



Dell Rugged Extreme 12-7204 Setup And Features Information

Regulatory Model: P18T
Regulatory Type:P18T001
RFID Model: DWRFID1302



Notes, Cautions, and Warnings

-  **NOTE:** A NOTE indicates important information that helps you make better use of your computer.
-  **CAUTION:** A CAUTION indicates either potential damage to hardware or loss of data and tells you how to avoid the problem.
-  **WARNING:** A WARNING indicates a potential for property damage, personal injury, or death.

© 2013 Dell Inc. All Rights Reserved.

Trademarks used in this text: Dell™, the Dell logo, Dell Boomi™, Dell Precision™, OptiPlex™, Latitude™, PowerEdge™, PowerVault™, PowerConnect™, OpenManage™, EqualLogic™, Compellent™, KACE™, FlexAddress™, Force10™, Venue™ and Vostro™ are trademarks of Dell Inc. Intel®, Pentium®, Xeon®, Core® and Celeron® are registered trademarks of Intel Corporation in the U.S. and other countries. AMD® is a registered trademark and AMD Opteron™, AMD Phenom™ and AMD Sempron™ are trademarks of Advanced Micro Devices, Inc. Microsoft®, Windows®, Windows Server®, Internet Explorer®, MS-DOS®, Windows Vista® and Active Directory® are either trademarks or registered trademarks of Microsoft Corporation in the United States and/or other countries. Red Hat® and Red Hat® Enterprise Linux® are registered trademarks of Red Hat, Inc. in the United States and/or other countries. Novell® and SUSE® are registered trademarks of Novell Inc. in the United States and other countries. Oracle® is a registered trademark of Oracle Corporation and/or its affiliates. Citrix®, Xen®, XenServer® and XenMotion® are either registered trademarks or trademarks of Citrix Systems, Inc. in the United States and/or other countries. VMware®, vMotion®, vCenter®, vCenter SRM™ and vSphere® are registered trademarks or trademarks of VMware, Inc. in the United States or other countries. IBM® is a registered trademark of International Business Machines Corporation.

2014 -01

Rev. A00

Contents

1 Front and Back View	5
2 Quick Setup	7
3 Removing and Installing Components	9
Removing the Battery.....	10
Installing the Battery.....	10
Removing the Hard Drive.....	10
Installing the Hard Drive.....	11
Opening The Press-Latch doors.....	11
Closing The Press-Latch doors.....	11
Opening The Slide-Latch doors.....	11
Closing The Slide-Latch doors.....	11
4 Smart Cards	13
5 Specifications	15
Information para NOM (únicamente para México).....	19
6 Finding More Information and Resources	21
7 Contacting Dell	23

Front and Back View

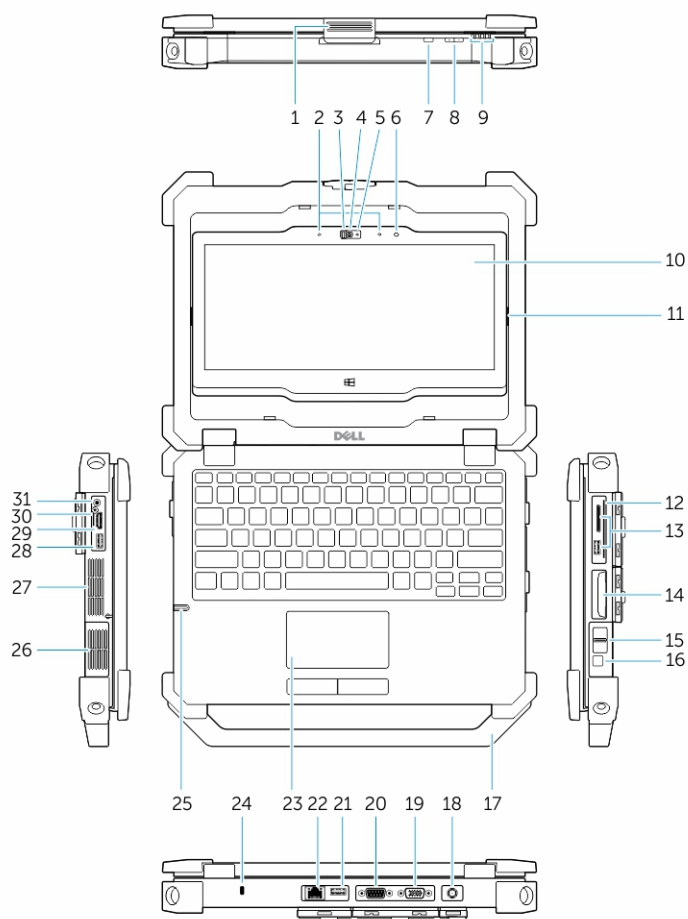

Figure 1. Front view

- | | |
|---|---|
| 1. Display latch | 2. microphones |
| 3. Privacy shutter | 4. Camera (optional) |
| 5. Camera Status Light | 6. Ambient light sensor |
| 7. Screen-rotate button | 8. Volume button |
| 9. Status lights | 10. Rotatable outdoor readable display/
touchscreen (optional) |
| 11. Flip-hinge | 12. Secure card reader |
| 13. Optional USB 3.0 connector and memory-
card reader/PC-card reader/Express-card
reader | 14. Hard disk |
| 15. Finger print reader | 16. Power Button |

- | | |
|----------------------------|---------------------------------------|
| 17. Handle | 18. Power connector |
| 19. VGA connector | 20. Serial connector |
| 21. USB 2.0 connector | 22. Network connector |
| 23. Touch pad | 24. Security cable slot |
| 25. Stylus | 26. Speaker |
| 27. Sealed thermal chamber | 28. USB 3.0 connector with PowerShare |
| 29. HDMI connector | 30. SIM card connector |
| 31. Audio connector | |

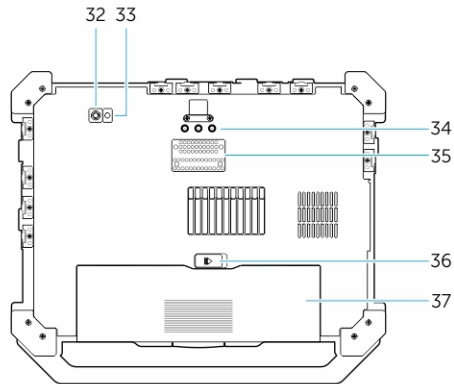

Figure 2. Bottom view

- 32 Rear camera
- 33 Camera flash
- 34 Radio frequency pass-through connectors
- 35 Docking device connector
- 36 Battery Latch
- 37 Battery

⚠ WARNING: Do not block, push objects into, or allow dust to accumulate in the air vents. Do not store your Dell computer in a low-airflow environment, such as a closed briefcase, while it is running. Restricting the airflow can damage the computer or cause a fire. The computer turns on the fan when the computer gets hot. Fan noise is normal and does not indicate a problem with the fan or the computer.

Quick Setup

- ⚠ WARNING:** Before you begin any of the procedures in this section, read the safety information that shipped with your computer. For additional best practices information, see www.dell.com/regulatory_compliance
- ⚠ WARNING:** The AC adapter works with electrical outlets worldwide. However, power connectors and power strips vary among countries. Using an incompatible cable or improperly connecting the cable to the power strip or electrical outlet may cause fire or equipment damage.
- ⚠ CAUTION:** When you disconnect the AC adapter cable from the computer, grasp the connector, not the cable itself, and pull firmly but gently to avoid damaging the cable. When you wrap the AC adapter cable, ensure that you follow the angle of the connector on the AC adapter to avoid damaging the cable.
- ✍ NOTE:** Some devices may not be included if you did not order them.

1. Connect the AC adapter to the AC adapter connector on the computer and to the electrical outlet.

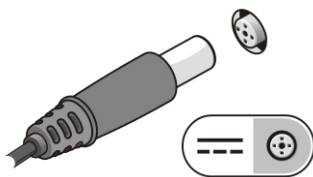

Figure 3. AC Adapter

2. Connect the network cable (optional).

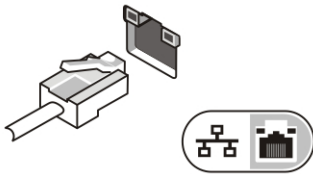

Figure 4. Network Connector

3. Connect USB devices, such as a mouse or keyboard (optional).

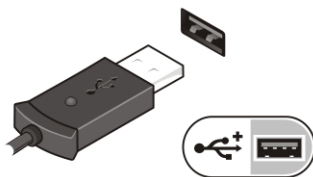

Figure 5. USB Connector

4. Connect IEEE 1394 devices, such as a 1394 hard drive (optional).

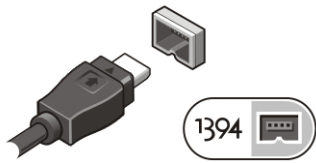



Figure 6. 1394 Connector

5. Open the computer display and press the power button to turn on the computer.









Figure 7. Power Button

-  **NOTE:** It is recommended that you turn on and shut down your computer at least once before you install any cards or connect the computer to a docking device or other external device, such as a printer.

Removing and Installing Components

This section provides detailed information on how to remove or install the components from your computer.

Removing the Battery

-  **WARNING:** Not for use in hazardous locations. See installation instructions.
-  **WARNING:** Using an incompatible battery may increase the risk of fire or explosion. Replace the battery only with a compatible battery purchased from Dell. The battery is designed to work with your Dell computer. Do not use a battery from other computers with your computer.
-  **WARNING:** Before removing or replacing the battery, turn off the computer, disconnect the AC adapter from the electrical outlet and the computer, disconnect the modem from the wall connector and computer, and remove any other external cables from the computer.
-  **WARNING:** To prevent ignition in a hazardous atmosphere, batteries must only be changed or charged in an area known to be non-hazardous.
-  **WARNING:** Utilisation d'une batterie non compatible peut accroître le risque d'incendie ou d'explosion. Cet ordinateur ne doit utiliser qu'une batterie achetée chez Dell. Ne pas utiliser les batteries des autres ordinateurs.
-  **WARNING:** Avant de retirer la batterie, arrêtez l'ordinateur, et retirez les câbles externes (y compris l'adaptateur secteur).
-  **WARNING:** Il y a danger d'explosion s'il y a un remplacement incorrect de la batterie. Remplacer uniquement avec une batterie du même type ou d'un type équivalent recommandé par le constructeur. Mettre au rebut les batteries usagées conformément aux instructions du fabricant.

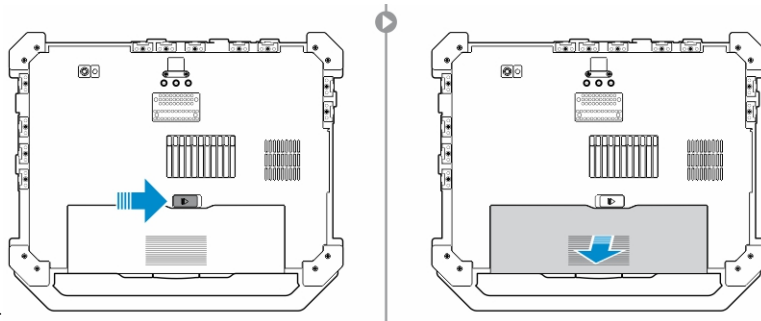

Perform the following steps:

- a) Slide the battery release latch to the unlock position.
- b) Remove the battery from the computer.

Installing the Battery

Slide the battery into its slot until it clicks into place.

Removing the Hard Drive

1. Perform the following steps:

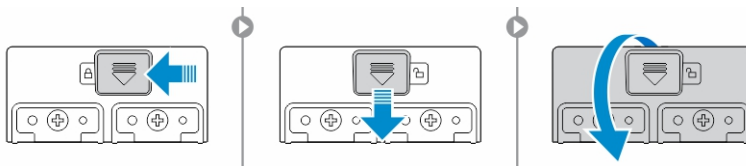

- a) To open the hard drive latch door, push the lock button to the left first and then in a downward direction.
 - b) Open the hard drive latch door by pushing the latch towards the rear of the computer.
2. Slide the hard drive outwards and remove it from the computer.



Installing the Hard Drive

1. Push the hard drive into its compartment until it snaps in place.
2. Close the hard-drive latch door .

Opening The Press-Latch doors

There are three press-latch doors. Two on the back and one on the right side panel. Follow the steps below to open the press-latch doors :

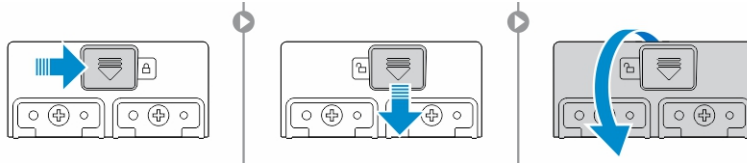

- a) Push the slide-lock to the right (the latch is locked when slid to the left).
- b) The door can now be opened by pressing down on the latch and pulling the door in a direction away from the computer.

Closing The Press-Latch doors

Follow the steps below to close the press-latch doors :

- a) Rotate the door back towards the computer and press until it is in a closed position.
- b) Engage the lock by pushing to the right until the lock symbol is visible.

Opening The Slide-Latch doors

There are three slide-latch doors. Two on the left and one on the right side panel. Follow the steps below to open the press-latch doors :

- a) Push the slide-latch in (the latch is locked when slid outward from the computer).
- b) The door can now be opened by sliding the latch towards the rear of the computer, and rotating the door in a downward direction.

Closing The Slide-Latch doors

Follow the steps below to close the slide-latch doors :

- a) Rotate the door back into its closed position and press until you can hear it click in place.

Smart Cards

There are two main types of Smart or Common Access Cards (CAC):

1. **Enclosed Smart Cards** — These cards have a contact area with many gold plated connection pads. When inserted into a card reader, the information from the chip can be read and written.
The Smart Card can be fully inserted, allowing the protective hinged door to be closed. Insert the card into the smart card slot with the gold contact pad facing upward and pointing toward the smart card slot. Slide the card into the slot until it is fully seated in its connector.
2. **Contact less Smart Cards** — These cards do not require any physical contact with the reader. The chip communicates with the card reader through RFID (DWRFID1302) induction technology. These cards require only close proximity to an antenna of a card reader to complete transactions.

Specifications



 **NOTE:** Offerings may vary by region. For more information regarding the configuration of your computer, click Start  (**Start icon**) → **Help and Support**, and then select the option to view information about your computer.

Table 1. System Information

Feature	Specification
Chipset	Intel Mobile Express Series 6 chipset
DRAM bus width	64-bit
Flash EPROM	SPI 32Mbits
PCIe Gen1 bus	100 MHz

Table 2. Processor

Feature	Specification
Types	<ul style="list-style-type: none"> • Intel Core i3 series • Intel Core i5 series • Intel Core i7 series
L3 cache	up to 6 MB
External bus frequency	1333 MHz

Table 3. Memory

Feature	Specification
Memory connector	two SODIMM slots
Memory capacity	2 GB, 4 GB, or 8 GB
Memory type	DDR3 SDRAM 1600 Mhz
Minimum memory	2 GB
Maximum memory	16 GB

Table 4. Audio

Feature	Specification
Type	four-channel high definition audio
Controller	IDT 92HD90

Feature	Specification
Stereo conversion	24-bit (analog-to-digital and digital-to-analog)
Interface:	
Internal	high definition audio
External	microphone-in/stereo headphones/external speakers connector
Speakers	one
Internal speaker amplifier	1W (RMS)
Volume controls	Volume Up/Volume Down buttons

 **CAUTION: Adjustment of volume control, as well as the equalizer in the operating system and/or equalizer software, to other settings than the center position may increase the earphones and/or headphones output and cause hearing damage or loss.**

Table 5. Video

Feature	Specification
Type	integrated on system board
Controller	
UMA	Intel HD Graphics 4600
Discrete	Nvidia GeForce (N14M-GE) Discrete Graphics Card, 2 GB Graphics

Table 6. Communications

Feature	Specification
Network adapter	10/100/1000 Mb/s Ethernet (RJ-45)
Wireless	<ul style="list-style-type: none"> Internal wireless local area network (WLAN)
Bluetooth	

Table 7. Ports and Connectors

Feature	Specification
Audio (optional)	one microphone/stereo headphone/speakers connector
Video	<ul style="list-style-type: none"> one 15-pin VGA connector 19-pin HDMI connector
Network adapter	one RJ-45 connector
USB 2.0	one 4-pin USB 2.0-compliant connector
USB 3.0	one 4-pin USB 3.0-compliant connector with PowerShare

Feature	Specification
Memory card reader	one 8-in-1 memory card reader
Serial	one DB9 pin serial connector
Docking port	one
Subscriber Identity Module (SIM) port	one

Table 8. Display

Feature	Specification
Type	white Light Emitting Diode (WLED) display
Size	12.0 inches
Dimensions:	
Height	158.5 mm (6.24 inches)
Width	268.0 mm (10.59 inches)
Diagonal	29.38 mm (1.15 inches)
Active area (X/Y)	256.12 mmx144 mm
Maximum resolution	<ul style="list-style-type: none"> • 1366 x 768 pixels • 1920 x 1080 pixels
Maximum Brightness	730 nits
Operating angle	0° (closed) to 180°
Refresh rate	60 Hz
Minimum Viewing angles:	
Horizontal	<ul style="list-style-type: none"> • +/- 40° for HD • +/- 60° for FHD
Vertical	<ul style="list-style-type: none"> • +10°/-30° for HD • +/-50° for FHD
Pixel pitch	0.2265 mm

Table 9. Keyboard

Feature	Specification
Number of keys	United States: 86 keys, United Kingdom: 87 keys, Brazil: 87 keys, and Japan: 90 keys
Layout	QWERTY/AZERTY/Kanji

Table 10. Touchpad

Feature	Specification
Active Area:	
X-axis	91 mm (3.58 inches)
Y-axis	51 mm (2.00 inches)

Table 11. Battery



Feature	Specification
Type	4-cell "smart" lithium ion
Dimensions:	
Height	16.5 mm (0.65 inches)
Width	215 mm (8.46 inches)
Depth	72.6 mm (2.85 inches)
Weight	318 g
Voltage	14.8 VDC
Temperature range:	
Operating	0 °C to 50 °C (32 °F to 122 °F)
Non-Operating	-40 °C to 85 °C (-40 °F to 185 °F)
	 NOTE: The battery pack is capable of safely withstanding the above storage temperatures with 100% charge.
	 NOTE: The battery pack is also capable of withstanding storage temperatures from -20 °C to +60 °C with no degradation in its performance.
Coin-cell battery	3 V CR2032 lithium coin cell

Table 12. AC Adapter

Type	65 W
Input voltage	100 VAC to 240 VAC
Input current (maximum)	1.7 A
Input frequency	50 Hz to 60 Hz
Output power	65 W
Output current	3.34 A (continuous)
Rated output voltage	19.5 +/- 1.0 VDC
Temperature range:	

Operating	0 °C to 40 °C (32 °F to 104 °F)
Non-Operating	-40 °C to 70 °C (-40 °F to 158 °F)

Table 13. Auto-air Adapter

Type	90 W
Input voltage	11 VDC to 16 VDC
Input current (maximum)	9.0 A
Output power	90 W
Output current	4.86 A(continuous)
Rated output voltage	19.5 +/- 1.0 VDC
Temperature range:	
Operating	0 °C to 35 °C (32 °F to 95 °F)

Table 14. Physical

Feature	Specification
Height	39.4 mm (1.55 inches)
Width	311 mm (12.24 inches)
Depth	229 mm (9.01 inches)
Weight	5.0 lbs (2.26 kg)

Table 15. Environmental

Feature	Specification
Temperature:	
Operating	0 °C to 35 °C (32 °F to 95 °F)
Storage	-40 °C to 65 °C (-40 °F to 149 °F)
Relative humidity (maximum):	
Operating	10 % to 90 % (non condensing)
Storage	5 % to 95 % (non condensing)
Altitude (maximum):	
Operating	-15.24 m to 3048 (-50 ft to 10,000 ft ft)
Non-Operating	-15.24 m to 10,668 m (-50 ft to 35,000 ft)
Airborne contaminant level	G1 as defined by ISA-71.04-1985

Information para NOM (únicamente para México)

The following information is provided on the device described in this document in compliance with the requirements of the official Mexican standards (NOM).

Voltaje de alimentación	100 VAC – 240 VAC
Frecuencia	50 Hz – 60 Hz
Consumo eléctrico	1.7 A
Voltaje de salida	19,50 V de CC
Intensidad de salida	3,34 A

Finding More Information and Resources

See the safety and regulatory documents that shipped with your computer and the regulatory compliance website at www.dell.com/regulatory_compliance for more information on:

- Safety best practices
- Regulatory certification
- Ergonomics

See www.dell.com for additional information on:

- Warranty
- Terms and Conditions (U.S. only)
- End User License Agreement

Additional information on your product is available at www.dell.com/support/manuals

Contacting Dell

 **NOTE:** If you do not have an active Internet connection, you can find contact information on your purchase invoice, packing slip, bill, or Dell product catalog.

Dell provides several online and telephone-based support and service options. Availability varies by country and product, and some services may not be available in your area. To contact Dell for sales, technical support, or customer service issues:

1. Visit **dell.com/support**
2. Select your support category.
3. Verify your country or region in the Choose a Country/Region drop-down menu at the top of page.
4. Select the appropriate service or support link based on your need.