

Cisco ITV7900 Family IP Set-Tops





Contents

Notice for Installers	4
IMPORTANT SAFETY INSTRUCTIONS.....	4
Change the Way You Watch TV	6
What's In the Carton?	6
Safety First.....	6
Identify Your Receiver with the Serial Number	6
In This Manual	6
Questions About Your Service.	6
Protecting You and the Environment	7
Front Panel.....	8
Back Panel	9
Connecting the Receiver.....	10
Connecting to the In-Home Network	11
Connections for a High-Definition TV (HDTV)	12
Connections for a Standard-Definition TV (SDTV)	13
Connections for a VCR or DVD Recorder	14
Connecting an Over-the-Air Converter Box.....	14
Connecting to an HDTV with an HDMI Connector	15
Connecting to an HDTV with a DVI Connector	16
Connecting to an HDTV with Component (YPbPr) Connectors.....	17
Connecting to an SDTV with Component (YPbPr) Connectors	18
Connecting to an SDTV with an S-Video Connector.....	19
Connecting to an SDTV with an RCA-Type Connector	20
Connecting to an SDTV with a Coaxial Cable.....	21
Connecting to a Home Theater System with Component (YPbPr) Connectors	22
Connecting to a Stereo VCR or DVD Recorder (optional)	23
Troubleshooting	24
Avoid Screen Burn-In.....	24
Frequently Asked Questions	24
Picture Formats.....	24
Index	24

Notice for Installers

The servicing instructions in this notice are for use by qualified service personnel only. To reduce the risk of electric shock, do not perform any servicing other than that contained in the operating instructions, unless you are qualified to do so.

Note to System Installer For this apparatus, the cable shield/screen shall be grounded as close as practical to the point of entry of the cable into the building. For products sold in the US and Canada, this reminder is provided to call the system installer's attention to Article 800-93 and Article 800-100 of the NEC (or Canadian Electrical Code Part 1), which provides guidelines for proper grounding of the cable shield.	
 This symbol is intended to alert you that uninsulated voltage within this product may have sufficient magnitude to cause electric shock. Therefore, it is dangerous to make any kind of contact with any inside part of this product. Ce symbole a pour but d'alerter toute personne qu'un contact avec une pièce interne de ce produit, sous tension et non isolée, pourrait être suffisant pour provoquer un choc électrique. Il est donc dangereux d'être en contact avec toute pièce interne de ce produit.	CAUTION: To reduce the risk of electric shock, do not remove cover (or back). No user-serviceable parts inside. Refer servicing to qualified service personnel. WARNING TO PREVENT FIRE OR ELECTRIC SHOCK, DO NOT EXPOSE THIS UNIT TO RAIN OR MOISTURE.  This symbol is intended to alert you of the presence of important operating and maintenance (servicing) instructions in the literature accompanying this product. Ce symbole a pour but de vous avertir qu'une documentation importante sur le fonctionnement et l'entretien accompagne ce produit.

IMPORTANT SAFETY INSTRUCTIONS

- 1) Read these instructions.
- 2) Keep these instructions.
- 3) Heed all warnings.
- 4) Follow all instructions.
- 5) Do not use this apparatus near water.
- 6) Clean only with dry cloth.
- 7) Do not block any ventilation openings. Install in accordance with the manufacturer's instructions.
- 8) Do not install near any heat sources such as radiators, heat registers, stoves, or other apparatus (including amplifiers) that produce heat.
- 9) Do not defeat the safety purpose of the polarized or grounding-type plug. A polarized plug has two blades with one wider than the other. A grounding-type plug has two blades and a third grounding prong. The wide blade or the third prong are provided for your safety. If the provided plug does not fit into your outlet, consult an electrician for replacement of the obsolete outlet.
- 10) Protect the power cord from being walked on or pinched particularly at plugs, convenience receptacles, and the point where they exit from the apparatus.
- 11) Only use attachments/accessories specified by the manufacturer.
- 12)  Use only with the cart, stand, tripod, bracket, or table specified by the manufacturer, or sold with the apparatus. When a cart is used, use caution when moving the cart/apparatus combination to avoid injury from tip-over.
- 13) Unplug this apparatus during lightning storms or when unused for long periods of time.
- 14) Refer all servicing to qualified service personnel. Servicing is required when the apparatus has been damaged in any way, such as a power-supply cord or plug is damaged, liquid has been spilled or objects have fallen into the apparatus, the apparatus has been exposed to rain or moisture, does not operate normally, or has been dropped.

Power Source Warning

A label on this product indicates the correct power source for this product. Operate this product only from an electrical outlet with the voltage and frequency indicated on the product label. If you are uncertain of the type of power supply to your home or business, consult your service provider or your local power company.

The AC inlet on the unit must remain accessible and operable at all times.

Ground the Product

 **WARNING: Avoid electric shock and fire hazard! If this product connects to cable wiring, be sure the cable system is grounded (earthed). Grounding provides some protection against voltage surges and built-up static charges.**

Protect the Product from Lightning

In addition to disconnecting the AC power from the wall outlet, disconnect the signal inputs.

Verify the Power Source from the On/Off Power Light

When the on/off power light is not illuminated, the apparatus may still be connected to the power source. The light may go out when the apparatus is turned off, regardless of whether it is still plugged into an AC power source.

Eliminate AC Power/Mains Overloads

 **WARNING: Avoid electric shock and fire hazard! Do not overload AC power/mains, outlets, extension cords, or integral convenience receptacles. For products that require battery power or other power sources to operate them, refer to the operating instructions for those products.**

Provide Ventilation and Select a Location

- Remove all packaging material before applying power to the product.
- Do not place this apparatus on a bed, sofa, rug, or similar surface.
- Do not place this apparatus on an unstable surface.
- Do not place this apparatus in excessive heat or moisture.
- Do not install this apparatus in an enclosure, such as a bookcase or rack, unless the installation provides proper ventilation.
- Do not place entertainment devices (such as VCRs or DVDs), lamps, books, vases with liquids, or other objects on top of this product.
- Do not block ventilation openings.

Operating Environment

This product is designed for operation indoors with a temperature range from 32° to 104° F (0° to 40° C). Each product should have adequate spacing on all sides so that the cooling air vents on the chassis are not blocked.

Protect from Exposure to Moisture and Foreign Objects

 **WARNING: Avoid electric shock and fire hazard! Do not expose this product to dripping or splashing liquids, rain, or moisture. Objects filled with liquids, such as vases, should not be placed on this apparatus.**

 **WARNING: Avoid electric shock and fire hazard! Unplug this product before cleaning. Do not use a liquid cleaner or an aerosol cleaner. Do not use a magnetic/static cleaning device (dust remover) to clean this product.**

 **WARNING: Avoid electric shock and fire hazard! Never push objects through the openings in this product. Foreign objects can cause electrical shorts that can result in electric shock or fire.**

Cisco and the Cisco logo are trademarks or registered trademarks of Cisco and/or its affiliates in the U.S. and other countries. To view a list of Cisco trademarks, go to this URL: www.cisco.com/go/trademarks. Third-party trademarks mentioned are the property of their respective owners. The use of the word partner does not imply a partnership relationship between Cisco and any other company. (1110R)

Manufactured under license from Dolby Laboratories. Dolby is a trademark of Dolby Laboratories.

HDMI The terms HDMI and HDMI High-Definition Multimedia Interface, and the HDMI Logo are trademarks or registered trademarks of HDMI Licensing LLC in the United States and other countries.

Rovi is a trademark of Rovi Corporation.

The Wi-Fi Protected Setup mark is a mark of the Wi-Fi Alliance. Wi-Fi Protected Setup is a trademark of the Wi-Fi Alliance.

© 2014 Cisco and/or its affiliates. All rights reserved. Last Updated: July 2014 78-21653-01C0
Printed in China PRC

Service Warnings

 **WARNING: Avoid electric shock! Do not open the cover of this product. Opening or removing the cover may expose you to dangerous voltages. If you open the cover, your warranty will be void. This product contains no user-serviceable parts.**

Check Product Safety

Upon completion of any service or repairs to this product, the service technician must perform safety checks to determine that this product is in proper operating condition.

Protect the Product When Moving It

Always disconnect the power source when moving the apparatus or connecting or disconnecting cables. 20110316_IP_No Tuner_Safety

Compliance Information

United States FCC Compliance

This equipment has been tested and found to comply with the limits for a Class B digital device, pursuant to Part 15 of the FCC Rules. These limits are designed to provide reasonable protection against harmful interference in a residential installation. This equipment generates, uses and can radiate radio frequency energy and, if not installed and used in accordance with the instructions, may cause harmful interference to radio communications. However, there is no guarantee that interference will not occur in a particular installation. If this equipment does cause harmful interference to radio or television reception, which can be determined by turning the equipment off and on, the user is encouraged to try to correct the interference by one of the following measures:

- Reorient or relocate the receiving antenna.
- Increase the separation between the equipment and receiver.
- Connect the equipment into an outlet on a circuit different from that to which the receiver is connected.
- Consult the dealer or an experienced radio/TV technician for help.

FCC Caution: Any changes or modifications not expressly approved by the party responsible for compliance could void the user's authority to operate this equipment.

This device is going to operated in the 5.15-5.25 MHz frequency ranges, it is restricted in indoor environment only

The availability of some specific channels and/or operational frequency bands are country dependent and are firmware programmed at the factory to match the intended destination. The firmware setting is not accessible by the end user.

Devices will not permit operations on channels 120-132 for 11a and 11n/a which overlap the 5600 - 5650 MHz band.

ITV7900 Family IP Set-Top
Models ITV7904, ITV7906, and ITV7908
Manufactured by: Cisco Systems, Inc.
170 West Tasman Drive
San Jose, CA 95134 USA
www.cisco.com/go/contacts

Note: The ITV7906 and ITV7908 have disabled the 5600-5650M band by S/W to avoid 5600-5650M band for IC certification.

Canada EMI Regulation

This Class B digital apparatus complies with Canadian ICES-003.

Cet appareil numérique de la class B est conforme à la norme NMB-003 du Canada.

20081121 FCC Standard

AVC VIDEO LICENSE

With respect to each AVC/H.264 product, we are obligated to provide the following notice:

THIS PRODUCT IS LICENSED UNDER THE AVC PATENT PORTFOLIO LICENSE FOR THE PERSONAL USE OF A CONSUMER OR OTHER USES IN WHICH IT DOES NOT RECEIVE REMUNERATION TO (i) ENCODE VIDEO IN COMPLIANCE WITH THE AVC STANDARD ("AVC VIDEO") AND/OR (ii) DECODE AVC VIDEO THAT WAS ENCODED BY A CONSUMER ENGAGED IN A PERSONAL ACTIVITY AND/OR WAS OBTAINED FROM A VIDEO PROVIDER LICENSED TO PROVIDE AVC VIDEO. NO LICENSE IS GRANTED OR SHALL BE IMPLIED FOR ANY OTHER USE. ADDITIONAL INFORMATION MAY BE OBTAINED FROM MPEG LA, L.L.C. SEE [HTTP://WWW.MPEGLA.COM](http://WWW.MPEGLA.COM).

Accordingly, please be advised that service providers, content providers, and broadcasters may be required to obtain a separate use license from MPEG LA prior to any use of AVC/H.264 encoders and/or decoders.

ROVI CORPORATION COPYRIGHT NOTICE

This product incorporates copyright protection technology that is protected by U.S. patents and other intellectual property rights of Rovi Corporation. Use of this copyright protection technology must be authorized by Rovi Corporation, and is intended for home and other limited viewing uses only unless otherwise authorized by Rovi Corporation. Reverse engineering and disassembly are prohibited.

Disclaimer

Cisco Systems, Inc. assumes no responsibility for errors or omissions that may appear in this manual. We reserve the right to change this manual at any time without notice.

IMPORTANT NOTE: FCC RF Exposure Statement:

This equipment complies with FCC radiation exposure limits set forth for an uncontrolled environment. This equipment should be installed and operated with minimum distance 20cm between the radiator and your body.

This device and it's antennas(s) must not be co-located or operating in conjunction with any other antenna or transmitter except in accordance with FCC multi-transmitter product procedures

Industry Canada Statement:

This device complies with RSS-210 of the Industry Canada Rules. Operation is subject to the following two conditions: (1) This device may not cause harmful interference, and (2) this device must accept any interference received, including interference that may cause undesired operation.

Caution:

The device for the bands 5150-5250 MHz is only for indoor usage to reduce potential for harmful interference to co-channel mobile satellite systems.

High power radars are allocated as primary users (meaning they have priority) of 5250-5350 MHz and 5650-5850 MHz and these radars could cause interference and/or damage to LE-LAN devices.

IMPORTANT NOTE:

Canada RF Exposure Statement:

This system has been evaluated for radiofrequency exposure for humans in reference to Canada Health Code 6 (2009) limits. The evaluation was based on evaluation per RSS-102 Rev 4. The minimum separation distance from the antenna to general bystander is 7.9 inches (20cm) to maintain compliance.



L'exposition humaine aux radiofréquences émises par ce système a été évaluée conformément aux limites spécifiées dans le Code de sécurité 6 de Santé Canada (2009). Cette évaluation était basée sur l'évaluation décrite dans le document RSS-102 Rev 4. Cette norme définit à 20 cm (7,9 po) la distance minimale devant séparer l'antenne de toute personne.

FCC Declaration of Conformity

This device complies with Part 15 of FCC Rules. Operation is subject to the following two conditions: 1) the device may not cause harmful interference, and 2) the device must accept any interference received, including interference that may cause undesired operation.

Avis pour les installateurs

Les instructions de maintenance présentées dans cette notice sont réservées aux techniciens qualifiés. Si vous n’êtes pas qualifié et afin de minimiser les risques d’électrocution, n’effectuez aucune autre tâche que celles décrites dans le guide d’utilisation.

Remarque à l’intention de l’installateur du système	
Pour cet appareil, l’écran/le blindage du câble doit être mis à la terre aussi près que possible du point d’entrée du câble dans l’immeuble. Pour les produits vendus aux États-Unis et au Canada, ce rappel sert à attirer l’attention de l’installateur du système sur les articles 800-93 et 800-100 du NEC (ou au Code canadien de l’électricité, Partie 1), qui présentent des directives concernant la mise à la terre appropriée du blindage du câble.	ATTENTION : afin de minimiser les risques de décharge électrique, ne retirez pas le couvercle (ni le panneau arrière). L’appareil ne contient aucune pièce dont l’entretien peut être assuré par l’utilisateur. Les tâches de maintenance doivent être réalisées par du personnel d’entretien qualifié.
	AVERTISSEMENT POUR ÉVITER LES INCENDIES ET LES DÉCHARGES ÉLECTRIQUES, N’EXPOSEZ PAS CET APPAREIL À LA PLUIE OU À L’HUMIDITÉ. 
Ce symbole a pour but d’alerter toute personne qu’un contact avec une pièce interne de ce produit, sous tension et non isolée, pourrait être suffisant pour provoquer un choc électrique. Il est donc dangereux d’être en contact avec toute pièce interne de ce produit.	Ce symbole a pour but de vous avertir qu’une documentation importante sur le fonctionnement et l’entretien accompagne ce produit.

INSTRUCTIONS IMPORTANTES RELATIVES À LA SÉCURITÉ

- Lisez ces instructions.**
- Conservez ces instructions.**
- Soyez attentif à tous les avertissements.**
- Suivez toutes les instructions.**
- N’utilisez pas cet appareil à proximité de points d’eau.**
- Nettoyez cet appareil avec un chiffon sec uniquement.**
- Veillez à ne pas obstruer les orifices de ventilation. Installez cet appareil conformément aux instructions du fabricant.**
- N’installez pas l’appareil à proximité d’une source de chaleur telle qu’un radiateur, une grille de chauffage, un poêle ou tout autre dispositif produisant de la chaleur (y compris un amplificateur).**
- Ne retirez pas le dispositif de sécurité de la prise avec détrompeur ou avec mise à la terre. Une prise avec détrompeur est constituée de deux broches dont l’une est plus large que l’autre. Une prise avec mise à la terre est constituée de deux broches et une troisième broche de terre. La broche large, ou la troisième broche de terre, est destinée à garantir votre sécurité. Si la prise fournie n’est pas adaptée à votre prise de courant, consultez un électricien pour remplacer cette dernière.**
- Évitez de marcher sur le cordon d’alimentation ou de le pincer, en particulier au niveau des prises de courant, des socles de prises de courant et du point de sortie de l’appareil.**
- Utilisez exclusivement les accessoires recommandés par le fabricant.**
-  **Utilisez uniquement le chariot, le support, le trépied, la console ou la table recommandés par le fabricant ou vendus avec l’appareil. Si vous utilisez le chariot, veillez à déplacer l’appareil avec précaution, afin de ne pas faire basculer le chargement et risquer de vous blesser.**
- Débranchez cet appareil pendant les orages ou en cas d’inutilisation prolongée.**
- La maintenance doit être réalisée par des techniciens qualifiés. Des opérations de maintenance sont nécessaires lorsque l’appareil a été endommagé (par exemple, en cas de dégâts au niveau du cordon d’alimentation ou de la prise), lorsque du liquide s’est répandu ou que des objets sont tombés à l’intérieur de l’appareil, lorsqu’il a été exposé à la pluie ou à l’humidité et en cas de dysfonctionnement ou de chute.**

Avertissement relatif à l'alimentation

Une étiquette apposée sur le produit indique le type d’alimentation à utiliser. Ne branchez ce produit qu’à une prise électrique offrant la tension et la fréquence indiquées sur l’étiquette. Si vous ne savez pas quel type de prise est installé à votre domicile ou dans votre entreprise, contactez votre fournisseur d’électricité.

La prise CA de l’unité doit rester accessible et utilisable à tout instant.

Mise à la terre

	AVERTISSEMENT : évitez les électrocutions et les incendies ! Si ce produit est branché par câble, assurez-vous que le câblage est relié à la terre. La mise à la terre permet de se protéger contre les surtensions et les accumulations d’électricité statique.
---	---

Protection contre la foudre

Débranchez la prise CA de la prise murale et déconnectez les entrées de signaux.

Vérification de la source d'alimentation à l'aide du voyant de mise sous et hors tension

Même lorsque le voyant de mise sous et hors tension est éteint, il se peut que l’appareil soit encore branché à l’alimentation. Le voyant peut s’éteindre lorsque l’appareil est mis hors tension, qu’il soit débranché ou non.

Élimination des surcharges du réseau d'alimentation CA

	AVERTISSEMENT : évitez les électrocutions et les incendies ! Évitez les surcharges au niveau du secteur, des prises, des rallonges ou des socles de prises de courant. Dans le cas de produits fonctionnant sur batterie ou à partir d’autres sources d’alimentation, consultez les instructions fournies avec ces produits.
---	---

Ventilation et choix de l'emplacement

- Retirez l’intégralité de l’emballage avant de brancher le produit.
- Ne placez pas l’appareil sur un lit, un canapé, une couverture ou une surface similaire.
- Ne placez pas ce produit sur une surface instable.
- N’exposez pas cet appareil à une chaleur excessive ou à l’humidité.
- N’installez pas cet appareil dans un emplacement fermé tel qu’une bibliothèque ou un rack, sauf si cette installation bénéficie d’une aération adaptée.
- Ne placez pas d’appareils multimédia (magnétoscopes, lecteurs de DVD), de lampes, de livres, de vases contenant de l’eau ou d’autres objets sur le produit.
- Veillez à ne pas obstruer les orifices de ventilation.

Environnement de fonctionnement

Ce produit est destiné à une utilisation en intérieur, avec une température comprise entre 0 et 40 °C. Vous devez laisser suffisamment d’espace de chaque côté du produit afin de ne pas bloquer les grilles d’aération du châssis.

Protection contre l'humidité et les corps étrangers

	AVERTISSEMENT : évitez les électrocutions et les incendies ! N'exposez pas ce produit aux infiltrations et aux projections de matières liquides, à la pluie ou à l'humidité. Ne placez pas d'objets contenant des matières liquides tels que des vases sur cet appareil.
---	---

	AVERTISSEMENT : évitez les électrocutions et les incendies ! Débranchez le produit avant de le nettoyer. N'utilisez pas de nettoyant liquide ou sous forme d'aérosol. N'utilisez pas d'appareil magnétique ou à électricité statique (dépoussiéreur) pour nettoyer ce produit.
---	---

	AVERTISSEMENT : évitez les électrocutions et les incendies ! N'insérez jamais d'objets dans les ouvertures. Ceux-ci peuvent créer des courts-circuits et entraîner une électrocution ou un incendie.
---	---

Avertissements relatifs à la maintenance

	AVERTISSEMENT : évitez les électrocutions ! Ne retirez pas le couvercle de ce produit. L'ouverture ou le retrait du couvercle peut vous exposer à des tensions dangereuses. Retirer le couvercle entraîne l'annulation de la garantie. Aucune pièce de ce produit ne peut être réparée par l'utilisateur.
---	--

Vérification de la sécurité du produit

Après toute opération de maintenance ou toute réparation, le technicien doit procéder à des vérifications pour déterminer si le produit est en bon état de fonctionnement.

Protection du produit lors de son déplacement

Débranchez toujours le produit de sa source d’alimentation lorsque vous le déplacez ou lorsque vous branchez ou débranchez des câbles.

20110316_IP_No Tuner_Safety

Informations relatives à la conformité Conformité aux normes de la FCC aux États-Unis

Cet équipement a été testé et jugé conforme aux limites des appareils numériques de classe B en vertu de la Partie 15 des règlements de la FCC. L’objectif de ces normes est de fournir une protection raisonnable contre ce type d’interférence dans une installation résidentielle. Cet équipement génère, utilise et peut émettre des radiofréquences. S’il n’est pas installé et utilisé conformément aux instructions, il peut entraîner un brouillage préjudiciable dans les communications radio. Toutefois, il n’est pas garanti que son fonctionnement ne provoquera pas de brouillage, dans une installation donnée. Si cet équipement cause un brouillage préjudiciable à la réception des ondes de radio ou de télévision, ce qui peut être vérifié en le mettant HORS TENSION puis de nouveau SOUS TENSION, l’utilisateur devra tenter de les corriger en procédant comme suit :

- Augmentez la distance entre l’équipement et le récepteur.
- Branchez l’équipement sur une prise d’un circuit autre que celui auquel le récepteur est relié.
- Demandez l’aide de votre câblo-opérateur ou d’un technicien de radio/télévision expérimenté.

Toute modification non approuvée explicitement par Cisco Systems, Inc. pourrait annuler le droit de l'utilisateur à faire usage de cet équipement.

Les informations présentées dans le paragraphe suivant de la Déclaration de conformité à la FCC sont demandées par la FCC et ont pour but de vous informer de la certification de ce périphérique par la FCC. *Les numéros de téléphone indiqués permettent uniquement de poser des questions en rapport avec la réglementation FCC et non pas des questions concernant le branchement ou le fonctionnement de ce périphérique. Contactez votre fournisseur d'accès pour toute question concernant le fonctionnement ou l'installation du périphérique.*

FCC Déclaration de conformité FCC

Cet appareil est conforme à la Partie 15 des règlements de la FCC. Son utilisation est soumise aux deux conditions suivantes : 1) il ne doit pas produire de brouillage préjudiciable et 2) il doit tolérer les brouillages reçus, y compris ceux susceptibles de perturber son fonctionnement.

Décodeurs IP de la gamme ITV7900 Modèles ITV7904, ITV7906 et ITV7908 Fabriqués par : Cisco Systems, Inc. 170 West Tasman Drive San Jose, CA 95134 États-Unis <p>www.cisco.com/go/contacts</p>

Réglementation du Canada relative aux interférences électromagnétiques

Cet appareil numérique de classe B est conforme à la norme NMB-003 du Canada.

Cet appareil numérique de classe B est conforme à la norme NMB-003 du Canada.

Norme 20081121 de la FCC

LICENCE VIDÉO AVC

Pour chaque produit AVC/H.264, nous sommes tenus de mentionner l’avis suivant :

CE PRODUIT EST SOUS LICENCE DU PORTEFEUILLE DE BREVETS AVC POUR UNE UTILISATION PERSONNELLE PAR UN CONSOMMATEUR, OU TOUTE AUTRE UTILISATION N’OUVRANT PAS DROIT À RÉMUNÉRATION LORSQUE CE CONSOMMATEUR (i) ENCODE UNE VIDÉO CONFORME AUX NORMES AVC (LA « VIDÉO AVC ») ET/OU (ii) DÉCODE UNE VIDÉO AVC ENCODÉE PAR UN CONSOMMATEUR IMPLIQUÉ DANS UNE ACTIVITÉ PERSONNELLE ET/OU OBTENUE D’UN FOURNISSEUR DE VIDÉOS DISPOSANT D’UNE LICENCE DE DIFFUSION DE VIDÉOS AVC. AUCUNE LICENCE EXPRESSE OU TACITE N’EST ACCORDÉE POUR UN AUTRE USAGE QUEL QU’IL SOIT. POUR DE PLUS AMPLES RENSEIGNEMENTS, ADRESSEZ-VOUS À MPEG LA, L.L.C. CONSULTEZ LE SITE WEB : **HTTP://WWW.MPEGLA.COM**.

En conséquence, nous vous informons que les fournisseurs de services, les fournisseurs de contenu et les télédiffuseurs peuvent avoir obligation d’obtenir une licence d’utilisation séparée émise par MPEG LA, préalablement à toute utilisation d’encodeurs et/ou décodeurs AVC/H.264.

AVERTISSEMENT RELATIF AUX DROITS D'AUTEUR DE ROVI CORPORATION

Ce produit intègre une technologie de protection des droits d’auteur protégée par des brevets américains et d’autres droits de propriété intellectuelle de Rovi Corporation. L’utilisation de cette technologie de protection des droits d’auteur doit être autorisée par Rovi Corporation et n’est destinée qu’à un usage privé ou restreint, sauf autorisation contraire de Rovi Corporation. Il est interdit de démonter le produit ou d’en étudier le fonctionnement.

Avertissement

Cisco Systems, Inc. décline toute responsabilité en cas d’erreurs ou d’omissions dans le présent manuel. Nous nous réservons le droit de modifier ce manuel à tout moment et sans avis préalable.

Déclaration sur les interférences de la FCC (Federal Communication Commission)

Cet équipement a été testé et jugé conforme aux limites des appareils numériques de Classe B en vertu de la Partie 15 des règlements de la FCC. L’objectif de ces normes est de fournir une protection raisonnable contre toute interférence nuisible dans une installation résidentielle. Cet équipement génère, utilise et peut émettre de l’énergie radioélectrique à haute fréquence et, s’il n’est pas installé et utilisé selon le manuel d’instructions, peut provoquer des interférences nuisibles aux communications radio. Toutefois, il n’est pas garanti que son fonctionnement ne provoquera pas de brouillage, dans une installation donnée. Si cet équipement provoque des interférences nuisibles à la réception de la radio ou de la télévision (détectables par la mise hors tension et sous tension de l’équipement), l’utilisateur peut tenter d’y remédier de différentes façons :

- Réorienter ou déplacer l’antenne réceptrice.
- Augmenter la distance entre l’équipement et le récepteur.
- Brancher l’équipement sur une prise d’un circuit autre que celui auquel le récepteur est relié.
- Solliciter l’aide du distributeur ou d’un technicien radio/télévision expérimenté.

Avertissement de la FCC : toute modification non approuvée expressément par la partie responsable de la conformité pourrait annuler le droit de l'utilisateur à faire usage de cet équipement.

Pour un fonctionnement à des plages de fréquences allant de 5 150 à 5 250 MHz et de 5 470 à 5 725 MHz, l’appareil est destiné à être utilisé dans un environnement intérieur.

Cet appareil est conforme à la section 15 des règlements de la FCC. Son utilisation est soumise aux deux conditions suivantes : (1) il ne doit pas produire de brouillage préjudiciable et (2) il doit tolérer les brouillages reçus, y compris ceux susceptibles de perturber son fonctionnement.

REMARQUE IMPORTANTE :

Déclaration de la FCC sur l'exposition aux radiofréquences :

Cet équipement est conforme aux normes d’exposition de la FCC en matière de radiations définies pour un environnement non contrôlé. Cet équipement doit être installé et utilisé en respectant une distance minimale de 20 cm entre l’émetteur de radiations et vous-même.

Cet émetteur ne cohabitera pas ou ne fonctionnera pas en conjonction avec toute autre antenne ou tout autre émetteur.

La disponibilité de certains canaux et/ou bandes de fréquences d’exploitation dépend du pays. Elle est programmée par micrologiciel sur le site de l’usine en fonction du pays de destination. La configuration par micrologiciel n’est pas accessible à l’utilisateur final.

Déclaration d'Industrie Canada :

Cet appareil est conforme à la norme CNR-210 des règlements d’Industrie Canada. Son utilisation est soumise aux deux conditions suivantes : (1) il ne doit pas produire de brouillage préjudiciable et (2) il doit tolérer les brouillages reçus, y compris ceux susceptibles de perturber son fonctionnement.

Mise en garde :

Pour des bandes de fréquences allant de 5 150 à 5 250 MHz et de 5 470 à 5 725 MHz, l’appareil peut uniquement être utilisé à l’intérieur pour réduire le risque de brouillage préjudiciable qui pourrait affecter les systèmes satellites portables sur la même voie.

Les radars haute puissance sont les utilisateurs principaux (c.-à-d. les utilisateurs prioritaires) des bandes 5 250–5 350 MHz et 5 650–5 850 MHz, et sont susceptibles de causer des brouillages ou d’endommager les appareils LE-LAN.

REMARQUE IMPORTANTE :

Déclaration sur l'exposition aux radiofréquences au Canada :

L’exposition humaine aux radiofréquences émises par ce système a été évaluée conformément aux limites spécifiées dans le Code de sécurité 6 de Santé Canada (2009). Cette évaluation était basée sur l’évaluation décrite dans le document RSS-102 Rev 4. Cette norme définit à 20 cm (7,9 po) la distance minimale devant séparer l’antenne de toute personne.

Remarque : Pour les modèles ITV7906 et ITV7908, la bande 5 600–5 650M a été désactivée par logiciel afin d’éviter la certification d’IC exigée pour cette bande.

Cisco et le logo Cisco sont des marques de commerce ou marques de commerce déposées de Cisco ou de ses filiales aux États-Unis et dans d’autres pays. Pour voir la liste des marques de commerce de Cisco, visitez le site www.cisco.com/go/trademarks. Les autres marques de commerce mentionnées appartiennent à leur détenteur respectif. L’utilisation du terme « partenaire » n’implique pas de relation de partenariat entre Cisco et une autre entreprise. (1110R)

Fabriqu  sous licence de Dolby Laboratories. Dolby est une marque commerciale de Dolby Laboratories.

HDMI Les termes « HDMI » et « Interface Multimédia Haute Définition » (HDMI ou High-Definition Multimedia Interface), ainsi que le logo HDMI, sont des marques commerciales ou des marques déposées de HDMI Licensing LLC aux États-Unis et dans d’autres pays.

Rovi est une marque commerciale de Rovi Corporation.

La marque Wi-Fi Protected Setup est une marque commerciale de Wi-Fi Alliance. Wi-Fi Protected Setup est une marque de Wi-Fi Alliance.

  2014 Cisco et/ou ses affili s. Tous droits r serv s.

Derni re mise   jour : juin 2014

78-21653-01CO

Imprim  en R publique populaire de Chine

IMPORTANT SAFETY INSTRUCTIONS, continued

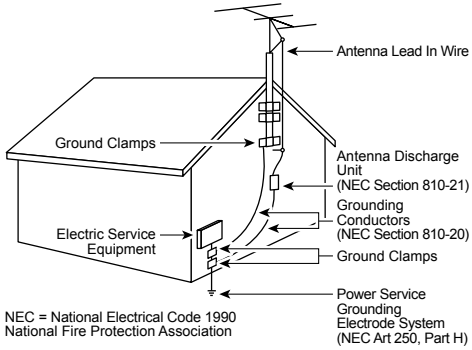

TO CATV INSTALLER

This reminder is provided to call the CATV system installer's attention to Article 820-40 of the National Electrical Code (NEC) that provides guidelines for proper grounding, and in particular, specifies that the cable ground shall be connected to the grounding system of the building, as close to the point of entry as practical.

T15378

Protect the Product from Lightning

In addition to disconnecting the AC power from the wall outlet, disconnect the signal inputs.

Verify the Power Source from the On/Off Power Light

When the on/off power light is not illuminated, the apparatus may still be connected to the power source. The light may go out when the apparatus is turned off, regardless of whether it is still plugged into an AC power source.

Eliminate AC Power/Mains Overloads



WARNING: Avoid electric shock and fire hazard! Do not overload AC power/mains, outlets, extension cords, or integral convenience receptacles. For products that require battery power or other power sources to operate them, refer to the operating instructions for those products.

Handling Disposable Batteries

This product may contain disposable batteries. Heed the following warning and follow the Battery Safety and Battery Disposal instructions below.



WARNING: There is danger of explosion if the battery is mishandled or incorrectly replaced. Replace only with the same type of battery. Do not disassemble it or attempt to recharge it outside the system. Do not crush, puncture, dispose of in fire, short the external contacts, or expose to water or other liquids. Dispose of the battery in accordance with local regulations and instructions from your service provider.

Battery Safety

- Insert batteries correctly. There may be a risk of explosion if the batteries are incorrectly inserted.
- Do not attempt to recharge 'disposable' or 'non-reusable' batteries.
- Please follow instructions provided for charging 'rechargeable' batteries.
- Replace batteries with the same or equivalent type that we recommend.
- Do not expose batteries to excessive heat (such as sunlight or fire).
- Do not expose batteries to temperatures above 100°C (212°F).

Battery Disposal

- The batteries may contain substances that could be harmful to the environment.
- Recycle or dispose of batteries in accordance with the battery manufacturer's instructions and local/national disposal and recycling regulations.



廢電池請回收

- The batteries may contain perchlorate, a known hazardous substance, so special handling and disposal of this product might be necessary. For more information about perchlorate and best management practices for perchlorate-containing substance, see www.dtsc.ca.gov/hazardouswaste/perchlorate

Provide Ventilation and Select a Location

- Remove all packaging material before applying power to the product.
- Do not place this apparatus on a bed, sofa, rug, or similar surface.
- Do not place this apparatus on an unstable surface.
- Do not install this apparatus in an enclosure, such as a bookcase or rack, unless the installation provides proper ventilation.
- Do not place entertainment devices (such as VCRs or DVDs), lamps, books, vases with liquids, or other objects on top of this product.
- Do not block ventilation openings.

Operating Environment

The set-top is designed for operation indoors with a temperature range from 32° to 104° F (0° to 40° C). Each set-top should have adequate spacing on all sides so that the cooling air vents on the chassis are not blocked.

Protect from Exposure to Moisture and Foreign Objects



WARNING: Avoid electric shock and fire hazard! Do not expose this product to dripping or splashing liquids, rain, or moisture. Objects filled with liquids, such as vases, should not be placed on this apparatus.



WARNING: Avoid electric shock and fire hazard! Unplug this product before cleaning. Do not use a liquid cleaner or an aerosol cleaner. Do not use a magnetic/static cleaning device (dust remover) to clean this product.



WARNING: Avoid electric shock and fire hazard! Never push objects through the openings in this product. Foreign objects can cause electrical shorts that can result in electric shock or fire.

Service Warnings



WARNING: Avoid electric shock! Do not open the cover of this product. Opening or removing the cover may expose you to dangerous voltages. If you open the cover, your warranty will be void. This product contains no user-serviceable parts.

Check Product Safety

Upon completion of any service or repairs to this product, the service technician must perform safety checks to determine that this product is in proper operating condition.

Protect the Product When Moving It

Always disconnect the power source when moving the apparatus or connecting or disconnecting cables.

20110316_Cable_Safety

Welcome

The Cisco® ITV7900 family of IP set-tops provide high-definition (HD) capability and broadband digital video services in exceptional picture and audio quality. On MoCA™-enabled set-tops, the MoCA connection enables an IP LAN connection over coaxial cable, which minimizes the need for new wiring in the home. On wireless-enabled set-tops, the connection with a video-centric access point/gateway, allows you to add new Wireless Protected Setup (WPS) -compliant clients to your home network giving you the flexibility to watch TV anywhere in the house. Contact your service provider for wireless pairing information and other available services.

Follow the instructions in this guide to install the set-top and to access the programming offered by your service provider.

The consumer support website provides news and information about this product. For more information, please refer to <http://www.cisco.com/web/consumer/support/index.html>.

Safety First

Before using the set-top, read the Important Safety Instructions section of this guide.

Identify your Set-Top

If your set-top requires troubleshooting in the future, your service provider may ask for this serial number. The serial number can be located on the label found at the bottom of the set-top.

CISCO
ITV790x
Set-Top Box SD/HD
Date of Mfg: XXXX-XX-XX
Input: 12VDC/15W

PID: XXXXXXXX
TAN: XX-XXXXXX-XX
HW: XXXXX
SW: XXXXX
Cisco factory ID: PSZ
Made in China

UL LISTED I.T.E. E.317539

FC

Serial Number → SN: XXXXXXXX

Wi-Fi MAC: XXXXXXXXXXXX

Ethernet Mac: XX XX XX XX

Manufactured under license from Dolby Laboratories
Dolby and the double-D symbol are trademarks of
Dolby Laboratories.

T16600

Watch TV

Use the Remote Control to Access Services and Programs

Press the following keys on the remote control to access services:

- Guide – Display the on-screen guide of TV programming schedules and other services available from your service provider, such as video-on-demand and pay-per-view programs.
- Arrows – highlight a program in the schedule.
- Info – Display the description of a specific program (either from the on-screen guide or while viewing a program).

Front Panel







1 Power

Turns the set-top on or places it in standby mode

2 Display

Displays the selected channel number and time of day. The display shows the following:

- Record (**REC**) - Indicates a recording is in progress when illuminated
- Home () - Indicates multi-room DVR activity when illuminated
- WiFi () - Indicates the set-top is receiving a wireless signal when illuminated
- Communication () - Indicates the set-top is receiving data via MoCA, Ethernet, or WiFi when illuminated
- Power () - Indicates the set-top is on when illuminated
- Message () - Indicates the set-top has received a system message when illuminated

Notes:

- This illustration may vary from the actual product
- The usage of the icons may vary based on the software implementation

Back Panel

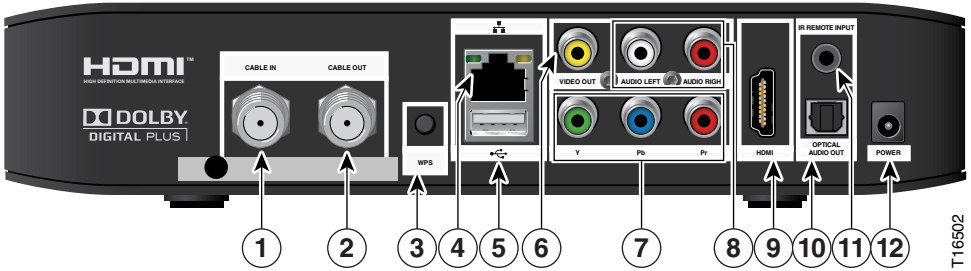

T16502

- 1 Cable In (optional for some models)** Connects to a coaxial cable that delivers the MoCA signal (IP over coax) to the set-top
 - 2 Cable Out** Connects to a coaxial cable that sends audio and video signals to a TV or VCR
 - 3 WPS (optional for some models)** When pressed, initiates the wireless setup feature, which allows you to add new Wireless Protected Setup (WPS) compliant clients to your home network
 - 4 Ethernet** Connects to the in-home network via Ethernet instead of using MoCA or WiFi
 - 5 USB 2.0** Connects to external USB equipment if supported by your service provider
 - 6 Video Out** Connects to the composite video input on your TV
 - 7 Y Pb Pr** Connects to the component input (YPbPr) on your TV
 - 8 Audio Out (Left/Right)** Connects to RCA cables that send analog audio signals (left and right) to the stereo inputs on a TV
 - 9 HDMI** Connects an HDMI™ cable to the HDMI input of an HDTV. HDMI supports both digital audio and video. May be used to connect to a DVI interface using an HDMI-to-DVI adapter for video and separate audio connections. Any of the following audio connections may be used: Audio Out Left/Right (8) or Optical Audio Out (10)
 - 10 Optical Audio Out** Connects to an optical cable that sends a digital audio signal to a surround-sound receiver or other digital audio device input
 - 11 IR Remote Input** Available to be connected to an approved remote IR receiver (purchased separately). Contact your service provider for details
 - 12 AC Power Input** Connects to the external power supply to deliver power to the set-top
- SD Card reader (optional, not shown)** Allow the addition of an SD card reader to support time shifted buffer (TSB) functionality

Notes:

- This illustration may vary from the actual product
- The usage of the icons may vary based on the software implementation

Connecting the Receiver

To connect your receiver to your network and home entertainment devices, complete these steps.

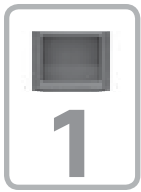

Because the connections for a high-definition (HD) or standard-definition (SD) TV are different, you must determine if your TV is HD or SD. Your TV must receive HD signals for you to enjoy the benefits of HDTV. Refer to the manual that came with your TV for more information.

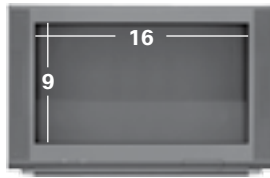

or

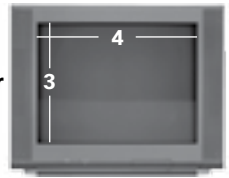

See page 26 for more information on picture formats.

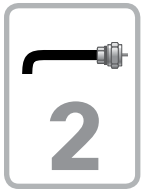

Make one of the following connections for your home network:

- If your home network uses coaxial cable, use the TO WALL connector on the receiver. **See page 11.**
- If your home network uses twisted pair cable (phoneline wiring), use the TO WALL connector on the receiver and an adapter that converts twisted pair to coaxial. **See page 11.**
- If your home network uses Ethernet (CAT-5) cable, use the NETWORK connector on the receiver. **See page 11.**

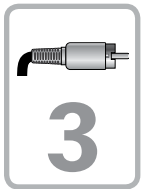

Make the connections for your TV, VCR, and DVD recorder as follows:

- If you are using an HDTV, **see page 12** and the connection diagrams in this manual.
- If you are using a standard-definition TV, **see page 13** and the connection diagrams in this manual.
- If you want to record some programs on VCR tape or DVD, **see page 14** and the connection diagrams in this manual.



Identify the additional consumer electronic devices you will connect to the receiver and TV. **See pages 15 through 23** and refer to the owner's manual for the device.



Plug the receiver and the TV into an AC power source that is not controlled by a switch.

Connecting to the In-Home Network

The following diagrams illustrate examples of the connections you can use to connect your receiver to your in-home network. Contact your service provider for the recommended connection method for your home.

Notes:

- The in-home coaxial and phoneline wiring networks use HomePNA 3.1 technology.
- The illustrations below may vary from the actual product.

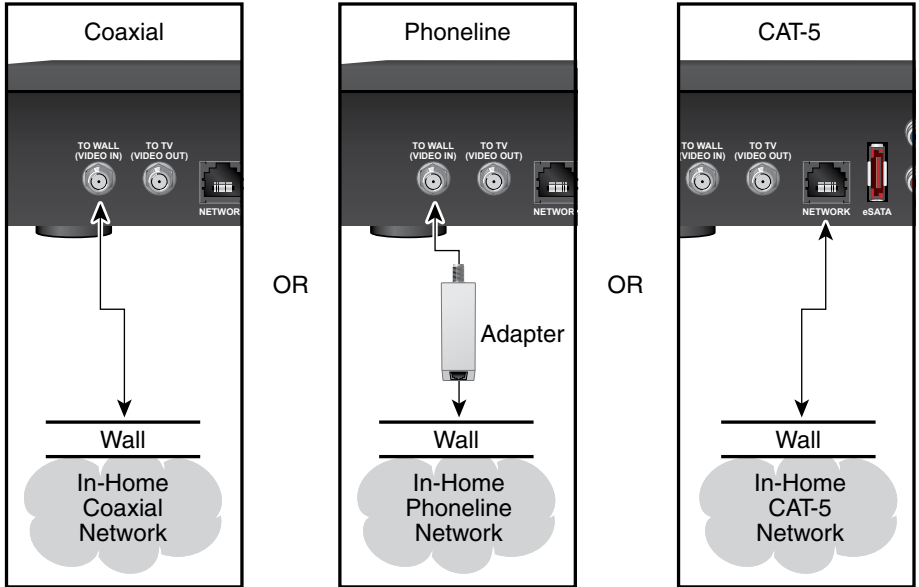

T15906

Should this stay shown with connections to the back of the ITV7900?

Should this connection page stay using connectors from the ITV7900?



















Connections for a High-Definition TV (HDTV)

To use the receiver with an HDTV, you must make *one* of the following connections to view the HD content. Refer to the owner's manual for your TV and the cabling diagrams in this manual for more detailed connection information.

Although all connections provide you with quality service, we list the connections in our recommended order.

Notes:

- The labeling on your receiver or HDTV may vary slightly from the illustrations shown below.
- Some cables shown in the connection diagrams may not be included with this receiver.

Use One of These Required Connections to an HDTV		Receiver Connections		HDTV Connections
HDMI	<p>Some HDTVs have a High-Definition Multimedia Interface (HDMI) connector. The HDMI connector provides both a digital video and audio connection. See the connection diagram on page 15 for an example.</p> <p>Note: The HDMI port on the TV must support high-bandwidth digital content protection (HDCP).</p>	 HDMI	Audio/Video	 HDMI
DVI	<p>The HDMI connector can provide the connection to an HDTV with a DVI input. If your HDTV has a Digital Visual Interface (DVI) connector, you need an HDMI-to-DVI adapter, and a separate audio connection (either L/R or optical audio).</p> <p>Note: The DVI port on the TV must support high-bandwidth digital content protection (HDCP).</p> <p>See the connection diagram on page 16 for an example.</p>	 HDMI	Video	 DVI
		<div style="background-color: black; color: white; text-align: center; padding: 2px;">Adapter Needed</div>  AUDIO OUT	Audio	 L R
		 OPTICAL		 OPTICAL INPUT
YPbPr	<p>The YPbPr (red, blue, and green) connectors provide high-definition component video signals to an HDTV, and a separate audio connection (either L/R or optical audio).</p> <p>See the connection diagram on page 17 for an example.</p>		Video	 Y Pb Pr
		 AUDIO OUT	Audio	 L R
		 OPTICAL		 OPTICAL INPUT
RGB	<p>Some HDTVs have only RGB or RGB-HV connectors. If you have one of these HDTVs, you need a Component-to-RGB adapter, and you need a separate audio connection.</p>		Video	 R G B H V
		<div style="background-color: black; color: white; text-align: center; padding: 2px;">Adapter Needed</div>  AUDIO OUT	Audio	 L R











Connections for a Standard-Definition TV (SDTV)

When using the receiver with an SDTV, you must make *one* of the following connections to view content. Some SDTVs may not have all these connections. Refer to the owner's manual for your TV and the cabling diagrams in this manual for more detailed information.

Although all connections provide you with quality service, we list the connections in our recommended order.

Notes:

- The labeling on your receiver or SDTV may vary slightly from the illustrations shown below.
- Some cables shown in the connection diagrams may not be included with this receiver.

Use One of These Required Connections to an SDTV		Receiver Connections		SDTV Connections
YPbPr	<p>The YPbPr (red, blue, and green) connectors can provide standard-definition component video signals to an SDTV. A separate audio connection is also needed.</p> <p>See the connection diagram on page 18 for an example.</p>		Video	
				Audio
S-Video	<p>The S-Video connection provides an optimal video connection to SDTVs. A separate audio connection is also needed.</p> <p>See the connection diagram on page 19 for an example.</p>		Video	
				Audio
Video Out	<p>The Video Out connector provides a video connection to an SDTV. A separate audio connection is also needed.</p> <p>See the connection diagram on page 20 for an example.</p>		Video	
				Audio
To TV (Video Out)	<p>The To TV (Video Out) connector provides both a video and audio connection to an SDTV.</p> <p>See the connection diagram on page 21 for an example.</p>		Audio/Video	

using connectors from the ITV7900?







Connections for a VCR or DVD Recorder

When using the receiver with a VCR or DVD recorder, you must make *one* of the following connections to view content.

Although all connections provide you with quality service, we list the connections in our recommended order.

Notes:

- The labeling on your receiver, VCR, or DVD recorder may vary slightly from the illustrations shown below.
- Some cables shown in the connection diagrams may not be included with this receiver.

Use One of These Optional Connections to a VCR or DVD Recorder	Receiver Connections		VCR/DVD Recorder Connections
VCR/DVD Recorder For VCRs or DVD recorders with S-Video In and Left and Right audio connectors, use the S-Video and the Audio Out Left and Right connectors on the receiver.	 S-VIDEO	Video	 S-VIDEO IN
	 L R AUDIO OUT		Audio
For VCRs or DVD recorders with Video In and Left and Right audio connectors, use the Video Out and the Audio Out connectors (Left and Right) on the receiver.	 VIDEO OUT	Video	 VIDEO IN
See the connection diagram on page 23 for an example.	 L R AUDIO OUT		Audio

Connecting an Over-the-Air Converter Box

You can connect an over-the-air converter box directly to your TV to receive certain local channels, but do not connect the over-the-air converter box directly to your receiver.

Connecting to an HDTV with an HDMI Connector

Cable Used in this Configuration

- 1 HDMI Cable

Notes:

- The HDMI port on the TV must support high-bandwidth digital content protection (HDCP).
- The HDMI interface supports Dolby™ Digital 5.1 audio.



WARNING:

Electric shock hazard! Unplug all electronic devices before connecting or disconnecting any device cables to the receiver.

Back of Set-Top

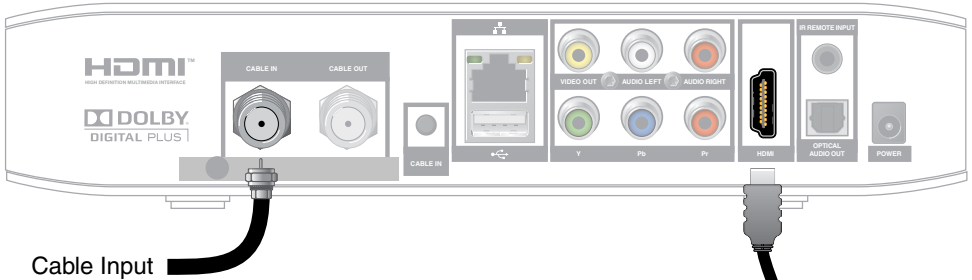

Back of HDTV

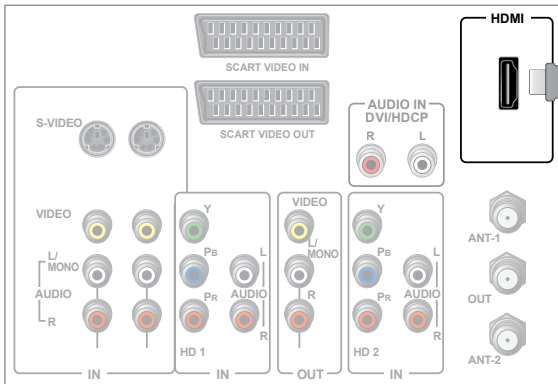

Connecting to an HDTV with Component (YPbPr) Connectors

Cables Used in this Configuration

- 1 Component Video Cable (YPbPr)
- 1 Audio Left/Right Cable (You can also use an optical cable [indicated by the dotted line] instead of the Audio Left/Right Cable as shown in the diagram, dependent upon your TV's capabilities.)



WARNING:

Electric shock hazard! Unplug all electronic devices before connecting or disconnecting any device cables to the receiver.

Back of Set-Top

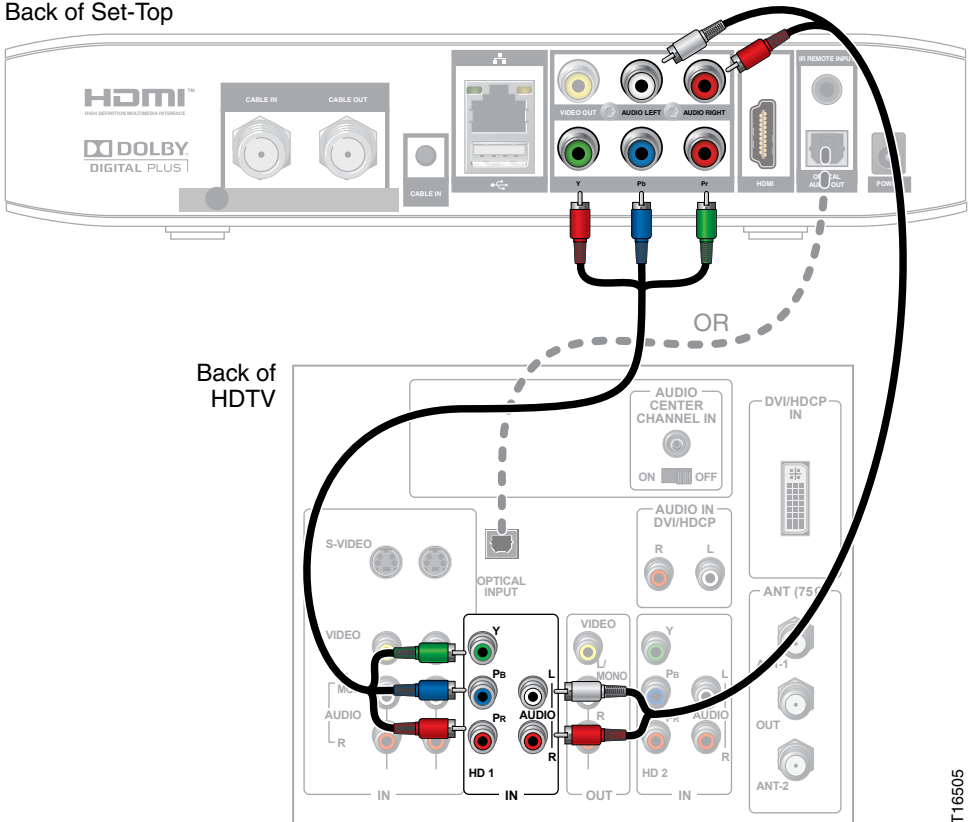

T16505

Connecting to an SDTV with Component (YPbPr) Connectors

Cables Used in this Configuration

- 1 Component Video Cable (YPbPr)
- 1 Audio Left/Right Cable

Note: The receiver must be set to the proper standard-definition mode.



WARNING:

Electric shock hazard! Unplug all electronic devices before connecting or disconnecting any device cables to the receiver.

Back of Set-Top

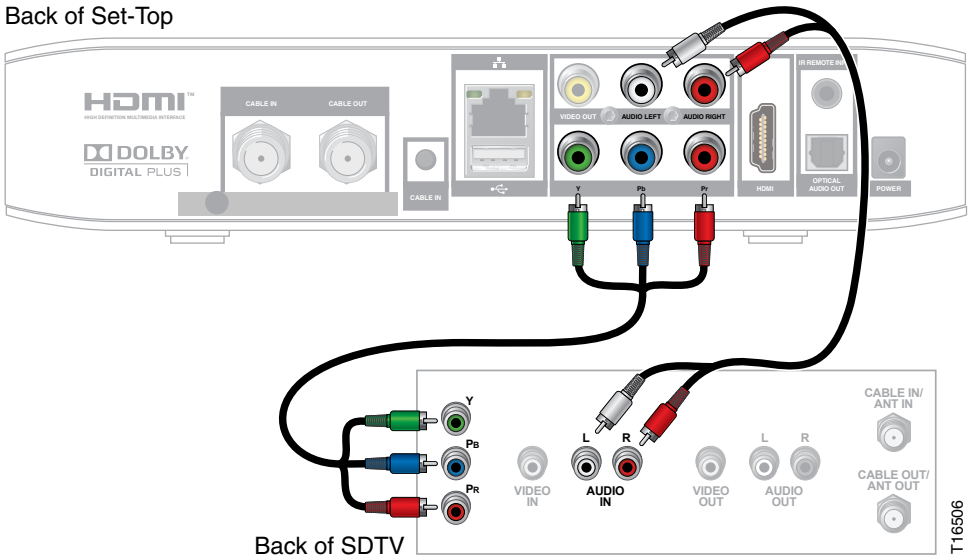

Back of SDTV

T16506

Connecting to an SDTV with an RCA-Type Connector

Cables Used in this Configuration

- 1 RCA-type Video Cable
- 1 Audio Left/Right Cable



WARNING:

Electric shock hazard! Unplug all electronic devices before connecting or disconnecting any device cables to the receiver.

Back of Set-Top

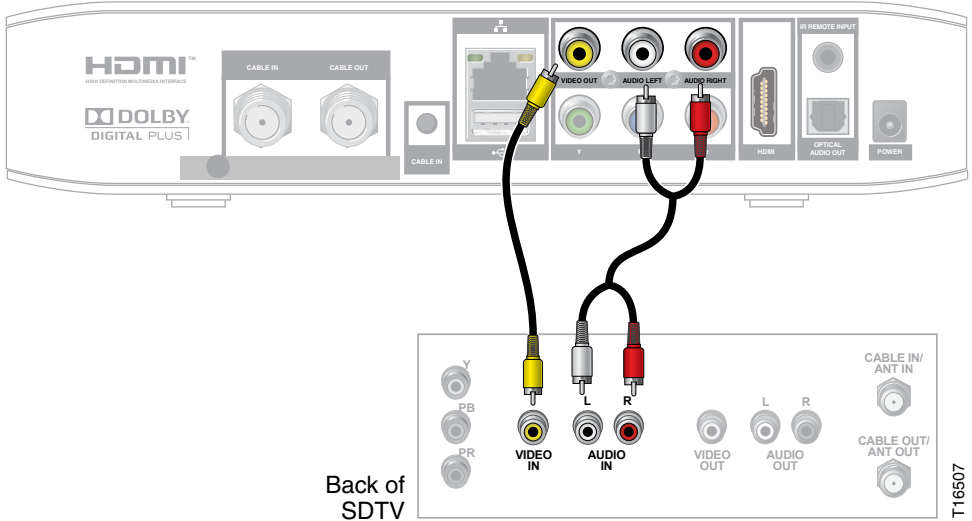

T16507

Connecting to a Home Theater System with Component (YPbPr) Connectors

Cables Used in this Configuration

- 1 Component Video Cable (YPbPr)
- 1 Audio Left/Right Cable (You can also use an optical cable [indicated by the dotted line] instead of the Audio Left/Right Cable as shown in the diagram.)

Notes:

- This connection requires that audio is provided by the home theater system.
- Consult the user guide that came with your home theater system for information on connecting your other video and audio devices.



WARNING:

Electric shock hazard! Unplug all electronic devices before connecting or disconnecting any device cables to the receiver.

Back of Set-Top

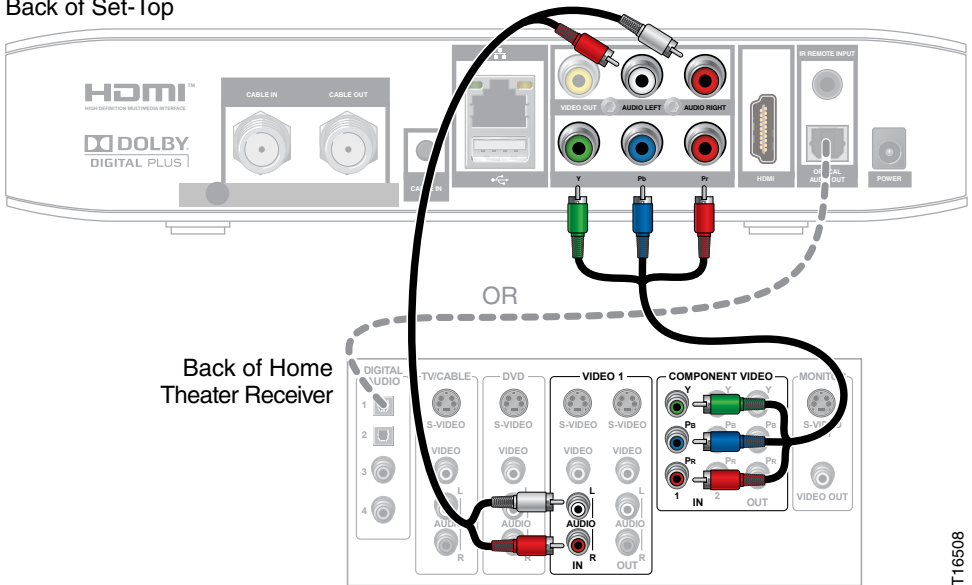

T16508

Connecting to a Stereo VCR or DVD Recorder (optional)

The diagram below shows how to connect a recording device to your receiver. Although it is possible to watch TV using a connection through your VCR or DVD recorder to the TV, this connection may not provide the best picture, and HDTV users are restricted to an SD format. In addition, some content is copy protected and passing this content through the recording device may result in a picture that cannot be viewed.

For these reasons, the connection shown is best used to provide only video and audio to your recording device and not for normal TV viewing. The connection from the recording device to the TV (only used for playback of recorded material) depends on the type of device being used, the outputs that are supported, and the inputs that remain available for use on your TV.

Consult the owner's manuals provided with your TV and recording device for more details on connection options.

Cables Used in this Configuration

- 1 RCA-type Video Cable
- 1 Set Audio Left/Right Cables



WARNING:

Electric shock hazard! Unplug all electronic devices before connecting or disconnecting any device cables to the receiver.

Connecting your TV directly to the Audio/Video output of your receiver will assure a more vivid picture and enhance your viewing enjoyment.

Back of Set-Top

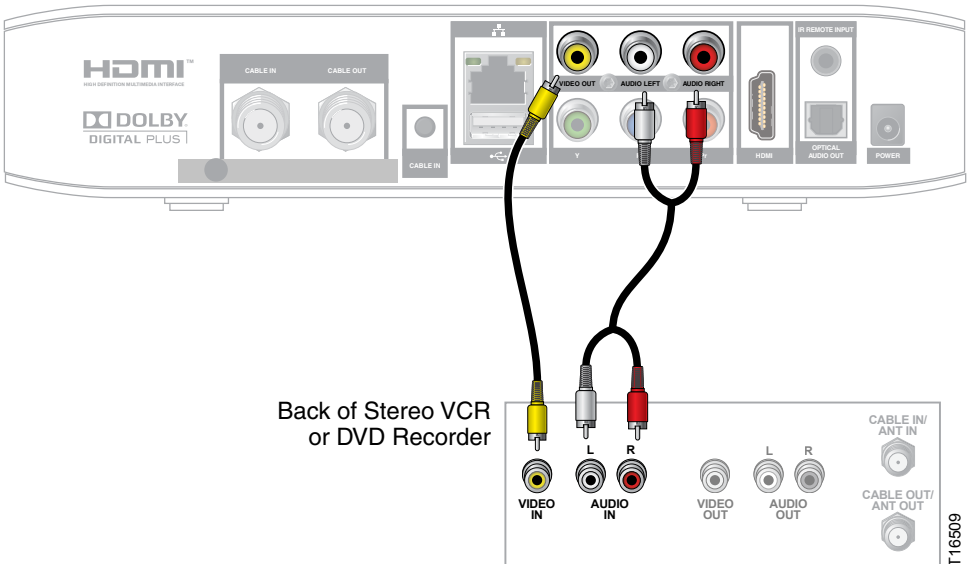

T16509

Troubleshooting

If the set-top does not perform as expected, the following tips may help you. If you need further assistance, contact your service provider:

No Picture

- Verify that power to your TV is turned on.
- If the set-top is plugged into a wall switch, verify the wall switch is in the ON position.
- Verify that all cables are properly connected.
- The current channel may not be available in your service package. Try selecting another channel to see if a picture appears.

No Color

- Verify the current TV program is broadcast in color.
- Adjust the TV color controls.

No Sound

- If your setup includes a stereo, verify that you have properly connected it to the set-top.
- Verify the volume is turned up.
- Verify the mute function is not on.

Avoid Screen Burn-In

Images such as letterbox bars or side bars, bright closed-captioning backgrounds, station logos, or any other stationary images may cause the display in your HDTV to age unevenly; this is known as screen burn-in. Refer to the owner's manual that came with your HDTV for more information.



CAUTION:

Avoid screen burn-in. Do not display the same fixed images on your HDTV screen for extended periods of time.

Frequently Asked Questions

What Is Digital Television?

Digital television (DTV) is a huge leap forward in television technology compared to analog television that has been widely available since the 1940s. DTV is delivered and displayed using digital encoding, similar to the way a PC operates. By using digital technology, there is no variation in picture and sound quality from the origination point until it is displayed on your television. You always receive a high-quality picture without the wavy lines or static you might sometimes get from a weak analog signal. Another feature of digital television is digital surround sound using Dolby Digital technology, which is the same technology used to produce the sound you hear in movie theaters.

What Is Standard-Definition Television?

Standard-definition television (SDTV) is basic digital television programming delivered by your service provider. Typically, the SDTV screen is the same, nearly square shape as an analog television screen. Digital images on an SDTV set are crisp and clear—noticeably better than on a standard analog television set using an antenna to receive over-the-air signals.

What Is High-Definition Television?

High-definition television (HDTV) is a completely new way to send and receive television broadcast signals. HDTV images are made up of pixels that are much smaller and closer together than those used in standard analog television, and there are millions of them. Thus, HDTV can display five to six times the detail of analog television to deliver picture quality that is much more realistic, dimensional, and precise. SDTV programs can be viewed on an HDTV.

Are Local TV Stations or Other Programmers Broadcasting in HDTV?

Many local TV stations and programmers are transmitting digital signals. However, transmitting a digital signal does not mean transmitting an HDTV signal. Some stations are using the new bandwidth to broadcast several standard-definition channels. Most stations and programmers, once they begin broadcasting in digital, are offering HD content from their parent network (for example, CBS, ABC, NBC, Fox, and PBS). Contact your service provider for more information.

Why Aren't All the Shows I Watch in High-Definition?

A high-definition program must originate in HD format and be broadcast in HD format. Having an HDTV system does not mean that everything you watch will be viewed in high-definition. Getting the signal from a digital source also does not mean it is high-definition.

Why Are Some HDTVs 4:3 Aspect Ratio and Others 16:9?

The aspect ratios differ because television manufacturers build both standard-screen and wide-screen HDTVs to appeal to consumer viewing preferences. The two aspect ratios are as follows:

- On standard-screen (4:3) HDTVs, the programming is displayed in letterbox format in the middle of the screen. There are bars surrounding the picture.
- On wide-screen (16:9) HDTVs, the programming is displayed on the full screen.

What Is HDMI and Does it Support Dolby Digital 5.1 Audio?

The High-Definition Multimedia Interface (HDMI) is an uncompressed, all-digital audio/video interface. The Dolby Digital audio format that provides up to 5.1 separate channels of surround sound, and is the standard used for DVD-Video. HDMI supports standard, enhanced, or high-definition video, plus multi-channel digital audio, such as Dolby Digital audio, on a single cable.

Picture Formats

What Is the Difference Between a Standard-Screen and a Wide-Screen HDTV?

The type of screen your HDTV has (wide-screen or standard-screen) determines how the receiver displays programs on the screen. The picture format for an HDTV is a combination of *aspect ratio* and *screen resolution* and is different for standard-screen and wide-screen HDTVs.

What Is Aspect Ratio?

An aspect ratio is the ratio of the width to the height of the TV screen. The aspect ratios differ because the television industry manufactures both standard-screen and wide-screen HDTVs to appeal to consumer viewing preferences.

What Is the Screen Resolution?

The screen resolution indicates the amount of detail that the picture displays. Resolution is identified by the number of display lines on the screen. The techniques that an HDTV uses to “paint” the picture on the screen are referred to as progressive and interlaced.

With the **progressive scanning** method, the lines are drawn on the screen one at a time in sequential order. Progressive scanning results in a more detailed image on the screen and is also less susceptible to the flicker commonly associated with interlaced scanning. The **interlaced method** involves refreshing pixels in alternation – first the odd lines and then the even lines.

For advanced setup, select the screen resolution that your TV can support. Refer to your *Feature Guide* and HDTV owner’s manuals to choose the proper screen resolution (480i, 720p, 1080i, or 1080p) for your setup.

For example, a screen resolution of 1080i indicates that the screen shows 1080 lines in an interlaced display, and 720p indicates that the screens shows 720 lines in a progressive display.

A **standard-screen HDTV** has a 4x3 aspect ratio. The screen is 4 units wide for every 3 units tall.

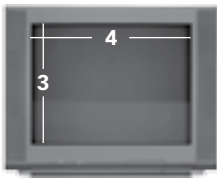

A screen resolution of 480i fills the screen.

A **wide-screen HDTV** is one-third wider than a standard-screen HDTV. The screen is 16 units wide for every 9 units tall.

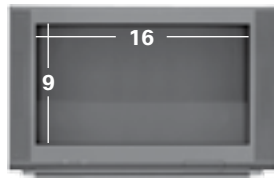

A screen resolution of 720p, 1080i, or 1080p fills the screen.

Cisco and the Cisco logo are trademarks or registered trademarks of Cisco and/or its affiliates in the U.S. and other countries. To view a list of Cisco trademarks, go to this URL: www.cisco.com/go/trademarks. Third-party trademarks mentioned are the property of their respective owners. The use of the word partner does not imply a partnership relationship between Cisco and any other company. (1110R)

Manufactured under license from Dolby Laboratories. Dolby and the double-D symbol are trademarks of Dolby Laboratories.

HDMI The terms HDMI and HDMI High-Definition Multimedia Interface, and the HDMI Logo are trademarks or registered trademarks of HDMI Licensing LLC in the United States and other countries.

Rovi is a trademark of Rovi Corporation.

MoCA is a trademark of the Multimedia over Coax Alliance.

© 2014 Cisco and/or its affiliates. All rights reserved.

Last Updated: July 2014

OL-32797-01

Printed in China