

# DASH

## User Guide

Version: 1.0

## **Introduction**

1. Please read these safety instructions carefully.
2. Please keep this User's Manual for later reference.
3. Please disconnect this equipment from connector before cleaning. Don't use liquid or sprayed detergent for cleaning. Use moisture sheet or cloth for cleaning.
4. Make sure the equipments are connected to the power source with the correct voltage, frequency, and ampere.
5. All cautions and warnings on the equipment should be noted.
6. Never pour any liquid into opening: this could cause fire or electrical shock.
7. Never open the equipment. For safety reason, the equipment should only be opened by qualified service personnel.
8. If one of the following situations arises, get the equipment checked by a service personnel:
  - a. Liquid has penetrated into the equipment.
  - b. The equipment has been exposed to moisture.
  - c. The equipment has not worked well or you cannot get it work according to user manual.
  - d. The equipment has dropped and damaged. If the equipment has obvious sign of breakage.

9. Caution on use of battery: User the battery recommended by the manufacturer or the same type of battery installed by the manufacturer. If incorrect battery is used, it may cause explosion or fire hazard. Recycle or discard used batteries according the manufacturer's instruction or your local authority.
10. The computers use nonvolatile memory that requires a battery to retain system information when power is removed. The 3V lithium battery is on the system board. The battery life depends on the amount of time the computer is powered on. If the computer does not display the correct time and date, replace the battery.

**IMPORTANT :** Loss of BIOS settings occurs when the battery is removed. BIOS settings must be reconfigured whenever the battery is replaced.

**WARNING :** A risk of fire and chemical burn exists if the battery is not handled properly. Do not disassemble, crush, puncture, or short external contacts, or expose the battery to temperatures higher than 60 °C (140 °F). Do not dispose of a used battery in water or fire.

**CAUTION :** Danger of explosion if battery is incorrectly replaced. Replace only with same or equivalent type recommended by the manufacturer. Discard used batteries according to the manufacturer's instructions.

### **FCC Compliance Statement**

This equipment has been tested and found to comply with the limits for a class B digital device, pursuant to part 15 of the FCC Rules. These limits are designed to provide reasonable protection against harmful interference in a residential installation.

This equipment generates uses and can radiate radio frequency energy and, if not installed and used in accordance with the instructions, may cause harmful interference to radio communications. However, there is no guarantee that interference will not occur in a particular installation. If this equipment does cause harmful interference to radio or television reception, which can be determined by turning the equipment off and on, the user is encouraged to try to correct the interference by one or more of the following measures:

- Reorient or relocate the receiving antenna.
- Increase the separation between the equipment and receiver.
- Connect the equipment into an outlet on a circuit different from that to which the receiver is connected.
- Consult the dealer or an experienced radio/TV technician for help.

**FCC Caution:** Any changes or modifications not expressly approved by the party responsible for compliance could void the user's authority to operate this equipment.

**FCC RF Radiation Exposure Statement:**

1. This Transmitter has been demonstrated co-location compliance requirements with Wi-Fi, Bluetooth and RF ID. This transmitter must not be co-located or operating in conjunction with any other antenna or transmitter.
2. This equipment complies with FCC RF radiation exposure limits set forth for an uncontrolled environment. This device was tested for typical hand held operations with the device contacted directly to the human body to the back side of the tablet pc. To maintain compliance with FCC RF exposure compliance requirements, avoid direct contact to the transmitting antenna during transmitting.

**Europe – EU Declaration of Conformity**

This device complies with the essential requirements of the R&TTE Directive 1999/5/EC and EMC directive 2004/108/EC. The following test methods have been applied in order to prove presumption of conformity with the essential requirements of the R&TTE Directive 1999/5/EC and EMC directive 2004/108/EC:

- < EN 55022: 2006 +A1: 2007
- < EN 61000-3-2 : 2006
- < EN 61000-3-3 : 1995 + A1 : 2001 + A2 : 2005
- < EN 55024: 1998 + A1: 2001 + A2: 2003

## DASH User Guide

---

(IEC 61000-4-2: 2008;  
IEC 61000-4-3: 2006 + A1:2007;  
IEC 61000-4-4: 2004;  
IEC 61000-4-5: 2005;  
IEC 61000-4-6: 2003 + A1: 2004 +A2: 2006;  
IEC 61000-4-8: 1993 +A1: 2000;  
IEC 61000-4-11: 2004)

< EN 60950-1: 2001

Safety of information technology equipment

< EN 300 328 V1.7.1: 2006

< EN 301 489-17 V2.1.1: 2009 and EN 301 489-1 V1.8.1: 2008

< EN 62311: 2008

This device is a 2.4GHz wideband transmission system (transceiver), intended for use in all EU member states and EFTA countries under the following conditions and/or with the following restrictions:

< In Italy the end-user should apply for a license at the national spectrum authorities in order to obtain authorization to use the device for setting up outdoor radio links and/or for supplying public access to telecommunications and/or network services.

< This device may not be used for setting up outdoor radio links in France and in some areas the RF output power may be limited to 10 mW EIRP in the frequency range of 2454 – 2483.5 MHz. For detailed information the end-user should contact the national spectrum authority in France.



# Table of Contents

<b>Introduction .....</b>	<b>2</b>
<b>Chapter 1 General Information .....</b>	<b>13</b>
<b>1.1. Introduction .....</b>	<b>13</b>
<b>1.2. Specification .....</b>	<b>13</b>
1.2.1. Main System .....	13
1.2.2. I/O Interface .....	15
1.2.3. In Front Control .....	16
1.2.4. Power Management .....	16
1.2.5. Environment .....	16
1.2.6. Material .....	17
1.2.7. Operation OS .....	18
1.2.8. Certifications .....	18
1.2.9. Optional: External Accessories .....	118
1.2.10. Optional: Packing Lists .....	18
<b>1.3. Packing List .....</b>	<b>19</b>



**1.4. Dimensions.....19**

**Chapter 2 System Setup .....22**

**2.1. Exploring Your DASH .....22**

2.1.1. .... *The front side of the DASH*  
.....22

2.1.2. .... *The rear side of the DASH*  
.....26

2.1.3. .... *The right side of the DASH*  
.....27

2.1.4. .... *The left side of the DASH*  
.....28

2.1.5. .... *The bottom side of the DASH*  
.....30

**2.2. Preparing for Installation.....30**

2.2.1. .... *Installing the Rubber Bumpers*  
.....30

2.2.2. .... *Removing the Rubber Bumpers*  
.....31

2.2.3. .... *Plugging to the DC supply*  
.....31

## DASH User Guide

---

2.2.4. ....	Starting Your System	33
2.2.5. ....	Connecting the keyboard and mouse	34
<b>2.3. Installing the Drivers.....</b>		<b>35</b>
<i>Installing Windows 7 from Optical Disk Drive.....</i>		35
<i>Installing the Chipset Driver .....</i>		35
<i>Installing the VGA Device Driver .....</i>		36
<i>Installing the Audio Device Driver .....</i>		37
<i>Installing the Touch Panel Driver.....</i>		37
<i>Installing the LAN Device Driver .....</i>		38
<i>Installing Hotkey Driver and Utility .....</i>		38
<i>Installing Wireless LAN Device Driver.....</i>		39
<i>Installing the Bluetooth Driver And Utility .....</i>		40
<i>Installing the Camera Utility .....</i>		40
<b>Chapter 3 Using the DASH .....</b>		<b>41</b>
<b>3.1. Introduction .....</b>		<b>41</b>
<b>3.2. Using the USB Ports .....</b>		<b>42</b>

---

**3.3. Using the External Audio System.....43**  
**3.4. Installing the Battery.....43**

***Chapter 4 The BIOS Setup Program ..... 45***

**4.1. Main Screen Setup Utility .....46**  
**4.2. Advanced BIOS Features .....48**  
**4.3. Security Chip Configuration .....50**  
**4.4. Boot Management Setup.....51**  
**4.5. Exit Control.....52**

***Chapter 5 User Interface for DASH ..... 54***

**5.1. Introduction .....54**  
**5.2. About the User Interface .....54**  
    5.2.1..... *Enable or disable the User Interface*  
    .....54  
    5.2.2..... *Hibernate this System*  
    .....56  
    5.2.3..... *System Status Information*  
    .....56  
**5.3. Using the Application .....58**  
    5.3.1..... *Brightness Control*

## DASH User Guide

---

.....	59
5.3.2.....	<i>Volume Control</i>
.....	60
5.3.3.....	<i>Webcam Launch</i>
.....	61
5.3.4.....	<i>Monitor Switch</i>
.....	61
<b>Chapter 6 Maintenance .....</b>	<b>63</b>
<b>6.1. Maintaining the Battery .....</b>	<b>63</b>
<b>6.2. Maintaining the LCD Display.....</b>	<b>64</b>
<b>6.3. Cleaning the DASH .....</b>	<b>64</b>

# ***Chapter 1***

## **General Information**

### ***1.1. Introduction***

DASH semi-rugged tablet PC is Intel® Oak Trail Atom Z670 1.5GHz processor core architecture based Semi-rugged Tablet PC with a bright 10.1-inch LED backlight LCD display. The powerful CPU brings the most dynamic applications to life without sacrifices to any industrial reliability.

Delivering a variety of connectivity features, built-in USBs, Microphone and Headphone port. It is ideal for an all-around system performance.

Furthermore, DASH semi-rugged tablet PC is equipped with fanless design.

### ***1.2. Specification***

The DASH semi-rugged tablet PC is a flexible, multi-functional flat tablet PC. With following specifications that can be applied in diverse operational environments and implemented in multi-faceted applications.

#### **1.2.1. Main System**

- **Platform:**
  - < Intel® Oak Trail Platform
- **GPU :**

## DASH User Guide

---

- < Intel® Atom Z6701.5GHz
- < Processor packing : Micro-FCBGA
- < Cores : Single Core
- < On-die L2 Cache : 512KB
- < FSB Speed : 400MHz
- **Chipset:**
  - < Chipset : Intel® Whitney Point PCH (SM35)
- **BIOS :**
  - < Phoenix BIOS
- **Graphics :**
  - < Intel® HD Graphics with dynamic frequency, support MPEG2, MPEG4, VC-1, WMV9 and H.264
- **System Memory :**
  - < DDR II 800 (32b) Memory Down, up to 2GB
- **Storage :**
  - < 1 x 1.8-inch half-size micro-SATA Solid State Disk
- **LCD Screen :**
  - < Panel size : 10.1-inch LED Backlight LCD
  - < Brightness : 200nits
  - < Resolution : 1366 RGB(W) x 768(H) WXGA
- **Touch Panel :**
  - < 5-wire Resistive Touch Panel
- **Sunlight Readable :**
  - < Transflective plus type
- **Audio :**

- < Internal Speaker : 2 x High Quality Speakers (2W)
- < Internal Microphone : 1 x in front Bezel
- **Communication :**
  - < 1 x Wireless IEEE 802.11 b/g/n
  - < 1 x Bluetooth 2.1 + EDR
- **RFID (NFC) :**
  - < Frequency : 13.56MHz  $\pm$ 7KHz
  - < Reading Range : within 40 ~50mm depending on type of tags
  - < HF RFID Reader :
    - ISO/IEC 14443A/B, 15693
    - Mifare 1K/4K, Ultralight
    - NFC-IP1 Protocol
- **Webcam :**
  - < Front Bezel: 1.3 Mega-pixel Camera audio input (Digital Microphone) functions.
  - < Rear Bezel: 2 Mega-pixel Camera, LED auxiliary light.

### **1.2.2. I/O Interface**

- **External I/O :**
  - < 2 x USB 2.0 type A
  - < 1 x Headphone Jack
  - < 1 x Microphone Jack
  - < 1 x Docking Connector
  - < 1 x DC-Jack
- **LED Status Indicator:**

- < Power LED Status: 1 x Green/Orange/Red Colors
- < Storage LED Status: 1 x Blue Color
- < Wi-Fi LED Status: 1 x Blue Color

### 1.2.3. In Front Control

- **Switch :**
  - < 1 x Power Button
  - < 1 x Lock Button
  - < 1 x RF Button
- **Button :**
  - < Navigation Buttons : 5+ Way navigation button with integrated enter button
  - < Program Function Buttons : 5 x Function keys (Programmable)
- **Sensor :**
  - < 1 x Light Sensor

### 1.2.4. Power Management

- **Power Adapter :**
  - < AC to DC, 19VDC@3.42A, 65W
  - < AC 100V ~ 240V, 50~60Hz input
  - < 19 DC-in
- **Battery (Internal Battery) :**
  - < Internal Smart Lithium Polymer Battery, 3800mAh

### 1.2.5. Environment

- **Operation Temperature :**
-



- < 0°C to +40°C (MIL-STD-810G Method 501.5 and 502.5)
- **Storage Temperature :**
  - < -20°C to +60°C (MIL-STD-810G Method 501.5 and 502.5)
- **Humidity :**
  - < 5-90% without condensation (MIL-STD-810G Method 507.5)
- **Drop :**
  - < 4-ft drop to Plywood (MIL-STD-810G Method 516.6 Procedure IV)
- **Vibration :**
  - < Operating : SSD (MIL-STD-810G Method 514.6 Category 4 Fig 514.6C-3)
- **Mechanical Shock :**
  - < Operating : 20g, 11ms, Terminal sawtooth
  - < Non-operating : 40g, 11ms, Terminal sawtooth (MIL-STD- 810G Method 516.6 Procedure I)
- **Water/Dust Resistance :** IP54 equivalent

### **1.2.6. Material**

- **Chassis :**
  - < Semi-Rugged Tablet PC Slate
- **Enclosure :**
  - < PC/ABS Plastic, PC/ABS and TPU Double Injection with Protective Rubber Grips Set
- **Dimension (W x H x D mm) :**
  - < 277.8 x 206 x 26.5mm
- **Weight :**
  - < Approximate 1.2kg (with internal battery)

### 1.2.7. Operation OS

- Windows 7 Embedded and Windows 7 Pro. Embedded

### 1.2.8. Certifications

- **EMI :**
  - < CE (EN55022/EN55024), FCC (PART 15B)
- **Safety :**
  - < CE
- **RF :**
  - CE (EN 300 328 / EN 301 489)  
FCC (PART15C)
- **SAR :**
  - < FCC SAR (OET 65)
  - < CE SAR (EN62311)
    - WCDMA/HSDPA 900/2100MHz

### 1.2.9. Optional: External Accessories

- **External Battery Kits :**
  - < **External Battery Pack :**
    - Hot-swappable Lithium Polymer battery pack - doubles duration of mobile operation, 4000mAh

### 1.2.10. Optional: Packing Lists

- Carrying Case
- Handle Secures

## **1.3. Packing List**

<b>Main Packing List</b>	<b>QTY</b>				
Main system	1	Utilities CD	1	Quick Setup Guide	1
Power Adapter	1	Power Code	1	Corner Rubber Screw	4
Corner Rubber	4	Shoulder Strap	1	Hand Strap	1
Stylus	1	Hook Screw	6	Desiccant	1

## **1.4. Dimensions**

The following sections provide information for the DASH dimensions.

**Dimensions (units in mm)**

# DASH User Guide

---

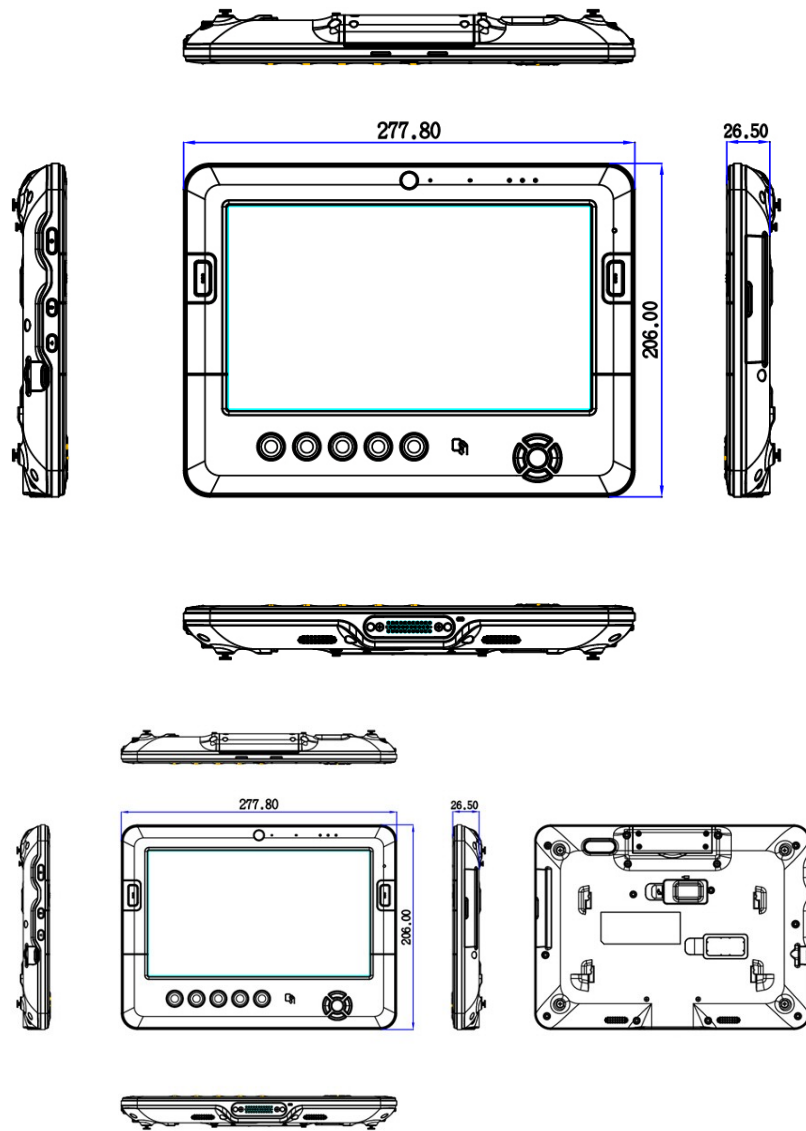

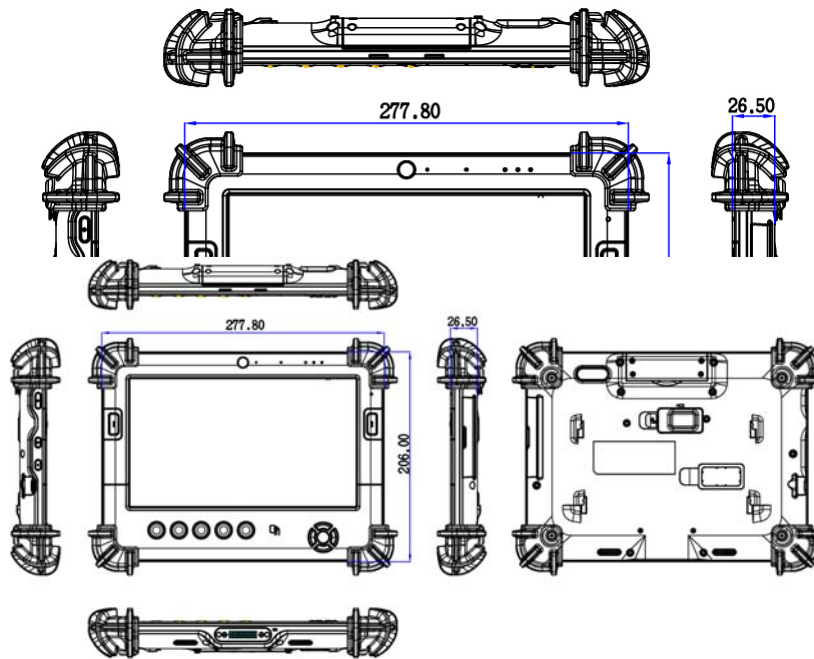

## ***Chapter 2***

# System Setup

### **2.1. Exploring Your DASH**

Before starting to set up the DASH, take familiar with the locations and purposes of controls, drives, connectors and ports, which are illustrated in the figures below. When placed upright on the desktop, the front panel of the DASH appears as shown in Figure 2.1.

#### **2.1.1. The front side of the DASH**

The front side of the DASH is equipped the I/O as described below.

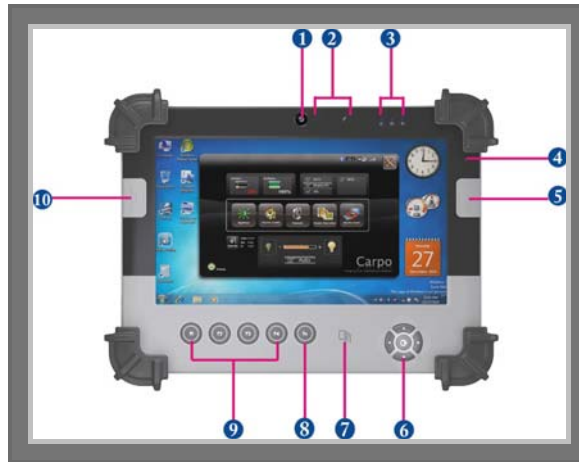

- |                             |                          |
|-----------------------------|--------------------------|
| 1. Camera/1.3 Mega-pixel    | 2. Digital Microphone    |
| 3. LED Power/Storage/Wi-Fi  | 4. Light Sensor          |
| 5. Barcode Button           | 6. Navigation Buttons    |
| 7. RFID                     | 8. User Interface Button |
| 9. Program Function Buttons | 10. Barcode Button       |

- **Camera/1.3 Mega-pixel**

The built-in camera can be used as a communication device for allowing you to capture images, record videos, and have video chats. It is 1.3M pixels and transmitting instant image through network for conference.

- **Digital Microphone**

The built-in microphone receives sounds and voices when used with the built-in camera.

- **LED Power/Storage/Wi-Fi**

Keeps you informed of your system's current power status, Storage operating status, and Wi-Fi accessing status.

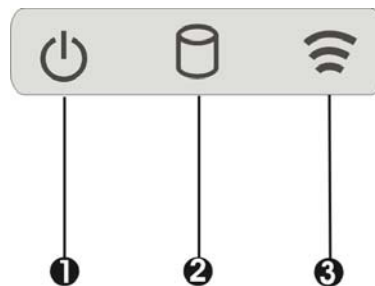

- |                        |                   |
|------------------------|-------------------|
| 1. Power Indicator LED | 2. Storage Access |
| 3. WiFi/Bluetooth      |                   |

- **Power Indicator LED**  
To let you know that system is turned on and indicate the battery charging status.

## DASH User Guide

---

- < Lights green when the system is powered on and battery is fully charged.
- < Lights blinking green when the system is in S3 Suspend.
- < Lights orange indicates that the battery is in charging.
- < Lights off when the battery is discharged or power off.
- < Lights blinking red when the battery power is low under 10%.
- **Storage Access**  
When LED in blue light indicates that the system is accessing the Storage Drive.
- **WiFi/Bluetooth**  
When LED turns on in blue light indicates that the WiFi/Bluetooth is activated. When LED lights off, it indicates that the function is disabled.
- **Light Sensor**  
This sensor works with brightness control. When you set the brightness control to Auto (for details, please refer 5.3.1), it will automatically detect the light environment, and adjust the screen brightness according to the operating environment.
- **Navigation Buttons**  
The navigation buttons include up, down, right, and left arrow keys and the Enter key in the center.  
  
This function lets you press the arrow keys to move the cursor up, down, right, or left on the screen, after that press Enter to execute the function.
- **RFID**  
Data/files transferring from the IR-equipped or equivalent device to your DASH System. This port only can receive data or files from other RFID-equipped or equivalent device.
- **User Interface Button**



If your system does not define User Interface function, this button can be programmable to execute specific application. When you program your application, please write this directory as listed below into your source code, then the system will aware and execute this application.

```
F5_EXE="C:\WINDOWS\system32\taskmgr.exe"  
F5_PARA=""  
F5_PATH=""
```

- **Programmable Function Buttons**

If your system does not define this button's function, this button can be programmable to execute specific application. When you program your application, please write this directory as listed below into your source code, then the system will aware and execute this application.

[Setup]

```
F1_EXE="c:\windows\explorer.exe"  
F1_PARA=""  
F1_PATH=""
```

```
F2_EXE="C:\Program Files\Windows Media Player\wmplayer.exe"  
F2_PARA="/prefetch: 1"  
F2_PATH=""
```

```
F3_EXE="c:\program files\E-Cam\E-CAM.exe"  
F3_PARA=""  
F3_PATH=""
```

```
F4_EXE="C:\WINDOWS\system32\osk.exe"  
F4_PARA=""  
F4_PATH=""
```

### 2.1.2. The rear side of the DASH

The rear side of the DASH is equipped the I/O as described below.

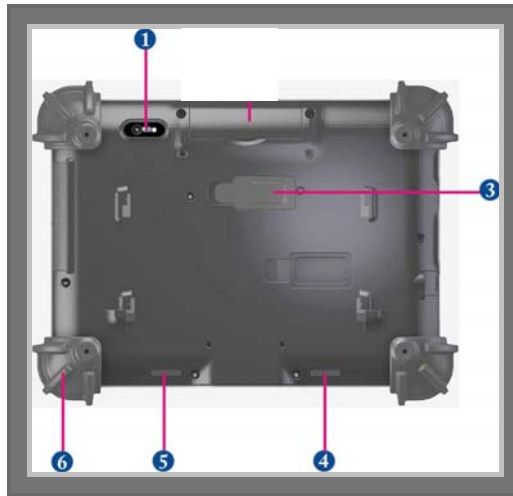

- 1. Camera/2 Mega-pixel
- 3. External Battery Connector
- 4. 5. Speaker
- 6. Protective Rubber

- **Camera/2 Mega-pixel**

The built-in camera can be used as a communication device for allowing you to capture images, record videos, and have video chats. It is 2.0 M pixels and transmitting instant image through network for conference.

- **External Battery Connector**

To install the External Battery, please remove the cover of external battery connector before snap the battery pack into the external battery connector (For details, please refer 3.4).

- **Speaker**  
Integrated left and right mini stereo speakers for sound and audio output for your multimedia presentations or listening pleasure.
- **Protective Rubber**  
To prevent system harm from vibration or shock, the system has been designed with installing four protective rubber at the four corner.

### 2.1.3. The right side of the DASH

The right side of the DASH is equipped the I/O as described below.

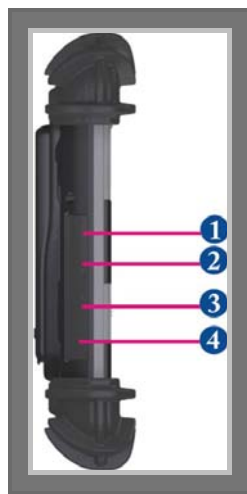

- 1. Microphone port
- 3. USB port

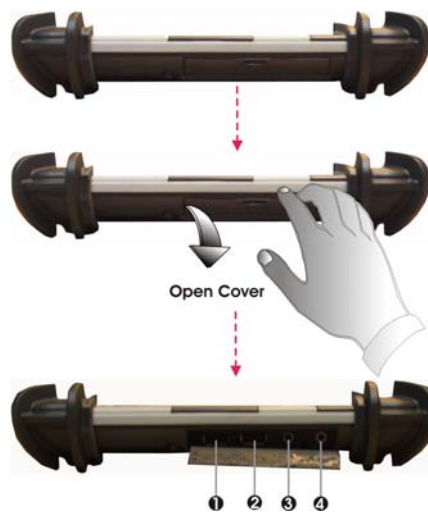

- 2. Headphone port
- 4. USB port

## DASH User Guide

---

- **Microphone port**

Allows you to connect an external microphone for monophonic sound recording directly into your Tablet PC.

- **Headphone Port**

Lets you plug in a stereo headphone, powered speakers, or earphone set for personal listening.

- **USB Ports (x2)**

The Universal Serial Bus (USB) port allows you to connect USB 2.0-compliant devices (for example, printers, scanners and so on) to your Tablet PC.

### 2.1.4. The left side of the DASH

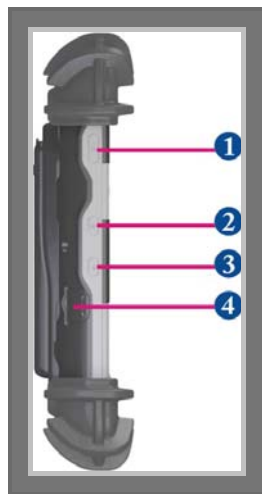

1. Power Button
3. Wi-Fi Button

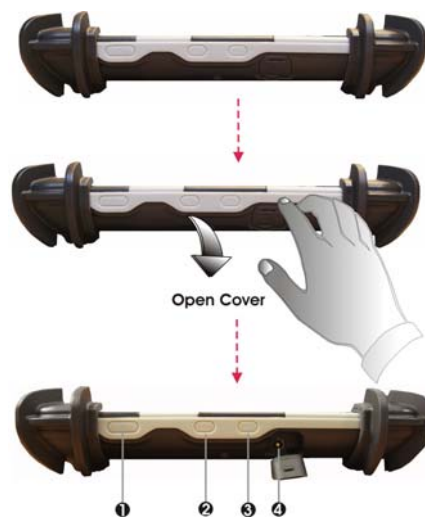

2. Lock Button
4. DC-Jack

- **Power Button**

Switches the computer power on and off, or resumes whenever it is in Suspend mode.

- **Lock Button**

To prevent the screen or function keys have been touched by random, you can press the Lock button to halt the system temporarily; the screen will appear **Lock** message.



To make the system back to work, press the Lock button again to disable the halt function, the screen will appear **Unlock** message.



**Note:** When you press the lock button, please hold for 3 seconds to activate or close this function.

- **Wi-Fi Button**

Press this button to activate or close the Wi-Fi, Bluetooth .

- **DC-Jack**

Lets you connect the AC power adapter in supplying continuous power to your Tablet PC and recharging the battery.

### 2.1.5. The bottom side of the DASH

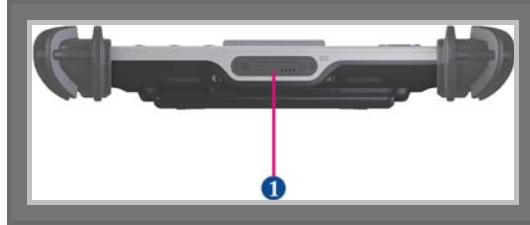

1. Docking Connector

- **Docking Connector**

Lets you connect the system to docking stand to dock the tablet PC when you are at home or office desk.

## 2.2. *Preparing for Installation*

Your DASH is designed and pre-configured for easy setup and use. This section describes the installation steps you should follow to get the system running as quickly as possible.

### 2.2.1. Installing the Rubber Bumpers

To protect the housing case of DASH, install the rubber bumpers.



1. Place the DASH to rear side and install the rubber bumpers to the 4 corners of the system.
2. Screws the rubber bumpers to fix them securely into the system.

### **2.2.2. Removing the Rubber Bumpers**

To remove the rubber bumpers, please place the system to rear side and unscrew the rubber bumpers of the tablet PC.

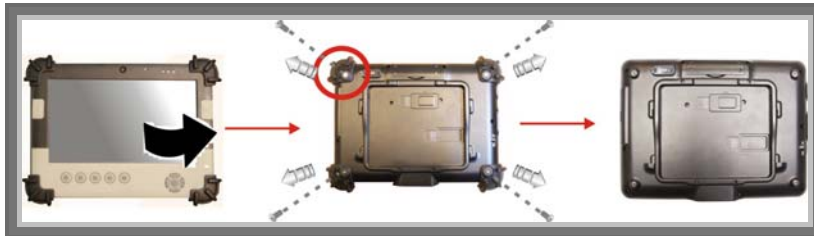

### **2.2.3. Plugging to the DC supply**

The AC adapter provides external power source to your system and charges the internal battery pack at the same time. The AC adapter also has an auto-switching design that can connect to any 100VAC ~ 240VAC power outlets.

To connect the power adapter:

## DASH User Guide

---

1. Plug the AC adapter connector to the DC-Jack socket on the left side of the system.
2. Plug the power cord to the AC adapter.

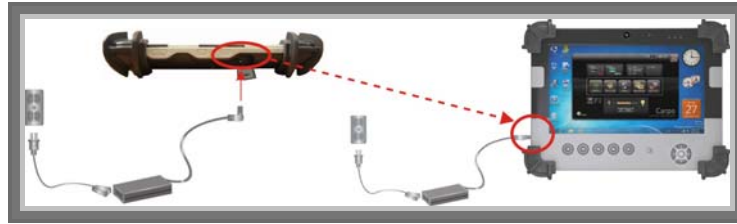

3. Plug the other end of the power cord to a live wall outlet, at the same time, the Power LED at face panel lights up green.



- ***For the power supply of this equipment, an approved power cord has to be used.***
- ***Make sure the socket and any extension cord(s) you use can support the total current load of all the connected devices.***
- ***Remove all power from the device prior to installing or removing any accessories, hardware, or cables***
- ***Before cleaning the system, make sure it is disconnected from***



*any external power supplies (i.e. AC adapter).*

## 2.2.4. Starting Your System

The Power/Resume button is found on the left side of the Tablet PC. Press the Power/Resume button to start your system and check that if the Power LED turns on.

After a few seconds, the system's display will turn on and your system will begin to execute the Power On Self Test or POST to check if all system components are running properly. Any error found during the test will be displayed on the screen.

After the test, the screen will also display a message "**press <F2> to enter SETUP**". You don't need to run this program at the moment as your dealer already made the necessary settings for your computer optimal operation.

After the test has completed, your computer will start to search and boot up the operating system from your hard drive.





### 2.2.5. Connecting the keyboard and mouse

Before setting up the system, please make sure the following items are available.

- Keyboard
- Mouse (for system software installation)

A keyboard is an input device; a mouse is a pointing device. Please connect these two devices as graphics shown below to interact with your system.



## 2.3. **Installing the Drivers**

If you already have an operating system installed into your Tablet PC, it is best to install the needed device drivers for using the built-in devices of your computer. Before installing the drivers, check with your dealer first if they have already installed all the drivers along with the operating system. If not, follow the procedures below:

### **Installing Windows 7 from Optical Disk Drive**

To install Windows 7 directly from your optical disk drive, please go to **Boot** menu of **BIOS** setup menu. Use arrow key to select "DVD/CD-ROM Drive", then use "+" or "-" to move it to the top. Go to **Exit** menu and select "**Exit Saving Changes**". Accordingly, insert the Windows 7 installation DVD into optical disk drive with following the instructions on the screen to finish the installation.

***Driver Installation Note:***

- Please be notified that whenever you install the driver utility, it should be installed the CHIPSET Driver first.***
- Before install Hotkey utility, please install Hotkey driver first.***
- Please install camera utility after install Hotkey utility.***
- Please install Hotkey driver and Utility first then enable wireless devices before installing wireless devices..***

### **Installing the Chipset Driver**

Your system uses the advanced chipset. Installing the driver to enhance the stability and performance.

**Installing Chipset device driver for Window 7 x86**

1. Click the **Start** button, then point to **Run**. The **Run** dialog box appears.

2. Click the **Browse** button and double click the directory as. "**E:\Win7\Chipset\Setup.exe**".
3. When computer appears **User Account Control** window, click "**Yes**" for accessing the computer.
4. Click "**Next**" continuously to install this driver when screen displays this command.
5. Click "**Yes**" to accept the License Agreement.
6. Click "**Next**" to continue the following step.
7. Click "**Next**" to complete it.
8. Tick the option "**Yes, I want to restart this computer now.**", and press "**Finish**" to restart your system.

### Installing the VGA Device Driver

Following is the procedure for installing the Intel Video Accelerator 3D Adapter VGA driver to your computer:

#### ***Installing Intel VGA device driver for Windows 7 x86***

1. Click the **Start** button, then point to **Run**. The **Run** dialog box appears.
  2. Click the **Browse** button and specify the directory as. "**E:\Win7\VGA\Setup.exe**".
  3. When computer appears **User Account Control** window, click "**Yes**" for accessing the computer.
  4. Click "**Next**" to install this driver when screen displays this command.
  5. Click "**Yes**" to accept the License Agreement.
  6. Click "**Next**" to continue the following step.
  7. Click "**Next**" to complete it.
  8. Tick the option "**Yes, I want to restart this computer now.**", and press "**Finish**" to restart your system.
-

## Installing the Audio Device Driver

Your system uses the Realtek Audio codec.

### **Installing Audio device driver for Windows 7 x86**

1. Click the **Start** button, then point to **Run**. The **Run** dialog box appears.
2. Click the **Browse** button and specify the directory as.  
**"E:\Win7\Audio\Setup.exe"**  
where the audio driver is located.
3. When system appears **User Account Control** window, click **"Yes"** for accessing the computer.
4. Click **"Next"** to continue the following steps.
5. Tick the option **"Yes, I want to restart my computer now."**, and press **"Finish"** to restart your system.

## Installing the Touch Panel Driver

Please follow the procedures below for installing the eGalax Touch Panel driver:

### **Installing Touch Panel driver for Windows 7 x86**

1. Click the **Start** button, then point to **Run**. The **Run** dialog box appears.
2. Click the **Browse** button and specify the directory as.  
**"E:\Win7\Touch Panel\setup.exe"**.
3. When system appears **User Account Control** window, click **"Yes"** for accessing the computer.
4. Click **"Next"** continuously to install this driver when screen displays this command.
5. Click **"OK"** to continue the following step.

## DASH User Guide

---

6. Un-tick item “**Support Mutli-Monitor System**”, and press "**Next**" to continue the following step.
7. Click "**Next**" twice.
8. Click “**Yes**” to do 4 point calibration.
9. Follow the screen guide to do 4 point calibration.

### Installing the LAN Device Driver

Please follow the procedures below for installing the ASIX LAN driver:

#### ***Installing LAN driver for Windows 7 x86***

1. Click the **Start** button, then point to **Run**. The **Run** dialog box appears.
2. Click the **Browse** button and specify the directory as.  
"**E:\Win7\LAN\setup.exe**".
3. When system appears **User Account Control** window, click "**Yes**" for accessing the computer.
4. Click "**Finish**" to complete the installation.

### Installing Hotkey Driver and Utility

Please follow the procedures below for installing the Hotkey driver and Utility:

#### ***Installing Hotkey driver for Windows 7 x86***

1. Click the **Start** button, then point to **Run**. The **Run** dialog box appears.
2. Click the **Browse** button and specify the directory as.  
"**E:\Win7\Hotkey\Driver\Setup.exe**"
3. When computer appears **User Account Control** window, click "**Yes**" for processing the further step.
4. Click "**Next**" to continue the following steps.

5. Choose item "**Install this driver software anyway**" continuously.
6. Click "**Finish**" to complete it.

**Installing Hotkey utility for Windows 7 x86**

1. Click the **Start** button, then point to **Run**. The **Run** dialog box appears.
2. Click the **Browse** button and specify the directory as "**E:\Win7\Hotkey\Utility\Setup.exe**"
3. When computer appears **User Account Control** window, click "**Yes**" for accessing the computer.
4. Click "**Next**" to continue the following steps.
5. Click "**Install**" to implement setup program to install the utility.
6. Tick the option "**Yes, restart the computer now.**", and press "**Finish**" to restart your system.

## **Installing Wireless LAN Device Driver**

Please follow the procedures below for installing the AW-NU162H or RTL8188CE-VAU Wireless LAN Adapter driver:

**Installing Wireless LAN device driver for Windows 7 x86**

1. Click the **Start** button, then point to **Run**. The **Run** dialog box appears.
2. Click **Browse** button and specify the directory as "**E:\Win7\WLAN\AW-NU162H\Setup.exe**" or "**E:\Win7\WLAN\RTL8188CE-VAU\Setup.exe**".
3. When computer appears **User Account Control** window, click "**Yes**" for accessing the computer.
4. Click "**Next**" to continue the following steps.
5. Tick the option "**Yes, I want to restart my computer now.**", and press "**Finish**" to restart your system.

### Installing the Bluetooth Driver and Utility

Please follow the procedures below for installing the AzureWave Bluetooth driver:

#### **Installing Bluetooth driver for Windows 7 x86**

1. Click the **Start** button, then point to **Run**. The **Run** dialog box appears.
2. Click the **Browse** button and specify the directory as "**E:\Win7\Bluetooth\Setup.exe**".
3. When screen appears the **User Account Control** window, click "**Yes**" for processing the further step.
4. Click "**Next**" to continue the following steps.
5. Choose "**I accept the terms in the license agreement**" and click "**Next**".
6. Click "**Next**" to continue the following steps.
7. Click "**Install**" to implement setup program to install this driver.
8. Click "**Finish**" to complete it.

### Installing the Camera Utility

Please follow the procedures below for installing the Camera Utility.

#### **Installing Bison Camera Utility for Windows 7 x86**

1. Click the **Start** button, then point to **Run**. The **Run** dialog box appears.
2. Click the **Browse** button and specify the directory as "**E:\Win7\Camera Utility\Bison\setup.exe**".
3. When computer appears **User Account Control** window, click "**Yes**" for accessing the computer.
4. Choose Setup Language and then click "**Next**" to continue the following steps.



5. Click "**Next**" again to continue the following steps.
6. Click "**Finish**" to complete it.

***Installing Camera Utility for Windows 7 x86***

1. Click the **Start** button, then point to **Run**. The **Run** dialog box appears.
2. Click the **Browse** button and specify the directory as "**E:\Win7\Camera Utility\AzureWave\setup.exe**" and "**E:\Win7\Camera Utility\Bison\setup.exe**".
3. When computer appears **User Account Control** window, click "**Yes**" for accessing the computer.
4. Choose Setup Language and then click "**OK**" to continue the following steps.
5. Click "**Next**" twice to continue the following steps.
6. Click "**Install**" to begin the installation.
7. Click "**Finish**" to complete it.

## ***Chapter 3***

### **Using the DASH**

#### **3.1. Introduction**

This chapter describes the basic features and procedures for using the panel PC. It includes the I/O ports connecting and the touch screen operation.

### 3.2. Using the USB Ports

USB (Universal Serial Bus) is a hardware interface that enables you to connect multiple devices (such as printers, mice, keyboards, storage devices, joysticks, digital cameras, and video conference cameras, etc.) to your tablet pc and up to 127 devices can be attached. Besides, USB's hot swap capability allows everything to be plugged in and unplugged without turning the system off.

Microsoft, HP, Compaq, Intel, Agere, NEC and Philip are seven core members of USB-IF to have worked on USB 2.0 standardization. USB 2.0 offers data transfer rate up to 480Mbps (megabits per second) compared to USB 1.1 devices, which transfer at speeds of 12Mbps. So, you could know that USB 2.0 can transfer data between the computer and its peripherals 40 times faster than USB 1.1. However, USB 2.0 is fully backward compatible, you will be able to use a USB 1.1 device in a USB 2.0 compliant system.

1. Connect the external device to the system.
2. The USB ports support hot plug-in connections. Install the device driver before using the device.

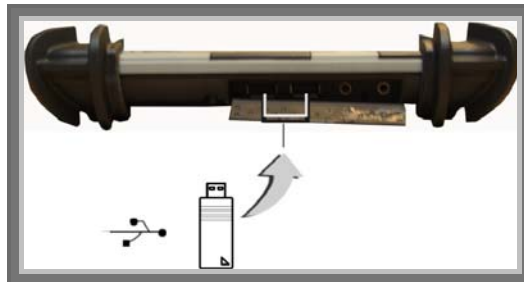

### **3.3. Using the External Audio System**

At the right side of your Tablet PC, you will find the built-in audio ports for connecting Microphone jacks, earphone or powered speaker.

To connect to an audio jack:

1. Locate the audio ports (Microphone and Headphone) that you want to use to the target device.
2. Plug the jack into the port on the right side of the system.



### **3.4. Installing the Battery**

DASH provides optional external battery to extend the power of your system.

For installing the battery pack, please follow the steps below:

1. Turn off the system.
2. Align the hook wall at the rear side, then place and screw it fixedly.

## DASH User Guide

---

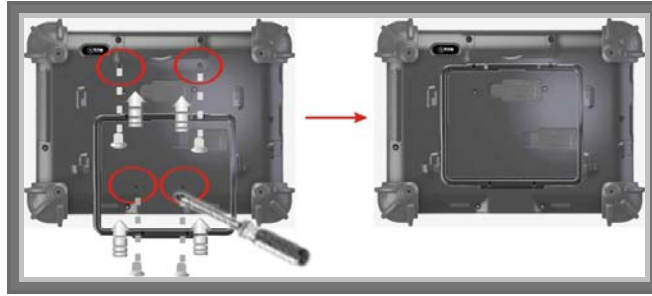

3. Remove the cover of the external battery connector (as marked **1** below) and place it on the lower position (as marked **2** below).

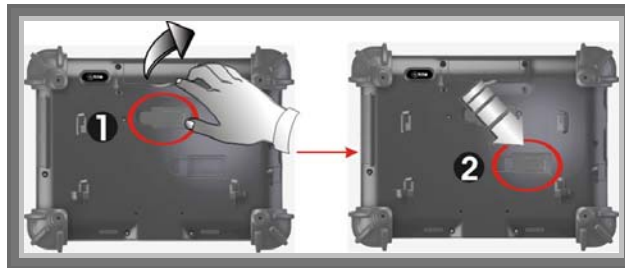

4. Snap the battery pack into the external battery connector and hook into the hook wall securely.



For removing the external battery, repeat the above steps in reverse order

to remove the battery.

## ***Chapter 4***

### **The BIOS Setup Program**

This system comes with a chip from Phoenix BIOS that contains the ROM Setup information for your system. (This chip serves as an interface between the processor and the rest of the system components.) This section explains the information contained in the Setup program and tells you how to modify the settings according to your system configuration.

The Setup utility program allows updates to the main board configuration settings. The BIOS setup values will be saved in the CMOS. It is executed when you change the system configuration, you change the system backup battery, or the system detects a configuration error and asks you to run the Setup program. You must have connected a USB type of keyboard, and Use the arrow keys to select, and press Enter to run the selected program.

#### **Function Key**

## DASH User Guide

---

Please check the following table for the function description of each direction key.

Function Key (s)	Function Description
←	Moves cursor left to select Screens
↑ / ↓	Moves cursor up or down to select items
+ / -	To change option for the selected items
<Tab>	To bring up the selected screen
<F1>	To display the General Help screen
<F10>	To save changes and exit the BIOS SETUP UTILITY
<ESC>	To jump to the Exit Screen or exit the current screen

### ***4.1. Main Screen Setup Utility***

When you enter the BIOS SETUP UTILITY, the Main screen will appear and display the system overview.

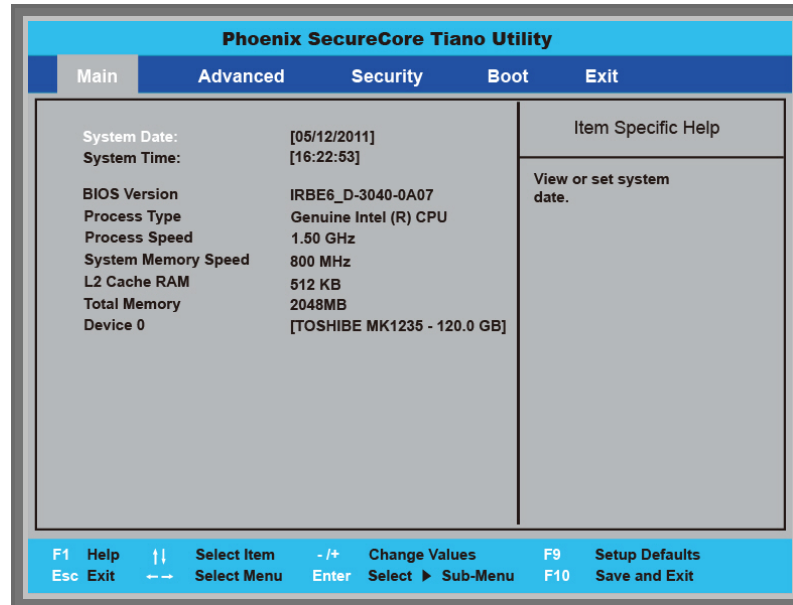

The Standard CMOS Setup screen is displayed above. Each feature may have one or more option settings. Use the arrow keys to highlight the feature you want to change and then use “↑” or “↓” to select the value you want for that feature.

**NOTE:** The system BIOS automatically detects AMIBIOS, Processor, memory size, thus no changes are necessary.

***NOTE: The system BIOS automatically detects Phoenix, Processor, memory size, thus no changes are necessary.***

- **System Date**

To set the date, highlight the Date field and then press +/- keys to set the current date. Follow the month, day and year format.

- **System Time**  
To set the time, highlight the Time field and then press +/- keys to set the current time. Follow the hour, minute, and second format.
- **BIOS Version**  
The system will automatically displays the information of BIOS version.
- **Processor Type**  
The system will automatically displays the information of Processor Type.
- **Processor Speed**  
The system will automatically displays the information of Processor Speed.
- **System Memory Speed**  
The system will automatically displays the information of System Memory Speed.
- **L2 Cache RAM**  
The system will automatically displays the information of L2 Cache RAM.
- **Total Memory**  
The system will automatically displays the information of Total Memory.
- **Device 0**  
The system will automatically displays the information of Device 0.

## ***4.2. Advanced BIOS Features***

For Advanced Settings, the BIOS will automatically display the Platform information and let you define the configuration when system booting.

In this section, you may set the configurations for the following items: Quick boot, UEFI boot, Legacy boot, and Boot Priority.



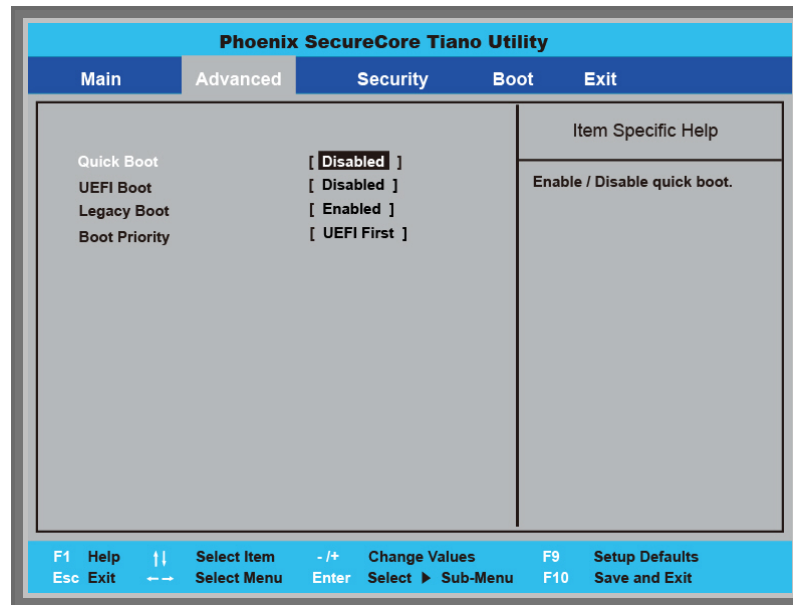

- **Quick Boot**  
Lets you activate or close the Quick boot function by selecting Enabled or Disabled option.
- **UEFI Boot**  
Lets you activate or close the UEFI boot function by selecting Enabled or Disabled option.
- **Legacy Boot**  
Lets you activate or close the Legacy boot function by selecting Enabled or Disabled option.
- **Boot Priority**  
Lets you set the boot priority from UEFI boot or HDD boot.

## 4.3. Security Chip Configuration

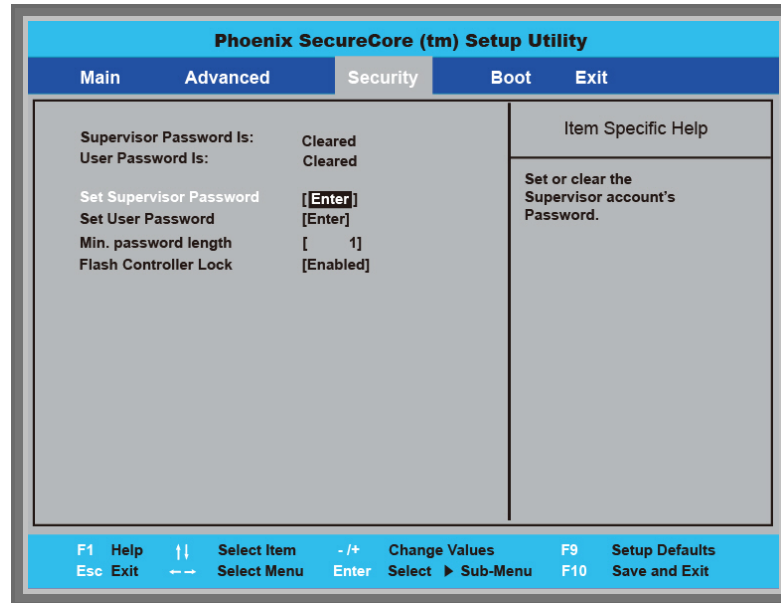

- **Supervisor Password is:**  
This option displays the status of Supervisor Password. If the password is entered, it will display “Set” information, or it will display “Cleared” information when there is no password setting.
- **User Password is**  
This option displays the status of User Password. If the password is entered, it will display “Set” information, or it will display “Cleared” information when there is no password setting.
- **Set Supervisor Password**  
This field let you set or clear the Supervisor account's password.
- **Set User Password**  
This field let you set or clear the User account's password.

- **Min password length**  
Lets you set the minimum number of characters for password. The value is from 1 to 20.
- **Flash Controller Lock**  
Lets you lock or unlock flash controllers by selecting “Enabled” or “Disabled” option.

## 4.4. **Boot Management Setup**

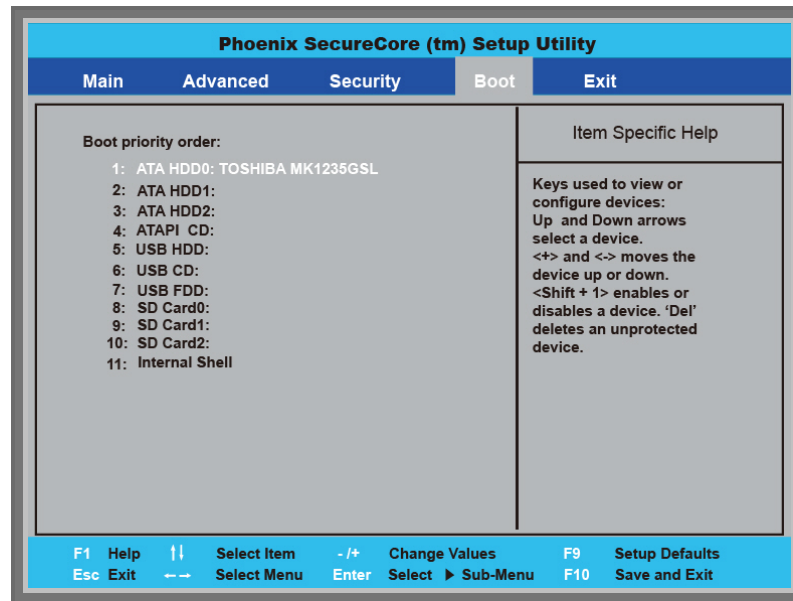

This page allows you to set the search drive sequence where the system will try to boot up first.

To select the boot device, you can use the up or down arrow key, then press <+> to move up the device in the list or press <-> to move down the device

in the list. To exit from this menu, press <Esc>.

### 4.5. Exit Control

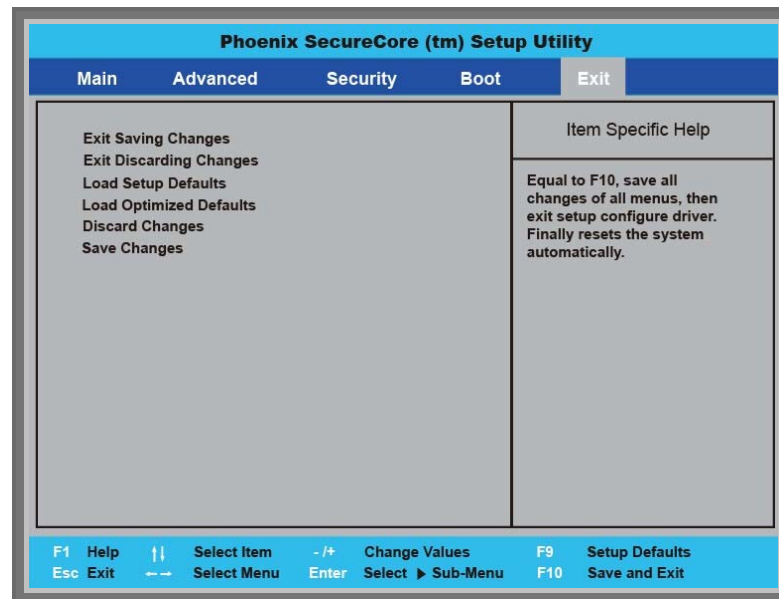

- **Exit Saving Changes**  
When you select this option, it will pop-out the following message, "Save configuration changes and exit setup?" Select [OK] to save the changes and exit the BIOS SETUP UTILITY.
- **Exit Discarding Changes**  
When you select this option, it will pop-out the following message, "Discard changes and exit setup?". Select [OK] to exit the BIOS SETUP UTILITY without saving any changes.
- **Load Setup Defaults**  
When you select this option, it will pop-out the following message,

“Load optimal defaults?” Select [OK] to load the default values for all the setup configurations.

- **Load Optimized Defaults**  
When you select this option, it will pop-out the following message, “Load optimal defaults?” Select [OK] to load the default values for all the setup configurations.
- **Discard Changes**  
When you select this option, it will pop-out the following message, “Discard changes?” Select [OK] to discard all changes.
- **Save Changes**  
When you select this option, it will pop-out the following message, “Save changes?” Select [OK] to save all changes.

## ***Chapter 5***

# User Interface for DASH

### **5.1. Introduction**

This user interface provides specific mobile utility to let you easily setup some helpful functions and aware the system status directly.

This utility also let you adjust some function to fit the requirements, such as brightness and volume adjustment, webcam launch, screen orientation and monitor switching.

Furthermore, it also provides system information for your reference, such as battery status, RF setting with its signal strength, firmware (BIOS & EC) version information. Besides these features, you can press the soft button to hibernate this device.

### **5.2. About the User Interface**

#### **5.2.1 Enable or disable the User Interface**

To display the User Interface, please press the Fn button or point the Hot key Utility on the screen.

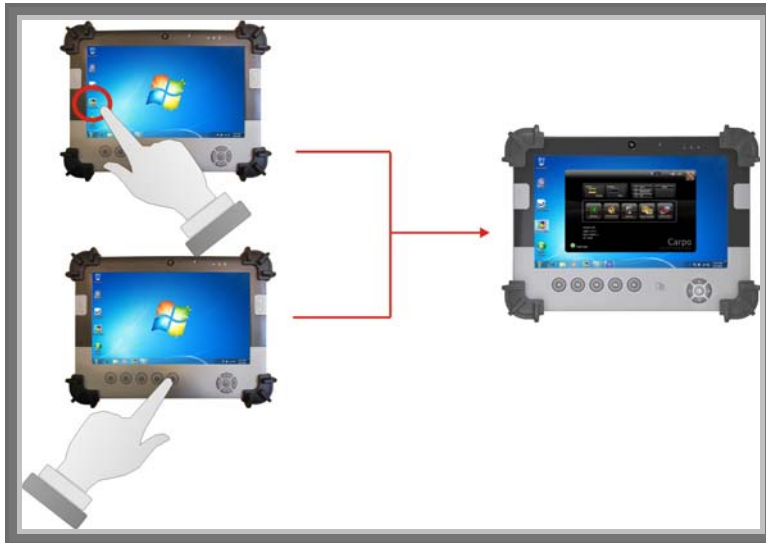

To close the User Interface function, please press the  button on the top right corner on this User Interface for disabling this utility from the screen.

If there is no action took for this utility in 5 seconds, the UI screen will close automatically.

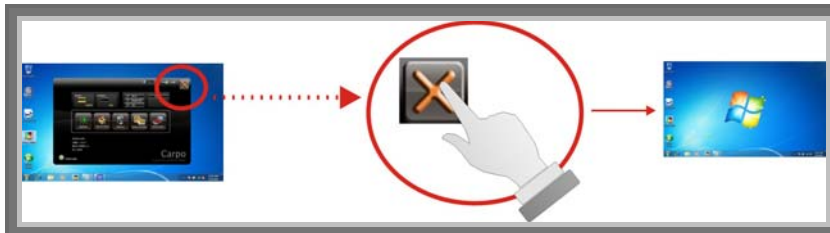

## 5.2.2 Hibernate this System

If you want to hibernate this system, please click  button for entering into S4 mode.



## 5.2.3 System Status Information

This utility shows you the battery capacity status, RF status with its signal strength and system information, and provides the control panel for the function setting.



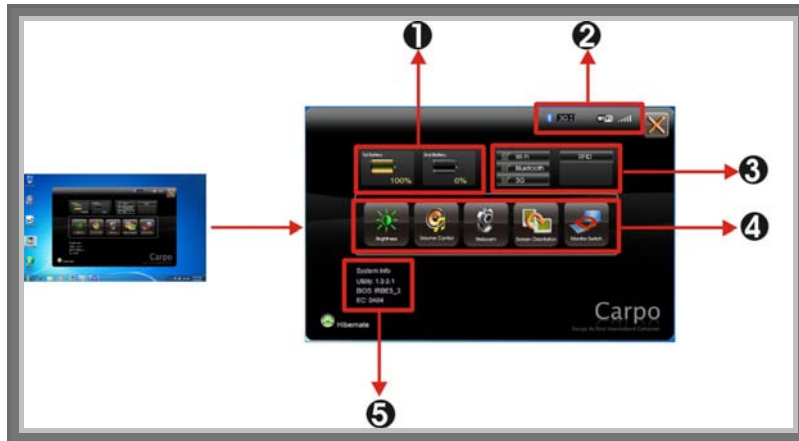

**For battery capacity status:**

The DASH is equipped with one internal battery and one optional battery.

The battery capacity status shown below advises you, that only one internal battery is embedded with the system with fully charged, and there is no optional battery installed in the system.



If the system installs both the 1st internal battery and 2nd optional battery, the graphics shown below indicates the charging status.

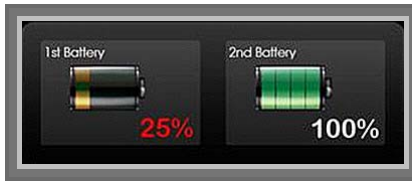

If 1st battery capacity is down to 15%, the system will display the following warning message for 5 seconds

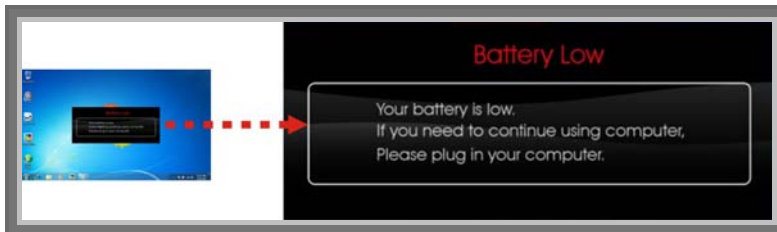

### For System Information:

The system information shown on the left advises you the utility version, BIOS and EC version and you can use them for customer service.

## 5.3. Using the Application

Your DASH has numbers of applications on the control panel for executing specific command. It provides you to adjust brightness, volume, launch webcam, make screen orientation and switch monitor.





### 5.3.1 Brightness Control

For brightness adjustment, press the **Brightness**  command.



When you press it, the brightness control panel is appeared as follows:



- You can click  or  to reduce or increase the brightness.
- Also, you can slide the scale bar  to set the brightness.
- Since the system supports the light sensor, if you tick the brightness Auto adjustment , the screen brightness will automatically adjust according to the operating environment.





### 5.3.2 Volume Control

For Volume adjustment, press the **Volume**  command.



When you press it, the Volume control panel is appeared as follows:



- You can click  or  to reduce or increase the audio volume incrementally.
- Also, you can slide the scale bar  to set the audio volume.
- You can tick the **Mute**  to make the system voiceless.

### 5.3.3 Webcam Launch

For Webcam Launch, press the **Webcam**  command to appear the Webcam utility for your application.







### 5.3.4 Monitor Switch

For Monitor switch, press the Monitor Switch  to pop-up the selection bar for choosing the display mode within following four options.

## DASH User Guide

---



- You can click **Computer only**  to display the DASH screen only.
- You can click **Duplicate**  to display the same contents both on the DASH screen and external display device. The resolution on these two display modes are same, it is not available to adjust the resolution on the external display mode.
- You can click **Extend**  to display the different contents on the DASH screen and external display device. You only can adjust the resolution on the external display device.
- You can click **Projector only**  to display on external projector only.

## ***Chapter 6***

### **Maintenance**

Your DASH needs occasional cleaning to prolong their life. Please read this section carefully to ensure proper care of DASH. When it is necessary to clean it, use a soft, lint-free cloth, slightly dampened with a mild detergent solution or use the contents of any commercially available computer cleaning kit.

Never use petroleum-based solvents, or harsh detergents to clean the system. Also never spray any liquids directly on the computer case or screen. If the display screen has become smeared or dusty, clean the screen by first applying a mild glass cleaner to a soft, clean, lint-free cloth, and gently wipe the glass. Never apply liquids directly on the screen surface. Moreover, do not use paper towels to clean the display screen. Paper can scratch the display screen matte.

#### ***6.1. Maintaining the Battery***

- Do not expose heat or attempt to disassemble the battery, and do not place the battery in water or in a fire.
- Do not subject the battery to strong impact, such as a blow from a hammer, or stepping on or dropping it.
- Do not puncture or disassemble the battery.
- Do not attempt to open or service the battery.
- Replace only with batteries designed specifically for this product.
- Keep the battery out of reach of children.

- Dispose of used batteries according to local regulations.

### **6.2. *Maintaining the LCD Display***

- Do not scratch the surface of the screen with any hard objects.
- Do not spray liquid directly on the screen or allow excess liquid to drip down inside the device.
- Do not place anything, such as food and drink, on the screen at any time to prevent damage to the screen.
- Clean the LCD display only with a soft cloth dampened with denatured alcohol or a proprietary LCD screen cleaner.

### **6.3. *Cleaning the DASH***

- Turn off the DASH and unplug the power cord.
- Wipe the screen and exterior with a soft, damp cloth moistened only with water. Do not use liquid or aerosol cleaners on the screen, as these will discolor the finish and damage the screen.