



**PORTMAN**

OPERATION MANUAL

**GPS&GPRS CAR ALARM GT3200ST**

## I. INTRODUCTION

GPS GPRS Tracking and Alarm System utilize the GPS and car alarm functions in one unit. You can monitor the vehicle location and control the car alarm remotely. In addition, the unit will send event report if any trigger occurs. It has built-in 8 outputs and 9 inputs to perform essential alarm functions.

### 1.1 Report structure

The standard report sent by the unit includes the information: (1) unit's ID, (2) status, (3) time, (4)GPS's latitude and longitude, (5)speed, (6) direction, (7)temperature, (8)device's status, (9)event number, and (10) report configuration parameters.

- (1) Unit's ID: each device has its own unique ID and must be registered in the server in order to perform monitoring or controlling.
- (2) Status: 'A' mean the number of satellite is more than 4 or equal to 4; 'B' mean the number of satellite is equal to 3, 'L' mean the number of satellite is less than 3.
- (3) Time: report time in Greenwich Mean time zone.
- (4) GPS's latitude and longitude.
- (5) Speed: in km/H
- (6) Direction: in degree to the North.
- (7) Temperature: in Celsius. If the temperature is not connected, 'NA' will be shown in this field.
- (8) Device's status: there are 32 states to represent the I/O and working modes for the both the device and the build in alarm.
- (9) Event number: all the generated reports will include a unique event number to indicate why it has been sent.
- (10)Report configuration parameters: user can remotely change the report configuration, and the configuration parameters will be shown in this field.

### 1.2 Report Setup

GT3200ST must be initialized by PC setup program in order to make communication with the remote server /call center. There are seven main sections that allow users to program the device, (1) User detail (Device ID, server IP, and port, SMS number, GPRS APN...) (2) In-built Geofence definition (up to 5 circular, 5 rectangular and 20 point Geofence shapes can be set in the device) (3) Local Report setting (Time, Distance, Intelligent mode, Temperature, Low battery, Course change...) (4) Roam Report setting (Time, Distance, Intelligent mode, Temperature, Low battery, Course change...) (5) ALARM report (to enable or disable the event generated by the inputs or build in ALARM, e.g. ACC, DOOR, ALARM...) (6)Roam alarm setting (Sleep mode, internal alarm report, external alarm report..) (7) Roam setting (Roaming GPRS mode select, prefer operators setting, compress setting...) Those data is saved in device's EEPROM and will not be lost even if the power is failure.

Note that the device ID, GPRS APN name, GPRS login name and password need to be set in initial PC setup in order to make the connection to the server. All the reports configuration or Geofence setup can be changed at anytime via over the air commands.

The automatic reporting mode can be categorized as 'time' report, 'distance' report, or 'time & velocity' report. User can choose the reporting mode and related parameters via the PC setup program or the remote sever.

The event trigger report is also configurable. User can turn on or off any event generated report from the PC setup program or via the air command. The event triggered report include (1) In-vehicle Door close/open (2) In-vehicle ignition on/off (3) Temperature range in/out the preset range (4) In-vehicle shock sensor trigger. The build in alarm (optional) trigger reports are also configurable and can be set from PC setup program or air command.

The server can not only configure the device just like the PC setup program does, but it also can send the command to control the device. The server can control both the device and the build in alarm.

### 1.3 Geofence function

The device has built-in 30 Geofence sets (1 immediate geofence, 4 circular, 5 rectangular and 20 point), it will send the report to the server if the Geofence event is triggered. User can setup the Geofence area from the PC setup program or sending the define.

A unique immediate Geofence function:

‘Immediate-Geofence function’ is a circular type Geofence which can be activated or deactivated from a single button. When activated, the system will record the current position and use the pre-defined radius as a circular Geofence to guard the vehicle. If the vehicle moves out of the preset Geofence zone, a report will be generated to the server. User can deactivate the self-Geofence at any time by pressing the button again. If the GPS cannot be located when the Immediate Geofence function is been executed, GT3200ST will used the last known position as the origin of the circular Geofence zone to perform the protection.

### 1.4 Store and forward ability

When there is no GPRS service or the server close. The unit will send short message to the server if defined SMS number. All the stored report will be forward to the server when GPRS connection is completed next time.

### 1.5 TCP and UDP socket support

GT3200ST supports both UDP and TCP socket communication. The server IP, port number and socket type can be selected from the PC-setup program or remote server command. In addition, the connection can be swap over to any server IP or port (either UDP or TCP) via the air command.

### 1.6 The server can send the command to control the device and the build in alarm.

Command for in-vehicle control:

We design 7 commands which can be integrated into the server, so that the users can control their vehicles.

Those commands are: (1) Door lock, (2) Door unlock, (3) Arming, (4) Panic, (5) Enable anti-car jacking, (6) Emergency release, (7) Trunk output

Notes:

1. Arming (this command is valid only if when ACC is off): If ACC Off, Server send arming command. The door will lock and the Engine will be Disable starter (if the starter cut relay connected), after the unit received the command.
2. Panic: (can be performed at any time) If Server send panic command, the horn will sound and parking lights will flash for 30 seconds after the unit received the command.
3. Enable anti-car jacking: (can be performed at any time) If Server send anti-car jacking command, the system will enter anti-carjacking mode after the unit received the command. Enter the anti-carjacking

mode, the first 30 seconds countdown, The horn will sound once and parking lights will flash once every 10 seconds, after 30 seconds, horn will sound once and parking lights will flash once every 5 seconds, 30 seconds later, horn will sound and parking lights will flash once every 1 second. 60 seconds later, engine will not be able to start again (if starter cut relay connected).

4. Emergency release: (can be performed at any time) If Server send Emergency release command while at Arming mode, panic mode, anti-car jacking mode. Then system will exit 'Arming' 'Anti-carjacking' 'Panic' mode. The 'Arming', 'parking light' and 'horn' outputs will back to normal (Disarm) status.

### 1.7 IRKP-20

External wireless 20- key keypad to used for calling

### 1.8 Valet switch operation

User can use the supplied Valet switch to perform 7 essential tasks, including (1) sending help report (2) activate or deactivate Immediate Geofence (3) Activate panic mode (4) sending 'Duty on' or 'Duty off' report to the server (5) Emergency release to exit 'ARM', 'Anti-carjacking' or 'Panic' modes (6) code learning for build in alarm, (7) set valet mode for build in alarm

### 1.9 handset operation (Optional)

User can use the supplied handset (HS200) to perform the function such as send/receive SMS, phone in/out, main unit status display etc. For detail, refer to the user manual of HS200.

### 1.10 History report

Flash memory for recording reports up to 6000 reports. It can be read out from the PC setup program via serial port.

### 1.11 Internal battery

The system has a built-in rechargeable battery (4.8V 80mA/H) for emergency use. The system will send a power cut report when all the external power are disconnected.

### 1.12 LED indication

Three LED indicate the status of the POWER, GPRS signal and GPS signal.

### 1.13 Keep alive procedure

Keep alive procedure (in order keep connection in GPRS network, the unit can be set to send short keep alive report to the server in order to prevent the disconnection from the mobile service provider)

### 1.14 Sleep Mode

The Sleep Mode:

For long periods of inactivity user have the options to set the unit in sleep mode this will enable the unit to save electric power.

GT3200ST Can go to sleep mode when ACC goes off, Shock-sensor not be trigger for 5minuts and this feature is configurable. "GPS" can be power off. User can setup the automatically wakeup time during the sleep mode to ensure the device is working. The system can send out a diagnostic report to the server after waking up.

During the sleep mode, if any of the inputs are triggered, the system will wake up and send relevant reports to the server. The input triggers for waking the device up are selectable. When ACC is on, the system will back to working mode and stay connected to the TCP/UDP server in GPRS network.

### 1.15 2-STAGE SHOCK SENSOR (Optional)

If car is lightly vibrated, siren will sound five times and parking light will flash five times to warn. If car receives a heavy shock, siren will sound and parking light will flash for 30 seconds.

### 1.16 Monitor mode

There is two way enter the monitor mode: 1. Password way, you sent the password of preset in PC-setup by SMS, if the password is right, then you will receive the PASS message, and system will enter the monitor mode; 2. Valet switch way, if you press Valet switch once within one second anytime, then system will enter the monitor mode. After the system enter the monitor mode, unit will auto answer the phone in the following 10 minutes. The system will auto exit monitor mode after 10 minutes.

## **II. BASIC FUNCTIONS**



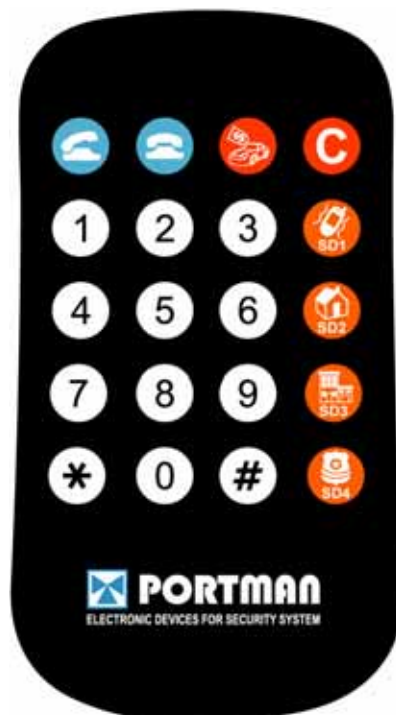

FUNCTIONS	APPLICATIONS
GPS	GPS receiver will output a complete position, velocity, and time (PVT) solution in the NMEA Version 3.0 protocol
GPRS, SMS	GPRS use standard TCP or UDP communicate protocol. If the GPRS service is failed, the SMS mode will be turned on for emergency use.
9 input	In-vehicle Door - In-vehicle door + In-vehicle ACC Temperature sensor /AD port (Optional) Shock-sensor port Crash sensor port Valet switch port Wireless 20- key keypad RF-receive port (Optional)
8 output	1. Parking light 2. Door Lock 3. Door Unlock 4. ARM 5. Horn 6. Audio port (microphone and hand free) 7. Handset port (Optional) 8. Trunk output
Valet Switch	(1) Send help report and enter the monitor mode (2) activate or deactivate Immediate Geofence (3) Activate panic mode (4) sending 'Duty on' or 'Duty off' report to the server (5) Emergency release to exit 'ARM', 'Anti-carjacking' or 'Panic' modes (6) code learning for build in alarm, (7) set valet mode for build in alarm
wireless keypad	(1) "II" Hang up a phone (2) "I" Answer a phone or redial a phone

Handset (Optional)	<ol style="list-style-type: none"> <li>1. SMS send/receive</li> <li>2. phone call</li> <li>3. main unit information display</li> <li>4. Immediate Geofence activate/deactivate</li> <li>5. Help report sending</li> <li>6. Duty on/off report</li> <li>7. Emergency release</li> </ol>
PC-setup	<p>Initialize the unit and program the device, including Network APN, server IP address, user message, report control, and Geogence setting, etc ...</p> <p>Note that Network APN and server IP details must be set before the installation.</p>
Build in ALARM (Optional)	If build in alarm is installed, the system will gather all the alarm information for the remote monitoring. The server also has the ability to control the build in alarm.
Standard Report	<p>Automatic report for AVL tracking purpose:</p> <ul style="list-style-type: none"> <li>Fixed time report</li> <li>Fixed distance report</li> <li>Intelligent report (combine time and distance)</li> <li>Keep alive report</li> </ul>
Event Report	<ul style="list-style-type: none"> <li>Temperature report</li> <li>Speeding report</li> <li>Low battery report</li> <li>Geofence trigger report</li> <li>Wake up report</li> <li>ALARM trigger report, e.g. PANIC mode, ARM, ACC inputs, etc ...</li> </ul>
History data store	6000 report can be saved in unit, and read from server and pc-setup

### III. IRKP-20 CONTROL



Anytime the unit can call out and pick up phone call as well. to dial the number directly through the keypad.

- a. After dialing the telephone number, press button  once or button " " of two button valet switch once dial out. If the dialing is successful, HAND FREE will ring, each time the button is pressed, the HANDFREE will chirp once as indication. Once the dialogist picks up the phone, the user can start talk with that person. Press button  once or button " " of two button valet switch once will hang up the phone call.
- b. If phone call comes in, HANDFREE will ring. User can either press button  once or button " " of two button valet switch once to pick up the phone or press button  once or button " " of two button valet switch once to hang up.
- c. On the above operation, the interval between pressing each two buttons must be finished within 5 seconds, otherwise the unit will exit current mode automatically. If phone number is entered incorrect, user can press button  once clear all the input, and then user needs to restart entering.

#### IV. Valet switch OPERATION

##### (1) Sending help report

Press the button once, The LED will flash once and a help report will be generated and the system will enter the monitor mode

##### (2) Activate or deactivate Immediate Geofence

Press the button and release it when the LED flashes once. After releasing it, the LED will stay continuously on to indicate the 'Immediate Geofence' is on. To deactivate: Press the button (the LED will be temporarily off), and release it when the LED flashes once. After releasing it, the LED will then stay continuously off. A report will be sent out if the vehicle goes out/in to the Geofence zone.

##### (3) Activate/Deactivate panic mode and send 'panic' report

Press the button (the LED will be temporarily stay off) and release it when the LED flashes twice. After releasing it, the panic mode is been triggered and the panic report is sent out. In panic mode, the horn will sound and the parking light will flash. To exit panic mode: press the button (the LED will be temporarily stay off), and release it when the LED flashes twice. After releasing it, the horn and parking light will stop.

##### (4) 'Duty on' or 'Duty off' reports / 'Status on' Status off' reports

Press the button (the LED will be temporarily stay off) and release it when the LED flashes 3 times. After releasing it, a 'Duty on' report will be sent out. To deactivate: Press the button (the LED will be temporarily stay off) and release it when the LED flashes 3 times. After releasing it, a 'Duty off' report will be sent out.

##### (5) Emergency release to exit 'ARM', 'Anti-carjacking' or 'Panic' modes.

ACC ON, press the button (the LED will be temporarily stay off) and release it when the LED flashes 5 times. After releasing it, 'ARM', 'parking light', and 'horn' outputs will back to normal (Disarm) status.

(6) Enter code learn mode or exit.

ACC on and then press the button (the LED will be temporarily stay off) and release it when the LED flashes 4 times. After releasing it, the horn will chirp three times to indicate system entered code learn mode; Turn ACC off to exit code learn mode and there is no sound for indication.

(7) Enter valet mode or exit.

ACC on and then press the button (the LED will be temporarily stay off) and release it when the LED flashes 8 times. After releasing it, the horn will chirp two times to indicate system entered or exit valet mode.

## V. STATUS INDICATOR

### System LED:

RED: Power indicator. When the unit power on, the led will light all the time. When power cut off the unit works with internal battery, the led will flash until all the report is sent to server.

YELLOW: GSM/GPRS indicator. Yellow LED will flash when the device is connected to the server with valid GPRS connection. It will stay continuously on when it is in GSM mode. It will stay off if there is no GSM reception.

Green: GPS indicator. This LED will be ON when the unit received a valid GPS data.

Note that the Green LED indication will not be valid until the system goes to the working mode, normally 30 seconds after power on.

## VI. BUILD IN ALARM OPERATION (Optional)

User can use the BUILD IN ALARM to perform all the car alarm function. For detail, refer to the BUILD IN ALARM OPERATION manual.

## VII. PC SETUP AND SYSTEM INITIATION

PC setup Procedure:

- (1.) Connect the 4pin to RS232 cable to the DB9 port.
- (2.) Open the PC setup program.
- (3.) Select the correct COM port for communication.
- (4.) Click “ok” to start the program
- (5.) Power on the device or press the reset button until red LED turn off.

Note that, if the connection fails, please check the cable connection is secured correctly. Press the reset button for a longer time, e.g. another 3 seconds.

### A. LOGIN dialog window

Select the correct COM port number, then “reset” the unit by pressing the reset button, and next click “OK”.

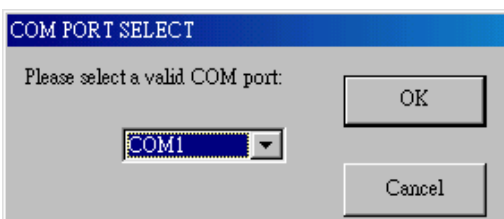

Note that: it is necessary to power on and reset the device soon after click the “ok” button.

PC setup program will detect the hardware for 60 seconds. If no hardware is detected, it will exit.

During the opening up screen shown as below, user can press “Esc” key to terminate the program.



## B. Version No. Checking

The below interface will last until correct UNIT Version No. is checked. (You should run this program before turn on power of UNIT)



## C. MAIN INTERFACE

### 1. [User detail:]

GT3200

User Detail | Geofence | Local Report | Roam Report | Alarm Setup | Roam Alarm | Roam Setting

Version: GT3200\_GT3200.SIM340.A\_PTM\_5.1.3\_1.81 Device ID: [ ]

SIM PIN: [ ] IMEI: [ ] Device Password: [ ]

GPRS login information:

APN: [ ]

User Name: [ ]

Password: [ ]

Server information:

TCP IP Address: [ ] Port: [ ]

UDP IP Address: [ ] Port: [ ]

Local GPRS enable  Roam GPRS enable

Local SMS enable  Roam SMS enable

SMS

Primary SMS number: [ ]

Secondary SMS number1: [ ]

Secondary SMS number2: [ ]

Secondary SMS number3: [ ]

GPS Data valid condition

AUTO GPS fix

3D GPS fix only

2D and 3D GPS fix display

Export History Record

To Text

To Excel

Export

Initialize | Request All | Request | Apply | Apply All | Load... | Save... | Exit

SIM PIN:

If the SIM card is password protected, user can input the “SIM PIN” window to set password of SIM Card.

IMEI

IMEI: Any operate with ‘request or request all’ t after GPRS power on, the module series number will display automatically, otherwise it displayed with space.

Device ID:

Device Password:

Set UNIT ID and UNIT password of for the device.

GPRS login information:

APN:

User Name:

Password:

Set Access Point Name (APN), User Name, Password. The maximum length of the APN, User name and Password is 49 characters.

Server information:

TCP IP Address:  Port:

UDP IP Address:  Port:

TCP/UDP address and Port number of the remote server being set, UNIT will send report to these address. Note that only one TCP or UDP server will be used at the same time.

Local GPRS enable  Roam GPRS enable

Local SMS enable  Roam SMS enable

To select enable or disable local GPRS/SMS or Roam GPRS/SMS

Set the SMS Number of the server. The unit will send reports to the server if GPRS connection is failed.

AUTO GPS fix: the report will be display “A” in the report and indicate that if the number of satellite is more than 3 or equal to 3. If the number of satellite is less than 3, then it will show “L” in GPS fix section.

3D GPS fix only: the report will be display “A” in the report and indicate that if the number of satellite is more than 4 or equal to 4. If the number of satellite is less than 4, then it will show “L” in GPS fix section.

2D and 3D GPS fix display: the report will be display “A” in the report and indicate that if the number of satellite is more than 4 or equal to 4.

If the number of satellite is equal to 3, then the report will show “B” in GPS fix section.

If the number of satellite is less than 3, then the report will show “L” in GPS fix section.

UNIT can save 6000 reports (6000-1) recently; Click ‘Export’ button can export them with Excel or Text format.

“Initialize ” button: clear all data in UNIT.

Request All: read out the whole existing setting from GT3200ST.

Request: read out the setting in the current page.

Apply: transfer the setting to GT3200ST in the current pages.

Apply All: transfer the whole setting to GT3200ST.

Load: load the saved configuration files.

Save: save the current configuration setting to a file.

“Exit ” button: exit PC-Setup to main program.

Note that Device ID , GPRS Login and server IP/Port information need to be input correctly in order to make the connection. If the report sending using GPRS connection fails, the report will be sent to the ‘primary’ SMS number first. The report will be resent, when the GPRS connection becomes available.

## 2. [Geofence:]

GT3200

User Detail | **Geofence** | Local Report | Roam Report | Alarm Setup | Roam Alarm | Roam Setting

Circular Type Origin Format Example : N2446.5321E12120.4231

No.	Origin	Radius	Km	Send	Local	Ignore
1.	<input type="text"/>	<input type="text"/>	<input type="text"/>	<input type="radio"/>	<input type="radio"/>	<input checked="" type="radio"/>
2.	<input type="text"/>	<input type="text"/>	<input type="text"/>	<input type="radio"/>	<input type="radio"/>	<input checked="" type="radio"/>
3.	<input type="text"/>	<input type="text"/>	<input type="text"/>	<input type="radio"/>	<input type="radio"/>	<input checked="" type="radio"/>
4.	<input type="text"/>	<input type="text"/>	<input type="text"/>	<input type="radio"/>	<input type="radio"/>	<input checked="" type="radio"/>
Self geofence:		<input type="text"/>	<input type="text"/>	<input type="radio"/>	<input type="radio"/>	<input checked="" type="radio"/>

Rectangular Type Format Example : N2446.5321E12120.4231

No.	Upright point	Downleft point	Send	Local	Ignore
1.	<input type="text"/>	<input type="text"/>	<input type="radio"/>	<input type="radio"/>	<input checked="" type="radio"/>
2.	<input type="text"/>	<input type="text"/>	<input type="radio"/>	<input type="radio"/>	<input checked="" type="radio"/>
3.	<input type="text"/>	<input type="text"/>	<input type="radio"/>	<input type="radio"/>	<input checked="" type="radio"/>
4.	<input type="text"/>	<input type="text"/>	<input type="radio"/>	<input type="radio"/>	<input checked="" type="radio"/>
5.	<input type="text"/>	<input type="text"/>	<input type="radio"/>	<input type="radio"/>	<input checked="" type="radio"/>

Point Type, Format Example : N2446.5321E12120.4231

No.	Point	Send	Local	Ignore
1.	<input type="text"/>	<input type="radio"/>	<input type="radio"/>	<input checked="" type="radio"/>
2.	<input type="text"/>	<input type="radio"/>	<input type="radio"/>	<input checked="" type="radio"/>
3.	<input type="text"/>	<input type="radio"/>	<input type="radio"/>	<input checked="" type="radio"/>
4.	<input type="text"/>	<input type="radio"/>	<input type="radio"/>	<input checked="" type="radio"/>
5.	<input type="text"/>	<input type="radio"/>	<input type="radio"/>	<input checked="" type="radio"/>
6.	<input type="text"/>	<input type="radio"/>	<input type="radio"/>	<input checked="" type="radio"/>
7.	<input type="text"/>	<input type="radio"/>	<input type="radio"/>	<input checked="" type="radio"/>
8.	<input type="text"/>	<input type="radio"/>	<input type="radio"/>	<input checked="" type="radio"/>
9.	<input type="text"/>	<input type="radio"/>	<input type="radio"/>	<input checked="" type="radio"/>
10.	<input type="text"/>	<input type="radio"/>	<input type="radio"/>	<input checked="" type="radio"/>
11.	<input type="text"/>	<input type="radio"/>	<input type="radio"/>	<input checked="" type="radio"/>
12.	<input type="text"/>	<input type="radio"/>	<input type="radio"/>	<input checked="" type="radio"/>
13.	<input type="text"/>	<input type="radio"/>	<input type="radio"/>	<input checked="" type="radio"/>
14.	<input type="text"/>	<input type="radio"/>	<input type="radio"/>	<input checked="" type="radio"/>
15.	<input type="text"/>	<input type="radio"/>	<input type="radio"/>	<input checked="" type="radio"/>
16.	<input type="text"/>	<input type="radio"/>	<input type="radio"/>	<input checked="" type="radio"/>

Initialize | Request All | Request | Apply | Apply All | Load... | Save... | Exit

GT3200

User Detail | **Geofence** | Local Report | Roam Report | Alarm Setup | Roam Alarm | Roam Setting

Circular Type Origin Format Example : N2446.5321E12120.4231

No.	Origin	Radius	Km	Send	Local	Ignore
1.	<input type="text"/>	<input type="text"/>	<input type="text"/>	<input type="radio"/>	<input type="radio"/>	<input checked="" type="radio"/>
2.	<input type="text"/>	<input type="text"/>	<input type="text"/>	<input type="radio"/>	<input type="radio"/>	<input checked="" type="radio"/>
3.	<input type="text"/>	<input type="text"/>	<input type="text"/>	<input type="radio"/>	<input type="radio"/>	<input checked="" type="radio"/>
4.	<input type="text"/>	<input type="text"/>	<input type="text"/>	<input type="radio"/>	<input type="radio"/>	<input checked="" type="radio"/>
Self geofence:		<input type="text"/>	<input type="text"/>	<input type="radio"/>	<input type="radio"/>	<input checked="" type="radio"/>

Rectangular Type Format Example : N2446.5321E12120.4231

No.	Upright point	Downleft point	Send	Local	Ignore
1.	<input type="text"/>	<input type="text"/>	<input type="radio"/>	<input type="radio"/>	<input checked="" type="radio"/>
2.	<input type="text"/>	<input type="text"/>	<input type="radio"/>	<input type="radio"/>	<input checked="" type="radio"/>
3.	<input type="text"/>	<input type="text"/>	<input type="radio"/>	<input type="radio"/>	<input checked="" type="radio"/>
4.	<input type="text"/>	<input type="text"/>	<input type="radio"/>	<input type="radio"/>	<input checked="" type="radio"/>
5.	<input type="text"/>	<input type="text"/>	<input type="radio"/>	<input type="radio"/>	<input checked="" type="radio"/>

Point Type, Format Example : N2446.5321E12120.4231

No.	Point	Send	Local	Ignore
4.	<input type="text"/>	<input type="radio"/>	<input type="radio"/>	<input checked="" type="radio"/>
5.	<input type="text"/>	<input type="radio"/>	<input type="radio"/>	<input checked="" type="radio"/>
6.	<input type="text"/>	<input type="radio"/>	<input type="radio"/>	<input checked="" type="radio"/>
7.	<input type="text"/>	<input type="radio"/>	<input type="radio"/>	<input checked="" type="radio"/>
8.	<input type="text"/>	<input type="radio"/>	<input type="radio"/>	<input checked="" type="radio"/>
9.	<input type="text"/>	<input type="radio"/>	<input type="radio"/>	<input checked="" type="radio"/>
10.	<input type="text"/>	<input type="radio"/>	<input type="radio"/>	<input checked="" type="radio"/>
11.	<input type="text"/>	<input type="radio"/>	<input type="radio"/>	<input checked="" type="radio"/>
12.	<input type="text"/>	<input type="radio"/>	<input type="radio"/>	<input checked="" type="radio"/>
13.	<input type="text"/>	<input type="radio"/>	<input type="radio"/>	<input checked="" type="radio"/>
14.	<input type="text"/>	<input type="radio"/>	<input type="radio"/>	<input checked="" type="radio"/>
15.	<input type="text"/>	<input type="radio"/>	<input type="radio"/>	<input checked="" type="radio"/>
16.	<input type="text"/>	<input type="radio"/>	<input type="radio"/>	<input checked="" type="radio"/>
17.	<input type="text"/>	<input type="radio"/>	<input type="radio"/>	<input checked="" type="radio"/>
18.	<input type="text"/>	<input type="radio"/>	<input type="radio"/>	<input checked="" type="radio"/>
19.	<input type="text"/>	<input type="radio"/>	<input type="radio"/>	<input checked="" type="radio"/>
20.	<input type="text"/>	<input type="radio"/>	<input type="radio"/>	<input checked="" type="radio"/>

Initialize | Request All | Request | Apply | Apply All | Load... | Save... | Exit

Circular Type Origin Format Example : N2446.5321E12120.4231

No.	Origin	Radius	Unit	Send	Local	Ignore
1.	<input type="text"/>	<input type="text"/>	Km	<input type="radio"/>	<input type="radio"/>	<input checked="" type="radio"/>
2.	<input type="text"/>	<input type="text"/>		<input type="radio"/>	<input type="radio"/>	<input checked="" type="radio"/>
3.	<input type="text"/>	<input type="text"/>		<input type="radio"/>	<input type="radio"/>	<input checked="" type="radio"/>
4.	<input type="text"/>	<input type="text"/>		<input type="radio"/>	<input type="radio"/>	<input checked="" type="radio"/>
Self geofence:		<input type="text" value="1"/>		<input type="radio"/>	<input type="radio"/>	<input checked="" type="radio"/>

Four Circular Geofence and one self-geofence:

Circular Geofence must set origin and radius:

Origin format :N2446.5321E12120.4231;

N2446.5321 is latitude, E12120.4231 is longitude.

Radius from 0.1 km to 1000km.

User can set the reports send or local or ignore:

Send: report will send out immediately if generation

Local: report will save if generation, it will send out by local network

Ignore: cancel reports.

Rectangular Type Format Example : N2446.5321E12120.4231

No.	Upright point	Downleft point	Send	Local	Ignore
1.	<input type="text"/>	<input type="text"/>	<input type="radio"/>	<input type="radio"/>	<input checked="" type="radio"/>
2.	<input type="text"/>	<input type="text"/>	<input type="radio"/>	<input type="radio"/>	<input checked="" type="radio"/>
3.	<input type="text"/>	<input type="text"/>	<input type="radio"/>	<input type="radio"/>	<input checked="" type="radio"/>
4.	<input type="text"/>	<input type="text"/>	<input type="radio"/>	<input type="radio"/>	<input checked="" type="radio"/>
5.	<input type="text"/>	<input type="text"/>	<input type="radio"/>	<input type="radio"/>	<input checked="" type="radio"/>

Five rectangular geofence:

Set two points position, the point format is N2446.5321E12120.4231;

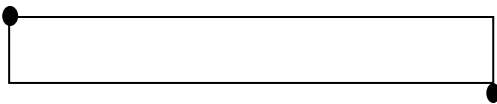

With two points, generate one rectangle. Unit will detect whether in rectangle. When unit enter or leave rectangle, will send one message out.

Point Type,	Format	Example : N2446.5321E12120.4231
No.	Point	
1.	<input type="text"/>	<input type="radio"/> Send <input type="radio"/> Local <input checked="" type="radio"/> Ignore
2.	<input type="text"/>	<input type="radio"/> Send <input type="radio"/> Local <input checked="" type="radio"/> Ignore
3.	<input type="text"/>	<input type="radio"/> Send <input type="radio"/> Local <input checked="" type="radio"/> Ignore
4.	<input type="text"/>	<input type="radio"/> Send <input type="radio"/> Local <input checked="" type="radio"/> Ignore
5.	<input type="text"/>	<input type="radio"/> Send <input type="radio"/> Local <input checked="" type="radio"/> Ignore
6.	<input type="text"/>	<input type="radio"/> Send <input type="radio"/> Local <input checked="" type="radio"/> Ignore
7.	<input type="text"/>	<input type="radio"/> Send <input type="radio"/> Local <input checked="" type="radio"/> Ignore
8.	<input type="text"/>	<input type="radio"/> Send <input type="radio"/> Local <input checked="" type="radio"/> Ignore
9.	<input type="text"/>	<input type="radio"/> Send <input type="radio"/> Local <input checked="" type="radio"/> Ignore
10.	<input type="text"/>	<input type="radio"/> Send <input type="radio"/> Local <input checked="" type="radio"/> Ignore
11.	<input type="text"/>	<input type="radio"/> Send <input type="radio"/> Local <input checked="" type="radio"/> Ignore
12.	<input type="text"/>	<input type="radio"/> Send <input type="radio"/> Local <input checked="" type="radio"/> Ignore
13.	<input type="text"/>	<input type="radio"/> Send <input type="radio"/> Local <input checked="" type="radio"/> Ignore
14.	<input type="text"/>	<input type="radio"/> Send <input type="radio"/> Local <input checked="" type="radio"/> Ignore
15.	<input type="text"/>	<input type="radio"/> Send <input type="radio"/> Local <input checked="" type="radio"/> Ignore
16.	<input type="text"/>	<input type="radio"/> Send <input type="radio"/> Local <input checked="" type="radio"/> Ignore
17.	<input type="text"/>	<input type="radio"/> Send <input type="radio"/> Local <input checked="" type="radio"/> Ignore
18.	<input type="text"/>	<input type="radio"/> Send <input type="radio"/> Local <input checked="" type="radio"/> Ignore
19.	<input type="text"/>	<input type="radio"/> Send <input type="radio"/> Local <input checked="" type="radio"/> Ignore
20.	<input type="text"/>	<input type="radio"/> Send <input type="radio"/> Local <input checked="" type="radio"/> Ignore

20 point Geo-fence areas can be set. When UNIT is out of these predefined zones, a report will be generated.

### 3. [Local report]:

The screenshot shows the 'Local Report' configuration window for the GT3200 device. The window has a blue title bar and a menu bar with options: User Detail, Geofence, Local Report (selected), Roam Report, Alarm Setup, Roam Alarm, and Roam Setting. The main area is divided into several sections:

- Intelligent report:** Includes checkboxes for 'NO More Often Than (moving)' and 'No less often Than (stopped)'. Parameters include 'Speed more than' (1.5 Km/Hr), 'No More Often Than' (90 Sec), 'No less often Than' (120 Sec), and 'Send Stop Report After' (120 Sec).
- Intelligent history report:** Similar to the intelligent report but with 'No less often Than' set to 360 Sec and 'Speed more than' set to 4 Km/Hr.
- IO connect selection:** A radio button selection between 'Temperature sensor' (selected) and 'AD1'.
- Temperature sensor report:** Includes checkboxes for 'Max temperature' and 'Min temperature' with values of 50 and -15 respectively, and a unit selector set to 'Celsius'.
- A/D 1 detect report:** Contains two columns of settings for 'Less than' and 'More than' voltage detection. Each column has fields for voltage (0.10 v), debounce time (20 sec), and resend time (120 sec). It also includes 'Voltage go up/down' and 'Min voltage' settings.
- A/D 2 detect report:** Identical in structure to A/D 1 detect report.
- Fixed report:** Includes checkboxes for 'Fixed time report' (120 Sec) and 'Fixed distance report' (1 Km).
- Speeding report:** Includes a checked 'Send speed over report' checkbox, 'Resend interval' (20 Sec), 'Threshold speed' (110 Km/h), and 'Enter over speed delay time'.

At the bottom of the window, there is a toolbar with buttons: Initialize, Request All, Request, Apply, Apply All, Load..., Save..., and Exit.

This screenshot shows the lower portion of the 'Local Report' configuration window, continuing from the previous image. It includes the following sections:

- Course change report:** Includes a checkbox for 'When course change' (180 degree) and a 'Debounce' time of 3 sec.
- Battery report:** Includes a checkbox for 'When less than' (50 %).
- Crash report:** Includes a checkbox for 'Send report when acceleration over' (4 (2-6)G).
- TL report:** Includes a checkbox for 'Send report when angle over' (5 degree).
- Keep alive:** Includes a checkbox for 'Keep alive' (3 Min, 2 retry) and an option to 'Send keep alive packet before due reports, if the idle time is longer than' (30 Min).
- GPRS Dial-up procedure:** Includes radio buttons for 'GPRS always online' (Reconnect interval: 1 Min), 'Base on report mode' (Reconnect times: 3 interval, 5 Min), and 'GPRS connect once'. It also has a checkbox for 'Reduce dialup procedure' with 'When reconnect times more than' (15 times) and 'it will wait for' (1.0 hour(s)).

The bottom toolbar remains the same: Initialize, Request All, Request, Apply, Apply All, Load..., Save..., and Exit.

Automatic report can be configured in this section. To activate the function(s), please select “√” in checkbox and fill in data in the textbox.

The reports will be summarized as

(1) Intelligent report

Parameters: On/Off, Report time when moving, Report time when stop, and threshold speed. Report when speed less than a preset value (refer the following 1.5 Km/Hr), and it will send stop report after a preset time (refer the following 120Sec). (min. speed is 0.1 km/Hr, max. speed is 1000 km/Hr).

(2) Intelligent history report (record the report in the system's flash ram)

Parameters: On/Off, Report time when moving, Report time when stop, and threshold speed. (min. speed is 0.1 km/Hr, max. speed is 1000 km/Hr).

(3) IO connect selection

Parameters: to select either temperature sensor or AD1

(4) Temperature report

Parameters: On/Off, and min. and max. temperature.

(5) AD detect report (AD1)

[on/off] SEND REPORT IF ADC1 LESS THAN [min voltage] V for [debounce time] SEC, RESEND PER [resend time] SEC

[on/off] SEND REPORT IF ADC1 MORE THAN [max voltage] V for [debounce time] SEC, RESEND PER [resend time] SEC

[on/off] SEND REPORT IF ADC1 GO UP [up voltage] V for [debounce time] SEC

[on/off] SEND REPORT IF ADC1 GO DOWN [down voltage] V for [debounce time] SEC

[on/off] SEND REPORT IF ADC1 ENTER/EXIT [min voltage] V TO [max voltage] V for [debounce time] SEC

Note: AD1 input voltage range is 0~3.30v, it must connect a resistance to share the voltage if the detected voltage higher than 3.30v.



## (6)AD detect report (AD2)

A/D 2 detect report

Less than 0.10 v  More than 0.10 v

debounce time 20 sec debounce time 20 sec

resend time 120 sec resend time 120 sec

Voltage go up 0.10 v  Voltage go down 0.10 v

debounce time 20 sec debounce time 20 sec

Min voltage 0.10 v  Max voltage 0.10 v

debounce time 20 sec

[on/off] SEND REPORT IF ADC2 LESS THAN [min voltage] V for [debounce time] SEC, RESEND PER [resend time] SEC

[on/off] SEND REPORT IF ADC2 MORE THAN [max voltage] V for [debounce time] SEC, RESEND PER [resend time] SEC

[on/off] SEND REPORT IF ADC2 GO UP [up voltage] V for [debounce time] SEC

[on/off] SEND REPORT IF ADC2 GO DOWN [down voltage] V for [debounce time] SEC

[on/off] SEND REPORT IF ADC2 ENTER/EXIT [min voltage] V TO [max voltage] V for [debounce time] SEC

Note: AD2 input voltage range is 0~3.30v, it must connect a resistance to share the voltage if the detected voltage higher than 3.30v.

## (7)Fixed time report

Parameters: On/Off, and time.

## (8)Fixed distance report

Parameters: On/Off, and distance. (min. distance is 0.1 km, max. distance is 100 km).

## (9)Course change report (to send a report when the course change is bigger than the value set here)

Parameters: On/Off, course change in degree and debounce time.

## (10) Low battery warning report (to alert user when the external battery level is low)

Parameters: On/Off, and warning battery level for report. For example, 50 to represent 50% lower level report.

The system will ignore the parameter with a value '0' to prevent continuous non-stop reporting.

## (11) Speed report

Parameters: resend interval, threshold speed, over speed delay time, exit over speed delay time, alert when over speed and report send or ignore

For example, if resend interval is 20 sec, enter over speed delay time is 20 sec, threshold speed is 110Km/h and exit over speed delay time is 2 sec.

If vehicle speed over threshold speed 20seconds, system will send speed over report once interval 20 sec until exit speed over delay time 2 sec, the over speed report will stop to send. If alert when over speed has configured, then it will alert when speed over.

## (12) Crash report

Parameters: on/off, and speed

You can select the crash report to be sent or not, while crash sensor over a preset value.(The crash sensor must be fit up, or the report still be ignored even if you select the item.) Otherwise the report will be ignored.

### (13) Tilt report

Parameters: on/off, and degree

If ACC off, then crash-sensor will work (if the Tangent angle sensor connected). crash-sensor can detect the little angle change. If the car be shake, then the crash-sensor will be triggered. And crash-sensor will wake up the system.

### (14) GPRS dial-up procedure

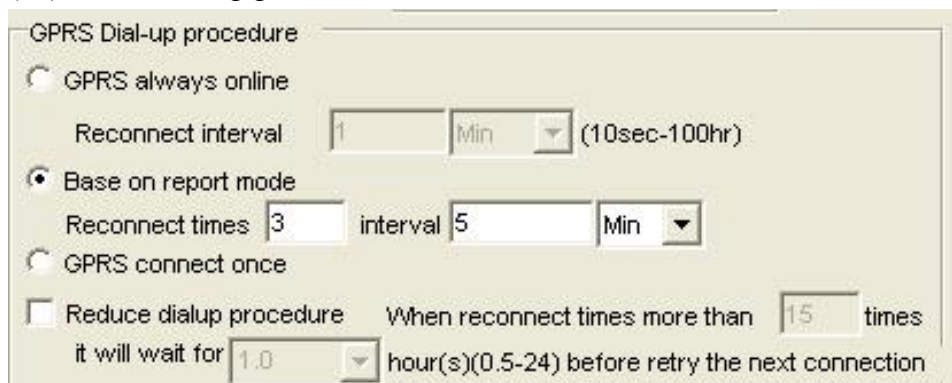

#### 1) GPRS always on-line

Parameters: Reconnect interval

While using this mode, when the unit can not searched GPRS signal, system will reconnect GPRS interval a preset value. (e.g.: 1minute)

#### 2) Base on report mode

Parameters: Max. reconnect times, reconnect interval

While using this mode, the unit will connect to the server when there is a report to send. If the first connection is failed, it will retry to connect to the server up to the max. reconnect times. Each retry will be separated by the reconnect “interval”.

#### 3) GPRS connect once

While using this mode, the unit will connect to the server when there is a report to send (but only try once). If it is not successful, the report will be stored and sent out in the next successful connection. Disconnect GPRS connection when report sending is completed.

#### 4) Reduce GPRS dialup method

Parameters: On/Off, Max. reconnect times, connect delay

If this method is used, the unit will reduce the GPRS dial-up connection when the dial-up is failed after number of times. User can define the delay time for the unit before try to reconnect to the server. If there is trigger report, the unit will connect to server immediately.

### (14)Keep alive procedure

Parameters: On/Off, and interval / retry times. In order to keep connection in GPRS network, the unit can be set to send short keep alive report to the server in order to prevent the disconnection from the mobile service provider.

Send reports after a successful keep alive ACK. Parameters: On/Off.

If you select this function, all the reports will only be sent out after a successful keep alive ACK. (So if your

keep alive time is shorter then select this function will be OK.) This function is very useful while using UDP to prevent report lost.

Send a keep alive packet right before a due reports if no data stream within certain time: Parameters: On/Off, and idle time.

Some GSM provider might cut connection, if there is no data within certain time. It might result report lost in this “fake connection” duration. For example, you can set parameters in this region, ex 20 mins. (it means if the unit did not send any data in this 20 mins (including keep alive or normal reports) ), then it will send a keep alive packet to check if the GPRS connection is valid or not. If not, it will actively reconnect to GPRS network.

### Special command for SMS mode:

If the GT3200ST is not in the GPRS online status, user can send command &&Y02 or &&Y04 to ask unit to connect to server. This command can be sent from any device via SMS;

**&&Y02:**

When received this command, system will actively try to connect to server in next 600 seconds.

**&&Y04,[connection time],[report interval]:**

For example: &&Y04, 3600, 60

When received this command, system will connect to server in the next 3600 seconds, and send one report out every 60 seconds.

## 4. [Roam report]

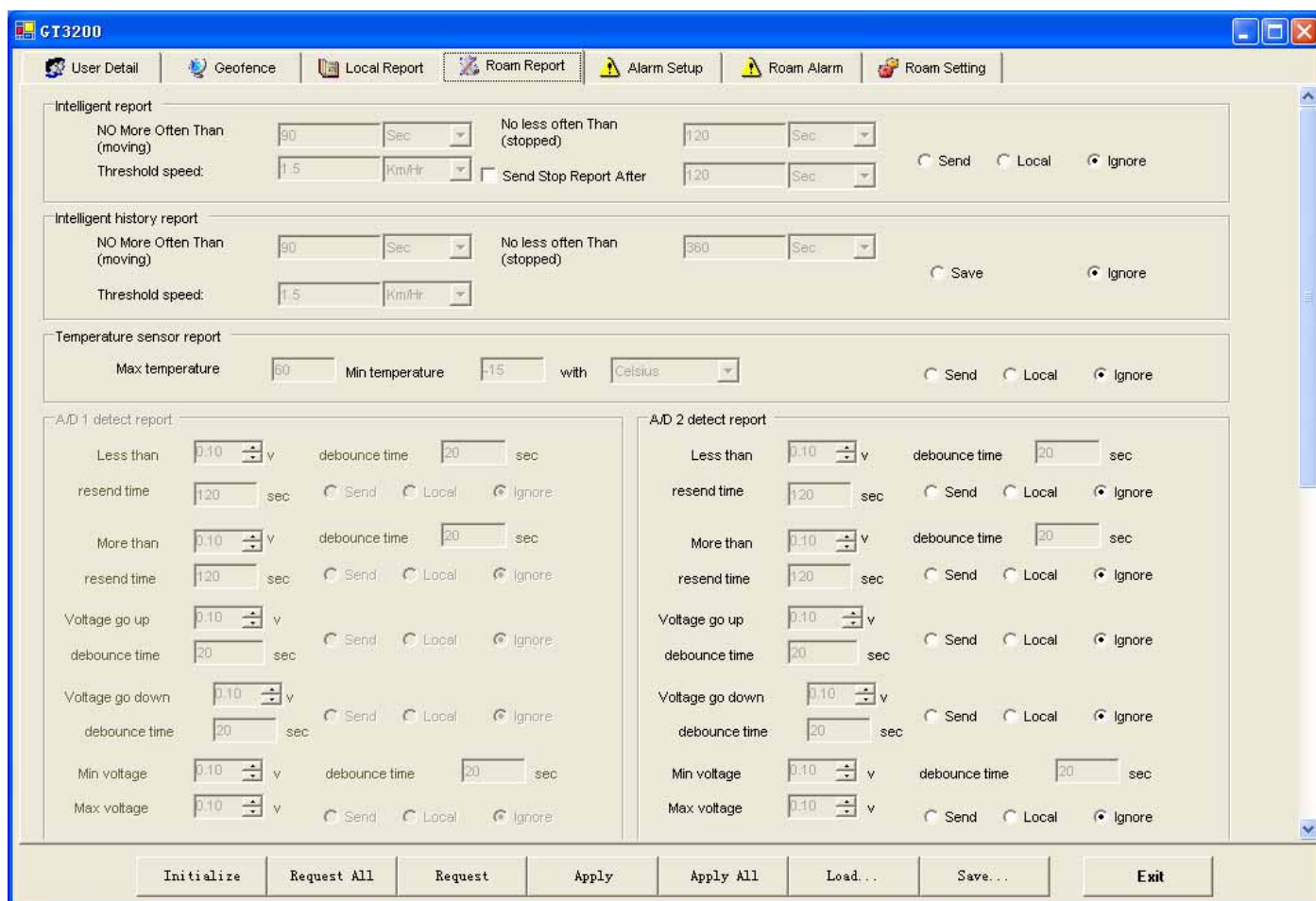

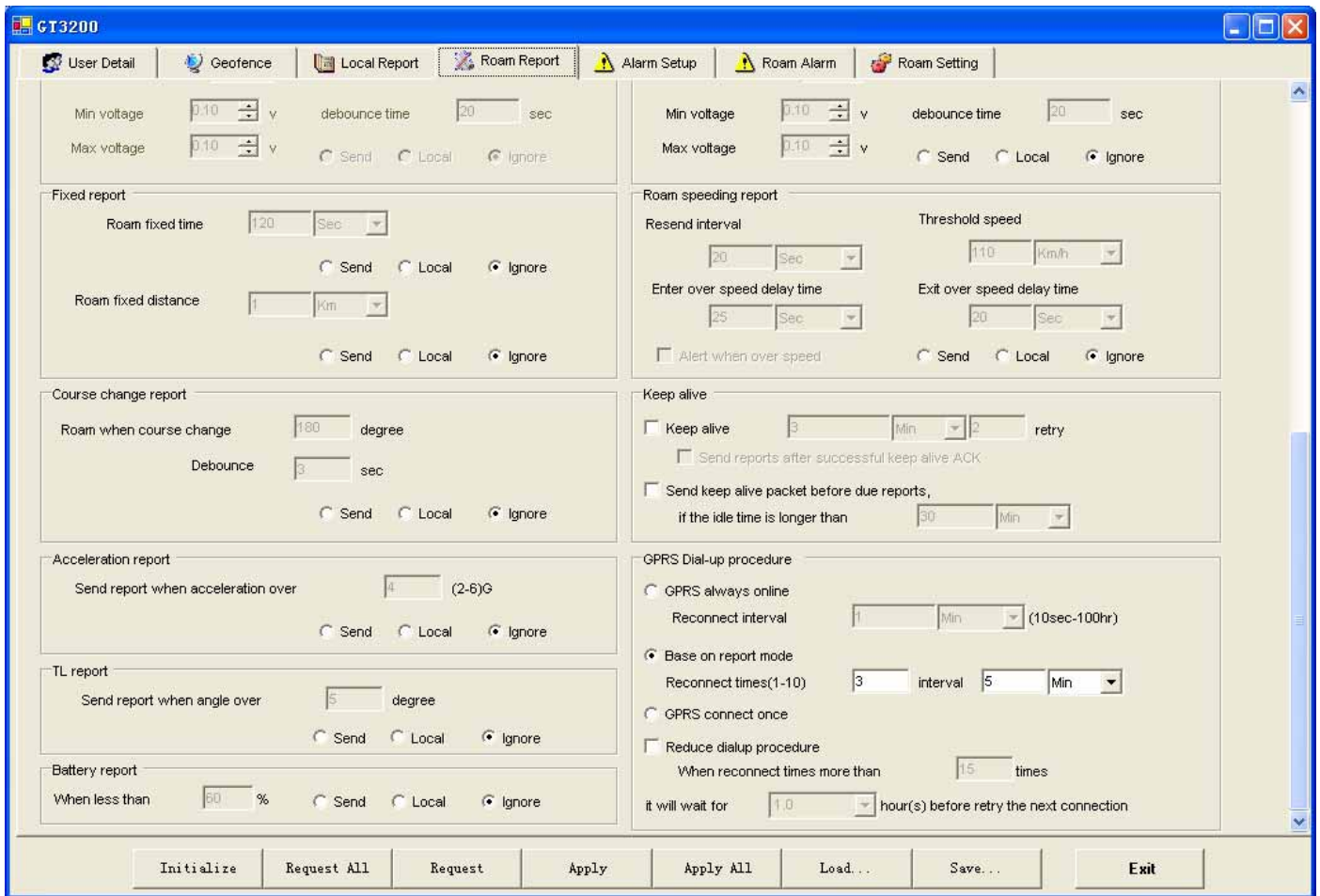

All the roam reports configured are same as Local report.

Send: report will send out immediately if generation

Local: report will save if generation, it will send out by local network

Ignore: cancel reports.

## 5. [Alarm REPORT setup]

Alarm report(s) is also configurable. User can customize the events generated by the in-vehicle input or build in car alarm to be sent to the server. If the item(s) be selected (VALID), the related reports will be sent. Otherwise the report will be ignored even when an event is occurred internally.

Also build in car alarm function can be set on here.

If input 3 with distance is selected, system will send the distance report every time ACC ON to ACC OFF, for example: %%GT3200ST,A,070521024400,N2240.8929E11359.2030,000,270,NA,D7000000,254,CFG:5, CFG:5 means the current ACC ON to ACC OFF distance is 5km.

### Sleep mode (when ACC OFF)

(1) GT3200ST can go to sleep mode when ACC goes off and crash-sensor (and optional shock sensor) not be trigger for 5minuts. In sleep mode, GPS will be disabled.

All the auto report (Time, Distance, Intelligent...) will not be send when ACC goes off.

(2) During the sleep mode, the system can wait up automatically and send a wake up diagnostic report. The automatic wakeup time is configurable. (Minimum duration is 5 minutes; maximum duration is 1000 Hours).

(3) If any of the inputs are triggered while in the sleep mode, the system will wake up automatic and then send reports to the server. The input triggers for waking the device up are selectable. If the GPRS connection is failed, for emergency purpose, GT3200ST will send out SMS report if number is defined.

If select the item, when ACC off, system will cut power of handset, otherwise, system will not cut power of handset.

## 6. [Roam Alarm REPORT setup]

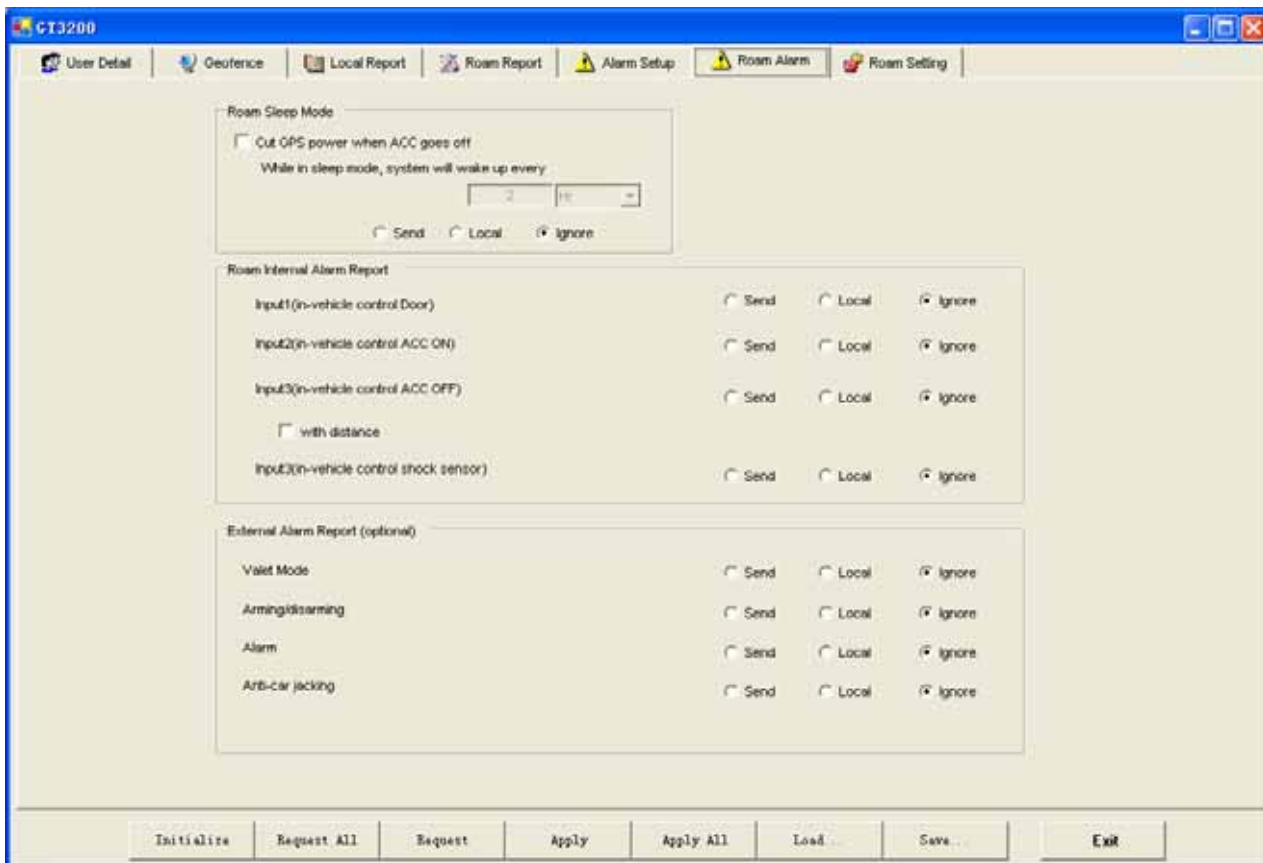

In roam alarm mode, use can set all the alarm reports send or local or ignore:

Send: report will send out immediately if generation

Local: report will save if generation, it will send out by local network

Ignore: cancel reports.

## 7. [Roam setting]

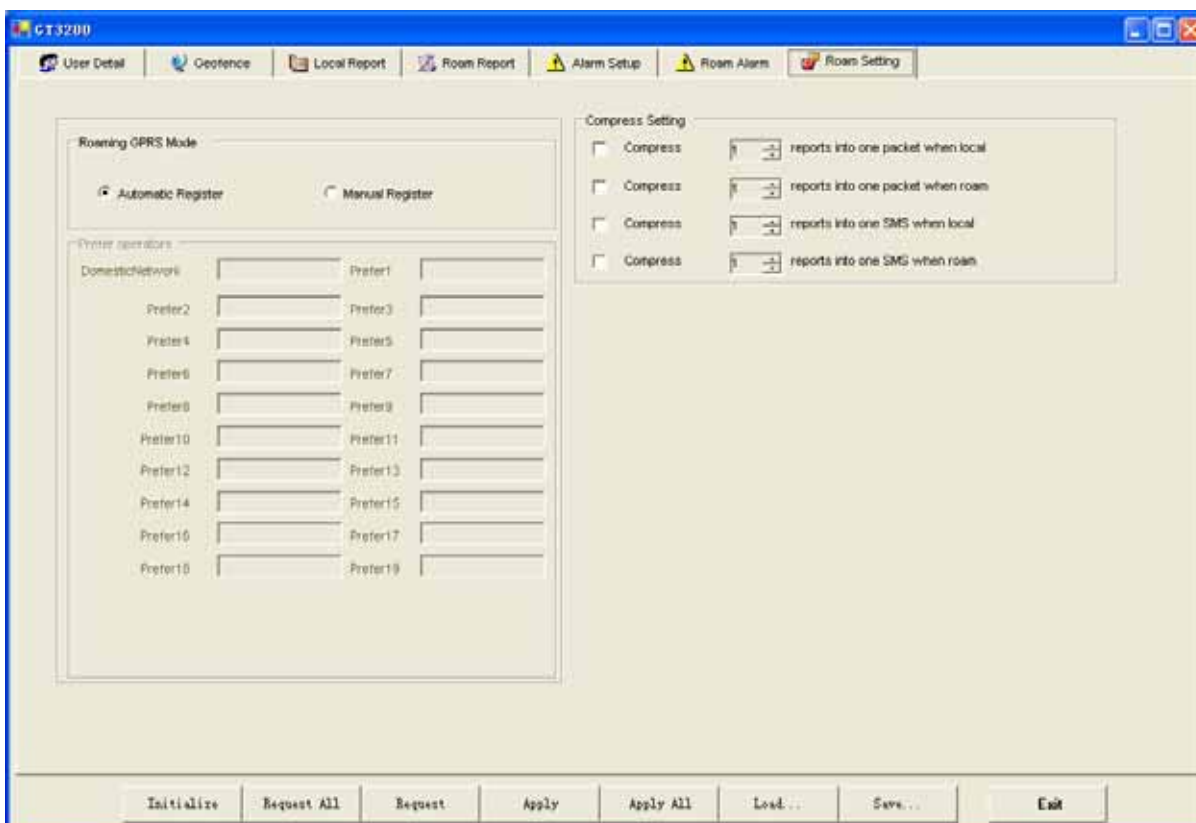

## 1) Roaming GPRS mode

Roaming GPRS Mode

Automatic Register
  Manual Register

Prefer operators

DomesticNetwork		Prefer1	
	Prefer2		Prefer3
	Prefer4		Prefer5
	Prefer6		Prefer7
	Prefer8		Prefer9
	Prefer10		Prefer11
	Prefer12		Prefer13
	Prefer14		Prefer15
	Prefer16		Prefer17
	Prefer18		Prefer19

Use can configure roaming GPRS mode with automatic register or manual register in this field.

When roaming GPRS mode in manual register, user can set 20 prefer operators, main unit will search and register from the 20 prefer operators.

## 2) Compress setting

Compress Setting

Compress 1 reports into one packet when local

Compress 1 reports into one packet when roam

Compress 1 reports into one SMS when local

Compress 1 reports into one SMS when roam

1. To send report in local GPRS, compressing N reports to a packet and then send out.(N: the digit between 1~8)
2. To send report in roam GPRS, compressing N reports to a packet and then send out.(N: the digit between 1~8)
3. To send report in local SMS, compressing N reports to a SMS and then send out.(N: the digit between 1~5)
4. To send report in roam SMS, compressing N reports to a SMS and then send out.(N: the digit between 1~5)

## APPENDIX 1

### GT3200ST SPECIFICATIONS

#### **Physical Parameters**

Enclosure dimensions	130*80*25mm
Weight	550g

**Electrical**

DC Supply voltage	12V or 24V
DC Tolerance voltage	9V - 36V
Current (GPRS online)	60mA
Current (GPRS transmission)	80mA
Current (Peak)	120mA
Current (Sleep)	25mA (GPS off)

**Internal Battery**

Battery type	Ni-Mh 4.8V
Battery capacity	80 mA/H
Charge type	Built-in charge circuit

**GPRS\*** Data provided by SIMCOM

Frequency Range (MHz)	Support 4-frequency 850/900/1800/1900
Channel spacing (Hz)	200
GPRS connectivity	GPRS multi-slot class 10 GPRS mobile station class B
SIM card interface	3.4~4.5V
SMS storage Capacity	40 in ME
Antenna Connector	Silver Male TNC or SMA
Antenna Impedance	50ohms

**GPS\*** Data provided by TYCO

Channels	20 parallel tracking
Correlators	200,000 plus
Frequency	L1-1575 MHz
Sensitivity	
Tracking	-159 dBm
Acquisition (Cold start)	-142 dBm
Position accuracy (Horizontal)	< 2.5m CEP autonomous
	< 2.0m CEP SBAX
Time to first fix	
Hot start 1	< 1s
Warm start 2	< 32s
Cold 3	< 35s
Standard GPS software	
NMEA message switchable	GGA, GSA GSV, VTG, RMC, GLL
Baudrate (in baud)	4800(default) to 34,400
Serial ports	
Tx0	NMEA output
Rx0	NMEA input
Temperature	
Operating	-30 to +85



Storage	-40 to +85
Humidity	Non-condensing
Input voltage	3.0 to 3.6 VDC
Current draw	
Average acquisition	36mA (typical)
Tracking	31mA (typical)
Antenna supply via VANT	
Voltage range	Up to 5.2V
Max. allowed current 4	50mA

### **Communication**

	GPRS \SMS\RS232\RF (with optional build in alarm)
--	---

### **Environmental**

Operating Temperature	-20°C to +55°C
Storage Temperature	-40°C to +85°C

### **Optional Accessories**

1. Combined Antenna (with GPRS and active GPS)
2. Temperature sensor
3. Ultrasonic sensor
4. Shock-sensor
5. PC-setup Cable
6. Handset

### **Note:**

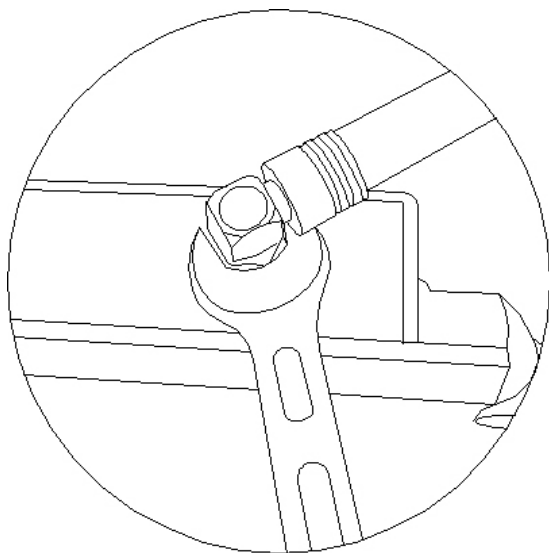

Using wrench to tighten the screw cap of GPS and GPRS antenna and lock the screw cap to fix position, for avoid antenna connect abnormality, user can not using hands to tighten the screw cap.

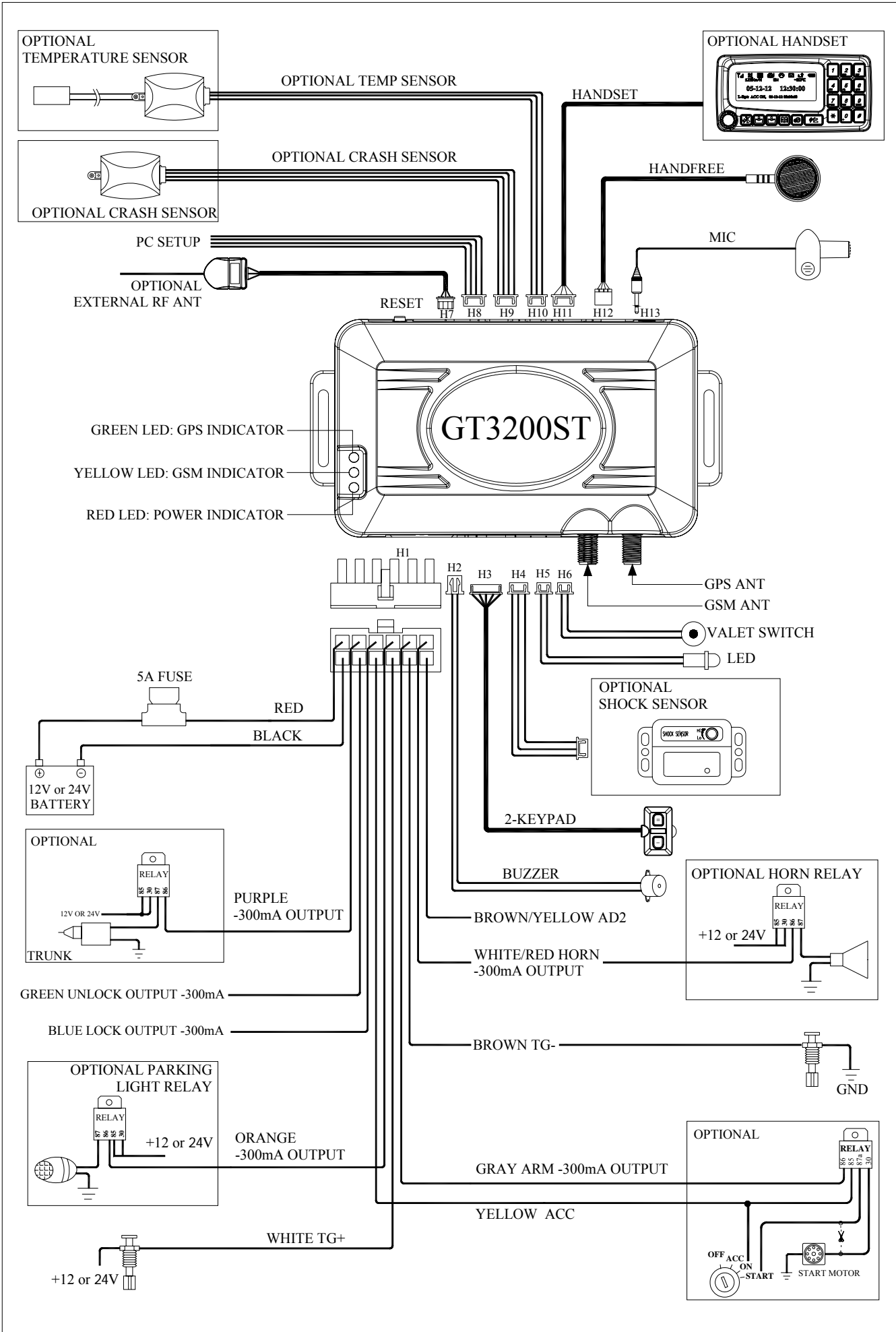

15.21

**Federal Communications Commission (FCC) Statement**

**You are cautioned that changes or modifications not expressly approved by the part responsible for compliance could void the user's authority to operate the equipment.**

15.105(b)

**Federal Communications Commission (FCC) Statement**

This equipment has been tested and found to comply with the limits for a Class B digital device, pursuant to part 15 of the FCC rules. These limits are designed to provide reasonable protection against harmful interference in a residential installation. This equipment generates, uses and can radiate radio frequency energy and, if not installed and used in accordance with the instructions, may cause harmful interference to radio communications. However, there is no guarantee that interference will not occur in a particular installation. If this equipment does cause harmful interference to radio or television reception, which can be determined by turning the equipment off and on, the user is encouraged to try to correct the interference by one or more of the following measures:

- Reorient or relocate the receiving antenna.
- Increase the separation between the equipment and receiver.
- Connect the equipment into an outlet on a circuit different from that to which the receiver is connected.
- Consult the dealer or an experienced radio/TV technician for help.

**Operation is subject to the following two conditions:**

- 1) this device may not cause interference and
- 2) this device must accept any interference, including interference that may cause undesired operation of the device.

**FCC RF Radiation Exposure Statement:**

1. This Transmitter must not be co-located or operating in conjunction with any other antenna or transmitter.
2. This equipment complies with FCC RF radiation exposure limits set forth for an uncontrolled environment. This equipment should be installed and operated with a minimum distance of 20 centimeters between the radiator and your body.