



Model: PTC20LD

16:10 DIGITAL LCD-TV-Monitor

19" Hi-Definition LCD Flat Panel TV w/Built-in DVD Player

OPERATING MANUAL

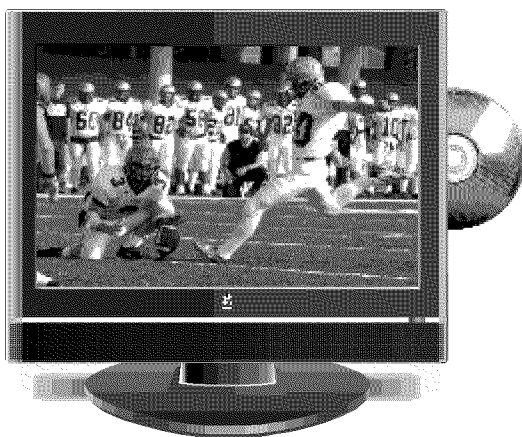

www.pyleaudio.com

Contents

1	PREFACE	3
<hr/>		
2	SAFETY PRECAUTIONS	3
<hr/>		
3	FRONT, BACK, CONNECTIONS OF LCD	5
<hr/>		
4	TV INSTALLATION GUIDE	4.1 CONNECTION ANTENNAS 7 4.2 AV VIDEO INPUT DRAWING 7 4.3 S-VIDEO INPUT DRAWING 7 4.4 PC (VGA) CONNEXION DRAWING 8
<hr/>		
5	TV OPERATION ----- Basic operation ----- MENU operation	Turning on and off TV 9 Select on screen language 9 Volume adjustment 9 How to adjust the OSD 10 Choosing a TV channel 10 Selecting input source 10 ----- Picture menu options 11 Audio menu options 11 Setup menu options 12 Feature menu options 14 VGA menu options 16 YPbPr menu options 17 HDMI menu options 17
<hr/>		
6	REMOTE CONTROLS SETUP	A Remote control instructions 20 B Battery Usage Caution 22
<hr/>		
7	ACCESSORIES	22
<hr/>		
8	INDEX	22

PREFACE

Thank you for buying this TV ! Please read this manual thoroughly before operating the monitor. Make sure the monitor was not damaged in transit. Should the monitor is damaged, do no install it and contact your dealer. Check that you have all the accessories according to the model.

SAFETY PRECAUTIONS

Preparation

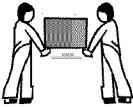

Put the monitor on a stable surface.



Do not use the monitor with others fixations than those provided or suggested by the manufacturer.

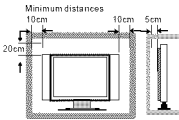

Do not place any material on the monitor.

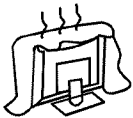

Do not block or cover the ventilation openings on the monitor

If you have a wall mount, check that it is steady

Power source

The monitor must be plugged with a tension source of 110 volts and 60 Hz.

Connexion cables



Power cord and cables must be properly routed and protected to prevent people from stepping on them and causing the monitor to fall.

Heating sources and humidity

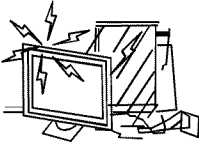

Keep the monitor dry and away from humidity.

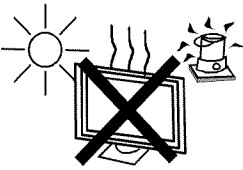

Keep the monitor away from heat sources

Cleaning and maintenance

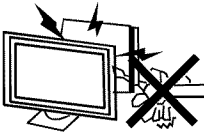

Unplug the monitor before cleaning it. Do not use solvents or liquids to clean the monitor.

Only clean the monitor with a soft and dry cloth.

In case of troubleshooting, do not use spare parts other than those suggested by the manufacturer. Using inadequate spare parts can lead to electric shocks, short-circuits fire or other incidents.

Departure in holidays



Unplug the LCD during lighting storms or when unused for long periods of time.

Front , Back , Connections of LCD

Front View

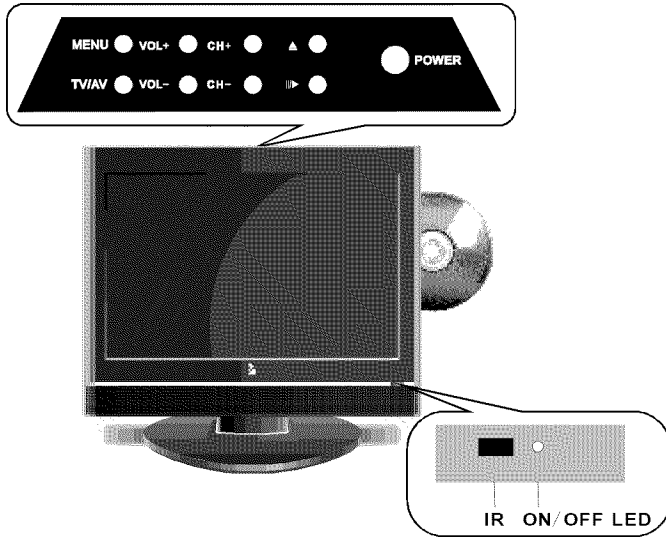

Back View and Control Connections

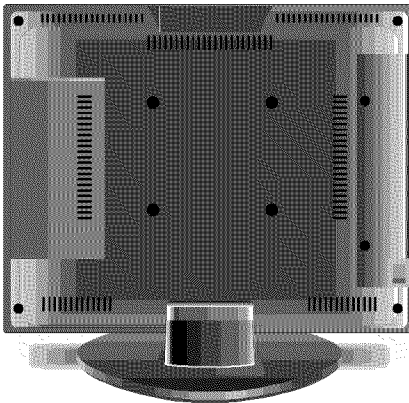

1	RF IN
2	V IN
3	S-VIDEO
4	HDMI
5	VGA
6	PC AUDIO
7	Pr
8	Pb
9	Y
10	R IN
11	L IN
12	PHONE
13	DC IN

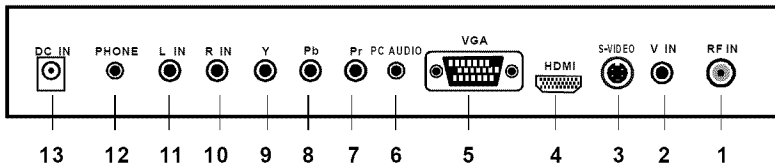

Side View DVD Player Control

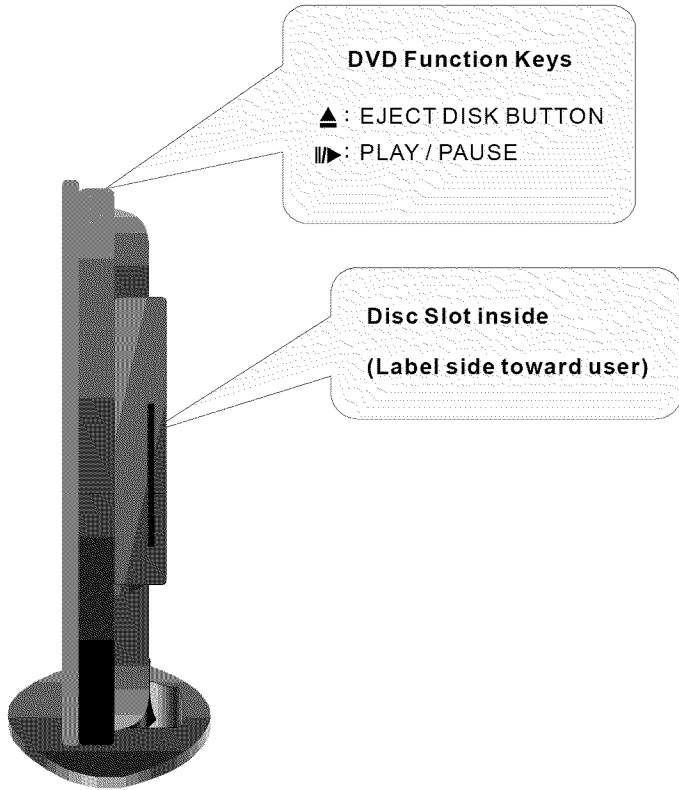

TV INSTALLTION DRAWINGS

CONNECTION ANTENNAS

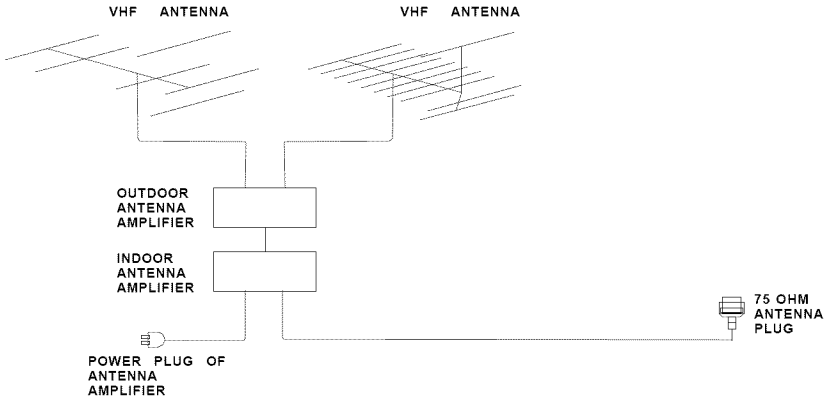

To ensure good picture and sound, TV antenna system needs to be installed. The antenna system as shown can be sourced from TV equipment shops, which will provide service for correct installation and connection. After installation, insert the 75-ohm antenna plug into the antenna jack as shown. In case of signal of closed circuit TV,

VIDEO CONNECTION

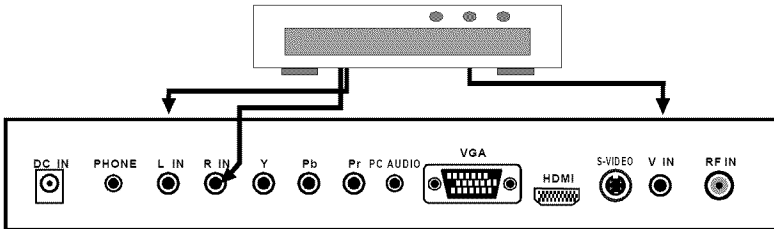

S-VIDEO CONNECTION

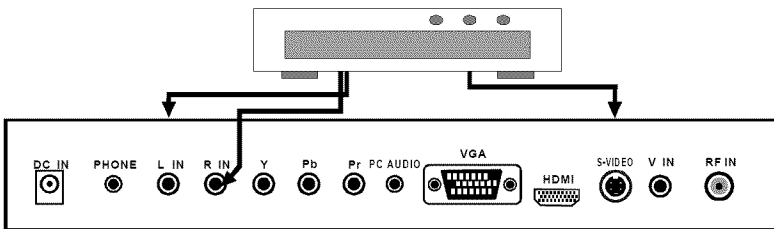

PCINPUT CONNECTION

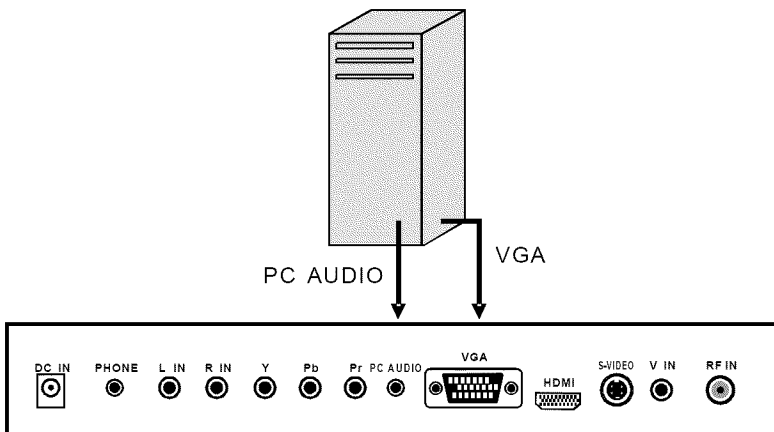

Menu Operation

Basic operation

Turning on and off the TV

TURN ON LCD TV

1. Connecting to the AC input cable then press the main power switch to switch ON LCD TV. At this time the TV will enter standby mode and indicator show red.
2. Use POWER button can turn ON LCD TV from standby mode.

TURN OFF LCD TV

1. Press POWER button or  button on the remote control to enter standby mode. The indicator is red.
2. Using main power switch turns off LCD TV completely.

Select on screen language

NOTE: If you use your LCD TV for the first time, you should select the language which will be used for displaying menus and indications.

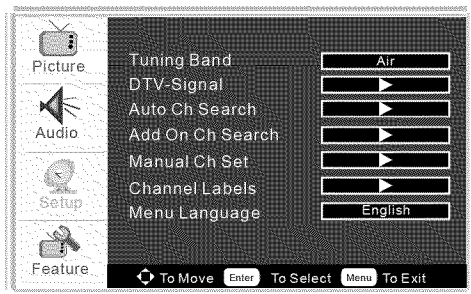

- Press **MENU** to display the main menu.
- Press **▲ / ▼** repeatedly to select the **SET MENU**.
- Use **◀ / ▶** and **▲ / ▼** to select **LANGUAGE**.
- Press **◀** and **▶** button to select your desired language.
- When you are satisfied with your choice, press the **MENU** to exit.

Volume adjustment

1. Press **VOL+/-** to adjust the volume.
2. If you want to switch the sound OFF, press the **MUTE** .
3. You can cancel this function by pressing **MUTE** or **VOL+**.

How to adjust the OSD screen

- Press the **MENU** button to display the main menu.
- Use **▲/▼/◀/▶** buttons to select and adjust the available menus.

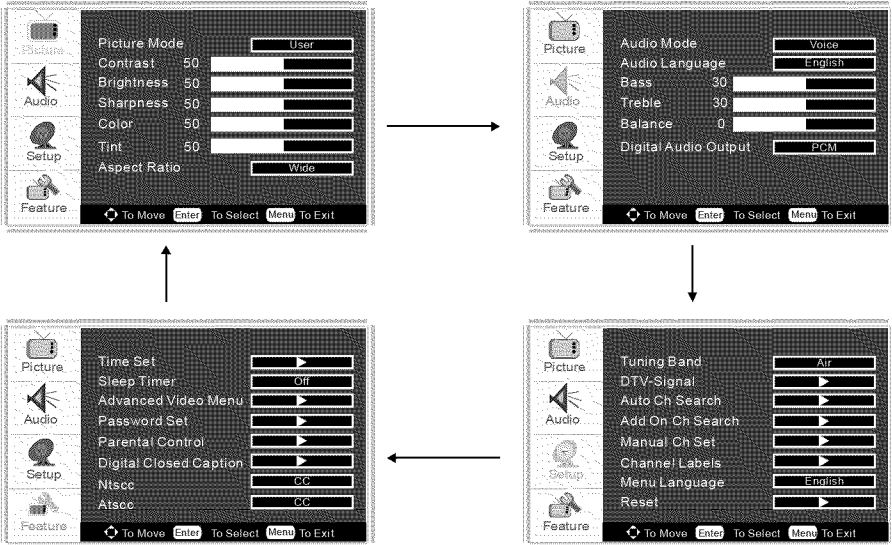

The OSD (On Screen Display) function enables you to adjust the screen status conveniently since it provides graphical presentation.

Choosing a TV channel

- Using the CH+/CH- on the front panel or on the remote control.**
 - Press **CH+** to increase channel number.
 - Press **CH-** to decrease channel number.
- Using 0-9 digital buttons and -/--button**
You can select the channel number by pressing 0 to 9 or -/--.
- Example:**
 - To select 1-digit channel (e.g. Channel 5): Press the 5 button.
 - To select 2-digit channel (e.g. Channel 20): Press the -/-- button repeatedly to display -- then press 2, follow by 0.
 - To select 3-digit channel (e.g. Channel 103): Press the -/-- button repeatedly to display -- then press 1, follow by 0, follow by 3.

Note: After select the digit button, the digit will be memorized.

Selecting input source

You can select the input source by pressing the **INPUT** on the remote control or on the front panel.

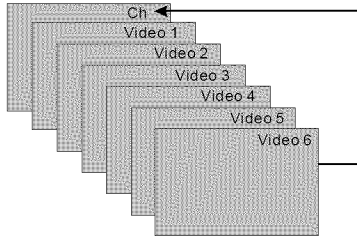

Picture menu options



In this manual, the OSD (On Screen Display) may be different from your TV' s because it is just example to help the TV operation.

Press the **MENU** on the front panel or on the remote control and then use **▲ / ▼** to select the **Picture** menu.

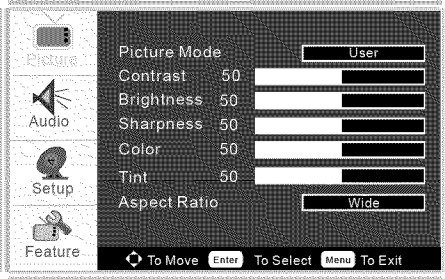

1. Use **▲ / ▼** to select what you want to adjust in the **Picture** menu.
2. Press **◀** and **▶** button to adjust.
3. When you are satisfied with your adjustment, press **MENU** to exit the main menu.

Picture Mode

Select the type of picture which best corresponds to your viewing requirements by selecting Picture Mode in PICTURE menu. You may select the picture mode directly by pressing the PMODE button on the remote control.

Contrast

Press **▼ / ▲** button and then use **◀ / ▶** to adjust the contrast of the picture.

Brightness

Press **▼ / ▲** button and then use **◀ / ▶** to adjust the brightness of the picture.

Sharpness

Press **▼ / ▲** button and then use **◀ / ▶** to adjust the sharpness level of picture.

Color

Press **▼ / ▲** button and then use **◀ / ▶** to adjust the color saturation.

Tint

Press **▼ / ▲** button and then use **◀ / ▶** to adjust the tint of picture.

Aspect Ratio

Press **◀▶** to select the ratio of picture display such as Normal/ Zoom/ Wide and Cinema.

AUDIO menu options

Press **MENU** on the front panel or on the remote control and then use **▲ / ▼** to select the **AUDIO** menu.

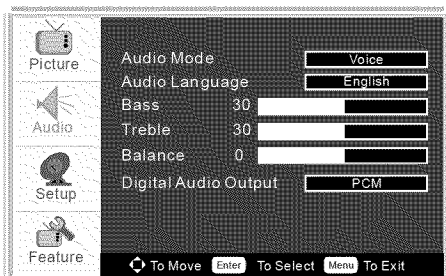

1. Use ▲ / ▼ to select what you want to adjust in the **Audio** menu.
2. Press ◀ and ▶ button to adjust.
3. When you are satisfied with your adjustment, press **MENU** or **EXIT** to exit the main menu.

Audio Mode

You can select the type of sound which best corresponds to your listening requirements by selecting Sound in SOUND menu. You may select the sound mode directly by pressing the SMODE button on the remote control.

Audio Language

Press ◀ / ▶ to select one of the audio language such as English/ French and Spain, but the condition is that the program system has included the language code.

Bass

Press ▼ / ▲ button and then use ◀ / ▶ to increase or decrease the level of the lower-pitched sounds.

Treble

Press ▼ / ▲ button and then use ◀ / ▶ to increase or decrease the level of the higher-pitched sounds.

Balance

Press ▼ / ▲ button and then use ◀ / ▶ to adjust the audio output between left and right speakers.

Digital Audio Output

Press ◀ / ▶ to select the one of mode of the digital audio output such as PCM and RAW.

Setup menu options

Press MENU on the front panel or on the remote control and then use ▲ / ▼ to select the Setup menu.

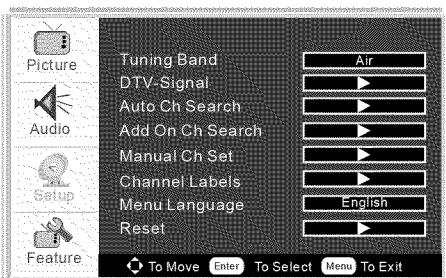

1. Use ▲ / ▼ to select what you want to adjust in the **Setup** menu.
2. Press ◀ and ▶ button to adjust.
3. When you are satisfied with your adjustment, press **MENU** to exit the main menu.

Tuning Band

Press Enter key to select Air, Cable, Cable HRC, Cable IRC or Cable Auto.

DTV-Signal

In DTV mode, you can tune manually and adjust the angle, orientation of the antenna etc

Auto Ch Search

Press **▲ / ▼** key to move the cursor to the item to be selected (item selected is highlighted in yellow). Press **Enter** key to enter your selection and scan. After the scan is finished, the following menu will display. The channels found are automatically saved as below:

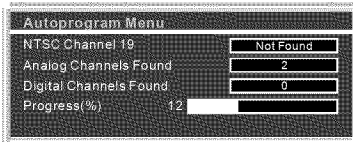

Add On Ch Search

When the channels are found, use **◀ / ▶** to add it to the channel list.

Manual Ch Set

Press **Enter** button to display a channel list that you can select channel as below:

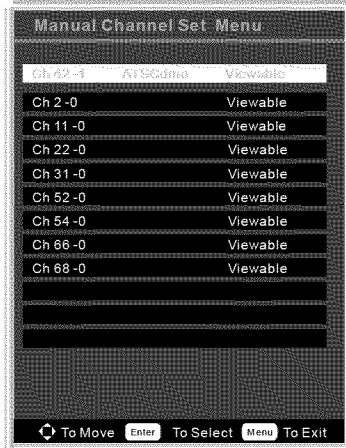

Channel labels

Allows you to name the channel that is selected. Use **◀ / ▶** to move the cursor and use **▲ / ▼** to input the name and then press **Menu** or **Enter** to return or exit as following:

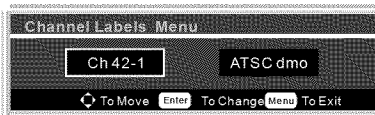

Manual Language

To select language of the OSD such as English/ French and Spain

Feature menu options

Press MENU on the front panel or on the remote control and then use ◀ / ▶ to select the Feature menu.

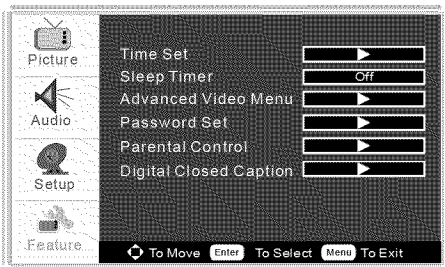

1. Use ▲ / ▼ to select what you want to adjust in the **Feature** menu.
2. Press ◀ and ▶ button to adjust.
3. When you are satisfied with your adjustment, press **MENU** to exit the main menu.

Time Set

Press ▼ / ▲ button and then use Enter the time set menu as below that allows you to set the time the TV will display.

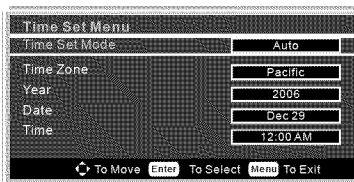

Time Set Mode

You can select one of auto and manual to set the time. When selected auto, the item of year/date and time will be disabled and can not to adjust. When select the manual mode, you can press ◀ / ▶ and ▲ / ▼ to set the corresponding functions.

Time Zone

Press ◀ / ▶ to select the time zone such as Pacific/ Alaska/ Hawaii/ Eastern/ Central/Mountain.

Sleep Timer

Press ◀ / ▶ to select the amount of time before your TV turn off automatically and press the Enter that can select the 30 min /60min/90min and OFF.

Advance Video Menu

Press Enter to enter the advance video menu as below:

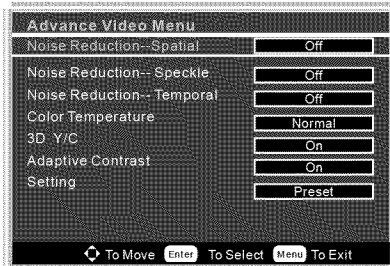

- Noise Reduction--Spatial: press Enter to select on or off.
- Noise Reduction--Speckle: press Enter to select on or off.
- Noise Reduction--Temporal: press Enter to select on or off.
- Auto Contrast Enhancement: press Enter to select on or off.
- Color Temperature: press Enter to select one of Normal/Cool and Warm.
- 3D Y/C: press Enter to select on or off.
- Adaptive Contrast: press Enter to select on or off.
- Setting: press Enter to return to the factory setting.

Password Set

Press Enter to enter the Enter Old Password menu, and then input the number of 0-9 as below, and you can change the password when you input the new one twice.

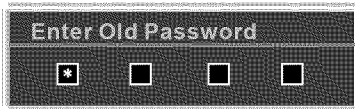

Parental Control

Press Enter to enter the sub-menu and then uses the 0-9 to enter the correct password.

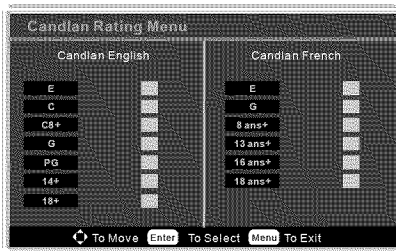

Digital Closed Captions

This item allows you to set the closed caption, and press Enter to enter Closed Caption Options menu as below:

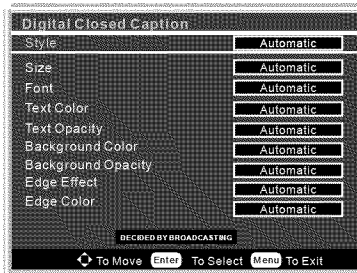

- Style: press Enter to select one of Automatic and Custom, when you select automatic, the others are disable and can not be adjusted.
- Size: press Enter to select one of Normal/Large and Small.
- Font: press Enter to select one of Default and from Font1 to Font7.
- Text Color: press Enter to select one of Red/Green/Blue/Yellow/Magenta/Cyan/Black and White.
- Text Opacity: press Enter to select one of the Solid/Flashing/Transparent/Translucent.
- Background Color: press Enter to select one of the Black/White/Red/Green/Blue/Yellow/Magenta/Cyan.
- Background Opacity: press Enter to select one of the Solid/Flashing/Transparent/Translucent.
- Edge Effect press Enter to select one of the None/Raised/Depressed/Uniform/Left Shadow/Right Shadow.
- Edge Color press Enter to select one of the Black/White/Red/Green/Blue/Yellow/Magenta/Cyan.

VGA menu options

Press MENU on the front panel or on the remote control and then use ▼ / ▲ to select the Feature menu in VGA mode.

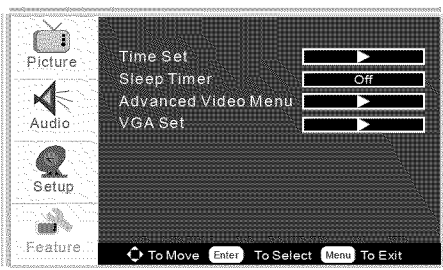

1. Use ▲ / ▼ to select what you want to adjust in the **Feature** menu.
2. Press ◀ and ▶ button to adjust.
3. When you are satisfied with your adjustment, press **MENU** to exit the main menu.

VGA Set

Press ▲ / ▼ button and then use Enter to enter the VGA set menu as below:

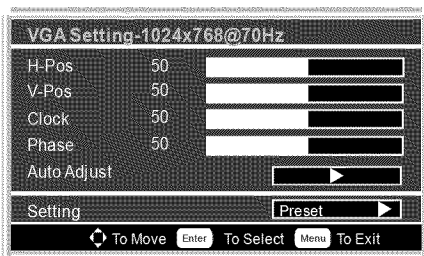

H-Pos

Press ▼ / ▲ button and then use ◀ / ▶ adjust the horizontal position of the picture.

V-Pos

Press ▼ / ▲ button and then use ◀ / ▶ adjust the vertical position of the picture.

Phase

Press ▼ / ▲ button and then use ◀ / ▶ to adjust the phase of the picture.

Clock

Press ▼ / ▲ button and then use ◀ / ▶ to adjust the clock of the picture.



- Phase This function allows you to remove any horizontal noise and clear or sharpen the image of characters
- Clock This function is to minimize any vertical bars or stripes visible on the screen background. And the horizontal screen size also will change.
- Position This function is to adjust the picture to Left/Right and Up/Down as you prefer..

Auto Adjust

Press ▼ / ▲ button and then use ◀ / ▶ to do auto adjust that automatically adjusts the available options for the best viewing configuration.

Setting

Press Enter to do preset that can return to the factory setting.

YPbPr menu options

Press MENU on the front panel or on the remote control and then use ▼ / ▲ to select the Feature menu in YPbPr mode.

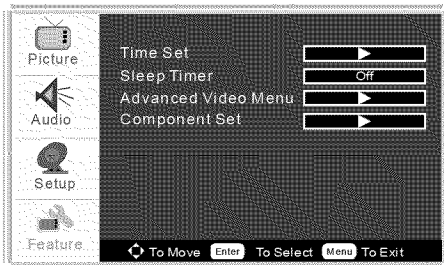

1. Use ▲ / ▼ to select what you want to adjust in the **Feature** menu.
2. Press ◀ and ▶ button to adjust.
3. When you are satisfied with your adjustment, press **MENU** to exit the main menu.

Component Set

Press ▲ / ▼ button and then use Enter to enter the VGA set menu as below:

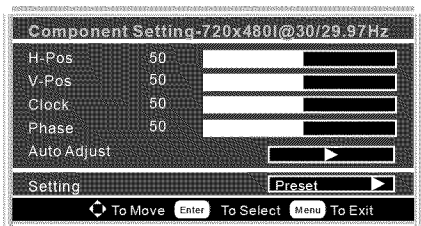

HDMI and S-VIDEO menu options

Press MENU on the front panel or on the remote control and then use ▼ / ▲ to select the Feature menu in HDMI or S-VIDEO mode.

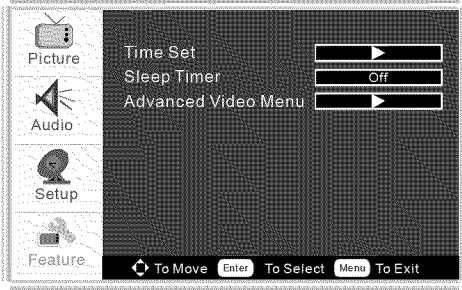

Time Set

Press **▼ / ▲** button and then use Enter the time set menu as below that allows you to set the time the TV will display.

Sleep Timer

Press **◀ / ▶** to select the amount of time before your TV turn off automatically and press the Enter that can select the 30 min /60min/90min and OFF.

Advance Video Menu

Press Enter to enter the advance video menu.

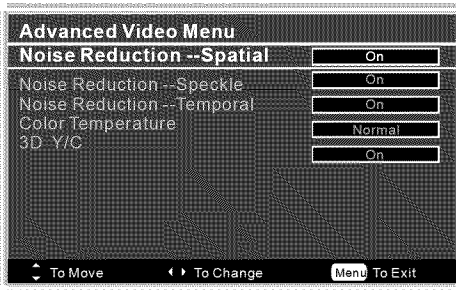

REMOTE CONTROL

Remote control instructions

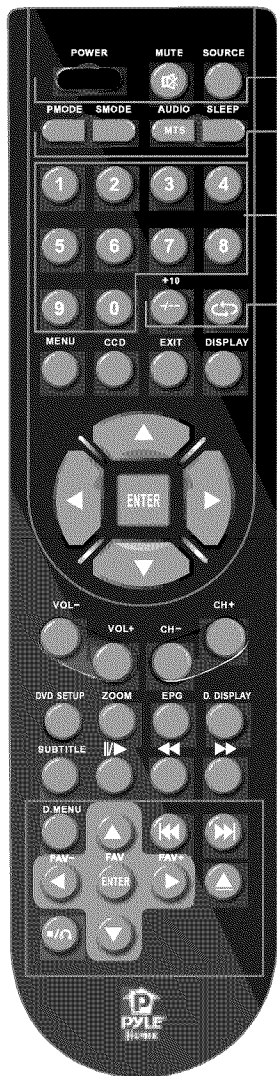

POWER

Switch on LCD TV when at standby mode or vice versa.

MUTE

Press to mute the sound. Press again or press VOL+ to unmute.

SOURCE

Press to cycle through the input source in following:

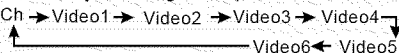

P.MODE

Press repeatedly to cycle through the available video picture modes.

S.MODE

Press to cycle through the different sound settings.

AUDIO (MTS)

Audio selection button.

SLEEP

Lets you select amount of time before your TV turn itself off automatically.

NUMBER BUTTONS

Press 0-9 to select a TV channel directly when you are watching TV. The channel change after 2 seconds.

-/--

Press this button to enter a program number for multiple program channel such as 2-1, etc.



Return to the previous channel viewed.

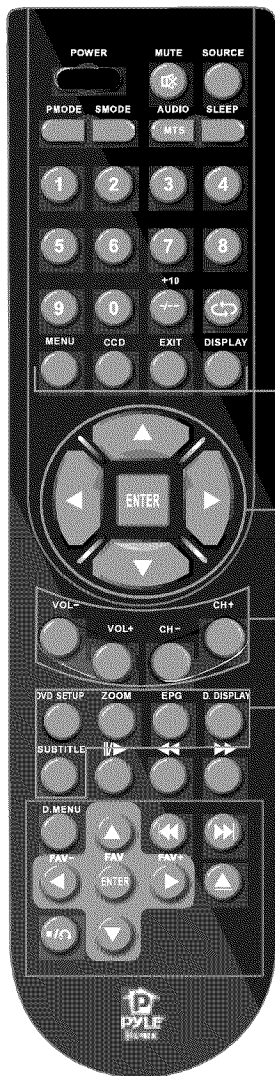

MENU

Brings up the main menu to the screen.

CCD

Closed caption button.

EXIT

Clears all on-screen displays and returns to TV viewing from any menu.

DISPLAY

Press to display the source and channel's information.

THUMBSTICK(▲ / ▼ / ◀ / ▶ / ENTER)

Allows you to navigate the on-screen menus and adjust the system settings to your preference.

CH+/-

Press to scan through channels. To scan quickly channels, press and hold down either +/-button.

VOL+/-

Press to increase / decrease the sound level.

DVD SETUP

Access to settings in DVD mode.

ZOOM

DVD ZOOM.

EPG

Display Electronic Program Guide.

D.DISPLAY

DVD DISPLAY

SUBTITLE

To display subtitle in DVD mode.

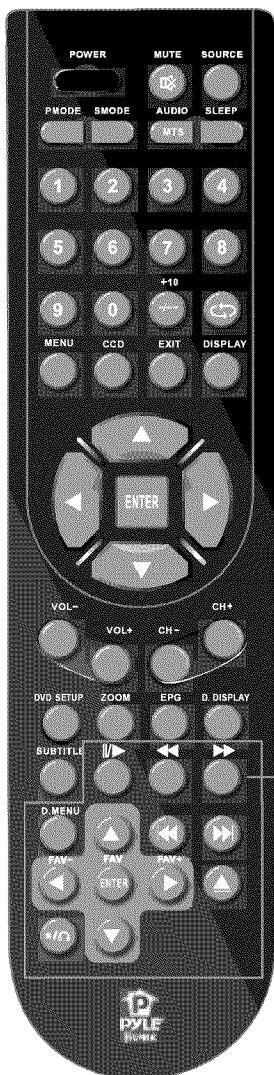

D.MENU

DVD MENU Access to menu in DVD Disc.



PLAY/PAUSE



Fast backward key.



Fast forward key.



Jump to previous track.



Jump to next track.

FAV+/FAV/FAV- (▲/▼/◀/▶/ENTER)

DVD THUMB STICK/OK.



DVD STOP



OPEN/CLOSE

Battery Usage Caution

- a) Open the cover
- b) AA size batteries, When inserting the batteries, make sure correct polarities as per "+" and "-" marks on the batteries and within the battery compartment
- c) Replace the battery cover

To prevent battery leakage which may result in bodily injury or damage to the remote:

1. Install all batteries correctly, and as marked on the remote control.
 2. Do not mix batteries: (OLD and NEW or CARBON and ALKALINE, etc)
- Remove batteries when the remote is not used for a long time.

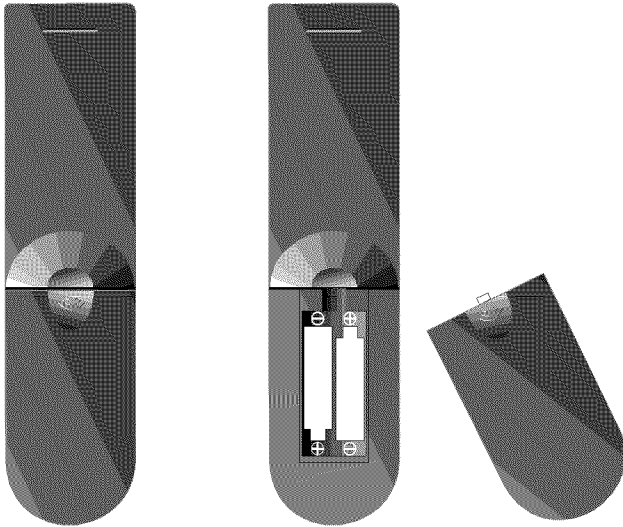

ACCESSORIES

- 1 Adapter Plug
- 2 One Remote Control
- 3 2 Batteries 1.5V
- 4 One User Manual

THE DVD SETUP MENU SYSTEM

8.1 Basic Operation

1. Press TV/DVD button on the remote controller or DVD button on the TV set to turn on (or off) DVD .
 2. Press OPEN / CLOSE button to load disc into disc tray.
 3. Press OPEN / CLOSE button to close the tray.
- Hold the disc without touching either of its surfaces, position it with the printed title side facing up, align it with the guides, and place it in its proper position.

8.2 DVD Setup Mode

- Setup Mode provides the menu for the configuration of General Setup Page, Speaker Setup Page, Dolby Digital, Setup, Video Setup Page and Preference Page .
- Item selection in the Setup Menu is done by using the Navigation Arrows, SETUP button and the OK button.
- Press the SETUP button first , enter into SETUP menu, then press the DIRECTION RIGHT button, you can enter into the next Sub-menu.
- Press the SETUP button again to exit the Setup Menu.

8.2.1 General Setup

TV Display

- PS

This is selected when the DVD player is connected to a normal TV. Wide-screen images are shown on the screen, but with some parts cut automatically.

- LB

This is selected when the player is connected to a normal TV. Wide-screen images are shown on the screen, with black belt on the top and bottom.

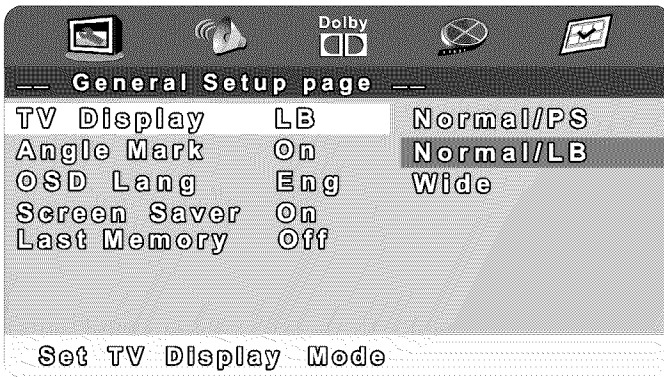

- Wide

This is selected when the player is connected to a wide-screen TV.

Angle Mark

This only works when there is an angle mark on the disc. Select ON, the screen shows the mark when playing DVD.

- ON
- OFF

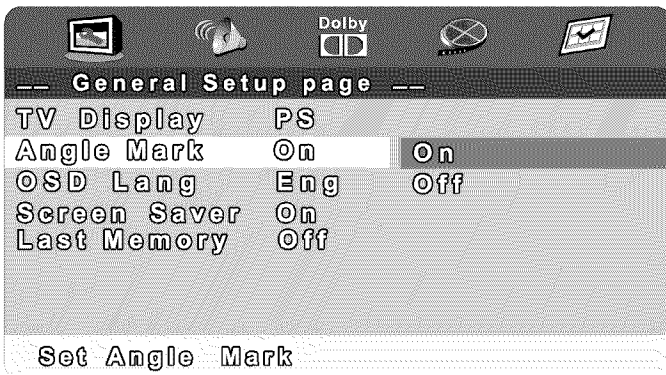

OSD Language

This is used to select the OSD language.

- English
- French
- Spanish

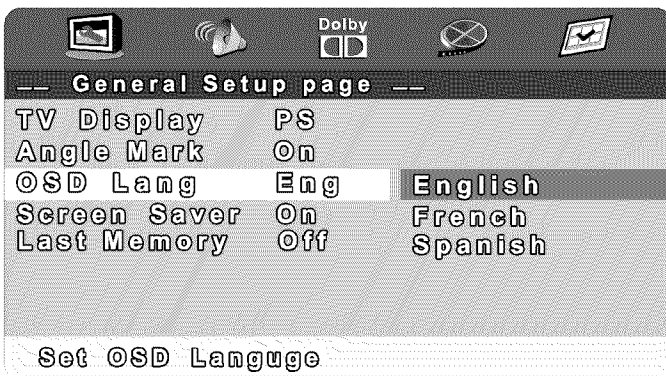

Screen Saver

Start the screen saver, the screen saver image will appear when the player stops or the picture is frozen for a few minutes. This saver can keep the screen from being damaged.

- On (Start the screen saver)
- Off (Remove the screen saver).

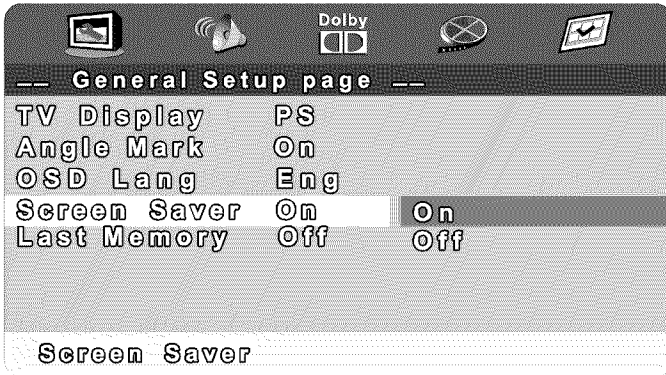

8.2.2 Speaker Setup Page

Downmix

- LT/RT

A disc recorded multi channel soundtrack, the output signal will be incorporated to left and right channel.

- Stereo

A disc recorded multi channel soundtrack, The output signal will be incorporated to stereo.

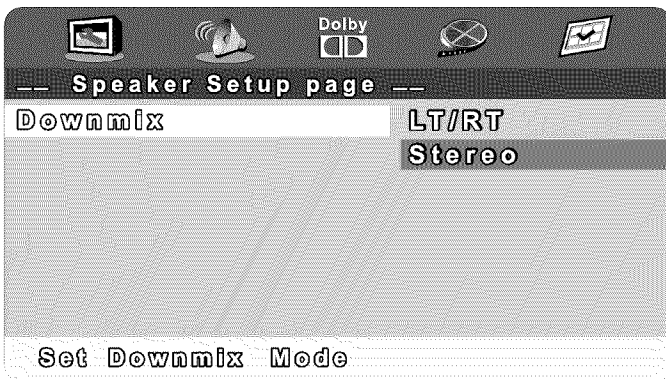

8.2.3 Dolby Digital Setup

Dual Mono

This is used to select the Stereo, L-MONO, R-MONO and MIX-MONO.



Dynamic

This option is used to set the compression ratio in order to control the sound (Vume) contrast.

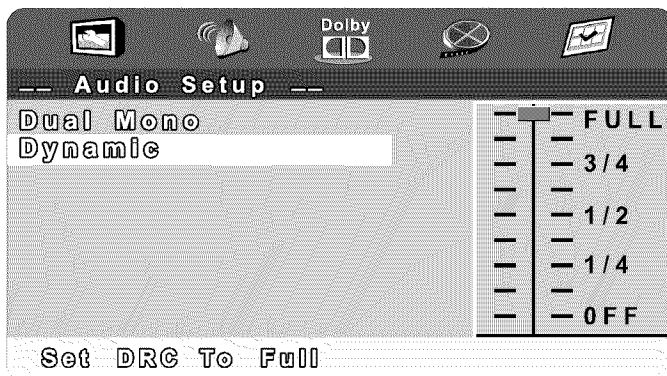

8.2.4 Video Setup

Sharpness

This option is used to set the sharpness level of the sharpness of the video output

- High
- Medium
- Low

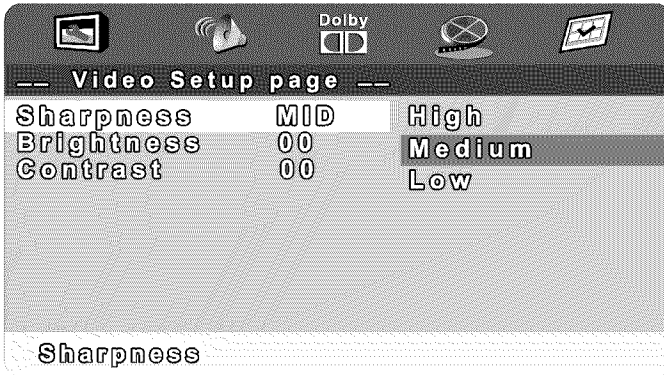

Brightness

User can set the level of brightness for the image displayed. is ranged from -20 to 20.

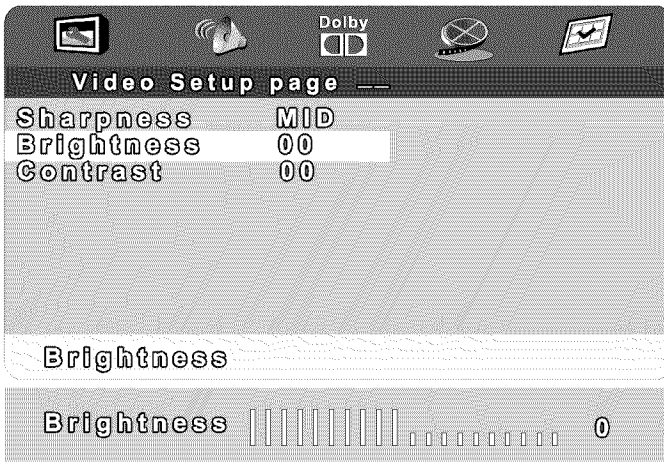

Contrast

User can set the level of contrast for the image displayed. It is ranged from -16 to 16.

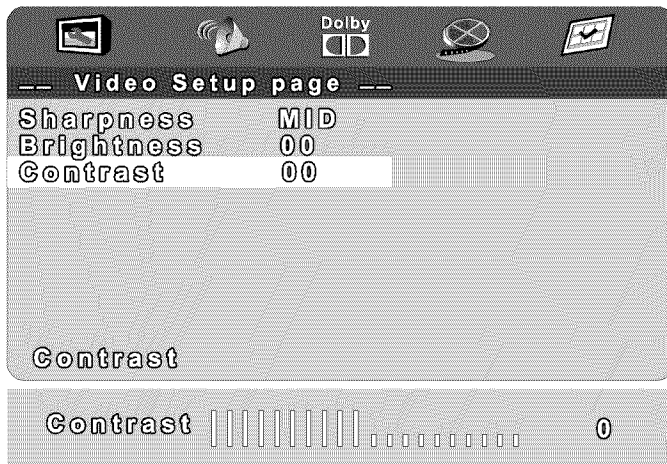

8.2.5 Preference Setup

You must press **STOP** twice to enter Preference Page

TV Type

- PAL

This is selected when the player is connected to an PAL System TV.

- MULTI

The player will set the TV system according to the disc in the tray.

- NTSC

This is selected when the player is connected to a NTSC System TV.

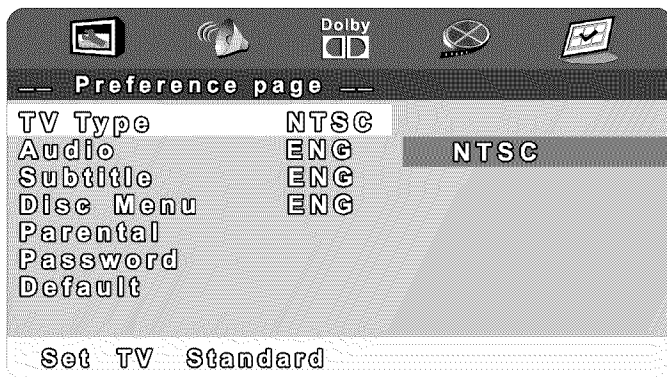

Audio

If a language listed below is recorded on the disc, you can play the sound in such language. If not, the language recorded will be used.

- English
- French
- Spanish
- Chinese
- Japanese
- German
- Duch
- Italian

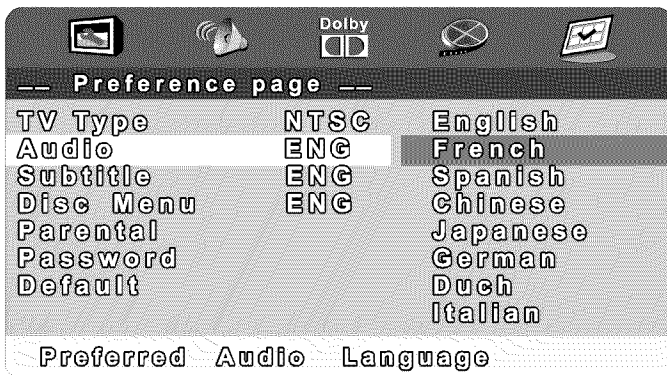

Subtitle

If a language listed below is recorded on the disc, you set the subtitle to be displayed in such language. If not, the language recorded will be used.

- English
- French
- Spanish
- Chinese
- Japanese
- German
- Duch
- Italian

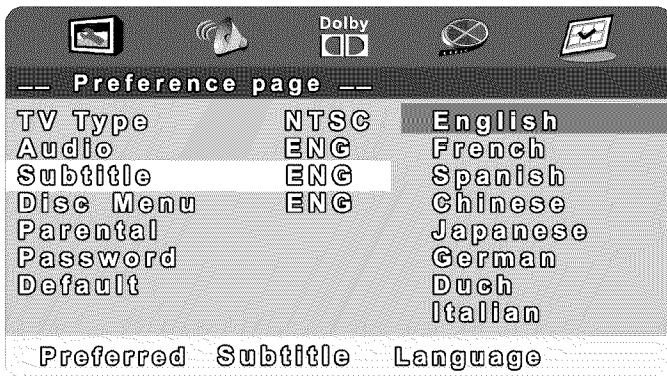

Disc Menu

If a language listed below is recorded on the disc, you can set the Menu to be displayed in such language. If not, the language recorded will be used.

- English
- French
- Spanish
- Chinese
- Japanese
- German
- Duch
- Italian

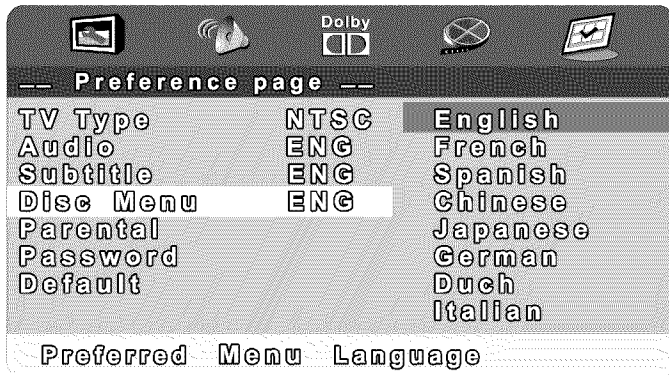

Parental

When playing disc with parental lock function, you may select an Age Control Grade according to grade of disc and your own preference. For example, if PG is selected, DVD Video disc rated higher than the PG grade cannot be played.

- KID SAFE
- G
- PG
- PG 13
- PGR
- R
- NC 17
- ADULT



Password

User can change the password that is required when the user wants to change the Age Control Grade in the Parental Lock function.

NOTE: (Default password is 3308)

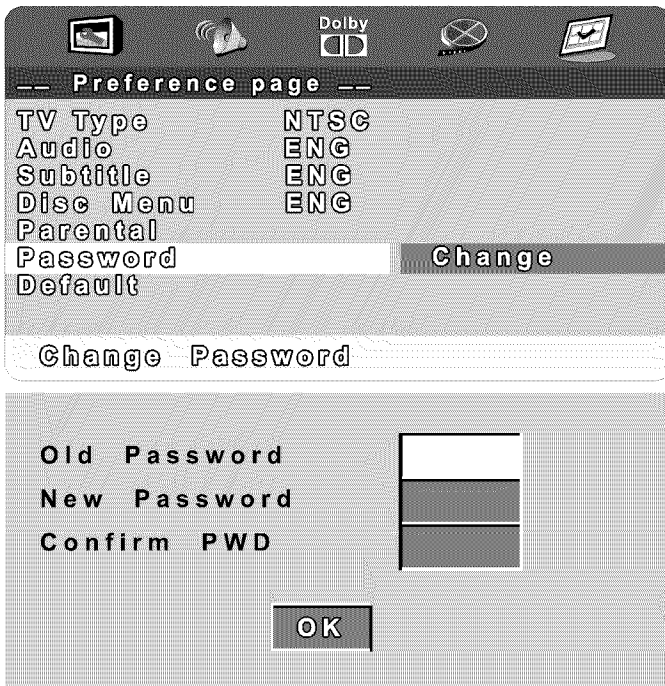

Default

User can load the original factory setting by choose RESET and press OK button .

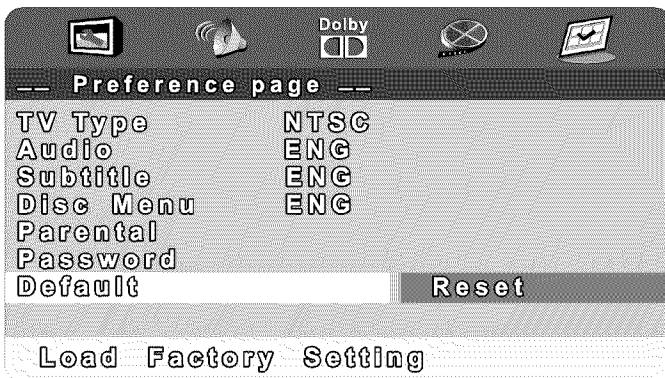

TROUBLESHOOTING AND ADVICE

Before calling our SAS centre, please check if you can solve the troubleshooting by yourself.

Troubleshooting	Control
No signal	Please check that all cables and cord's are correctly plugged in.
No color shades	Adjust the contrast, the color and the brightness
Stain show on the screen.	May be result from a lighting signal from car, motor, neon light and other electrical devices or appliances.
Double or multiple display image	May be the result of an electrical wave disturb from other TV, Computer and Game machine or Radio
Snow on the screen	The cables of the antenna are not correctly plugged in.
The remote control does not work	Please check the batteries order and alignment. Check that the IR of the remote control is not hidden by something.
"Zip" made noise on TV cover	Even if the display image is correct, the noise may come from an unsteady fixation of the panel.
No sound	Make sure that you have not press the MUTE button of the panel or of the remote control.
No DVD	Make sure if the TV Set have been switched to DVD mode
DVD player not working properly	Ensure disc is correctly inserted into the player. Ensure the disc does not damaged and with correct format. Please wait patiently as some discs need longer time to play.

SPECIFICATIONS

Screen Size		19 Inch
Display Type		TFT LCD
Resolution(Pixel)		1440 * 900
Brightness		400cd/m ²
Color		16. 2M
Contrast Ratio		500 : 1
View Angle(H/V)		160°/135°
Aspect Ratio		16:10
AC INPUT		110V/120V Voltage Selectable
TV System		NTSC
Video Input Format		NTSC
Antenna Input		Standard antenna socket 75 Ω
Audio Output		L / R 10W*2
Input	Video	Video 1.0vp-p75 Ω ;RCA
	S-Video	Y:1.0Vp-p±3db C:0.3Vp-p±3db
	PC	640*480/60Hz 、 800*600/60Hz 、 1024*768/60Hz
	Audio (Videos-Video-PC)	R/L200mVrms (max3.0vp-p)20 ΩkRCA
Disc Physical Format		DVD/CD/VCD/MP3/JPEG/CD-R/CD-RW
DVD Video Output Format		NTSC
Video Decompression		MPEG-2 (ISO/IEC-13818),MPEG-1,JPEG
Weight		13.4 lbs
Dimensions (with stand)		19.5" W x 16.8" H x 2.8" D

This manual is only for your reference, any change to the design and specification will not be advised.