

**Handbook
for the
Palm VII™ Handheld**

Copyright

Copyright © 1998-2000 Palm, Inc. or its subsidiaries. All rights reserved. Graffiti, HotSync, iMessenger, Palm OS, PalmConnect, and PalmModem are registered trademarks, and the HotSync logo, Palm, the Palm logo, Palm VII, the Palm VII logo, and Palm.Net are trademarks of Palm, Inc. or its subsidiaries. Other product and brand names may be trademarks or registered trademarks of their respective owners.

Disclaimer and Limitation of Liability

Palm, Inc. and its subsidiaries assume no responsibility for any damage or loss resulting from the use of this handbook.

Palm, Inc. and its subsidiaries assume no responsibility for any loss or claims by third parties which may arise through the use of this software. Palm, Inc. and its subsidiaries assume no responsibility for any damage or loss caused by deletion of data as a result of malfunction, dead battery, or repairs. Be sure to make backup copies of all important data on other media to protect against data loss.

Important: Please read the End User Software License Agreement included with this product before using the accompanying software program(s). Using any part of the software indicates that you accept the terms of the End User Software License Agreement.

Palm™ Desktop organizer software

Palm™ Desktop organizer software is supplied on a CD-ROM disc. If you do not have access to a CD-ROM drive for your computer, you may download the Palm Desktop software from <http://www.palm.com>.

P/N: 406-1606
A/N: 423-1606

Contents

About This Book	1
------------------------------	---

Chapter 1: Introduction to Your Palm VII™ Handheld

Getting to know your Palm VII handheld.....	3
What is a Palm VII handheld?.....	3
System requirements	4
Palm VII components	5
Installing the batteries	9
Replacing batteries.....	9
Setting up your handheld and charging the transmitter	10
Upgrade information.....	10
Palm Desktop organizer software	12
Using your handheld with another PIM	14
Palm.Net wireless features	14
Tapping and typing.....	17
Tap with the stylus to get things done.....	17
Elements of the interface.....	18
Opening applications	19
Using menus	22
Four ways to enter data.....	24
Customizing your handheld	28

Chapter 2: Entering Data in Your Palm VII™ Handheld

Using Graffiti writing to enter data.....	31
Writing Graffiti characters	31
Graffiti tips	33
The Graffiti alphabet.....	34
Writing capital letters	35
Writing numbers	35
Graffiti numbers	36
Writing punctuation marks	36
Additional Graffiti punctuation.....	37
Writing symbols and extended characters	37
Writing accented characters	38
Accent strokes.....	38
Additional non-English characters.....	38
Navigation strokes.....	39
Graffiti ShortCuts.....	39
Using the onscreen keyboard.....	40
Using your computer keyboard.....	41
Importing data.....	41

Chapter 3: Managing Your Applications

Using the Applications Launcher	43
Selecting applications.....	43
Switching between applications.....	43
Categorizing applications.....	43
Changing the Applications Launcher display.....	44
Choosing preferences.....	45
Installing and removing applications.....	46
Installing add-on applications	46
Installing games	48
Removing applications	49
Removing Palm Desktop software.....	50
Security.....	50
Assigning a password.....	50
Changing or deleting a password	51
Locking your handheld	52
Recovering from a forgotten password.....	53

Chapter 4: Using Your Basic Applications

Overview of basic applications	56
Date Book.....	56
Address Book	57
To Do List.....	58
Memo Pad.....	59
Calculator.....	59
Expense	60
Common tasks	61
Creating records.....	61
Editing records.....	61
Deleting records.....	63
Purging records.....	64
Exchanging and updating data: HotSync operations	65
Categorizing records.....	67
Finding records.....	71
Sorting lists of records.....	75
Making records private.....	76
Attaching notes.....	78
Choosing fonts	79
Application-specific tasks	81
Date Book.....	81
Address Book	95
To Do List.....	100
Memo Pad.....	105

Calculator	108
Expense.....	110

Chapter 5: Web Clipping Applications and the iMessenger® Application

Your handheld is a wireless device	121
Web clipping applications	121
Wireless Internet messaging: the iMessenger application	124
The Palm.Net wireless communication service.....	124
Improving signal strength	127
Using web clipping applications	129
Opening web clipping applications	129
Working with web clipping applications	130
Web clipping application menus	136
Using the iMessenger application	137
The iMessenger application differs from the Mail application.....	137
Opening the iMessenger application	138
Checking for and viewing messages.....	139
Opening and reading messages.....	140
Creating messages.....	145
Rerouting replies to your messages	149
Adding a signature to your message	150
Sending messages	151
Editing an unsent message	152
Draft messages.....	153
Filing a message	154
Deleting messages.....	154
Removing a message from the Deleted folder.....	155
Purging deleted messages	155
Options for the iMessenger list screen	155
Your Palm.Net mailbox.....	157
The iMessenger application and HotSync operations	158
iMessenger menus	159

Chapter 6: Managing Desktop E-Mail and Beaming Information

Managing desktop E-Mail away from your desk	161
Setting up Mail on the desktop	162
Synchronizing Mail with your E-Mail application	164
Opening the Mail application on your handheld.....	164
Viewing e-mail items	164
Creating e-mail items.....	165
Looking up an address.....	168
Adding details to e-mail items	169
Storing e-mail to be sent later	172

Editing unsent e-mail.....	173
Draft e-mail.....	174
Filing e-mail.....	175
Deleting e-mail.....	175
Removing e-mail from the Deleted folder	175
Purging deleted e-mail.....	176
Message list options	176
HotSync options.....	178
Creating special filters	179
Truncating e-mail items.....	183
Mail menus.....	183
Beaming information	185

Chapter 7: Advanced HotSync® Operations

Selecting HotSync setup options.....	189
Customizing HotSync application settings	191
IR HotSync operations.....	193
Preparing your computer for infrared communication.....	193
Configuring HotSync Manager for infrared communication	196
Performing an IR HotSync operation	197
Returning to cradle HotSync operations.....	197
Conducting a HotSync operation via modem.....	198
Preparing your computer.....	198
Preparing your handheld	200
Selecting the conduits for a modem HotSync operation	201
Performing a HotSync operation via a modem.....	202
Conducting a HotSync operation via a network	203
Connecting to your company's dial-in server	203
Performing a network HotSync operation.....	206
Using File Link.....	206
Creating a user profile	207

Chapter 8: Setting Preferences for Your Handheld

Viewing preferences.....	210
Buttons preferences	210
Pen preferences	211
HotSync buttons preferences	212
Digitizer preferences	213
Formats preferences	213
Country default.....	213
Time, date, week start, and numbers formats	214
General preferences.....	214
Auto-off delay	214
System, alarm, and game sounds.....	215

Beam Receive	215
Connection preferences.....	216
Sample connection for remote IR HotSync operations.....	217
Network preferences and TCP/IP software	218
Selecting a service	219
Entering a user name	219
Entering a password	220
Selecting a connection	220
Adding telephone settings.....	221
Connecting to your service.....	223
Creating additional service templates	224
Adding detailed information to a service template	224
Login scripts.....	227
Creating a login script on your handheld	228
Plug-in applications	230
Deleting a service template.....	230
Network preferences menu commands.....	230
TCP/IP troubleshooting.....	231
Owner preferences.....	232
ShortCuts preferences	233
Creating a ShortCut	233
Editing a ShortCut	234
Deleting a ShortCut	234
Wireless preferences	234
Proxy	234
Sending ID or location information.....	235

Appendix A: Maintaining Your Handheld

Caring for your handheld	237
About the AAA batteries	238
Automatic recharging of the transmitter.....	239
Proper use of the antenna	241
Resetting your handheld.....	243
Performing a soft reset	243
Performing a hard reset.....	244

Appendix B: Frequently Asked Questions

Software installation problems	248
Operating problems.....	249
Tapping and writing problems	250
Wireless problems.....	251
Application problems.....	252
HotSync problems.....	253
Beaming problems	259

Password problems	260
Technical support and customer care.....	261

Appendix C: Creating a Custom Expense Report

About mapping tables	263
Customizing existing sample templates	264
Determining the layout of the Expense Report.....	265
Labels.....	265
Sections.....	266
Analyzing your custom Expense Report	267
Programming the mapping table	268
Using applications other than Microsoft Excel	272
Expense file details	273

Appendix D: Non-ASCII Characters for Login Scripts

Use of ^char	275
Carriage return and line feed.....	275
Literal characters	276

Palm.Net™ Service Agreement and Other Product Information

Palm.Net service agreement	277
Product regulatory information	285
FCC Statement.....	285
Battery Warning.....	286

Index	289
--------------------	-----

About This Book

Welcome to the Palm VII™ handheld. This handbook is designed to help you get up and running quickly on your handheld. It describes all you need to know about how to use handhelds in the Palm VII product series and the applications that come with them.

It walks you through:

- Locating all the parts of your handheld
- Viewing and entering data
- Using the Palm VII wireless features
- Using your handheld with your computer
- Personalizing your handheld with your own preference settings

After you become familiar with the basic functionality of your handheld, you can use the rest of this handbook as a reference for less common tasks, for maintaining your handheld, and also as a source of information if you have problems operating it.

Chapter 1

Introduction to Your Palm VII™ Handheld

This chapter explains the physical buttons and controls on your Palm VII™ handheld, how to set up your handheld and charge the transmitter, how to use your handheld for the first time, and how to use HotSync® technology to synchronize your handheld and Palm™ Desktop organizer software. This chapter also introduces the Palm.Net™ wireless communication service and the wireless features of the Palm VII handheld.

Getting to know your Palm VII handheld

What is a Palm VII handheld?

With your Palm VII handheld you will no longer have trouble getting to meetings and appointments on time, remembering people's names and personal details, or tracking all the items on your To Do list. Your handheld can help you improve your track record in all these areas, both at work and at home.

You can enter all your schedule details in Date Book so you can view them by the day, week, or month, and you also have an agenda view for displaying current events and To Do items at the same time. Keep all your contact names, addresses, phone numbers, and other details in Address Book, so you can find them as soon as you need them. Add your tasks to To Do List, prioritize them so you don't overlook them, and assign them a due date.

You can easily connect your Palm VII handheld to the Internet, without using a wire or an external modem, through a wireless communication service maintained by Palm, Inc. Using web clipping applications, you can access a wide spectrum of information available on the Internet and view that information in a format that is easy to read on your handheld screen. Another application, the iMessenger® application, gives you an Internet messaging address; so you can use your handheld to stay connected by wireless Internet messaging anytime, anywhere within the coverage area of the wireless communication service.

To make sure you don't lose any important information, you can synchronize your data with Palm Desktop software on your computer so you always have a backup copy. You can set different security levels for your handheld so unauthorized eyes cannot view your data.

When you are out of the office, track your expenses for your expense reports; then transfer the data to your computer to print it out. You can write, edit, and view your e-mail, and then synchronize your e-mail with your desktop E-Mail application when you return to your office.

System requirements

To install and operate Palm Desktop software, your computer system must meet the following requirements:

Minimum requirements

- IBM-compatible 486 computer or higher
- One of the following:
 - Windows 95/98 and 8 MB RAM (memory),
 - Windows NT 4.0 and 16 MB RAM,
 - Windows 2000 and 64 MB RAM
- 20 MB available hard disk space
- VGA monitor or better
- CD-ROM drive (you can also download Palm Desktop software from <http://www.palm.net>)
- Mouse
- One available serial port or USB port (PalmConnect® USB Kit sold separately)

See “Activating the Palm.Net wireless communication service” later in this chapter for requirements to activate the service.

Optional equipment

- PalmModem® accessory
- Windows-compatible printer
- Infrared communication device

Macintosh compatibility

You can connect your Palm VII handheld to your Macintosh using the PalmConnect® Serial Kit or PalmConnect USB Kit (sold separately). For more information about Macintosh compatibility, visit the web site <http://www.palm.com>.

Palm VII components

Locating front panel controls

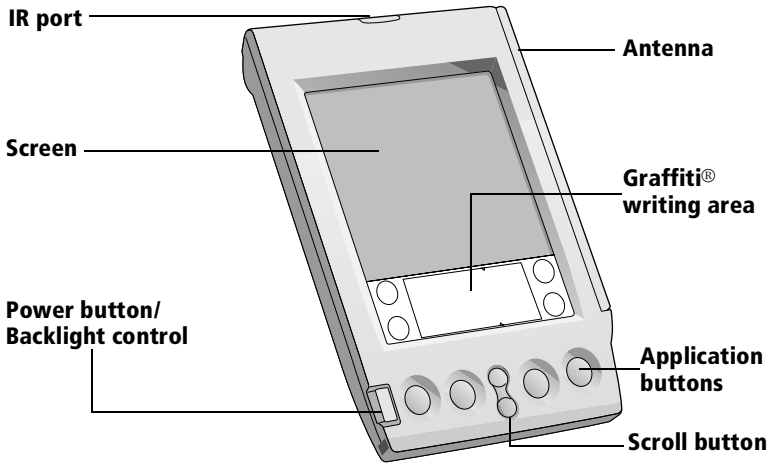

IR port Uses infrared technology to transmit data to and receive data from other Palm OS® handhelds, and to perform HotSync operations. See “Beaming information” in Chapter 6 and “IR HotSync operations” in Chapter 7 for more information.

Screen Displays the applications and information stored in your handheld. It is touch-sensitive and responds to the stylus.

Power button/ Backlight control Turns your handheld on or off and controls the backlight feature. If your handheld is turned off, pressing the power button turns your handheld on and returns you to the last screen you viewed. Press the power button to turn your handheld off.

If you have difficulty seeing the information onscreen, use the backlight to illuminate the screen. Press the power button and hold it down for about two seconds to turn the backlight on or off. The backlight turns off automatically (after a period of inactivity) with the Auto-off feature. See “General preferences” in Chapter 8 for more information. You can assign the full-screen pen stroke to activate the backlight. See “Pen preferences” in Chapter 8 for more information.

Antenna Gives you access to the Palm.Net service. See Chapter 5 for more information. See “Buttons preferences” in Chapter 8 to learn how to open a specific application when you raise the antenna.

Whenever you use the wireless features of your handheld, please observe the guidelines or prohibitions on the use of wireless devices in your current location. For example, when you are on an airplane, do not raise the antenna or use the wireless features at times when the Federal Aviation Administration (FAA) or airline regulations prohibit the use of cellular phones. You can, of course, use all other applications of your handheld in accordance with airline regulations for electronic devices.

Graffiti® writing area The area where you write letters and numbers using the Graffiti® alphabet. See Chapter 2 to learn how to write Graffiti characters.

Application buttons Opens the individual handheld applications that correspond to the icons on the buttons: Date Book, Address Book, To Do List, and Memo Pad. See “Buttons preferences” in Chapter 8 for details on reassigning these buttons to activate any application on your handheld.

Tip: If your handheld is turned off, pressing any application button activates your handheld and opens the corresponding application.

Scroll button Displays text and other information that extends beyond the area of the handheld screen. Pressing the lower half of the scroll button scrolls down to view information below the viewing area, and pressing the upper half of the button scrolls up to view the information above the viewing area.

Locating back panel components

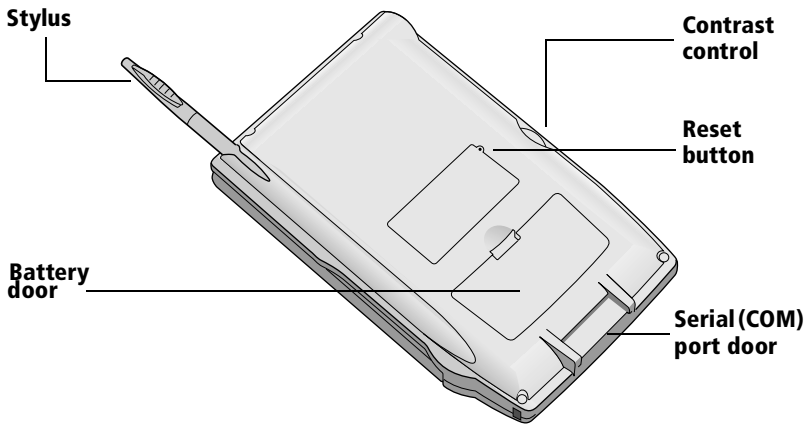

Stylus Slides in and out of the slot in the back panel of the handheld. To use the stylus, remove it from the slot and hold it as you would a pen or pencil. Unscrew the top of the stylus to access the reset tool.

Battery door Covers the AAA batteries that power your handheld and charge the transmitter. See “Installing the batteries” later in this chapter for information on removing the battery door and installing batteries.

Contrast control Adjusts the appearance of the screen for the clearest screen display. Depending on the lighting conditions or temperature of the environment where you use your handheld, you may need to adjust the setting of the contrast control.

Reset button Under normal use, you should not have to use the reset button. See Appendix A for information about when and how to use the reset button.

Serial (COM) port door

Protects the serial port that fits into the connector of the handheld cradle. The door ensures that the connection surface of the serial port remains clean and clear of debris.

Note: When your handheld is in the cradle, and the cradle is connected to your computer, you can use HotSync technology to do a two-way exchange of the data on your handheld and your computer. Plug the connector of the cradle into the serial (COM) port, as shown in the following illustration.

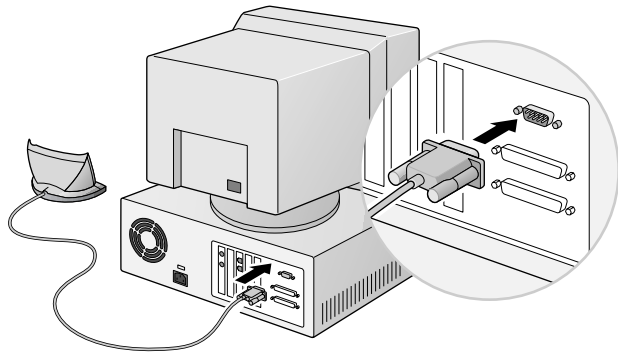

Important: Your handheld requires a dedicated port. It cannot share a port with an internal modem or other device. If you are unsure about the location of the serial port on your computer, refer to your computer's documentation.

Installing the batteries

To use your handheld, you must install two AAA alkaline batteries. The batteries fit behind the battery door on the back of your handheld.

To install the batteries:

1. Press the tab on the battery door and lift the battery door away from your handheld.

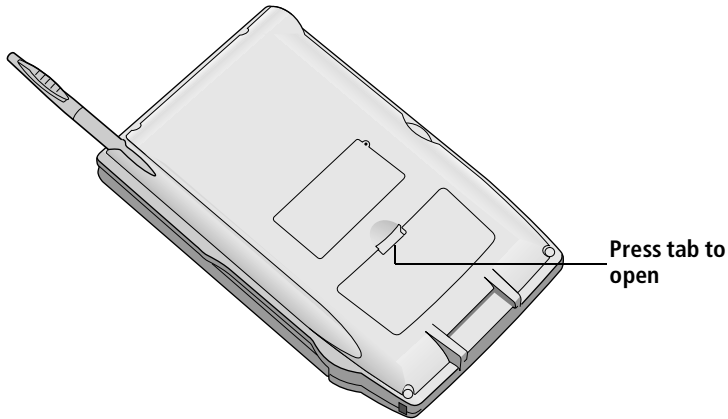

2. Install the two AAA alkaline batteries supplied with your handheld into the battery compartment.

Note: A diagram in the interior of the battery compartment shows the orientation of the positive (+) and negative (-) ends of the batteries. When correctly installed, the clips in the battery compartment secure the batteries in place.

3. Insert the battery door back into place so that it is flush with the back of your handheld and “clicks” into position.

Important: Do not force the battery door. When the batteries are correctly installed, the battery door clips smoothly into place. If you feel resistance when replacing the battery door, make sure the door is aligned with the slots on the back of your handheld, and that the batteries are firmly seated in the battery compartment.

Replacing batteries

Under normal conditions, depending on your usage pattern, the AAA batteries of your handheld should provide weeks of use. When the time comes to replace the AAA batteries, your handheld gives you ample warning.

When you replace the AAA batteries, keep these points in mind:

- Before you replace the batteries, perform a HotSync operation so that you have a backup copy of all your data on your computer.
- When you remove the old batteries, the built-in backup power of your handheld maintains memory data. Whenever you remove the batteries, replace them immediately. We recommend replacing batteries within a **period of one minute**. If you encounter any difficulties or delays while you're replacing the batteries, reinstall the original batteries and wait a few minutes for the backup power to recharge.
- When you dispose of the AAA batteries, please dispose of them without damaging the environment.

Setting up your handheld and charging the transmitter

The first time you insert the AAA batteries, your handheld automatically begins two processes:

- The batteries begin to charge the transmitter you use with the wireless communication service. **This takes about 70 minutes.** As soon as the transmitter has been charged, you can activate the service. See "Activating the Palm.Net wireless communication service" later in this chapter.
- Your handheld turns on automatically and Setup begins. Setup consists of a short series of screens that you complete to prepare your handheld for use. Setup also lists the web clipping applications that are preloaded on your handheld. To complete Setup, follow the instructions onscreen.

As soon as you finish Setup, you can use all the basic applications of your handheld. See Chapter 4 for the list of your basic applications.

Upgrade information

If you already own a Palm OS handheld, we recommend that you install the version of Palm Desktop software that comes with your new Palm VII handheld into the same folder as your current Palm Desktop software. When you install the new version in the same folder as the previous version, all your data is preserved. If you use another personal information manager (PIM), you still need to install Palm Desktop software to add HotSync Manager, conduit software, and other features of Palm Desktop software to your computer.

You perform HotSync operations in exactly the same way, so you can quickly synchronize your old data with your new handheld.

To upgrade:

1. Read the *Getting Started* guide for an overview of the complete installation process.
2. Synchronize your old handheld with your old Palm Desktop software. This ensures that the latest information from your handheld is on your desktop computer.
3. (Optional) To ensure against any data loss, go to the folder that stores Palm Desktop software, copy the folder and all its contents, rename it (for example, Palm Backup), and store the copy outside the Palm Desktop software folder.
4. Follow the installation instructions in “Installing Palm Desktop software” later in this chapter. Be sure to install the new software in the same folder as the old software.
5. To prepare for the first HotSync operation that synchronizes your new handheld with your new Palm Desktop software, go to the HotSync Manager and choose Custom.

Note: Be sure your username appears in the box at the top of the Custom dialog box. If not, select your username.

6. For all conduits, click Change and select the option Desktop overwrites handheld. Then click Done. See “Customizing HotSync application settings” in Chapter 7 for more information.
7. Place your new handheld in the cradle and press the HotSync button. If the Select User dialog box appears, select your username.

Note: If you customized the modem setup on your old handheld, you must re-enter the modem initialization string. See “Connection preferences” in Chapter 8 for more information.

Any passwords you set on your old handheld are not restored during this HotSync operation. Records you previously marked Private are still marked Private, but you need to reenter a password on your new handheld.

8. Return to the *Getting Started* guide and complete the activation of your handheld.

Each handheld must have a unique name

After you finish the upgrade process described above, you have two handhelds with the same name. This is an undesirable situation. Each handheld must have a unique name in order to prevent unexpected results during HotSync operations and other complications.

We strongly recommend that you perform a hard reset on your old handheld. See “Performing a hard reset” in Appendix A for details.

A hard reset not only erases all data from the old handheld; it also erases the name and makes that handheld a clean slate, ready to receive a new name. The next time you perform a HotSync operation with this old handheld, you are asked to give it a name. Be sure to give it a unique name.

Palm Desktop organizer software

Palm Desktop software extends many of the functions of your handheld to your computer and serves to back up all your data. Viewing and editing your data using Palm Desktop software is optional. However, when you use it with your handheld and the built-in HotSync technology, you can fully synchronize the information on your handheld with the information on your computer.

It is a good idea to back up your data in case something happens to the data on your handheld. Changes you make on your handheld or Palm Desktop software appear in both places after you synchronize.

With Palm Desktop software, you can do the following:

- Work with your handheld applications on your computer. Palm Desktop software duplicates the Date Book, Address Book, To Do List, and Memo Pad applications on your handheld, so you can view, enter, and modify any data stored on your handheld.
- Back up the data stored on your handheld with HotSync technology and synchronize the data on your Palm Desktop software. Synchronization is a one-step procedure that ensures your data is always safe and up-to-date. See “Exchanging and updating data: HotSync operations” in Chapter 4 for more information.
- Import and export data. See “Importing data” in Chapter 2 for more information.
- Print your Date Book, Address Book, To Do List, and Memo Pad information on any printer.

Installing Palm Desktop software

The following instructions guide you through installing Palm Desktop software. After installation, refer to the online Help in Palm Desktop software for information about how to use the software.

To ensure a safe and uninterrupted installation of Palm Desktop software, please do the following before installing:

- Turn off your computer and connect the cradle to it. **Do not** put the handheld in the cradle yet; you do that later in the process.
- Do *not* simply copy the Palm Desktop software files to your computer's hard disk. You must use the installation software to place the files in their proper locations and to decompress the files.

To install Palm Desktop software:

1. Exit any open programs, including those that run automatically at startup. Disable any virus-scanning software.
2. Insert the Palm Desktop software CD-ROM into the computer's CD-ROM drive.
3. When the Palm Desktop Installer Menu appears, click the Install button to begin the installation procedure.
4. Follow the onscreen instructions to complete the installation. During installation you will be asked to insert your handheld into the cradle.

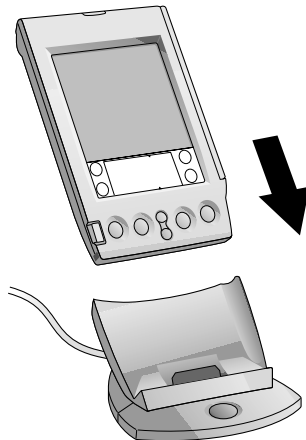

Using your handheld with another PIM

If you prefer to use another personal information manager (PIM), such as Microsoft Outlook, you still need to install Palm Desktop software in order to add HotSync Manager, connection software, and other features of Palm Desktop software to your computer. The connection software, called a conduit, lets you synchronize the data between your handheld and your PIM.

If the installation program detects that you have Microsoft Outlook on your computer, the program lets you choose between installing Palm Desktop software or installing the conduit for Outlook so that you can use that application as your PIM.

For information on the availability of conduit software for the PIM you use, contact the vendor of your PIM or visit the web site <http://www.palm.com>.

Palm.Net wireless features

Your handheld is equipped with a transmitter and an antenna that let you transmit and receive data over the airwaves. Palm, Inc. provides the Palm.Net wireless communication service, which you must subscribe to in order to gain access to wireless features.

After you activate the wireless communication service, the following wireless features become available to you:

- Web clipping, using web clipping applications
- Wireless Internet messaging, using the iMessenger application

Activating the Palm.Net wireless communication service

The transmitter inside your handheld contains a rechargeable battery that must be charged before you can activate the wireless communication service and use the wireless features. The AAA batteries that you install during Setup of your handheld charge the transmitter, and charging begins as soon as you insert the batteries. Charging takes about 70 minutes.

Before you activate the Palm.Net service, be sure of the following:

- You're within coverage of the network. To find detailed maps of coverage, visit the web site <http://www.palm.net>.
- You're in a location that can receive a strong radio signal. See "Wireless problems" in Appendix B for tips on eliminating obstacles to the signal.

To activate the Palm.Net service:

1. Read the brochure, *Choosing a Palm.Net Service Plan*, included in the handheld package, describing the monthly service plans. Decide on a plan. (You can switch plans at any time.)
2. Prepare to enter the following information: your name, firm, billing address, phone number, current desktop e-mail address, choice of service plan, and credit card information (or corporate account number).

During activation you are also asked to create a username and a password. You can accept one of the usernames suggested by the Activate application or create your own; it must be at least 3 characters long. Your password must be 4 to 15 characters long.

3. Read the Palm.Net service agreement, located at the back of this book.
4. After the transmitter finishes charging, raise the antenna on the right side of your handheld by gently rotating it upwards.

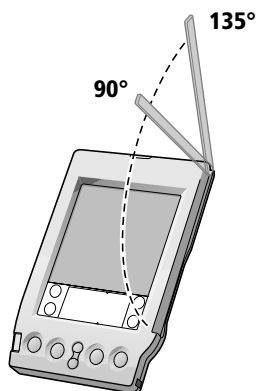

To ensure the best reception: If you are holding the handheld in your hand, raise the antenna to its position at 135°, located at the second click you feel as you raise the antenna. If the handheld is on a flat surface, raise the antenna to its position at 90°.

5. Follow the instructions onscreen to activate the wireless communication service.

Important: Be sure to record and remember the username and password you create during activation. You need them both to access information about your usage of the service and your billing information. Your username is also part of your address on the Palm.Net network — for example, `username@palm.net`.

Web clipping

Your handheld includes special kinds of applications called *web clipping applications*. Web clipping applications take advantage of the wireless functionality of your handheld to give you access to information on the Internet.

Web clipping applications give you access to a wide spectrum of practical Internet information: news and business headlines, travel information, stock quotes, sports scores, restaurant reviews, movie times, and much more.

It's impractical, however, to browse the Internet from a small handheld computer and look at elaborate, animated, graphics-laden web pages on a screen the size of your handheld's. So instead of web browsing, web clipping applications offer you a more efficient way to access the Internet, called *web clipping*.

In general, web clipping is a simple process of query-and-response. You simply request information, tap a button that transmits your request to the Internet, and within seconds, you receive a response. See Chapter 5 for more information.

Wireless Internet messaging

Like web clipping, the iMessenger application takes advantage of the wireless functionality of your handheld to give you wireless Internet messaging. Your handheld, like a cellular phone, uses a radio frequency to transmit and receive information. Your handheld is part of the Palm.Net network, which receives and stores messages sent to you at your @palm.net address, and delivers messages you send from your handheld to the recipient's Internet e-mail address.

After you activate the wireless communication service, whenever you're within the coverage area, you can communicate with anyone who has an Internet e-mail account. See Chapter 5 for more information.

Tapping and typing

Tap with the stylus to get things done

Like using a mouse to click elements on a computer screen, using the stylus to tap elements on your handheld screen is the basic action that gets things done on your handheld.

The first time you start your handheld, setup instructions appear on the screen. These instructions include a calibration screen, or digitizer. Calibration aligns the internal circuitry of your handheld with its touch-sensitive screen so that when you tap an element on the screen, your handheld can detect exactly which task you want to perform.

Important: Always use the point of the stylus for tapping or making strokes on the handheld screen. Never use an actual pen, pencil, or other sharp object to write on the handheld screen.

With your handheld turned on, you can tap the handheld screen to do many operations, such as the following:

- Open applications
- Submit queries to the Internet
- Check for and send messages in the iMessenger application
- Choose menu commands
- Initiate a global Find operation
- Select options in dialog boxes
- Open the onscreen keyboard

Just as you can drag the mouse to select text or move objects on your computer, you can also drag the stylus to select text. You can also use the stylus to drag the slider of any scroll bar.



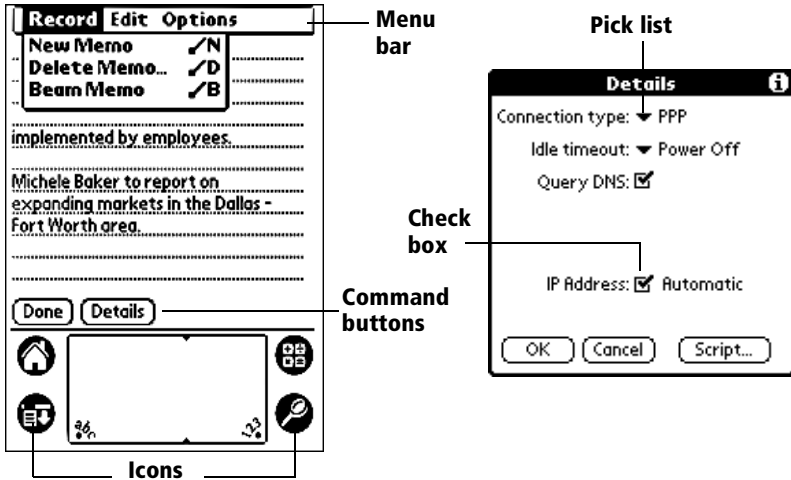

Elements of the interface

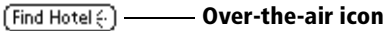

Menu bar A set of commands that are specific to the application. Not all applications have a menu bar.

Command buttons Tap a button to perform a command. Command buttons appear in dialog boxes and at the bottom of application screens. A command button that initiates a wireless transaction always displays the over-the-air icon:



Icons Tap the icons to open applications , menus , and Calculator , and to find text in the data of your basic applications .

abc With the cursor in an input field, tap the dot to activate the alphabetic keyboard.

123 With the cursor in an input field, tap the dot to activate the numeric keyboard.

Check box When a check mark appears in a check box, the corresponding option is active. If a check box is empty, tapping it inserts a check mark. If a check box is checked, tapping it removes the check mark.

Pick list Tap the arrow to display a list of choices, and then tap an item in the list to select it.

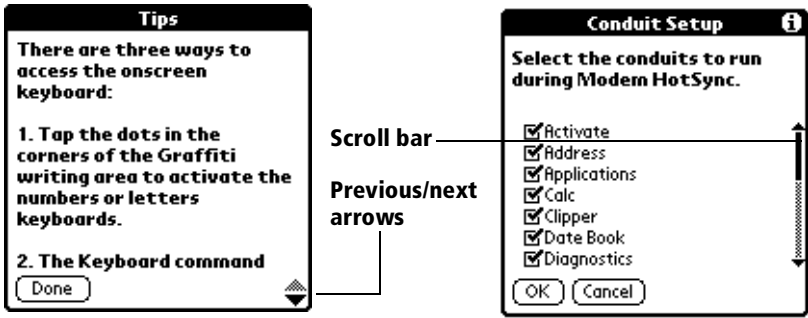

Scroll bar Drag the slider, or tap the top or bottom arrow, to scroll the display one line at a time. To scroll to the previous page, tap the scroll bar just above the slider. To scroll to the next page, tap the scroll bar just below the slider.

You can also scroll to the previous and next pages by pressing the upper and lower portions of the scroll button on the front panel of your handheld.

Previous/next arrows Tap the up and down arrows to display the previous and next page of information; tap the left and right arrows to display the previous and next record.

Opening applications

You can use the Applications Launcher to open any application installed on your handheld. You can also open the four main applications — Date Book, Address Book, To Do List, and Memo Pad — with the application buttons on the front panel of your handheld.

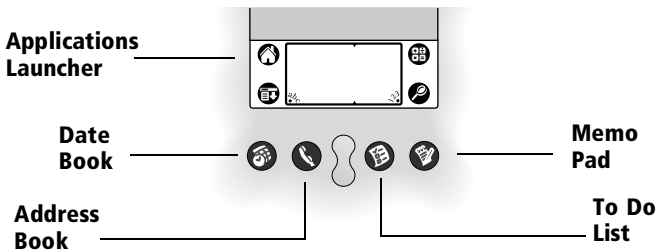

Tip: When you press an application button on the front panel, you have instant access to the selected application. You don't even need to turn on your handheld first.

In addition to providing a way for you to open applications, the Applications Launcher displays the current time, battery level, and application category.

To open an application:

1. Tap the Applications icon .
2. Tap the icon of the application that you want to open. If you have many applications installed on your handheld, tap the scroll bar to see all of your applications.



Tip: To find an application quickly, you can write the Graffiti character for the first letter of its name. The Applications Launcher scrolls to the first application with a name that begins with that letter. You can also assign applications to different categories. See “Categorizing applications” in Chapter 3.

To open an application that uses the antenna:

These applications use the antenna:

- All web clipping applications
 - iMessenger application
 - Applications that support your use of the wireless features
1. Raise the antenna, located on the right side of your handheld.

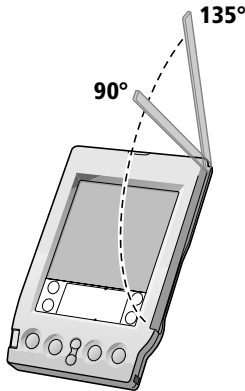

To ensure the best reception: If you are holding the handheld in your hand, raise the antenna to its position at 135°, located at the second click you feel as you raise the antenna. If the handheld is on a flat surface, raise the antenna to its position at 90°.

Raising the antenna automatically opens the Applications Launcher to the Palm.Net category. When the transmitter successfully connects to the network, your handheld beeps.

2. Tap the web clipping application that queries the Internet for the kind of information you want.

Tip: You can set your handheld to open a specific application whenever you raise the antenna. See “Buttons preferences” in Chapter 8 for details.

When you install web clipping applications, they appear by default in the Palm.Net category of the Applications Launcher. The icons of web clipping applications and all applications that use the antenna are easy to recognize: They all have a dark diamond shape as their background and include the over-the-air icon:

◆ **Background of all web clipping application icons**



Sample web clipping application icon

Feel free to explore all your web clipping applications to find out what kind of information they offer. Despite the presence of the over-the-air symbol in its icon, you can open any web clipping application without incurring any cost.

Using menus

Menus on your handheld are easy to use. Once you master them in one application, you can use them the same way in all other applications. The menus of each application are illustrated in the section on that application in Chapter 4. The Edit menu is described in “Editing records” in Chapter 4.

To open the menu bar:

1. Open an application (such as Memo Pad).
2. Do one of the following:
 - Tap the Menu icon .
 - Tap the inverted title area at the top of the screen.

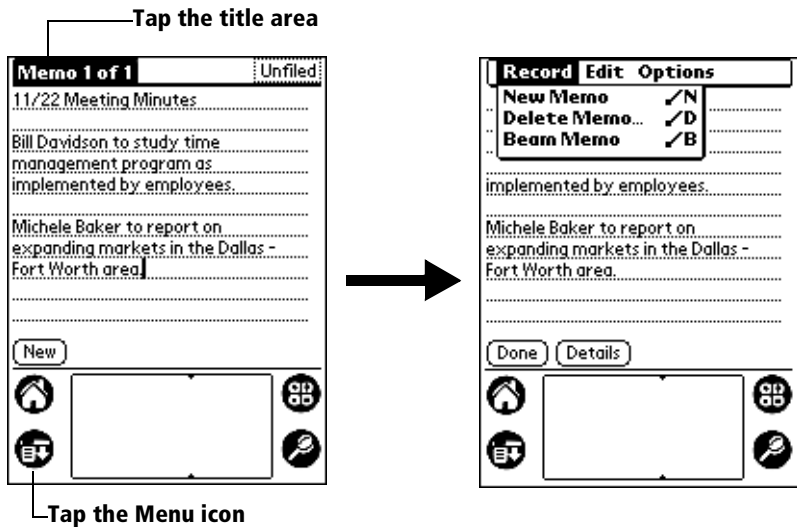

In this example, three menus are available: Record, Edit, and Options. The Record menu is selected and contains the commands New Memo, Delete Memo, and Beam Memo.

Choosing a menu

After you open the menu bar for an application, tap the menu that contains the command you want to use. The menus and menu commands that are available depend on the application that is currently open. Also, the menus and menu commands vary depending on *which part* of the application you're currently using. For example, in Memo Pad, the menus are different for the Memo list screen and the Memo screen.

Graffiti menu commands

Most menu commands have an equivalent Graffiti Command stroke, which is similar to the keyboard shortcuts used to execute commands on computers. The command letters appear to the right of the command names.



Draw the Command stroke anywhere in the Graffiti area. When you draw the Command stroke, the Command toolbar appears just above the Graffiti writing area to indicate that you are in Command mode.

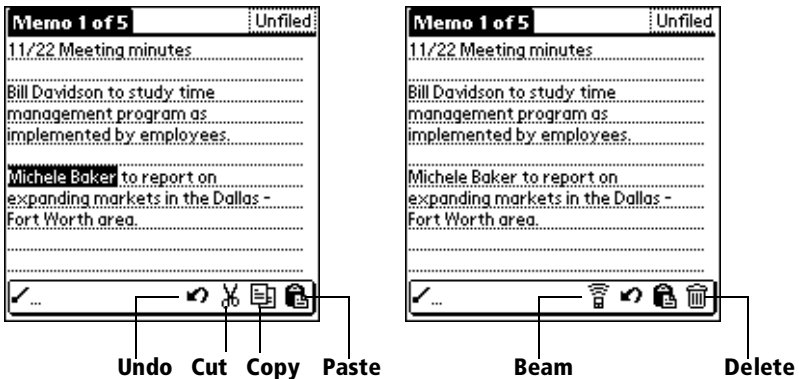
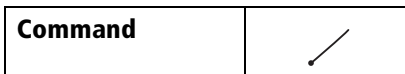

The command toolbar displays context sensitive menu commands for the current screen. For example, if you select text, the undo, cut, copy, and paste menu icons appear. Tap an icon to select the command, or immediately write the corresponding command letter in the Graffiti writing area. For example, to choose Copy in the Edit menu, draw the Command stroke, followed by the letter "c."

Note: Command mode is only active for a short time, so you must tap an icon or write the command letter immediately to choose the menu command. In web clipping applications, the command toolbar is available only when you select text or text in your handheld's memory is available to paste or undo.

Displaying online tips

Many of the dialog boxes that appear on your handheld contain a Tips icon in the upper-right corner. Online tips anticipate questions you have in a dialog box, provide shortcuts for using the dialog box, or give you other useful information.

To display an online tip:

1. Tap the Tips icon (i).
2. After you review the tip, tap Done.

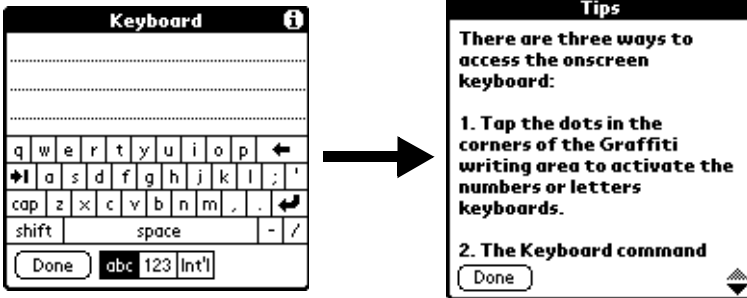

Four ways to enter data

There are four ways to enter data into your handheld:

- Using the onscreen keyboard
- Using Graffiti writing
- Entering or importing data in Palm Desktop software and then synchronizing with your handheld
- Using an external keyboard

Onscreen keyboard

When you create or edit a record in an application such as Address Book, you can open the onscreen alphabetic and numeric keyboards to enter data.

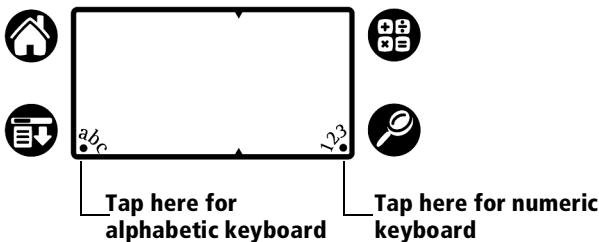

After a keyboard is open, you can tap to open any of the other keyboards, including the international keyboard. See “Using the onscreen keyboard” in Chapter 2 for more information.

Note: You cannot enter Graffiti characters while using the onscreen keyboard.

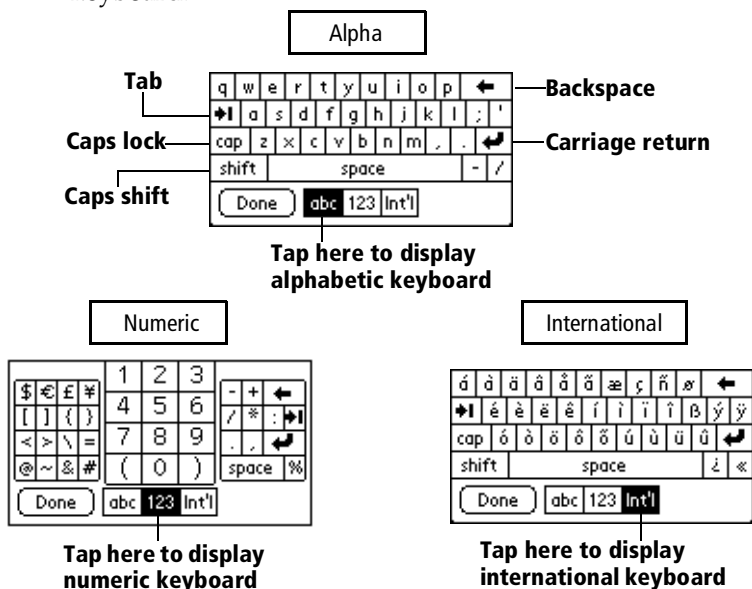

Graffiti writing

Your handheld includes Graffiti writing software as the primary system for entering text and numbers. With Graffiti writing, you write simple strokes with the stylus and they are instantly recognized as letters or numbers.

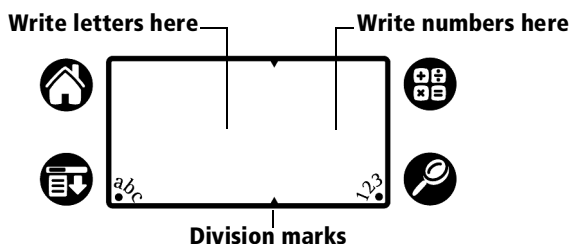

Your handheld also includes Giraffe, a game you can use to practice writing Graffiti characters. See “Installing and removing applications” in Chapter 3 for installation instructions. The Memo Pad application is ideal for practicing Graffiti writing. This section explains how to open Memo Pad and use it to practice Graffiti writing.

To open Memo Pad:

1. Press the Memo Pad application button .
2. Tap New.

Note: A blinking cursor appears on the first line of the new memo to indicate where new text will appear.

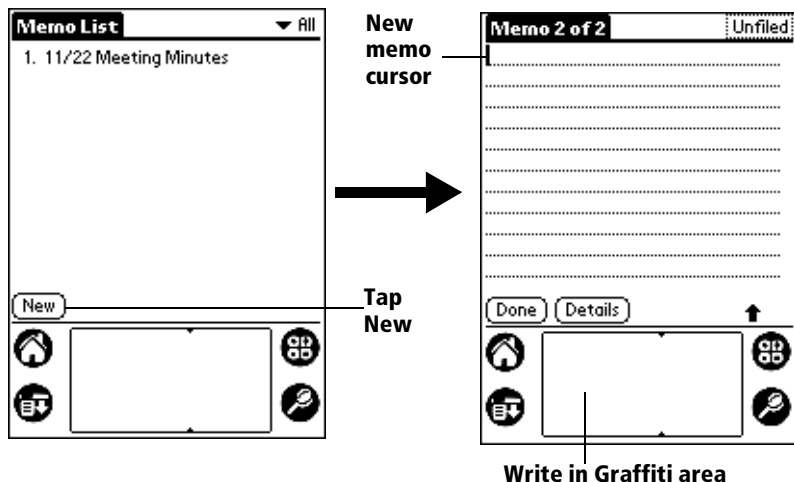

See “Using Graffiti writing to enter data” in Chapter 2 for more information.

Using Palm Desktop software

If you have new records you want to add to your handheld and prefer to use the computer keyboard rather than Graffiti writing or the onscreen keyboard, enter the data in the Palm Desktop software or the PIM you have installed to use with your handheld.

After the information is in Palm Desktop software, perform a HotSync operation to synchronize your handheld with your computer. See “Exchanging and updating data: HotSync operations” in Chapter 4 for more information.



Importing data

If you already have data in a database on your computer, you can import it into Palm Desktop software. You can import data stored in computer applications such as spreadsheets and databases, or from another Palm OS handheld. When you import data, you transfer the records to your handheld without having to enter them manually. See “Importing data” in Chapter 2 for more information.



External keyboard

You can connect an optional keyboard accessory to the serial connector on your handheld so you can type data directly into your handheld. External keyboards are very helpful when you need to enter large amounts of data quickly and accurately while you are away from your computer.

Customizing your handheld

You can customize your handheld by using the Preferences application. You can enter personal information such as your name and address; change the time and date; view different date and time formats when you travel; turn off sounds; and configure your handheld to work with a modem or network. See Chapter 8 for more information on customizing your handheld.

To open the Preferences screens:

1. Tap the Applications icon .
2. Tap the Preferences (Prefs) icon .
3. Tap the category pick list in the upper-right corner of the screen.
4. Tap the Preferences category you want to view.

The following procedures for setting the time and date give you an example of how to customize your handheld.

You make changes to the time and date in General preferences.

To set the current time:

1. Tap the Set Time box.

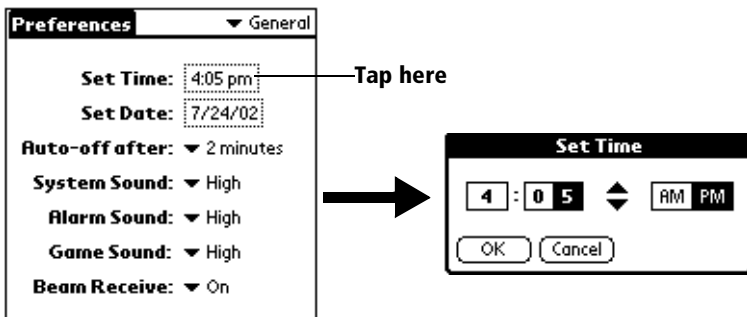

2. Tap the up or down arrows to change the hour.
3. Tap each number of the minute, and then tap the arrows to change them.
4. Tap AM or PM.

Note: Your handheld can also display time based on a 24-hour clock. See "Formats preferences" in Chapter 8 for more information.

5. Tap OK.

To set the current date:

1. Tap the Set Date box.
2. Tap the arrows to select the current year.

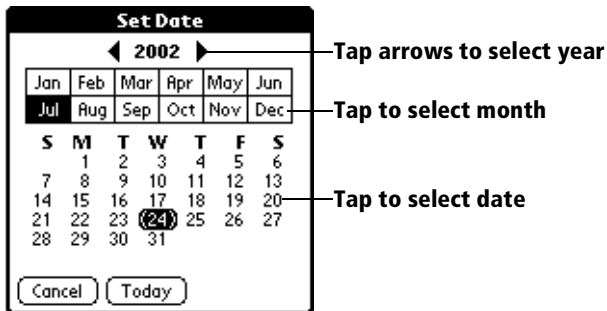

3. Tap a month.
4. Tap the current date.

Chapter 2

Entering Data in Your Palm VII™ Handheld

This chapter explains how to enter data into your Palm VII™ handheld, by writing with the stylus in the Graffiti® writing area, by using the onscreen keyboard, by using the computer keyboard, or by importing data from another application.

Using Graffiti writing to enter data

Chapter 1 introduced Graffiti writing and briefly described how to use it to enter text in your applications. In this section, you learn the procedures for creating letters, numbers, punctuation, and symbols, as well as some Graffiti tips and tricks.

Writing Graffiti characters

Most people find they can enter text quickly and accurately with only minutes of practice. Graffiti writing includes any character you can type on a standard keyboard. The Graffiti strokes closely resemble the uppercase letters of the regular alphabet, which makes Graffiti writing easy to learn.

There are four basic concepts for success with Graffiti writing:

- If you draw the character shape exactly as shown in the tables later in this chapter (like the shapes shown in the following diagram), you achieve 100% accuracy.



- The heavy dot on each shape shows where to begin the stroke. Certain characters have similar shapes, but different beginning and end points. Always begin the stroke at the heavy dot (you should not create the heavy dot; it is only there to show you where to begin the stroke).

- Most characters require only a single stroke. When you lift the stylus from the Graffiti writing area, your handheld recognizes and displays the text character immediately. To accomplish single strokes, some Graffiti strokes are portions of the regular alphabet equivalents.
- The Graffiti writing area is divided into two parts: one for writing the letters of the alphabet and one for writing numbers. The small marks at the top and bottom of the Graffiti writing area indicate the two areas.

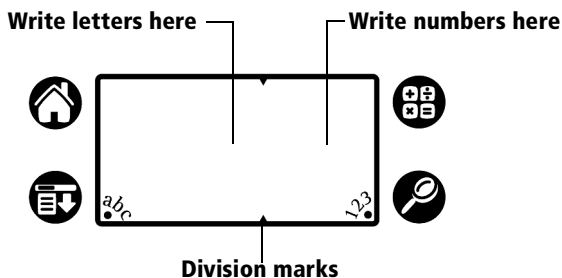

To write Graffiti letters:

1. Tap the screen where you want your text to go.

Note: You need to tap above the Graffiti writing area, and you must see a blinking cursor before you write the text.

2. Use the tables on the following pages to find the stroke shape for the letter you want to create. For example, the stroke shown below creates the letter “n.”

Note: There are two different stroke shapes available for some letters. For these letters, choose the one that’s easiest for you.

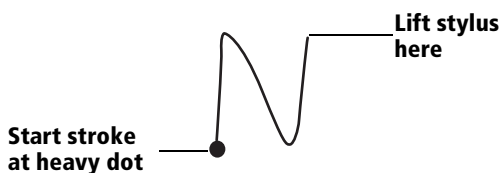

As you’ll see later, you use the same shape to create both the uppercase and lowercase version of a letter.

3. Position the stylus in the left-hand side of the Graffiti writing area.
4. Start your stroke at the heavy dot and draw the stroke shape as it appears in the tables.
5. Lift the stylus from the screen at the end of the stroke shape.

That's all there is to it! When you lift the stylus from the screen, your handheld recognizes your stroke immediately and prints the letter at the insertion point on the screen.

As soon as you lift the stylus from the screen, you can begin the stroke for the next character you want to write.



























Important: You must begin the character strokes in the Graffiti writing area. If you do not make Graffiti strokes in the Graffiti writing area, your handheld does not recognize them as text characters.

Graffiti tips

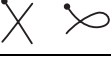
When using Graffiti writing, keep these tips in mind:

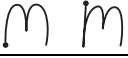
- Accuracy improves when you write large characters. You should draw strokes that nearly fill the Graffiti writing area.
- Press firmly.
- To delete characters, simply set the insertion point to the right of the character you want to delete and make the backspace stroke (a line from right to left) in the Graffiti writing area.
- Write at natural speed. Writing too slowly can generate recognition errors.
- Do not write on a slant. Vertical strokes should be parallel to the sides of the Graffiti writing area.

The Graffiti® alphabet

Letter	Strokes	Letter	Strokes
A		N	
B		O	
C		P	
D		Q	
E		R	
F		S	
G		T	
H		U	
I		V	
J		W	
K		X	
L		Y	
M		Z	
Space		Back Space	
Carriage Return		Period	<i>tap twice</i>

Writing capital letters

You make capital letters with the same stroke shapes as the basic alphabet characters. To make capital letters, you must first “shift” to caps — just as you press the Shift key on a keyboard — and then write the character strokes.

Note: Graffiti writing includes a feature that automatically capitalizes the first letter when you create a new sentence or a new record (by tapping New or a blank line).

To draw the first letter of a word as a capital letter:

- Use the Caps Shift stroke:

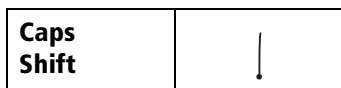

Tip: When Caps Shift is active, an “up arrow” symbol appears in the lower-right corner of the handheld screen. If you accidentally activate Caps Shift, backspace will cancel it.

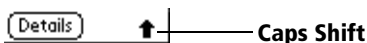

To enter only capital letters (Caps Lock):

- Use the Caps Lock stroke:



Tip: When Caps Lock is active, an underlined “up arrow” symbol appears in the lower-right corner of the handheld screen. To return to lowercase, make the Caps Shift stroke.

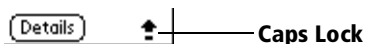

Writing numbers

Writing numbers with Graffiti writing is similar to writing letters of the alphabet, except that you make the character strokes on the right-hand side (numbers side) of the Graffiti writing area.

Graffiti numbers

Number	Strokes	Number	Strokes
0		5	
1		6	
2		7	
3		8	
4		9	

Writing punctuation marks

Graffiti writing can create any punctuation symbol that you can enter from a standard keyboard. All punctuation marks begin with a single tap on the Graffiti writing area. When you make this tap, you activate Punctuation Shift and a dot appears to show it is active. The next stroke you make with the stylus creates a punctuation mark.



Tip: When Punctuation Shift is active, you can make a symbol stroke anywhere in the Graffiti writing area (the letters *or* numbers side).

Symbol	Stroke	Symbol	Stroke
Period .	•	Dash —	—
Comma ,	,	Left Paren ((
Apostrophe '	'	Right Paren))
Question ?	?	Slash /	/
Exclamation !	!	Dollar \$	\$

Additional Graffiti punctuation

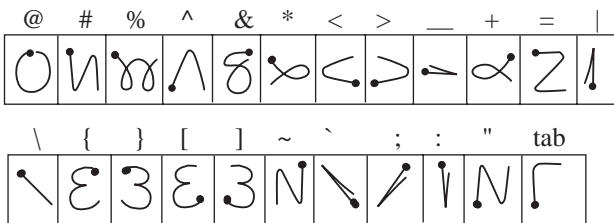

Writing symbols and extended characters

All symbols and extended characters begin with the stroke in the Graffiti writing area of your handheld:

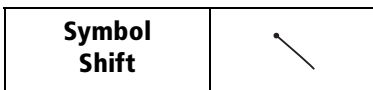

When the Symbol Shift is active, a slanted shift symbol appears in the lower-right corner of the screen. The next stroke that you make creates the symbol or extended character.

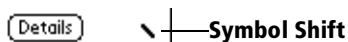

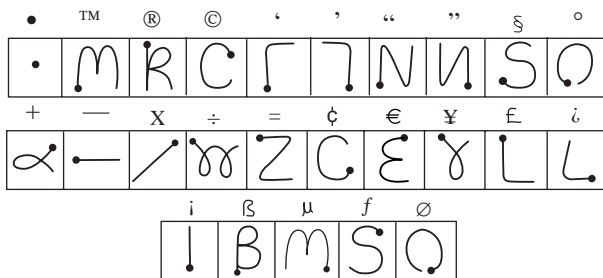

Writing accented characters

To create accented characters, draw the stroke normally used to create the letter, followed by an accent stroke. Graffiti writing then adds the accent to the letter.

For example, the following diagram shows the strokes required to draw an accented “e.”

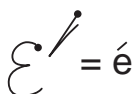

Accent strokes

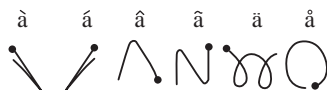

Using these accent strokes, you can write the following accented letters:

à á â ã ä å è é ê ë ì í î ï ò ó ô õ ö ù ú û ü ý ÿ ñ

Additional non-English characters



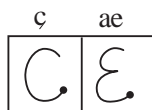

You can write the following characters without any special punctuation or shifting:



Note: You must write these non-English characters in the left side of the Graffiti writing area.

Navigation strokes

In addition to character symbols, Graffiti writing includes special strokes that you can use to navigate within text or fields in your applications.

Command	Stroke
Move cursor right	
Move cursor left	
Previous field	
Next Field	
Open Address Record (Address Book only)	

Graffiti ShortCuts

Graffiti ShortCuts make entering commonly used words or phrases quick and easy. ShortCuts are similar to the Glossary or Autotext features of some word processors.

Graffiti writing comes with several predefined ShortCuts, and you can also create your own. Each ShortCut can represent up to 45 characters. For example, you might create a ShortCut for your name, or for the header of a memo. See “ShortCuts preferences” in Chapter 8 to learn about creating your own ShortCuts.

To use a ShortCut, draw the ShortCut stroke followed by the ShortCut characters. When you draw the ShortCut stroke, the ShortCut symbol appears at the insertion point to show that you are in ShortCut mode.

ShortCut	
----------	---

Your handheld includes the following predefined Graffiti ShortCuts:

Entry	ShortCut
Date stamp	ds
Time stamp	ts
Date/time stamp	dts
Meeting	me
Breakfast	br
Lunch	lu
Dinner	di

Using the onscreen keyboard

You can open the onscreen keyboard anytime you need to enter text or numbers on your handheld. Note that you cannot enter Graffiti characters while using the onscreen keyboard.

To use the onscreen keyboard:

1. Open any application (such as Memo Pad).
2. Tap any record, or tap New.
3. Tap "abc" to open the alphabetic keyboard, or tap "123" to open the numeric keyboard.

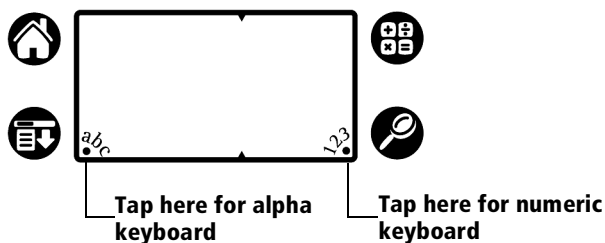

4. Tap the characters to enter text and numbers.

Note: The onscreen keyboard also includes a dialog box for international characters. You can switch among the three dialogs at any time to enter the exact text you need.

5. After you finish, tap Done to close the onscreen keyboard and place the text in the record.

Using your computer keyboard

If you have a lot of data to enter, or prefer to use the computer keyboard, you can use Palm™ Desktop software, or any supported PIM, to enter information. You can then perform a HotSync® operation to synchronize the information on your computer with the information on your handheld. All the main applications on your handheld are also available in Palm Desktop software and in most PIMs, so you don't need to learn different applications.

Refer to Palm Desktop online Help for more information on entering data on your computer.

Importing data

If you have data stored in computer applications such as spreadsheets and databases, or if you want to import data from another handheld, you can transfer the data to your handheld without having to key it in manually. Save the data in one of the file formats listed below, import it into Palm Desktop software, and then perform a HotSync operation to transfer the data to your handheld.

Palm Desktop software can import data in the following file formats:

- Comma delimited (.csv, .txt): Address Book and Memo Pad only
- Tab delimited (.tab, .tsv, .txt): Address Book and Memo Pad only
- CSV (Lotus Organizer 2.x/97 Mapping): Address Book only
- Date Book archive (.dba)
- Address Book archive (.aba)
- To Do List archive (.tda)
- Memo Pad archive (.mpa)

Archive formats can only be used with Palm Desktop software. Use the archive file formats to share information with other people who use Palm OS® handhelds or to create a copy of your important Palm Desktop information.

To import data:

1. Open Palm Desktop software.
2. Click the application into which you want to import data.
3. If you are importing records that contain a field with category names, do the following:

Select All in the Category box.

Be sure that the same categories that appear in the imported file also exist in the application. If the categories do not exist, create them now; otherwise, the records are imported into the Unfiled category.

4. From the File menu, choose Import.
5. Select the file you want to import.
6. Click Open.
7. To import data into the correct Palm Desktop fields, drag fields in the left-hand column so that they are opposite the corresponding imported field on the right.
8. If you do not want to import a field, deselect the check box for that field.
9. Click OK.

The imported data is highlighted in the application.

10. To add the imported data to your handheld, perform a HotSync operation.

See Palm Desktop online Help for more information on importing and exporting data.

Chapter 3

Managing Your Applications

This chapter explains how to switch between applications on your Palm VII™ handheld, how to change application settings so they are personalized to your work methods, and how to categorize applications so you view them in related groups.

Using the Applications Launcher

To open the Applications Launcher, tap the Applications icon .

Selecting applications

Your handheld is equipped with a variety of applications. All the applications installed on your handheld appear in the Applications Launcher. See “Opening applications” in Chapter 1 for details.



Switching between applications

When working in any application, tap the Applications icon  or press an application button on the front panel of your handheld to switch to another application. Your handheld automatically saves your work in the current application and displays it when you return to that application.

Categorizing applications

The category feature enables you to manage the number of application icons that appear onscreen in the Applications Launcher. You can assign an application to a category and then display a single category or all of your applications.

To categorize an application:

1. Tap the Applications icon .
2. Tap the Menu icon .
3. Tap App, and then tap Category.
4. Tap the pick list next to each application to select a category.

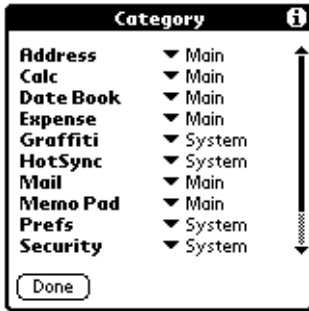

Tip: To create a new category, tap Edit Categories from the pick list. Tap New, enter the category name, and then tap OK to add the category. Tap OK.

5. Tap Done.

To display applications by category:

1. Tap the Applications icon .
2. Do one of the following:



Tap the Applications icon repeatedly to cycle through all your categories.

Tap the pick list in the upper-right corner of the screen and select the category you want to display.

Changing the Applications Launcher display



By default, the Applications Launcher displays each application as an icon. As an alternative, you can choose to show a list of applications. You can also choose to view the same category of applications each time you open the Applications Launcher.

To change the Applications Launcher display:

1. Tap the Applications icon .
2. Tap the Menu icon .
3. Tap Options, and then tap Preferences.
4. Tap the View By pick list and select List.
5. Tap OK.



To open the Applications Launcher to the last opened category:

1. Tap the Applications icon .
2. Tap the Menu icon .
3. Tap Options, and then tap Preferences.
4. Tap the Remember Last Category check box to select it.
5. Tap OK.

Choosing preferences

You can set options that affect an entire application in the application's Preferences dialog box.

To change preferences for an application:

1. Open an application.
2. Tap the Menu icon .
3. Tap Options, and then tap Preferences.

Note: Not all applications have a Preferences command.

4. Make changes to the settings.
5. Tap OK.

Installing and removing applications

This section explains how to install and remove applications on your handheld and how to remove Palm™ Desktop organizer software from your computer.

Installing add-on applications

Your handheld comes with the Date Book, Address Book, To Do List, Memo Pad, Expense, Calculator, and Mail applications installed and ready to use.

Your handheld also contains several built-in web clipping applications; so after you activate the wireless communication service, you have immediate access to Internet information.

The CD-ROM containing Palm Desktop software also contains many more web clipping applications. You can transfer these to your computer at the same time that you install the software. These web clipping applications are stored in the Add-on folder, and you can add them to your handheld using the Install Tool.

You can also install additional applications on your handheld, such as games and other software, including more web clipping applications. Many third-party applications are available for your handheld. The web site <http://www.palm.net> has more information about these applications.

Note: Any game or application that you install on your handheld resides in RAM memory; you can delete it at any time. See “Removing applications” later in this chapter for more information.

With the Install Tool and HotSync® technology, you can easily install software on your handheld.

To install add-on software on your handheld:

1. Using your desktop computer, copy or download the application you want to install into the Add-on folder in your Palm Desktop directory.

Note: If the software you download is compressed, you need to decompress it into this folder. If you prefer to place the application into another folder, you need to navigate to that folder before you complete step 5.

2. Double-click the Palm Desktop icon on your desktop.

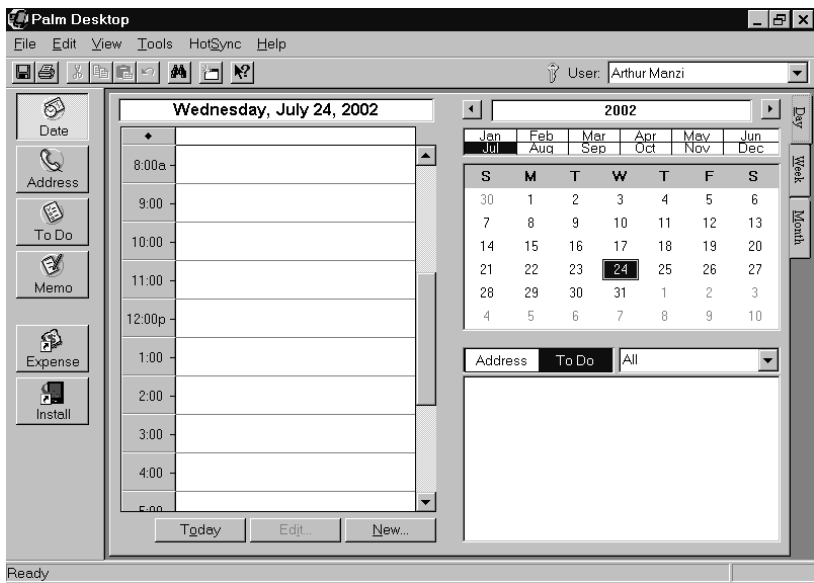

3. Click Install.

Tip: You can also access the Install Tool dialog box by selecting Install Tool from the Palm Desktop program group or by double-clicking any file with a PDB, PRC, PNC, or PQA file extension.

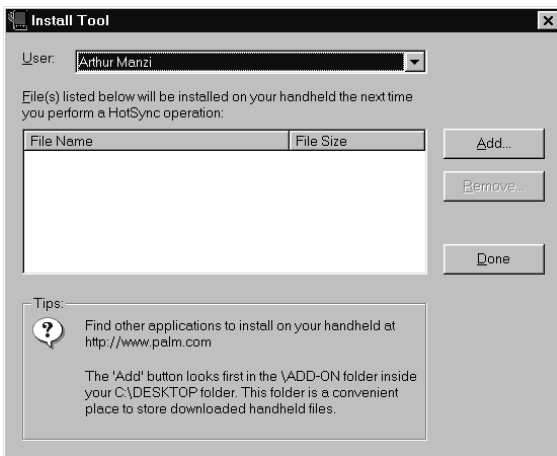

4. In the User drop-down list, select the name that corresponds to your handheld.

5. Click Add.

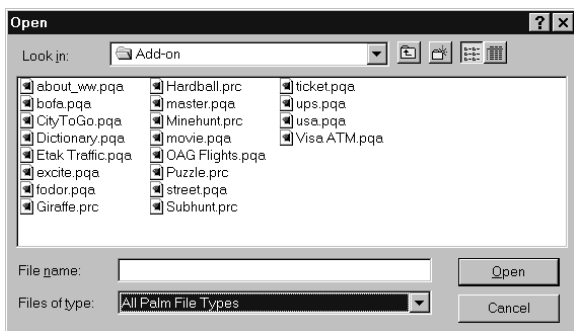

To see a list of just the web clipping applications that are on your computer, in Files of type, select the option for files with the PQA extension.

6. Select the application(s) that you want to install on your handheld.
7. Click Open.

Note: Review the list of applications you selected in the Install Tool dialog box. If you do not want to install an application, select it, and then click Remove. (This does not remove the application from your computer; it simply removes it from the list of applications to install.)

8. Perform a HotSync operation to install the application(s) you selected in step 6. See “Exchanging and updating data: HotSync operations” in Chapter 4 for details.

By default, web clipping applications appear on your handheld in the Palm.Net category of the Applications Launcher.

Installing games

The CD-ROM also includes several games that you can install with the Install Tool:

- Giraffe
- HardBall
- MineHunt
- Puzzle
- SubHunt

During Install, these games are automatically copied to the \Add-on folder in your Palm Desktop directory on your computer.



Note: Giraffe is a fun, easy way for you to practice Graffiti® writing.

After you install and start a game, the instructions appear in the Game menu. Depending on the game, the Game menu may also contain commands to show high scores, to start a new game, or to set preferences for the game.

Removing applications

In the event that you run out of memory or decide that you no longer need an application you installed, you can remove applications from your handheld. You can remove only add-on applications, patches, and extensions that you install; you cannot remove the applications that reside in the ROM portion of your handheld.

To remove an add-on application:

1. Tap the Applications icon .
2. Tap the Menu icon .
3. Tap App, and then tap Delete.
4. Tap the application that you want to remove.



5. Tap Delete.
6. Tap Yes.
7. Tap Done.

Removing Palm Desktop software

If you no longer want to use Palm Desktop software, you can remove it from your computer.

To remove Palm Desktop software:

1. From the Windows Start menu, choose Settings, and then Control Panel.
2. Double-click the Add/Remove Programs icon.
3. On the Install/Uninstall tab, select Palm Desktop software.
4. Click Add/Remove.

Note: You need to install the HotSync Manager from the installation CD-ROM if you want to synchronize data with another PIM. In the Setup Type dialog box, select Custom; then deselect all options except the HotSync option.

Security

Your handheld comes with a Security application so that unauthorized users cannot view the entries you wish to protect.

See “Protection of your wireless transactions” in Chapter 5 for information about the security of the Palm.Net™ network.

In Security, you can do the following:

- Lock and turn off your handheld so that it does not operate until you enter the correct password.
- Mask all records that you mark as private so the information appears greyed out.
- Hide all records that you mark as private so they do not appear on any screen.

You can mask and hide private records with or without a password. Without a password, private records are hidden or masked until you set the Security application to show them. With a password, you must enter the password to view the private entries. See “Making records private” in Chapter 4 for information on making records private.

Assigning a password

You can assign a password to protect your private records and to lock your handheld.

To assign a password:

1. Tap the Applications icon .
2. Tap the Security icon.
3. Tap the Password box.
4. Enter a password.

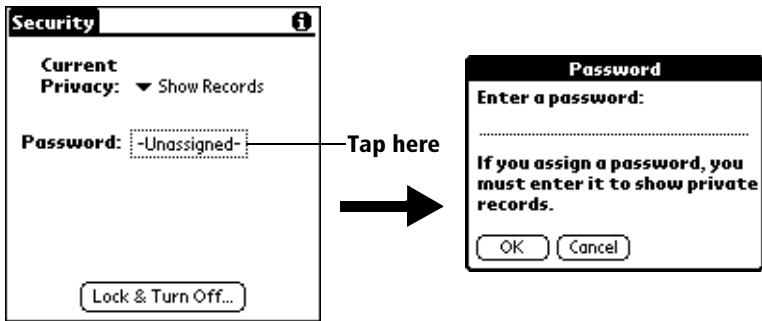

5. Tap OK.
6. Enter the *same* password a second time, and tap OK.

Changing or deleting a password

Once you define a password for your handheld, you can change or delete it at any time. You must enter the current password before you can change or delete it.

To change or delete your password:

1. Tap the Password box.
2. Enter the current password.

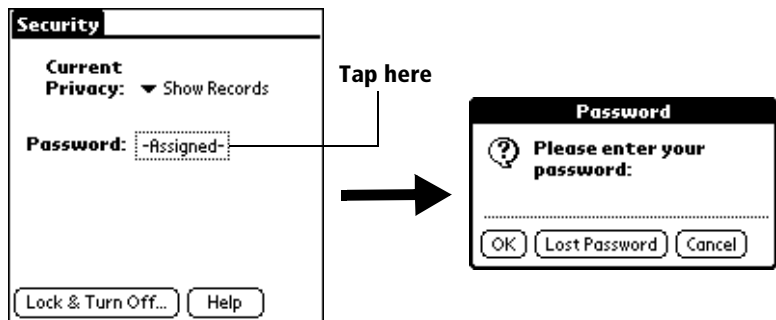

3. Tap OK.
4. Do one of the following:

To change the password, enter the new password, and tap OK.

To delete the password, tap Delete.



Locking your handheld

You can also lock your handheld so that you need to enter your password to operate it.

Important: If you lock your handheld, you must enter the exact password to re-activate your handheld. If you forget the password, you need to perform a hard reset to resume using your handheld. Performing a hard reset deletes all the records in your handheld; however, you can restore all synchronized data at the next HotSync operation. See "Performing a hard reset" in Appendix A for information about how to perform a hard reset.

To lock your handheld with a password:

1. Perform a HotSync operation to synchronize the data between your handheld and your computer. See "Exchanging and updating data: HotSync operations" in Chapter 4 for information on synchronizing your data.
2. Assign a password.
3. Tap Lock & Turn Off.

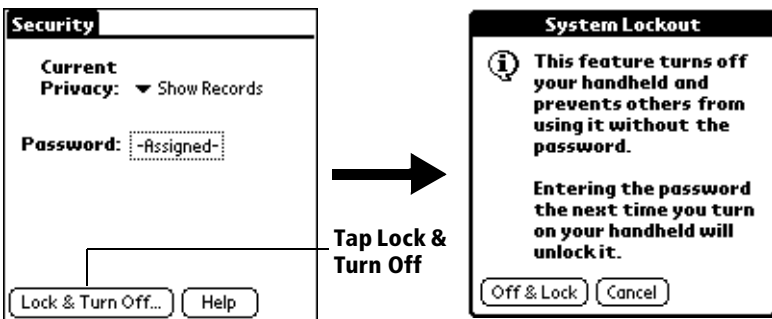

4. Tap Off & Lock.
5. To start your handheld, turn it on and then enter the password.

Recovering from a forgotten password

If you did not activate the Off & Lock feature and you forget your password, you can delete the password from your handheld. Deleting a forgotten password also deletes all entries and files marked as Private.

Important: If you synchronize with your computer before deleting a forgotten password, your handheld restores your private entries the next time you perform a HotSync operation, but it does not restore the password.

To delete a forgotten password:

1. Tap Lost Password.
2. Tap Yes.

Chapter 4

Using Your Basic Applications

Your Palm VII™ handheld includes these basic applications:

- Date Book
- Address Book
- To Do List
- Memo Pad
- Calculator
- Expense

See Chapter 5 for information on web clipping applications and the iMessenger® application. See Chapter 6 for information on Mail.

This chapter is divided into three sections:

- “Overview of basic applications” briefly describes each application and explains how to open it.
- “Common tasks” gives instructions on how to do tasks that you can do in most or all of the basic applications. It’s easy to transfer what you learn in one application to the others because the structure and behavior of all the applications are quite similar.
- “Application-specific tasks” is organized by application and gives instructions on how to do tasks that are specific to each application.

Overview of basic applications

Date Book



Date Book lets you quickly and easily schedule appointments or any kind of activity associated with a time and date.

In Date Book, you can do the following:

- Enter a description of your appointment and assign it to a specific time and date.
- Display a chart of your appointments for an entire week. The Week View makes it easy to spot available times and any potential scheduling overlaps or conflicts.
- Display a monthly calendar to quickly spot days where you have morning, lunch, or afternoon appointments.
- Display an agenda showing appointments, untimed events, and your To Do items for the day.
- Set an alarm to sound prior to the scheduled activity.
- Create reminders for events that are based on a particular date, rather than time of day. Birthdays and anniversaries are easy to track with your handheld.
- Attach notes to individual events for a description or clarification of the entry in your Date Book.

To open Date Book:

- Press the Date Book application button on the front panel of your handheld. Date Book opens to today's schedule.

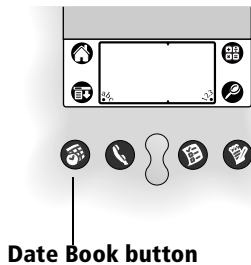

Note: Press the Date Book application button repeatedly to cycle through the Day, Week, Month, and Agenda views.

Address Book



Address Book enables you to keep names, addresses, phone numbers, and other information about your personal or business contacts.

In Address Book, you can do the following:

- Quickly look up or enter names, addresses, phone numbers, and other information.
- Enter up to five phone numbers (home, work, fax, mobile, etc.) or e-mail addresses for each name.
- Define which phone number appears in the Address list for each Address Book entry.
- Attach a note to each Address Book entry, in which you can enter additional information about the entry.
- Assign Address Book entries to categories so that you can organize and view them in logical groups.

To open Address Book:

- Press the Address Book application button on the front panel of your handheld. Address Book opens to display the list of all your records.

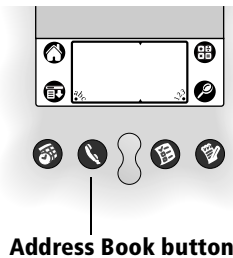

Note: Press the Address Book application button repeatedly to cycle through the categories in which you have records.

To Do List



To Do List is a convenient place to create reminders and prioritize the things that you have to do.

In To Do List, you can do the following:

- Make a quick and convenient list of things to do.
- Assign a priority level to each task.
- Assign a due date for any or all of your To Do List items.
- Assign To Do List items to categories so that you can organize and view them in logical groups.
- Sort your To Do List items either by due date, priority level, or category.
- Attach notes to individual To Do List items for a description or clarification of the task.

To open To Do List:

- Press the To Do List application button on the front panel of your handheld. To Do List opens to display the category of items you last viewed.

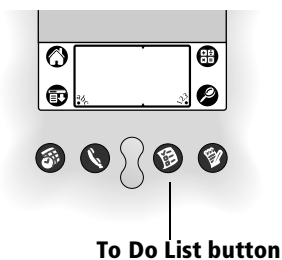

Note: Press the To Do List application button repeatedly to cycle through the categories in which you have items.

Memo Pad



Memo Pad provides a place to take notes that are not associated with records in Date Book, Address Book, or To Do List.

In Memo Pad, you can do the following:

- Take notes or write any kind of message on your handheld.
- Drag and drop memos into popular computer applications like Microsoft Word when you synchronize using Palm™ Desktop organizer software and HotSync® technology.
- Assign memos to categories so that you can organize and view them in logical groups.
- Write down phone numbers and other types of information. Later, you can copy and paste this information to other applications.

To open Memo Pad:

- Press the Memo Pad application button on the front panel of your handheld. Memo Pad opens to display the last Memo Pad screen that you viewed.

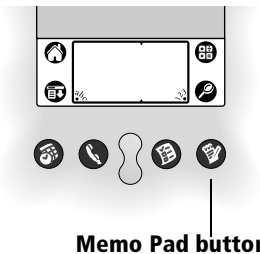

Note: Press the Memo Pad application button repeatedly to cycle through the categories in which you have memos.

Calculator



Calculator enables you to perform addition, subtraction, multiplication, and division.

In Calculator, you can do the following:

- Perform basic calculations.
- Store and retrieve values.

- Display the last series of calculations, which is useful for confirming a series of “chain” calculations.

To open Calculator:

- Tap the Calculator icon  next to the Graffiti® writing area.

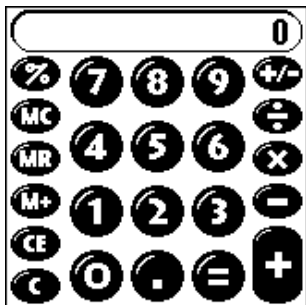



Expense

-  Expense lets you keep track of your expenses and then transfer the information to a spreadsheet on your computer.

In Expense, you can do the following:

- Record dates, types of expenses, amount spent, payment method, and other details associated with any money that you spend.
- Assign expense items to categories so that you can organize and view them in logical groups.
- Keep track of vendors (companies) and people involved with each particular expense.
- Log miles traveled for a particular date or expense category.
- Sort your expenses by date or expense type.
- Transfer your expense information to a Microsoft Excel spreadsheet (version 5.0 or later) on your computer. (Microsoft Excel is *not* included in the Palm VII™ handheld package.)

To open Expense:

1. Tap the Applications icon .
2. Tap the Expense icon .

Common tasks

The tasks described in this section use the term “records” to refer to an individual item in any of the basic applications: a single Date Book event, Address Book entry, To Do List item, Memo Pad memo, or Expense item.

Creating records

You can use the following procedure to create a new record in Date Book, Address Book, To Do List, Memo Pad, and Expense.

To create a record:

1. Select the application in which you want to create a record.
2. Tap New.
3. In Date Book only: Select start and end times for your appointment and tap OK.
4. Enter text for the record.
5. (Optional) Tap Details to select attributes for the record.
6. In Address Book and Memo Pad only: Tap Done.

There’s no need to save the record because your handheld saves it automatically.

Editing records

After you create a record, you can change, delete, or enter new text at any time. Two screen features tell you when your handheld is in editing mode:

- A blinking cursor
- One or more edit lines

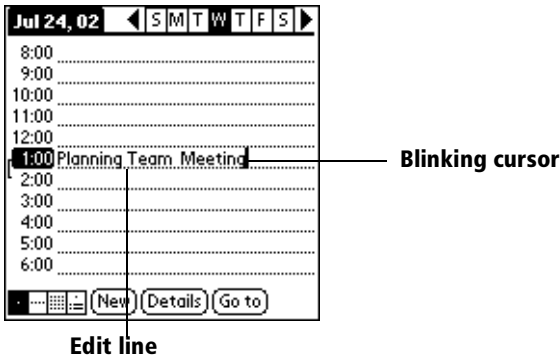

Entering text

For information on how to enter text using Graffiti writing, the onscreen keyboard, or the keyboard attached to your computer, see Chapter 2.

Edit menu

The Edit menu is available with any screen where you enter or edit text. In general, commands available in the Edit menu apply to text that you *select* in an application.

To select text in an application:

1. Tap the beginning of the text that you want to select.
2. Drag the stylus over the text to highlight it (in black).

Note: You can also double tap to select a word, or triple tap to select a line of text.

You can also drag *across* the text to select additional words, or drag *down* to select a group of lines.

The following commands may appear in an Edit menu:

Undo	Reverses the action of the <i>last edit</i> command. For example, if you used Cut to remove text, Undo restores the text you removed. Undo also reverses deletions done by using backspace.
Cut	Removes the selected text and stores it temporarily in the memory of your handheld. You can paste the text you cut into another area of the current application or into a different application.
Copy	Copies the selected text and stores it temporarily in the memory of your handheld. You can paste the text that you copy into another area of the current application or into a different application.
Paste	Inserts the text that you cut or copied at the selected point in a record. The text you paste replaces any selected text. If you did not previously cut or copy text, Paste does nothing.
Select All	Selects all of the text in the current edit line, record, or screen. This enables you to cut or copy all of the text and paste it elsewhere.

- Copy Page** Copies the first 4,000 bytes of a clipping or page in a web clipping application. See “Saving information from a web clipping application” in Chapter 5.
- Keyboard** Opens the onscreen keyboard. When you finish with the onscreen keyboard, tap Done.
- Graffiti Help** Opens screens that show all the Graffiti character strokes. Use this command anytime you forget a stroke for a character.

Deleting records

To delete a record in any of the basic applications:

1. Select the record you want to delete.
2. Tap the Menu icon .
3. Tap Record, and then tap the Delete command:

Date Book: Delete Event

Address Book: Delete Address

To Do List: Delete Item

Memo Pad: Delete Memo

Expense: Delete Item

A confirmation dialog box appears. If you want to save a copy of the deleted item to an archive file in Palm Desktop software, be sure that the check box is checked. If you don't want to save a copy, tap the check box to remove the check.

4. Tap OK.

If you save a copy of the item, your handheld transfers it to an archive file on your desktop the next time you perform a HotSync operation.

Other ways to delete records

You can also delete records in the following ways:

- In the application's Details dialog box, tap Delete, then tap OK.
- Delete the text of the record.

Note: In Date Book, you can choose to delete the text of the current repeating event, current and future events, or all instances of that event.

Purging records

Over time, as you use Date Book, To Do List, and Expense, you'll accumulate records in these applications that have outlived their usefulness. For example, events that occurred months ago remain in the Date Book, and To Do List items that you marked as completed remain in the list, as do Expense items.

Note: The To Do preferences control which To Do List items appear. See "To Do Show Options" later in this chapter for more information.

All these outdated records take up memory on your handheld, so it's a good idea to remove them by using Purge. If you think Date Book or To Do List records might prove useful later, you can purge them from your handheld and save them in an archive file.

Purging is also available in the iMessenger application (see Chapter 5) and in Mail (see Chapter 6).

Purging is not available in Address Book or Memo Pad. You must delete unneeded records from these applications.

To purge records:

1. Open the application.
2. Tap the Menu icon .
3. Tap Record, and then tap Purge.

A confirmation dialog box appears.

Date Book: Tap the pick list and select how old a record must be to be purged. Purge deletes repeating events if the last of the series ends before the date that you purge records.

Date Book, To Do List: If you want to save a copy of the purged records to an archive file on your desktop, be sure that the check box is checked. If you don't want to save a copy, tap the check box to remove the check box.

4. Tap OK.

If you chose to save a copy of the purged records, your handheld transfers them to an archive file on your desktop the next time you perform a HotSync operation.

Note: Purging does not happen automatically. You must tap the command to make it happen.

Exchanging and updating data: HotSync operations

The HotSync process automatically synchronizes — that is, exchanges and updates — the data on your handheld and Palm Desktop software. Changes you make on your handheld or Palm Desktop software appear in both places after a HotSync operation. HotSync technology synchronizes only the needed portions of files, thus reducing synchronization time.

You can synchronize your data either directly or indirectly. Direct methods include placing your handheld in the cradle attached to your computer, or using infrared communications. Indirect methods include using a modem, or via a network using the network HotSync technology. See Chapter 7 for information about performing HotSync operations via a modem, network, or IR port.

Performing a HotSync operation for the first time

The first time you synchronize your data, you need to enter user information in your Palm Desktop software. After you enter this information and synchronize, the HotSync Manager recognizes your handheld and doesn't ask for this information again.

If you are a System Administrator preparing several handhelds for a group of users, you may want to create a user profile. See “Creating a user profile” in Chapter 7 before performing the following steps.

Important: You must perform your *first* HotSync operation with a local, direct connection, rather than using a modem.

The following steps assume that you have already installed the Palm Desktop software. If you have not installed this software, See “Palm Desktop organizer software” in Chapter 1 for instructions.

To perform a local HotSync operation:

1. Insert your handheld into the cradle.

Tip: The bottom edge of the handheld should align smoothly with the cradle when it is inserted properly.

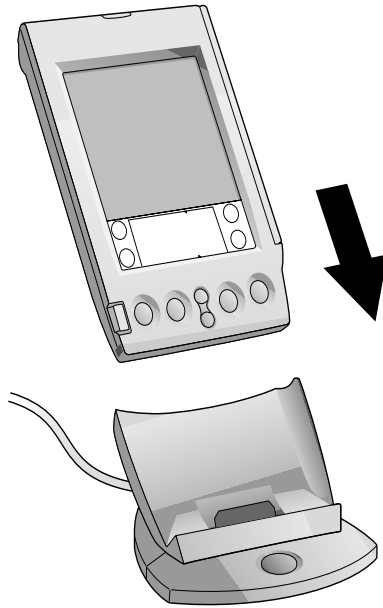

2. If the HotSync Manager is not running, start it: on the Windows desktop, click Start, and then choose Programs. Navigate to the Palm Desktop software program group and choose HotSync Manager. Alternatively, you can start the Palm Desktop software which automatically opens the HotSync Manager.
3. Press the HotSync button ™ on the cradle.



Important: The first time you perform a HotSync operation, you must select a user name in the New User dialog box and click OK. Every handheld must have a unique name. To prevent loss of a user's records, never try to synchronize more than one handheld to the same user name.

The HotSync dialog box appears and synchronization begins.

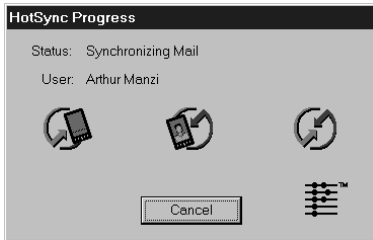

4. Wait for a message on your handheld indicating that the process is complete.

After the HotSync process is complete, you can remove your handheld from the cradle.

Categorizing records

Categorize records in the Address Book, To Do List, Memo Pad, and Expense applications so that they are grouped logically and are easy to review. (You can also categorize applications. See "Using the Applications Launcher" in Chapter 3 for more information.)

When you create a record, your handheld automatically places it in the category that is currently displayed. If the category is All, your handheld assigns it to the Unfiled category. You can leave an entry as Unfiled or assign it to a category at any time.

System-defined and user-defined categories

By default, your handheld includes system-defined categories, such as All and Unfiled, and user-defined categories, such as Business and Personal.

You cannot modify the system-defined categories, but you can rename and delete the user-defined categories. In addition, you can create your own user-defined categories. You can have a maximum of 15 user-defined categories in each application.

Address Book contains the QuickList user-defined category, in which you can store the names, addresses, and phone numbers you might need in emergencies (doctor, fire department, lawyer, etc.).

Expense contains two user-defined categories, New York and Paris, to show how you might sort your expenses according to different business trips.

Note: The illustrations in this section come from Address Book, but you can use these procedures in all the applications in which categories are available.

To move a record into a category:

1. Select the record you want to categorize.
2. In Address Book only: Tap Edit.
3. Tap Details.
4. Tap the Category pick list to display the list of available categories.



5. Select the category for the record.
6. Tap OK.

Note: In Address Edit and Memo you can tap the category name in the upper-right corner of the screen and select a new category for the item.

To display a category of records:

1. Tap the category pick list in the upper-right corner of the list screen.

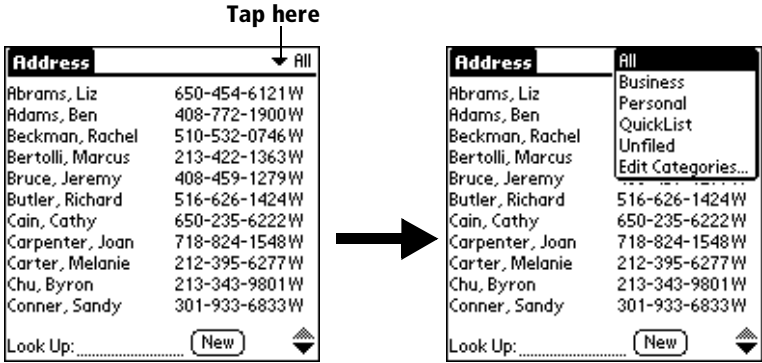

Note: In the Date Book Agenda view, the pick list is in the upper right of the To Do list.

2. Select the category you want to view.

The list screen now displays only the records assigned to that category.

Tip: Pressing an application button on the front panel of the handheld toggles through all the categories of that application.

To define a new category:

1. Tap the category pick list in the upper-right corner of the screen or list.

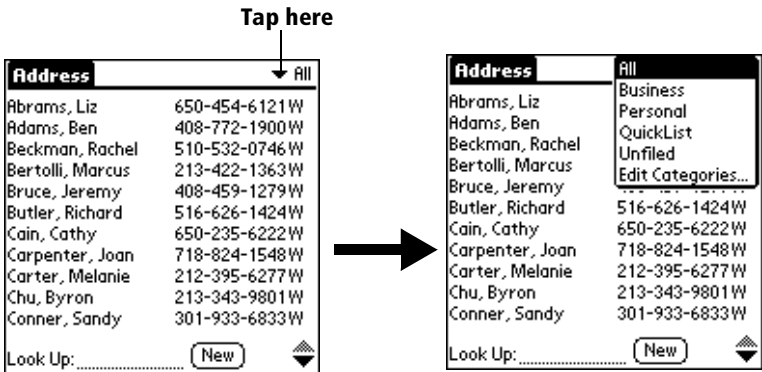

2. Tap Edit Categories.
3. Tap New.



4. Enter the name of the new category, and then tap OK.



5. Tap OK.

You can assign any of your records to the new category.

To rename a category:

1. Tap the category pick list in the upper-right corner of the screen or list.
2. Tap Edit Categories.
3. Select the category that you want to rename, and then tap Rename.



4. Enter the new name for the category, and then tap OK.



5. Tap OK.

Tip: You can group the records in two or more categories into one category by giving the categories the same name. For example, if you change the name of the Personal category to Business, all records formerly in the Personal category appear in the Business category.

Finding records

Your handheld offers several ways to find information quickly:

- **All applications:** Find locates any text that you specify, always starting with the current application.
- **Date Book, To Do List, Memo Pad:** Phone Lookup displays the Address list screen and lets you add the information that appears in this list to a record.
- **Address Book:** The Look Up line lets you enter the first letters of a name to scroll immediately to that name.
- **Expense:** Lookup displays the names in your Address Book that have data in the Company field. You can add these names to a list of attendees associated with an Expense record.

Looking up Address Book records

When working with Address Book, the scroll button on the front panel of the handheld makes it easy to navigate among your address entries.

- In the Address list screen, the scroll button moves up or down an entire screen of records. If you hold down the scroll button, you accelerate the scrolling and display every third screen.
- In the Address View screen, the scroll button moves to the previous or next address record.

You can also use the Address list Look Up feature to quickly scroll to any of your Address Book entries.

To look up an Address Book record:

1. Display the Address list screen.
2. Enter the first letter of the name you want to find.

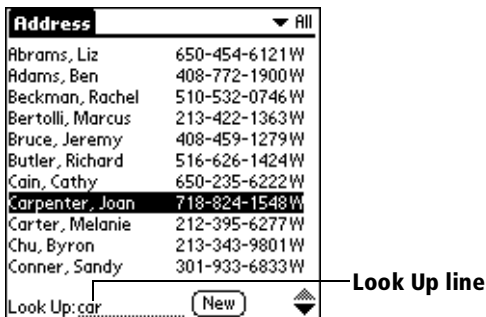

The list scrolls to the first entry that begins with that letter. If you write another letter, the list scrolls to the first entry that starts with those *two* letters. For example, writing an “s” scrolls to “Sands,” and writing “sm” scrolls further to “Smith.” If you sort the list by company name, the Look Up feature scrolls to the first letter of the company name.

3. Tap the record to view its contents.

Using Find

You can use Find to locate any text that you specify, in any application except web clipping applications.

To use Find:

1. Tap the Find icon .

Tip: If you select text in an application before you tap Find, the selected text automatically appears in the Find dialog box.

2. Enter the text that you want to find.

Find is *not* case-sensitive. For example, searching for the name “davidson” also finds “Davidson.”

Find locates any words that begin with the text you enter. For example, searching for “plane” finds “planet,” but not “air-plane.”

3. Tap OK.

Find searches for the text in all records and all notes.

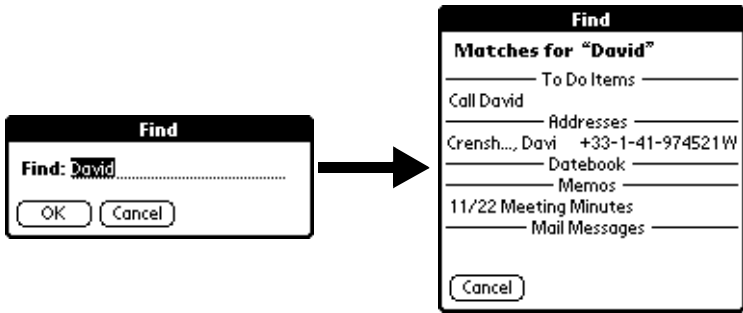

During the search, you can tap Stop at any time if the entry you want appears before your handheld finishes the search. To continue the search after you tap Stop, tap Find More.

4. Tap the text that you want to review.

Using Phone Lookup

Phone Lookup displays the Address list screen and lets you add information from that list to a record.

To use Phone Lookup:

1. Display the record in which you want to insert information. It can be in Date Book, To Do List, Memo Pad, Mail, or iMessenger®.
2. Tap the Menu icon .
3. Tap Options, and then tap Phone Lookup.
4. Spell the last name of the name you want to find.



The list scrolls to the first record in the list that starts with the first letter you enter. Continue to spell the name you're looking for, or when you see the name, tap it. Note that in Mail and iMessenger, only names with e-mail addresses appear.

5. Tap Add.

The name you selected, along with the other information associated with it, is pasted into the record you selected in step 1. In Mail and iMessenger, Phone Lookup inserts only the e-mail address.

Phone Lookup tips

Write the Graffiti Command stroke /L to activate the Phone Lookup feature. You can also activate it in the following circumstances:

- **While entering text:** For example, to insert the full name and phone number for someone with the last name “Williams,” write the Graffiti characters for “Wi” and then the Phone Lookup Command stroke /L.

Assuming you have only one Address Book record that begins with “Wi,” your handheld inserts the full name “Fred Williams” (and its associated information). If you have more than one name that begins with “Wi,” the Phone Lookup screen appears and highlights the first record that begins with “Wi.”

- **For selected text:** Drag to highlight the text, and then write the Phone Lookup Command stroke /L. Your handheld replaces the selected text and adds the name and its associated information.

Looking up names to add to expense records

In Expense, Lookup displays the names in your Address Book that have data in the Company field. You can add these names to a list of attendees associated with an Expense record.

To add names to an Expense record:

1. Tap the Expense record to which you want to add names.
2. Tap Details.



The screenshot shows a 'Receipt Details' screen with the following fields and controls:

- Category:** ▾ Unfiled
- Type:** ▾ Lunch
- Payment:** ▾ Unfiled
- Currency:** ▾ \$
- Vendor:**
- City:**
- Attendees:** Who...

At the bottom, there are four buttons: OK, Cancel, Delete, and Note, followed by an upward-pointing arrow.

3. Tap Who.

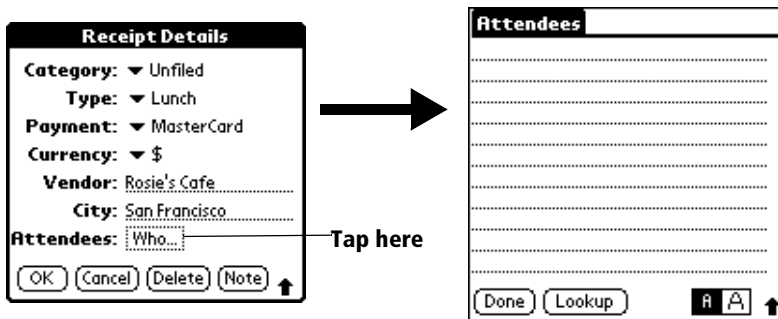

4. Tap Lookup.

The Attendees Lookup screen displays all the names in your Address Book that have data in the Company field.

5. Select the name you want to add, and then tap Add.

The name appears in the Attendees screen.

6. Repeat steps 4 and 5 to add more names.

7. Tap Done.

8. Tap OK.

Sorting lists of records

You can sort lists of records in various ways, depending on the application. Sorting is available in applications that have list screens: Address Book, To Do List, Memo Pad, and Expense.

Note: You can also assign records to categories. See “Categorizing records” earlier in this chapter.

To sort records in To Do List and Expense:

1. Open the application to display the list screen.
2. Tap Show.
3. Tap the Sort by pick list and select an option.
4. Tap OK.

To sort records in Address Book and Memo Pad:

1. Open the application to display the list screen.
2. Tap the Menu icon .
3. Tap Options, and then tap Preferences.

Address Book



Memo Pad

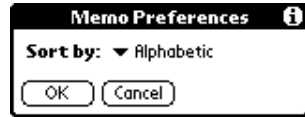

4. Do one of the following:

Address Book: Tap the setting you want.

Memo Pad: Tap the Sort by pick list and select Alphabetic or Manual.

5. Tap OK.

To sort the Memo list manually, tap and drag a memo to a new location in the list.

Note: To make the list of your memos appear in Palm Desktop software as you manually sorted it on your handheld, open Memo Pad in Palm Desktop software and click List by. Then select Order on handheld.

Making records private

In all basic applications except Expense and Mail, you can make individual records private. Private records remain visible and accessible, however, until you select the Security setting to hide or mask all private records. See “Security” in Chapter 3 for more information.

Hiding or masking private records

You can hide or mask all records that you mark as private. Masked records appear as grey placeholders in the same position they would appear if they were not masked, and are marked with a lock icon. Hidden records disappear completely from the screen. If you define a password for your handheld, you must enter it to display private records.

Address		All
Abrams, Liz	650-454-6121	🔒
Beckman, Rachel	510-532-0746	
Bertolli, Marcus	213-422-1363	
Cain, Cathy	650-235-6222	🔒
Carpenter, Joan	718-824-1548	
Carter, Melanie	212-395-6277	
Chu, Brian	213-343-9801	🔒

Look Up: car

To hide all private records:

1. Tap the Applications icon .
2. Tap Security.
3. Tap the Current Privacy pick list and select Hide Records.

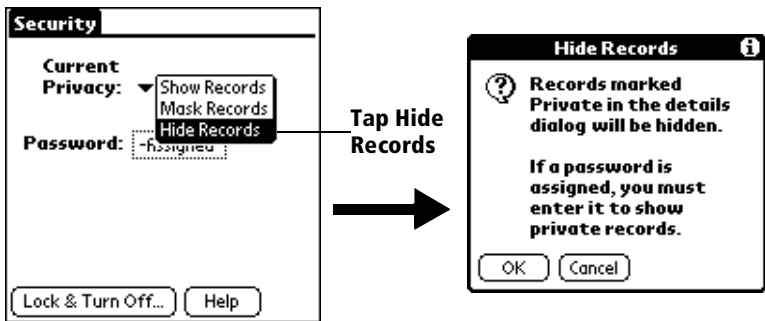

4. Tap OK to confirm that you want to hide private records.

To mask all private records:

1. Tap the Applications icon .
2. Tap Security.
3. Tap the Current Privacy pick list and select Mask Records.

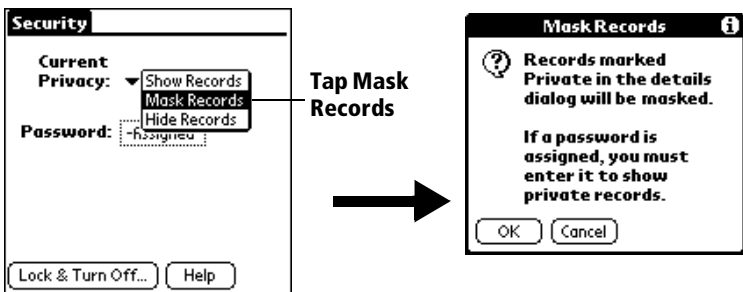

4. Tap OK to confirm that you want to mask private records.

To display private records:

1. Do one of the following:

Tap the Applications icon , tap Security, then tap the Current Privacy pick list and select Show Records.

If you do not have a password, hidden and masked records become visible.

If you have a password, the Show Private Records dialog box appears. Go to step 2.

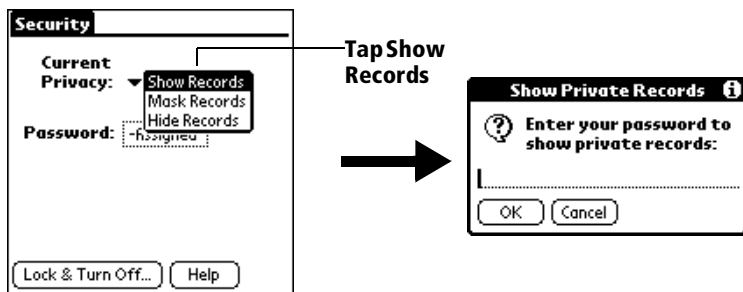

2. Enter your password and then tap OK.

To make a record private:

1. Display the entry that you want to make private.
2. Tap Details.
3. Tap the Private check box to select it.
4. Tap OK.

Attaching notes

In all basic applications except Memo Pad, you can attach a note to a record. A note can be up to several thousand characters long. For example, for an appointment in Date Book, you can attach a note with directions to the location.

To attach a note to a record:

1. Display the entry to which you want to add a note.
2. In Address Book only: Tap Edit.
3. Tap Details.
4. Tap Note.
5. Enter your note.

6. Tap Done.

A small note icon appears at the right side of any item that has a note.

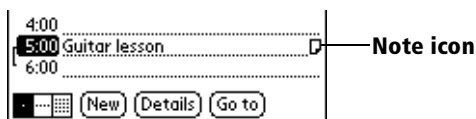

To review or edit a note:

1. Tap the Note icon .

To delete a note:

1. Tap the Note icon .
2. Tap Delete.
3. Tap Yes.

Choosing fonts

In all basic applications except Expense, you can change the font style to make text easier to read. You can choose a different font style for each application.

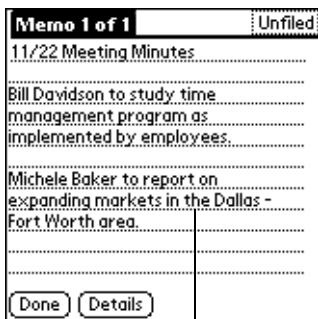

Small font



Large font

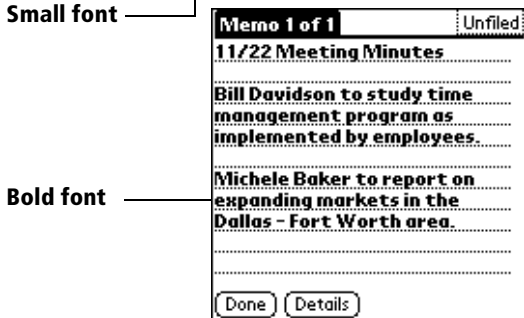

Bold font

To change the font style:

1. Open an application.
2. Tap the Menu icon .
3. Tap Options, and then tap Font.
4. Tap the font style you want to use.

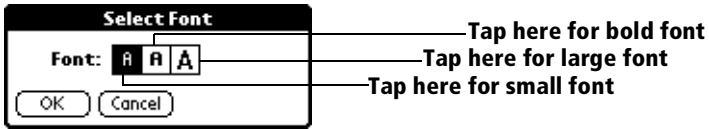

5. Tap OK.

Application-specific tasks

Date Book

When you open Date Book, the screen shows the current date and a list of times for a normal business day.

Scheduling an event

A record in Date Book is called an “event.” An event can be any kind of activity that you associate with a day. You can enter a new event on any of the available time lines.

When you schedule an event, its description appears on the time line, and its duration is automatically set to one hour. You can easily change the start time and duration for any event.

Note: It’s possible to schedule events that overlap, but Date Book makes it easy to find such conflicts. See “Spotting event conflicts” later in this chapter.

You can also schedule events in your Date Book that occur on a particular date but have no specific start or end times, such as birthdays, holidays, and anniversaries. These are referred to as “untimed events.” Untimed events appear at the top of the list of times, marked with a diamond. You can have more than one untimed event on a particular date.

You can also schedule a repeating event, such as a weekly meeting, and continuous events, such as a three-day conference or a vacation.

To schedule an event for the current day:

1. Tap the time line that corresponds to the beginning of the event.

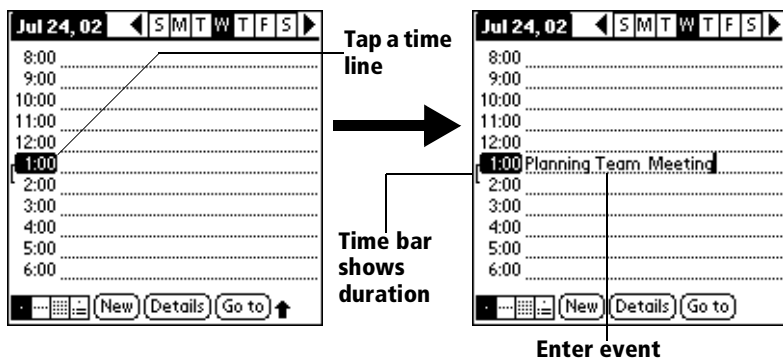

2. Enter a description of the event. You can enter up to 255 characters.
3. If the event is one hour long, skip to step 7. If the event is longer or shorter than an hour, tap the time of the event to open the Set Time dialog box.

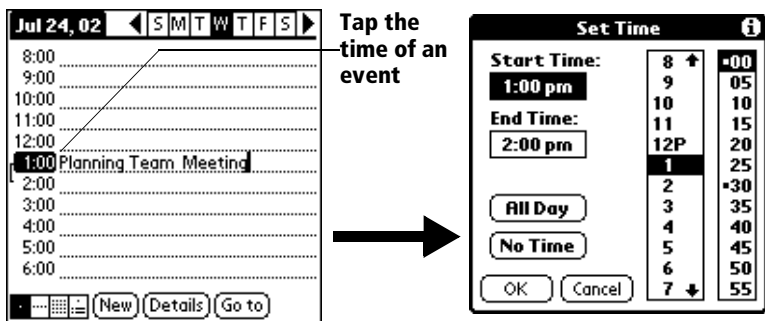

Tip: You can also open the Set Time dialog (to select a start time) by making sure no event is selected, and then writing a number on the number side of the Graffiti writing area.

4. Do one of the following:

Tap the time columns on the right side of the Set Time dialog to set the Start Time, then tap the End Time box and tap the time columns to set the End Time.

Tap All Day to automatically insert the start and end time of the event as defined in your Date Book preferences.

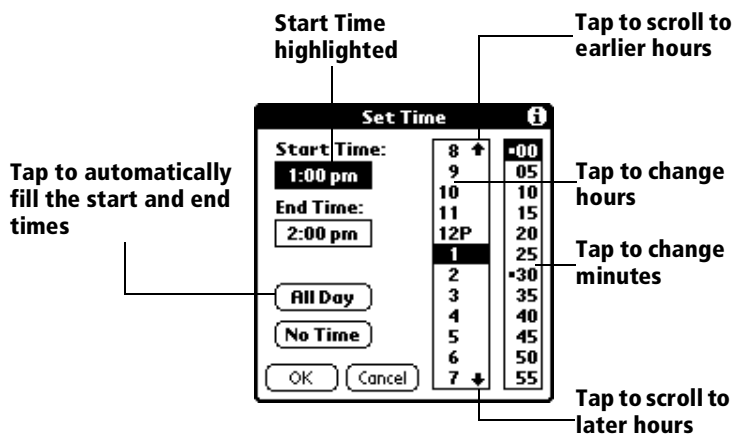

5. Tap OK.

6. Tap a blank area of the screen to deselect the event. A vertical line appears next to the time, indicating the duration of the event.

Note: If an event has the same start and end time, the time only appears once.

To schedule an event for another day:

1. Select the date you want for the event by doing one of the following:
 - Tap the day of the week that you want in the date bar at the top of the screen. If necessary, tap the Previous week or Next week scroll arrows to move to another week.

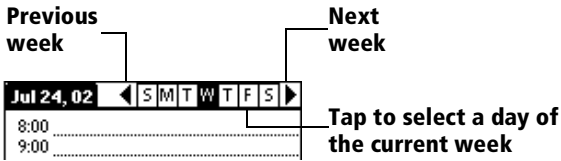

Tip: You can also use the scroll button on the front panel of your handheld to move forward or backward one day at a time.

- Tap Go To at the bottom of the screen to open the Go to Date dialog box. Select a date by tapping a year, month, and day in the calendar.

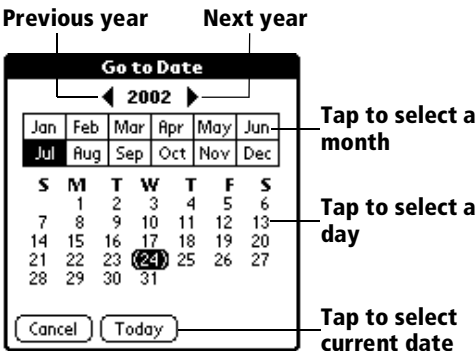

Tip: In the Go to Date dialog box, you can also use the scroll button on the front panel of the handheld to move forward or backward one month at a time.

2. After you locate the date, follow the steps for scheduling an event for the current day.

To schedule an untimed event:

1. Select the date that you want for the event as described in "To schedule an event for another day."
2. Tap New.
3. Tap OK, so that no start or end times are defined for the new event.

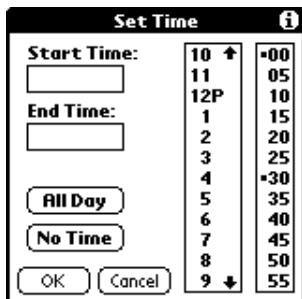

Tip: You can also create a new untimed event by making sure no event is selected and then writing letters in the Graffiti writing area.

4. Enter a description of the event.

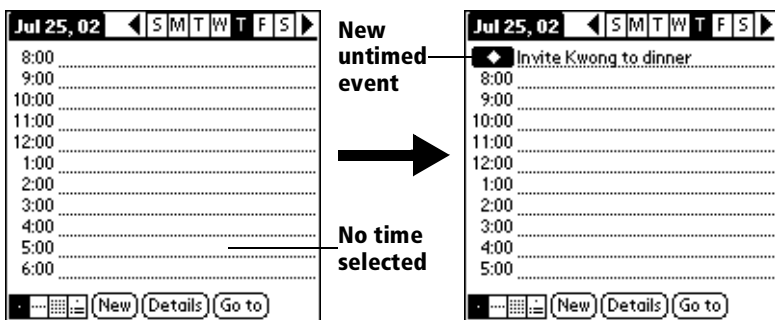

5. Tap a blank area on the screen to deselect the untimed event.

Note: If you create an event and decide later that there is no particular start or end time, you can easily change it to an untimed event. Tap the time of the event in the Date Book screen, tap No Time, and then tap OK.

Rescheduling an event

You can easily make changes to your schedule with your handheld.

To reschedule an event:

1. Tap the event you want to reschedule.
2. Tap Details.
3. To change the time, tap the Time box and select a new time.
4. To change the date, tap the Date box and select a new date.
5. Tap OK.

Setting an alarm for an event

The Alarm setting enables you to set an audible alarm for events in your Date Book. You can set an alarm to sound minutes, hours, or days before an event. The default Alarm setting is 5 minutes before the time of the event, but you can change this to any number of minutes, hours, or days.

When you set an alarm, this icon  appears to the far right of the event with the alarm. When the alarm tone sounds, a reminder message also appears onscreen.

To set an alarm for an event:

1. Tap the event to which you want to assign an alarm.
2. Tap Details.
3. Tap the Alarm check box to select it.

The default setting, 5 Minutes, appears.

4. Tap the pick list to select Minutes, Hours, or Days.
5. Select the 5 and enter any number from 0 to 99 (inclusive) as the number of time units.

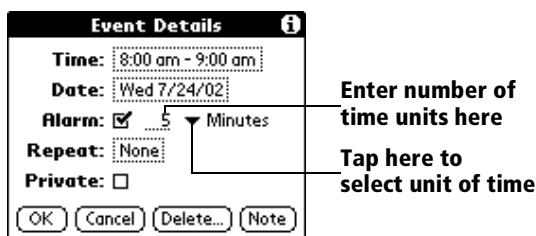

6. Tap OK.

7. When the reminder message appears on screen, do one of the following:

Tap OK to permanently dismiss the reminder and return to the current screen.

Tap Snooze to dismiss the reminder and return to the current screen. The reminder message appears again five minutes after you tap Snooze.

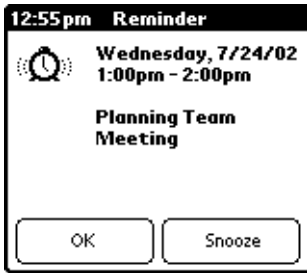

Alarm for untimed events: You can set a silent alarm for an untimed event. In this case, the alarm triggers at the specified period of minutes, hours, or days before midnight (beginning) of the day of the untimed event. No audible alarm sounds for an untimed event; instead, the reminder message appears onscreen.

For example, you set an alarm for an untimed event that occurs on February 4th. If the alarm is set for 5 minutes, the reminder message appears at 11:55 PM on the night of February 3rd. The reminder remains onscreen until you turn on your handheld and tap OK to dismiss it.

Scheduling repeating or continuous events

The Repeat function lets you schedule events that recur at regular intervals or extend over a period of consecutive days.

A birthday is a good example of an event that repeats annually. Another example is a weekly guitar lesson that falls on the same day of the week and the same time of day.

A business trip or a vacation is an example of a continuous event.

To schedule a repeating or continuous event:

1. Tap the event.

Typically, a continuous event is an untimed event.

2. Tap Details.

3. Tap the Repeat box to open the Change Repeat dialog box.

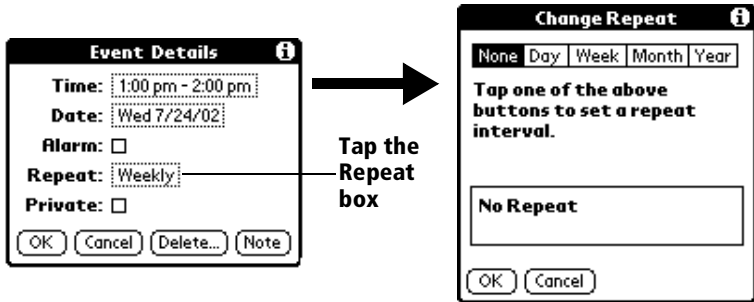

4. Tap Day, Week, Month, or Year to set how often the event repeats.

For a continuous event, tap Day.

5. Enter a number that corresponds to how often you want the event to repeat on the Every line.

For example, if you select Month and enter the number 2, the event repeats every other month.

6. To specify an end date for the repeating or continuous event, tap the End on pick list and tap Choose Date. Use the date picker to select an end date.

7. Tap OK.

After you schedule a repeating or continuous event, this icon  appears to the far right of the event.

Changing repeating or continuous events

When you make changes to a repeating or continuous event, such as deleting or adding notes, or changing the time of an event, you can decide which of the events you want to change; all events in the series, just the current event, or the current and future events.

To delete repeating events:

1. Select the record you want to delete.
2. Tap the Menu icon .
3. Tap Record, and then tap Delete Event.
4. Do one of the following:

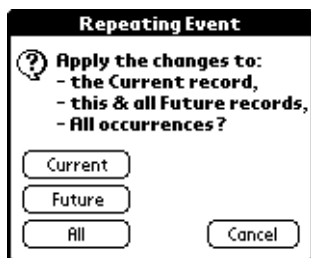

Tap Current to delete only the current event item.

Tap Future to delete the current and all future event items and reset the end date of the repeating event to the last shown date.

Tap All to delete all occurrences of the repeating event.

5. Tap OK.

Considerations for repeating or continuous events: Keep the following points in mind.

- If you change the start date of a repeating event, your handheld calculates the number of days you moved the event. Your handheld then automatically changes the end date to maintain the duration of the repeating event.
- If you change the repeat interval (e.g., daily to weekly) of a repeating event, past occurrences (prior to the day on which you change the setting) are not changed, and your handheld creates a new repeating event.
- If you change the date of an occurrence of a repeating event (e.g., from January 14th to January 15th) and apply the change to all occurrences, the new date becomes the start date of the repeating event. Your handheld adjusts the end date to maintain the duration of the event. If you apply the change to current and future occurrences, past occurrences are not changed.
- If you change other repeat settings (e.g., time, alarm, private) of a repeating event and apply the change to all occurrences, your handheld creates a new event. The start date of this new event is the day on which the setting is changed. Past occurrences (prior to the day of the change) are not changed.
- If you apply a change to a single occurrence of a repeating event (e.g., time), that occurrence no longer shows the Repeat icon .

Changing the Date Book view

In addition to displaying the time list for a specific day, you can also display a whole week, a month, or an agenda. You can also display the current time.

To cycle through Day, Week, and Month views:

- Press the Date Book application button repeatedly to display the next view.
- Tap the appropriate view icon in the lower-left corner of Date Book.

To display the current time:

1. Tap and hold the stylus on the date bar to display the current time.

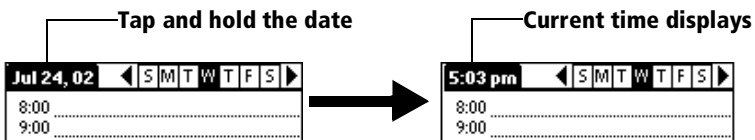

2. Drag the stylus below the title area and then lift it to redisplay the date.

Working in Week View: Week View shows the calendar of your events for an entire week. This view lets you quickly review your appointments and available time slots. In addition, the graphical display helps you spot overlaps and conflicts in your schedule.

To display the Week View:

1. Tap the Week View button.



2. Tap the navigation controls to move forward or backward a week at a time, or tap a column to display details of an event.

Note: The Week View also shows untimed events and events that are before and after the range of times shown.

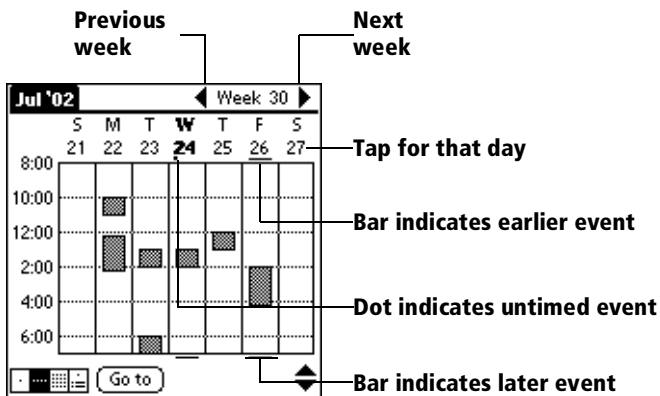

3. Tap an event to show a description of the event.

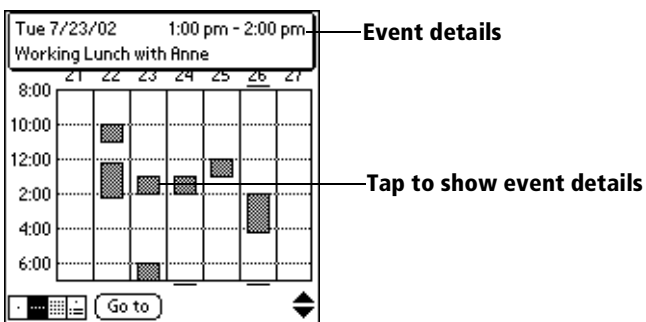

Tips for using Week View: Keep the following points in mind.

- To reschedule an event, tap and drag the event to a different time or day.
- Tap a blank time on any day to move to that day and have the time selected for a new event.
- Tap any day or date that appears at the top of the Week View to move directly to that day without selecting an event.
- The Week View shows the time span defined by the Start Time and End Time in the Date Book Preferences settings. If you have an event before or after this time span, a bar appears at the top or bottom of that day's column. Use the onscreen scroll arrows  to scroll to the event.

Spotting event conflicts

With the ability to define specific start and end times for any event, it's possible to schedule events that overlap (an event that starts before a previous event finishes).

An event conflict (time overlap) appears in the Week View as overlapping bars. The Day View displays overlapping brackets to the left of the conflicting times.

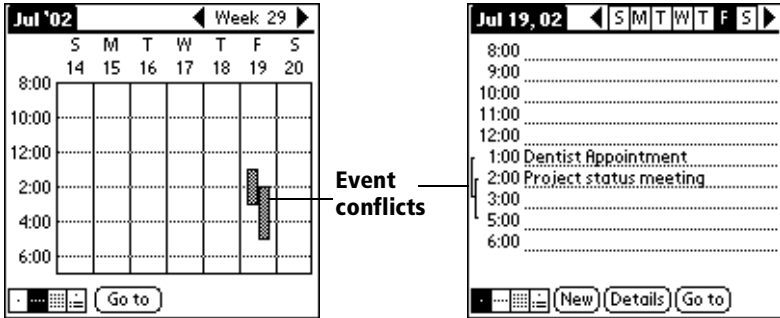

Working in Month View

The Month View screen shows which days have events scheduled. Dots and lines in the Month View indicate events, repeating events, and untimed events.

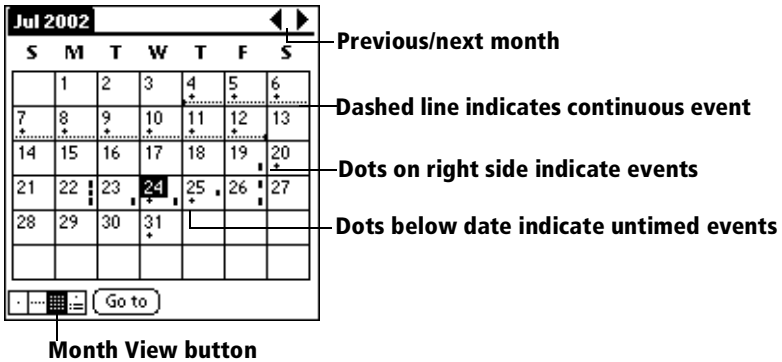

You can control the dots and lines that appear in the Month View. See “Options menu” at the end of this section on Date Book.

Tips for using Month View: Keep the following points in mind.

- Tap a day in the Month View to display that day in the Day View.
- Tap the scroll arrows in the upper-right corner to move forward or backward a month.
- Tap Go to in order to open the date selector and select a different month.
- Use the scroll button on the front panel of your handheld to move between months. Press the upper half of the button to display the previous month, the lower half to display the next month.

Working in Agenda View

The Agenda view shows you your untimed events, appointments, and To Do List items in one screen. When you tap an untimed event or appointment in the Agenda view, the Day view appears so you can see more detailed information about the event. You can tap the check box next to a To Do List item to mark it complete. When you tap a To Do List item, your To Do List appears.

Note: The To Do List items that appear and how you can change them depends on the settings in your To Do preferences. See “To Do Show Options” later in this chapter for more information.

To display the Agenda View:

1. Tap the Agenda View button.



2. Tap the navigation controls to move forward or backward a day at a time, or to display more events and To Do List items.

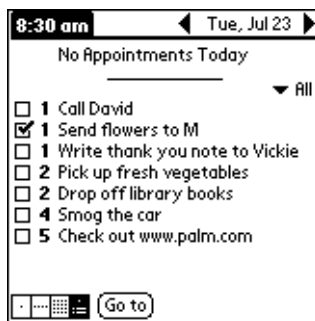
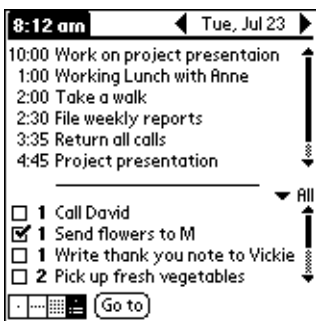

Note: You can also change the category of To Do List items shown. Tap the pick list to choose another category. See “To Do List” later in this chapter for more information on working with To Do List items.

Date Book menus, preferences, and display options

Date Book menus are shown here for your reference, and Date Book features that are not explained elsewhere in this book are described here.

See “Using menus” in Chapter 1 for information about choosing menu commands.

Record menu

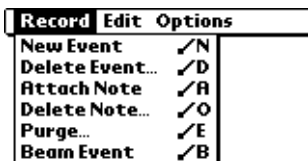

Options menu



Display Options

Allows you to change Date Book’s appearance and which events display.



- **Show Time Bars:** Activates the time bars that appear in the Day View. The time bars show the duration of an event and illustrate event conflicts.

- **Compress Day View:** Controls how times appear in the Day View. When Compress Day View is off, all time slots display. When it is on, start and end times display for each event, but blank time slots toward the bottom of the screen disappear to minimize scrolling.
- **Month View settings:** These check boxes apply to the Month View of the Date Book. You can activate any or all of these settings to show that you have Timed, Untimed, or Daily Repeating events in the Month View *only*.

Preferences

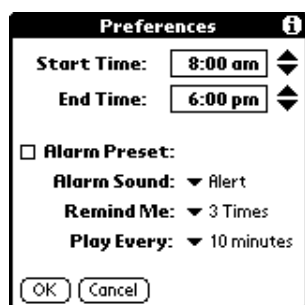

- **Start/End Time:** Defines the start and end times for Date Book screens. If the time slots you select do not fit on one screen, you can tap the scroll arrows \blacklozenge to scroll up and down.
- **Alarm Preset:** Automatically sets an alarm for each new event. The silent alarm for untimed events is defined by minutes, days, or hours before midnight of the date of the event.
- **Alarm Sound:** Sets the tone of the alarm.
- **Remind Me:** Defines how many times the alarm sounds. The choices are Once, Twice, 3 Times, 5 Times, and 10 Times.
- **Play Every:** Defines how often the alarm sounds. The choices are Minute, 5 minutes, 10 minutes, and 30 minutes.

About Date Book

Shows version information for Date Book.

Address Book

Address Book is the application in which you store name and address information about people or businesses.

Creating an Address Book entry

A record in Address Book is called an “entry.” You can create entries on your handheld, or you can use Palm Desktop software to create entries on your computer and then download the entries to your handheld with your next HotSync operation.

Palm Desktop software also has data import capabilities that enable you to load database files into Address Book on your handheld.

See “Importing data” in Chapter 2 and Palm Desktop online Help for more information.

To create a new Address Book entry:

1. Press the Address Book application button  on the front of your handheld to display the Address list.
2. Tap New.

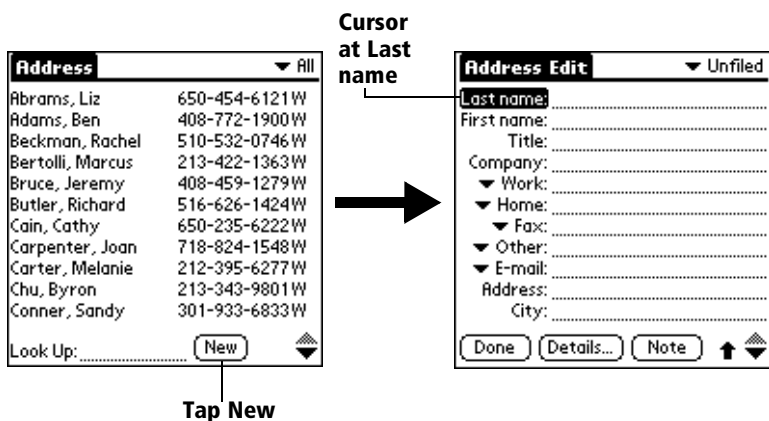

3. Enter the last name of the person you want to add to your Address Book.

Note: Your handheld automatically capitalizes the first letter of each field (except numeric and e-mail fields). You do not have to use the Graffiti capital stroke to capitalize the first letter of the name.

- Use the Next Field Graffiti stroke to move to the First Name field.

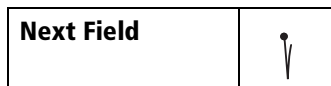

Tip: You can also move to any field by tapping it directly.

- Enter the person's first name in the First Name field.
- Enter the other information that you want to include in this entry.

Note: As you enter letters in the Title, Company, City, and State fields, text appears for the first logical match that exists in your Address Book. As you enter more letters, a closer match appears. For example, you may already have Sacramento and San Francisco in your Address Book. As you enter "S" Sacramento appears, and as you continue entering "a" and "n" San Francisco replaces Sacramento. As soon as the word you want appears, tap in the next field to accept the word.

- Tap the scroll arrows  to move to the next page of information.
- After you finish entering information, tap Done.

A screenshot of an "Address Edit" form. The form has a title bar with "Address Edit" and "Unfiled" on the right. The fields are: Last name: Carter, First name: Melanie, Title: (empty), Company: (empty), Work: 212-395-6227, Home: 212-395-4511, Fax: (empty), Other: (empty), E-mail: mcarter@aol.com, Address: 2267 5th Avenue, City: New York. At the bottom are buttons for "Done", "Details...", and "Note", and a scroll arrow icon.

Tap Done

Tip: To create an entry that always appears at the top of the Address list, begin the Last name or Company field with a symbol, as in *If Found Call*. This entry can contain contact information in case you lose your handheld.

Selecting types of phone numbers

You can select the types of phone numbers or e-mail addresses that you associate with an Address Book entry. Any changes you make apply only to the current entry.

To select other types of phone numbers in an entry:

1. Tap the entry that you want to change.
2. Tap Edit.
3. Tap the pick list next to the label you want to change.

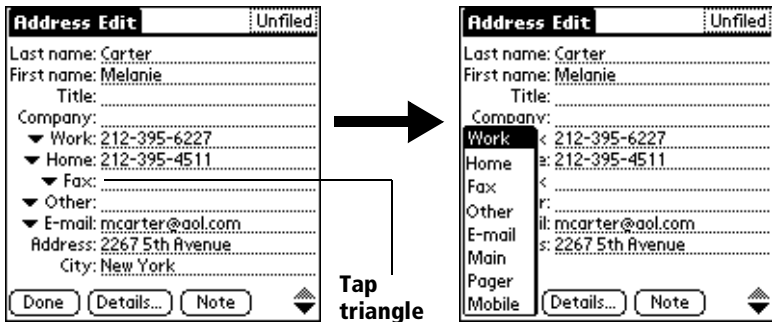

4. Select a new label.

Changing Address Entry details

The Address Entry Details dialog box provides a variety of options that you can associate with an entry.

To open the Address Entry Details dialog box:

1. Tap the entry whose details you want to change.
2. Tap Edit.
3. Tap Details.



4. Select any of the following settings:

Show in List Select which type of phone or other information appears in the Address list screen. Your options are Work, Home, Fax, Other, E-mail, Main, Pager, and Mobile. The identifying letters W, H, F, O, E, M, or P appear next to the record in the Address list, depending on which information is displayed. If the E-mail or Other fields end in a letter, the identifying letters are not displayed.

Category Assign the entry to a category.

Private Hide this entry when Security is turned on.

Address Book menus

Address Book menus are shown here for your reference, and Address Book features that are not explained elsewhere in this book are described here.

See “Using menus” in Chapter 1 for information about choosing menu commands.

The Record and Options menus differ depending on whether you’re displaying the Address list screen or the Address View screen.

Record menus

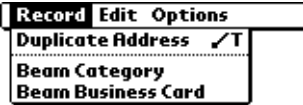

Address list

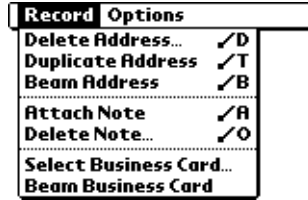

Address View

Duplicate Address Makes a copy of the current record and displays the copy in Address Edit so you can make changes to the copied record. The copy has the same category and attached notes as the original record.

Options menus



Address list



Address View

Preferences

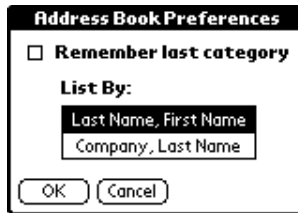

- **Remember last category:** Determines how Address Book appears when you return to it from another application. If you select this check box, Address Book shows the last category you selected. If you clear it, Address Book displays the All category.

Rename Custom Fields

These custom fields appear at the end of the Address Edit screen. Rename them to identify the kind of information you enter in them. The names you give the custom fields appear in all entries.



About Address Book

Shows version information for Address Book.

To Do List

A To Do List item is a reminder of some task that you have to complete. A record in To Do List is called an “item.”

To create a To Do List item:

1. Press the To Do List application button  on the front of your handheld to display the To Do list screen.
2. Tap New.

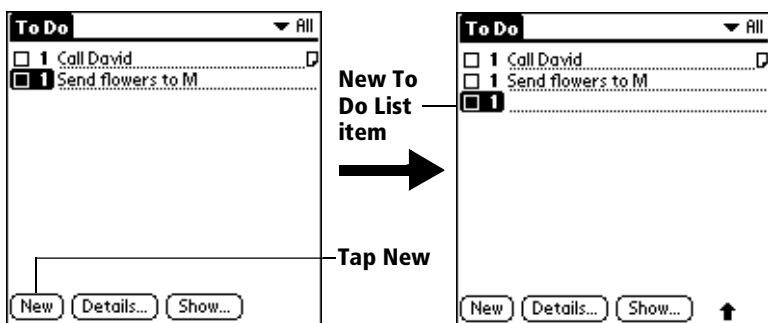

3. Enter the text of the To Do List item. The text can be longer than one line.
4. Tap anywhere onscreen to deselect the To Do List item.

Tip: If no To Do List item is currently selected, writing in the Graffiti writing area automatically creates a new item.

Setting priority

The priority setting for items lets you arrange the tasks in your To Do List according to their importance or urgency. The default setting for the To Do List is to arrange items by priority and due date, with priority 1 items at the top. If you have a number of items in your list, changing an item’s priority setting may move its position in the list.

Note: When you create a new To Do List item, its priority is automatically set to level 1, the highest (most important) level. If you select another item first, however, the item you create appears beneath the selected item and is given the same priority as the selected item.

To set the priority of a To Do List item:

1. Tap the Priority number on the left side of the To Do List item.

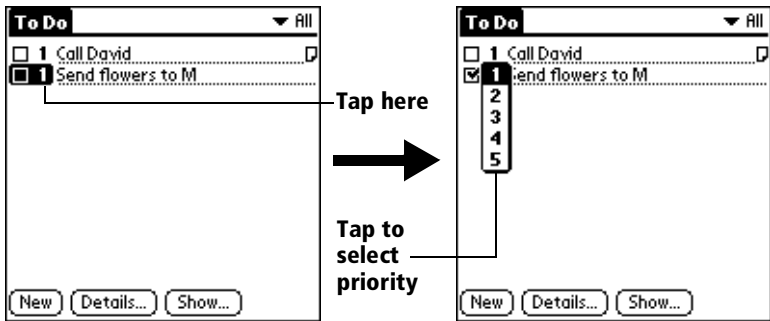

2. Tap the Priority number that you want to set (1 is most important).

Checking off a To Do List item

You can check off a To Do List item to indicate that you've completed it. You can set the To Do List to record the date that you complete the To Do List item, and you can choose to show or hide completed items. See "To Do Show Options" later in this chapter.

To check off a To Do List item:

- Tap the check box on the left side of the item.

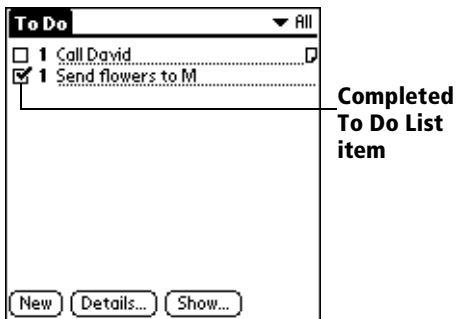

Changing To Do List item details

The To Do Item Details dialog box enables you to change settings for individual items.

To display the To Do Item Details dialog box:

1. Tap the text of the item whose details you want to change.
2. Tap Details.



Setting a due date

You can associate a due date with any To Do List item. You can also sort the items that appear in the list based on their due date.

To set a due date for a To Do List item:

1. In the Details dialog box, tap “No Date” to open the Due Date pick list.

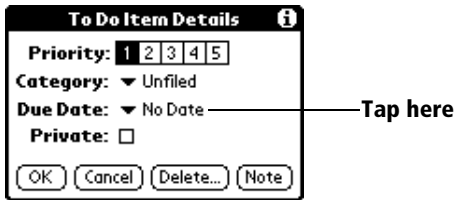

2. Tap the date that you want to assign the item:

Today: Assigns the current date.

Tomorrow: Assigns tomorrow’s date.

One week later: Assigns the date exactly one week from the current date.

No Date: Removes the due date from the item.

Choose Date: Opens the date selector, where you can choose any date that you want for the item.

3. Tap OK.

Tip: If you turn on the Show Due Dates option in the To Do Show options dialog, you can tap directly on the due date in the To Do List to open the pick list shown in step 2.

To Do Show Options

The Show Options dialog box enables you to control the appearance of To Do List and To Do List items in Date Book Agenda view.

To change the Show Options settings:

1. In To Do List, tap Show.



2. Select any of the following settings:

Show Completed Items: Displays your completed items in the To Do List. If you turn off this setting, your To Do List items disappear from the list when you complete (check) them.

Items that no longer appear on the list because you turn off this setting have not been deleted. They are still in the memory of your handheld. Purge completed items to remove them from memory.

Show Only Due Items: Shows only the items that are currently due, past due, or have no due date specified. When this setting is active, items that are not yet due do not appear in the list until their due date.

Record Completion Date: Replaces the due date with the actual date when you complete (check) the item. If you do not assign a due date to an item, the completion date still records when you complete the item.

Show Due Dates: Displays the due dates associated with items in the To Do List and displays an exclamation mark next to items that remain incomplete after the due date passes.

Show Priorities: Shows the priority setting for each item.

Show Categories: Shows the category for each item.

3. Tap OK.

To Do List menus

To Do List menus are shown here for your reference, and To Do List features that are not explained elsewhere in this book are described here.

See “Using menus” in Chapter 1 for information about choosing menu commands.

Record menu

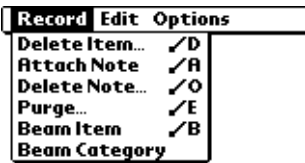

Options menu



About To Do List Shows version information for To Do List.

Memo Pad

A memo can contain up to 4,000 characters. The number of memos you can store is dependent only on the memory available on your handheld. A record in Memo Pad is called a “memo.”

To create a new memo:

1. Press the Memo Pad application button  on the front of your handheld to display the Memo list.
2. Tap New.

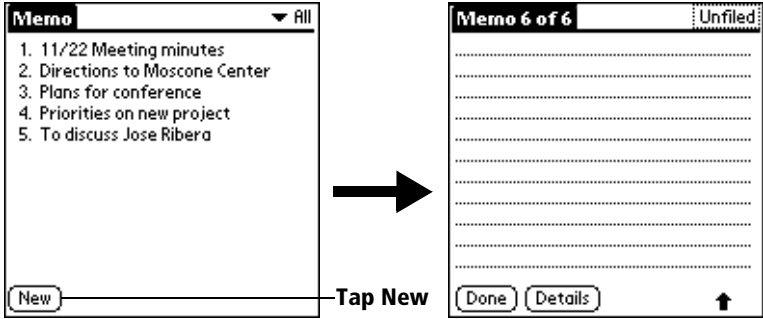

Tip: In the Memo list screen, you can also begin writing in the Graffiti writing area to create a new memo. The first letter is automatically capitalized and begins your new memo.

3. Enter the text you want to appear in the memo. Use the carriage return stroke to move down to new lines in the memo.
4. Tap Done.

Reviewing memos

The first line of a memo appears in the Memo list. This makes it easy to locate and review your memos.

To review a memo:

1. In the Memo list, tap the text of the memo.

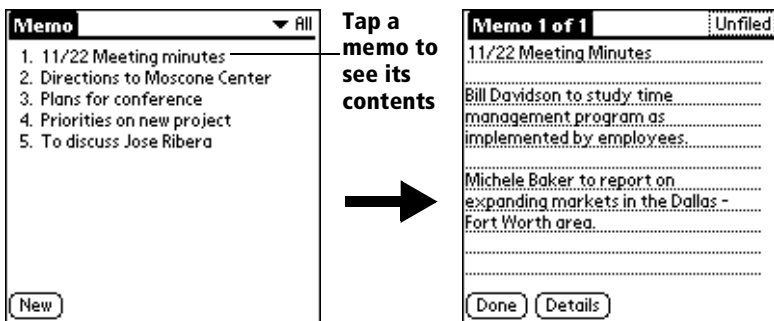

2. Review or edit the text in the memo.
3. Tap Done.

Memo Pad menus

Memo Pad menus are shown here for your reference, and Memo Pad features that are not explained elsewhere in this book are described here.

See “Using menus” in Chapter 1 for information about choosing menu commands.

The Record and Options menus differ depending on whether you’re displaying the Memo list or an individual memo.

Record menus

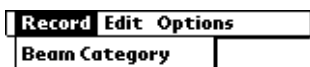

Memo list

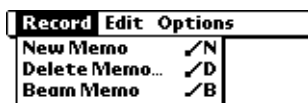

Memo screen

Options menus

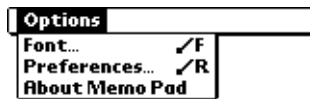

Memo list



Memo screen

Go to Top of Page	Moves to the top (first) line of the memo.
Go to Bottom of Page	Moves to the bottom (last) line of the memo.
Preferences	Displays the Memo Preferences dialog box, where you define the sort order for memos.
About Memo Pad	Shows version information for Memo Pad.

Calculator

The Calculator includes several buttons to help you perform calculations.



Clears the last number you entered. Use this button if you make a mistake while entering a number in the middle of a calculation. This button enables you to re-enter the number without starting the calculation over.



Clears the entire calculation and enables you to begin a fresh calculation.



Toggles the current number between a negative and positive value. If you want to enter a negative number, enter the number first *and then press* the +/- button.



Places the current number in memory. Each new number you enter with the M+ button is *added to the total* already stored in memory. The number that you add can be either a calculated value or any number you enter by pressing the number buttons. Pressing this button has no effect on the current calculation (or series of calculations); it merely places the value into memory until it is recalled.



Recalls the stored value from memory and inserts it in the current calculation.



Clears any value that is stored in the Calculator memory.

Recent Calculations

The Recent Calculations command enables you to review the last series of calculations and is particularly useful for confirming a series of “chain” calculations.

To display recent calculations:

1. Tap the Menu icon .
2. Tap Options, and then tap Recent Calculations.

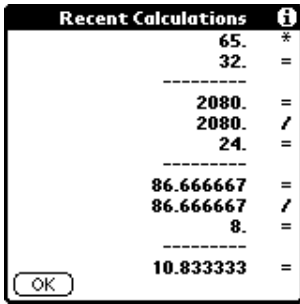

3. After you finish reviewing the calculations, tap OK.

Calculator menus

Calculator menus are shown here for your reference, and Calculator features that are not explained elsewhere in this book are described here.

See “Using menus” in Chapter 1 for information about choosing menu commands.

Options menus

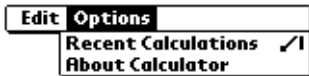

**About
Calculator**

Shows version information for Calculator.

Expense

Expense enables you to record the date, expense type, and the amount that you spent. A record in Expense is called an “item.” You can sort your Expense items into categories or add other information that you want to associate with the item.

To create an Expense item:

1. Tap the Applications icon .
2. Tap Expense.
3. Tap New.

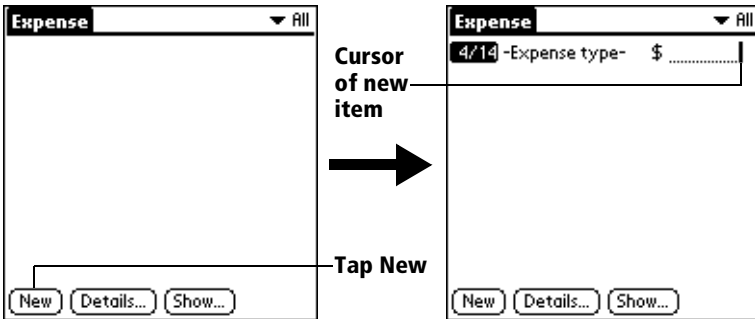

Tip: You can also create a new Expense item by writing on the number side of the Graffiti writing area while in the Expense list screen. The first number you write begins the amount of your new Expense item.

4. Enter the amount of the expense.
5. Tap the Expense type pick list and select a type from the list.

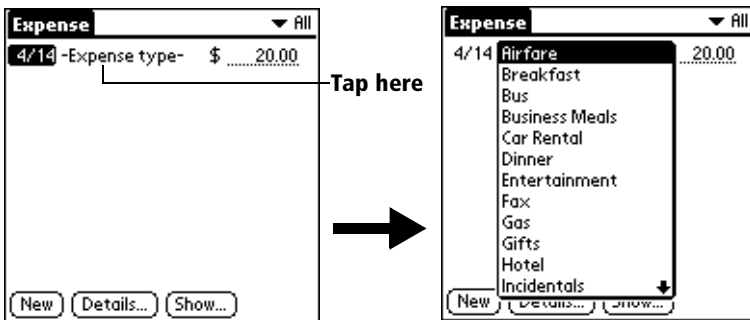

Note: As soon as you select an expense type, your handheld saves your entry. If you do not select an expense type, it does not save the entry.

Tip: Another quick way to create a new Expense item is to make sure that no Expense item is selected in the Expense list, write the first letter(s) of the expense type, and then write the numerical amount of the Expense item. This technique takes advantage of the automatic fill feature. See “Options menu” later in this chapter for details.

Changing the date of an Expense item

Initially, Expense items appear with the date you enter them. You can use Expense to change the date associated with any Expense item.

To change the date of an Expense item:

1. Tap the Expense item you want to change.
2. Tap the date of the selected item.

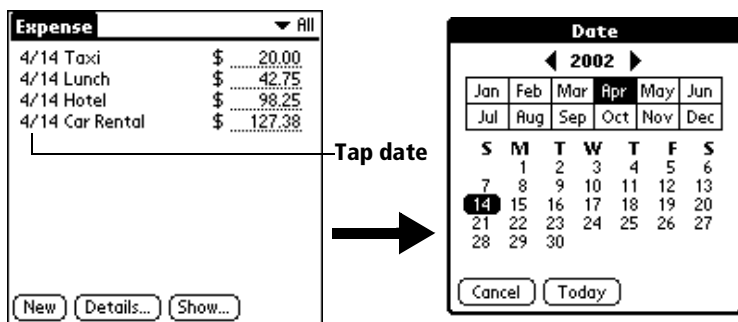

3. Tap the new date.

Entering receipt details

Expense provides a variety of options that you can associate with an item. These options appear in the Receipt Details dialog box.

To open the Receipt Details dialog box:

1. Tap the Expense item to which you want to assign details.
2. Tap Details.



3. Select any of the following options:

Category: See “Categorizing records” earlier in this chapter.

Type: Opens a pick list of expense types.

Payment: Lets you choose the payment method used to pay the Expense item. If the item is prepaid (such as airline tickets supplied by your company), you can choose Prepaid to place your expense in the appropriate company-paid cell of your printed expense report spreadsheet. See “Transferring your data to Microsoft Excel” later in this chapter for more information.

Currency: Enables you to choose the type of currency used to pay the Expense item. The default currency unit is defined in the Preferences dialog box (see “Options menu” later in this chapter). You can also display up to four other common types of currency. See “Customizing the Currency pick list” later in this chapter for more information.

Vendor and City: Lets you record the name of the vendor (usually a company) associated with the expense and the city where the expense was incurred. For example, a business lunch might be at Rosie's Cafe (Vendor) in San Francisco (City).

Attendees: See “Looking up names to add to expense records” earlier in this chapter.

4. Tap OK.

Customizing the Currency pick list

You can select the currencies and symbols that appear in the Currency pick list.

To customize the Currency pick list:

1. Tap the Currency pick list in the Receipt Details dialog box, and then select Edit currencies.

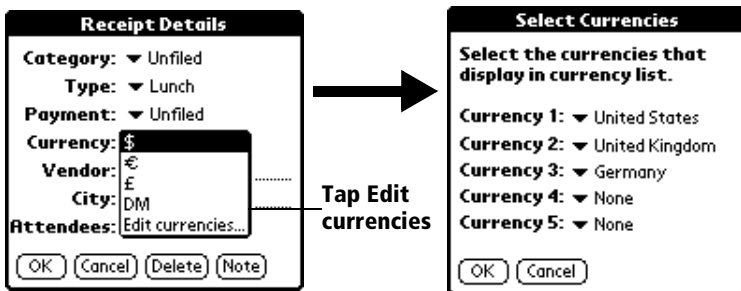

2. Tap each Currency pick list and select the country whose currency you want to display on that line.
3. Tap OK to close the Select Currencies dialog box.
4. Tap OK.

To change your default currency:

1. Open Expense.
2. Tap the Menu icon .
3. Tap Options, and then tap Preferences.
4. Tap the Default Currency pick list.
5. Tap the currency symbol you want to appear in Expense.

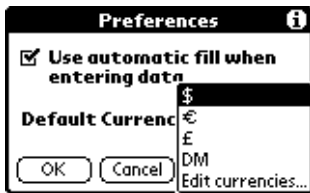

6. Tap OK.

Defining a custom currency symbol

If the currency you want to use is not in the list of countries, you can create your own custom country and currency symbol.

To define a custom currency symbol:

1. Tap the Menu icon .
2. Tap Options, and then tap Custom Currencies.
3. Tap one of the four Country boxes.

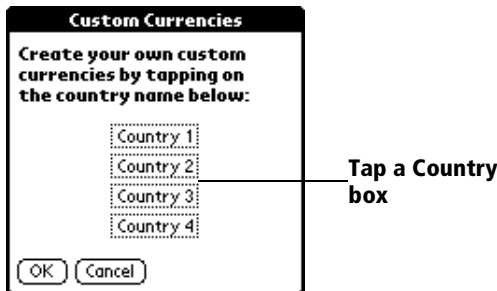

4. Enter the name of the country and the symbol that you want to appear in Expense.



5. Tap OK to close the Currency Properties dialog box.
6. Tap OK.

Note: If you want to use your custom currency symbol as the default for all Expense items, select the symbol in the Preferences dialog box. If you want to use your custom currency symbol only for a particular Expense item, select the symbol in the Receipt Details dialog box associated with that item.

Show Options

Show Options define the sort order and other settings that relate to your Expense items.

To open the Show Options dialog box:

1. In the Expense list, tap Show.
2. Select any of the options.

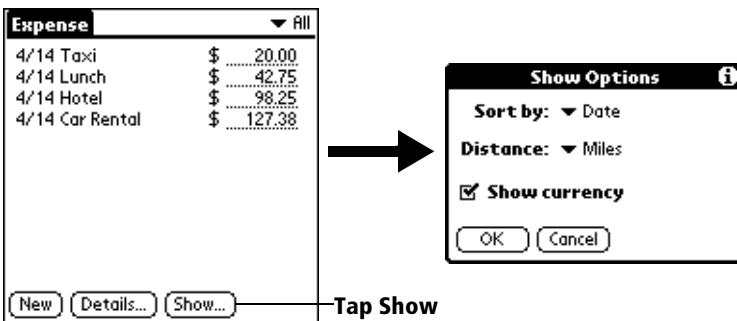

- Sort by** Enables you to sort expense items by date or type.
- Distance** Enables you to display Mileage entries in miles or kilometers.
- Show currency** Shows or hides the currency symbol in the Expense list.

3. Tap OK.

Transferring your data to Microsoft Excel

After you enter your expenses into the Expense application on your handheld, Palm Desktop software enables you to view and print the data with your computer.

Note: You need Microsoft Excel version 5.0 (or later) to view and print your Expense data using one of the provided templates. Microsoft Excel is *not* included with the Palm VII handheld package. The procedures in this section also assume that you have installed Palm Desktop software. See “Palm Desktop organizer software” in Chapter 1 for more information.

Displaying the euro on your desktop computer

When you perform a HotSync operation, the euro symbol is transferred to your Desktop application like any other piece of data on your handheld. The symbol appears in your Desktop application, however, only if you are using fonts that support the euro symbol.

These fonts are part of the operating system on your desktop computer. They do not reside with your Desktop application, and they are not produced by Palm, Inc.

Operating System

Euro Support

Mac OS

Contained in Mac OS 8.5 or higher. For more information, visit the following web site:
<http://til.info.apple.com/techinfo.nsf/artnum/n22222>

Windows 95

Download free font upgrades from the Web. For more information, visit the following web site:
<http://www.microsoft.com/windows/euro.asp>

Windows 98

Includes all the necessary fonts and drivers.

Windows NT 4.0

Download free font upgrades from the Web. For more information, visit the following web site:
<http://www.microsoft.com/windows/euro.asp>

Windows 2000

Includes all the necessary fonts and drivers.

Printing the euro

Even with operating system support, problems may arise while printing documents that contain the euro. When a font is present on both the printer and the computer, the printer font is used by default to increase printing speed. If the printer font does not include the euro, a box prints instead of the euro symbol.

You can work around this problem by sending a bitmap image of the euro to the printer or by not using the printer's built-in fonts (if allowed).

Creating or printing an expense report

You can use Palm Desktop software to view and print your Expense data in a Microsoft Excel spreadsheet.

To create or print an expense report:

1. Perform a HotSync operation to transfer your latest Expense data to your computer.
2. Click Expense in Palm Desktop software to open Microsoft Excel and the Expense Report configuration dialog box.

Note: If you launch Expense from the Start menu instead of Palm Desktop software, you must first choose your handheld user name.

3. Click the expense category that you want.

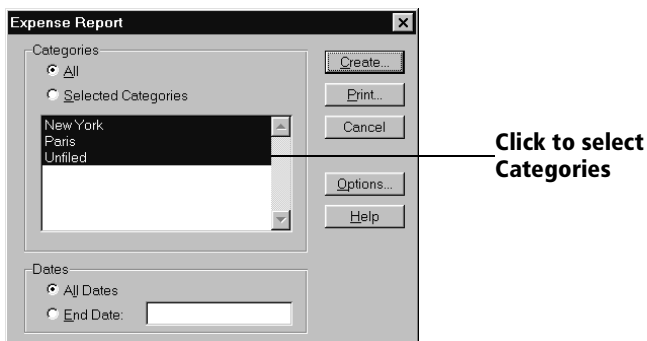

Tip: You can press Ctrl+click to select multiple categories. To print the expenses associated with all of your Expense categories, select All in the Categories group.

4. If you want to define an end date for the expense report, enter the date in the End Date box.

Note: If you do not specify an end date, all expense entries for the selected categories appear — up to the date of the last HotSync operation.

5. Do one of the following:

Click Print to display the expense report in the Print Preview window, and then click Print in the Microsoft Excel window to print your expense report.

Click Create to display a Microsoft Excel spreadsheet containing your expense data. Your data appears in Microsoft Excel spreadsheet form. You can enter information, make formatting changes, and save and print the file in the normal manner.

Using expense report templates

Palm Desktop software includes several expense report templates. When you use one of these templates, you can edit your expense data in Microsoft Excel.

The templates have the extension .xlt and are stored in the template folder in the Palm Desktop software directory on your computer. To see what a template looks like before you use it, open the template in Microsoft Excel. For example, the template Sample2.xlt looks like this:

Sample2.xlt

	1	2	3	4	6	8	10	12	14	16	18	20	22	24	25
1	Travel Expense Report														
2	Expense number			Expense number			Department			Date: 2/3/98					
3	Travel														
4	Date: _____														
5	Bill to: _____														
6	TOTAL														
7	TOTAL														
8	LODGING														
9	Lodging & Hotel														
10	Laundry														
11	Tips														
12	Lodging total														
13	MEALS														
14	Breakfast														
15	Lunch & Snacks														
16	Dinner														
17	Meals total														
18	BUSINESS														
19	Business meals														
20	Conference														
21	Entertainment														
22	Business total														
23	TRANSPORTATION														
24	Airfare														
25	Auto Rental														
26	Auto Maint/Gas														
27	Local Transportation														
28	Tolls/Parking														
29	Miles @ \$\$\$\$ / mile														
30	Trans. total														
31	MISCELLANEOUS														
32	Gifts														
33	Telephone & Fax														
34	Supplies														
35	Postage														
36	Other														
37	Misc. total														
38	TOTAL														
39															
40	Less cash advance														
41	Due employee														
42	Due company														
43															
44															
45															
46															
47															
48															
49															
50															
51															
52															
53															
54															
55															
56															
57	Expense number			Exp #			Date			Expense number					
58	Expense number			Exp #			Date			Expense number					
59	Expense number			Exp #			Date			Expense number					
60	Expense number			Exp #			Date			Expense number					
61	Expense number			Exp #			Date			Expense number					
62	Expense number			Exp #			Date			Expense number					
63	Expense number			Exp #			Date			Expense number					

If you want to streamline or customize your expense reports, you can change these templates. For example, you can add your company name to a template. See Appendix C for information on changing templates.

To view your expense data using a Microsoft Excel template:

1. Display your expense data in a Microsoft Excel spreadsheet as described in the previous procedure.
2. Click Options.

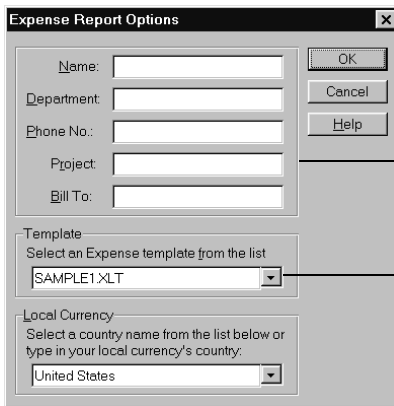

Enter name and other information

Choose expense template

3. Enter name, department, and other information as necessary for your expense report.
4. Click the Templates menu; then select an expense template.

Note: If you want to create your own custom expense template and have it appear in the Templates menu, see Appendix C for more information.

5. Click OK.

Expense menus

Expense menus are shown here for your reference, and Expense features that are not explained elsewhere in this book are described here.

See “Using menus” in Chapter 1 for information about choosing menu commands.

Record menu

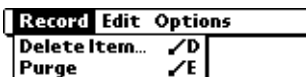

Options menu



Preferences

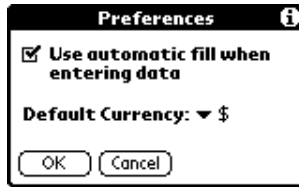

- **Use automatic fill:** Lets you select an expense type by writing the first letter of an expense type in the Graffiti writing area. For example, if you write the letter “T,” it enters the “Taxi” expense type. Writing “T” and then “E” enters “Telephone” which is the first expense type beginning with the letters “TE.”

About Expense Shows version information for Expense.

Chapter 5

Web Clipping Applications and the iMessenger® Application

Your handheld is a wireless device

Your Palm VII™ handheld is equipped with an internal transmitter and an antenna. These components enable your handheld, like a cellular phone, to use a radio frequency to transmit and receive information over the airwaves.

You don't need a modem or a wired connection to a computer to use your handheld as a wireless device, but you must activate the Palm.Net™ wireless communication service. See "Activating the Palm.Net wireless communication service" in Chapter 1 for more information.

After you activate the service, you have access to two wireless features that enhance your ability to stay connected: web clipping and wireless Internet messaging. This chapter describes those features and explains how to use them.

Important: Whenever you use the wireless features of your handheld, please observe the guidelines or prohibitions on the use of wireless devices in your current location. For example, when you are on an airplane, do not raise the antenna or use the wireless features at times when the Federal Aviation Administration (FAA) or airline regulations prohibit the use of cellular phones. You can, of course, use all other applications of your handheld in accordance with airline regulations for electronic devices.

Web clipping applications

Web clipping is a fast and simple way to retrieve specific information from the Internet. It is a simple process of query-and-response: You submit a request for specific information from the Internet and tap a button that transmits your request; within seconds, you receive a response.

Web clipping applications

Just as your web browser gives you access to many different web sites, your handheld gives you access to many different “sites” for web clipping — as many as you care to add and your handheld can store. If you have already set up your handheld, you have some already.

These “sites” are called *web clipping applications*. They were created by third-party developers, but you open them and use them just as you would a basic Palm VII application like Address Book.

Web clipping applications give you access to a wide spectrum of practical Internet information. Each web clipping application is designed to let you query the Internet for a specific kind of information.

For example, the web clipping applications available to you when you set up your handheld and install Palm™ Desktop organizer software give you access to the following kinds of information: traffic and weather conditions; airline, hotel, and restaurant information; locations of automatic teller machines; driving directions; stock market data; movie listings; availability of tickets to local events; business and general news; definitions, spelling, and synonyms of words; and business and residential phone numbers, addresses, and e-mail addresses.

Web clipping, not web browsing

It's impractical to browse the Internet from a small handheld computer and look at elaborate, animated, graphics-laden web pages on a screen the size of your handheld's. As a way to access Internet information, web clipping offers you the following advantages:

- **Convenience:** Because your handheld is a wireless device, you can be walking down the street while accessing the Internet.
- **Focus:** Web clipping applications focus on retrieving small pieces of specific, up-to-date information.

So when you're near a desktop computer and have some time, you can take advantage of the elaborate graphics, variety, and many choices offered by a web site —

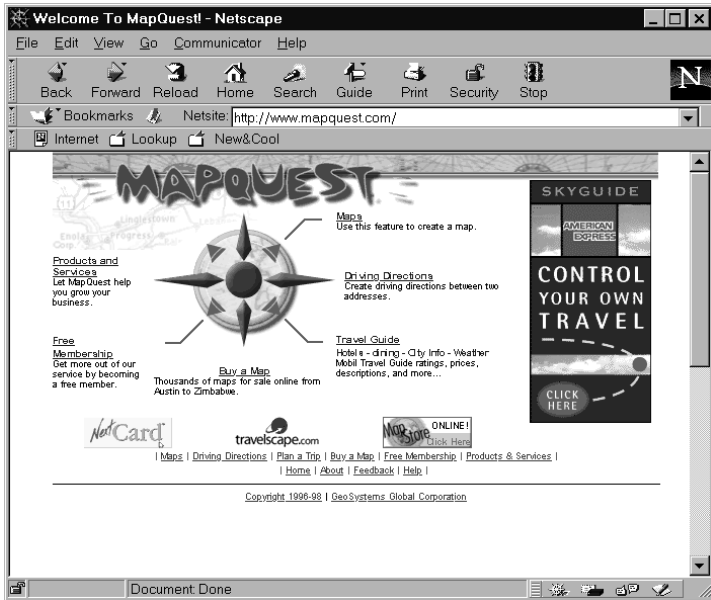

But when you're in a car or on the street and need information fast, a web clipping application on your handheld makes it easy to find the specific information you need —



Adding more web clipping applications

When you set up your handheld, you find that several web clipping applications have been preloaded onto your handheld.

When you install Palm Desktop software on your computer, you can select many more web clipping applications. Use the Install Tool to transfer these to your handheld.

Still more web clipping applications are available on the web site <http://www.palm.net>.

You add web clipping applications to your handheld just as you would any other application. See “Installing add-on applications” in Chapter 3 for details.

Wireless Internet messaging: the iMessenger application

Using the iMessenger® application on your handheld, you can send and receive short text messages.

Your handheld is part of the Palm.Net network. This network receives and stores messages sent to you at your Palm.Net address, and it delivers any message you send directly from your handheld to the Internet e-mail address you specify.

When you activate the Palm.Net wireless communication service, you acquire an address on the network — for example, `username@palm.net`. Then, whenever you’re within coverage of the network, you can communicate with anyone who has an Internet e-mail account.

Important: The iMessenger application is completely independent of the Mail application. Mail does not use the transmitter or the Palm.Net wireless communication service. See “The iMessenger application differs from the Mail application” later in this chapter for details. See Chapter 6 for information about Mail.

The Palm.Net wireless communication service

The Palm.Net wireless communication service includes the following:

- The network through which you access the Internet.
- The web site on which you can track your usage of the service, learn about the service and its features, and find new web clipping applications to download.

- The Palm.Net web clipping application, in which you can also track your usage of the service and learn about the service and its features.
- Customer Care. See the *Getting Started* guide for the support e-mail addresses and phone numbers.
- Convenient credit card billing.

The network

The Internet is often described as a “network of networks,” and the Palm.Net network is just another network tied into the Internet.

The advantage of the Palm.Net network is that your handheld has a wireless, over-the-air connection to it. So long as one of the radio transmitter/receivers of the network can pick up the signal sent by your handheld — referred to as being “within coverage” — you can use web clipping applications and the iMessenger application.

Note: See the important notice at the beginning of this chapter about observing regulations on the use of wireless devices on airplanes and in other locations where their use may be restricted.

Protection of your wireless transactions

Your handheld is equipped with next generation encryption technology from Certicom. This encryption technology is used to secure your credit card number when you activate the Palm.Net service. It is also used by various web clipping applications to secure the transmission of sensitive information such as messages and passwords that are sent over the Palm.Net network. Data is protected both when sent from your handheld over the network and when coming in from the Internet directly to your handheld.

When a wireless transaction is secured, the command button that initiates the transaction is marked not only by the over-the-air icon, but also by the security icon.

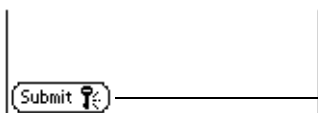

The security icon indicates that your transmission is encrypted

Encryption makes your data unreadable by anyone but the intended recipient. Encryption is done using elliptic curve cryptography, a technology developed by Certicom and used in a wide variety of consumer handheld devices and enterprise applications. For more information about Certicom's encryption technology, visit the Certicom web site <http://www.certicom.com>.

It's not unusual to experience a delay of a several seconds when a wireless transaction is being encrypted.

In addition to the protection provided by the Palm.Net network, individual web clipping applications may add another layer of protection to their transactions. For example, a web clipping application may require you to create and use a password to access sensitive information (for example, your checking account).

See "Wireless preferences" in Chapter 8 for information about preventing the transmission of your location and identification. See "Security" in Chapter 3 for information about locking your handheld. See "Making records private" in Chapter 4 for information about hiding specific records.

The Palm.Net web site: <http://www.palm.net>

The Palm.Net web site is an important source of information about the wireless features of your handheld and about your use of the wireless communication service. The following features are available on the web site:

- **Coverage maps:** Review detailed maps that show where Palm.Net coverage is available. You can also look up a ZIP code to see if an area is within coverage. Go here if you want to report an area where the signal strength is too weak to perform wireless transactions.
 - **My Account:** Check the current status of your account, in both summary and detailed (day-by-day) form. Go here to change your account information and password.
- Note:** Access to My Account is restricted to users who have an account with the Palm.Net wireless communication service. To access My Account, you must log in with the username and password you created during activation.
- **iMessenger application support:** Delete messages, designate a forwarding address, and designate an address to which to send a copy of all your outgoing messages.

- **Support:** Learn about Palm.Net services and wireless features, get answers to frequently asked questions, and submit questions to Palm.Net Customer Care.
- **Web Clipping Apps:** Download the latest web clipping applications to your desktop computer.
- **Web Resources:** Order books about Palm OS® handhelds and sign up for InSync Online, an e-mail service that distributes new web clipping applications, tips about your handheld, and news about Palm OS handheld compatible products. Use the links on this site to visit hundreds of other sites related to Palm OS handhelds.

The Palm.Net web clipping application

The Palm.Net web clipping application is a condensed version of the web site. If you have a question about the service or your use of it, the web clipping application is the first place to go to find your answer.

To open the Palm.Net web clipping application:

- Tap the Palm.Net web clipping application icon: .

You can do the following in the web clipping application:

- Check a summary of the current status of your account
- Read Customer Support topics
- Submit a question or comment to Customer Support

Improving signal strength

Radio signals can be blocked by many kinds of objects in the environment. Trying to perform wireless transactions using a weak signal requires more power from your batteries.

If you experience poor reception, often you can improve it simply by moving five or ten feet in any direction away from the spot where reception is poor. See “Wireless problems” in Appendix B for a list of steps you can take to improve reception.

As you move around to improve reception, you can monitor the increase or decrease in signal strength.

To monitor signal strength in the Diagnostics application:

- Tap the Diagnostics icon .

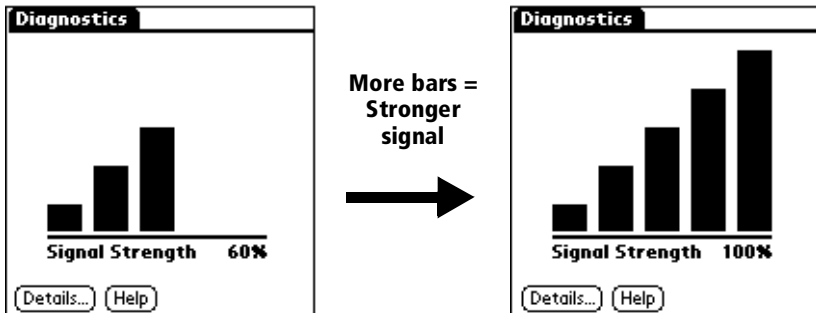

Both the bar graph and the number represent the signal strength:

- The graph represents signal strength as a series of bars. The more bars displayed, the stronger the signal.
- The number represents signal strength as a percentage. The higher the number, the stronger the signal.

You can also monitor signal strength from within web clipping applications and the iMessenger application. A small version of the same bar graph you see in the Diagnostics application appears onscreen when you're performing a wireless transaction.

In web clipping applications



In the iMessenger application



Using web clipping applications

In general, web clipping is a simple process of query-and-response that works like this:

- You open the web clipping application that provides the information you want. For example, you open a web clipping application that reports the weather.
- You submit a query that requests specific information. For example, you ask what the weather forecast is for San Francisco.
- You tap a button that sends your request to the Internet.
- The web clipping application sends your request to the Internet and returns, quickly, with a clipping that gives you only the specific piece of information that you requested.

Opening web clipping applications

When you install web clipping applications, they appear by default in the Palm.Net category of the Applications Launcher. The icons of web clipping applications are easy to recognize: They all have a dark diamond shape as their background and include the over-the-air icon:



Feel free to explore all of your web clipping applications to find out what kind of information they offer. Despite the presence of the over-the-air symbol in its icon, you can open any web clipping application without incurring any cost.

To open a web clipping application:

1. Raise the antenna, located on the right side of your handheld.

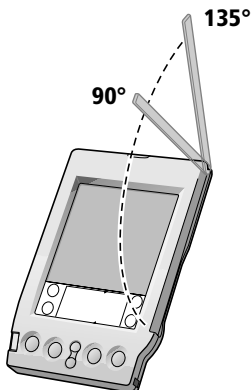

To ensure the best reception: If you are holding the handheld in your hand, raise the antenna to its position at 135° , located at the second click you feel as you raise the antenna. If the handheld is on a flat surface, raise the antenna to its position at 90° .

Raising the antenna automatically opens the Applications Launcher to the Palm.Net category. When the transmitter successfully connects to the network, your handheld beeps.

2. Tap the web clipping application that queries the Internet for the kind of information you want.

Tip: You can set your handheld to open a specific application whenever you raise the antenna. See “Buttons preferences” in Chapter 8 for details.

Working with web clipping applications

Web clipping applications are designed so that you can use them as you use any of the basic applications. The skills you learn in other applications can be applied to working in web clipping applications.

Web clipping applications are similar to basic applications in the following ways:

- You tap to select an item or perform an action just as you do in other applications on your handheld.
- You use Graffiti® writing or the onscreen keyboard to enter text.
- Elements of the interface that look familiar — edit lines, pick lists, check boxes, scroll arrows, buttons, menus, etc. — behave in web clipping applications as they behave in basic applications like Address Book or Memo Pad.
- In edit lines, you can select, cut, copy, and paste text as you do in other applications on your handheld.

Sorted pick lists

In web clipping applications, pick lists of words sorted alphabetically or numbers sorted in ascending order work in the same way that Phone Lookup works: if you write the first letter of a word, the list scrolls to the first entry that begins with that letter. If you write the first two letters, the list scrolls to the entry that starts with those two letters; and so on, until the letters you write identify a unique entry.

For example, when you select a state from an alphabetical list of states, writing “m” causes the list to scroll to and select Maine. If you then write “o,” the list selects Montana and enters it in the field.

Actions that incur a cost

Tapping a command button or other object that displays the over-the-air icon initiates a wireless transaction. Typically, you incur a cost whenever you perform a wireless transaction. This cost takes the form of either (1) a deduction from the kilobytes included in your monthly plan or (2) if your monthly kilobytes have been used up, an additional charge. Consult <http://www.palm.net> or the Palm.Net web clipping application for details on billing.

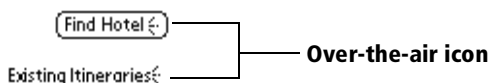

Simply reviewing the contents of a web clipping application does not initiate a wireless transaction and costs nothing.

To submit a query to the Internet:

1. Raise the antenna.
2. Tap the icon of the web clipping application you want to open.
3. Follow the directions onscreen for specifying the information you want from the Internet.

Some web clipping applications need you to identify a location in order to give you useful information. For example, web clipping applications that report the weather or list movie theaters need to know the location for which you want information.

Such web clipping applications may ask you to specify the ZIP code of the location you're interested in.

4. Tap the button or other object that displays the over-the-air icon to submit your query to the Internet.

The response — your clipping— typically appears onscreen within seconds.

To stop a wireless transaction:

- Tap the Stop icon.



Any data that is downloaded to your handheld before you tap the Stop icon appears onscreen.

Important: You incur a cost for any data that is downloaded to your handheld or sent to the Palm.Net server.

Reviewing current queries and clippings: Back arrow

Your handheld stores the queries and clippings of your current session so that you can review them. Use the Back arrow to review the pages you displayed since you opened the web clipping application.

To go back to a previously viewed page:

- Tap the Back arrow  in the web clipping application you want to review.

Note: You do not incur a cost when you review pages.

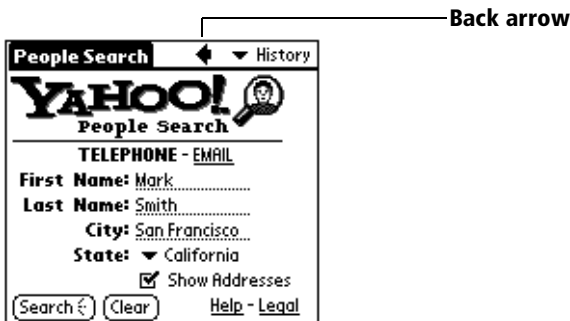

Example of web clipping

This example takes you through the process of finding someone's phone number and address using the Yahoo!® People Search web clipping application. This web clipping application is preloaded on your handheld.

To find a phone number and an address:

1. Raise the antenna.

Raising the antenna automatically opens the Applications Launcher to the Palm.Net category. If you moved the Yahoo! People Search web clipping application, go to that category.

2. Tap the Yahoo! People Search icon.
3. Tap the First Name edit line and enter the first name of a person whose address and phone number you want to find.

You can use Graffiti writing or the onscreen keyboard to enter data.

4. Enter the last name of the person and the city where the person lives.
5. Tap the State pick list and select the state where the person lives.

Tip: Writing the first few letters of the state you want causes the list to scroll to the first entry that begins with those letters. For example, write "ca" to select and enter California.

6. (Optional) If you want to find the address of the person, tap the Show Addresses check box to select it.
7. Tap Search.

People Search ← History

YAHOO!
People Search

TELEPHONE - EMAIL

First Name: Mark.....

Last Name: Smith.....

City: San Francisco.....

State: ▼ California

Show Addresses

Search Clear Help - Legal

Tap here to submit your query

Within seconds, your clipping appears. In this case, the web clipping application found two items that satisfy your query.



How big was that clipping?

After you receive a clipping, you can find out the size of the clipping. If you see two exclamation points (!!) in the title area, the clipping is larger than 1,000 bytes.

To see the size of a clipping:

1. Tap the Menu icon .
2. Tap Options, and then tap Info. The Info dialog box shows how many bytes the clipping contains.

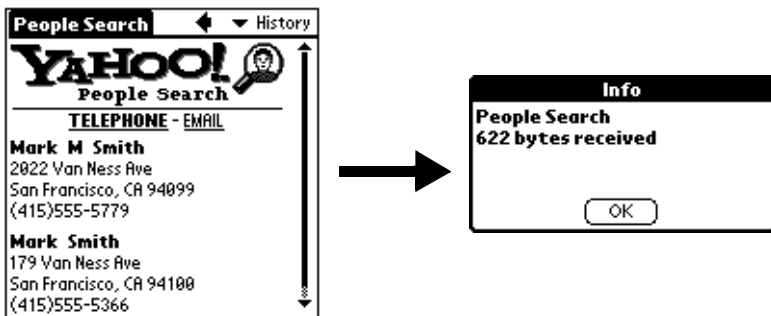

Reviewing stored clippings: History list

You can see a list of stored clippings in the History list and then select the one you want to review. You can see clippings that pertain only to the web clipping application that is open. When you open another web clipping application, the History list changes to display only clippings that you received in that web clipping application.

Note: You do not incur a cost when you review clippings in the History list.

To review the History list:

1. Open the web clipping application that has clippings you want to review.
2. Tap the History pick list.



3. Select the clipping you want to review.

Saving information from a web clipping application

You can copy the text in a clipping or a page of a web clipping application and paste it into another application. For example, you can copy an address you receive as a clipping from Yahoo! People Search and paste the address into Address Book.

To save the text of a clipping or page:

1. Make sure the clipping or page you want to copy is onscreen.
You can use the Back arrow or the History list to display the clipping or page you want.
2. Tap the Menu icon .
3. Tap Edit, and then tap Copy Page.
4. Open one of the basic applications, such as Address Book or Memo Pad.
5. Create a new record.
6. Tap the Menu icon.
7. Tap Edit, and then tap Paste.

Keep the following points in mind about the Copy Page command:

- Copying always starts at the top of the current clipping or page, regardless of what is displayed onscreen.
- The Copy Page command copies only the first 4,000 bytes (4KB) of data. If the clipping or page you copy contains more than 4KB of

data, your handheld appends the word “truncated” to the end of the pasted text.

- The Copy Page command does not copy images or icons; table structures; or text formatting such as bold, italics, and so on.

Sending e-mail from a page

If a web clipping application or clipping gives you the opportunity to reply to an e-mail address, you can do so.

To send e-mail from a page:

1. Tap the address displayed in the page.

The iMessenger application opens. The To: field contains the address to reply to.

2. Enter the text of your message.

3. Do one of the following:

Tap Put in Outbox to file the message in the Outbox. Your message is sent the next time you open the iMessenger application and tap Check & Send.

Tap Cancel, and then tap Yes to save the message in the Draft folder of the iMessenger application. Tap No to delete the message.

Web clipping application menus

All web clipping applications have the same menus. Web clipping application menus are shown here for your reference, and web clipping application features that are not explained elsewhere in this book are described here.

See “Using menus” in Chapter 1 for information about choosing menu commands.

Options menu



About Web Clipping

Shows version information for the web clipping technology that supports web clipping applications.

Using the iMessenger application



In addition to the Mail application and infrared (IR) beaming, which are explained in Chapter 6, your handheld offers you another way to stay in communication with others: wireless Internet messaging.

By activating the Palm.Net wireless communication service, you acquire an address and mailbox on the Palm.Net network. You can then use the iMessenger application to send and receive short text messages. Whenever you're within coverage of the network, you can use the iMessenger application to be in contact with anyone who has an Internet e-mail account.

In the iMessenger application, you can do the following:

- Download messages waiting for you on the Palm.Net network.
- Read, delete, reply to, and reroute incoming messages.
- Create outgoing messages and drafts of messages.
- Send messages to any Internet e-mail address directly from your handheld.

The iMessenger application differs from the Mail application

The iMessenger application is completely independent of the Mail application. You use them differently, and they do not interact in any way. You do not have to choose between Mail and the iMessenger application, however. You can use both.



Icon of the iMessenger application



Icon of the Mail application

One convenient similarity between the iMessenger application and Mail is this: skills you learn in one application you can easily transfer to the tasks you do in the other. For example, writing text, looking up addresses, viewing header information, saving drafts, and purging deleted items are all done the same way in both applications.

Mail depends on your computer

You use Mail to manage the e-mail that you receive in your desktop computer's E-Mail application. When you create e-mail items in Mail, you cannot send them out directly from your handheld; rather, you must first synchronize your handheld with your computer. At that time, e-mail items you created in Mail are transferred to your desktop E-Mail application and sent out through that application. Mail does not use the transmitter or the Palm.Net wireless communication service. See Chapter 6 for complete information about Mail.

The iMessenger application is independent of your computer

The iMessenger application is a wireless feature. By taking advantage of the wireless capability of your handheld, the iMessenger application enables you to send and receive messages even though you may be miles away from any desktop computer. You work only with your handheld to create, send, receive, and otherwise manage messages. Synchronizing with your computer does not transfer iMessenger messages to your desktop E-Mail application.

Opening the iMessenger application

1. Raise the antenna, located on the right side of your handheld.

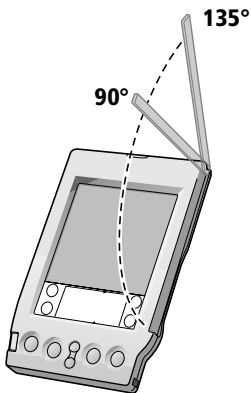

To ensure the best reception: If you are holding the handheld in your hand, raise the antenna to its position at 135°, located at the second click you feel as you raise the antenna. If the handheld is on a flat surface, raise the antenna to its position at 90°.

Raising the antenna automatically opens the Applications Launcher to the Palm.Net category. When the transmitter successfully connects to the network, your handheld beeps.

2. Tap the iMessenger icon .

Tip: You can set your handheld to open the iMessenger application directly whenever you raise the antenna. See "Buttons preferences" in Chapter 8 for details.

Checking for and viewing messages

The iMessenger list screen of the Inbox lists your downloaded messages, who sent them, and optionally, the date they were received. (See “Date column” later in this chapter.)

- Unread messages have a dash (—) next to them.
- Messages you’ve already read have a check mark (✓) next to them.
- Messages you create have a diamond (◆) next to them.

You can tap these symbols to open a menu of commands that you can use in the current context.

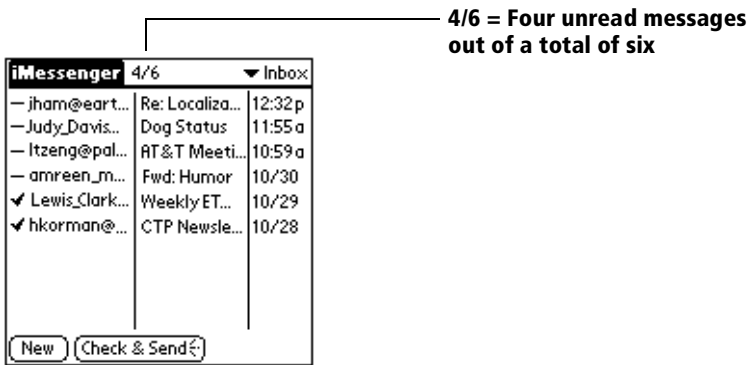

To check for new messages:

- Tap Check & Send.

Tapping Check & Send accomplishes two actions:

- Downloads messages that are waiting for you on the network
- Sends out messages that are in the iMessenger Outbox

A Transaction Progress message box appears onscreen and tracks the progress of the transaction.

The iMessenger application downloads no more than ten messages at a time to your handheld. The Transaction Progress message box notifies you if more messages are waiting for you on the network.

To cancel a wireless transaction:

- In the Transaction Progress message box, tap Cancel.

Any messages that were downloaded to your handheld before you tapped Cancel appear in the Inbox.

Important: You incur a cost for the number of kilobytes you sent to the server or downloaded before you tapped Cancel.

To view a log of the most recent wireless transaction:

1. Tap the Menu icon .
2. Tap Options, and then tap Show Log.

To open a message:

- In the iMessenger list screen, tap a message to open it.

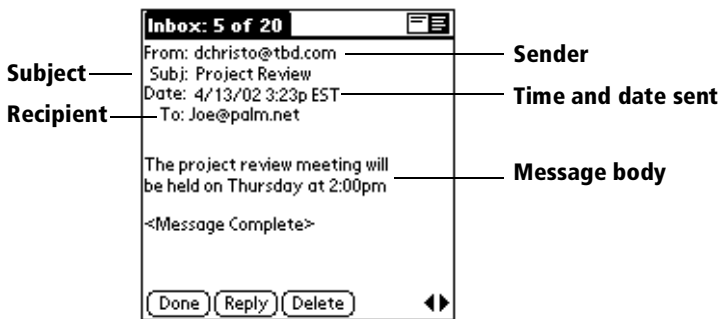

To close a message:

- Tap Done.

Opening and reading messages

A message is downloaded from the network in compressed characters. When you open the message, the characters are converted to an uncompressed, readable form.

The message arrives in segments, each comprising 500 readable characters.

Note: You are charged for the number of bytes downloaded as compressed characters, not by the number of readable characters.

Short messages and long messages

The following table outlines how incoming messages of various lengths are treated:

If a message has *x* readable characters

Then this happens:

500 or fewer characters

The entire message is downloaded. <Message Complete> appears at the end of the message.

500 - 50,000 characters

The first 500 characters are downloaded. A message at the end tells you how many readable characters are left to be retrieved. You can download as much of the rest of the message as you want or ignore what's left.

More than 50,000 characters

Palm.Net service returns the message to the sender as undeliverable.



— Marks the end of a message

— Tap right arrow to view the next message, left arrow for the previous one

Downloading the remainder of a long message

You download long messages in separate segments so that you can choose how much of the message you want to read (and pay for).

To download more of a long message:

1. At the bottom of the screen, tap More.

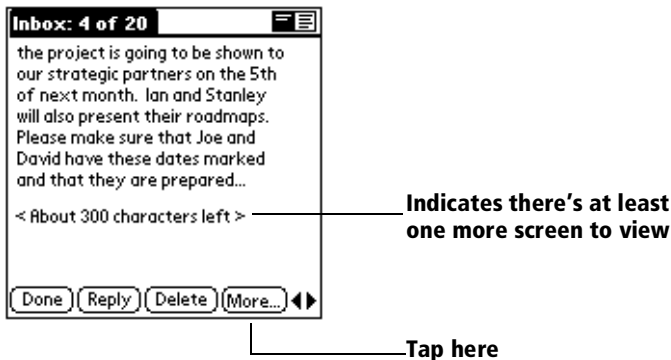

The Retrieve More dialog box appears.

2. Do one of the following:

For a message with fewer than 500 characters left, tap Get Rest.



For a message with more than 500 characters left, a different Retrieve More dialog box appears. Tap one of the following:

Get Next: Retrieves the next 500 characters of the message

Get Rest: Retrieves all the remaining text of the message



The maximum amount you can download in one transaction is 6,000 characters. If you want to get the rest of a message that has more than 6,000 characters left to download, you can download only 6,000 characters at one time. The Retrieve More dialog box looks like this:



Note: You don't have to download all the segments of a long message at one time. From the time you download the first 500 characters, you have a maximum of 30 days to download the remainder of the message. Then it's deleted from your mailbox on the Palm.Net network.

Displaying header information

Complete header information includes the distribution lists and the From:, Subj:, and Date: fields. By default, the iMessenger application displays abbreviated header information, which comprises only the From: and Subj: fields.



Abbreviated header icon

To display complete header information:

1. Open a message.
2. Tap the complete header icon.

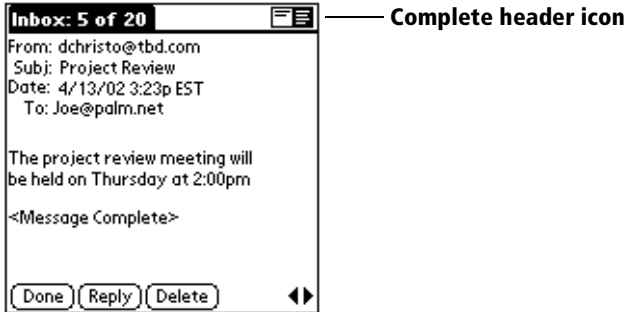

Tip: To redisplay the abbreviated header, tap the abbreviated header icon.

The iMessenger application uses the header type you select for all incoming messages.

Distribution lists of incoming messages

Distribution lists are the addresses in the To:, CC:, and BCC: fields of an incoming message. A maximum of 300 of the first 500 characters of a message is used to download the distribution lists. (A maximum of 100 characters is used to download the text in the Subj: field.)

If a distribution list must be truncated, an ellipsis (. . .) appears after the last name. There is no way to retrieve the truncated part of the list.

Your address (username@palm.net) always appears as the first address in the distribution list you are part of. After your address is downloaded, as much of the remaining information in the distribution lists is downloaded, up to the maximum 300 characters, in the following order: the To:, CC:, and BCC: fields.

Attachments

The iMessenger application does not support attachments, with one exception: If an attachment is a simple ASCII text file, the iMessenger application appends the text of the file to the end of the message, so you can read it as part of the body of the message.

Otherwise, when you open a message that was sent to you with any other kind of attachment, a message notifies you that the attachment cannot be downloaded. To prevent attachments from taking up space in your Palm.Net mailbox, delete the message as soon as you can.

One way to retrieve attachments sent to you is to have all messages delivered to your Palm.Net mailbox also delivered to your e-mail address. See "Identifying a forwarding address" later in this chapter.

Creating messages

To create a message in the iMessenger application, you identify the recipient(s) of the message, define a subject, and create the body of the message.

Note: A new message in the iMessenger application does not have CC: (copied) or BCC: (blind carbon copy) fields. You can, however, add as many names to the To: field as you like.

You create original messages and replies in the New Message screen. All messages must, at the very least, contain information in the To: field.

To create a message:

1. Tap New.

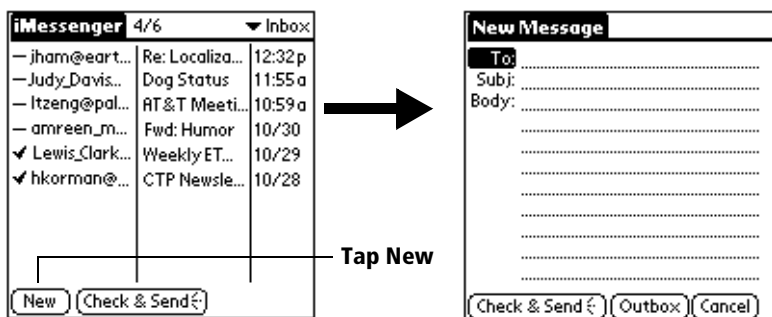

Tip: You can also create a message by tapping New from the Message menu.

2. Enter the e-mail address of the recipient.



You have two ways to enter the at sign (@):

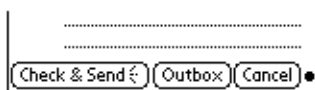

Tap once in the Graffiti writing area to activate Punctuation Shift. A dot appears

Then make this stroke



Or, tap "123" in the Graffiti writing area. Then tap @ on the numeric keyboard

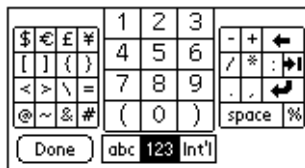

When you enter more than one address in the To: field, separate the addresses with commas or spaces, or enter each address on its own line.

3. Tap the Subj: field and enter a subject for your message.
4. Tap the Body: field and enter the text of your message.

Tip: If the address, subject, or body exceeds the capacity of the screen display, tap the name of the field (for example, tap "To:") to expand that field. Tap the Done button to return to the New Message screen.

Tap the name of the field to open

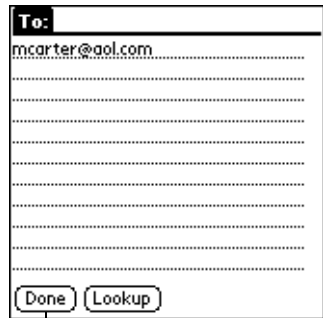
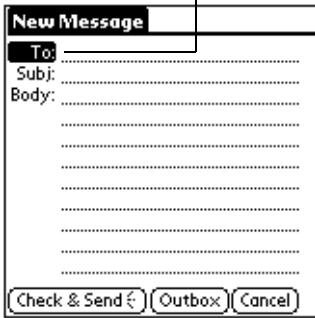

Tap to return to New Message screen

To reply to a message:

1. Tap a message in the iMessenger list to display it onscreen.
2. Tap Reply.
3. Select whom you want to reply to: Sender only or Forward (for someone who didn't see the original message).

Note: Although the iMessenger application does not have a "reply to all" option, you can add as many names to the To: field as you like.



4. Select whether you want to include original text and if so, whether you want to insert comments within the original text.

If you decide to insert comments, each line of the original text is marked with a >.

5. Tap OK.
6. Enter the text of your reply.
7. Tap Check & Send to send the message immediately. Tap Outbox to place the reply in the Outbox.

Looking up an address

To identify the recipient of a message, you need to enter that person's e-mail address. You can do this either by entering the data directly into the field or by using the Look Up command to access the information in your Address Book.

To look up an e-mail address:

1. Tap the To: field name to expand it.
2. Enter the first few letters of the last name of the person whose address you want to find.
3. Tap Lookup.
4. If the letters you enter identify a unique listing from your Address Book, your handheld completes the address for you. If not, the Lookup dialog box appears and lists all records that contain information in an E-mail field.

Tip: You can also open the Look Up dialog box in the New Message screen by tapping Lookup from the Options menu or by using the Graffiti Command stroke /L.

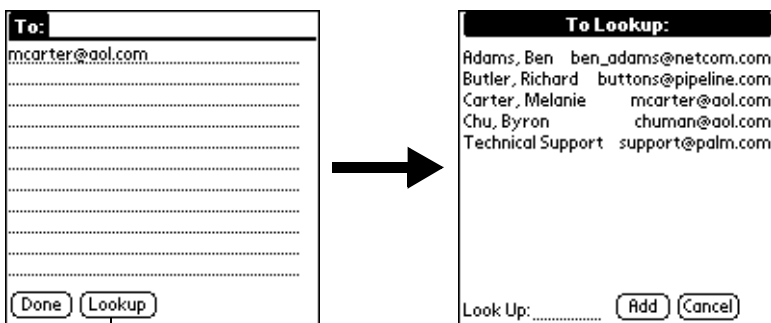

Tap Lookup

5. Enter the first letter of the entry you want to find to scroll to the first entry that begins with that letter. If you write an additional letter, the list scrolls to the first entry that starts with those two letters. For example, writing a "c" scrolls to "Carter," and writing "ch" scrolls to "Chu."
6. Tap an address to select it.
7. Tap Add.

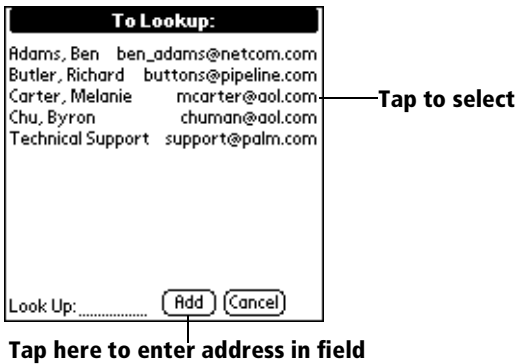

Rerouting replies to your messages

The From: field of your outgoing iMessenger messages contains your @palm.net address. If you don't want people who receive your messages to reply to you at your @palm.net address, you can specify a different address for recipients to use.

To reroute replies to your messages:

1. Tap the Menu icon .
2. Tap Options, and then tap Preferences.
3. In the edit line for Reply To Address, enter the address where you want to receive replies to your messages.



4. Tap OK.

When recipients reply to your message, their e-mail application automatically uses the Reply To address that you specify.

Note: The iMessenger application uses this address for *all* wireless Internet messages you subsequently send.

Adding a signature to your message

Adding a signature to your message is a two-part process. First, you create your signature. Then, every time you want to add your signature to a message, you must tap Add Signature.

The signature for your wireless Internet messages can be different from the signature you define in the Mail application.

To create a signature:

1. Tap the Menu icon .
2. Tap Options, and then tap Preferences.
3. Tap Signature.
4. Enter the text of your signature.

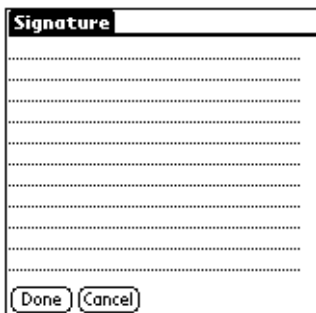

5. Tap Done.

To add a signature to your message:

1. In the new message you're creating, position the blinking cursor where you want to insert your signature.
2. Tap the Menu icon .
3. Tap Options, and then tap Add Signature.

Tip: You can also add your signature to the message by using the Graffiti Command stroke /Z.

The signature appears at the end of your message.

Sending messages

You can send wireless Internet messages anytime the handheld antenna is raised and you are located within coverage of the Palm.Net wireless communication service.

To send messages:

- Tap Check & Send.

Tapping Check & Send sends the current message and all messages in the Outbox. This command also downloads messages that are waiting for you on the network.

You can store messages in the Outbox and then send them at another time. For example, you can create messages and store them until you're in a location that is within coverage of the wireless communication service.

To store messages and send them later:

1. Create a message.
2. Tap Outbox.

The message is stored in the Outbox.

3. If you have more messages to write, repeat steps 1 and 2.
4. Tap Check & Send when you're ready to send the messages waiting in the Outbox.

To cancel a wireless transaction:

- In the Transaction Progress message box, tap Cancel.

Important: You incur a cost for the number of kilobytes you sent to the server or downloaded before you tapped Cancel.

You can check the log to see which messages were sent.

To view a log of the most recent wireless transaction:

1. Tap the Menu icon .
2. Tap Options, and then tap Show Log.

Editing an unsent message

You can make changes to a message that has not yet been sent. When you edit a message, your handheld removes the message from the Outbox folder and takes you back to the New Message screen, where you can edit the message and resend it, save it as a draft, or delete it.

To edit an unsent message:

1. In the iMessenger list screen, tap Outbox from the pick list in the upper-right corner.

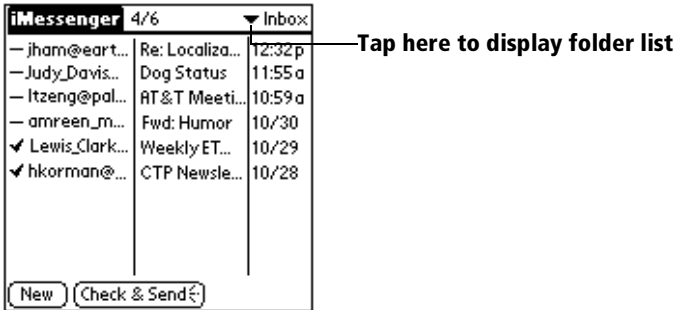

2. In the Outbox folder, tap the message you want to view.

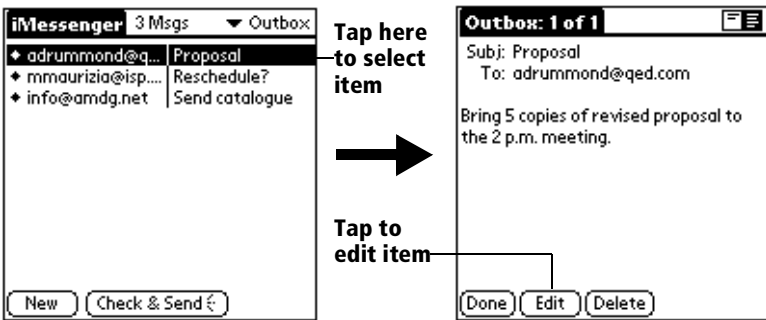

3. Tap Edit.

Draft messages

Sometimes you may not want to send a message immediately; for example, you may want to add additional information before sending it. Your handheld stores such messages in the Draft folder until you are ready to edit them again.

Note: When you're creating or editing a message, you can also save the item as a draft by canceling it. When you cancel a message, your handheld opens a dialog box asking if you want to save the message. If you tap Yes, your handheld saves the message in the Draft folder.

To save a message as a draft:

1. Create a message.
2. Tap the Menu icon .
3. Tap Message, and then tap Save Draft.

Tip: You can also save your message as a draft by using the Graffiti Command stroke /D.

To edit a message saved as a draft:

1. In the iMessenger list screen, tap Draft from the pick list in the upper-right corner.
2. Tap the draft you want to display.

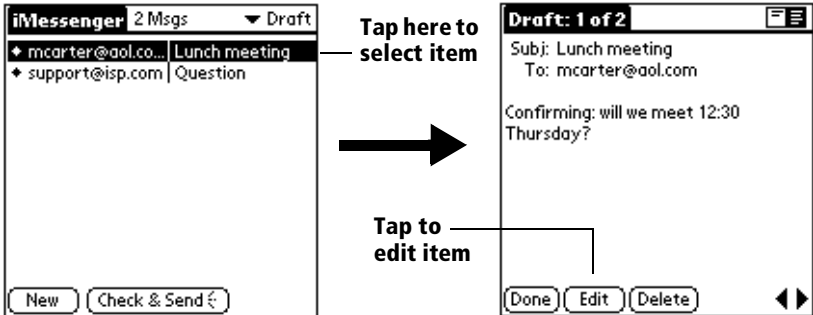

3. Tap Edit and enter your changes.
4. Do one of the following:
 - Tap Cancel and then Yes to save the message again as a draft.
 - Tap Check & Send to send the message.
 - Tap Outbox to move the item to your Outbox folder.

Filing a message

Your handheld can store any message you receive or create in the Filed folder.

To file a message:

1. Open the message.
2. Tap the Menu icon .
3. Tap Message, and then tap File.

To remove a message from the Filed folder:

1. In the iMessenger list screen, tap Filed from the pick list in the upper-right corner.
2. Tap the message you want to view.
3. Tap Edit or Reply to modify the message.

Tip: After you display and modify the message, you can send it now, move it to the Outbox, save it as a draft, or leave it in the Filed folder.

Deleting messages

Your handheld stores deleted messages in the Deleted folder until the folder reaches its maximum storage capacity of 50 kilobytes. At that point, messages in the Deleted folder are purged to make room for newly deleted messages. The message in the Deleted folder with the oldest date is purged first, then the one with the next oldest date, and so on, until there's enough space in the folder to hold the newly deleted message.

See "Purging deleted messages" later in this chapter to learn how to manage the size of the Deleted folder. See "Your Palm.Net mailbox" later in this chapter to learn about the storage and deletion of messages in your mailbox on the network.

To delete a message:

1. Open the message you want to delete.
2. Tap Delete.

Removing a message from the Deleted folder

You can remove a message from the Deleted folder and work with it again.

To remove a message from the Deleted folder:

1. In the iMessenger list screen, tap Deleted from the pick list in the upper-right corner.
2. Tap the message you want to restore.
3. Tap Undelete.

The handheld moves the message to the folder from which you deleted it and opens that folder.

Purging deleted messages

The Deleted folder has a maximum storage capacity of 50 kilobytes. To prevent deleted messages from taking up storage space on your handheld, purge the contents of your Deleted folder.

Note: You cannot restore messages after you purge them.

To purge the contents of the Deleted folder:

1. Tap the Menu icon .
2. Tap Message, and then tap Purge Deleted.
3. Tap Yes.

Tip: You can also purge deleted messages by using the Graffiti Command stroke /E.

Options for the iMessenger list screen

You can manage the way the iMessenger list screen displays information.

Folders

The iMessenger application provides folders for categorizing your messages. The iMessenger list screen displays the messages that are in the folder you select.

To select a folder:

1. Tap the pick list in the upper-right corner to open the list of folders:

Inbox: Contains messages downloaded from the network.

Outbox: Contains messages for which you tapped Outbox when you created them. Messages in the Outbox are sent out whenever you tap Check & Send.

Deleted: Contains messages you deleted. Purge these messages to free space on your handheld.

Filed: Contains messages you want to store on the handheld.

Draft: Contains messages you created but are not yet ready to send.

2. Select the folder you want to display.

Date column

The Date column is an optional part of the iMessenger list. By default, the Date column option is set to display. Turn it off to increase the amount of screen space available for the From: and Subj: fields.

Messages downloaded the same day on which they were sent display the time that they were received. Messages downloaded on a day after they were sent display the date they were received.

To show the Date column:

1. In the iMessenger list screen, tap the Menu icon .
2. Tap Options, and then tap Preferences.
3. Tap the Show Date check box to select it.



4. Tap OK.

Sorting the iMessenger list

You can sort messages by the date sent, by sender, or by subject.

To sort the iMessenger list:

1. In the iMessenger list screen, tap the Menu icon .
2. Tap Options, and then tap Preferences.
3. Tap the Sort by pick list and select one of the following options:
 - Date:** Sorts by date and displays the most recent message at the top of the screen.
 - Sender:** Sorts by sender's user name and displays messages in ascending alphabetical order, based on the first word of the From: field.
 - Subject:** Sorts by subject and displays messages in ascending alphabetical order, based on the first word of the Subj: field.
4. Tap OK.

Your Palm.Net mailbox

Your mailbox on the Palm.Net network has a storage capacity of up to 2 MB; that's more than two million readable characters.

Attachments of messages in your mailbox take up storage space even though most attachments cannot be downloaded to your handheld. Messages that are larger than 50KB are not stored in your mailbox at all because they cannot be delivered to your handheld; rather, they're returned to the sender as undeliverable.

A full mailbox

If your mailbox should run out of storage space, incoming messages are returned to the sender as undeliverable. To make room quickly in a full mailbox, you can delete blocks of messages. See "Deleting messages from your mailbox" below.

Life span of a message on the network

After you download the complete text of a message, or part of a long message, the message remains in your mailbox for 30 days. After 30 days, it is deleted from your mailbox.

Important: A message that you do not download to your handheld remains in your mailbox for 60 days. After 60 days, it is deleted from your mailbox.

Identifying a forwarding address

You can have all messages that are delivered to your Palm.Net mailbox also delivered to another address. Go to the web site <http://www.palm.net> and follow the instructions onscreen for identifying a forwarding address. This can be useful if you want to be able to retrieve attachments that are sent to you.

Keeping a copy of messages you send

You can keep a copy of your outgoing iMessenger messages by identifying an address to which to send a blind carbon copy of your messages. Go to the Palm.Net web site and follow the instructions onscreen for identifying a blind carbon copy address.

Deleting messages from your mailbox

You can delete blocks of messages directly from your Palm.Net mailbox. Go to the Palm.Net web site and follow the instructions onscreen. You can delete messages older than two weeks, older than four weeks, or all messages in the mailbox. You cannot look at your messages from the web site, and you cannot delete individual messages.

The iMessenger application and HotSync operations

The iMessenger application is independent of Palm Desktop software, with this exception: when you synchronize your handheld with Palm Desktop software, the following information is stored on your computer:

- Your iMessenger application preferences
- A record of what is currently in the iMessenger application, including the last message you downloaded from the network

This information becomes useful if you do a hard reset of your handheld. A hard reset erases all data on your handheld, including messages in the iMessenger application.

Important: *Synchronize immediately after you do a hard reset in order to restore the record of what messages were on your handheld before the hard reset.* Then the next time you use the Check & Send command, only messages you have not read yet are downloaded from the network.

See “Performing a hard reset” in Appendix A for more information.

To enable synchronization of the iMessenger application with a Macintosh computer, Macintosh users need a special version of Palm Desktop software. Go to the web site <http://www.palm.net> for information about this software.

iMessenger menus

iMessenger menus are shown here for your reference, and features that are not explained elsewhere in this book are described here.

See "Using menus" in Chapter 1 for information about choosing menu commands.

Pop-up menus

In the iMessenger list screen, tap the icon (a dash, check mark, or diamond) at the left to open a menu of commands that you can use in the current context.

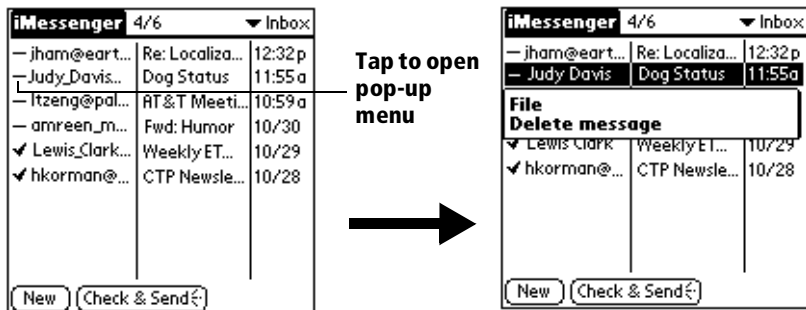

Message menus

The Message menu varies depending on whether you are viewing a message, creating a message, or viewing the iMessenger list.

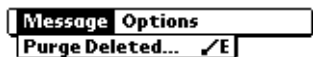

iMessenger list

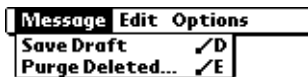

New Message

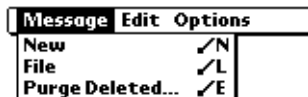

View Message

Options menus

The Options menu varies depending on whether you are viewing a message, creating, or viewing the iMessenger list.



iMessenger list



New Message



View Message

About iMessenger

Shows version information for the iMessenger application.

Chapter 6

Managing Desktop E-Mail and Beaming Information

In addition to web clipping and wireless Internet messaging, your Palm VII™ handheld offers features to help you stay connected:

- **Managing desktop E-Mail:** Using your handheld, you can read, reply to, compose, and delete e-mail from your desktop E-Mail application while you're away from your desk.

Note: The Mail feature is completely independent of the iMessenger® application for wireless Internet messaging. Mail does not use the transmitter or the wireless communication service. See “The iMessenger application differs from the Mail application” in Chapter 5 for details.

- **IR beaming:** The infrared port located at the top of your handheld lets you send data from your handheld — including entire applications — to any other Palm OS® handheld that's close by and also equipped with an IR port.

Managing desktop E-Mail away from your desk



Mail lets you manage the e-mail that you send and receive through the E-Mail application on your desktop computer. You can read, reply to, compose, and delete e-mail on your handheld; but to send or receive e-mail, you must perform a HotSync® operation either directly or indirectly. Direct methods include placing your handheld in the cradle attached to your computer, or using infrared communications. Indirect methods include using a modem, or using network HotSync technology.

Mail truly synchronizes the Inbox in your desktop E-Mail application with the mail on your handheld. For example, if you delete e-mail items from Mail, your next HotSync operation also deletes the e-mail items from your desktop E-Mail application, so you never have to delete e-mail items twice. Similarly, if you read an e-mail item on your handheld and leave it in your Inbox, your next HotSync operation marks it as read in your desktop E-Mail application.

In Mail, you can do the following:

- View, delete, file, and reply to incoming mail.
- Create outgoing e-mail items and drafts of e-mail items.
- Create simple or complex filters, which allow you to decide the type of e-mail that your handheld retrieves from your desktop E-mail application.
- Use your handheld in its cradle to send and retrieve e-mail items from your desktop E-Mail application.

Setting up Mail on the desktop

Before you use Mail for the first time, make sure your desktop E-Mail application is up and running. You must also set up Palm™ Desktop organizer software for use with your desktop E-Mail application.

Your handheld supports a number of desktop E-Mail applications, such as Microsoft Exchange (version 4.0 or higher), Microsoft Windows Messaging 4.0, Microsoft Outlook, Microsoft Outlook Express, QUALCOMM Eudora (version 3.0.3 or higher), and Lotus cc:Mail (versions 2.5, 6.0, and 7.0). You can see the full list of the supported applications when you set up Mail.

If your desktop E-Mail application does not appear on the list, you may still be able to manage your desktop E-Mail application from your handheld by means of special connection software, called a conduit, that lets you synchronize your desktop E-Mail application and your handheld. Contact the vendor of your E-Mail application for more information.

Note: The following instructions assume that you have already installed Palm Desktop software on your computer and that you did not set up Mail during the installation. If you have not yet installed the Palm Desktop software, the installation procedure prompts you to set up Mail as part of the Palm Desktop software installation.

To set up Mail:

1. Click Start in the Windows taskbar.
2. Highlight Programs, highlight Palm Desktop software, and then click Mail Setup to begin setup.
3. Follow the instructions onscreen to set up your handheld for use with your desktop E-Mail application.

To select HotSync options:

1. Click the HotSync icon  in the Windows system tray (bottom-right corner of the taskbar).
2. Choose Custom.

Tip: You can also choose Custom from the HotSync menu in Palm Desktop software.

3. Select Mail in the list box.
4. Click Change.

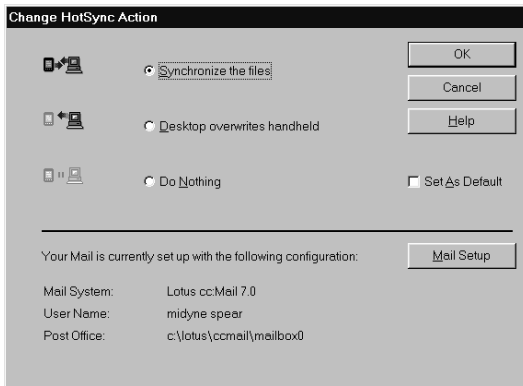

5. Click one of the following settings:

Synchronize the files: Synchronizes the mail on your handheld and your desktop E-Mail application.

Desktop overwrites handheld: Replaces the mail on your handheld with the mail in your desktop E-Mail application. You should use this option only if, for some reason, the two inboxes get out of sync. This setting applies for only one HotSync operation and then reverts back to the default setting.

Do Nothing: Turns off communication between your handheld and desktop E-Mail application. This setting applies for only one HotSync operation and then reverts back to the default setting.

Note: Changing the HotSync setting from the default affects only the *next* HotSync operation. Thereafter, the HotSync Action reverts to the default setting.

To change your Mail setup options:

1. Click the HotSync icon  in the Windows system tray.
2. Choose Custom.

Tip: You can also choose Custom from the HotSync menu in Palm Desktop software.

3. Select Mail in the list box.
4. Click Change.
5. Modify your settings as needed.
6. Click OK.

Synchronizing Mail with your E-Mail application

After you enable and configure Mail, you need to perform a HotSync operation to synchronize Mail with your desktop E-Mail application. For a complete explanation of HotSync technology, see Chapter 7.

Opening the Mail application on your handheld

To open Mail:

1. Tap the Applications icon .
2. Tap the Mail icon .

Viewing e-mail items

The Message list displays a list of your incoming e-mail items, who sent them, and the date they were received. E-mail items you've read have a check next to them. High-priority e-mail items appear in bold.



Previously read

To open an e-mail item:

- Tap an e-mail item to open it.

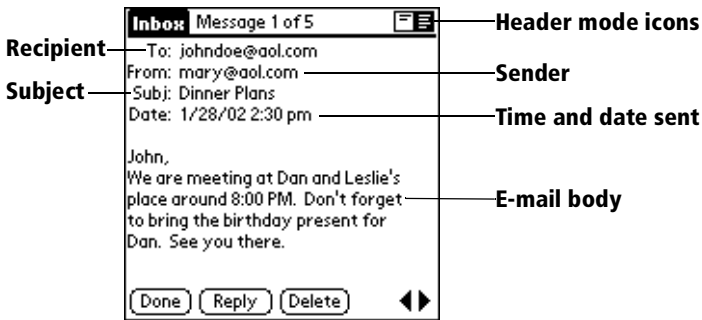

To close an e-mail item:

- Tap Done to close the e-mail item.

Displaying full header information

By default, Mail displays abbreviated header information, which comprises only the From: and Subj: fields. The full header provides complete information about the sender, receiver, and copied recipients, in addition to the subject and date the e-mail item was created. Mail uses the header type you select for all your e-mail items.

To display full header information:

1. Open an e-mail item.
2. Tap the complete header icon.

Tip: To redisplay the abbreviated header, tap the abbreviated header icon.

Creating e-mail items

You create e-mail items with your handheld the same way you create e-mail with your desktop E-mail application: you identify the recipient(s) of the e-mail item, define a subject, and create the body of the e-mail item.

You create original e-mail items and replies in the New Message screen. All e-mail items must, at the very least, contain information in the To: field.

To create an e-mail item:

1. Tap New.

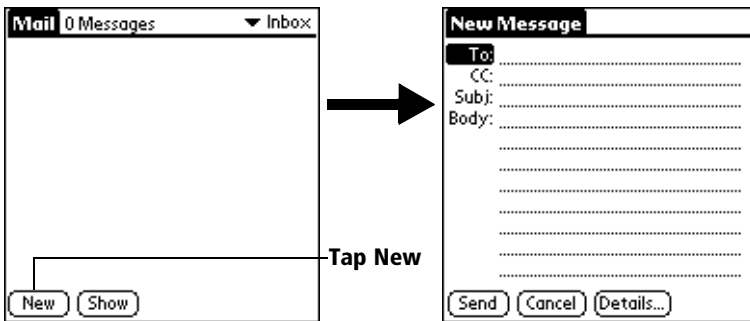

Tip: You can also create an e-mail item by tapping New from the Message menu.

2. Enter the e-mail address of the recipient.

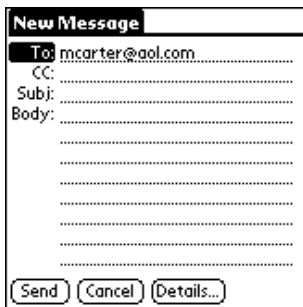

Tip: Enter the address as if you were entering it from your desktop E-Mail application. For example, network users sending an e-mail item to a user on the same network do not need to add Internet information, such as @mycorp.com. When you enter more than one address in the To: field, separate the addresses with commas or spaces, or enter each address on its own line.

3. To send a copy of this e-mail item to additional recipients, tap the CC: field, and then enter the e-mail addresses of the additional recipients, separating the addresses with a comma followed by a space.
4. Tap the Subj: field and enter a subject for your e-mail item.
5. Tap the Body: field and enter the text of your e-mail item.

Tip: If the address, CC, subject, or body exceeds the capacity of the screen display, tap the name of the field (for example, tap "To:") to expand that field. Tap the Done button to return to the New Message screen.

Tap the name of the field to open

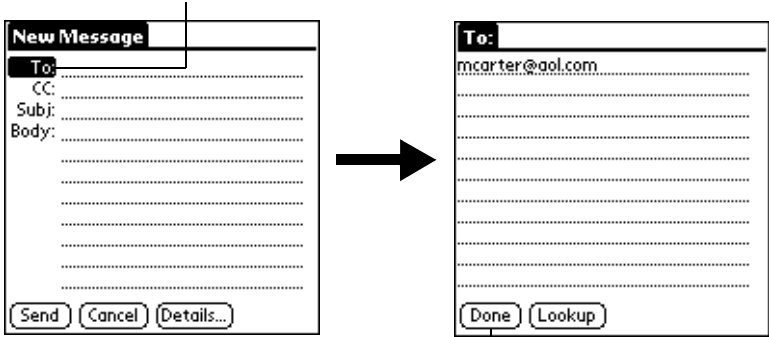

Tap to return to New Message screen

To reply to an e-mail item:

1. Tap an e-mail item in the Message list to display it onscreen.
2. Tap Reply.
3. Select whom you want to receive the reply: Sender only, All recipients, or someone who didn't see the original e-mail item (Forward).



4. Select whether you want to include original text or comment original text.
5. Tap OK.
6. Enter the text of your reply.

Tip: You have several options including setting the priority. See "Adding details to e-mail items" later in this chapter.

7. Tap Send to place your reply in the Outbox.

Looking up an address

To identify the recipient of an e-mail item, you need to enter that person's e-mail address. You can do this either by entering the data directly into the field or by using the Look Up command to access the information in your Address Book.

To look up an e-mail address:

1. Tap either the To: or CC: field name to expand it.
2. Enter the first few letters of the last name of the person whose address you want to find.
3. Tap Lookup.
4. If the letters you enter identify a unique listing from your Address Book, your handheld completes the address for you. If not, the Lookup dialog box appears and lists all records that contain information in an E-mail field.

Tip: You can also open the Look Up dialog box in the New Message screen by tapping Lookup from the Options menu or by using the Graffiti® Command stroke /L.

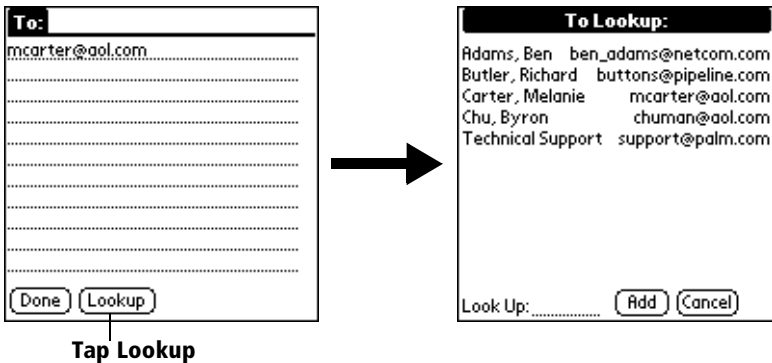

5. Enter the first letter of the entry you want to find to scroll to the first entry that begins with that letter. If you write an additional letter, the list scrolls to the first entry that starts with those two letters. For example, writing a "c" scrolls to "Carter," and writing "ch" scrolls to "Chu."
6. Tap an address to select it.
7. Tap Add.

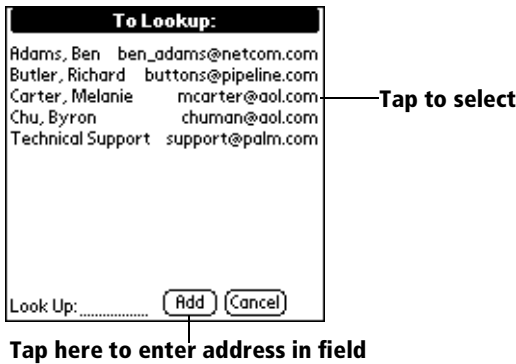

Adding details to e-mail items

Before you send your e-mail item, you can attach additional attributes to it, such as a signature or a priority level. These features are dependent on the desktop E-Mail application you use. If your application does not support the attribute you select, your handheld cannot attach that attribute to the e-mail item.

The following details are available:

- | | |
|-------------------------|--|
| Priority | Flags an e-mail item as High, Normal, or Low priority. |
| BCC | Creates a blind carbon copy field in the New Message screen. |
| Signature | Attaches previously defined text as the closing of an e-mail item. See "Adding a signature to your e-mail item" later in this chapter. |
| Confirm Read | Requests a confirmation telling you when the e-mail item was read. |
| Confirm Delivery | Requests a confirmation telling you when the e-mail item was delivered. |

Note: The Priority and BCC settings are valid only for the current e-mail item and must be set for each item you create.

Setting a priority

To set a priority for your e-mail item:

1. In the New Message screen, tap Details.

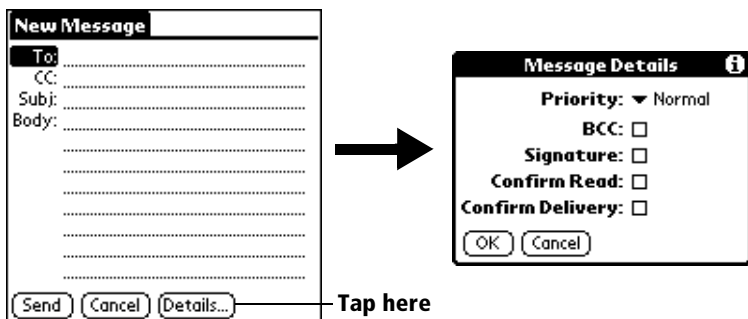

2. Tap the Priority pick list and select the priority you want.

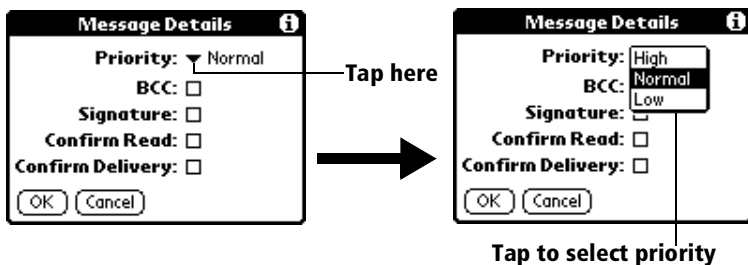

3. Tap OK.

Tip: Your handheld can flag e-mail items with a specific priority only if your desktop E-Mail application supports this feature.

Sending a blind carbon copy

To add a BCC field to your e-mail item:

1. In the New Message screen, tap Details.
2. Tap the BCC check box to select it.
3. Tap OK.
4. Tap the BCC: field and enter an address.

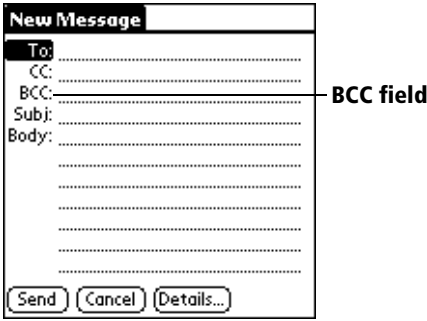

Adding a signature to your e-mail item

A signature consists of information about yourself that is appended to your e-mail item as its closing. For example, a signature can contain your name, address, phone and fax numbers, and any other text you want to include. By defining such information as a signature, you save yourself the trouble of having to enter it every time you create an e-mail item.

Adding a signature to your message is a two-part process. First, you create your signature. Then you select the Signature option.

To create a signature:

1. Tap the Menu icon .
2. Tap Options, and then tap Preferences.
3. Tap the Signature text field and enter the text of your signature.

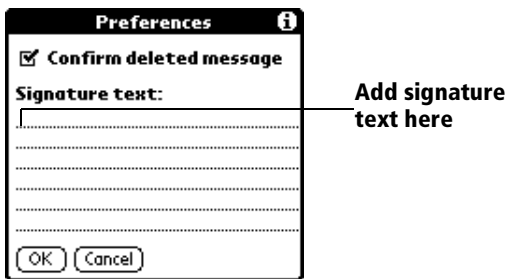

4. Tap OK.

To add a signature to your e-mail item:

1. In the New Message screen, tap Details.
2. Tap the Signature check box to select it and add your signature to the e-mail item.

Note: The check box stays selected, so all subsequent e-mail items you create will also contain your signature until you deselect the Signature option.

3. Tap OK.

Note: The signature does not display in your e-mail item; only your recipient sees the signature.

Requesting confirmations

To receive a confirmation when your e-mail item is read:

1. In the New Message screen, tap Details.
2. Tap the Confirm Read check box to select it.
3. Tap OK.

To receive a confirmation when your e-mail item is delivered:

1. In the New Message screen, tap Details.
2. Select the Confirm Delivery check box to select it.
3. Tap OK.

You won't receive a confirmation unless the e-mail application to which you send mail also supports this feature.

Storing e-mail to be sent later

When you send e-mail from your handheld, it actually stores the e-mail in the Outbox folder until the next time you synchronize your handheld with your computer. During synchronization, all e-mail stored in the Outbox folder is transferred to the Outbox folder in your desktop E-Mail application. E-mail created on your handheld is sent out the next time you send mail from your desktop E-Mail application.

To send e-mail:

- After you create an e-mail item, tap Send.

Editing unsent e-mail

You can make changes to an e-mail that has not yet been sent, as long as you have not yet performed a HotSync operation. When you edit an e-mail item, your handheld removes the item from the Outbox folder and takes you back to the New Message screen, where you can edit the item and resend it, save it as a draft, or delete it.

To edit an e-mail item:

1. In the Message list, tap Outbox from the pick list in the upper-right corner.

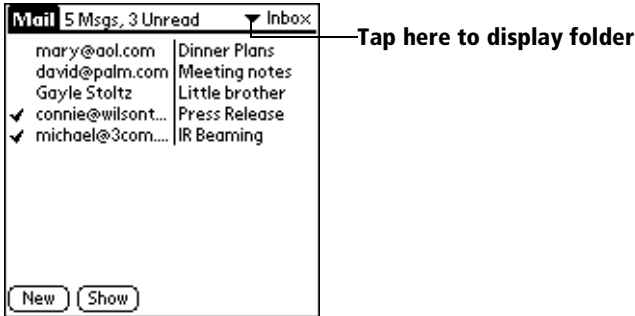

2. Tap the e-mail item you want to edit.

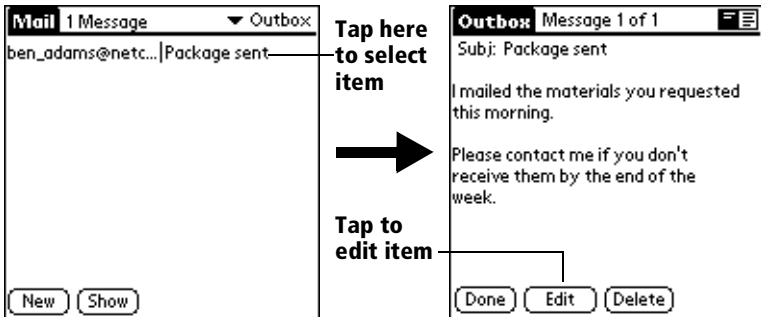

3. Tap Edit.

Draft e-mail

Sometimes you may not want to send an e-mail item immediately; for example, you may want to add additional information before sending it. Your handheld stores such e-mail items in the Draft folder until you are ready to edit them again.

Note: When you're creating or editing an e-mail item, you can also save the item as a draft by canceling it. When you cancel an item, your handheld opens a dialog asking if you want to save the e-mail item. If you tap Yes, your handheld saves the item in the Draft folder.

To save an e-mail item as a draft:

1. Create an e-mail item.
2. Tap the Menu icon .
3. Tap Message, and then tap Save Draft.

To edit an e-mail item saved as a draft:

1. In the Message list, tap Draft from the pick list in the upper-right corner.
2. Tap the draft you want to display.

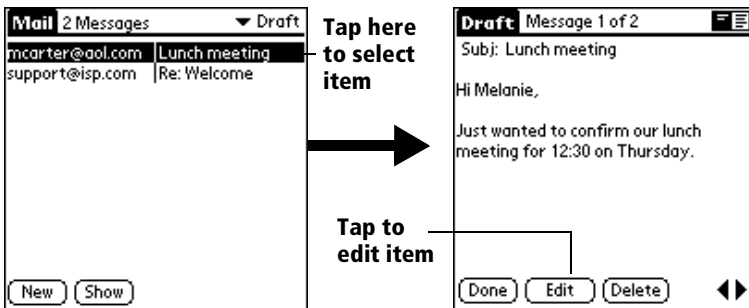

3. Tap Edit.
4. Enter your changes; then either save the e-mail item again as a draft, or tap Send to move the item to your Outbox folder.

Filing e-mail

Your handheld can store e-mail you receive or create in the Filed folder. The contents of this folder do not automatically synchronize with your desktop E-Mail application during a HotSync operation. Your handheld, however, stores a backup copy of the Filed folder on your computer hard disk.

To file e-mail:

1. Open an e-mail item.
2. Tap the Menu icon .
3. Tap Message, and then tap File.
4. Tap No to save the e-mail item and move it to the Filed folder, or tap Yes to file the item and keep a copy in the Inbox.

To remove e-mail from the Filed folder:

1. In the Message list, tap Filed from the pick list in the upper-right corner.
2. Tap the e-mail item you want to restore.
3. Tap Edit or Reply to modify the item.

Tip: After you display and modify the e-mail item, you can send it, save it as a draft, or return it to the Filed folder.

Deleting e-mail

Your handheld stores deleted e-mail in the Deleted folder until you perform the next HotSync operation. If you delete an e-mail item from the handheld, it is also deleted from your desktop E-Mail application when you perform the next HotSync operation.

To delete e-mail:

1. Open the e-mail item you want to delete.
2. Tap Delete.
3. If you selected the Preferences option to confirm deletion, tap Yes.

Removing e-mail from the Deleted folder

You can reverse the deletion of an e-mail item (by removing it from the Deleted folder) as long as you have not performed a HotSync operation or purged the contents of the Deleted folder.

To remove an e-mail item you received from the Deleted folder:

1. In the Message list, tap Deleted from the pick list in the upper-right corner.
2. Tap the e-mail item you want to restore.
3. Tap Undelete to move the selected item to the Inbox and mark it as read.

To remove an e-mail item you created from the Deleted folder:

1. In the Message list, tap Deleted from the pick list in the upper-right corner.
2. Tap the e-mail item you want to restore.
3. Tap Edit to display and modify the item.

Note: After you display and modify the e-mail item, you can send it or save it as a draft.

Purging deleted e-mail

Because your handheld stores deleted e-mail in the Deleted folder until you perform a HotSync operation, deleted e-mail can monopolize storage space. To avoid or correct this problem, purge the contents of your Deleted folder. E-mail that you purge is still deleted from your desktop E-Mail application when you perform the next HotSync operation.

To purge the contents of the Deleted folder:

1. Tap the Menu icon .
2. Tap Message, and then tap Purge Deleted.
3. Tap Yes.

Note: You cannot restore e-mail items after you purge them.

Message list options

Message list options enable you to manage the way the Message list displays information.

Folders

Your handheld provides folders for categorizing your mail. The Message list displays the e-mail items in the folder you select.

To select a folder:

1. Tap the pick list in the upper-right corner to open the list of folders:

Inbox: Contains the e-mail from your desktop E-Mail application Inbox, minus any that you have excluded using filtering options. See “Creating special filters” later in this chapter.

Outbox: Contains the e-mail you created and sent on the handheld since the last HotSync operation.

Deleted: Contains the e-mail you deleted since the last HotSync operation.

Filed: Contains the e-mail you want to store on the handheld.

Draft: Contains the e-mail you created using the handheld but are not yet ready to send.

2. Select the folder you want to display in the Message list screen.

Date column

The Date column is optional in the Message list. By default, the Date column is hidden to increase the available screen space.

To show the Date column:

1. In the Message list, tap Show.

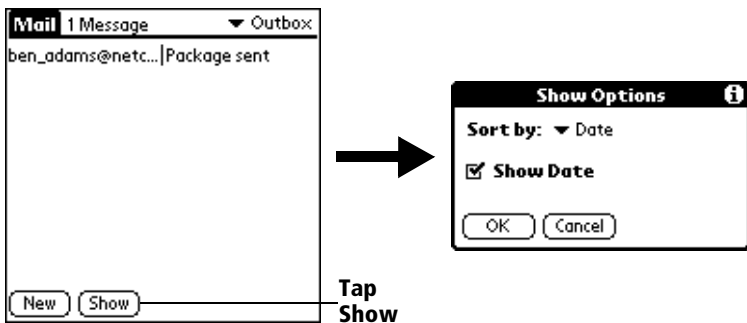

2. Tap the Show Date check box to select it.
3. Tap OK.

Sorting the Message list

You can sort e-mail items by the date sent, by sender, or by subject.

Note: High-priority e-mail items always appear first, no matter how you sort the list.

To sort the Message list:

1. In the Message list, tap Show.
2. Tap the Sort by pick list and select one of the following options:
 - Date:** Sorts e-mail by date and displays the most recent e-mail item at the top of the screen.
 - Sender:** Sorts e-mail by sender's user name and displays items in ascending alphabetical order, based on the first word of the From: field.
 - Subject:** Sorts e-mail by subject and displays items in ascending alphabetical order, based on the first word of the Subj: field.
3. Tap OK.

HotSync options

HotSync options enable you to manage your e-mail more effectively by selecting which e-mail items download when you synchronize your computer and your handheld. You can define different settings for local and remote synchronization. For example, you may want to download all of your e-mail during local synchronization and only urgent e-mail during remote synchronization. Once defined, your handheld determines if synchronization is occurring locally or remotely and uses the appropriate settings for the HotSync operation.

To open the HotSync Options dialog box:

1. Tap the Menu icon .
2. Tap Options, and then tap HotSync Options.
3. Tap the Settings for pick list and select Local HotSync or Remote HotSync.

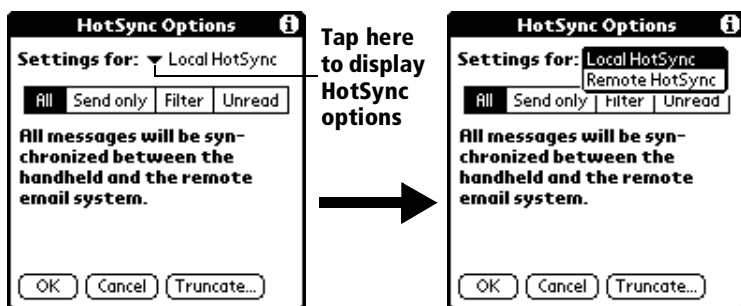

Note: For more information about Local and Remote HotSync operations, see Chapter 7.

4. Tap the filtering option you want to apply:

All: During synchronization, all e-mail items in your desktop E-Mail Inbox synchronize with your handheld, and all e-mail items in your handheld Outbox are sent to your desktop E-Mail application.

Send only: During synchronization, only the e-mail items in your handheld Outbox are sent to your desktop E-Mail application; from there, they are sent to their destinations.

Filter: During synchronization, all e-mail items in your handheld Outbox are sent to your desktop E-Mail application, and items in your desktop E-Mail Inbox that meet specific criteria download to your handheld. When you select the Filter setting, the HotSync Options dialog box opens and displays additional filter settings. See “Creating special filters” later in this chapter.

Unread: During synchronization, only unread e-mail items download to your handheld from your desktop E-Mail Inbox, and all items in your handheld Outbox are sent to your desktop E-Mail application.

Note: The All setting does not mean that all information included in each e-mail item downloads to your handheld. Truncation settings (explained in a following section) for long e-mail items still apply. Also, Mail never downloads any attachments to your handheld. The e-mail item and any text information appear, but the attachment is left in your desktop E-Mail application.

5. If you selected All, Send only, or Unread, tap OK. If you selected Filter, continue to the next section.

Creating special filters

You can create special filters to control the type of e-mail items that download to your handheld during synchronization. Special filters work on the premise of ignoring or retrieving items that contain specific information in their header fields.

To create a special filter, you must decide whether you want to ignore or retrieve certain e-mail items. Then, based on that decision, you must tell your handheld what it needs to look for in the To:, From:, and Subj: fields to single out those e-mail items.

To access the special filter settings:

- Tap the Filter box in the HotSync Options dialog box.

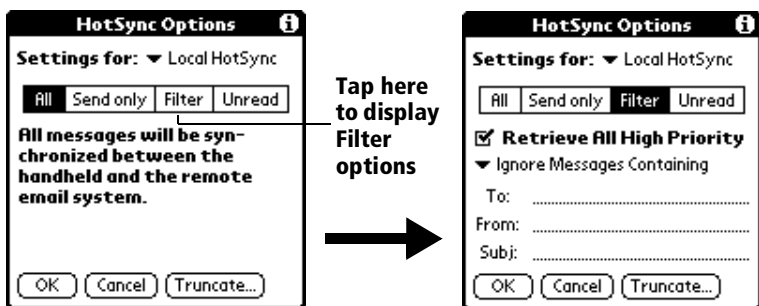

Ignoring or receiving e-mail

The first step in establishing a special filter is to determine if you want to ignore or retrieve e-mail that matches the information you specify.

To define whether to ignore or receive e-mail:

- Tap the pick list in the center of the HotSync Options dialog box and select one of the following settings:

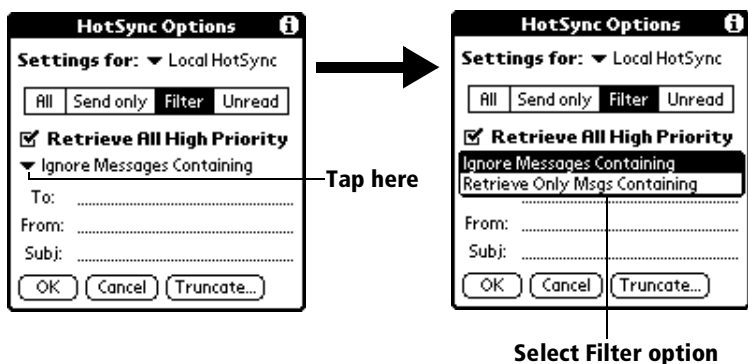

Ignore Messages Containing: Tells your handheld to *exclude* the e-mail items that meet the criteria you define and download *all other e-mail items* during synchronization. In general, this filter downloads more e-mail during synchronization because it blocks only one defined subset of e-mail.

Retrieve Only Msgs Containing: Tells your handheld to *include* only the e-mail items that meet the criteria you define and to ignore all other e-mail items during synchronization. This filter has the potential to block more e-mail during synchronization because it downloads only one subset of e-mail.

Defining filter strings

E-mail items are filtered based on the information contained in their To:, From:, and Subj: fields. The information that defines what your handheld is looking for is called a *filter string*. You create a filter string by listing the words you want your handheld to find and separating them with either a comma or a space. Each word in the filter string is joined by an implicit OR, so you do not need to enter logical connectors like AND or OR.

To create a more complex filter, you can define filter strings for the To:, From:, and Subj: fields simultaneously. Your handheld joins the filter strings for these fields using an implicit AND; once again, you do not need to add the logical connector. Your handheld does that for you.

For example, suppose you want to receive only e-mail items from John Smith (jsmith@aol.com) or Jack Jones (jjones@aol.com) concerning the Apollo Project. You would create the following filter strings:

In the To: field: jsmith@aol.com, jjones@aol.com

In the Subj: field: Apollo Project

Your handheld interprets this as, “Accept e-mail items about the Apollo Project from John Smith or Jack Jones. Do not accept e-mail items from other people. Do not accept e-mail items from John or Jack about any other subject.”

When you define a string, note that your handheld searches for any instance of that character *sequence*. For example, if you create a filter that retrieves only e-mail items containing the string “info,” your handheld finds “info,” “rainforest” and “kinfolk” as matches.

To define a filter string:

1. Tap a header field in the HotSync Options dialog box.

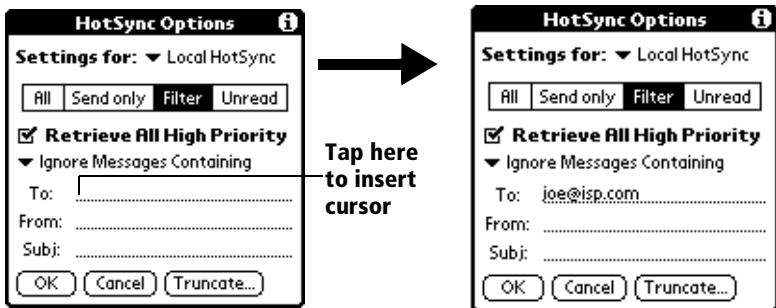

2. Enter your filter string with commas or spaces between the words. Do not add connectors, such as AND or OR, in a string.
3. If your string exceeds the length of the field, tap the name of the field to display the Notes screen for that header field. For more information about header field Notes screens, see “Creating e-mail items” earlier in this chapter.

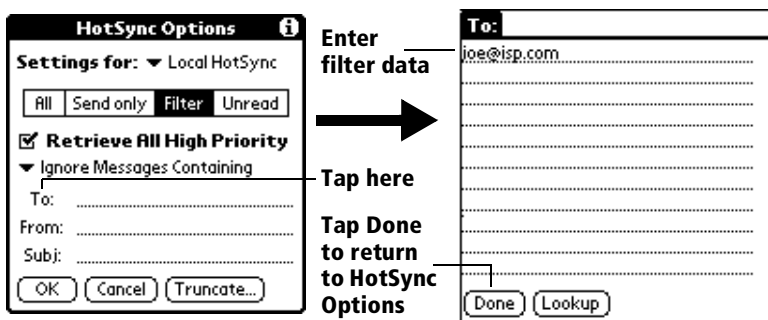

4. Tap Done to return to the HotSync Options dialog box.
5. Tap OK.

High-priority e-mail

The Retrieve All High Priority setting lets you retrieve e-mail items marked high-priority, even if those items would have been blocked by a defined filter.

To retrieve high-priority e-mail items:

1. Tap the Filter box in the HotSync Options dialog box.
2. Tap the Retrieve All High Priority check box to select it.

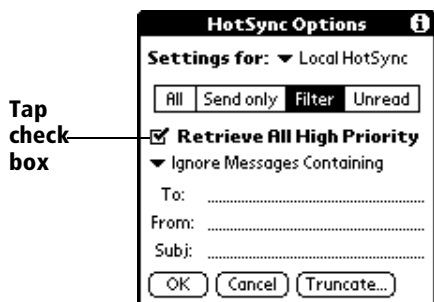

3. Tap OK.

Note: This setting is applicable only if your E-Mail application has the capacity to flag high-priority e-mail items.

Truncating e-mail items

The Truncate feature lets you set a point at which long e-mail items truncate when downloading to your handheld. By default, this Truncate value is 4,000 characters. By truncating long messages, you reduce the time it takes to synchronize your desktop E-Mail and Mail, as well as the amount of storage space e-mail uses on your handheld.

Note: Truncation is separate and independent from filtering.

To truncate e-mail items:

1. Tap Truncate in the HotSync Options dialog box.

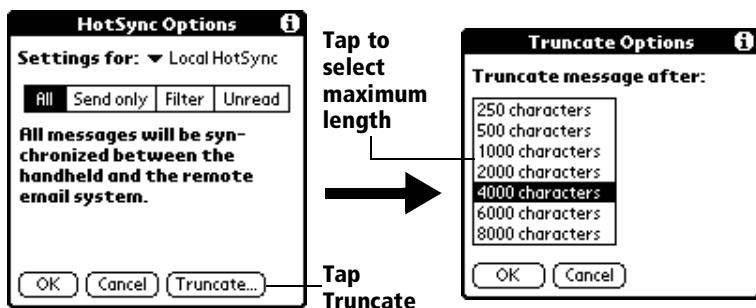

2. Tap to select the truncation setting you want.

Tip: If you select the maximum setting, messages can be 8,000 characters; longer messages are truncated. If you select a lower value, you'll have more room for e-mail items.

3. Tap OK.

Mail menus

Mail menus are shown here for your reference, and Mail features that are not explained elsewhere in this book are described here.

See "Using menus" in Chapter 1 for information about choosing menu commands.

Message menus

The Message menu varies depending on whether you are viewing an e-mail item, creating an e-mail item, or viewing the Message list.

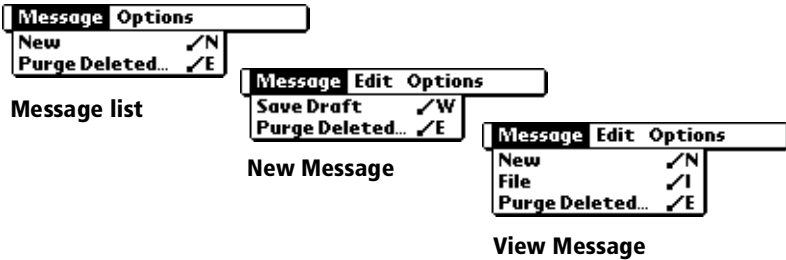

Options menus

The Options menu varies depending on whether you are creating or editing an e-mail item.

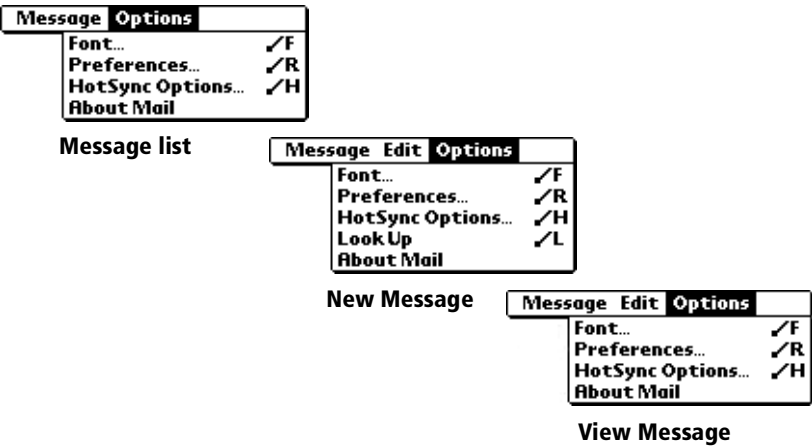

About Mail

Shows version information for Mail.

Beaming information

Your handheld is equipped with an IR (infrared) port that you can use to beam information to another Palm OS handheld that's close by and also has an IR port. The IR port is located at the top of the handheld, behind the small dark shield.

You can beam the following information between Palm OS handhelds:

- The record currently displayed in Date Book, Address Book, To Do List, or Memo Pad
- All records in the category currently displayed in Address Book, To Do List, or Memo Pad
- A special Address Book record that you designate as your business card, containing information you want to exchange with business contacts
- An application installed in RAM memory

Note: You can also perform HotSync operations using the IR port. See "IR HotSync operations" in Chapter 7 for more details.

To select a business card:

1. Create an Address Book record that contains the information you want on your business card.
2. Tap the Menu icon .
3. Tap Record, and then tap Select Business Card.
4. Tap Yes.

To beam a record, business card, or category of records:

1. Locate the record, business card, or category you want to beam.
2. Tap the Menu icon .
3. Tap Record, and then tap one of the following:
 - The Beam command for an individual record
 - In Address Book only: Beam Business Card
 - Beam Category
4. When the Beam Status dialog box appears, point the IR port directly at the IR port of the receiving handheld.

Tip: For best results, Palm VII handhelds should be between 10 centimeters (approximately 4 inches) and 1 meter (approximately 39 inches) apart, and the path between the two devices must be clear of obstacles. Beaming distance to other Palm OS handhelds may be different.



5. Wait for the Beam Status dialog box to indicate that the transfer is complete before you continue working on your handheld.

To beam an application:

1. Open the Applications Launcher.
2. Tap the Menu icon .
3. Tap App, and then tap Beam.
4. Tap the application you want to transfer.

Note: Some applications are copy-protected and cannot be beamed. These are listed with a lock icon next to them.

5. Tap Beam.
6. When the Beam Status dialog box appears, point the IR port directly at the IR port of the receiving handheld.
7. Wait for the Beam Status dialog box to indicate that the transfer is complete before you continue working on your handheld.

To receive beamed information:

1. Turn on your handheld.
2. Point the IR port directly at the IR port of the transmitting device to open the Beam dialog box.
3. If you're receiving Address Book, To Do List, or Memo Pad information, select a category for the incoming information, create a new category, or leave the information unfiled.



4. Tap Yes.

Tips on beaming information

- You can press the Address Book application button  for about two seconds to beam your business card.
- You can set the full-screen pen stroke to beam the current entry. See "Pen preferences" in Chapter 8 for more information.
- You can draw the Graffiti Command stroke to activate the Command toolbar, and then tap the Beam icon.
- You can use the Graffiti Command stroke /B to beam the current entry.

Chapter 7

Advanced HotSync® Operations

HotSync® technology enables you to synchronize data between one or more Palm OS® handhelds and Palm™ Desktop organizer software or another PIM such as Microsoft Outlook. To synchronize data, you must connect your Palm VII™ handheld and Palm Desktop software. You can synchronize your data either directly or indirectly. Direct methods include placing your handheld in the cradle attached to your computer, or using infrared communications. Indirect methods include using a modem, or using network HotSync technology.

This chapter describes how to select HotSync options and perform a HotSync operation via infrared communications, a modem, or a network. See “Exchanging and updating data: HotSync operations” in Chapter 4 for information about performing your first and subsequent local HotSync operations.

Selecting HotSync setup options

You can choose when you want HotSync Manager to run. If necessary, you can adjust the local and modem HotSync settings as well.

To set the HotSync options:

1. Click the HotSync icon ™ in the Windows system tray.
2. Choose Setup.

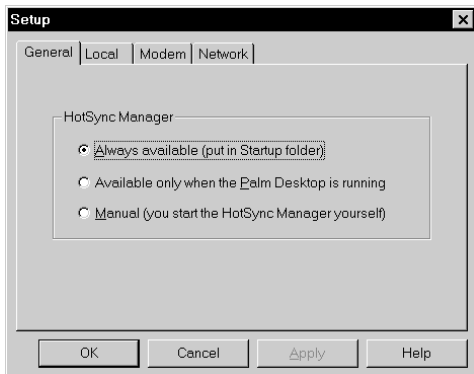

3. Click the General tab and select one of the following options:

Always available: Adds HotSync Manager to the Startup folder and constantly monitors the communication port for synchronization requests from your handheld. With this option, the HotSync Manager synchronizes data even when Palm Desktop software is not running.

Available only when Palm Desktop software is running: Starts HotSync Manager and monitors requests automatically when you open Palm Desktop software.

Manual: Monitors requests only when you select HotSync Manager from the Start menu.

Tip: If you're not sure which option to use, keep the default setting: Always available.

4. Click the Local tab to display the settings for the connection between your computer and the handheld cradle, and adjust the following options as needed.

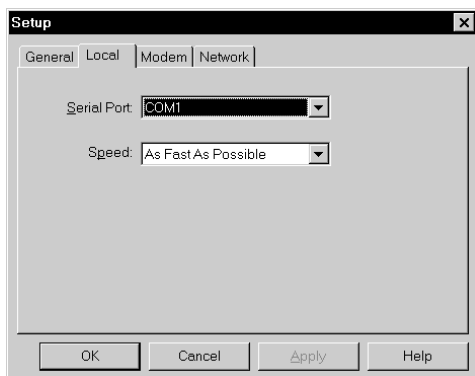

Serial Port: Identifies the port that HotSync Manager uses to communicate with the cradle. The Palm Desktop installation software automatically detects the port to which you connected the cradle. If necessary, you can change the port selection.

Note: Your handheld cannot share this port with an internal modem or other device. See "Palm VII components" in Chapter 1 if you have trouble identifying the serial port.

Speed: Determines the speed at which data is transferred between your handheld and Palm Desktop software. Try the As Fast As Possible rate first, and adjust downward if you experience problems. This setting allows Palm Desktop software and your handheld to find and use the fastest speed.

5. Click the Modem tab to display the modem settings and adjust the options as needed. See “Conducting a HotSync operation via modem” later in this chapter for more information.
6. If you are attached to a network, click the Network tab to display the network settings and adjust the options as needed. See “Conducting a HotSync operation via a network” later in this chapter for more information.
7. Click OK.

Customizing HotSync application settings

For each application, you can define a set of options that determines how records are handled during synchronization. These options are called a “conduit.” By default, a HotSync operation synchronizes all files between the handheld and Palm Desktop software.

In general, you should leave the settings to synchronize all files. The only reason you might want to change these settings is to overwrite data on either your handheld or Palm Desktop software, or to avoid synchronizing a particular type of file because you don’t use it.

In addition to the conduits for Date Book, Address Book, To Do List, Memo Pad, and Expense, Palm Desktop software includes System and Install conduits. The System conduit backs up the system information stored on your handheld, including Graffiti® ShortCuts. The Install conduit installs add-on applications on your handheld.

To customize HotSync application settings:

1. Click the HotSync icon  in the Windows system tray (bottom-right corner of the taskbar).
Tip: You can also click the HotSync command on the Palm Desktop software menu bar.
2. From the HotSync Manager menu, choose Custom.

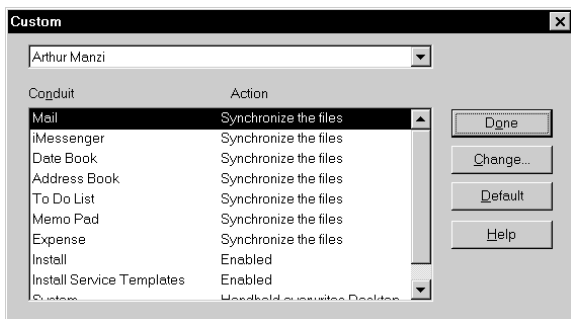

3. Select the appropriate user name from the list.
4. Select an application in the Conduit list.
5. Click Change.

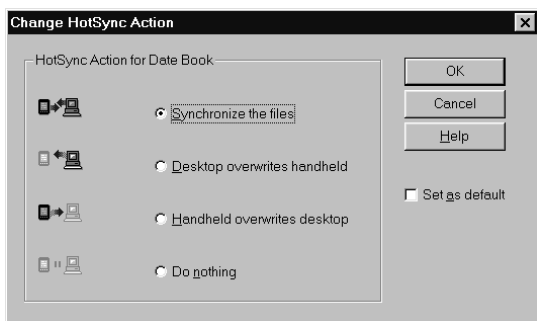

6. Select the direction in which you want to write data, or click Do Nothing to skip data transfer for an application.

Note: Changing the HotSync setting from the default affects only the *next* HotSync operation. Thereafter, the HotSync Actions revert to their default settings. To use a new setting on an ongoing basis, select the Set As Default box. Thereafter, whatever you selected as the default setting is used when you click the Default button in the Custom dialog.

7. Click OK.
8. Repeat steps 4 through 7 to change conduit settings for other applications.
9. Click Done to activate your settings.

IR HotSync operations

Your handheld is equipped with an infrared (IR) port that supports the IrCOMM implementation of the standards for infrared communication established by the Infrared Data Association (IrDA). This means that not only can you beam data to another Palm OS handheld that's equipped with an IR port, but you can also beam data to a cell phone and any other device that supports the IrCOMM implementation of the IrDA standards.

Most importantly, you can use the IR port to perform HotSync operations; you don't need your cradle. This is especially useful if you travel with an infrared-enabled laptop. You simply enable infrared communication on your laptop and handheld and follow the steps in "Performing an IR HotSync operation" later in this section.

Preparing your computer for infrared communication

Before you can perform a HotSync operation using the IR port, the computer with which you want to synchronize must fulfill these requirements:

- Your computer must support the IrCOMM implementation of the IrDA standards.
- Your computer must have an enabled infrared port that's built into the computer, or an enabled infrared device attached to the computer.

Desktop computers are likely to require an infrared device attached to a physical COM port. Laptops are likely to have a built-in IR port, so no external device is necessary. Your computer must also have an installed infrared driver.

Check your computer's documentation to learn if the computer supports infrared communication. If your computer is a Macintosh G3, or uses Microsoft Windows 98 or Windows 2000, infrared communication is built into the operating system. Some versions of the Macintosh iMac also have built-in infrared communication.

The following procedure explains how to find out if your Windows 95 computer has an infrared driver installed.

To check if your Windows 95 computer supports infrared communication:

1. In the Windows taskbar, click Start.
2. Choose Settings, and then choose Control Panel.

3. In the Control Panel, look for the Infrared icon.

If the icon is there, your computer is enabled for infrared communication. If it isn't there, you need to install an infrared driver.

Note: If you have an external infrared device attached to your computer, a driver is probably included with the device. Consult the documentation included with the device for information on installing the required driver.

To install a Windows 95 infrared driver:

1. Click the HotSync Manager icon  in the Windows system tray and choose Setup. Click the tabs and note the COM ports being used by the HotSync Manager. You need this information later.

2. Go to this web site:

<http://www.microsoft.com/windows/downloads>

3. Follow the links to the Windows 95 IrDA 2.0 (Infrared Driver), and follow the instructions to download the driver.

4. Close your Internet browser if it's in the way.

5. Find the file W95ir.exe on your computer.

Before you go to the next step, be sure this file is in a folder where you want to store the infrared driver.

6. Double-click W95ir.exe.

A window lists the files that are unzipping onto your hard disk. When the title bar displays Finished, close this window.

7. Double-click Setup.exe to begin installation. This file is in the folder where you unzipped W95ir.exe.

The Add Infrared Device Wizard appears.

8. Click Next.

9. Accept the defaults provided until the Wizard asks you to select an infrared port. Be sure to select an available communications port. Do not select the port that the HotSync Manager currently uses.

10. Continue the rest of the installation using the defaults provided.

If an alert appears telling you that there is a communication port conflict, click OK and proceed.

After you install the infrared driver, check the ports used by your computer for infrared communication.

To check the ports used for infrared communication:

1. In the Windows taskbar, click Start, choose Settings, and then choose Control Panel.
2. Double-click Infrared.
3. Click the Options tab.
4. Select Enable infrared communication.

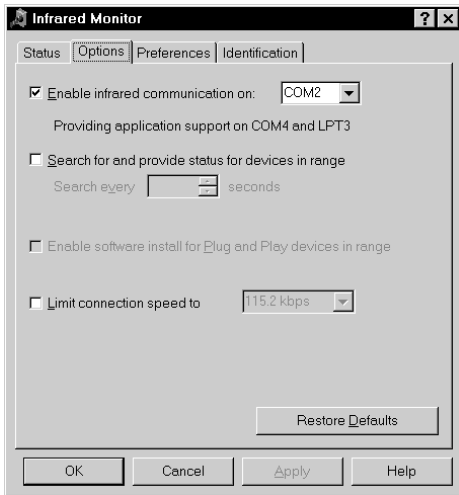

The COM port displayed in the drop-down box is the port where your infrared device is attached. It should be *different* from any port used by the HotSync Manager.

5. Make a note of which port is listed as “providing application support.” You need this information to configure the HotSync Manager for infrared communication.

This port (COM4 in this example) is the simulated port, the channel through which the actual infrared communication takes place between your computer and your handheld.

6. Deselect any other check boxes in the Options tab.
7. Click Apply and OK.

Configuring HotSync Manager for infrared communication

Next, you need to go to the HotSync Manager and specify the simulated port used for infrared communication.

To configure HotSync Manager for infrared communication:

1. Click the HotSync Manager icon  in the Windows system tray.
2. Make sure Local is checked on the menu.
3. Choose Setup.
4. Click the Local tab.
5. In the Serial Port drop-down box, select the COM port that was given as the simulated port in the Options tab of the Infrared Monitor (in this example, COM4).

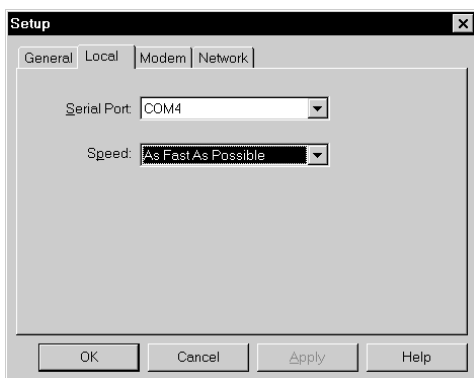

6. Click OK.

The HotSync Manager is now communicating with the simulated port defined for infrared communication. This means that you cannot use your cradle again until you reconfigure the HotSync Manager to communicate with the port defined for cradle synchronization.

Performing an IR HotSync operation

After you complete the steps to prepare for performing an IR HotSync operation, it is easy to perform the actual operation.

To perform an IR HotSync operation:

1. In the Applications Launcher, tap the HotSync icon.
2. Tap Local.
3. Tap the pick list below the HotSync icon and select IR to a PC/Handheld.
4. Position the IR port of your handheld within a couple of inches of the infrared port of your computer.
5. Tap the HotSync icon to start the IR HotSync operation.

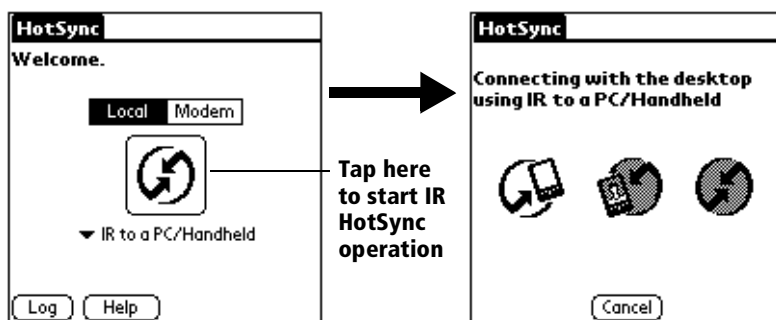

Returning to cradle HotSync operations

It's easy to return to using the cradle for HotSync operations.

To return to cradle HotSync operations:

1. If needed, connect the cradle to a serial (COM) port of your computer.
2. Click the HotSync Manager icon  in the Windows system tray.
3. Choose Setup, and then click Local.
4. Select the COM port where your cradle is connected.
5. Click OK.

Now, the next time you want to perform a HotSync operation, just press the HotSync button on the cradle, as you always did in the past.

You can leave the HotSync application on your handheld set to perform IR HotSync operations and still use the cradle. This is useful if you perform HotSync operations with both your desktop computer and a laptop that you travel with. When you travel, you don't have to carry a cradle or cable because your handheld is set to perform IR HotSync operations. When you're in the office, just place your handheld in the cradle and press the HotSync button.

Conducting a HotSync operation via modem

You can use a modem to synchronize your handheld when you are away from your computer.

Note: The first HotSync operation must be local, using the cradle. After that, you can perform a modem HotSync operation.

To perform a HotSync operation via modem, you need the following:

- A modem connected to your computer
- Palm Desktop software configured for use with the modem
- A modem, for example, a PalmModem accessory, connected to your handheld
- A configuration for the kind of modem connection (Serial to Modem or IrCOMM to Modem) you want to make. See "Connection preferences" in Chapter 8 for more information.

Preparing your computer

You must perform a few steps to prepare your computer for a modem HotSync operation. Perform these steps before you leave your office so that your computer is ready to receive a call from your handheld.

To prepare your computer for a modem HotSync operation:

1. Confirm that the computer modem is connected and turned on, and that no communications applications, such as fax or telephony software, are running on a COM port.

Note: To avoid conflicts with the COM port, make sure the computer is disconnected from all online services, such as America Online (AOL) and CompuServe.

2. Start HotSync Manager if it is not already running, and from the HotSync Manager menu, choose Modem.

3. Adjust the following options as needed.

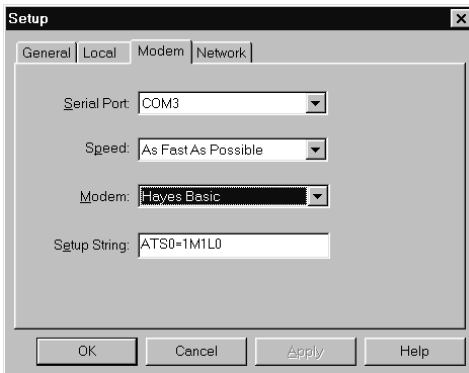

Serial Port: Identifies the port for the modem. If you are unsure of the port assignment, look at the Modem Properties in the Windows Control Panel.

Speed: Determines the speed at which data is transferred. Try the As Fast As Possible rate first, and adjust downward if you experience problems. This setting allows Palm Desktop software and your handheld to find and use the fastest speed.

Modem: Identifies the modem type or manufacturer. Refer to your modem manual or face plate for its type or settings. If you're not sure of your modem type or your modem doesn't match any that appear in the list, select Hayes Basic.



Setup String: Identifies the setup string for your particular modem. Not all modems require a setup string. Refer to your modem manual and enter the setup string if recommended by the manufacturer.

4. Click OK.

Preparing your handheld

There are a few steps you must perform to prepare your handheld for a modem HotSync operation.

To prepare your handheld for a modem HotSync operation:

1. Tap the Applications icon .
2. Tap the HotSync icon .
3. Tap Modem.

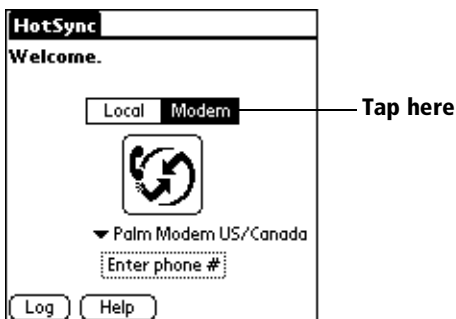

4. Tap the pick list below the icon and select a modem configuration.

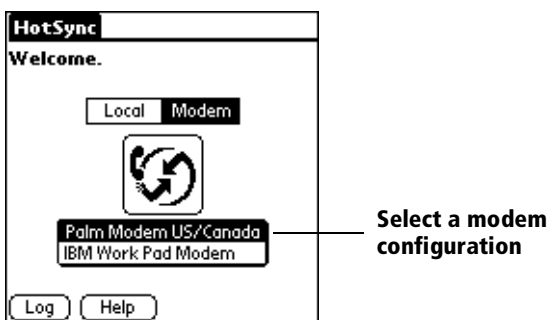

Note: If you need to create a configuration, tap the Menu icon and then select Options and Connection Setup. See “Connection preferences” in Chapter 8 for more information.

5. Tap the Enter phone # field.

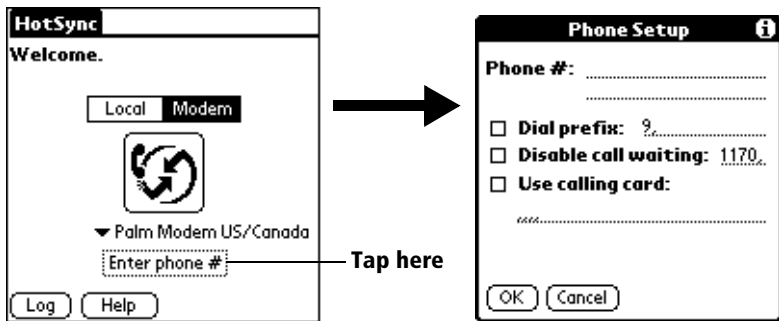

Note: If you plan to connect to your company’s dial-in server (network modem) instead of connecting to a computer modem, see “Conducting a HotSync operation via a network” later in this chapter.

6. Enter the telephone number to access the modem connected to your computer.
7. If needed, enter a dial prefix (such as “9”) to access an outside line, and then tap the Dial Prefix check box.



Tip: You can enter a comma in the field to introduce a “pause” in the dialing sequence. Each comma equals a two second pause.

8. If the phone line you’re using for the handheld has Call Waiting, select the Disable call waiting check box to avoid an interruption during the modem HotSync operation.
9. If you want to use a calling card to place the call, select the check box and enter the calling card number.
10. Tap OK.

Selecting the conduits for a modem HotSync operation

The Conduit Setup dialog box on your handheld enables you to define which files and/or applications synchronize during a modem HotSync operation. You can use these settings to minimize the time required to synchronize data with a modem.

To change the Conduit Setup for a modem HotSync operation:

1. Tap the Applications icon .
2. Tap the HotSync icon .
3. Tap the Menu icon .

4. Tap Options, and then tap Conduit Setup.
5. Tap the check boxes to deselect the files and applications that you do *not* want to synchronize during a modem HotSync operation. The default setting is to synchronize all files.





Note: Applications that do not have a database (such as games) do not synchronize — even if you select the item in the Conduit Setup dialog box.

6. Tap OK.

Performing a HotSync operation via a modem

After you prepare your computer and handheld, and select your Conduit Setup options, you are ready to perform a modem HotSync operation.

To perform a modem HotSync operation:

1. Tap the Applications icon .
2. Tap the HotSync icon .
3. Tap the Modem icon  to dial the Palm Desktop modem and synchronize the applications.
4. Wait for the HotSync operation to complete.

See “HotSync problems” in Appendix B if you have any problems conducting a successful HotSync operation.

Conducting a HotSync operation via a network

When you use the network HotSync technology, you can take advantage of the LAN and WAN connectivity available in many office environments. The network HotSync technology enables you to perform a HotSync operation by dialing in to a network or by using a cradle that is connected to any computer on your LAN or WAN (provided that the computer connected to the cradle also has the network HotSync technology installed, your computer is on, and the HotSync Manager is running).

Connecting to your company's dial-in server

A network HotSync operation requires the following (consult your System Administrator for assistance):

- Your computer has TCP/IP support installed.
- Both your company's network system and its remote access server support TCP/IP. (Your System Administrator has this information.)
- You have a remote access account. (If you don't have an account, consult your System Administrator.)

Everything you need to connect to your company's dial-in server (network modem) is included with Palm Desktop software and your handheld. You need to activate the feature, however, on both Palm Desktop software and your handheld.

To prepare your computer for a network HotSync operation:

1. Click the HotSync Manager icon  in the Windows system tray.
2. From the HotSync Manager menu, choose Network.

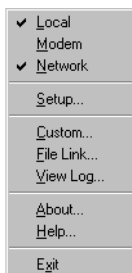

3. From the HotSync Manager menu, choose Setup.

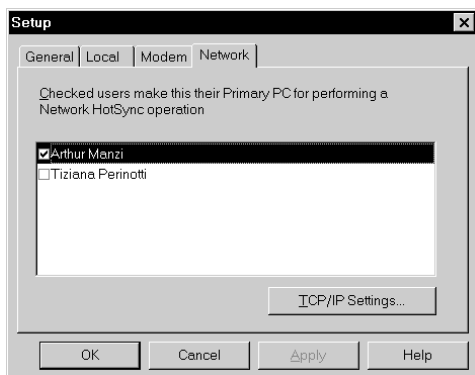

- Click the Network tab and make sure your user name has a check mark next to it. If the check mark is not there, click the check box next to your user name.



- Click OK.
- Place your handheld in the cradle and perform a HotSync operation.

The HotSync operation records network information about your computer on your handheld. With this information, your handheld can locate your computer when you perform a HotSync operation over the network.

To prepare your handheld for a network HotSync operation:

- Tap the Applications icon .
- Tap the HotSync icon .
- Tap the Menu icon .
- Tap Options, then tap Modem Sync Prefs.
- Tap Network.

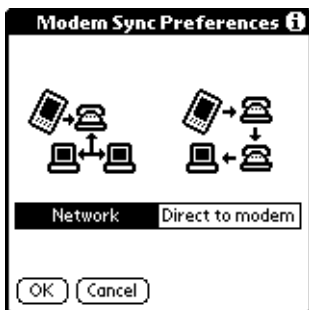

6. Tap OK.
7. Tap Select Service.

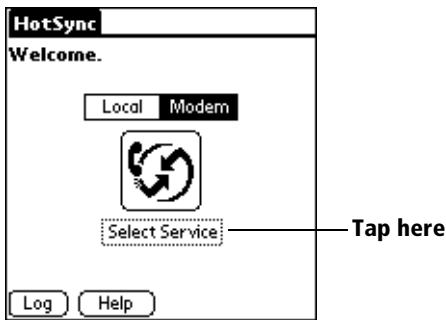

Note: See “Network preferences and TCP/IP software” in Chapter 8 for information on creating a network connection.

8. Tap Service and select a service.

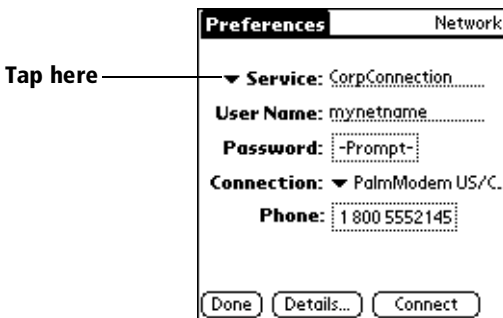

9. Tap Done.
10. Tap the Menu icon .
11. Tap Options, then tap Conduit Setup.

Follow the instructions in “Selecting the conduits for a modem HotSync operation” earlier in this chapter.

Performing a network HotSync operation

After you prepare your computer and your handheld, and select your Conduit Setup options, you are ready to perform a network HotSync operation.

To perform a network HotSync operation:

- Tap the modem HotSync icon to begin the operation.

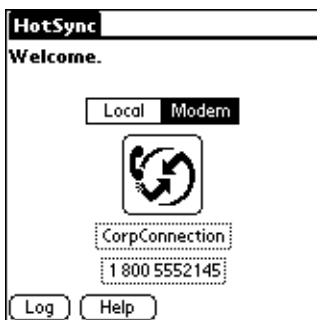

Using File Link

The File Link feature enables you to import Address Book and Memo Pad information onto your handheld from a separate external file such as a company phone list. HotSync Manager stores the data in a separate category on your Palm Desktop software and your handheld. You can configure the File Link feature to check for changes to the external file when you perform a HotSync operation.

With File Link, you can import data stored in any of the following formats:

- Comma delimited (.csv)
- Tab delimited (.tsv)
- Memo Pad archive (.mpa)
- Address Book archive (.aba)
- Text (.txt)

For information on how to set up a file link, see the Palm Desktop online Help.

Creating a user profile

If you use the File Link feature to configure several Palm OS handhelds with specific information (such as a company phone list) before distributing them to their actual users, you can create a user profile to load the data into an handheld without associating that data with a user name. The User Profile feature is designed only for the first-time HotSync operation, before you assign a User ID to a particular handheld.

To create a user profile:

1. Open Palm Desktop software.
2. From the Tools menu, choose Users.
3. Click Profiles.
4. Click New.

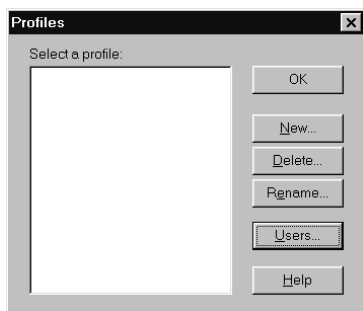

5. Enter a unique name for the profile, and click OK.



6. Repeat steps 3 and 4 for each profile that you want to create, and then click OK to return to Palm Desktop software.
7. Select the profile from the User list and create the data for the profile (e.g., company phone list, etc.).

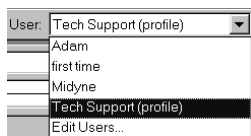

To use a profile for the first-time HotSync operation:

1. Place the new handheld in the cradle.
2. Press the HotSync button  on the cradle.
3. Click Profiles.
4. Select the profile you want to load on the handheld, and click OK.

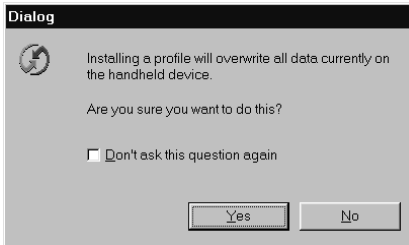

5. Click Yes to transfer all the profile data to the handheld.

The next time you perform a HotSync operation, Palm Desktop software prompts you to assign a user name to the handheld.

Chapter 8

Setting Preferences for Your Handheld



The Preferences screens enable you to customize the configuration options on your handheld.

In the Preferences screens, you can do the following:

- | | |
|-------------------|--|
| Buttons | Assign different applications to the buttons on the front panel of your handheld and the HotSync® button on the cradle; identify an application to open whenever you raise the antenna; reassign the full-screen pen stroke command. |
| Digitizer | Calibrate the screen on your handheld. |
| Formats | Set the country default and the formats for dates, times, calendar, and numbers. |
| General | Set the date and time, the auto shut-off interval, the Beam Receive feature, and the system, alarm, and game sounds. |
| Connection | Configure serial, modem, and infrared communication settings. |
| Network | Configure your handheld for use with a network. |
| Owner | Assign your name, phone number, and other owner information to your handheld. |
| ShortCuts | Define a list of Graffiti® abbreviations. |
| Wireless | View your Palm.Net™ address; change the proxy server IP address; and receive a warning when a wireless transaction is about to transmit your identification or location. |

Viewing preferences

To open the Preferences screens:

1. Tap the Applications icon .
2. Tap the Preferences icon .
3. Tap the pick list in the upper-right corner of the screen.
4. Select the Preferences screen you want to view.

Buttons preferences

The Buttons Preferences screen enables you to assign different applications to the buttons on the front panel of your handheld and the HotSync button on the cradle.

For example, if you find that you seldom use To Do List and often use Expense, you can assign the To Do List button to start Expense.

If you assign a different application to a button, you can still access the original application using the Applications Launcher.

The Buttons Preferences screen also enables you to reassign the full-screen pen stroke command and identify an application to open whenever you raise the antenna.

Any changes you make in the Buttons Preferences screen become effective immediately; you do not have to change to a different screen or application.

To reassign the applications buttons:

1. Tap the pick list next to the button you want to reassign.

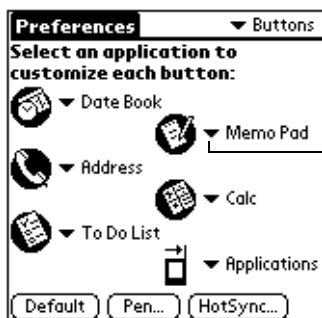

Tap arrow to show pick list

2. Tap the application that you want to assign to the button.

Tip: Tap Default to restore all of the buttons to their initial settings.

To identify the application that opens when you raise the antenna:

1. Tap the pick list next to the Applications button.
2. Tap the application you want to open whenever you raise the antenna.

Tip: Tap Default to have the Wireless category of the Applications Launcher open when you raise the antenna.

Pen preferences

The Buttons Preferences screen enables you to change the assignment of the full-screen pen stroke. By default, the full-screen pen stroke activates Graffiti Help.

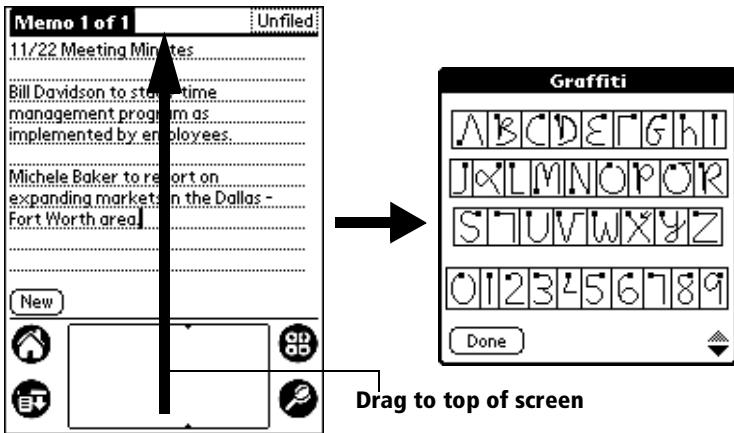

To change the Pen preferences:

1. Tap Pen.



2. Tap the pick list and select one of the following settings for the full-screen pen stroke:

Backlight: Turns the backlight of your handheld on and off.

Keyboard: Opens the onscreen keyboard for entering text.

Graffiti Help: Opens a series of screens that show the complete Graffiti character set.

Turn Off & Lock: Turns off and locks the handheld. You must assign a password to lock the handheld. When locked, you need to enter the password to use your handheld.

Beam Data: Beams the current record to another Palm OS® handheld equipped with an IR port.

3. Tap OK.

HotSync buttons preferences

The Button Preferences screen also enables you to associate different applications with the HotSync button on the cradle and the HotSync button on the optional PalmModem® accessory. Any changes you make in the HotSync Buttons dialog box become effective immediately; you do not have to change to a different screen or application.

To change the HotSync buttons preferences:

1. Tap HotSync.
2. Tap the pick list next to the button you want to assign.

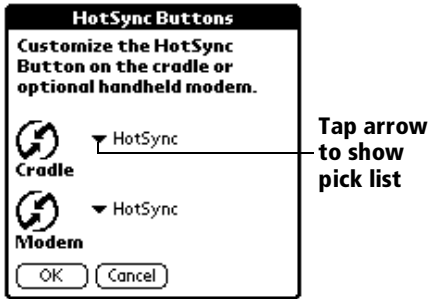

3. Tap the application that you want to assign to each button.

The default setting for each button is the HotSync setting, which means the cradle and optional PalmModem accessory perform their normal HotSync functions.

4. Tap OK.

Digitizer preferences

The Digitizer Preferences screen opens the digitizer calibration screen. This is the same screen that appears when you go through the Setup process for your handheld.

You can recalibrate your screen after a hard reset, or if your digitizer drifts.

Formats preferences

Use the Formats Preferences screen to set the country default and the display format of the dates, times, and numbers on your handheld.

Country default

The country default sets date, time, week start day, and number conventions based on geographic regions where you might use your handheld. For example, in the United Kingdom, time often is expressed using a 24-hour clock. In the United States, on the other hand, time is expressed using a 12-hour clock with an AM or PM suffix.

All your handheld applications use the Country default settings. You can, however, customize your own preferences as described in the “Time, date, week start, and numbers formats” section later in this chapter.

To set the country default:

1. Tap the country name pick list.

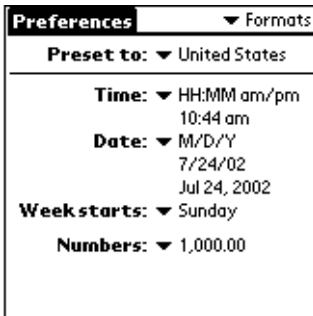

2. Tap the setting you want to use.

Time, date, week start, and numbers formats

The Time setting defines the format for the time of day. The time format that you select appears in all applications on your handheld.

To select the time, date, week start, and numbers format:

1. Tap the Time pick list and select a format.
2. Tap the Date pick list and select a format.
3. Tap the Week starts pick list, and select whether you want the first day of the week to be Sunday or Monday.

Note: This setting controls the Day, Week, and Month views in Date Book and all other aspects of your handheld that display a calendar.

4. Tap the Numbers pick list, and select formats for the decimal point and thousands separator.

General preferences

The General Preferences screen enables you to set the time, date, auto shutoff interval, sounds, and beam receive option for your handheld.

See Chapter 1 for information on setting the time and date.

Auto-off delay

Your handheld has an automatic shutoff feature that turns off the power and backlight after a period of inactivity. This feature helps conserve battery power in case you forget to turn off your handheld.

If you find that your handheld shuts itself off before you finish reviewing the information on the screen, you should increase the time setting of the automatic shutoff feature.

To set the Auto-off delay:

1. Tap the Auto-off pick list.
2. Tap the setting you want to use for the automatic shutoff feature: 30 seconds, 1 minute, 2 minutes, or 3 minutes.

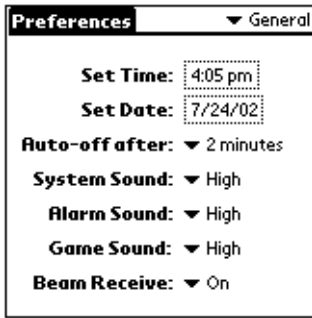

System, alarm, and game sounds

Your handheld uses a variety of sounds. The System, Alarm, and Game Sound settings enable you to turn the sounds on or off, and to adjust the volume level.

To set the system and alarm sounds:

1. Tap the System Sound pick list and select the sound level.

Note: When you turn off the System Sounds, you also turn off the “chime” tones associated with the HotSync operation.

2. Tap the Alarm Sound pick list and select the sound level.
3. Tap the Game Sound pick list and select the sound level.

Note: The Game Sound setting works only with games that are programmed to respond to this setting. Older games typically do not respond to this setting.

Beam Receive

You can choose to turn off the Beam Receive feature. This prohibits anyone from beaming information to your handheld. It also results in a slight saving of battery power.

To change the Beam Receive setting:

- Tap the Beam Receive pick list and select On or Off.

Connection preferences

The Connection Preferences screen enables you to define the settings used to perform different types of HotSync operations. The screen displays a list of available configurations that are ready to be further defined; the list varies depending on the kind of software you've added to your handheld.

For example, a modem connection appears on the list. If you have this modem, you only need to specify the phone setup (and network connection — if required) to complete the configuration.

Note: You can purchase a modem for use with your handheld. See <http://www.palm.com>.

You can also create custom configurations. There are four possible kinds of connections.



Serial to PC: A local HotSync connection: the direct serial connection between your handheld and your desktop computer. Your handheld is connected by its serial port to the cradle, and the cradle is attached by its cable to a serial (COM) port of your desktop computer.

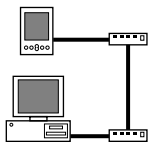

Serial to Modem: A connection between a modem attached to the serial port of your handheld and a modem that is part of your computer or laptop.



IrCOMM to PC: A connection between the IR port of your handheld and the infrared device of your computer or laptop.

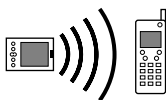

IrCOMM to Modem: A connection between the IR port of your handheld and a modem. The modem can be attached to a computer or some other device containing an IR port.

Sample connection for remote IR HotSync operations

The following sample configuration would enable you to perform an IR HotSync operation by sending data through the IR port of a modem attached to a cell phone, which then dials a modem attached to your desktop computer, to synchronize with your Desktop application. For this example, you use the IrCOMM to Modem connection.

To create an IrCOMM to Modem connection:

1. Tap New.
2. Enter a name to identify this configuration.
3. Tap the Connection Method pick list and select IrCOMM to Modem.



4. Tap the Dialing pick list and select TouchTone or Rotary.
5. Tap the Volume pick list and select the speaker volume you want.
6. Tap Details.

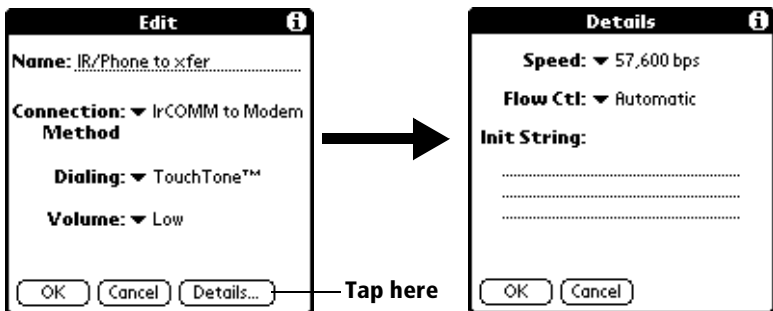

7. Enter the initialization string supplied by the documentation for the modem attached to your cell phone.
8. Tap OK, and then tap OK again to save the configuration.



Your new configuration appears in the list of available configurations

After you create the configuration, you need to set up the HotSync Manager of your Desktop application and the HotSync application of your handheld to perform a modem HotSync operation.

Network preferences and TCP/IP software

The Network Preferences settings enable you to use the TCP/IP software that is included in the Palm OS software. You can use the TCP/IP software to connect with Internet Service Providers (ISPs) or dial-in (remote access) servers. Because the TCP/IP software is a feature of the operating system, you configure all parameters relating to it from the Preferences application.

To use TCP/IP, you must create a configuration in Connection Preferences and then create Network Preferences settings.

Note: The Connection Preferences screen enables you to define several ways that your handheld can use the modem to communicate with remote devices. For example, you can communicate with your ISP server, or with your computer if you are away on travel. See “Connection preferences” earlier in this chapter for details on creating modem configurations.

After you configure both the Connection and Network Preferences, you can establish a PPP (Point-to-Point Protocol), SLIP (Serial Line Internet Protocol), or CSLIP (Compressed Serial Line Internet Protocol) connection with your ISP or dial-in server. You can do this either by using menu commands from the Network Preferences screen or by using a third-party application.

Note: TCP/IP enables you to connect to your ISP or dial-in server with applications that allow you to view the transmitted data. Visit the web site <http://www.palm.com> for information on third-party applications that take advantage of TCP/IP.

Selecting a service

Use the Service setting to select the service template for your Internet Service Provider or a dial-in server. Service templates are a set of ISP and dial-in server configuration settings that you can create, save, and reuse.

To select a service:

1. Tap the Service pick list.

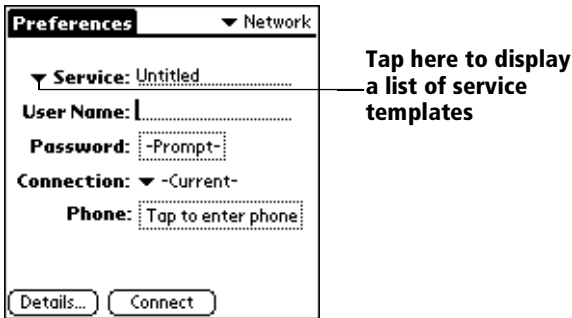

2. Tap the predefined service template you want to use.

Entering a user name

The User Name setting identifies the name you use when you log into your Internet Service Provider or your dial-in server. Although this field can contain multiple lines of text, only two lines appear onscreen.

To enter a user name:

1. Tap the User Name field.
2. Enter your user name.

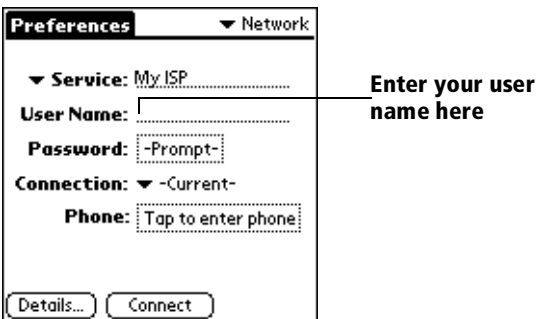

Note: Most dial-in servers do not accept spaces in the user name.

Entering a password

The Password box identifies the password you use to log into your server or ISP. Your entry in this field determines whether your handheld prompts you to enter a password each time you log into your network:

- If you do not enter a password, your handheld displays the word “Prompt” in this field and asks you to enter a password during the login procedure.
- If you enter a password, your handheld displays the word “Assigned” in this field and does not prompt you to enter a password during the login procedure.

Note: If you are concerned about security, select the Prompt option and do not enter a password.

To enter a password:

1. Tap the Password field.
2. Enter the password you use to log into your server.

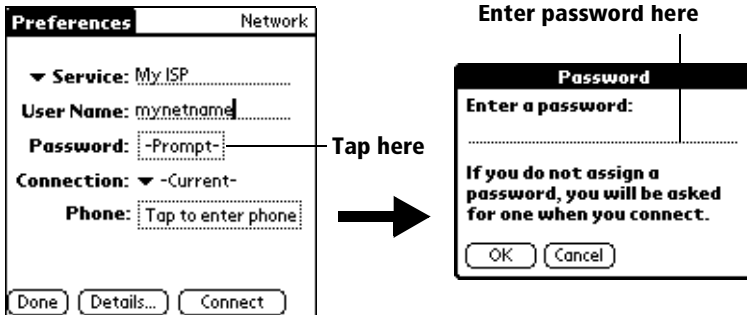

3. Tap OK.

Note: The Password field updates to display the word “Assigned.”

Selecting a connection

Use the Connection setting to select the method you want to use to connect to your Internet Service Provider or a dial-in server. See “Connection preferences” earlier in this chapter for information about creating and configuring connection settings.

To select a connection:

1. Tap the Connection pick list.



Tap here to display
a list of available
connections

2. Tap the connection you want to use.

Adding telephone settings

When you select the Phone field, your handheld opens a dialog box in which you define the telephone number you use to connect with your ISP or dial-in server. In addition, you can also define a prefix, disable Call Waiting, and give special instructions for using a calling card.

Note: The Phone Setup dialog box works correctly for AT&T and Sprint long-distance services. However, because MCI works differently, MCI customers need to put the calling card number in the Phone # field and the phone number in the Use calling card field.

To enter your server phone number:

1. Tap the Phone field.
2. Enter the phone number you use for your ISP or dial-in server.



Enter your ISP phone
number here

3. If you need to enter a prefix or disable Call Waiting, continue to the following procedures. If not, tap OK.

Entering a prefix

A prefix is a number that you dial before the telephone number to access an outside line. For example, many offices require that you dial “9” to dial a number outside the building.

To enter a prefix:

1. Tap the Dial Prefix check box to select it.

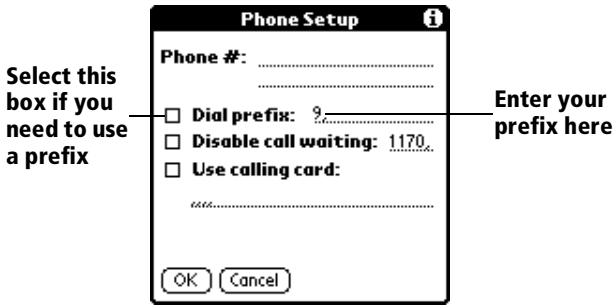

2. Enter the prefix.

Tip: It's a good idea to add a comma after the prefix. One comma adds a two-second delay to the transmission.

3. Tap OK.

Disabling Call Waiting

Call Waiting can cause your session to terminate if you receive a call while you are connected. If your telephone has Call Waiting, you need to disable this feature before logging into your ISP or dial-in server.

To disable Call Waiting:

1. Tap the Disable call waiting check box to select it.

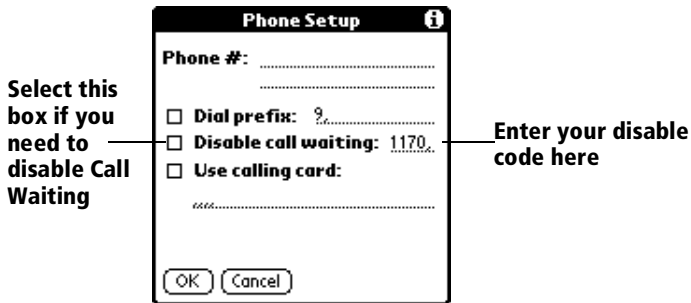

2. Enter the code to disable Call Waiting on the Disable call waiting line.

Note: Each telephone company assigns a code to disable Call Waiting. Contact your local telephone company for the code that is appropriate for you. It's a good idea to add a comma after the code. One comma adds a two-second delay to the transmission.

3. Tap OK.

Using a calling card

The Use calling card field enables you to use your calling card when dialing your ISP or Intranet server. Keep in mind that there is usually a delay before you enter your calling card number. When you define your calling card number, you need to add commas at the beginning to compensate for this delay. Each comma delays transmission of your calling card number for two seconds.

To use a calling card:

1. Tap the Use calling card check box to select it.

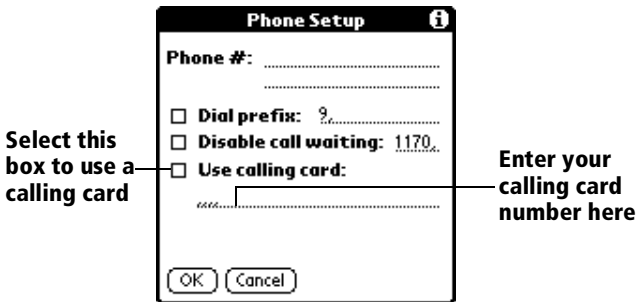

2. Enter your calling card number on the Use calling card line.

Note: It's a good idea to add at least three commas before your calling card number to compensate for the cue delay.

3. Tap OK.

Connecting to your service

After you set your Connection and Network Preferences, establishing a connection to your Internet Service Provider (ISP) or your company's network (dial-in server) is easy.

Note: If you are connecting to an ISP, you need a third-party application, such as a web browser or news reader, to take advantage of this connection. For information about third-party applications that support TCP/IP, check the web site <http://www.palm.com>.

To establish a connection:

- In the Network Preferences screen, tap Connect to dial the current service and display the Service Connection Progress messages.

Tip: To see expanded Service Connection Progress messages, press the lower half of the Scroll button.

To close a connection:

- Tap Disconnect to terminate the connection between your handheld and your service.

Creating additional service templates

You can create additional service templates from scratch or by duplicating existing templates and editing information. After you create a new or duplicate template, you can add and edit settings.

To add a new service template:

1. Tap the Menu icon .
2. Tap Service, and then tap New.

A new service template (called Untitled) is added to the Service pick list.

To duplicate an existing service template:

1. Tap the Service pick list.
2. Tap the predefined service template you want to duplicate.
3. Tap the Menu icon .
4. Tap Service, and then tap Duplicate.

A copy of the service template is added to the Service pick list.

Adding detailed information to a service template

If you are using one of the predefined service templates, you probably only need to enter your user name and telephone number. If you are creating a new service template, you may need to provide additional information to your ISP or dial-in server. You use the Details dialog box to add additional information to a selected service template.

To select a connection type:

1. Tap the service field.
2. Tap Details.

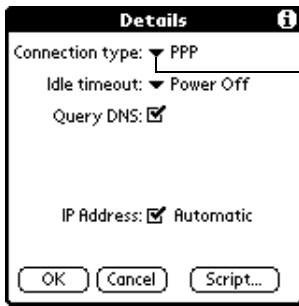

Select connection type

3. Tap the Connection type pick list and select one of the following connection types:

PPP: Point-to-Point protocol

SLIP: Serial Line Internet Protocol

CSLIP: Compressed Serial Line Internet Protocol

Note: If you are not sure, try PPP; if that doesn't work, ask your Internet Service Provider or your System Administrator for the correct connection type.

Idle timeout

The Idle timeout setting defines how long your handheld waits before dropping the connection with your ISP or dial-in server when you switch out of a TCP/IP application.

To set the Idle timeout:

1. Tap the Idle timeout pick list and select one of the following options:

Immediate: Drops the connection to your ISP immediately when you switch to another application.

1 minute: Waits one minute for you to open another application before it drops the connection.

2 minutes: Waits two minutes.

3 minutes: Waits three minutes.

Power Off: Keeps your PPP or SLIP connection until you turn off your handheld (or until it times out). This option works best with the PalmModem accessory.

2. Tap OK.

Defining primary and secondary DNS

The Domain Naming System (DNS) is a mechanism in the Internet for translating the names of host computers into IP addresses. When you enter a DNS number (or IP address), you are identifying a specific server that handles the translation services.

Each IP address has four sections, separated by periods. In the Details dialog box, you enter each section separately. Each section of an IP address is made up of a number from 0 to 255; numbers are the only allowable characters in this field.

Ask your Internet Service Provider or System Administrator for the correct Primary or Secondary DNS IP numbers.

Tip: Many systems do not require that you enter a DNS. If you are not sure, leave the DNS field blank.

To enter a primary and secondary DNS:

1. Tap the Query DNS check box to deselect it.
2. Tap the space to the left of the first period in the Primary DNS field, and then enter the first section of the IP address.

Note: Each section must be a number from 0 to 255.

3. Repeat step 2 for the second, third, and last sections of the Primary DNS field.
4. Repeat steps 2 and 3 for the Secondary DNS number.
5. Tap OK.

IP address

Everyone who logs on to the Internet needs to have a unique identifier (an IP address), whether permanent or temporary. Some networks dynamically assign a temporary IP address when clients log in. The IP Address field lets you identify whether your network provides automatic (dynamic) temporary IP addressing.

Note: If your IP address is permanently assigned, you need to get that information from your System Administrator. If you are not sure, select Automatic.

To identify dynamic IP addressing:

- Tap the IP Address check box to select it.

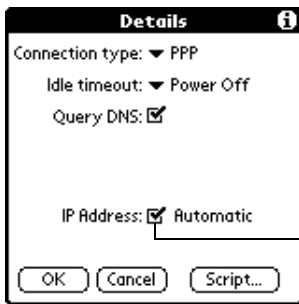

Tap to select automatic IP address

To enter a permanent IP address:

1. Tap the IP Address check box to deselect it and display a permanent IP address field below the check box.
2. Tap the space to the left of the first period then enter the first section of the IP address.

Note: Each section must be a number from 0 to 255.

3. Tap and enter the remaining sections of the IP address.
4. Tap OK.

Login scripts

A login script is a series of commands that automates logging in to a network server, for example, your corporate network or your Internet Service Provider (ISP). A login script is associated with a specific service template created in Network Preferences.

A login script is something that you are likely to receive from your IS System Administrator if your company has a system in which you log in to the corporate servers from your handheld using a modem or network connection. The script is generally prepared by the System Administrator and distributed to users who need it. It automates the events that must take place in order to establish a connection between your handheld and the corporate servers.

You can create login scripts in two ways:

- In a text editor on your desktop computer, in which you create a file with the extension PNC, which you then install on your handheld using the Install Tool (this method is not available to Macintosh users)

- In the Login Script dialog box on your handheld, accessed from the Details dialog box in Network Preferences

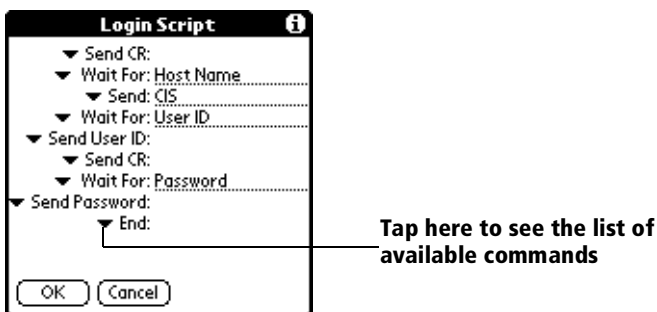

Note: You can also use non-ASCII and literal characters in your login script. See Appendix D for more information.

Creating a login script on your handheld

You can create login scripts by selecting commands from the Command pick list in the Login Script dialog. Some commands, such as Send, require you to supply additional information. Those commands have a parameter field so that you can add the necessary data.

To create a login script:

1. Tap Script.
2. Tap the End pick list.

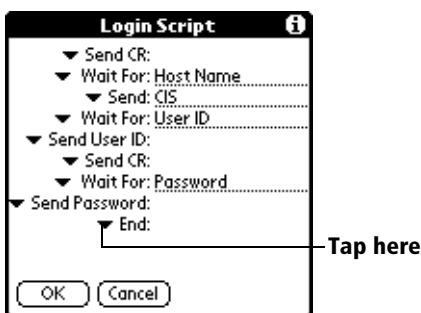

3. Tap the command you want from the Command list. If the command requires additional information, a field appears to the right of it for you to enter the information. The following commands are available:

Wait For	Tells your handheld to wait for specific characters from the TCP/IP server before executing the next command.
Wait For Prompt	Detects a challenge-response prompt coming from the server and then displays the dynamically generated challenge value. You then enter the challenge value into your token card, which in turn generates a response value for you to enter on your handheld. This command takes two arguments, separated by a vertical bar () on the input line.
Send	Transmits specific characters to the TCP/IP server to which you are connecting.
Send CR	Transmits a carriage return or LF character to the TCP/IP server to which you are connecting.
Send User ID	Transmits the User ID information entered in the User ID field of the Network Preferences screen.
Send Password	Transmits the password entered in the Password field of the Network Preferences screen. If you did not enter a password, this command prompts you to enter one. The Password command is usually followed by a Send CR command.
Delay	Tells your handheld to wait a specific number of seconds before executing the next command in the login script.
Get IP	Reads an IP address and uses it as the IP address for your handheld. This command is used with SLIP connections.
Prompt	Opens a dialog box and prompts you to enter text of some kind (for example, a password or a security code).
End	Identifies the last line in the login script.

- Repeat steps 2 and 3 until the login script is complete.
- Tap OK.

Plug-in applications

You can create plug-in applications containing script commands that extend the functionality of the built-in script commands. A plug-in application is a standard PRC application that you install on your handheld just like any other application. After you install the plug-in application, you can use the new script commands in a login script.

Plug-in applications have the following characteristics:

- Written in C language
- Compiled into a device executable
- Called properly from a login script
- Able to return control to a login script after it terminates
- Created using a development environment that supports Palm OS[®] software, such as Metrowerks CodeWarrior for Palm Computing Platform.

For additional information on creating plug-in applications, send e-mail to Palm Developer Support at devsupp@palm.com.

Deleting a service template

Use the Delete command from the Service menu to delete a service template.

To delete a service template:

1. Tap the Service pick list.
2. Tap the service template you want to delete.
3. Tap the Menu icon .
4. Tap Service, and then tap Delete.
5. Tap OK.

Network preferences menu commands

The Network Preferences screen includes menu commands to make it fast and easy to create and edit service templates. TCP/IP application menus are shown here for your reference.

See “Using menus” in Chapter 1 for more information about choosing menu commands.

Service menu

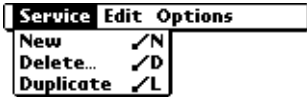

Options menu



TCP/IP troubleshooting

If you are having a problem establishing a network connection using TCP/IP, check this section and try the suggestions listed.

Displaying expanded Service Connection Progress messages

It's helpful to identify at what point in the login procedure the connection fails. An easy way to do this is to display the expanded Service Connection Progress messages. Expanded Service Connection Progress messages describe the current stage of the login procedure. Press the lower half of the scroll button at any point during login to display these messages.

Viewing the Network Log

If viewing the expanded Service Connection Progress messages does not give you enough information to find out why you cannot connect to your ISP or dial-in server, take a look at the Network Log. The Network Log lists all of the communication that occurs between your modem and your dial-in server during the login procedure. The information in the Network Log can help your ISP or your System Administrator pinpoint where and why the login procedure communication fails.

To view the Network Log:

1. Tap Options, and then tap View Log.
2. Tap the up and down arrows of the scroll bar to see the entire Network Log.
3. Tap Done.

Adding a DNS number

If your ISP or dial-in server requires a DNS number and you did not enter that information in the Network Preferences screen, it will appear that you successfully logged into your network. When you try to use an application or look up information, however, the connection fails. If this occurs, try adding a DNS number. Ask your ISP or your System Administrator for the correct Primary and Secondary DNS IP numbers.

Owner preferences

The Owner Preferences screen enables you to record a name, company name, phone number, or any other information that you want to associate with your handheld.

If you use the Security application to turn off and lock your handheld with a password, information that you put in the Owner Preferences displays the next time you turn on your handheld. See “Security” in Chapter 3 for more information.

To enter the Owner preferences:

- Enter the text that you want to associate with your handheld in the Owner Preferences screen. If the text cannot fit on one screen, a scroll bar automatically appears on the right side of the screen.

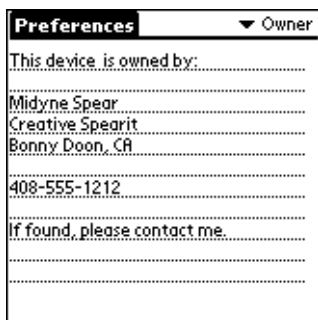

If you assign a password with the Security application, the information in the Owner Preferences screen cannot be changed. In this case, an Unlock button appears at the bottom of the screen.

To unlock the Owner Preferences screen:

1. Tap Unlock.
2. Enter the password that you defined in the Security application.
3. Tap OK.

ShortCuts preferences

The ShortCuts Preferences screen enables you to define abbreviations for entering text with Graffiti strokes. This section describes how to create, edit, and delete a ShortCut. See “Graffiti ShortCuts” in Chapter 2 for more information on the use of ShortCuts.

Creating a ShortCut

You can create a ShortCut for any words, letters, or numbers. All ShortCuts you create appear on the list in the ShortCut Preferences screen. All the ShortCuts are available in any of your handheld applications and are backed up on your computer when you perform a HotSync operation.

To create a ShortCut:

1. Tap New.
2. On the ShortCut name line, enter the letters you want to use to activate the ShortCut.

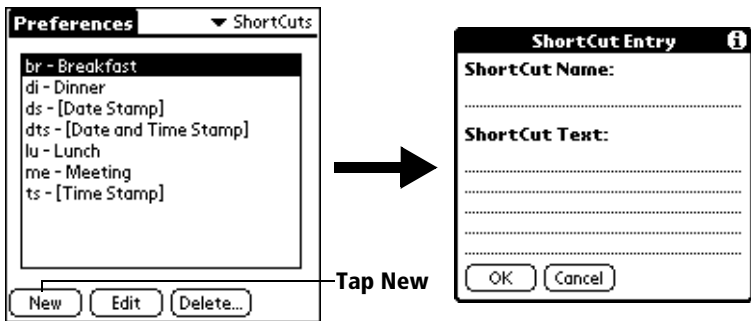

3. Tap the ShortCut Text area and enter the text that you want to appear when you write the ShortCut characters.

Tip: You may want to add a space (space character) after the last word in your ShortCut text. This way, a space automatically follows the ShortCut text.

4. Tap OK.

Tip: To use a ShortCut, draw the ShortCut stroke followed by the ShortCut characters. When you draw the ShortCut stroke, the ShortCut symbol appears at the insertion point to show that you are in ShortCut mode.

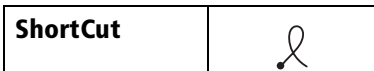

Editing a ShortCut

After you create a ShortCut, you can modify it at any time.

To edit a ShortCut:

1. Tap the ShortCut you want to edit.
2. Tap Edit.
3. Make the changes you want and tap OK.

Deleting a ShortCut

If you don't need a ShortCut, you can delete it from the ShortCut list.

To delete a ShortCut:

1. Tap the ShortCut you want to delete.
2. Tap Delete.
3. Tap Yes.

Wireless preferences

The Wireless Preferences screen enables you to do the following:

- View your address on the Palm.Net network, which you create when you activate the service.
- Change the proxy server with which your handheld communicates.
- Receive a warning when a wireless transaction is about to transmit your identification or location.

Proxy

The IP address that appears by default in this screen is the address of the Palm.Net proxy server. You do not need to identify a different proxy server unless your organization has its own proxy server and supplies you with an IP address for that proxy server.

To change the IP address of your proxy server:

1. Tap the Proxy field.

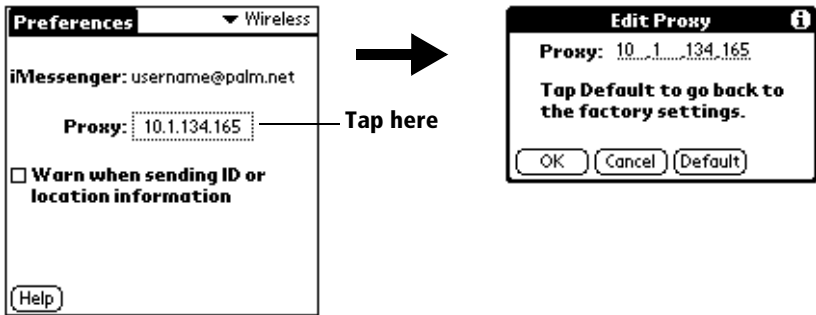

2. Tap the dot to the right of the first section of the Proxy field, and then enter the first section of the IP address.

Note: Each section must be a number from 0 to 255.

3. Repeat step 2 for the second, third, and last sections of the IP address.
4. Tap OK.

Tip: To restore the initial IP address of the proxy server, tap Default.

Sending ID or location information

When you submit a query to some web clipping applications, they automatically elicit the following information from your handheld:

- The number that uniquely identifies your handheld
- Your approximate location, reported as the ZIP code of the area where you are currently located

Having such information enables the web clipping application to offer you better service and more accurate information in its clippings.

If, however, you do not want to send this information over the airwaves, you can receive a warning whenever a web clipping application is about to send this information. The warning gives you a choice; you can continue the transaction or cancel the transaction before any information is sent.

To activate the warning about transmission of ID or location:

- Select the check box next to Warn when sending ID or location information. A check mark should appear in the check box.

Appendix A

Maintaining Your Handheld

This chapter provides information on the following:

- Caring for your handheld
- About the AAA batteries
- Automatic recharging of the transmitter
- Proper use of the antenna
- Resetting your handheld

Caring for your handheld

Your handheld is designed to be rugged and reliable and to provide years of trouble-free service. Please observe the following general tips when using your handheld:

- Take care not to scratch the screen of your handheld. Keep the screen clean. When working with your handheld, use the supplied stylus or plastic-tipped pens intended for use with a touch-sensitive screen. Never use an actual pen or pencil or other sharp object on the surface of the handheld screen.
- Your handheld is not waterproof and should not be exposed to rain or moisture. Under extreme conditions, water may enter the circuitry through the front panel buttons. In general, treat your handheld as you would a pocket calculator or other small electronic instrument.
- The touch-sensitive screen of your handheld contains a glass element. Take care not to drop your handheld or subject it to any strong impact. Do not carry your handheld in your back pocket: if you sit on it, the glass may break.
- Protect your handheld from temperature extremes. Do not leave your handheld on the dashboard of a car on a hot day, and keep it away from heaters and other heat sources.
- Do not store or use your handheld in any location that is extremely dusty, damp, or wet.
- Use a soft, damp cloth to clean your handheld. If the surface of the handheld screen becomes soiled, clean it with a soft cloth moistened with a diluted window-cleaning solution.

About the AAA batteries

Please note the following considerations when replacing the batteries in your handheld:

- Under normal conditions, depending on your usage pattern, the AAA batteries of your handheld should provide weeks of use. You can conserve battery life by minimizing the use of the backlight feature, and changing the Auto-off setting that automatically turns the handheld off after a period of inactivity. See “General preferences” in Chapter 8 for more information.
- As the batteries become low in the course of normal use, messages appear onscreen alerting you to the low battery condition. Replace the batteries as soon as you can after the first alert appears. Remember to perform a HotSync® operation to back up your data before you replace the batteries. This helps prevent accidental data loss.
- When replacing the batteries, begin by turning your handheld off (so there is no screen display).
- When replacing the batteries, always use good quality batteries of the same type. Do not mix old and new batteries. Use only alkaline batteries with your handheld.
- When you remove the old batteries, the built-in backup power of your handheld maintains memory data. Whenever you remove the batteries, replace them immediately. We recommend replacing batteries within a **period of one minute**. If you encounter any difficulties or delays while you’re replacing the batteries, reinstall the original batteries and wait a few minutes for the backup power to recharge.
- If the batteries drain to the point where you cannot turn on your handheld, there is enough residual power in the batteries to preserve your data safely only for a few days beyond that point. If your handheld does not turn on when you press the power button, you should replace the batteries immediately.
- If you leave drained batteries in your handheld for an extended period of time, you can lose all of the stored data. If this happens, replace the batteries and use the reset button to reset your handheld. (See “Resetting your handheld” later in this chapter for details.) After you reset your handheld, perform a HotSync operation to restore the data from your computer.

Automatic recharging of the transmitter

The transmitter used by your handheld for web clipping and wireless Internet messaging contains a rechargeable storage battery. It is a NiCad (nickel-cadmium) battery.

When you first set up your handheld, the initial charging of the transmitter takes about 70 minutes. Like any storage battery, the transmitter must be recharged. How often recharging must happen depends on the frequency with which you use web clipping and wireless Internet messaging.

You don't have to do anything to recharge the transmitter. Your handheld senses when the transmitter needs to be recharged and automatically recharges it from the AAA batteries. Your handheld also tries to schedule the recharging of the transmitter at a time when you typically don't use the handheld. The handheld does not have to be turned on to recharge the transmitter.

To monitor the status of the transmitter:

1. In the Applications Launcher, tap the Diagnostics icon.
2. Tap Details.
3. Refer to the following fields for information on the transmitter:

Transmitter Charge: Indicates the voltage remaining in the transmitter. A number above 5 indicates that the transmitter has adequate power.

Scheduled Charge: Can show one of the five following states:

“Not Scheduled” indicates that your transmitter has adequate power.

“Today” or “Tomorrow” and a time indicate that your transmitter needs to be recharged, and your handheld has scheduled recharging to occur either today or tomorrow at the indicated time.

“Charging” indicates that your handheld is currently recharging the transmitter.

“Charging Suspended” indicates that your handheld is unable to recharge the transmitter because of power demands by your handheld (typically, the backlight is in use). To resume recharging, turn off the backlight or simply turn off your unit. Recharging resumes when power demands are reduced.

“Insert new AAA batteries” indicates that the batteries in your handheld lack sufficient power to continue recharging the transmitter. Insert new batteries as soon as you can.

Charge Finish: Appears only when recharging has been scheduled or is under way. Displays the estimated time that recharging will end.

Recharging takes less time than the initial charging of the transmitter. While the transmitter is being recharged, you cannot use web clipping applications or the iMessenger® application. You can, however, use all other applications.

Important: You yourself cannot replace the transmitter, even when it can no longer be recharged, because attempting to open the handheld voids the warranty. There are no parts inside your handheld that you can replace, so do not attempt to open it. See “Palm.Net™ Service Agreement and Other Product Information” for details.

For information on returning the handheld to Palm, Inc., visit the web site <http://www.palm.net>

The RBRC Battery Recycling Seal is on the NiCad battery inside your handheld, which indicates that Palm, Inc. is voluntarily participating in an industry program to collect and recycle these batteries at the end of their useful life, when taken out of service in the United States or Canada. The RBRC program provides a convenient alternative to placing used NiCad batteries into the trash or the municipal waste stream, which is illegal in some areas. Please call 1-800-8-BATTERY for information on NiCad battery recycling in your area. Palm, Inc.'s involvement in this program is part of our commitment to preserving our environment and conserving our natural resources.

If you ever dispose of your handheld, please dispose of it without damaging the environment. Either return your handheld to Palm, Inc., or take it to your nearest environmental recycling center.

Proper use of the antenna

The antenna of your handheld is designed to be durable and can easily withstand years of normal use. It is a movable part, however, so it's important to handle it with care. Keep these points in mind as you use the antenna:

- Do not lift or drag your handheld by the raised antenna.
- Do not bend the antenna.
- When you raise the antenna, you feel three clicks at its three positions: 90°, 135°, and 180°. We recommend that you transmit or receive data only after you raise the antenna at least to 90°.
- Whenever you're not using an application that performs wireless transactions, keep the antenna fully lowered.
- Before you use the wireless features of your handheld, please observe the guidelines or prohibitions on the use of wireless devices in your current location. For example, when you are on an airplane, do not raise the antenna or use the wireless features at times when the Federal Aviation Administration (FAA) or airline regulations prohibit the use of cellular phones. You can, of course, use all other applications of your handheld in accordance with airline regulations for electronic devices.

If the antenna is damaged, you can remove it and replace it with another antenna. For information on ordering a new antenna, visit the web site <http://www.palm.net>.

Important: Do not remove the antenna until you have a new antenna ready to install. Using the wireless features without an antenna can damage your handheld.

To remove the antenna:

1. Perform a HotSync operation, and then turn off your handheld.
2. Remove the AAA batteries.

Important: When you remove the batteries, the built-in backup power of your handheld maintains memory data. If you encounter any difficulties or delays while you're replacing the antenna, however, we recommend that you reinstall the batteries and wait a few minutes for the backup power to recharge. Then start the replacement process again.

3. Raise the antenna to 180°.

To be sure the antenna is raised to 180°, place the handheld face down on a flat surface and flatten the antenna against the surface.

4. Grasp the antenna close to the pivot point with your thumb and index finger.
5. Using your thumb, firmly push the antenna out of the pivot point.

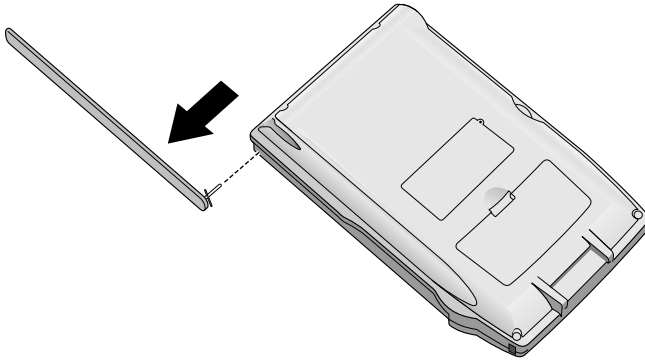

Note: After you remove the antenna, be careful not to change the alignment of the pivot point.

To insert the new antenna:

1. Holding the antenna in the 180° position, insert the contact pin into the center hole of the pivot point.
2. Align the transverse pin with the opening for it in the pivot point. Push the antenna the rest of the way into the pivot point until you feel the antenna snap into place.

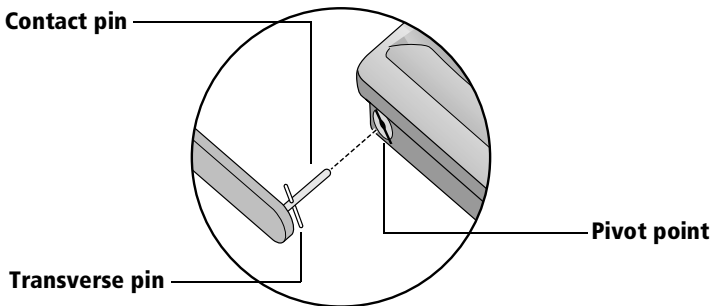

3. Lower the antenna.
4. Put the AAA batteries back in.
5. If necessary, perform a HotSync operation to restore your data.

Resetting your handheld

Under normal circumstances, you will not have to use the reset button. On rare occasions, however, your handheld may no longer respond when you press buttons or tap the screen. In this case, you need to reset your handheld so that it will work again.

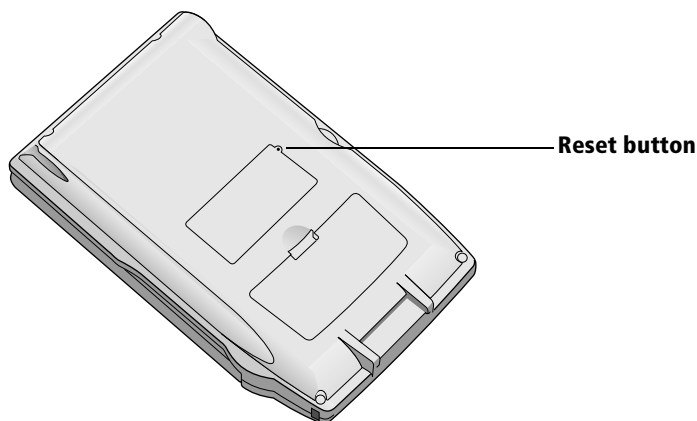

Performing a soft reset

A soft reset tells your handheld to stop what it's doing and start over again. All records stored in your handheld are retained with a soft reset.

Tip: The stylus that comes with your handheld has a reset tool inside. To use the tool, unscrew the top of the stylus.

To perform a soft reset:

- Use the reset tool, or the tip of an unfolded paper clip (or similar object *without* a sharp tip), to gently press the reset button inside the hole on the back panel of your handheld.

After a soft reset, the Welcome screen appears, followed by the General Preferences screen (to set time and date).

Performing a hard reset

With a hard reset, all records stored in your handheld are erased. Never perform a hard reset unless a soft reset does not solve your problem.

After performing a hard reset, you can transfer the data in Palm™ Desktop software to your handheld by performing a HotSync operation.

To perform a hard reset:

1. Hold down the power button on the front panel of the handheld.
2. While holding down the power button, use the reset tip tool, or the tip of an unfolded paper clip (or similar object *without* a sharp tip), to gently press and release the reset button.
3. Wait for the Palm Computing® Platform logo to appear; then release the power button.
4. When a message appears on the handheld screen warning that you are about to erase all the data stored on your handheld, do one of the following:

Press the upper half of the scroll button on the front panel of the handheld to complete the hard reset and start Setup.

Press any other button to perform a soft reset.

Besides erasing all records, note these results of a hard reset:

- The current date and time are retained.
- Formats Preferences and other settings are restored to their initial default settings.
- Preloaded web clipping applications reappear on your handheld. Other add-on applications, however, are deleted from your handheld, so you need to re-install them.
- If you use a proxy server other than the Palm.Net proxy server, you must re-enter its IP address. See “Wireless preferences” in Chapter 8 for details.

To restore your data after a hard reset:

Important: Be sure to perform a HotSync operation *before* you use the Check & Send command in the iMessenger application.

1. Click the HotSync icon ™ in the Windows system tray (bottom-right corner of the taskbar).

2. From the HotSync Manager menu, choose Custom.

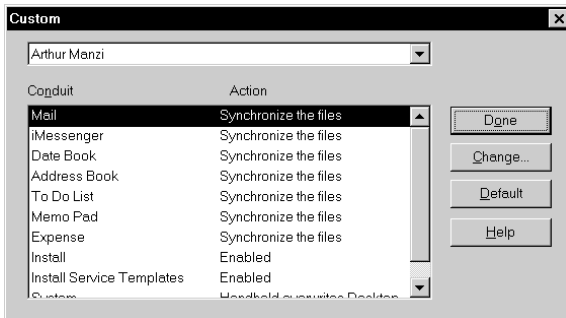

3. Select the appropriate user name from the list.
4. Select an application in the Conduit list.
5. Click Change.

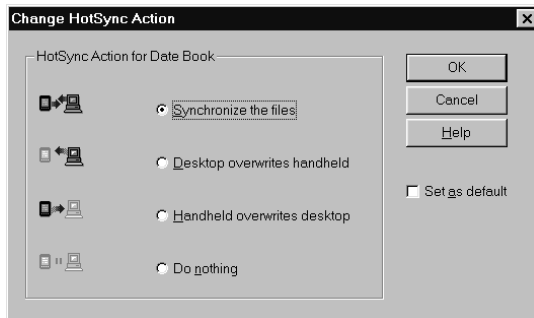

6. Select Desktop overwrites handheld.

Note: Changing the HotSync setting from the default affects only the *next* HotSync operation. Thereafter, the HotSync actions revert to their default settings.

7. Click OK.
8. Repeat steps 4 through 7 to change conduit settings for other applications.
9. Click Done to activate your settings.
10. Perform a HotSync operation.

Appendix B

Frequently Asked Questions

If you encounter a problem with your handheld, do not call Technical Support until you have reviewed the following list of frequently asked questions, and you have also reviewed the following:

- The README file and HelpNotes located in the folder where you installed Palm™ Desktop software on your computer (or on your installation CD)
- The Palm Desktop online Help
- The “Palm Support Assistant” knowledgebase, accessible at <http://www.palm.com> under the Support section
- The latest Palm VII™ handheld customer support information on <http://www.palm.net>

If you are still having problems, contact Technical Support. For e-mail addresses and telephone numbers, see the *Getting Started* guide that comes with your handheld.

Note: Thousands of third-party add-on applications have been written for Palm OS® handhelds. Unfortunately, we are not able to support such a large number of third-party applications. *If you are having a problem with a third-party application, please contact the developer or publisher of that software.*

Software installation problems

Problem

I cannot install Palm Desktop software with Windows 95/98.

Solution

Try the following:

1. Disable any virus scanning software on your computer.
2. Press CTRL-ALT-DELETE and end all tasks except Systray and Explorer.
3. Make sure your computer has at least 20MB disk space.
4. Delete all temporary files.
5. Run ScanDisk on your computer.
6. Reinstall Palm Desktop software.

Operating problems

Problem

Solution

I don't see anything on my handheld's screen.

Try each of these in turn:

- Adjust the contrast control. See "Locating back panel components" in Chapter 1.
- Make sure the batteries are installed properly. See "Installing the batteries" in Chapter 1.
- Replace the batteries. If your handheld still does not operate, try a soft reset. See "Resetting your handheld" in Appendix A.
- If your handheld was exposed to cold, make sure it is at room temperature.

I get a warning message telling me my handheld memory is full.

- Purge the Date Book, To Do List, Mail, and iMessenger® applications. This removes records that you deleted from these applications from memory. See "Purging records" in Chapter 4. You may also need to perform a HotSync® operation to recover the memory.
- Delete unused memos and records. If necessary, you can save these records. See "Deleting records" in Chapter 4.
- If you have installed additional applications on your handheld, remove them to recover memory. See "Removing applications" in Chapter 3.

My handheld keeps turning itself off.

Your handheld is designed to turn itself off after a period of inactivity. This period can be set at 30 seconds, one, two, or three minutes. Check the Auto-off setting. See "General preferences" in Chapter 8.

My handheld is not making any sounds.

Check the System Sound setting. See "General preferences" in Chapter 8.

My handheld has frozen.

Perform a soft reset. See "Resetting your handheld" in Appendix A.

Tapping and writing problems

Problem

When I tap the buttons or screen icons, my handheld activates the wrong feature.

When I tap the Menu icon , nothing happens.

I can't get my handheld to recognize my handwriting.

Solution

Calibrate the screen. See “Digitizer preferences” in Chapter 8.

Not all applications or screens have menus. Try changing to a different application.

- For your handheld to recognize handwriting input with the stylus, you need to use Graffiti® writing. See “Using Graffiti writing to enter data” in Chapter 2.
- Make the Graffiti character strokes in the Graffiti writing area, not on the display part of the screen.
- Write Graffiti strokes for letters in the left-hand side, and the strokes for numbers in the right-hand side of the Graffiti writing area.
- Make sure that Graffiti is not shifted into extended or punctuation modes. See “Using Graffiti writing to enter data” in Chapter 2.
- See “Graffiti tips” in Chapter 2 for tips on increasing your accuracy when you write Graffiti characters.

Wireless problems

Problem

Solution

The signal strength is weak.

- Make sure the antenna is pointing straight up, perpendicular to the ground:
If you hold your handheld in your hand, raise the antenna to 135°.
If you lay it on a table or other surface parallel to the ground, raise the antenna to 90°.

Tap the Diagnostics icon . Then monitor the signal strength while you try the following solutions:

- Move away from your original location, five to ten feet in any direction.
- If you are indoors, stand near a window, or move outdoors.
- Open metal blinds on windows.
- If you are in an underground parking lot or other space below street level, move to a location aboveground.
- If you are in a crowd, move to a less crowded area.
- If you're in a vehicle, keep your handheld level with the windshield. The metal frame of the vehicle shields radio signals. Mountains and buildings may also block signals.
- If you're outdoors, move away from overhead electrical wires. Move from under trees.

I forgot the password to my Palm.Net™ service account.

Visit <http://www.palm.net>, or contact Customer Care. See the *Getting Started* guide for contact information.

Application problems

Problem

Solution

I tapped the Today button, but it does not show the correct date.

Your handheld is not set to the current date. Make sure the Set Date box in the General Preferences screen displays the current date. See “General preferences” in Chapter 8 for more information.

I know I entered some records, but they do not appear in the application.

- Check the Categories pick list (upper-right corner). Choose All to display all of the records for the application.
- Check Security and confirm that Private Records is set to Show private records.
- In To Do List, tap Show and see if Show Only Due Items is selected.

I am having problems listing memos the way I want to see them.

- If you cannot manually arrange the order of the memos in the list screen, check the Memo Preferences setting. Make sure that Sort by is set to Manual.
- If you choose to view your memos alphabetically on Palm Desktop software and then perform a HotSync operation, the memos on your handheld still appear in the order defined in the Memo Preferences setting. In other words, the sort settings you use with Palm Desktop software *are not* transferred to your handheld.

I created an event in Date Book, but it doesn't appear in the Week View.

In the Week View, you cannot select overlapping events that have the same start time. If you have two or more events with the same start time, choose the Day View to see the overlapping events.

I entered the euro symbol, but after a HotSync operation it doesn't appear in my Palm Desktop software.

You must have fonts that include the euro symbol on your desktop computer. Check these web sites for additional information:
<http://www.microsoft.com/windows/euro.asp>
<http://til.info.apple.com/techinfo.nsf/artnum/n22222>

HotSync problems

Problem

Solution

I cannot do a HotSync operation; what should I check to make sure I am doing it correctly?

- Check the Windows system tray to make sure the HotSync Manager is running. If it is not, open Palm Desktop software.
- Click the HotSync Manager, choose Setup, and click the Local tab. Check that the Serial Port setting displays the correct serial (COM) port where your cradle is attached.
- Make sure the cradle is connected securely.

I did a HotSync operation, but one of my applications did not synchronize.

Click the HotSync Manager and choose Custom. Check that the correct conduit is active.

I am using Outlook as my PIM, but I cannot do a HotSync operation.

- Click the HotSync Manager and choose Custom. Check that the correct conduit is active.
- Check that the correct conduit is installed. Reinstall the HotSync Manager and make sure the correct conduit is selected.

I cannot launch the HotSync Manager.

- Make sure you are not running another program, such as America Online, CompuServe, or WinFax, that uses the serial port you selected in the Setup dialog box.
- Backup the Palm Desktop software, uninstall it, and then reinstall it.

My handheld appears to freeze when I place it near my computer.

Move your handheld away from the computer's infrared port.

I tried to do a local HotSync operation, but it did not complete successfully.

Try each of these in turn:

- Make sure HotSync Manager is running. If HotSync Manager is running, exit and restart it.
- Make sure you selected Local from the HotSync Manager menu or the Palm Desktop software menu.
- Check the cable connection between the cradle and the serial port on your computer.
- Make sure you selected the correct serial port on the Local tab in the Setup dialog. It should be set to the port where you connected the cradle.
- Try a lower baud rate setting on the Local tab in the Setup dialog.
- Make sure you are not running another program, such as America Online, CompuServe, or WinFax, that uses the serial port you selected in the Setup dialog box.
- Read the HotSync Log for the user account for which you are performing a HotSync operation.
- Make sure your handheld is seated in the cradle correctly.
- Make sure the gold-plated connectors on the cradle and your handheld are clean. Use a pencil eraser to clean them.

I tried to do a modem HotSync operation, but it did not complete successfully.

Check the following on your computer:

- Make sure your computer is turned on and that it does not shut down automatically as part of an energy-saving feature.
- Make sure the modem connected to your computer is turned on and is connected to the outgoing phone line.
- Make sure Modem is checked in the HotSync Manager menu.
- Make sure the modem you are using with your handheld has an on-off switch. Your handheld cannot “wake up” a modem that has an auto-off feature.
- Make sure the modem is connected properly to a serial port on your computer and is connected to the incoming phone line.
- Confirm that the Setup String in the Setup dialog box configures your modem correctly. You may need to select a different Modem Type or enter a custom Setup String. Most modems have a Setup String that causes them to send initial connection sounds to a speaker. You can use these sounds to check the modem connection.
- Confirm that the Speed setting in the Setup dialog box works for your modem.
- If you have problems using the As Fast As Possible option or a specific speed, try using a slower speed.
- Make sure you are not running another program, such as America Online, CompuServe, or WinFax, that uses the serial port you selected in the Setup dialog box.
- Make sure your modem resets before you try again. (Turn off your modem, wait a minute, then turn it back on.)

I tried to do a modem HotSync operation, but it did not complete successfully.
(continued)

Check the following on your handheld:

- Confirm that the telephone cables are securely attached to your modem.
- Make sure the dialing instruction dials the correct phone number.
- If you need to dial an outside line prefix, make sure you selected the Dial Prefix option on your handheld and entered the correct code.
- If the telephone line you are using has Call Waiting, make sure you selected the Disable call waiting option under Modem Sync Phone Setup on your handheld and entered the correct code.
- Make sure the telephone line you are using is not noisy, which can interrupt communications.
- Check the batteries in your modem and replace them if necessary.

I can't perform an IR HotSync operation.

- Be sure the HotSync Manager is running and the Serial Port for local operations is set to the simulated port for infrared communication.
- On your handheld, be sure the HotSync application is set to Local, with the option IR to a PC/Handheld.
- Be sure the IR port of your handheld is aligned directly opposite to, and within a few inches of, the infrared device of your computer.
- IR HotSync operations do not work after you receive a low battery warning. Check the batteries in your handheld and replace them if necessary.

When I tap the HotSync button on the cradle, nothing happens on Palm Desktop software and my handheld times out.

- Check Palm Desktop software HotSync Setup options to confirm that you have the correct settings for local HotSync operations.
- If you are experiencing intermittent success, try a lower speed setting on the Local tab in the Setup dialog box in the HotSync Manager.
- Close and restart HotSync Manager on your computer.
- Verify there are no COM port conflicts on your computer:
 1. From the Start menu, choose Settings, and then choose Control Panel.
 2. Double-click System.
 3. Click the Device Manager tab.
 4. Double-click Ports.
 5. Make sure each accessory is using a different port.
- Make a copy of your Palm folder. Uninstall, then reinstall Palm Desktop software.
- Turn on your handheld and tap the Applications icon. Tap the HotSync icon, then tap Local.

When I perform a HotSync operation, my information does not transfer to Palm Desktop software.

- If you have performed a HotSync operation successfully, but you cannot find the data from your handheld on Palm Desktop software, check to see you have the correct user name selected for viewing data.
- Click the HotSync Manager and choose Custom. Check that all conduits are set to synchronize files.

My handheld displays the message "Waiting for sender" when it's near my computer's infrared port.

- Your computer's infrared port may be set to search automatically for the presence of other infrared devices. Do the following to turn off this option:
 1. In the Windows taskbar, click Start.
 2. Choose Settings, and then choose Control Panel.
 3. Double-click Infrared.
 4. Click the Options tab.
 5. Deselect the option Search for and provide status for devices in range.
 6. Click Apply and OK.
- If you are using Windows 98, move your handheld away from the computer's infrared port.

I want to synchronize my computer with more than one handheld.

- If the computer running Palm Desktop software synchronizes with more than one handheld, each handheld must have a unique name. Assign a user name to your handheld the first time you perform a HotSync operation.
- Please be aware that synchronizing more than one handheld with the same user name causes unpredictable results and, potentially, loss of your personal information.

Beaming problems

Problem

Solution

I cannot beam data to another Palm OS handheld.

- For best results, Palm VII handhelds should be between ten centimeters (approximately 4") and one meter (approximately 39") apart, and that the path between the two handheld must be clear of obstacles. Beaming distance to other Palm OS handhelds may be different.
- Move your handheld closer to the receiving handheld.
- Perform a soft reset. See "Performing a soft reset" in Appendix A for more information.

When someone beams data to my handheld, I get a message telling me it is out of memory.

- Your handheld requires at least twice the amount of memory available as the data you are receiving. For example, if you are receiving a 30K application, you must have at least 60K free.
- Perform a soft reset. See "Performing a soft reset" in Appendix A for more information.

Password problems

Problem

Solution

I forgot the password, and my handheld is not locked.

You can use Security to delete the password. If you do this, your handheld deletes all entries marked as private. You can, however, perform a HotSync operation *before* you delete the password: the HotSync process backs up all entries, whether or not they are marked private. In this case, the following procedure restores your private entries and lets you access them:

1. Use the Palm Desktop software and the cradle or infrared communication to synchronize your data.
2. Tap Forgotten Password in Security to remove the password and delete all private records.
3. Perform a HotSync operation to synchronize your data and restore the private records by transferring them from your computer to your handheld.

I forgot the password and my handheld is locked.

If you assign a password and lock your handheld, you must perform a hard reset to continue using your handheld. See “Performing a hard reset” in Appendix A for more information.

I forgot the password to my Palm.Net service account.

Visit <http://www.palm.net>, or contact Customer Care. See the *Getting Started* guide for contact information.



Technical support and customer care

If, after reviewing the sources listed at the beginning of this appendix, you cannot solve your problem, contact your regional technical support office by e-mail, phone, or fax. For support e-mail addresses and phone numbers, see the *Getting Started* guide, which comes with your handheld.

Before requesting support, please experiment a bit to reproduce and isolate the problem. When you do contact support, please be ready to provide the following information:

- The name and version of the computer operating system you are using
- The actual error message or state you are experiencing
- The steps you take to reproduce the problem
- The version of handheld software you are using and available memory

To find version and memory information:

1. Tap the Applications icon .
2. Tap the Menu icon .
3. Tap App, and then tap Info.
4. Tap Version to see version numbers, and tap Size to see the amount of free memory, in kilobytes.

Note: Thousands of third-party add-on applications have been written for Palm OS handhelds. Unfortunately, we are not able to support such a large number of third-party applications. *If you are having a problem with a third-party application, please contact the developer or publisher of that software.*

Appendix C

Creating a Custom Expense Report

This section explains how to modify existing Expense application templates and how to create your own custom expense report templates for use with the Expense application.

Note: This section assumes that you are familiar with Microsoft Excel or a similar spreadsheet application. If you are not familiar with Microsoft Excel, consult your company's Information Services department or another experienced user.

About mapping tables

Before creating or modifying an Expense template, it's important to understand the function of the Palm™ Desktop organizer software Expense application. In simple terms, the Expense application is designed to move Expense data from your handheld into a Microsoft Excel spreadsheet.

Each Expense item in your handheld represents a group of related data. You can associate the following data with an expense item:

- Category
- Date
- Expense Type
- Amount
- Payment Method
- Payment Currency
- Vendor
- City
- Attendees
- Note

When you perform a HotSync® operation between your handheld and Palm Desktop software on your computer, the Expense data is stored on your computer (in a file named Expense.txt). When you open the Expense application in Palm Desktop software, an Excel macro starts, and populates an expense template with your data based on the rules specified in a spreadsheet file named Maptable.xls.

The Maptable.xls file is an editable spreadsheet that functions as a "mapping table." The function of the mapping table is to guide the Excel macro in extracting the Expense data. The mapping table tells the Excel macro how large the spreadsheet is and provides the data-cell layout of the Excel template used for the Expense Report.

Customizing existing sample templates

Four sample Expense Report templates come with Palm Desktop software. These templates are stored in the Template folder (which is in the same folder as Palm Desktop software).

If the layout of one (or more) of these templates is appropriate for your reporting needs, you can easily customize the templates with your company name and other information.

To customize a sample Expense Report template:

1. Make a backup copy of the contents of the Template folder.

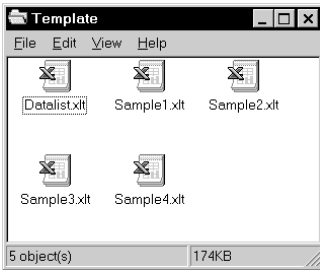

2. Double-click the name of the sample template you want to modify to open it in Microsoft Excel.
3. Make any changes that you want to the names (or other information) in the sample template.

Important: *Do not* insert rows or columns in the sample template. Doing so changes the way your Expense data maps to the template and causes errors. If you want to move the cells to a different location or add or delete rows or columns, you have to make changes to the Mappable.xls file.

Note: You can insert your own company logo without changing the Mappable.xls file. If you change the file name, however, you need to make a corresponding change in the Mappable.xls file.

You can also rename cells without changing the Mappable.xls file, provided that the expense type corresponds to your handheld data. For example, you can change "Snack" to "Munchies," and then all items entered on your handheld as "Snack" map to the cell(s) labeled "Munchies."

4. From the File menu, choose Save As.
5. Click the Save as type drop-down list and choose Template (*.xlt).
6. Navigate to the Template folder (in the Palm Desktop software directory).

Note: If you *do not* need to change the Mappable.xls file, save the template file with its *original file name* (e.g., Sample2.xlt).

If you *do* need to change the Mappable.xls file, give your modified template a unique name. Be sure to use the .xlt file suffix, which defines the file as a Microsoft Excel template.

7. Click Save to save your modified template and make it available for future use.

Note: If you need to modify the Mappable.xls file, you must do this before you can use the modified template with your Expense data. To modify the Mappable.xls file for your new template, see “Programming the mapping table” later in this appendix. *Read all of the sections of this appendix before making changes to the Mappable.xls file.*

Determining the layout of the Expense Report

This section describes the layout considerations for the Expense Report and explains the terms used for creating the report.

Labels

There are two kinds of labels that you need to define for your report: day/date and expense type. Each kind of label can be either Fixed or Variable. A Fixed label means that the label *always* appears as a header at the beginning of a row or column. If a label is not Fixed, it is variable.

For example, a list table of expenses could have variable labels in the rows for day/date, and variable labels in the columns for expense type. In this case, neither day/date or expense type information would be “fixed” (as a header). Instead, the date and expense type information would be filled into the cells of the spreadsheet as appropriate.

Examples of both Fixed and Variable labels appear in the sample expense templates.

Sections

A Section is an area of the report that has common formatting. It is common for an Expense report to have more than one Section. For example, the following sample Expense Report named Sample3.xlt contains several Sections.

File Edit View Insert Format Tools Data Window Help									
1	2	3	4	5	6	7	8	9	10
				Employee			Emp. #	Dept.	Project
Expense Report									
		DATE							
ITINERARY		CITY							
		CITY							
M E A L S									
		Employee paid							
Breakfast		Company paid							
		Employee paid							
Lunch & Snack		Company paid							
		Employee paid							
Dinner		Company paid							
		Employee paid							
Business meals & entertainment		Company paid							
		Employee paid							
Conference		Company paid							
		Employee paid							
M I S C									
Postage		Company paid							
		Employee paid							
Parking & Tolls		Company paid							
		Employee paid							
Gifts, Tips, Suppl		Company paid							
		Employee paid							
Incidentals, Other		Employee paid							
BUSINESS MEALS AND ENTERTAINMENT EXPENDITURES									
Date Expense Type Amount Vendor City									
Date Expense Type Amount Vendor City									
Date Expense Type Amount Vendor City									

Section 1 (not prepaid)

Section 2 (prepaid)

Section 3

Because your Expense data maps to row and column areas of your final report, different Sections require different definitions for the data mapping. To create additional Sections with different mapping, you create corresponding additional lines to the mapping table file named Maptable.xls. This procedure is explained later in this appendix.

If a section contains cells for prepaid (company paid) expenses, you need to create an additional line in the mapping table for “prepaid.” This will count as an additional section in the mapping table. The only data that differs in the prepaid section (from the non-prepaid section) is the row/column numbers for the expense type.

Analyzing your custom Expense Report

If you already have a custom Excel expense report, you can use it with a modified mapping table. However, before you can create a Mappable.xls file that corresponds to your custom Expense Report, you must first analyze the characteristics of your report.

Perform the following before you begin a custom mapping table:

- Print a copy of your custom expense report. Activate the Row and Column Headings option in the Sheet settings of the Page Setup command. This enables you to quickly determine the size of the Section(s), as well as the numbers for the start rows and columns.
- On the printed copy, identify the data Sections. A Section is an area of data with common row and column formatting. A yellow highlighter marking pen can make it easy to see the Sections as you work with programming the mapping table. Your custom Expense Report can contain any number of Sections, and the same data can be repeated in any Section.
- On the printed copy, identify the type of Labels that apply to each Section. Each Section can have only one kind of Fixed or Variable Label for rows. Likewise, each Section can have only one kind of Fixed or Variable Label for columns.
- Place a copy of your custom Expense Report in the Template folder (in the Palm Desktop software directory). Change the file name so it has the file extension .xlt (which defines it as a Microsoft Excel template). Make a note of the exact file name so it can be defined in the mapping table file.

Programming the mapping table

Once you have analyzed the components of your custom Expense Report, you can program the mapping table to fill the report with data from the handheld.

To program a new custom mapping table:

1. Open a copy of the Maptable.xls file in Microsoft Excel.

Note: This file is located in the same folder as the Palm Desktop software application. *Make a backup copy of this file before you make your modifications.*

2. **Mapping a new template.** Scroll to where you find the name of the original template that you chose for your modifications. The name of the template will appear in column B of the Maptable.xls file, next to the cell highlighted in green that reads "Template Name:". If you did not modify an existing template, move to any table in the Maptable.xls file.
3. Select all the *rows* associated with the template name. To select the rows, click and drag on the row numbers (left side), so they appear highlighted.

	1	2	3	4	5
5	Template Name:	SAMPLE1.XLT			
6		ROW			
7		Fixed Label		Variable Label by	
8		Day/Date	Expense Type	Day/Date	Expense Type
9	Section1			X	
10					
11					
12					
13	Template Name:	SAMPLE2.XLT			
14		ROW			
15		Fixed Label		Variable Label by	
16		Day/Date	Expense Type	Day/Date	Expense Type
17	Main		X		
18	Business&Entertainment			X	
19					
20					
21					
22	Template Name:	SAMPLE3.XLT			
23		ROW			
24		Fixed Label		Variable Label by	
25		Day/Date	Expense Type	Day/Date	Expense Type
26	Main (PREPAID)		X		
27	Main		X		

All rows related to template are selected

4. From the Edit menu, choose Copy.

5. Scroll down to a blank area of the Mappable.xls file (below the rows used for Sample4.xls), and click on a row number to select a blank row.
6. From the Edit menu, choose Paste. A copy of the rows you selected in step 3 is pasted into the Mappable.xls file.
7. **Name the table.** In the cell immediately to the right of the cell entitled Template Name, enter the *exact* file name of your custom Expense Report template.
8. **Define the number of Sections.** Each row in a table defines how your handheld data will be placed in a Section of your custom Expense Report. Note that the prepaid portion of a section has its own row and counts as a separate section for map table purposes, *even though it is not a separate section in your template.*

22	Template Name:	SAMPLE3.XLT	
23			ROW
24		Fixed Label	
25		Day/Date	Expense Type
26	Main (PREPAID)		X
27	Main		X
28	Business Meals & Entertainment		
29	Mileage Log		

Table with four sections

You may add or delete rows as necessary so that the total number of rows corresponds to the number of Sections in your custom Expense Report. To clear all of the existing settings in a row, click to select the row and press Ctrl+Delete. Name each row to correspond to a Section of your custom Expense Report.

9. **Determine the Label settings.** The orientation of the data fields (Row, Column) appears in the yellow section of the table.

SAMPLE1.XLT		ROW				COLUMN			
Fixed Label		Variable Label by		Fixed Label		Variable Label by			
Day/Date	Expense Type	Day/Date	Expense Type	Day/Date	Expense Type	Day/Date	Expense Type		
		X					X		

Determine whether the **Rows** will contain expense or date information, and place an “x” in the appropriate cell. When you do this, you also define whether the label is Fixed or Variable. You can place only one “x” in the Row section (columns 2–5).

Determine whether the **Columns** will contain expense or date information, and place an “x” in the appropriate cell. When you do this, you also define whether the label is Fixed or Variable. You can place only one “x” in the Column section (columns 6–9).

10. **Define the dimensions of the Section.** The dimensions of the Section appear in the green columns (10–13).

# of Rows	# of Columns	Start Row	Start Column
36		12	1

of Rows: Represents the total number of rows in the Section, excluding any header or total rows. In other words, this includes only the number of rows in the Section where your handheld data will be placed.

of Columns: Represents the total number of columns in the Section, excluding any header or total columns. In other words, this includes only the number of columns in the Section where your handheld data will be placed.

Start Row: Is the number of the first row of the Section that will be filled with your handheld data.

Start Column: Is the number of the first column of the Section that will be filled with your handheld data.

11. **Define the Dates and Intervals.** The dates and intervals between dates appears in the light blue columns (14–17).

Date	Intervals Between		
Date	Dates	Start day	Day
1	0		

In the **Date** cell, enter the row or column number where all the date information will be placed.

In the **Dates** cell, enter the number of blank columns (or rows) separating the date fields. If there are no blank columns (or rows) between date entries, leave this number set to zero.

In the **Start Day** cell, enter the day of the week that starts the expense reporting period. Enter a three-character abbreviation for the day (e.g., Sun, Mon, Tue).

In the **Day** cell, enter the row or column number where all the day information will be placed. If the dates are in a row, enter the row number. If the dates are in a column, enter the column number.

12. **Define whether the Section is in list format.** This setting appears in the light purple columns (18–19).

Listing Format	Expense Type
YES	8

If the Section will present the data in a list format, enter the word “yes”. Otherwise, enter the word “no”. The following diagram shows data presented in a list format:

6	Date	Category	Type	Amount	Country	Payment Type
7						
8						
9						
10						
11						

Only if your section is in list format: In the Expense Type cell, enter the number of the row or column where the expense description will be placed. Expense amounts can be entered in several different columns or rows if required by your template. *Expense type labels* must all appear in the same column.

13. **Enter the row or column numbers for the expense types that appear in the Section.** These settings appear in the aqua columns (20–48).

Expense Types					
Airfare	Breakfast	Bus	Business Meals	Car Rental	Dinner
4	4	4	4	4	4

For these settings, simply enter the row or column number for the expense types that you want to appear in the Section. Note that the same row or column number can be used more than once. An example of this would be meals that encompass breakfast, lunch, dinner, and snacks. In the previous example, all expense items would be populated into row/column 4 of the custom Expense Report.

14. **Complete the table.** All of the remaining columns (49–57) in the table are used to define the column or row number that corresponds to the description.

15. **Mark a Section for prepaid expenses (yellow column).** If a row in the map table is for prepaid (company paid) expenses, type a “yes” in the cell on that Section’s row. Type “no” in all the cells of this column that do not pertain to prepaid expenses.

57
PrePaid
NO
YES
NO

16. Repeat steps 9 through 15 for each Section that you have defined for your custom Expense Report.
17. **Map Expense Report Options dialog (magenta section).** The Expense Report Options dialog has five fields where you can enter data for the header on your expense report. Use this section to specify the row and column on your template where this information will be mapped.

Employee Name		Department	
Header 1Flow	Header 1Col	Header 2Flow	Header 2Col
2	5	2	9

Because header data is not related to any particular Section, you have to enter data in only one row. If the item does not appear on your template, leave these cells blank.

Using applications other than Microsoft Excel

You can use applications other than Microsoft Excel (such as Lotus 1-2-3 or Quattro Pro) to open and manipulate the Expense data on your computer. The data file is named “Expense.txt,” and is stored in the Expense folder, within the folder containing the handheld user data.

Expense data in the Expense.txt file is in tab-delimited format.

Expense file details

The Expense.txt file contains four groups of data. It will be easier to see these four distinct groups of data if you open the file with a spreadsheet application.

- Trips** Shows the number of Expense application categories, and lists each one followed by an “end” statement.
- Currency** Shows how many currencies were used for the Expense data, and lists the countries that correspond to that currency.
- Trip** Shows the number of expenses by category, and lists the expenses for each category.
- Expenses** Shows the total number of expenses, and lists them chronologically.

Appendix D

Non-ASCII Characters for Login Scripts

The following information enables you to create custom login scripts that require non-ASCII characters. It is provided for advanced users who understand the use and requirements of such characters in a custom login script.

Use of \wedge char

You may use the caret (\wedge) to transmit ASCII command characters. If you send \wedge char, and the ASCII value of char is between @ and _, then the character is automatically translated to a single-byte value between 0 and 31.

For example, \wedge M is converted to a carriage return. If char is a value between a and z, then the character sequence is translated to a single-byte value between 1 and 26. If char is any other value, then the character sequence is not subject to any special processing.

For example, the string "Joe \wedge M" transmits Joe, followed by a carriage return.

Carriage return and line feed

You may include carriage return and line feed commands as part of the login script, when entered in the following format:

- `<cr>` Sends or receives a carriage return
- `<lf>` Sends or receives a line feed

For example, the string "waitfor Joe`<cr><lf>`" waits to receive Joe followed by a carriage return and line feed from the remote computer before executing the next command in the script.

Literal characters

The backslash (\) character defines that the *next character* is transmitted as a literal character, and is not subject to any special processing ordinarily associated with that character.

Examples:

- \^ Includes a caret as part of the string
- \< Includes a < as part of the string
- \\ Includes a backslash as part of the string

Palm.Net™ Service Agreement and Other Product Information

Palm.Net service agreement

NOTICE TO END USER: CAREFULLY READ THE FOLLOWING LEGAL AGREEMENT (“AGREEMENT”). USE OF THE PALM.NET™ WIRELESS COMMUNICATION SERVICE (THE “SERVICE”) CONSTITUTES YOUR ACCEPTANCE OF THESE TERMS. IF YOU DO NOT AGREE TO THE TERMS OF THIS AGREEMENT, DO NOT ACTIVATE THE SERVICE. AS USED IN THIS AGREEMENT “YOU” MEANS BOTH THE INDIVIDUAL ACTIVATING THE SERVICE AND ANY CORPORATION OR OTHER ENTITY RESPONSIBLE FOR THE PAYMENT OF THE CORRESPONDING ACCOUNT. UPON WRITTEN OR ELECTRONIC NOTICE TO YOU, PALM, INC. MAY MODIFY THIS AGREEMENT, MAY MODIFY THE SERVICE RULES OR PRICES, AND MAY DISCONTINUE OR REVISE ANY OR ALL OTHER ASPECTS OF THE SERVICE.

1. General Information, Definitions, and Operating Policies.

1.1 Description. The Service is provided by Palm, Inc. or its subsidiaries, hereinafter referred to as “Palm, Inc.”, through the facilities of a wireless service provider(s) to Palm, Inc. (“Wireless Service Provider”). The “Network” is the method by which a Palm VII™ device connects to the Service. A Venue Host is a third party content provider to the Service. By subscribing to the Service, you have accepted the terms of this Agreement. Further, you agree to use the Service in a manner consistent with any and all applicable laws and regulations. If any information provided by you is incomplete or inaccurate, Palm, Inc. retains the right to terminate your access to the Service.

(a) Palm, Inc. is providing you with access to various types of information through the Service which may include, without limitation, financial information, news, maps and directions (the “Information”) solely for your own use and not for further redistribution. The Information is the property of Palm, Inc. or its Venue Hosts (or other licensors) and is protected by applicable law. Palm, Inc. and its Venue Hosts (or other licensors) reserve any rights not expressly granted herein.

(b) The Information does not include the design or layout of the web pages on which the Information is displayed. Elements of such web pages are protected by trade dress and other laws and may not be copied or retransmitted without the express permission of the web site owner.

(c) Neither Palm, Inc. nor the Venue Hosts assume the responsibility of enforcing licensing requirements, or of checking for licenses, with respect to licensed professions or trades, prior to publishing advertisements. Neither Palm, Inc. nor the Venue Hosts are responsible for the content of any advertising published on the server.

(d) You may obtain information regarding the general availability and reception quality of the Service in a given location within the United States (“Service Rat-

ings”) through the Palm.Net site on the World Wide Web at the URL <http://www.palm.net> (the “Palm.Net Site”) by entering the corresponding U.S. Postal Service zip code in the space provided. You acknowledge and agree, however, that the Service Ratings are merely approximate guidelines, and shall not be considered to be a warranty or representation of Palm, Inc., the Wireless Service Provider or any other third party as to the availability and/or reception quality of a Network connection from any given location at any given time. You acknowledge that neither Palm, Inc., the Wireless Service Provider nor any other third party shall be liable to you if the actual Service in a given location is not available or is not of the same reception quality as any posted Service Rating for such location.

1.2 Accounts. To use the Service, you must have an open, active account that corresponds to your Palm VII device.

1.3 Password Responsibility. Once you subscribe to the Service, you shall receive a password and an account. You are solely and entirely responsible for maintaining the confidentiality of your password. Furthermore, you are solely and entirely responsible for any and all activities which occur under your account. You agree to immediately notify Palm, Inc. of any unauthorized use of your account or any other breach of security known to you. You acknowledge that the complete privacy of your data and messages transmitted while using the Service cannot be guaranteed. For the purposes hereof, “use” means to transfer data over the Network.

1.4 Lost or Stolen Units. You agree to notify Palm, Inc. immediately if your Palm VII device is lost or stolen. If you fail to do so, any charges incurred on your account will be your responsibility.

2. Copyright and Licenses. You acknowledge that no title to the intellectual property in, or transmitted by, the Service is transferred to you. Subject to the terms and conditions of this Agreement, you will have a nonexclusive, nontransferable, nonassignable personal subscription to the Service for the term of this Agreement. The use of any Service software or documentation related thereto is licensed, not sold, to you for use only under the terms of the license contained herein.

3. Interruptions of Service. In the event that the Service is interrupted or you experience some other difficulty with the Service, including any problems or outages with the Network, Palm, Inc. shall use commercially reasonable efforts to try to correct problems with the Service as soon as reasonably possible. You acknowledge and agree that Palm, Inc. is not responsible for performance degradation and delays due to conditions on the Internet or due to the equipment or actions of the Venue Hosts.

4. Charges and Billing Practices.

4.1 Current Rates. You may obtain current rates and surcharges for using the Service via Palm, Inc.’s web site located at <http://www.palm.net> or by calling the Palm.Net Service customer service department at 1-888-756-PALM. In addition, you are responsible for paying any governmental taxes imposed on your use of the Service, including, but not limited to, sales, use or value-added taxes. You are solely responsible for arranging payment for any and all additional or premium charges for your use of any third party services via the Service.

4.2 Payment. To establish an individual, non-corporate accounts, payment must be made by a major credit card accepted by Palm, Inc. (currently, VISA, MasterCard, and American Express). For a corporate account, payment may be made by major credit card or via an approved purchase order. Cash will not be accepted.

4.3 Activation and Changes. Upon each activation of your account, you may be charged an activation fee. If you request any change to your level of service, you agree to pay any additional fees, if applicable, related thereto.

4.4 Billing Information. The billing period ends each month on the monthly anniversary of your activation date. If, however, the billing period would end on the 29th, 30th or 31st day of a month, the Billing Date will be the first day of the following month. You will be billed in advance for the next month's service level charge, and in arrears for any previously unbilled usage. It is possible that Palm, Inc. may (but you agree that it is not obligated to) give you the option to obtain an estimate of the then-current charges incurred by you since your last billing statement through the Palm.Net Site; however, you acknowledge that the amount displayed therein at any given time is only a general estimate of the total amount that will be billed to you in your next billing statement, and agree that additional charges owed by you for your use of the Service (including without limitation taxes, service level change fees, and other charges incurred but not yet billed to your account) may be included in your next monthly bill. If you have elected to pay for the Service by credit card and Palm, Inc. does not receive payment from the card issuer or its agent, you agree to pay all amounts due upon demand by Palm, Inc. Each time you use the Service you agree and reaffirm that Palm, Inc. is authorized to charge your designated credit card. Your card issuer agreement governs your use of your designated card in connection with the Service, and you must refer to that agreement and not this Agreement to determine your rights and liabilities as a cardholder. Further, you agree that Palm, Inc. may delay obtaining authorization from your card issuer until submission of the accumulated charges.

4.5 Late Payment; Discrepancies. If Palm, Inc. does not receive the full amount of your Service account balance within thirty (30) days of the Billing Date, a late payment charge of one and one-half percent (1.5%) per month (or the highest amount allowed by law, whichever is lower) may be added to your bill and immediately become due and payable. Unless you notify Palm, Inc. of any discrepancies within sixty (60) days after they first appear on your account statement, they will be deemed accepted by you for all purposes, including resolution of inquiries made by your card issuer. You release Palm, Inc. from all liabilities and claim of loss resulting from any error or discrepancy that is not reported to Palm, Inc. within sixty (60) days of its first appearance on an invoice or credit card statement.

4.6 Deactivation for Non Payment. You agree to pay Palm, Inc. all reasonable attorney's fees and costs incurred by Palm, Inc. to collect any past due amounts. Your account may be deactivated without further notice if payment is thirty (30) days past due, regardless of the dollar amount. You agree to pay any outstanding balance in full within thirty (30) days of cancellation or termination of your Service account.

4.7 Reservation of Rights. PALM, INC. RESERVES THE RIGHT, AT ANY TIME, TO CHANGE ITS FEES AND BILLING METHODS, INCLUDING THE ADDITION OF SUPPLEMENTAL FEES OR SEPARATE CHARGES FOR CONTENT, OR SERVICES PROVIDED BY PALM, INC., EFFECTIVE THIRTY (30) DAYS AFTER AN ONLINE

POSTING ON THE PALM.NET SITE. PALM, INC. MAY ADDITIONALLY PROVIDE NOTICE OF BILLING CHANGES THROUGH YOUR DESKTOP E-MAIL OR THROUGH THE U.S. MAIL. If any such change is unacceptable to you, you may terminate your subscription to the Service, as provided in Section 5 below. YOUR CONTINUED USE OF THE SERVICE FOLLOWING THE EFFECTIVE DATE OF A CHANGE TO SUCH FEES AND BILLING METHODS SHALL CONSTITUTE YOUR ACCEPTANCE OF SUCH CHANGE.

5. Term; Termination; Effect of Termination.

5.1 Obligations. This Agreement shall be effective as of the date when you activate the Service. This Agreement shall remain in effect until terminated as set forth herein. Palm, Inc. reserves the right, in its sole discretion, to suspend or terminate your access to and use of Service without further notice if you breach any of the terms and conditions of this Agreement. Additionally, either you or Palm, Inc. may terminate this Agreement at any time without cause by sending notice to the other party.

5.2 Responsibilities. Termination of this Agreement shall not relieve you of any obligations to pay accrued charges, including any prorated charges accrued for the billing cycle in which this Agreement is terminated. The payment in advance for the next month's service level is nonrefundable.

5.3 Additional Charges. You will be charged for any additional charges beyond the monthly rates and applicable usage surcharges that have accumulated through the date of termination of your account, and will be billed for such additional amounts on the account's monthly anniversary date.

6. Links to Other Content. Some Service plans enable access through the Network to third-party World Wide Web sites and other resources. Neither Palm, Inc. nor any Venue Host assumes responsibility for the availability or content of these sites and resources. Therefore, any concerns that you may have regarding any site should be directed to the relevant site administrator or webmaster.

7. Availability of Service. The Service will be available in the United States and in the District of Columbia, EXCEPT for Alaska, Guam, Hawaii, the Marshall Islands, Montana, North Dakota, Puerto Rico, South Dakota, Vermont and Wyoming. There will also be areas within the 44 covered states and District of Columbia where the Service is not available. Specific coverage information will be available at the Palm.Net Site. If the Service is not available within your intended location, you agree that your sole remedy shall be to terminate this Agreement.

7.1 Compliance with Laws. You shall not use the Service in any manner contrary to local, state or federal law. Palm, Inc. expressly disclaims any and all responsibility or liability for any action by you that is contrary to such law(s) by you and reserves the right to terminate your Service immediately upon notice for your failure to comply with any such local, state or federal law.

8. Disclaimer of Service Warranties.

8.1 Subscription to Service does not affect the warranty that came with your Palm VII device. No additional warranty is provided as a result of subscribing to the Service. Palm, Inc. SPECIFICALLY DISCLAIMS ANY RESPONSIBILITY FOR ANY EQUIPMENT OR SOFTWARE PROVIDED BY YOU AND IN NO WAY WARRANTS THE CAPABILITIES OF ANY SUCH PROVIDED EQUIPMENT OR SOFTWARE USED IN CONJUNCTION WITH THE SERVICE OR THE PALM VII DEVICE. PALM, INC. FURTHER MAKES NO REPRESENTATIONS OR WARRANTIES THAT THE PALM VII DEVICE OR THE SERVICE WILL ACHIEVE THE MAXIMUM NETWORK ACCESS SPEED SET FORTH IN ANY PALM, INC. DOCUMENTATION.

8.2 YOU EXPRESSLY AGREE THAT USE OF THE SERVICE IS AT YOUR SOLE RISK. THE SERVICE IS PROVIDED ON AN "AS IS" AND AN "AS AVAILABLE" BASIS.

8.3 PALM, INC. AND ITS LICENSORS EXPRESSLY DISCLAIM ALL WARRANTIES OF ANY KIND, WHETHER EXPRESS, IMPLIED OR STATUTORY, INCLUDING, BUT NOT LIMITED TO THE IMPLIED WARRANTIES OF MERCHANTABILITY, FITNESS FOR A PARTICULAR PURPOSE, TITLE AND NON-INFRINGEMENT OF THIRD PARTY RIGHTS.

8.4 PALM, INC. MAKES NO WARRANTY THAT THE SERVICE WILL MEET YOUR REQUIREMENTS, OR THAT THE SERVICE WILL BE UNINTERRUPTED, TIMELY, SECURE, OR ERROR FREE; NOR DO PALM, INC. OR ITS LICENSORS MAKE ANY WARRANTY AS TO THE RESULTS THAT MAY BE OBTAINED FROM THE USE OF THE SERVICE OR AS TO THE ACCURACY, COMPLETENESS OR RELIABILITY OF ANY INFORMATION OBTAINED THROUGH THE SERVICE. PALM, INC. AND/OR ITS LICENSORS MAY MAKE IMPROVEMENTS AND/OR CHANGES IN THE SERVICE AT ANY TIME.

8.5 YOU UNDERSTAND AND AGREE THAT ANY MATERIAL AND/OR DATA DOWNLOADED OR OTHERWISE OBTAINED THROUGH THE USE OF THE SERVICE IS DONE AT YOUR OWN DISCRETION AND RISK AND THAT YOU WILL BE SOLELY RESPONSIBLE FOR ANY DAMAGE TO YOUR PALM VII DEVICE AND/OR YOUR COMPUTER SYSTEM OR LOSS OF DATA THAT RESULTS FROM THE DOWNLOAD OF SUCH MATERIAL AND/OR DATA.

8.6 PALM, INC. MAKES NO WARRANTY REGARDING ANY GOODS OR SERVICES PURCHASED OR OBTAINED THROUGH THE SERVICE OR ANY TRANSACTIONS ENTERED INTO THROUGH THE SERVICE.

8.7 NO ADVICE OR INFORMATION, WHETHER ORAL OR WRITTEN, OBTAINED BY YOU FROM PALM, INC. OR THROUGH THE SERVICE SHALL CREATE ANY WARRANTY NOT EXPRESSLY MADE HEREIN.

8.8 SOME JURISDICTIONS DO NOT ALLOW THE EXCLUSION OF CERTAIN WARRANTIES, SO SOME OF THE ABOVE EXCLUSIONS MAY NOT APPLY TO YOU.

9. Limitation Of Liability For The Service.

9.1 Palm, Inc. shall not be liable for any loss, injury, claim, liability or damage of any kind resulting in any way from (i) your use of the Service, (ii) your use of any equipment in connection with the Service, or (iii) the content of materials included with or accessed via use of the Service, or (iv) any goods or services purchased through the Service. Neither Palm, Inc. nor any Wireless Service Providers shall have any liability of any kind, direct or indirect, to you for any damages other than actual damages directly or proximately resulting from the failure, delay, or nonperformance of the Service. The limitations stated in this Section 9 ("Limitation of Liability") also apply to Venue Hosts and Wireless Service Providers.

9.2 PALM, INC., WIRELESS SERVICE PROVIDERS AND/OR PALM, INC.'S LICENSORS SHALL NOT BE LIABLE FOR ANY DIRECT, INDIRECT, INCIDENTAL, SPECIAL OR CONSEQUENTIAL DAMAGES, WHETHER BASED IN CONTRACT, TORT (INCLUDING NEGLIGENCE), STRICT LIABILITY, OR OTHERWISE, RESULTING FROM THE USE OR THE INABILITY TO USE THE SERVICE, RELATED FACILITIES, EQUIPMENT OR SOFTWARE, EITHER SEPARATELY OR IN COMBINATION WITH ANY OTHER SERVICES, FACILITIES, EQUIPMENT, OR SOFTWARE, WHETHER OR NOT PERFORMED OR PROVIDED UNDER THIS AGREEMENT, OR FOR COST OF PROCUREMENT OF SUBSTITUTE GOODS AND SERVICES OR RESULTING FROM ANY GOODS OR SERVICES PURCHASED OR OBTAINED OR MESSAGES RECEIVED OR TRANSACTIONS ENTERED INTO THROUGH THE SERVICE, OR RESULTING FROM UNAUTHORIZED ACCESS TO OR ALTERATION OF YOUR TRANSMISSIONS OR DATA, INCLUDING BUT NOT LIMITED TO, DAMAGES FOR LOSS OF PROFITS, USE, DATA OR OTHER INTANGIBLE, EVEN IF PALM, INC., WIRELESS SERVICE PROVIDERS AND/OR PALM, INC.'S LICENSORS HAVE BEEN ADVISED OF THE POSSIBILITY OF SUCH DAMAGES.

9.3 NOTWITHSTANDING ANY OTHER PROVISION OF THIS AGREEMENT, THE MAXIMUM LIABILITY OF PALM, INC. FOR DAMAGES HEREUNDER SHALL NOT EXCEED \$100.00 AND THE MAXIMUM COLLECTIVE LIABILITY OF PALM, INC. AND WIRELESS SERVICE PROVIDERS FOR ACTUAL DAMAGES DIRECTLY AND PROXIMATELY RESULTING FROM THE FAILURE, DELAY, OR NONPERFORMANCE OF THE SERVICE HEREUNDER SHALL BE LIMITED SOLELY TO THE AMOUNT PAID BY YOU TO PALM, INC. FOR THE SERVICE DURING SUCH PERIOD OF FAILURE, DELAY, OR NONPERFORMANCE.

9.4 SOME JURISDICTIONS DO NOT ALLOW THE LIMITATION OR EXCLUSION OF LIABILITY FOR INCIDENTAL OR CONSEQUENTIAL DAMAGES SO SOME OF THE ABOVE LIMITATIONS MAY NOT APPLY TO YOU.

10. Third Party Rights. The provisions of this Agreement are for the benefit of Palm, Inc., Venue Hosts, and their respective licensors. Each of these individuals or entities shall have the right to assert and enforce this Agreement on its own behalf.

11. Messaging Service Terms and Conditions.

11.1 Rules of Use. If you elect to use the Wireless Internet Messaging Service (the "Messaging Service"), you hereby agree to comply with the additional terms and conditions set forth in this Section 11 ("Messaging Terms and Conditions"). You further agree that this Agreement applies with equal force and effect to your use of the Messaging Service.

(a) You are solely responsible for the contents of your transmissions through the Messaging Service. Your use of the Messaging Service is subject to all applicable local, state, national and international laws and regulations.

(b) You agree: (1) to comply with US law regarding the transmission of technical data exported from the United States through the Messaging Service; (2) not to use the Messaging Service for unlawful or wrongful purposes, including, but not limited to, distributing material that (i) is copyrighted (except to the extent expressly permitted by the copyright owner), (ii) is obscene, libelous, harassing or discriminatory, (iii) is protected by trade secret, (iv) is an invasion of the privacy of a third party; (v) creates a clear and present danger, or (vi) advocates unlawful conduct; (3) not to interfere or disrupt networks connected to the Messaging Service; and (4) to comply with all regulations, policies and procedures of networks connected to the Messaging Service.

(c) You agree not to use the Messaging Service for chain letters, junk mail, spamming or any use of distribution lists to any person who has not given specific permission to be included in such a process.

11.2 Modifications To Messaging Service. Palm, Inc. reserves the right to modify or discontinue the Messaging Service with or without notice. Palm, Inc. shall not be liable to you or any third party should Palm, Inc. exercise its right to modify or discontinue the Messaging Service. You agree that Palm, Inc. has no obligation to monitor or regulate the transmissions sent by you. Palm, Inc. will endeavor to keep your messages private, viewable only by you and the person to whom you address it. However, systems operators may need to look at your messages if Palm, Inc. believes it is necessary to protect itself or others from injury or damage; for example, if Palm, Inc. has reason to believe you are involved in illegal activities which could lead the authorities to seize or search its system. Palm, Inc. reserves the right to the appropriate action if it becomes aware of any use of the Messaging Service which Palm, Inc. believes violates any law or is otherwise wrongful, including immediately terminating your access to the Messaging Service, but Palm, Inc. will not monitor messages unless it believes the Messaging Service is being misused.

11.3 No Resale Or Commercial Use Of The Service. Your right to use the Messaging Service is personal to you. You agree not to resell the use of the Messaging Service, without the express written consent of Palm, Inc.

11.4 Indemnification. Since you are responsible for your transmissions and their consequences, you agree to indemnify and hold Palm, Inc., its parents, subsidiaries, affiliates, officers and employees, harmless from and against any claim or demand, including reasonable attorneys' fees, made by any third party resulting from or arising out of your use of the Messaging Service (or the Messaging Service by persons using your password), your violation of this Agreement, or the infringement by you, or other user of the Messaging Service using your computer or password, of any intellectual property or other right of any person or entity.

12. General.

12.1 Entire Agreement. This Agreement is intended as the complete, final and exclusive statement of the terms of the agreement between the parties relating to the subject matter hereof and supersede all prior understandings, writings, proposals, representations or communications, oral or written, relating to the subject matter hereof. Palm, Inc. may make changes to this Agreement by notifying you in accordance with Section 12.3. No change requested by you shall be binding upon Palm, Inc. unless agreed to in writing executed by both parties.

12.2 Force Majeure. Except with respect to your payment obligations under this Agreement, neither party shall be liable to the other party for any alleged loss or damages resulting from delays in performance caused by acts of the other party, acts of civil or military authority, governmental priorities, earthquake, fire flood, epidemic, quarantine, energy crisis, strike, labor trouble, war, riot, accident, shortage, delay in transportation, or any other causes beyond the reasonable control of the party whose performance is so delayed.

12.3 Notices. You may send notices to Palm, Inc. by postal mail or by express delivery, addressed to Palm, Inc. at 5400 Bayfront Plaza, Santa Clara, CA 95052-8145, Attention: Palm VII Customer Care or at such other address as Palm, Inc. may provide. Palm, Inc. may send notices to you electronically by facsimile, desktop e-mail, or by postal mail, addressed to you at your last known address or number. All notices shall be deemed to have been given and received on the earlier of actual delivery or three (3) days from the date of postmark.

12.4 Waiver. A waiver of any default hereunder or of any of the terms and conditions of this Agreement shall not be deemed to be a continuing waiver or a waiver of any other default or of any other term or condition, but shall apply solely to the instance to which such waiver is directed. The exercise of any right or remedy provided in this Agreement shall be without prejudice to the right to exercise any other right or remedy provided by law or equity.

12.5 Severability. In the event any provisions of this Agreement are found to be invalid, illegal or unenforceable, the validity, legality and enforceability of any of the remaining provisions shall not in any way be affected or impaired thereby.

12.6 Assignment. Assignment of this Agreement shall be prohibited without the express written consent of the other party; except that Palm, Inc. shall be entitled to assign its rights and obligations hereunder to any subsidiary or affiliate or in connection with a merger or other business combination in which Palm, Inc. is not the surviving entity. Any attempted assignment in violation of this provision shall be null and void.

12.7 Governing Law. THE VALIDITY, PERFORMANCE, CONSTRUCTION, AND INTERPRETATION OF THIS AGREEMENT SHALL BE GOVERNED BY THE LAWS OF THE STATE OF CALIFORNIA, EXCLUDING CONFLICTS OF LAWS PRINCIPLES. The Superior Court of Santa Clara County and/or the United States District Court for the Northern District of California shall have jurisdiction and venue over all controversies in connection herewith.

12.8 **Arbitration.** All disputes, claims, and controversies between the parties arising out of or related to this Agreement or the breach thereof (except for non-payment or late payment; and breach of any obligation of confidentiality or infringement of any intellectual property right for which an injunction may be sought) shall be settled by arbitration. The arbitration shall be conducted by one arbitrator under the then current Commercial Arbitration Rules of the American Arbitration Association. The power of the arbitrator shall be limited to that possessed by a Superior Court Judge in California. The arbitrator is prohibited from awarding damages or remedies in excess of those allowed by the provisions of this Agreement. The decision and award of the arbitrator shall be final and binding and judgment on the award so rendered may be entered in any court having jurisdiction thereof. The arbitration shall be held in Santa Clara County, California, or a mutually convenient location, and the award shall be deemed to be made in California.

12.9 **Survival.** Sections 4 (“Charges and Billing Practices”), 5.3 (“Additional Charges”), 8 (“Disclaimer of Service Warranties”), 9 (“Limitation Of Liability For The Service”), 11.4 (“Indemnification”), and 12 (“General”) shall survive the expiration or termination of this Agreement.

Product regulatory information

FCC Statement

This device complies with part 15 of the FCC rules. Operation is subject to the following two conditions: (1) This device may not cause harmful interference, and (2) this device must accept any interference received, including interference that may cause undesired operation.

Note: This equipment has been tested and found to comply with the limits for a Class B digital device, pursuant to Part 15 of the FCC rules. These limits are designed to provide reasonable protection against harmful interference in a residential installation. This equipment generates, uses, and can radiate radio frequency energy and, if not installed and used in accordance with the instructions, may cause harmful interference to radio communications. However, there is no guarantee that interference will not occur in a particular installation. If this equipment does cause harmful interference to radio or television reception, which can be determined by turning the equipment off and on, the user is encouraged to try to correct the interference by one or more of the following measures:

- Reorient or relocate the receiving antenna.
- Increase the separation between the equipment and receiver.
- Connect the equipment into an outlet on a circuit different from that to which the receiver is connected.
- Consult the dealer or an experienced radio/TV technician for help.

The use of shielded I/O cables is required when connecting this equipment to any and all optional peripheral or host devices. Failure to do so may violate FCC rules.

Caution: Changes or modifications not covered in this manual must be approved in writing by the manufacturer's Regulatory Engineering Department. Changes or modifications made without written approval may void the user's authority to operate this equipment.

Responsible Party:

Palm, Inc.
5400 Bayfront Plaza
PO Box 58007
Santa Clara, California 95052-8007
United States of America
(408) 326-5000

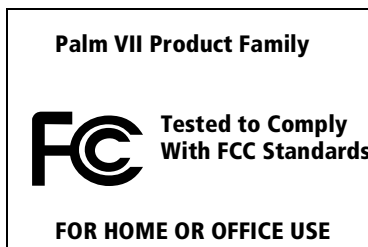

Battery Warning

Do not mutilate, puncture, or dispose of batteries in fire. The batteries can burst or explode, releasing hazardous chemicals. Discard used batteries according to the manufacturer's instructions and in accordance with your local regulations.

Varning

Eksplotionsfara vid felaktigt batteritype. Använd samma batterityp eller en ekvivalent typ som rekommenderas av apparattillverkaren. Kassera använt batteri enligt fabrikan- tens instruktion.

Advarsel!

Lithiumbatteri—Eksplotionsfare ved fejlagtig håndtering. Udskiftning må kun ske med batteri af samme fabrikat og type. Levér det brugte batteri tilbage tilleverandøren.

Varoitus

Paristo voi räjähtää, jos se on virheellisesti asennettu. Vaihda paristo ainoastaan valmistajan suosittelemaan tyyppiin. Hävitä käytetty paristo valmistajan ohjeiden mukaisesti.

Advarsel

Ekspløsjonsfare ved feilaktig skifte av batteri. Benytt samme batteritype eller en tilsvarende type anbefalt av apparatfabrikanten. Brukte batterier kasseres i henhold til fabrikan- tens instruksjoner.

Waarschuwing!

Bij dit produkt zijn batterijen geleverd. Wanneer deze leeg zijn, moet u ze niet wegge- oien maar inleveren als KCA.

Uwaga

Nie kroić lub przekłuwać baterii, ani nie wrzucać ich do ognia. Mogą się rozerwać lub wybuchnąć wydzielając trujące środki chemiczne. Zużytych baterii należy pozbywać się w sposób opisany przez producenta i zgodnie z miejscowymi przepisami.

Nowe baterie powinny być tego samego lub analogicznego typu, co baterie zalecane w instrukcji obsługi kieszonkowego komputera Philips. Regeneracyjne baterie litowe mogą wybuchnąć jeżeli nie są odpowiednio umieszczone w komputerze.

אזהרה

יש סכנת התפוצצות אם מחליפים את הסוללה בצורה לא נכונה.
יש להחליף את הסוללה בסוללה זהה או דומה, בהתאם להמלצת היצרן.
יש להשליך סוללות משומשות בהתאם להוראות היצרן

Index

A

AAA batteries. *See* Batteries

ABA (Address Book archive file) 41

Accented characters

 Graffiti writing 38

 onscreen keyboard 40

Account on Palm.Net service 126

Activating the Palm.Net service 14,
125

Add-on applications 46–49, 244

Address Book

 If Found Call entry 96

 adding custom fields 99

 archive files (.aba) 41

 business card for beaming 185

 categorizing records 68

 conduit for synchronizing 191

 creating records 61, 95–96

 deleting records 63

 displaying category 99

 displaying data in the Address
 list 98

 duplicating records 98

 finding records 71–72

 fonts 79

 menus 98

 notes for records 78–79

 opening 57

 overview 57

 pressing button to beam
 information 187

 private records 78

 sorting records 75

Address on Palm.Net network 124

Agenda (Date Book view) 92

Airline regulations on use of wireless
devices 121

Alarm

 preset 94

 setting 85

 sound 94, 215, 249

 for untimed events 86

Alphabet

 Graffiti writing 34

 onscreen keyboard 18, 24

Antenna

 best positions 6, 129, 251

 location 5

 pen stroke to open

 application 211

 proper use 121, 241

 replacing 241–242

Application buttons 6, 19

 for beaming 187

 for cycling through views 56, 57,
58, 59

 reassigning 210

Applications

 Address Book 57

 beaming 185–186

 Calculator 59

 categories 43–44

 Date Book 56

 Expense 60

 font style 80

 iMessenger 137

 installing 46–49

 Memo Pad 59

 opening 20

 plug-in 230

 preferences for 45

 problems with 252

 removing 49

 security 50

 size in kilobytes 261

 third-party 261

 To Do List 58

 version of 261

 viewing as icons 44

 viewing as list 44

 web clipping applications 129

See also Add-on applications

Applications Launcher 19–20, 43–45

Archive files

 importing data from 41

 for main applications 41

 saving deleted records 63

 saving purged records 64

Arrows 19

Attachments
 iMessenger application 145, 157
 Mail 179
Automatic fill, in Expense 120
Auto-off delay 214
Autotext. *See* Graffiti ShortCuts

B

Backlight 5, 211
Bar graph showing signal strength 128
Batteries
 backup power when removed 238
 battery door 7, 9
 battery life 238
 conserving power 214
 gauge 20
 installing 9, 10
 See also Transmitter
Battery
 warning 286–287
BCC (blind carbon copy) 158, 170
Beaming
 See also Infrared
Beaming information 185–187
 categories 186
 location of IR port 5
 pen stroke to activate 212
 problems with 259
Billing 126, 131, 279
Bold font for text 79
Brightness control 7
Business card for beaming 185
Buttons preferences 210

C

Calculator
 buttons explained 108
 memory 108
 opening 60
 overview 59
 recent calculations 60, 108
Calibration 17, 213, 250
Call Waiting, disabling 201, 222

Calling card, using in phone settings 201, 223
Capital letters (Graffiti writing) 35
Caring for the handheld 237
Categories
 application 43–44
 assigning records to 67–68
 beaming 185–186
 creating 69–70
 default 67
 displaying 68, 99, 252
 folders for e-mail 176
 folders for iMessenger messages 155
 merging 71
 renaming 70
 using in Applications Launcher 44
cc:Mail 162
Certicom 126
Chain calculations 108
Characters, Graffiti 31
Charging the transmitter 10
Check boxes 18
Check marks to mark read items
 e-mail (Mail) 164
 messages (iMessenger application) 139
Clearing Calculator entries 108
Clippings
 response to query 129
 reviewing 132–135
 saving information from 135–136
 size of 134
COM port 194, 195
COM port. *See* Serial port
Combining categories 71
Comma delimited files, importing data from 41
Command
 buttons 18, 126, 131
 equivalents (Graffiti writing) 23
 toolbar 23
Compressing Day view 94
Computer keyboard, entering data with 26

Conduits
for connecting to PIMs 14
for modem HotSync
operations 201
for synchronizing
applications 253, 191–192,
244–245

Confirming e-mail 172

Conflicting events 91

Connecting
to Internet 129, 138
service templates 224
to server or ISP 223

Connection
preferences 218
selecting for network 220

Continuous events
deleting from Date Book 63
scheduling 86

Contrast control 7

Copy Page command in web clipping
applications 135

Copying text 62

Country default setting 213

Coverage of Palm.Net service 125,
126

Cradle
connecting to serial port 8
for local HotSync operations 66,
197

Creating
Address Book entries 95–96
categories 43–44, 69–70
currency symbols 113
custom fields in Address
Book 99
Date Book events 81
e-mail in Mail 165–167
Expense items 110
expense reports in Excel 116–119
memos 105
messages in iMessenger
application 145–147
notes for records 78
queries to submit to
Internet 130–131
records 61

To Do List items 100

Currency
default 113
defining 113
for Expense items 112

Current date 29, 252

Current time 20
displaying in Date Book 89
setting 28

Custom currencies and symbols 113

Custom expense reports 263–273

Custom fields in Address Book 99

Customer support 125, 127, 247, 261

Customizing. *See* Preferences

Cutting text 62

Cycling through views 56, 57, 58, 59

D

Data entry. *See* Entering data

Date Book
adding Address Book data to
records 73–74
Agenda view 92
alarm 85
archive files (.dba) 41
changing event time 85
changing event to untimed 84
conduit for synchronizing 191
conflicting events 91
continuous events 86–88
creating records 61, 81–85
Day view 89
deleting records 63
display options 93
end time for Day view 94
fonts 79
menus 93
Month view 91
notes for records 78–79
opening 56
overview 56
private records 78
purging records 64
repeating events 63, 86–88
scheduling events 81–85
selecting dates 83
start time for Day view 94

- Sunday or Monday to start week 214
 - switching views 89
 - untimed events 81, 84
 - Week view 89, 214, 252
 - Dates
 - Expense item 111
 - setting current 29, 252
 - showing in iMessenger list 156
 - showing in Mail list 177
 - To Do List record due 102
 - Day (Date Book view) 81, 94
 - DBA (Date Book archive file) 41
 - Decimal point 214
 - Default
 - categories 67
 - currency in Expense 113
 - proxy server 235
 - settings. *See* Preferences
 - Deleted
 - data, saving in archive files 63
 - e-mail, recovering 175
 - iMessenger messages, recovering 155
 - Deleting
 - applications 46, 49
 - Desktop software 50
 - e-mail 175
 - Graffiti characters 33
 - iMessenger messages 154
 - iMessenger messages from network 158
 - passwords 51
 - records 63
 - service templates 230
 - text 62
 - See also* Purging records
 - Delivering
 - e-mail (Mail) 169, 172
 - messages (iMessenger application) 151
 - Desktop E-Mail application
 - applications supported 162
 - managing 161–184
 - support of Mail features 169
 - Desktop software 12–13
 - configuring mail 162–164
 - displaying euro 115
 - for entering data 26
 - linking to external files 206
 - removing 50
 - saving deleted data to an archive file 63
 - system requirements 4
 - upgrading 10
 - See also* PIM
 - Diagnostics application
 - monitoring signal strength 128, 251
 - monitoring transmitter charge 239
 - Digitizer 17, 213, 250
 - Distribution lists in iMessenger application 144
 - DNS (Domain Naming System) 226
 - Double-booked events 91
 - Downloading iMessenger messages 139–145
 - Drafts
 - in iMessenger application 153
 - in Mail 174
 - Dragging
 - memos into other applications 59
 - stylus to activate features 211
 - using the stylus 17
 - Driver for infrared communication on Windows 95 194
 - Duplicating addresses 98
- ## E
- Editing
 - records 61–63
 - unsent e-mail (Mail) 173
 - unsent messages (iMessenger application) 152
 - Elliptic curve cryptography 126
 - E-mail addresses
 - in Address Book 97, 98
 - looking up (iMessenger application) 148–149
 - looking up (Mail) 168–169
 - E-mail items. *See* Mail
 - Encryption 126

- Entering data 24–27
 - importing from other applications 41–42
 - problems with 250
 - using Graffiti writing 31–40
 - using the computer keyboard 41
 - using the onscreen keyboard 40
- Entries. *See* Address Book
- Eudora 162
- Euro
 - displaying on desktop computer 115
 - in Expense 113
 - printing 116
 - problems with 252
- Events. *See* Date Book
- Excel, transferring Expense data to 115–119
- Exchange 162
- Exchanging data. *See* HotSync
- Exclamation marks in To Do List 103
- Expense
 - adding Address Book data to records 74–75
 - categorizing records 68
 - conduit for synchronizing 191
 - creating records 61, 110
 - currency 112
 - date of item 111
 - defining new currency 113
 - deleting records 63, 87
 - menus 119
 - notes for records 78–79
 - opening 60
 - overview 60
 - purging records 64
 - receipt details 111
 - reports in Excel 116–119, 263–273
 - sorting records 75
 - templates for reports 117
 - type 112, 120
 - vendor 112
- External keyboard 27
- F**
- FAQ 247–261
- FCC Statement 285
- Federal Aviation Administration (FAA) guidelines on using wireless devices 121
- Files, linking to external 206
- Filing
 - e-mail (Mail) 175
 - messages (iMessenger application) 154
- Filters for e-mail 179–182
- Finding
 - applications, using Graffiti writing 20
 - e-mail addresses (iMessenger application) 148–149
 - e-mail addresses (Mail) 168–169
 - information in
 - applications 71–75
 - phone numbers 73–74
 - using the Find application 72
- Folders
 - for e-mail (Mail) 176
 - for messages (iMessenger application) 155
- Fonts 79, 80, 115
- Formats preferences 213
- Frequently asked questions 247–261
- Frozen handheld 249
- G**
- Games 48, 215
- General preferences
 - alarm sounds 215
 - auto-off delay 214
 - system sounds 215
- Getting more of truncated messages 142–143
- Glossary. *See* Graffiti ShortCuts
- Graffiti
 - accented characters 38
 - alphabet 31, 34
 - basic concepts 31
 - capital letters 35
 - Command stroke 23, 150
 - defined 25
 - Giraffe game for practicing 49
 - how to write characters 32

- menu commands 23
- moving the cursor 39
- numbers 35
- online Help 63, 211
- problems using 250
- punctuation marks 36
- ShortCuts for entering data 39, 233–234
- symbols 37
- tips 33
- writing 31–40
- writing area 6, 32

H

Handheld

- interface elements 18
- locking 52
- problems with 247–261
- setting up 10
- turning on and off 5
- unique name 12

Hard reset 244

- effect on iMessenger application 158
- after upgrading 12

Header information

- in iMessenger application 143, 146
- in Mail 165, 167

Help

- Graffiti 63
- online Tips 24

Hiding records 76

High Priority e-mail filter 182

History, list of clippings 134

HotSync

- buttons preferences 212
- conduits for synchronizing applications 191–192, 244–245
- customizing 191
- defined 65
- first-time operation 65–67, 207–208
- for managing desktop E-Mail 163–164
- HotSync Manager 65

- and iMessenger application 158
- IR operation 193–198
- linking to external files 206
- local operation 66, 190, 254
- Manager 194, 196
- modem operation 191, 198–202, 255–256
- modem settings 199
- network operation 203–206
- operations using cradle 197, 216
- operations using IR port 196–197, 217–218
- options for filtering e-mail 178–182
- problems with 253–258
- problems with IR 256
- before replacing batteries 238
- setting options 189–191
- for synchronizing data 12
- using with another PIM 50

I

Icons

- alarm 85
- application 18, 44
- in iMessenger application 139, 159
- note 79
- online Tips 24
- onscreen 250
- over-the-air 131
- repeating event 87
- security (for wireless transactions) 126
- for web clipping applications 129

- Idle timeout of ISP or server connection 225

- Ignoring e-mail. *See* Filters for e-mail iMessenger application

- address 124, 234
- address lookup 148–149
- attachments 145
- canceling transactions 140
- checking for messages 139–140
- closing messages 140
- copy of outgoing messages 158

- creating messages 145–147
 - deleting messages 154, 158
 - different from Mail 137
 - draft messages 153
 - editing unsent messages 152
 - filing messages 154
 - folders 155
 - fonts 79
 - forwarding address 158
 - icons in 139
 - log of wireless transaction 140
 - long messages 141–143
 - mailbox on network 157
 - menus 159
 - opening messages 140–145
 - opening upon raising
 - antenna 211
 - overview 16, 124, 137
 - purging deleted messages 155
 - recovering deleted messages 155
 - replying to messages 147
 - rerouting replies 149
 - sending messages 145–147, 151
 - short messages 141
 - showing dates 156
 - signature 150
 - sorting messages 157
 - synchronizing after hard
 - reset 158
 - undeliverable messages 157
 - viewing messages 139–145
 - Importing data 27, 41–42
 - Inbox
 - iMessenger application 156
 - Mail 177
 - information 186
 - Infrared
 - connections 216
 - HotSync operations 196–197, 217–218
 - installing Windows 95
 - driver 194
 - port 193, 195
 - problems with IR HotSync
 - operations 256
 - requirements for computer 193
 - Infrared port. *See* IR port
 - Installing
 - applications 46–49
 - batteries 9
 - conduit to install
 - applications 191
 - Desktop software 13, 248
 - Mail. *See* Mail, desktop
 - configuration
 - InSync Online 127
 - Interface elements 18
 - International characters
 - Graffiti writing 38
 - onscreen keyboard 40
 - Internet. *See* iMessenger application
 - and Web clipping applications
 - IP address
 - for Network preferences 226
 - for Palm.Net proxy server 234
 - for service template 224
 - IR port 5
 - See also* Beaming information
 - IR. *See* Infrared
 - IrCOMM 193, 216
 - IrDA (Infrared Data Association) 193
 - Items. *See* To Do List *or* Expense
- ## K
- Keyboard
 - computer 41
 - onscreen 18, 40, 211
 - Kilobytes (KB) 131, 134, 135
 - kinds 16
- ## L
- Letters
 - font style 80
 - Graffiti 31, 34
 - onscreen keyboard 40
 - List, in Applications Launcher 44
 - Locking the handheld with a
 - password 52, 212, 232
 - Log of iMessenger transactions 140
 - Login scripts 227–230, 275
 - Looking up Address Book data
 - to add to other records 73–74
 - scrolling in Address list 71

- to add to e-mail (Mail) 168–169
- to add to messages (iMessenger application) 148
- Lost handheld, contact for 96
- Lost records 252
- Lotus
 - 1-2-3, for expense reports 272
 - cc:Mail 162
 - Organizer, importing data from 41

M

- Macintosh 115, 193, 227
- Macintosh compatibility 4, 159
- Mail
 - address lookup 168–169
 - attachments 179
 - BCC (blind carbon copy) 169, 170
 - changing setup 164
 - closing e-mail 165
 - confirm delivery 169, 172
 - confirm read 169, 172
 - creating e-mail 165–167
 - deleting e-mail 175
 - desktop configuration 162–164
 - different from iMessenger application 137
 - draft e-mail 174
 - editing unsent e-mail 173
 - filing e-mail 175
 - filtering options 178–182
 - folders 176
 - fonts 79
 - HotSync options 163–164
 - menus 183
 - opening e-mail 164
 - overview 161–162
 - priority of delivery 169, 170
 - purging deleted e-mail 176
 - recovering deleted e-mail 175
 - replying to e-mail 167
 - sending 172
 - showing dates 177
 - signature 169, 171–172
 - sorting e-mail 177
 - synchronizing 164

- truncating e-mail 183
- viewing e-mail 164
- Mailbox on Palm.Net network 157
- Main applications 19
- Maintenance information 237
- MapQuest 123
- Maps of Palm.Net coverage 126
- Masking records 76
- Memo Pad
 - adding Address Book data to records 73–74
 - archive files (.mpa) 41
 - categorizing records 67
 - conduit for synchronizing 191
 - creating records 61, 105
 - deleting records 63, 87
 - dragging memos into other applications 59
 - fonts 79
 - menus 106, 109
 - opening 59
 - overview 59
 - private records 78
 - reviewing memos 105
 - sorting records 75, 252
- Memory
 - amount of free 261
 - for beaming 259
 - Calculator 108
 - regaining 64, 249
- Memos. *See* Memo Pad
- Menus 22–23, 250
 - Address Book 98
 - choosing 22
 - command equivalents (Graffiti writing) 23
 - command toolbar 23
 - Date Book 93
 - Edit menu 62–63
 - Expense 119
 - iMessenger application 159
 - Mail 183
 - Memo Pad 106, 109
 - menu bar 18, 22
 - Network Preferences 230
 - pop-up (iMessenger application) 159

- To Do List 104
 - web clipping applications 136
- Messages. *See* iMessenger application
- Microsoft
 - Excel, transferring Expense data to 115–119
 - Exchange 162
 - Outlook, connecting to 14, 162, 253
 - Windows 95, 98 193
 - Windows Messaging 4.0 162
- Modem
 - connections 216
 - HotSync operations via 198–202, 255–256
 - setup after upgrade 11
- Monday, to start week 214
- Month (Date Book view) 91, 94
- Moving the cursor (Graffiti writing) 39
- MPA (Memo Pad archive file) 41

N

- Network
 - connecting 224
 - connection type 225
 - HotSync operation 203–206
 - idle timeout 225
 - login scripts 227–230
 - Palm.Net service 125
 - password 220
 - phone settings 221
 - preferences 218–232
 - primary DNS 226
 - secondary DNS 226
 - selecting connection 220
 - selecting service 219
 - TCP/IP 218
 - user name 219
- NiCad (nickel-cadmium)
 - battery 239–240
- Notes, attaching to records 78–79
- Numbers
 - decimal point and thousands separator 214
 - Graffiti writing 35
 - onscreen keyboard 18, 24, 40

O

- 1-2-3, for expense reports 272
- Onscreen keyboard 24, 40, 63
 - pen stroke to open 211
- Opening
 - Address Book 57
 - applications 19–20
 - Calculator 60
 - Date Book 56
 - Expense 60
 - iMessenger application 138
 - Mail 164
 - Memo Pad 59
 - To Do List 58
 - web clipping
 - applications 129–130
- Organizer (Lotus PIM) 41
- Outbox
 - iMessenger application 151, 156
 - Mail 172, 177
- Outlook, connecting to 14, 162, 253
- Overlapping events 91
- Owner preferences 232

P

- Palm Desktop software. *See* Desktop software
- Palm.Net service
 - account status 126
 - activating 14
 - mailbox on 157
 - maps of coverage 126
 - network 125
 - overview 14, 124
 - password 15
 - protection of wireless transactions 125
 - service agreement 277
 - signal strength 127
 - support information 127
 - username 15
 - web clipping application 127
 - web site 126
- Passwords 50–53
 - changing 51
 - creating 51

- deleting 51
 - for network 220
 - forgotten 53, 260
 - for Palm.Net service 15, 251
 - Pasting text 62
 - Payment, Expense item 112
 - PDB (add-on application file extension) 47
 - Pen stroke, full-screen 211–212
 - Personal information managers. *See* PIM
 - Phone Lookup 73–74
 - Phone numbers
 - selecting for Address list 98
 - selecting types 97
 - Phone settings for ISP or dial-in server 221–223
 - Pick lists 18, 130
 - PIM (personal information manager)
 - in upgrading process 10
 - using HotSync Manager with 50
 - using with handheld 14
 - Plug-in applications 230
 - Pop-up menus (iMessenger application) 159
 - Ports
 - IR on handheld 193
 - simulated for infrared communication 195
 - Power button 5
 - PPP 224
 - PQA (web clipping application file extension) 47
 - PRC (add-on application file extension) 47
 - PRC (application file extension) 230
 - Preferences 28
 - Buttons 210
 - choosing 45
 - Connection 218
 - Digitizer 213
 - Formats 213
 - General 214
 - HotSync buttons 212
 - Network 218–232
 - Owner 232
 - ShortCuts 233
 - Wireless 234
 - Primary DNS 226
 - Printing
 - expense reports from
 - Excel 116–119
 - records from applications 12
 - Prioritizing To Do List records 100, 103
 - Priority of delivery (Mail) 170
 - Private records
 - displaying and creating 76–78, 252
 - lost with forgotten password 53
 - See also* Security
 - Problems with handheld 247–261
 - Profiles 207
 - Proxy server for Palm.Net service 234
 - Punctuation marks
 - Graffiti writing 36
 - onscreen keyboard 40
 - Purging
 - deleted e-mail (Mail) 176
 - deleted messages (iMessenger application) 155
 - records 64
 - See also* Deleting
- ## Q
- QUALCOMM 162
 - Quattro Pro, for expense reports 272
- ## R
- Radio signal 121, 127, 251
 - Range of times in Day view 94
 - Reading e-mail on handheld 164
 - Receipts, recording in Expense 111
 - Receiving data. *See* Beaming information
 - Reception 127, 251
 - Recharging the transmitter 239
 - Records
 - Address Book 95
 - beaming 185–186
 - choosing categories 67
 - copying address 98
 - creating 61

- Date Book 81
 - defined 61
 - deleting 63, 87
 - displaying a category of 68
 - duplicating address 98
 - editing 61–63
 - Expense 110
 - fonts 79
 - hiding private 50, 76
 - lost 252
 - masking private 50, 76
 - Memo Pad 105
 - notes for 78–79
 - number of 261
 - private 76–78
 - purging 64
 - sorting 75–76
 - To Do List 100
 - Recovering
 - deleted e-mail (Mail) 175
 - deleted messages (iMessenger application) 155
 - filed e-mail (Mail) 175
 - filed messages (iMessenger application) 154
 - Recycling NiCad battery 240
 - Removing
 - applications 49
 - Desktop software 50
 - Renaming categories 70
 - Repeating events
 - changing 87–88
 - deleting from Date Book 63
 - scheduling 86
 - Replacing antenna 241–242
 - Replying to mail
 - in iMessenger application 147, 149
 - in Mail 167
 - in web clipping applications 136
 - Requirements 4
 - Retrouting replies to messages (iMessenger application) 149
 - Rescheduling events 85
 - Resetting handheld
 - hard reset 244
 - location of reset button 7, 243
 - soft reset 243
 - tool for 243
 - Responses to queries. *See* Clippings
 - Retrieving e-mail. *See* Filters for e-mail
- ## S
- Saving
 - clippings 135–136
 - data 43, 61, 63
 - draft e-mail (Mail) 174
 - draft messages (iMessenger application) 153
 - Scheduling events 81–85
 - Screen
 - backlight 5
 - blank 249
 - calibrating 17, 213
 - caring for 237
 - touching with your finger 5
 - Scroll bar 19
 - Scroll button 6
 - Searching. *See* Finding
 - Secondary DNS 226
 - Security 50–53
 - changing password 51
 - deleting password 51
 - displaying owner's name 232
 - forgotten password 53
 - locking the handheld 52
 - preventing transmission of
 - location and ID 235
 - private records 76–78
 - of wireless transactions 125
 - Selecting
 - date for event 83
 - e-mail to be synchronized. *See* Filters for e-mail
 - phone numbers in Address Book 97
 - text 62
 - Sending
 - data. *See* Beaming information
 - e-mail (Mail) 165–167, 172
 - messages (iMessenger application) 145–147, 151

- messages from web clipping
 - applications 136
 - queries to Internet 131
- Separators between addresses 146, 166
- Serial
 - connections 216
- Serial port 8, 190, 198
- Service agreement, Palm.Net 277
- Service templates 224, 230
- Service, Palm.Net 124
- Service, selecting for network 219
- Setting up handheld 10
- Settings. *See* Preferences
- ShortCuts
 - backing up 191
 - managing 233–234
 - menu commands 23
 - predefined 40
 - using 39
- Showing dates
 - in iMessenger list 156
 - in Mail list 177
- Signal strength 127–128, 251
- Signature
 - for e-mail (Mail) 171–172
 - for messages (iMessenger application) 150
- Simulated port for infrared communication 195
- Soft reset 243
- Sorting
 - applications 44
 - e-mail (Mail) 177
 - messages (iMessenger application) 157
 - records 75–76, 252
- Sounds. *See* Alarm *and* System sounds
- Starting applications
 - basic applications 19–20
 - iMessenger application 138
 - web clipping applications 129
- Storing
 - e-mail (Mail) 172, 175
 - messages (iMessenger application) 151

- Stylus
 - dragging with 17
 - pen stroke to activate a feature 211
 - reset tool 243
 - tapping with 17
 - writing with 7, 31
- Submitting queries to Internet 131
- Sunday, to start week 214
- Symbols
 - for currency 112
 - in Graffiti writing 37
 - See also* Icons
- Synchronizing data. *See* HotSync
- System conduit 191
- System requirements for Desktop software 4
- System sounds 215

T

- Tab delimited files, importing data from 41
- Tapping 17, 250
- TCP/IP 218, 231
- TDA (To Do List archive file) 41
- Technical Support 125, 127, 247, 261
- Templates for expense reports 117
- Text
 - copying 62
 - cutting 62
 - entry. *See* Entering data
 - fonts for 79
 - selecting all 62
- Text files, importing data from 41
- Thousands separator 214
- Time
 - alarm setting 85
 - format 214
 - setting current 28
 - setting event 81
 - start and end for Date Book Day view 94
- Time bars in Date Book 93
- Tips, online 24
- To Do List
 - adding Address Book data to records 73–74

- archive files (.tda) 41
- categorizing records 67, 103
- completed items 103
- completion date 103
- conduit for synchronizing 191
- creating records 61, 100
- deleting records 63, 87
- due date 102, 103
- fonts 79
- menus 104
- notes for records 78–79
- opening 58
- overview 58
- prioritizing records 100, 103
- private records 78
- problems with 252
- purging records 64, 103
- sorting records 75
- Today. *See* Current date
- Transferring data. *See* HotSync
- Transmitter 10, 239
- Transmitting data. *See* Beaming information
- Troubleshooting 247–261
- Truncated messages (iMessenger application) 142–143
- Truncating e-mail (Mail) 183
- Turning off handheld
 - automatically 214
 - pen stroke for 212
 - power button 5
 - problems with 249
- Turning on handheld
 - application buttons 6
 - displaying owner's name 232
 - power button 5
 - problems with 249

U

- Undeliverable iMessenger messages 157
- Undoing actions 62
- Uninstalling Desktop software 50
- Unresponsive handheld 249
- Unsent e-mail, editing 173
- Unsent iMessenger messages, editing 152

- Untimed events 81, 84, 86
- Updating data. *See* HotSync
- Upgrading 10–12
- User profiles 207
- User-defined categories 67
- Username
 - identifying handheld 232
 - for ISP 219
 - for Palm.Net service 15, 234
 - unique for each handheld 12

V

- Vendor for Expense item 112

W

- Web clipping 136
 - example 133–134
 - overview 16, 121–123
- Web clipping applications
 - downloading new 124
 - example 133–134
 - going back through pages 132
 - menus 136
 - overview 122, 129
 - for Palm.Net service 127
 - preferred application to open 211
 - preventing transmission of location and ID 235
 - reviewing clippings 134
 - saving information
 - from 135–136
 - sending messages from 136
 - stopping transactions 132
 - submitting queries 131
- Web sites 14, 126, 194
- Week (Date Book view) 89–90, 214, 252
- Windows Messaging (Microsoft) 162
- Wireless communication service. *See* Palm.Net service
- Wireless features. *See* iMessenger application *and* Web clipping applications
- Wireless Internet messaging. *See* iMessenger application

Wireless preferences 234
Writing area 6
Writing. *See* Entering data

X

XLT (Expense report template in
Excel) 117

Y

Yahoo! People Search 133