

VisorPhone™ Module User Guide



Copyright

Copyright © 2000 - 2001 Handspring, Inc. All rights reserved. Handspring, Springboard, Visor, VisorPhone, the Handspring logo, and the Springboard logo are trademarks of Handspring, Inc., and may be registered in some jurisdictions. Graffiti, HotSync, and Palm OS are registered trademarks of Palm, Inc. or its subsidiaries. All other trademarks are the property of their respective owners.

Disclaimer and limitation of liability

Handspring, Inc. and its suppliers assume no responsibility for any damage or loss resulting from the use of this guide.

Handspring, Inc. and its suppliers assume no responsibility for any loss or claims by third parties which may arise through the use of this software and hardware. Handspring, Inc. and its suppliers assume no responsibility for any damage or loss caused by deletion of data as a result of malfunction, dead battery, or repairs. Be sure to make backup copies of all important data on other media to protect against data loss.

Important: Please read the Handspring End User Software License Agreement in the back of this guide before using the accompanying software program(s). Using any part of the software indicates that you accept the terms of the Handspring End User Software License Agreement.

Part #: 50-0227-01

Contents

Getting Started	1
Step 1: Set up your handheld computer.....	2
Step 2: Insert your SIM card into your VisorPhone	3
Step 3: Insert your battery into your VisorPhone	4
Step 4: Get to know your phone	5
Step 5: Connect the phone to your handheld.....	7
Step 6: Charge the battery.....	8
Step 7: Turn on your phone.....	9
Step 8: Activate your account.....	10
Congratulations	11
Making Voice Calls	13
Calling a speed dial number	14
Dialing a number with the Dialpad	15
Redialing the last number	16
Redialing previous numbers	16
Calling a number in your Address Book.....	17
Dialing a number from other applications.....	18
Returning a missed call.....	19
Calling an emergency number	20
Receiving Calls	21
Answering the phone.....	22
Responding to call waiting	23
Forwarding calls	24

Handling Multiple Calls.....	25
Placing a call on hold	26
Dialing another number while a call is on hold	27
Switching between two calls	28
Using 3-way calling.....	29
Checking Messages	31
Reviewing missed calls	32
Checking voicemail	33
Checking text messages.....	34
Displaying call history.....	35
Purging call history	36
Managing Your Speed Dial List	37
Defining speed dial buttons	38
Adding an Address Book entry to your speed dial list.....	39
Changing a speed dial entry.....	40
Deleting speed dial entries	41
Arranging the speed dial list.....	42
Using Your SIM Phonebook	43
Copying entries from your speed dial list to your SIM card.....	44
Copying entries from your SIM card to your speed dial list.....	45
Deleting entries from your SIM card	46
Dialing entries on your SIM card	47

Working With SMS Text Messages	49
Enabling SMS and SMS Email	50
Viewing messages	51
Replying to messages.....	52
Creating messages	53
Creating message greetings and signatures	56
Saving incoming messages.....	57
Copying incoming messages	57
Forwarding incoming messages	58
Modifying messages.....	58
Sorting messages.....	59
Deleting messages	60
Using VisorPhone as a Wireless Modem	61
Setting up VisorPhone as a wireless modem	62
Using third-party data applications with VisorPhone	63
Preparing for a direct wireless HotSync operation	64
Preparing for a network wireless HotSync operation	65
Performing a wireless HotSync operation.....	66
Customizing Your Phone	67
Setting dialing prefixes for use in North America	68
Assigning dialing applications	69
Changing the phone display.....	70
Selecting the ringer settings	71
Preventing unauthorized use of your phone.....	72
Unlocking your phone.....	73

Disabling call waiting	74
Blocking your phone number for outgoing calls	75
Selecting a service provider network	76
Connecting a headset	77
Using the Menus.....	79
Phone application Edit menus	79
Phone application Record menu.....	79
Phone application Options menus.....	80
SIM Phonebook application Edit menu	81
SIM Phonebook application Options menu.....	81
SMS Message Manager application Message menus	82
SMS Message Manager application Edit menu.....	83
SMS Message Manager application Options menu	84
Troubleshooting and Maintenance.....	85
Caring for your VisorPhone module	91
Caring for the battery	92
How do I dispose of the battery?	93
Warranty and Other Product Information	95
Index	115

Getting Started

Congratulations on the purchase of your new VisorPhone™ module. Your VisorPhone module integrates the power of a state-of-the-art digital mobile phone with the simplicity of your Handspring handheld computer.

To use your VisorPhone, you must first activate your account with your mobile phone service provider.

Your account information is located on your SIM (Subscriber Identity Module) card. If a SIM card did not come with your VisorPhone, your service provider will provide one when you subscribe to their service. Your SIM card must be inserted into your VisorPhone before you can use it.

Just follow the eight easy steps in this chapter to get up and running quickly.

Step 1: Set up your handheld computer

1. If you haven't already set up your handheld, follow the steps that came with your handheld to set it up.
2. (Recommended) Synchronize your handheld with your computer.

Place your handheld
in the cradle and
press the HotSync
button

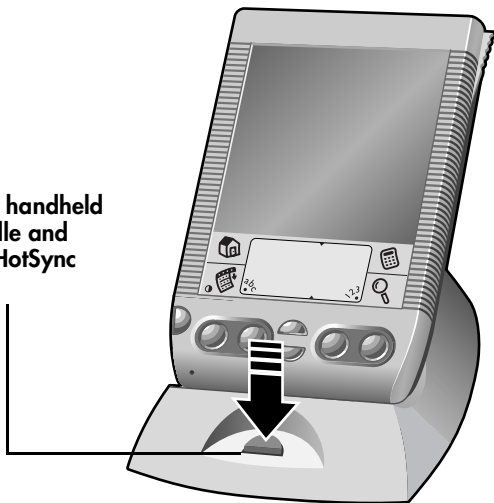

Tip: If you need additional information about synchronizing, refer to the *Quick Reference Guide* and *Visor Handheld User Guide* that came with your handheld.

Step 2: Insert your SIM card into your VisorPhone

The SIM (Subscriber Identity Module) card is a small rectangular plastic piece. The SIM card is included with your service provider's documentation and is often referred to as a "smartcard."

Note: If your SIM card is already inserted in your phone, skip to Step 3.

- Insert the SIM card into the slot.

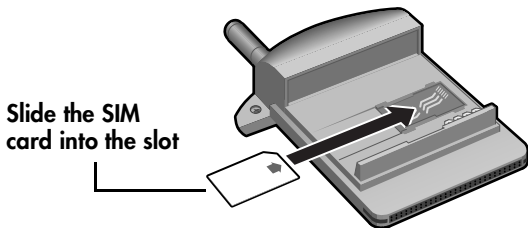

Tip: Since calls are billed to your telephone number, you can move your SIM card to any mobile phone that uses a SIM card, and the calls will be billed to your account.

Step 3: Insert your battery into your VisorPhone

- Insert the battery into your VisorPhone and secure the latch.

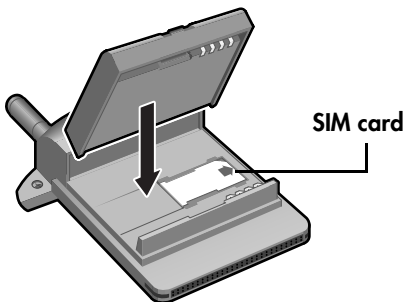

Step 4: Get to know your phone

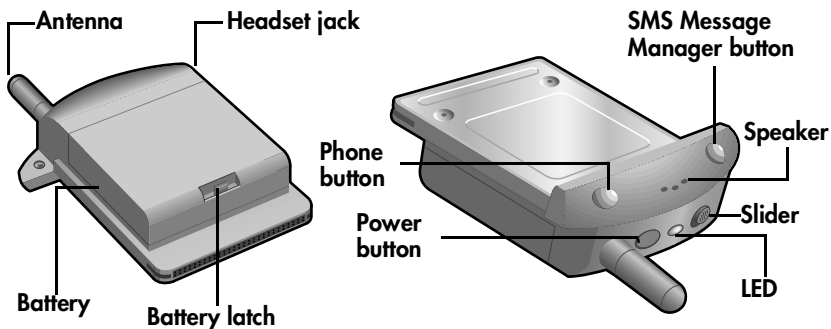

- Antenna** Receives and sends signals on your VisorPhone. The antenna does not telescope out of the phone.
- Headset jack** Enables you to connect a headset so you can view your handheld screen while talking on the phone.
- Battery** Powers your VisorPhone.
- Battery latch** Secures the battery to your VisorPhone.
- Power button**  Turns on your VisorPhone and activates the signal. Your phone stays on until you remove it from your handheld or press the power button to turn it off.

Speaker



Functions as the earpiece on your VisorPhone.

Tip: To adjust the volume during a call, press the scroll buttons on the front of your handheld.

Phone button



Turns on your handheld and starts the Phone application. If another application is running, press this button to switch to the Phone application. If the phone is ringing, press this button to answer calls.

SMS Message Manager button



Turns on your handheld and starts the SMS Message Manager application so you can view, send, and receive text messages.

Slider



Controls the ringer setting. See “Selecting the ringer settings” on page 71 for details on changing the settings.

LED

Provides status information for your VisorPhone. The color of the light and the blink state indicate the status as follows:

No light = Phone off

Red/solid = Charger on; battery charging

Green/solid = Charger on; battery fully charged

Red/slow blink = Phone on; no network service

Green/slow blink = Phone on; in service

Red/fast blink = Battery low

Green/fast blink = Data call active

Step 5: Connect the phone to your handheld

1. Remove the slot protector from your handheld.
2. Insert your VisorPhone module into the Springboard™ expansion slot.

Slide the slot protector away from your handheld

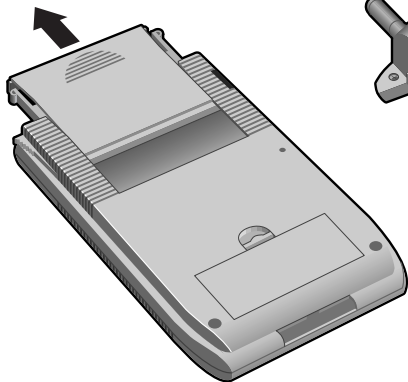

Slide the module into the Springboard expansion slot

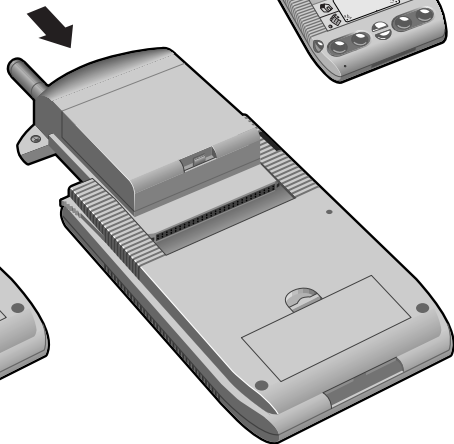



Tip: To remove your VisorPhone from your handheld, simply slide it out from the Springboard expansion slot.

Step 6: Charge the battery

1. Plug the travel charger into a wall outlet.
2. Insert the travel charger cable into the connector on your handheld.

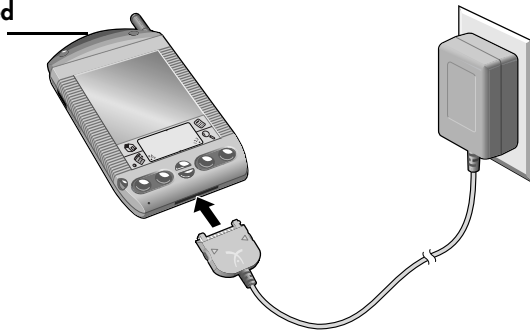
LED turns solid red when charging and solid green when charged



Tip: When your phone is on, the charge icon  appears in the Phone application while your VisorPhone charges. Note that your VisorPhone must be in your handheld while charging, and that it takes about 1.5 hours to fully charge the battery. It's time to recharge the battery when you observe one of the following:

- the LED turns red and blinks quickly
- the LED does not turn on when you turn on your phone
- the battery gauge  in the top-right corner of the Phone application appears empty when your VisorPhone is on and the Phone application is on the screen

Step 7: Turn on your phone

After the battery is charged, you can begin using your phone.

1. Press the Power button on your VisorPhone for two seconds until you hear a beep.

Note: If the Unlock Phone dialog appears, see “Unlocking your phone” on page 73 for instructions.

2. Wait up to two minutes for your VisorPhone to locate your service provider’s network. Do not tap OK.





Tip: When your VisorPhone locates the network, the Network Search dialog displays a Welcome message and your service provider’s name appears in the upper-left corner of the Phone application. If you are in an area without coverage, the Network Search dialog displays an “Unable to register to the network” message and “No Service” appears in the upper-left corner of the Phone application.

Step 8: Activate your account

If you received a new SIM card with your phone, you need to call your service provider to activate your account (unless it was activated upon purchase at a retail location). Your service provider's phone number is located on the materials that came with your VisorPhone module.

Once you receive your phone number, it may take a few hours to become fully active. Some service providers send a special message with your phone number. Follow these steps to check the phone number:

1. Make sure your phone is on for at least 30 seconds.
2. Press the Phone button  on your VisorPhone to access the Phone application.
3. Tap the Menu icon .
4. Under Options, tap Phone Info.

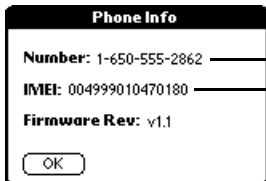

—Your VisorPhone number (if available)

—Your equipment ID number

5. Tap OK.

Congratulations

You're ready to use your VisorPhone module. Keep these things in mind as you use your new phone:

- If you travel outside a coverage area, your phone remains on but you can't make or receive calls. If this occurs, the LED blinks red slowly and the phone periodically tries to register to the network. When you return to a coverage area, the LED blinks green.
- Although VisorPhone supports many calling features, such as call waiting, call hold, call forwarding, 3-way calling, voicemail, SMS, and SMS Email, check with your service provider to confirm that these services are available and active on your mobile calling plan.
- If you travel outside a coverage area, you can't receive SMS text messages. However, the messages are stored by the network and you will receive them when you return to a coverage area.
- Your account includes a voicemail feature so people can always leave you a message even when your phone is off.
- Always use care when operating a mobile phone. If you plan to use your VisorPhone module while driving a car, we recommend that you become familiar with local laws concerning use of a mobile phone while driving, and that you use a headset for hands-free operation. See "Connecting a headset" on page 77 to learn how to connect a headset to your VisorPhone.

Making Voice Calls

There are several ways to make voice calls with your VisorPhone. This chapter describes how to dial a number by:

- Selecting it from your speed dial list
- Entering it on the Dialpad
- Selecting it from your Call History list
- Selecting it from your Address Book
- Dialing from another application
- Returning a missed call
- Dialing an emergency number

After you dial and establish a connection, the Active Call screen appears:

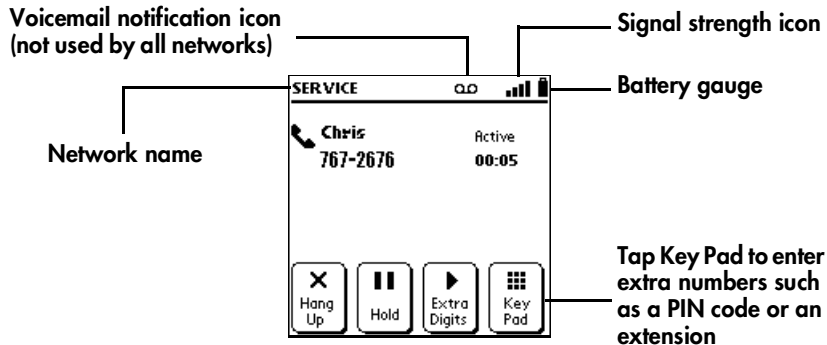

Calling a speed dial number

Speed dialing enables you to quickly place a call without entering the number. This is particularly useful for numbers you call often, such as your home or office.

Note: This section assumes you've already created a speed dial list. To learn how to add numbers to your speed dial list see “Defining speed dial buttons” on page 38.

1. Press the Phone button  on your VisorPhone.

Tip: If the screen below doesn't appear, tap the Speed Dial icon .

2. Select the number you want to call.

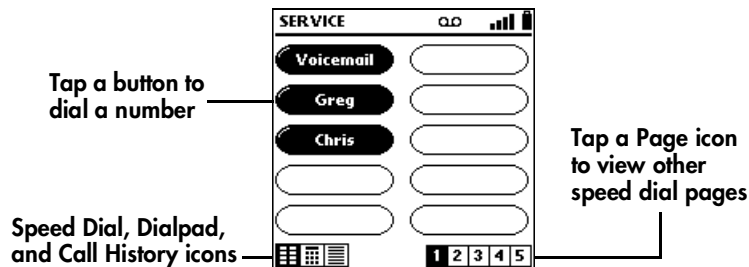

Tip: After you make the connection the Active Call screen appears. If prompted to enter a menu selection, tap Key Pad. If you defined any Extra Digits, such as an extension, tap Extra Digits.

3. Tap Hang Up to end the call.

Dialing a number with the Dialpad

1. Press the Phone button  on your VisorPhone.

Tip: You can also tap the Phone icon  in the Applications Launcher to start the Phone application.

2. Tap the Dialpad icon .
3. Dial the number. If you are dialing an international number, tap the + key before entering the number to automatically insert the international access code upon dialing.

Tip: To display the last ten numbers dialed, press the scroll buttons on the front of your handheld.

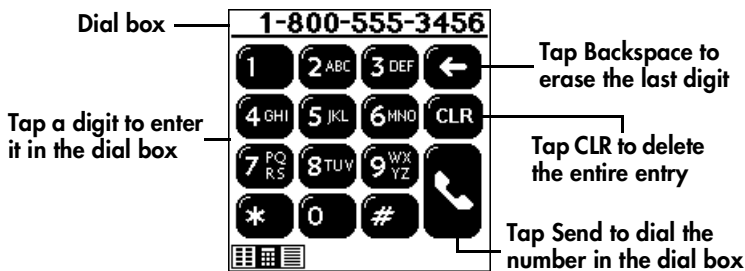



Tip: To edit the phone number, tap the Dial box and then use the keypad, Graffiti® writing, or the onscreen keyboard.

4. Tap Hang Up to end the call.

Redialing the last number

- Hold down the Phone button for two seconds to redial the last number you called.

Redialing previous numbers

1. Press the Phone button  on your VisorPhone.
2. Tap the Call History icon  to view a list of previous incoming and outgoing calls.
3. Select the number you want to call.

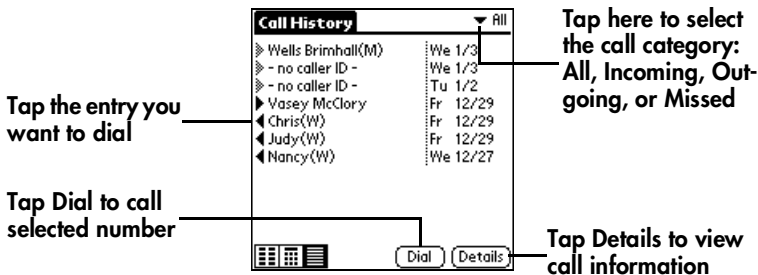

4. Tap Dial.

Tip: To add a number to your Address Book or Speed Dial list, tap Details, tap Copy Phone #, then in Address Book or Speed Dial Edit view, tap the line where you want to add the number, and select Paste from the Edit menu to insert the number.

Calling a number in your Address Book

1. Press the Address Book button  on the front of your handheld.
2. Select the number you want to call.

Tap a name to view or edit contact information



Tap a number to select a number to dial

Tap a number to select it

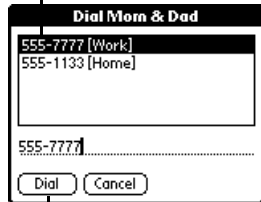

Tap Dial to call the number

Tip: If you install a third-party email or SMS application, the Dial button changes to an Email button when you select an email address, or to an SMS button when you select a mobile phone number. See “Assigning dialing applications” on page 69 for details on assigning compatible third-party SMS and Email applications to these buttons.

3. Tap Hang Up to end the call.

Dialing a number from other applications

You can also dial numbers from other applications such as Memo Pad or To Do List.

1. Highlight the number you want to dial.
2. Press the Phone button  on your VisorPhone.

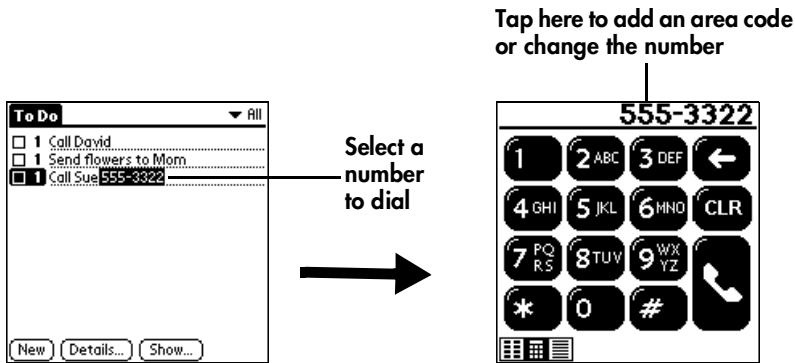

Tip: The number automatically appears in the Dial box on the Dialpad screen so you can edit the number if needed.

Returning a missed call

When your VisorPhone is on and you remain in a coverage area, any calls you miss appear in the Call History list and you receive a missed call alert message. When your phone is off or you travel outside a coverage area, your calls are forwarded to voicemail and they do not appear in the Call History list.

- If you miss multiple calls, a message appears indicating the number of calls you missed. Follow the steps in “Reviewing missed calls” on page 32 to return the calls.
- If you miss a single call, the following screen appears:

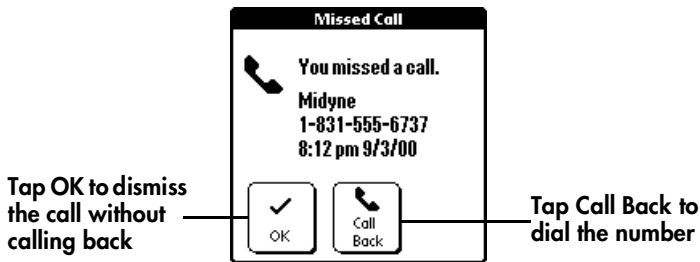

Tip: If the caller's phone number is not available, the Call Back button does not appear on the Missed Call screen.

Calling an emergency number

Your VisorPhone provides easy access to emergency numbers such as 112 or 911.

1. Press the Phone button  on your VisorPhone.
2. Do one of the following:
 - If your phone is unlocked, dial 112 or 911 from the Dialpad screen.
 - If your phone is locked or your SIM card is missing, tap Make Emergency Call from the Unlock Phone or SIM Card Not Found screen.



Tap Make Emergency Call

Tip: You don't need to unlock your phone or even have the SIM card installed to call an emergency number.

Receiving Calls

Whenever your phone is on and you are within a coverage area, you can receive incoming calls. In addition to answering calls, you can also choose several incoming call options. This chapter describes how to:

- Answer the phone (or reject a call)
- Respond to a call waiting prompt
- Forward your calls

Answering the phone

An incoming call turns on your handheld if it is off.



Tip: You can also answer a call by pressing the Phone button  while your VisorPhone is ringing.

Responding to call waiting

When you are on the phone and receive a second call, the Phone application updates the Active call screen and emits a Call Waiting “beep” tone.

Tip: Make sure the Disable Call Waiting option on the Call Preferences screen is off. When this option is off the Disable Call Waiting check box is empty. For more information on enabling and disabling call waiting, see “Disabling call waiting” on page 74.

- When the Call Waiting dialog appears, tap the appropriate button.

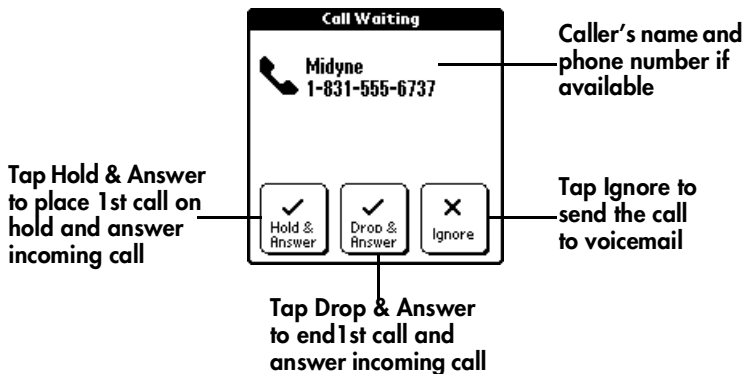

Tip: You can also press the Phone button  to place the first call on hold and answer the incoming call.

Forwarding calls

If you need to turn off your phone or know you will be traveling outside a coverage area, you can forward your calls to another number. Keep in mind that your service provider will still charge you for your forwarded calls.

Note: Because call forwarding information is stored by the network, it's a good idea to check the current network settings both before and after you change the call forwarding option.

1. Tap the Menu icon .
2. Under Options, tap Call Preferences.
3. Select the call forwarding option you want to use.

Tap here to forward all calls to the selected number

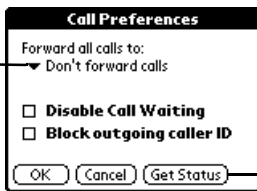

Tap here to display current network settings

Tip: You can define multiple forwarding numbers. Select Edit numbers from the list to add, change, or delete a number.

4. Tap OK.

Handling Multiple Calls

You can use the Hold button in the Phone application to handle a variety of situations that involve multiple calls. During an active call, you can receive or place another call, switch between two active calls, and create a 3-way conference call. For example, when you're talking to a friend, you can put them on hold, call a restaurant to make dinner reservations, and return to your friend to confirm the time and place. These features also enable you to receive an important incoming call while you're already on the phone, and to facilitate conference calls when you're on the go.

This chapter describes how to:

- Place a call on hold
- Dial another number while a call is on hold
- Switch between two calls
- Use 3-way calling

Placing a call on hold

1. Place or answer a call.



Tap Hold to put the call on hold

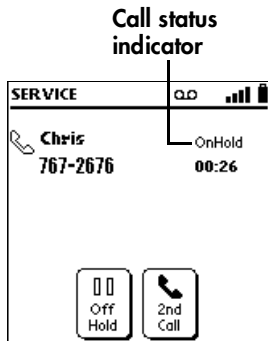

Tap Off Hold to return to the call

2. Tap Hang Up to end the call.

Dialing another number while a call is on hold

1. Place or answer a call.
2. Put the call on hold.

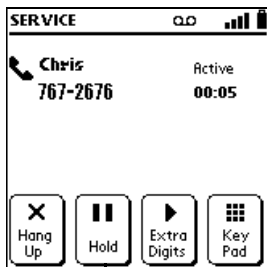

Tap Hold to put the call on hold



Tap 2nd Call to access dial functions

3. Tap 2nd Call.
4. Dial the number.

Tip: You can tap the Applications Launcher icon  to open another application that has the number you want to dial.

Switching between two calls

1. Answer or place two calls. See “Dialing another number while a call is on hold” on page 27.
2. Tap Swap, or tap the call status line to switch between calls.

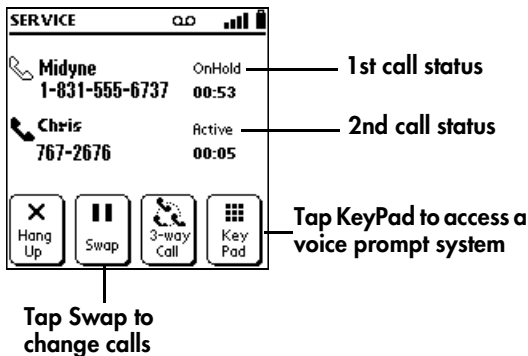

- Tip:** If you called an automated phone system that prompts you to enter a menu selection or phone extension, tap KeyPad to respond to the voice prompts.
3. Tap Hang Up to end the active call.

Using 3-way calling

1. Answer or place two calls.
2. Join the two calls.

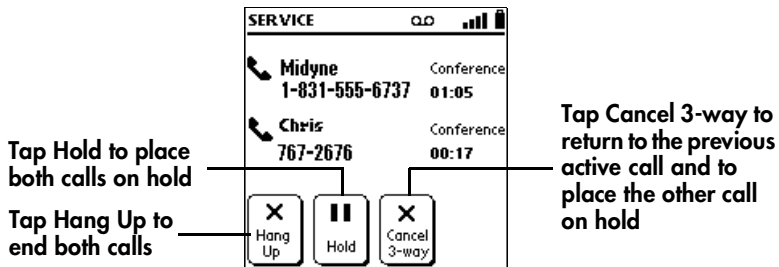
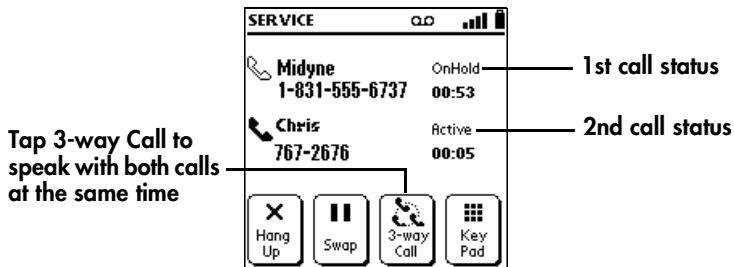

Checking Messages

Your VisorPhone is capable of receiving voicemail and text messages and generating missed call messages.

If you miss a call when your VisorPhone is on and you remain in a coverage area, your missed calls appear in the Call History list and you receive a missed call alert message. When your phone is off or you travel outside a coverage area, your missed calls are forwarded to voicemail and they do not appear in the Call History list. Similarly, when your phone is off or you travel outside a coverage area, your service provider stores your text messages until you turn on your phone or return to a coverage area.

Note: You may need to contact your service provider to add the text messaging feature to your rate plan. This feature is sometimes referred to as SMS, or Short Message Service.

This chapter describes how to:

- Review missed calls
- Check voicemail
- Check text messages
- Display call history
- Purge call history

Reviewing missed calls

When you don't answer an incoming call, it appears under Missed calls in your Call History list.

1. Tap the Call History icon .
2. Tap Missed in the pick list in the upper-right corner.

Tap caller's name
or phone number

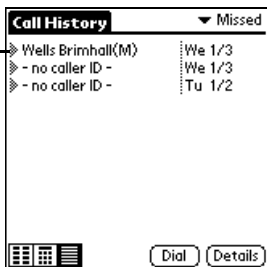

Tap Dial to return the call

Checking voicemail

When your phone is off, you travel outside a service area, or you miss or choose to ignore a call, the caller may leave a voicemail message. When you connect to the network, the phone application notifies you that you received voicemail messages.

1. Dial your voicemail service using one of these methods:
 - Tap the Voicemail button in the Speed Dial view.
 - Tap Listen in the Voicemail alert dialog.
 - Tap the Voicemail icon  in the upper-right part of the Speed Dial view or the Dialpad view.

Tip: Some service providers do not support the Listen button and the Voicemail icon .

2. Tap Key Pad on the Active Call screen.

Tap buttons to dial access codes and review messages



3. Tap Done.

Checking text messages

When your phone is off or you travel outside a service area, other people can still send you text messages. Your service provider stores the messages for you until you turn on your phone or return to a service area. When you connect to the network, the SMS Message Manager displays the first message in a screen similar to the following:

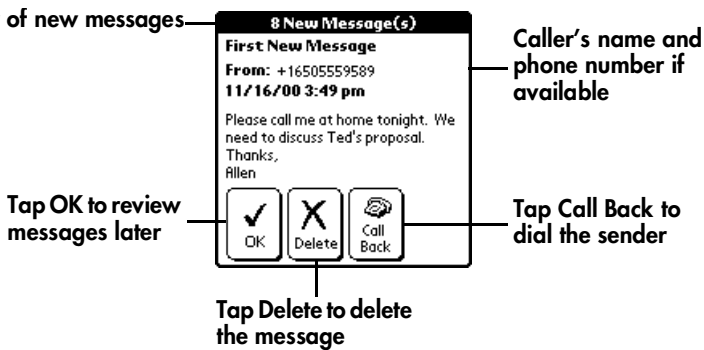

Displaying call history

The Call History view provides quick access to the previous 1,000 incoming and outgoing calls.

- Tap the Call History icon .

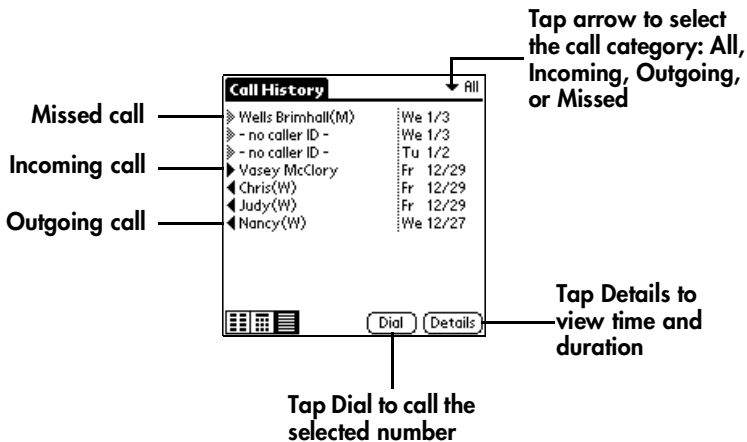

Tip: To temporarily store a number in your handheld's memory, tap Details, tap Copy Phone #, and then tap Done. You can now Paste this number into any application on your handheld.

Purging call history

Your VisorPhone continues accumulating call history information for up to 1,000 calls until you purge the call history list. To conserve storage space, we recommend that you purge this list periodically.

Note: Using the Purge function permanently removes the calls from your handheld. You cannot undo this process to restore the information.

1. From the Call History view, tap the Menu icon .
2. Under Record, tap Purge.

Tip: To delete a specific item, select the item from the Call History view and tap Delete Item instead of Purge.

3. Select the purge option you want to use.

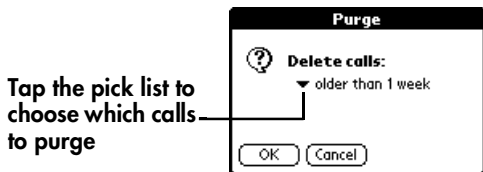

4. Tap OK.

Managing Your Speed Dial List

You can store up to 50 phone numbers in the speed dial list. There are five pages of numbers that hold ten numbers per page.

Tip: Keep your speed dial list organized by storing different types of numbers on different pages. For example, create separate pages for family, business, friends, and emergency numbers.

This chapter describes how to:

- Assign phone numbers to speed dial buttons
- Add Address Book entries to your speed dial list
- Change speed dial entries
- Delete speed dial entries
- Arrange the speed dial list

Defining speed dial buttons

1. Tap the Speed Dial icon .
2. Tap a blank speed dial button.

Note: The first slot on the first Speed Dial page is reserved for your service provider's voicemail service number.

3. In the Edit Entry dialog, enter the Name, Number, and any Extra digits.

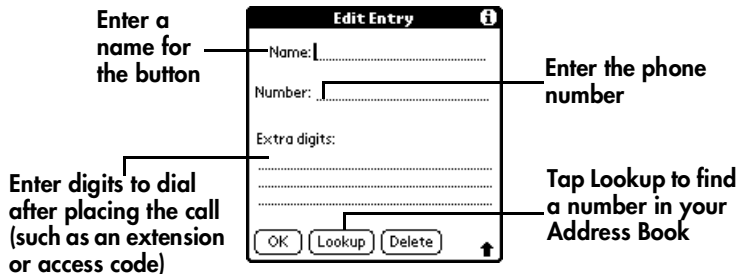

Tip: To insert a pause between Extra digits when dialing, enter a comma (,). Each comma represents a one second pause.

4. Tap OK.

Adding an Address Book entry to your speed dial list

1. Tap the Speed Dial icon .
2. Tap a blank speed dial button.
3. Tap Lookup.
4. In the Phone Number Lookup dialog, use the scroll arrows or begin writing the person's last name to find the number you want.

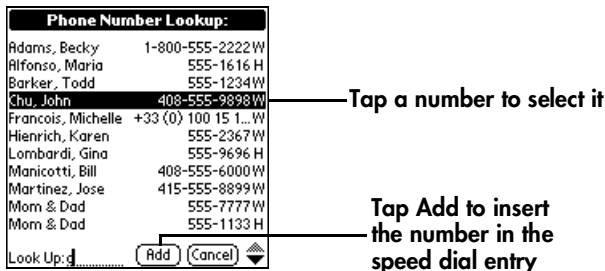



5. Tap Add.

Tip: You can edit the number or name by tapping it in the Edit Entry dialog.

6. From the Edit Entry dialog, tap OK.

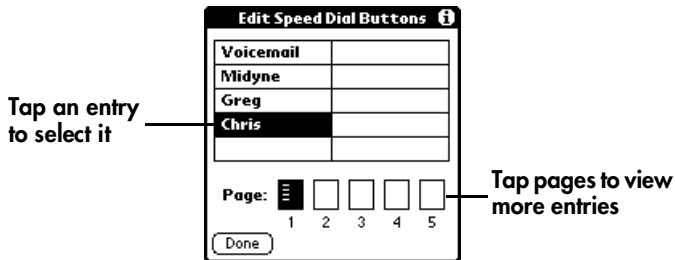

Changing a speed dial entry

1. Tap the Speed Dial icon .
2. Tap the Menu icon .
3. Under Edit, tap Edit Speed Dial.
4. Select the entry you want to change.



5. In the Edit Entry dialog, enter the new information.
6. Tap OK to save the new information.
7. Tap Done.

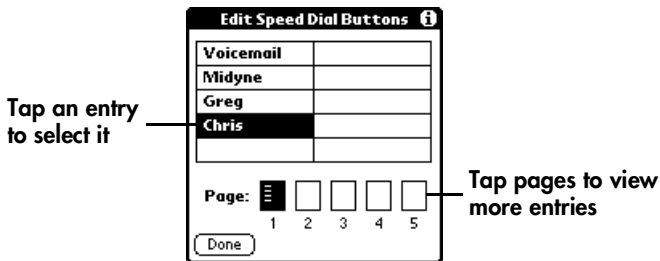

Deleting speed dial entries

1. Tap the Speed Dial icon .
2. Tap the Menu icon .
3. Under Edit, tap Edit Speed Dial.
4. Select the entry you want to delete.



5. In the Edit Entry dialog, tap Delete.
6. Tap OK to confirm deletion.
7. Tap Done.

Arranging the speed dial list

1. Tap the Speed Dial icon .
2. Tap the Menu icon .
3. Under Edit, tap Edit Speed Dial.

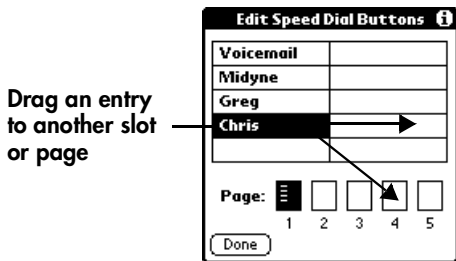

- Tip:** If the new slot is full, the other entries move over one slot as the rows fill from top to bottom. If you drag an entry to a page icon, the entry moves to the first available slot on that page.
4. Tap Done.

Using Your SIM Phonebook



In addition to storing your phone number and billing information, your SIM card also contains a phone list that is separate from your Address Book and speed dial list. Most SIM cards enable you to store more than 50 names and numbers. By storing a phone list on your SIM card, you have immediate access to your phone list when you move your SIM card to another phone.

The SIM Phonebook application is a utility that enables you to view and manage the phone list on your SIM card.

This chapter describes how to:

- Copy entries from your speed dial list to your SIM card
- Copy entries from your SIM card to your speed dial list
- Delete entries from your SIM card
- Dial entries on your SIM card

Copying entries from your speed dial list to your SIM card

1. Tap the Applications Launcher icon  on the front of your handheld.
2. Tap the SIM Phonebook icon .
3. Tap Speed Dial in the pick list in the upper-right corner.
4. Tap the entry you want to copy.

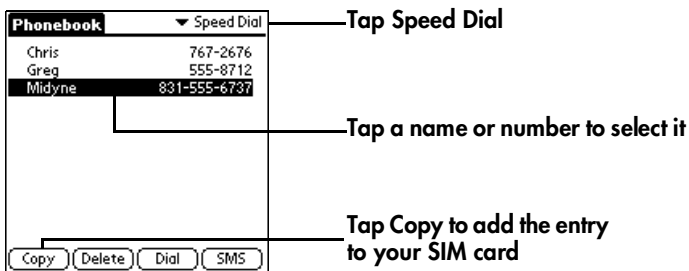

Tip: To copy all the numbers in your speed dial list, select Copy All from the Edit menu.



Tip: A check mark indicates that the entry is already on both your speed dial list and your SIM list.

5. Tap Copy.

Copying entries from your SIM card to your speed dial list

1. Tap the Applications Launcher icon  on the front of your handheld.
2. Tap the SIM Phonebook icon .
3. Tap SIM in the pick list in the upper-right corner.
4. Tap the entry you want to copy.

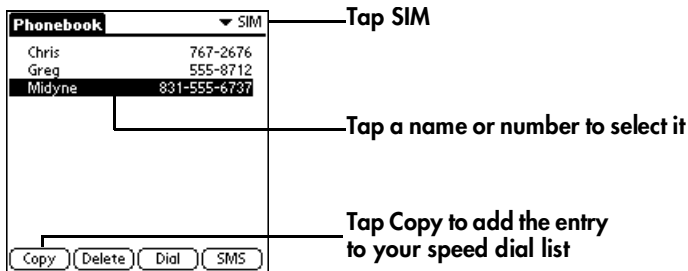

Tip: To copy all the numbers in your speed dial list, select Copy All from the Edit menu.



Tip: A check mark indicates that the entry is already on both your speed dial list and your SIM list.

5. Tap Copy.

Deleting entries from your SIM card

1. Tap the Applications Launcher icon  on the front of your handheld.
2. Tap the SIM Phonebook icon .
3. Tap SIM in the pick list in the upper-right corner.

Tip: To delete entries from your speed dial list, tap Speed Dial instead.

4. Select the entry you want to delete.

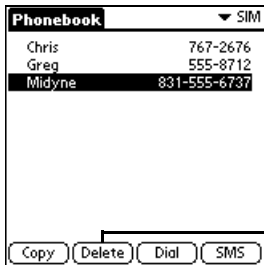



Tap to select SIM or Speed Dial

Tap a name or number to select it

Tap Delete to remove the entry

5. Tap Delete.
6. Tap OK to confirm deletion.

Dialing entries on your SIM card

1. Tap the Applications Launcher icon  on the front of your handheld.
2. Tap the SIM Phonebook icon .
3. Tap SIM in the pick list in the upper-right corner.

Tip: You can also dial entries from your speed dial list by tapping Speed Dial instead.

4. Select the entry you want to dial.

Tip: You can also send a text message to an SMS-enabled mobile phone by tapping a mobile phone number and then tapping SMS instead of Dial.

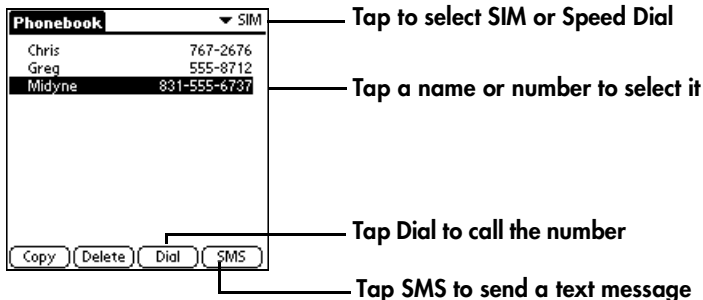

5. Tap Dial.

Working With SMS Text Messages



In addition to dialing and receiving calls, you can use your VisorPhone to send and receive short text messages. These text messages, also called SMS (Short Message Service) messages, are similar to email messages that you send and receive from your computer, but are limited to a few sentences in length. The person receiving your message must also have a GSM mobile phone and a service provider that supports text messages. Some service providers also allow you to use your mobile phone to send text messages to an email address and to receive text messages from a computer. Talk to your service provider for details about their SMS and SMS Email features. This chapter describes how to:

- Enable SMS and SMS Email
- View messages
- Reply to messages
- Create messages
- Create message greetings and signatures
- Set message options
- Save messages
- Forward messages
- Copy message text to the clipboard
- Modify outgoing messages
- Sort messages
- Delete messages

Enabling SMS and SMS Email

To send and reply to SMS messages, you must subscribe to your service provider's SMS service. If you subscribe to this service, your service provider supplies an SMS Message Center number which appears in the SMS Preferences dialog.

To use SMS Email, you must subscribe to your service provider's SMS Email service and enter their SMS Email Center number in the SMS Preferences dialog. The SMS Email Center forwards the SMS messages to the recipient's email address. Contact your service provider to obtain their SMS Email Center number.

1. Press the SMS Message Manager button  on your VisorPhone.
2. From any SMS Message Manager list view, tap the Menu icon .
3. Under Options, tap Preferences.

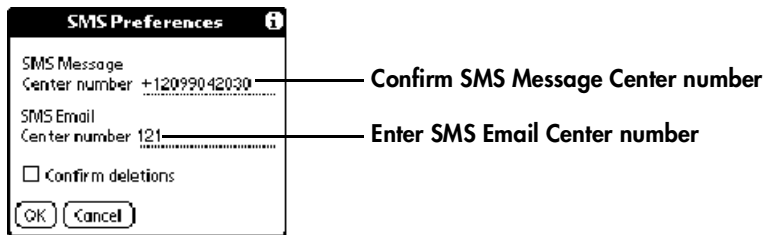

4. Tap OK.

Viewing messages

You can view SMS messages even if you don't subscribe to your service provider's SMS service.

1. Press the SMS Message Manager button  on your VisorPhone to open the SMS Message Manager Inbox.



Message read —

Tap New to create a message —

SMS 12 Msg. 9 New		Inbox
121	FM: Janet MSG...	9/5
121	FM: Chris MSG...	9/5
+16505...	Good news! M...	9/5
+16505...	Please meet m...	9/5
✓ +16505...	Karl can't mak...	9/5
+16505...	Please come g...	9/5
+16505...	Hi, Thank you...	9/5
+16505...	URGENT: I need...	9/5
+16505...	Please get milk...	9/5
+16505...	Please call me...	9/5
✓ +16505...	I'm running 10...	9/5

Tap arrow to select the message category: Inbox, Saved, Pending, or Sent

New Show...

Tip: When viewing Saved messages, the arrows indicate whether a message was incoming or outgoing.

2. Tap the message you want to view.
3. Press the scroll buttons on your handheld to scroll through a message. At the start or end of a message, it displays the next message.
4. Tap Done.

Replying to messages

To reply to SMS messages, you must subscribe to your service provider's SMS service. See “Enabling SMS and SMS Email” on page 50 to determine if you subscribed to your service provider's SMS service.

1. Tap the incoming message to which you want to reply.



Tap Reply to respond to the message

2. Tap Reply.
3. Enter the message text.

Tip: When you reply to an SMS message, the SMS Message Manager fills in the To field for you. When you reply to an email message, you must enter the email address on the first line of the message. See “Creating an SMS Email message” on page 55 for more information.

4. Tap Send.

Creating messages

SMS Message Manager enables you to create short text messages and send them to a GSM mobile phone number or an email address. If a message exceeds 160 characters, SMS Message Manager divides the text into multiple messages. As you create a message, the status bar indicates how many messages will be sent and the total number of characters in all the messages.

To save time while creating messages, you can insert predefined text from a template. Some templates ask you to enter information such as a meeting time or place. Using a template is similar to filling in the blanks on a form letter instead of writing a letter from scratch. Fortunately, in SMS Message Manager you can easily combine the template text with your own text to personalize your message.

You can create a message at any time, but if you send a message when you are outside a coverage area, your VisorPhone places the message in the Pending category and sends it automatically when you return to a coverage area. While a message is in the Pending category, you cannot edit it, but you can delete it before it is sent.

Creating an SMS text message

1. From any SMS Message Manager list view, tap New.
2. Address the message to a mobile phone number.

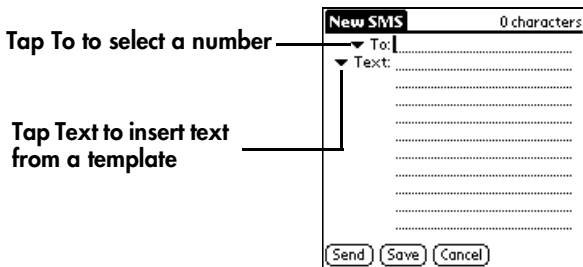

3. Enter text using Graffiti, the onscreen keyboard, or the Text and Greetings pick lists.
4. Tap Send. (The message goes into the Pending category until your phone transmits the message.)

Tip: To store a draft message and send it later, tap Save instead.

After your message transmits, your VisorPhone places a copy in the Sent category. If an error occurs while sending the message, an exclamation point (!) appears next to the message in the Sent category.

Note: Some service providers may restrict you from sending SMS messages to recipients outside your service network.

Creating an SMS Email message

To send a message to an email address, you must first enter your service provider's SMS Email Center number. See “Enabling SMS and SMS Email” on page 50.

1. From any SMS Message Manager list view, tap New.
2. Tap the To pick list and select SMS Email Center.

**Tap To to select
SMS Email Center**

**Enter email address
followed by a space
and # symbol**

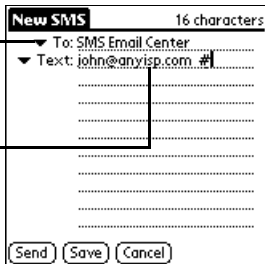

The screenshot shows a 'New SMS' form with a character count of '16 characters'. The 'To' field is set to 'SMS Email Center' and the 'Text' field contains 'john@anyisp.com #'. Below the 'Text' field are several empty lines for additional text. At the bottom are 'Send', 'Save', and 'Cancel' buttons.

3. On the first Text line, enter the recipient's email address followed by a space and a # symbol.
4. Enter the remaining text.
5. Tap Send. (The message goes in the Pending category until it transmits.)

Tip: To store a draft message and send it later, tap Save instead.

Creating message greetings and signatures

When you create a message you can use the greetings pick lists to insert a greeting and signature in your message. You can also add items to these lists or modify the existing items.

1. From any SMS Message Manager list view, tap the Menu icon .
2. Under Options, tap Greetings.

Tap here to hide the greetings pick lists

Tap Add entry to create a new greeting

Tap Add entry to create a new signature



3. Tap Done.

Saving incoming messages

1. Open the message you want to save.
2. Tap the Menu icon .
3. Under Message, tap Save.

Tip: Saving an incoming message moves the message from your Inbox to the Saved category.

Copying incoming messages

1. Open the message you want to copy.
2. Tap the Menu icon .
3. Under Message, tap Put Into Clipboard.

Tip: To create a memo with the text, tap Copy to Memo Pad instead.

4. Open the message or application where you want to insert the message.
5. Tap the Menu icon .
6. Under Edit, tap Paste.

Forwarding incoming messages

1. From the Inbox or Saved category, open the incoming message you want to forward.
2. Tap the Menu icon .
3. Under Message, tap Forward.

Tip: You can edit the forwarded message before sending it.

4. Enter the recipient's mobile phone number.

Note: The recipient's phone must be SMS enabled.

5. Tap Send.

Modifying messages

You can modify any outgoing messages in your Saved or Sent categories.

Tip: You can create your own message template by modifying and resending a Sent message.

1. Open the message you want to change.
2. Tap the message text, or tap Edit.
3. Edit the message.
4. Tap Send.

Tip: When modifying a message, you can keep the revised message without sending it by tapping Save instead of Send.

Sorting messages

1. In the SMS Message Manager, tap Show.
2. Select the sort method you want to use.

Tap arrow to select
sort method



3. Tap OK.

Tip: If you sort the list by name, messages from senders that are not in your Address Book appear at the bottom of the list in numerical order by phone number.

Deleting messages

1. In the SMS Message Manager, tap the pick list in the upper-right corner to select the category containing the messages you want to delete.
2. Tap the Menu icon .
3. Under Message, tap Purge.
4. Select the deletion method you want to use.

Tap arrow to select
deletion method



5. Tap OK.
6. If prompted, tap Yes to confirm deletion.

Tip: To delete a single message, open it and tap the Delete button.

Using VisorPhone as a Wireless Modem



In addition to using your VisorPhone as a phone, you can also use it as a modem that operates at 14.4Kbps or 9.6Kbps, depending on the speed of your service provider network. You can use your VisorPhone's modem capabilities with third-party communication software that you download from the Internet, such as web browsers or email applications, and to perform wireless HotSync operations when your cradle is not available.

This chapter describes how to:

- Set up your VisorPhone as a wireless modem
- Use third-party data applications with VisorPhone
- Prepare for a direct wireless HotSync operation
- Prepare for a network wireless HotSync operation
- Perform a wireless HotSync operation

Setting up VisorPhone as a wireless modem

To use your VisorPhone as a modem, you must subscribe to the data services feature from your service provider and establish an ISP account or corporate dial-up account.

1. Tap the Applications Launcher icon  on the front of your handheld.
2. Tap the Prefs icon .
3. Tap Network in the pick list in the upper-right corner.
4. Enter the configuration information for your ISP.

Select your ISP
from the Service
pick list

Tap here to enter
advanced DNS and
IP Address settings

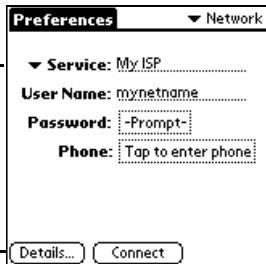

▼ Service: My ISP
User Name: mynetname
Password: -Prompt-
Phone: Tap to enter phone
Details... Connect

Enter your User Name,
Password, and your
ISP's phone number

- Note:** If your ISP is not on the Service pick list, tap the Menu icon , tap New on the Service menu, and enter the service name.
5. Check your settings by tapping Connect. When your settings work properly, the Connect button changes to a Disconnect button.



To learn more about using your handheld with your ISP, see “Network Preferences and TCP/IP Software” in the *Visor Handheld User Guide*.

Using third-party data applications with VisorPhone

Before using a third-party communication application, verify with the developer that the application you installed is compatible with VisorPhone.



1. Install the third-party application on your handheld. See “Installing third-party applications” in the *Visor Handheld User Guide* for details.
2. Start the third-party application you installed.

Note: Most third-party applications automatically connect you to your ISP when you start the application. If the application doesn’t connect you to your ISP, follow these steps to establish a connection:

- a. Tap the Applications Launcher icon  on the front of your handheld.
 - b. Tap the Prefs icon .
 - c. Tap Network in the pick list in the upper-right corner.
 - d. Tap Connect and wait for a connection to establish.
3. Disconnect after you finish using the third-party application.

Preparing for a direct wireless HotSync operation

A direct wireless HotSync operation is when you dial a modem attached to your desktop computer to perform a remote HotSync operation.

1. Tap the Applications Launcher icon  on the front of your handheld.
2. Tap the HotSync icon .
3. Tap Enter Phone #.
4. Enter your computer modem number, and then tap OK.

**Enter the number
used to call your
computer modem**



Phone Setup ⓘ

Phone #:



Dial prefix: 9.....

Disable call waiting: 1170.....

Use calling card:

.....



OK Cancel

5. Tap the Menu icon .
6. Under Options, tap Modem Sync Prefs.
7. Tap Direct to modem, and then tap OK.
8. On a Windows computer, click the HotSync icon  and check Modem on the HotSync Manager menu. On a Macintosh, open HotSync Manager and select Modem Setup on the Serial Port Settings tab.



Preparing for a network wireless HotSync operation

A network wireless HotSync operation is when you dial a modem attached to a network, such as a server on a corporate LAN, to perform a remote HotSync operation.

Note: This feature is not available for the Macintosh.

1. Tap the Applications Launcher icon  on the front of your handheld.
2. Tap the HotSync icon .
3. Tap the Menu icon .
4. Under Options, tap Modem Sync Prefs.
5. Tap Network, and then tap OK.
6. Tap Select Service and configure the Network Preferences panel.



Note: For information on the Network HotSync feature and configuring the Network Preferences panel, see the *Visor Handheld User Guide*.

7. On your desktop computer, click the HotSync icon  and check Network on the HotSync Manager menu.
8. Click the HotSync icon  again, select Setup, click the Network tab, and then select your user name.
9. Perform a HotSync operation.

Performing a wireless HotSync operation

Since your VisorPhone operates as a modem at 14.4Kbps or 9.6Kbps, a wireless HotSync operation takes significantly longer than performing a HotSync operation with your cradle. Therefore, we recommend performing a wireless HotSync operation only when your cradle is not available.

Tip: To increase the speed of a wireless HotSync operation, select Conduit Setup under Options and reduce the number of applications with which you synchronize.

1. Tap the Applications Launcher icon  on the front of your handheld.
2. Tap the HotSync icon .
3. Tap the Modem Sync icon .
4. Wait for your VisorPhone to connect with the modem on the other end and for the HotSync operation to finish.

Tip: If necessary, you can cancel the procedure at any time by tapping the Cancel button.

Customizing Your Phone



The Phone application Preference screens enable you to customize many of the VisorPhone features to meet your individual needs. For example, you can choose which view appears when you start the Phone application, and set security options to prevent unauthorized use.

This chapter describes how to:

- Set dialing prefixes
- Reassign the buttons in your Address Book
- Change the phone display
- Select the ringer setting
- Prevent unauthorized use of your phone
- Unlock your phone
- Disable call waiting
- Block your phone number for outgoing calls
- Select a different service provider network
- Connect a headset to your VisorPhone

Setting dialing prefixes for use in North America

Some North American service providers require 11-digit dialing. If you already have 7-digit or 10-digit numbers in your Address Book, you can set your VisorPhone to automatically use 11-digit dialing by using a default area code. Using this feature does not change the numbers in your Address Book.

1. Press the Address Book button  on the front of your handheld.
2. Tap the Menu icon .
3. Under Options, tap Dial Preferences.

Tap check box to insert an area code in front of 7-digit numbers before dialing

Tap check box to insert a 1 in front of 10-digit numbers before dialing

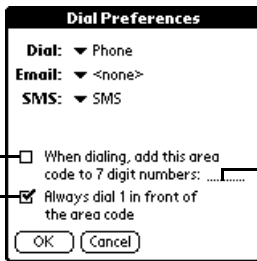

Dial Preferences

Dial: Phone
Email: <none>
SMS: SMS

When dialing, add this area code to 7 digit numbers:

Always dial 1 in front of the area code

OK Cancel



Enter default area code here

4. Tap OK.

Note: You may be prompted to enter a default area code the first time you dial a number from your Address Book.

Assigning dialing applications

When you select a phone number or email address in Address Book, you can tap the Dial, SMS, or Email buttons to direct the selected information to a specific application. The default applications for these buttons are the Phone application and the SMS Message Manager. However, if you have third-party SMS or Email applications installed on your handheld, you can assign these buttons to any application that is compatible with the dialing-enabled version of Address Book.

1. Press the Address Book button  on the front of your handheld.
2. Tap the Menu icon .
3. Under Options, tap Dial Preferences.

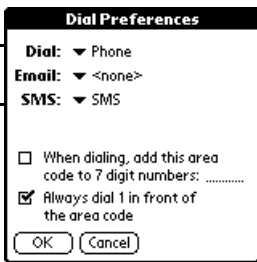

Tap pick lists to assign an application to that button



Tip: If no other applications appear in the pick lists, then you don't have compatible SMS or Email applications on your handheld.

4. Tap OK.

Changing the phone display

1. Press the Phone button  on your VisorPhone.
2. Tap the Menu icon .
3. Under Options, tap Phone Preferences.
4. Select the display options you want to use.

Tap the view you want to see when you open the Phone application

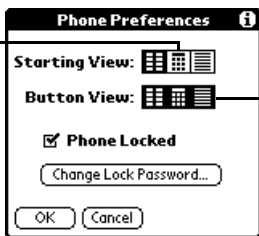



Tap an icon to skip that view when pressing the Phone button repeatedly

5. Tap OK.

Selecting the ringer settings

1. Tap the Menu icon .
2. Under Options, tap Ringer Preferences.

Tip: The slider on your phone has two positions  and . The two Ringer Preferences columns control the behavior of the corresponding slider position.

3. Select the ringer settings you want to use.

Tap Ring pick lists to
select ring style

Tap Volume pick lists to
select volume level

Tap Vibrate pick lists to turn
vibrate mode on or off





Tip: You can use both a ring tone and vibrate alert or use them separately. For example, you can set one position to ring softly and vibrate, and the other position to vibrate only. To preview a new sound, select Play ring when changed.

4. Tap OK.

Preventing unauthorized use of your phone

You can protect your phone number from unauthorized use by locking your SIM card.

1. Turn on your phone.
2. Press the Phone button  on your VisorPhone.
3. Tap the Menu icon .
4. Under Options, tap Phone Preferences.
5. Select the Phone Locked check box to lock your SIM card.

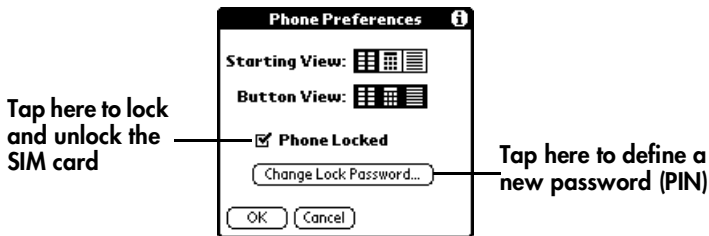

6. Enter your password (PIN) and tap OK.

Note: If you haven't set a password yet, check your service provider's documentation for the default password. In North America, this is usually 1234 or 1111.

7. Tap OK.

Unlocking your phone

1. Turn on your phone.
2. Press the Phone button  on your VisorPhone.
3. Enter your password (PIN).

Note: If you haven't set your own password, enter the password listed in your service provider documentation. In North America, this is usually 1234 or 1111.

If you are using a SIM card from an established account, enter your existing password.



4. Tap OK.

Tip: See “Preventing unauthorized use of your phone” on the previous page to learn about setting your own password.

Disabling call waiting

If you receive a call while you are talking on the phone, the Phone application notifies you about the second call. If you don't want to be interrupted by other calls, you can disable call waiting.

Note: Because call waiting information is stored by the network, it's a good idea to check the current network settings both before and after you change the call waiting option.

1. Tap the Menu icon .
2. Under Options, tap Call Preferences.
3. Disable the call waiting option.

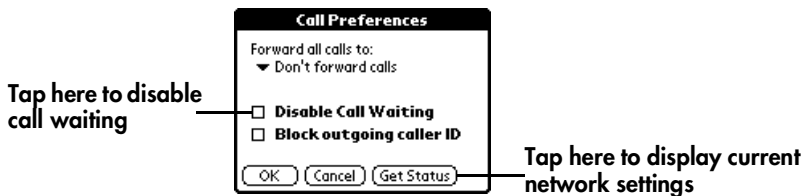



4. Tap OK.

Tip: To reactivate Call Waiting, remove the check from the Disable Call Waiting check box.

Blocking your phone number for outgoing calls

When you place a call from your VisorPhone, the Phone application reveals your phone number to the person you're calling. If your service provider supports caller ID blocking, you can prevent revealing your phone number to people you call.

Note: Because caller ID blocking information is stored by the network, it's a good idea to check the current network settings both before and after you change the Block outgoing caller ID option.

1. Press the Phone button  on your VisorPhone.
2. Tap the Menu icon .
3. Under Options, tap Call Preferences.
4. Enable the Block outgoing caller ID option.

Tap here to place
anonymous calls

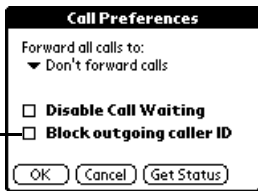



5. Tap OK.

Selecting a service provider network

If you roam to an area where multiple service providers offer coverage, your VisorPhone automatically selects the provider with the strongest signal. However, if you prefer, you can manually select a service provider network.

Note: When you manually select a network, your VisorPhone finds only that network until you either choose another network, or return to Automatic Mode.

1. Press the Phone button  on your VisorPhone.
2. Tap the Menu icon .
3. Under Options, tap Select Network.
4. Select a network.

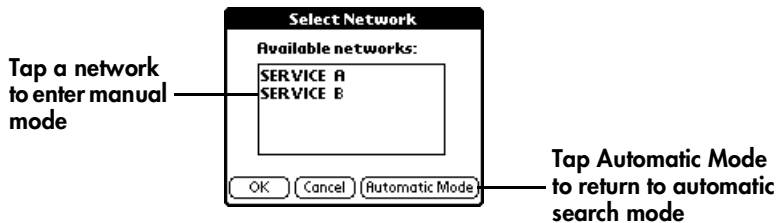

5. Tap OK.

Note: Selecting a new network may take 30 seconds or more.

Connecting a headset

Use the built-in speaker and microphone or connect an optional headset for hands-free operation. For best results, use only headsets from Handspring.

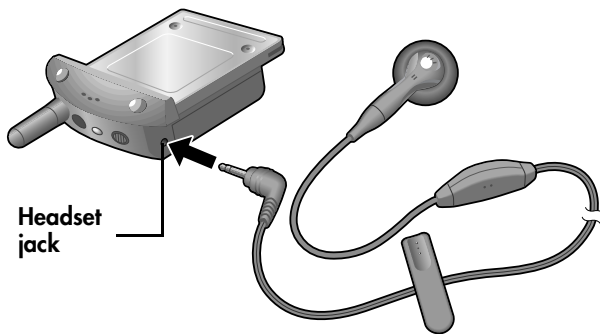

Using the Menus

This section provides an overview of the menu options available in the Phone, SIM Phonebook, and SMS Message Manager applications. Some of the menu options vary based on which screen is active.

Phone application Edit menus

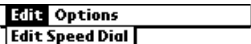

Speed Dial view

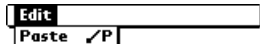

Dialpad view

Edit Speed Dial: Opens a dialog where you can define, change, and delete speed dial buttons. For details, see “Changing a speed dial entry” on page 40.

Paste: Inserts a phone number from the clipboard into the dial box.

Phone application Record menu

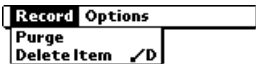

Call History view

Purge: Opens a dialog where you can remove selected records from the Call History list. For details, see “Purging call history” on page 36.

Delete Item: Removes the selected record from the Call History list.

Phone application Options menus

Speed Dial
and Dialpad
views

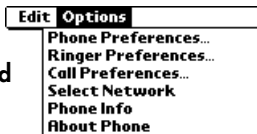

Call History
view

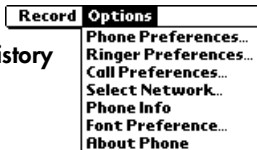

Phone Preferences: Opens a dialog where you can change your phone display and lock the phone. For details, see “Changing the phone display” on page 70 and see “Preventing unauthorized use of your phone” on page 72.

Ringer Preferences: Opens a dialog where you can choose the ringer settings. For details, see “Selecting the ringer settings” on page 71.

Call Preferences: Opens a dialog where you can choose call waiting, call blocking, and call forwarding settings. For details, see “Disabling call waiting” on page 74, “Blocking your phone number for outgoing calls” on page 75, and “Forwarding calls” on page 24.

Select Network: Opens a dialog where you can search for and use networks other than your default network. For details, see “Selecting a service provider network” on page 76.

Phone Info: Opens a dialog where you can view information about your phone such as the phone number and the IMEI number that uniquely identifies your phone to the network.

Font Preference: Opens a dialog where you can choose the font you want.

About Phone: Opens a dialog where you can view version and copyright information for the Phone application.

SIM Phonebook application Edit menu

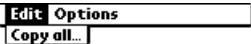

Speed Dial and SIM views

Copy All: Copies all entries that exist in one phone list to the other phone list. If you are viewing the speed dial list, it copies all new entries to your SIM card. If you are viewing the SIM card list, it copies all new entries to the speed dial list.

SIM Phonebook application Options menu

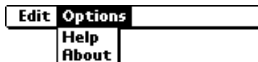

Speed Dial and SIM views

Help: Opens a dialog where you can view tips about using the SIM Phonebook application.

About: Opens a dialog where you can view version and copyright information for the SIM Phonebook application.

SMS Message Manager application Message menus

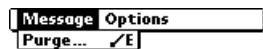

Inbox view

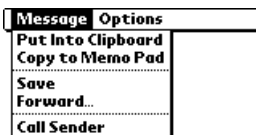

Message view

Purge: Opens a dialog where you can choose which messages you want to remove from the Inbox. For details, see “Deleting messages” on page 60.

Put Into Clipboard: Copies the selected message to the clipboard so you can paste it into another message or application. For details, see “Copying incoming messages” on page 57.

Copy to Memo Pad: Copies the selected message to a new Memo Pad memo. For details, see “Copying incoming messages” on page 57.

Save: Stores the selected message in the Saved category.

Forward: Creates a copy of the selected message so you can send it to someone else. For details, see “Forwarding incoming messages” on page 58.

Call Sender: Dials the person who sent the message.

SMS Message Manager application Edit menu

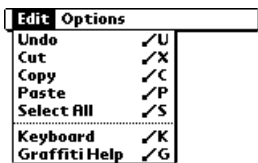

Undo: Clears the last action.

Cut: Removes the selected text and places it on the clipboard.

Copy: Copies the selected text and places it on the clipboard.

Paste: Inserts text stored on the clipboard at the current cursor position.

Select All: Selects all text in the current field.

Keyboard: Opens the onscreen keyboard.

Graffiti Help: Opens screens that show you how to form Graffiti characters.

SMS Message Manager application Options menu



Font: Opens a dialog where you can choose the font you want to use.

Greetings: Opens a dialog where you can enter predefined opening and closing phrases to use in your messages. For details, see “Creating message greetings and signatures” on page 56.

Preferences: Opens a dialog where you can view the SMS Service Center number (if this field is blank, contact your service provider for this information), choose deletion confirmation, and enter your service provider’s SMS Email Center number. For details, see “Enabling SMS and SMS Email” on page 50.

About SMS: Opens a dialog where you can view version and copyright information for the SMS Message Manager application.

Troubleshooting and Maintenance

If you encounter a problem with your VisorPhone module, check this section to see if your problem is listed. If your problem isn't listed here, or the suggestions don't resolve your problem, visit us at www.handspring.com for technical support contact information.

My VisorPhone won't turn on

- Make sure your VisorPhone is inserted firmly in the Springboard expansion slot.
- Make sure your VisorPhone battery isn't drained.
- When you turn on your VisorPhone, hold down the power button for at least two seconds, until you hear a beep.
- Turn on your handheld to make sure that the handheld batteries aren't drained. Low batteries will prevent your VisorPhone from turning on.

I get a message that my SIM card is missing when I turn on my VisorPhone

- Make sure your SIM card is properly inserted. The metal contacts must face down (away from the battery), and the side with the corner cut must slide into the SIM slot first. For details, see “Step 2: Insert your SIM card into your VisorPhone” on page 3.
- Your SIM card may be damaged. Contact your service provider for a new card.

My VisorPhone requires an unlocking code (PIN), but I didn't set one

- Your service provider may have set the locking code before you received your VisorPhone. Enter the default unlocking code (PIN) and then tap OK. In North America, the default unlocking code is usually 1234 or 1111. If this doesn't work, contact your service provider.

Note: It is actually your SIM card that is locked, not your VisorPhone.

- If you see the *Unblock* Phone screen instead of the *Unlock* Phone screen, you entered the *unlock* code (PIN) incorrectly three times, and your VisorPhone is now blocked. Contact your service provider to obtain the unblock code. If you enter the *unblock* code (PUK) incorrectly ten times, your SIM is permanently disabled.

I called my service provider to enable my phone service, but it still doesn't work

Some service providers require 24 hours or more to activate your phone service. If it has been longer than your service provider's activation period, report the problem to your service provider.

My phone number isn't on the Phone Info screen

Your service provider may need to install your phone number onto your SIM card. Contact your service provider to see if they can send a message to your VisorPhone that writes your phone number onto your SIM card.

My VisorPhone won't register to the network

- You are probably outside a network coverage area. Try using another GSM phone to verify whether coverage is available in your current location.
- If coverage is available in your location, try your SIM card in another GSM phone. If it still doesn't, work, your SIM card may be malfunctioning. Contact your service provider for another SIM card.
- Turn off your VisorPhone, and then turn it on again. If a dialog appears asking if you want to search for a network, tap Yes.

I tried dialing a phone number, but my VisorPhone just beeps at me

- Make sure you dialed the correct number.
- Wait a few minutes and try again. If the network is very busy, calls cannot connect.
- Verify that you are in a network coverage area and then move a few yards away and try the call again. If you are in a weak coverage area (1 bar of signal strength or less), you may not be able to complete calls even though you are registered to the network.

I can't dial international numbers

For security purposes, most service providers require you to enable international calling on your account. Call your service provider to enable international calling.

Call waiting doesn't work

Enable call waiting in the Call Preferences dialog. For details, see “Disabling call waiting” on page 74.

Call forwarding doesn't work

For security purposes, most service providers require you to enable this feature on your account even though there is usually no extra charge. Call your service provider to enable call forwarding.

Caller ID blocking for my outgoing calls doesn't work

Some service providers require you to enable this feature on your account. Call your service provider to enable blocking your Caller ID.

Some incoming caller's names don't appear in Call History

- Find out if a caller has blocked their Caller ID.
- Call History does not show names for records you marked hidden in your Address Book.

The SIM Phonebook application won't open

Make sure your SIM card is inserted in your VisorPhone and that your phone has been on for at least 30 seconds.

My SIM Phonebook doesn't display the full name and number

When a name or number is longer than will fit in the SIM Phonebook display, three dots appear to indicate that the entry contains additional information. SIM Phonebook does not truncate the actual entry, it just does not appear on the screen.

Some phone numbers don't appear in the SMS Lookup

Make sure the number you want is identified as a mobile number in your Address Book. Only mobile phone numbers appear when you use the SMS Message Manager Lookup button.

I can't send SMS Messages

- Make sure SMS services are enabled on your account by checking the SMS Preferences dialog to see if the SMS Message Center number is on this screen. If the number is missing, contact your service provider for the SMS Message Center number and enter it in the SMS Preferences dialog.

Note: Receiving SMS messages does not indicate that you have a subscription to your service provider's SMS service. You must subscribe to this service to send or reply to messages.

- Verify that you are in a GSM coverage area.
- Make sure the destination number is correct. Some service providers require 11-digit phone numbers for SMS messages.

I get an error message when I send an SMS message to an email address

Make sure you have subscribed to and enabled the SMS email feature. You need to get the SMS Email Center number from your service provider and enter it in the SMS Preferences dialog. This number is different from the SMS Message Center number you use to send messages to other mobile phone numbers. For more information, see “Enabling SMS and SMS Email” on page 50.

The applications I assigned to the Dial, Email, and SMS buttons in the Dialing Address Book don't launch

- Check the Dial Preferences dialog in the Address Book to confirm the application is assigned to the Dial, Email, or SMS button. For details, see “Assigning dialing applications” on page 69.
- Contact the software developer for the application you want to use when you tap the button, and verify that the software is compatible with the new Dialing Address Book and the version of Palm OS your VisorPhone uses. To take advantage of these buttons, an application must contain special code that registers its capabilities to the Dialing Address Book.

I get a “No Carrier” error when making data calls

- Verify that data calls are enabled on your account.
- Verify that you are in a coverage area.

**I can't
synchronize
when my
VisorPhone is
connected to my
handheld**

Make sure that there are no active calls on your VisorPhone before you begin a HotSync operation. You cannot synchronize while you have an active call, and you cannot make or receive calls during a HotSync operation.

Caring for your VisorPhone module

- Keep your VisorPhone and its accessories out of the reach of small children.
- Keep your VisorPhone dry.
- Use your VisorPhone at normal temperatures between -20 degrees and 54.4 degrees Celsius (-4 degrees and 130 degrees Fahrenheit). Temperatures outside of this range may cause damage to your VisorPhone.
- Keep your VisorPhone away from dusty or dirty areas.
- Do not disassemble your VisorPhone.
- Do not use harsh detergents to clean your VisorPhone.
- Use only genuine Handspring accessories. Third party accessories are not guaranteed to function properly with your VisorPhone.
- Do not let the Springboard contacts on your VisorPhone come in direct contact with conductive or electronic objects.
- Do not short any contacts on your VisorPhone module or the Springboard connectors.

Caring for the battery

Your VisorPhone uses a 680mAh Lithium Ion battery. A fully-charged battery provides approximately 3 hours of talk time and more than 70 hours of standby time. Follow these guidelines to get the most from your battery:

- Do not disassemble the battery pack.
- If you are not using your VisorPhone for an extended period of time, disconnect the battery pack from the phone and store it in a cool, dry place; charge the battery at least once every six months when not in use.
- Never throw the battery pack into fire or expose it to extreme heat.
- If the battery pack ever becomes hot or smells odd, stop using it.
- If the battery pack becomes damaged and leaks liquid, stop using it and avoid skin contact with the leaking liquid.
- Use only a genuine Handspring battery pack. Third party battery packs are not guaranteed to function properly with your VisorPhone.
- Always replace the battery pack with the same type of pack. Using another type of battery pack may cause an explosion.
- Do not short any battery contacts or let the contacts come in direct contact with conductive or electronic objects.
- Be sure to properly dispose of the battery. For more information, see “How do I dispose of the battery?” on page 93.

How do I dispose of the battery?

When your battery fails to hold a charge, you need to replace it.

Caution: It is illegal in many areas to dispose of Lithium Ion batteries in household or business trash. Call your local recycling center for instructions on battery recycling, or contact Handspring for safe disposal options. Do not handle a damaged or leaking battery.

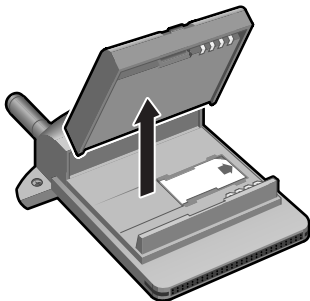

Warranty and Other Product Information

Handspring, Inc. Springboard Module End User Software License Agreement

THIS PRODUCT CONTAINS PRE-LOADED SOFTWARE, THE USE OF WHICH IS LICENSED BY HANDSPRING, INC. AND ITS SUPPLIERS (COLLECTIVELY, "HANDSPRING"), TO ITS CUSTOMERS FOR THEIR USE ONLY AS SET FORTH BELOW.

SOFTWARE LICENSE: Handspring grants you a nonexclusive license to use the software program(s) (the "Software") pre-loaded on this Product subject to the terms and restrictions set forth in this VisorPhone End User Software License Agreement ("License Agreement"). You are not permitted to lease or rent, distribute or sublicense the Software or to use the Software in a time-sharing arrangement or in any other unauthorized manner. Further, no license is granted to you in the human readable code of the Software (source code). Except as provided below, this License Agreement does not grant you any rights to patents, copyrights, trade secrets, trademarks, or any other rights in respect to the Software. The Software is licensed to be used solely as pre-loaded on the Product and solely in connection with Handspring products. Otherwise, the Software and supporting documentation may be copied only as essential for backup or archive purposes in support of your use of the Software as permitted hereunder. You must reproduce and include all copyright notices and any other proprietary rights notices appearing on the Software on any copies that you make.

PAYMENT OF FEES: The effectiveness of the licenses granted hereunder is conditioned on the receipt by Handspring of any applicable fees.

NO ASSIGNMENT; NO REVERSE ENGINEERING: You may transfer the Software and this License Agreement to another party in connection with a transfer of the Product on which the Software is pre-loaded, if the other party agrees in writing to accept the terms and conditions of this License Agreement. If you transfer the Software, you must at the same time either transfer all copies of the Software as well as the supporting documentation to the same party or destroy any such materials not transferred. Except as set forth above, you may not transfer or assign the Software or your rights under this License Agreement. Modification, reverse engineering, reverse compiling, disassembly, or removal of the Software from the Product on which it is pre-loaded is expressly prohibited. However, if you are a European Union ("EU") resident, information necessary to achieve interoperability of the Software with other programs within the meaning of the EU Directive on the Legal Protection of Computer Programs is available to you from Handspring upon written request.

EXPORT RESTRICTIONS: You agree that you will not export or re-export the Software or accompanying documentation (or any copies thereof) or any products utilizing the Software or such documentation

in violation of any applicable laws or regulations of the United States or the country in which you obtained them. The software covered by this License Agreement may contain strong data encryption code which cannot be exported outside of the U.S. or Canada. You agree that you will not export/re-export, either physically or electronically, the encryption software or accompanying documentation without obtaining written authorization from the U.S. Department of Commerce.

UNITED STATES GOVERNMENT LEGEND: If you are acquiring the Software on behalf of any unit or agency of the United States Government, the following provisions apply. The Software constitutes a "commercial item", as that term is defined at Federal Acquisition Regulation (FAR) 2.101 (Oct. 1995), consisting of "commercial computer software" and "commercial computer software documentation", as such terms are used in FAR 12.212 (Sept. 1995), and is provided to the U.S. Government only as commercial software (with "Restricted Rights", if applicable). Use, duplication, or disclosure by the U.S. Government is subject to restrictions set forth in this License Agreement and as provided in DFARS 227.7202-1(a) and 227.7202-3(a) (1995), DFARS 252.227-7013(c)(1)(ii) (OCT 1988), FAR 12.212(a) (1995), FAR 52.227-19, or FAR 52.227-14 (ALT III), as applicable.

TERM AND TERMINATION: This License Agreement is effective until terminated. You may terminate it at any time by destroying the Software and documentation together with all copies and merged portions in any form. It will also terminate immediately if you fail to comply with any term or condition of this License Agreement. Upon such termination you agree to destroy the Software and documentation, together with all copies and merged portions in any form.

GOVERNING LAW: This License Agreement shall be governed by the laws of the State of California as such laws are applied to agreements entered into and to be performed entirely within California between California residents and by the laws of the United States. You agree that the conflicts of laws principles of such laws and the United Nations Convention on Contracts for the International Sale of Goods (1980) are hereby excluded in its entirety from application to this License Agreement.

LIMITED WARRANTY; LIMITATION OF LIABILITY: All warranties and limitations of liability applicable to the Software are as stated on the Limited Warranty or in the product manual accompanying the Software. Such warranties and limitations of liability are incorporated herein in their entirety by this reference.

SEVERABILITY: In the event any provision of this License Agreement is found to be invalid, illegal or unenforceable, the validity, legality and enforceability of any of the remaining provisions shall not in any way be affected or impaired and a valid, legal and enforceable provision of similar intent and economic impact shall be substituted therefor.

ENTIRE AGREEMENT: This License Agreement sets forth the entire understanding and agreement between you and Handspring, supersedes all prior agreements, whether written or oral, with respect to the Software, and may be amended only in a writing signed by both parties.

Handspring, Inc. Limited Warranty for Accessories

LIMITED WARRANTY: Handspring, Inc. ("Handspring"), warrants to the original end user ("Customer") that under normal intended use (i) Handspring hardware accessories will be free from defects in workmanship and materials for one year from the date of purchase, and (ii) Handspring software accessories will substantially conform to their specifications and the media containing the software will be free from defects in workmanship and materials, for ninety (90) days from the date of purchase. Handspring does not provide any warranty for any third party software. During the warranty period, Handspring shall either repair, replace or refund the purchase price of defective accessories.

Handspring and its suppliers shall not be liable for any losses or damages of any kind resulting from the use of this accessory or for any of Customer's software or data stored on accessories returned to Handspring for service.

WARRANTY SERVICE: Customer must obtain warranty service authorization from Handspring within the applicable warranty period before returning defective accessories to Handspring. Returned accessories must be shipped prepaid and packaged appropriately, and it is recommended that they be insured or sent by a method that provides for tracking of the package. If Handspring ships a replacement accessory to Customer before receiving the original accessory and Customer fails to return the original accessory to Handspring within thirty (30) days from the date the warranty service authorization is issued, Handspring will charge Customer the then current published catalogue price of such accessory.

LIMITATIONS: THIS LIMITED WARRANTY IS IN LIEU OF ALL OTHER WARRANTIES, TERMS, OR CONDITIONS; INCLUDING WARRANTIES, TERMS, OR CONDITIONS OF MERCHANTABILITY, FITNESS FOR A PARTICULAR PURPOSE, SATISFACTORY QUALITY, CORRESPONDENCE WITH DESCRIPTION, AND NON INFRINGEMENT, ALL OF WHICH ARE EXPRESSLY DISCLAIMED BY HANDSPRING AND ITS SUPPLIERS. IN NO EVENT WILL HANDSPRING OR ITS SUPPLIERS BE LIABLE FOR ANY SPECIAL, INCIDENTAL, CONSEQUENTIAL, OR INDIRECT DAMAGES RESULTING FROM THE POSSESSION, USE, OR FAILURE OF THIS ACCESSORY.

Some countries, states, or provinces do not allow the exclusion or limitation of implied warranties or the limitation of incidental or consequential damages or the limitation of liability for personal injury, so the above limitations and exclusions may be limited in their application to you. When the implied warranties are not allowed to be excluded in their entirety, they will be limited to the duration of the applicable written warranty. This warranty gives you specific legal rights which may vary depending on local law.

Handspring, Inc. Springboard-modul Endnutzer-softwarelizenzvereinbarung

DIESES PRODUKT ENTHÄLT VORINSTALLIERTE SOFTWARE, DEREN VERWENDUNG VON HANDSPRING, INC. UND SEINEN LIEFERANTEN (IM FOLGENDEN „HANDSPRING“ GENANNT) AN SEINE KUNDEN FÜR DEREN PERSÖNLICHEN GEBRAUCH - AUSSCHLIESSLICH WIE UNTEN AUSGEFÜHRT - LIZENZIERT IST.

SOFTWARELIZENZ: Handspring gewährt Ihnen eine einfache Lizenz für die Verwendung des/der Softwareprogramms/Softwareprogramme (im nachfolgenden „Software“ genannt), das/die auf diesem Produkt vorinstalliert ist/sind, gemäß den Bestimmungen und Beschränkungen dieses VisorPhone Endnutzer-Softwarelizenzvertrags (im nachfolgenden „Lizenzvertrag“ genannt). Sie sind nicht befugt, die Software zu verleasen oder zu vermieten, zu vertreiben oder Unterlizenzen zu vergeben. Zudem ist es Ihnen nicht gestattet, die Software im Rahmen einer Timesharing Vereinbarung oder in sonstiger nicht autorisierter Weise zu (be-)nutzen. Darüber hinaus erhalten Sie keine Lizenz für den Quellcode der Software. Abgesehen von den unten ausgeführten Bestimmungen werden Ihnen keine Rechte an Patenten, Urheberrechten, Geschäftsgeheimnissen, Warenzeichen oder anderen Rechten bezüglich der Software eingeräumt. Die Software darf nur so wie auf diesem Produkt vorinstalliert und nur in Verbindung mit Handspring-Produkten verwendet werden. Die Software und das Begleitmaterial dürfen nur kopiert werden, soweit dies aus Datensicherungs- oder Archivierungsgründen zur Nutzung der Software gemäß den hier dargelegten Bestimmungen zwingend erforderlich ist. Sie müssen alle in der Software enthaltenen Urheberrechtshinweise und alle Markenrechtshinweise in die von Ihnen erstellten Kopien aufnehmen und die Hinweise auf den Kopien wiedergeben.

GEBÜHREN: Die hiermit gewährte Lizenz wird mit Erhalt der Zahlung aller anwendbaren Gebühren durch Handspring wirksam.

KEINE ABTRETUNG, KEINE RÜCKENTWICKLUNG: Sie dürfen die Software und diesen Lizenzvertrag im Rahmen einer Übertragung des Produkts, auf dem die Software vorinstalliert ist, an Dritte übertragen, wenn diese sich schriftlich mit den Bestimmungen dieses Lizenzvertrags einverstanden erklären. Wenn Sie die Software übertragen, müssen Sie gleichzeitig auch entweder alle Kopien sowie das Begleitmaterial an dieselbe Partei übertragen oder aber das nicht übertragene Material vernichten. Abgesehen von der obengenannten Regelung dürfen Sie die Software oder Ihre Rechte im Rahmen dieses Lizenzvertrags nicht abtreten oder übertragen. Jede Veränderung, Rückentwicklung, Dekompilierung, Disassemblierung oder Entfernung der Software von dem Produkt, auf dem die Software vorinstalliert ist, ist ausdrücklich verboten. Wenn sich jedoch Ihr Wohnsitz im Gebiet der Europäischen Union („EU“) befindet, können Sie Informationen, die zur Herstellung der Interoperabilität der Software mit anderen Programmen im Sinne der EU-Richtlinie zum rechtlichen Schutz von Computerprogrammen benötigt werden, auf schriftliche Anfrage von Handspring erhalten.

EXPORTBESCHRÄNKUNGEN: Sie erklären sich damit einverstanden, die Software und das Begleitmaterial (oder jegliche Kopien davon) bzw. Produkte, die die Software nutzen, nicht unter Verletzung geltender Gesetze und Bestimmungen der USA oder des Landes, in dem Sie sie erhalten haben, zu exportieren oder zu reexportieren. Die von diesem Lizenzvertrag betroffene Software enthält eventuell Datenverschlüsselungscode, der nicht aus den U.S.A. oder Kanada ausgeführt werden darf. Sie erklären sich damit einverstanden, die Verschlüsselungssoftware oder das Begleitmaterial ohne schriftliche Genehmigung des U.S. Department of Commerce weder gegenständlich noch elektronisch zu exportieren oder zu reexportieren.

RECHTLICHE BESCHRÄNKUNGEN FÜR REGIERUNGSBEHÖRDEN DER USA: Wenn Sie die Software im Auftrag einer Abteilung oder Dienststelle der Regierungsbehörden der USA beschaffen, gelten die folgenden Bestimmungen. Die Software stellt eine „kommerzielle Ware“ gemäß FAR 2.101 (Okt. 1995) dar, bestehend aus „kommerzieller Computer-Software“ und „Dokumentation für kommerzielle Computer-Software“ entsprechend FAR 12.212 (Sept. 1995), und wird den Regierungsbehörden der USA nur als kommerzielle Software (ggf. mit „Eingeschränkten Rechten“) zur Verfügung gestellt. Die Verwendung, Vervielfältigung oder Offenlegung durch die Regierungsbehörden der USA unterliegt den Bestimmungen dieser Lizenzvereinbarung und den rechtlichen Beschränkungen von DFARS 227.7202-1(a) und 227.7202-3(a) (1995), DFARS 252.227-7013(c)(1)(ii) (Okt. 1988), FAR 12.212(a) (1995), FAR 52.227-19 oder FAR 52.227-14 (ALT III), je nachdem, welche Bestimmungen anwendbar sind.]

GELTUNGSDAUER UND KÜNDIGUNG: Dieser Lizenzvertrag bleibt bis zu seiner Kündigung in Kraft. Sie können ihn jederzeit kündigen, indem Sie die Software und das Begleitmaterial zusammen mit allen Kopien und anhängenden Teilen, gleich welcher Form, zerstören. Darüber hinaus endet der Vertrag umgehend bei Verstoß gegen eine der Bestimmungen dieses Lizenzvertrags. Sie stimmen zu, bei einer solchen Beendigung die Software und das Begleitmaterial zusammen mit allen Kopien und anhängenden Teilen, gleich welcher Form, zu zerstören.

GELTENDES RECHT: Dieser Lizenzvertrag unterliegt dem Sachrecht des US-Bundesstaates Kalifornien und dem Bundesrecht der U.S.A. unter Ausschluß der Regelungen des Interlokalen und Internationalen Privatrechts sowie des Wiener UN-Kaufrechtsübereinkommens von 1980.

BESCHRÄNKTE GEWÄHRLEISTUNG; HAFTUNGSBESCHRÄNKUNG: Auf die Software sind die Garantiebestimmungen und Haftungsbeschränkungen, wie sie im Benutzerhandbuch aufgeführt sind, anwendbar. Diese Garantiebestimmungen und Haftungsbeschränkungen werden hiermit in ihrer Gesamtheit Bestandteil dieses Lizenzvertrags.

UNWIRKSAMKEIT EINZELNER BESTIMMUNGEN: Falls eine Bestimmung dieses Lizenzvertrags für unwirksam, illegal oder undurchsetzbar befunden wird, ist die Gültigkeit, rechtliche Zulässigkeit und Durchsetzbarkeit der übrigen Bestimmungen in keiner Weise betroffen oder beeinträchtigt.

GESAMTE VEREINBARUNG: Dieser Lizenzvertrag stellt die gesamte Vereinbarung und den gesamten Vertrag zwischen Ihnen und Handspring dar und ersetzt alle früheren schriftlichen oder mündlichen Ver-

träge, die für diese Software gelten, und kann nur in schriftlicher Form und nach Unterzeichnung durch beide Parteien abgeändert werden.

Handspring, Inc. Haftungsbeschränkung Und Beschränkte Gewährleistung Für Zubehör

HAFTUNGSBESCHRÄNKUNG: Handspring Inc. („Handspring“) ist gegenüber dem ursprünglichen Endnutzer („Kunden“) zur Einhaltung der zwingenden Bestimmungen des deutschen Gewährleistungsrechts verpflichtet. Die deutschen Gewährleistungsbestimmungen gelten mit folgenden Abweichungen:

Im Falle der Mangelhaftigkeit des Produkts oder eines Teils im Sinne des Gesetzes ist Handspring nach seiner Wahl dazu berechtigt, das Produkt oder Teil zu ersetzen oder zu reparieren. Bei Fehlschlägen der Ersatzlieferung oder Nachbesserung stehen dem Kunden weiterhin alle ihm gesetzlich zwingend zukommenden Rechte zu.

Jegliche Haftung für einen schuldhaft durch Handspring verursachten Schaden wird hiermit ausgeschlossen, soweit ein solcher Schaden nicht durch Handspring zuzurechnende grobe Fahrlässigkeit oder Vorsatz verursacht worden ist und soweit es sich bei einem solchen Schaden nicht um Tod oder Körperschaden handelt, welcher durch eine Handspring zuzurechnende Handlung oder Unterlassung verursacht wurde.

BESCHRÄNKTE GEWÄHRLEISTUNG FÜR ZUBEHÖR: Zusätzlich zu den zwingenden Bestimmungen des deutschen Gewährleistungsrechts, die unter den oben aufgeführten Einschränkungen anwendbar sind, gewährt Handspring die im folgenden dargestellte Garantie:

Handspring übernimmt gegenüber dem Kunden die Garantie, daß bei gewöhnlichem, zweckbezogenen Gebrauch (i) Handspring-Hardwarezubehör für den Zeitraum von einem Jahr ab Kaufdatum frei von Verarbeitungs- und Materialfehlern ist und daß (ii) Handspring-Softwarezubehör im wesentlichen seiner Beschreibung entspricht und die Datenträger, auf denen die Software enthalten ist, für einen Zeitraum von neunzig (90) Tagen ab Kaufdatum frei von Verarbeitungs- und Materialfehlern sind. Handspring übernimmt keine Garantie für Software von Drittanbietern. Während der Garantiezeit wird defektes Zubehör von Handspring entweder repariert, ersetzt oder aber der Kaufpreis dafür rückerstattet.

HANDSPRING UND SEINE LIEFERANTEN HAFTEN WEDER FÜR VERLUSTE ODER SCHÄDEN, GLEICH WELCHER ART, DIE AUS DEM GEBRAUCH DIESES ZUBEHÖRS ENTSTEHEN, NOCH FÜR KUNDENSOFTWARE ODER -DATEN, DIE AUF ZUBEHÖR ENTHALTEN SIND, DAS FÜR REPARATUREN AN HANDSPRING GESCHICKT WIRD, SOWEIT EIN SOLCHER VERLUST ODER SCHADEN NICHT DURCH HANDSPRING ZUZURECHNENDE GROBE FAHRLÄSSIGKEIT ODER VORSATZ VERURSACHT WORDEN IST UND SOWEIT ES SICH BEI EINEM SOLCHEN SCHADEN NICHT UM TOD ODER KÖRPERSCHADEN HANDELT, WELCHER DURCH EINE HANDSPRING ZUZURECHNENDE HANDLUNG ODER UNTERLASSUNG VERURSACHT WURDE.

WAHRNEHMUNG VON GARANTIELEISTUNGEN, RÜCKGABE FEHLERHAFTEN ZUBEHÖRS UND VERSPÄTETE RÜCKGABE FEHLERHAFTEN ZUBEHÖRS: Der Kunde muß innerhalb der geltenden Garantiezeit eine Garantiezusage von Handspring einholen, bevor defektes Zubehör an Handspring zurückgeschickt wird. Das eingesandte Material muß mit Rückporto versehen und angemessen verpackt sein. Es wird außerdem empfohlen, das Zubehör zu versichern oder eine Versandart zu wählen, die die Rückverfolgung des Pakets ermöglicht. Wenn Handspring Ersatzzubehör an den Kunden liefern läßt, bevor Handspring das Originalzubehör erhalten hat, und der Kunde das Originalzubehör nicht innerhalb von dreißig (30) Tagen nach Erteilung der Garantiezusage an Handspring zurücksendet, berechnet Handspring dem Kunden den zu diesem Zeitpunkt gültigen Katalogpreis des entsprechenden Zubehörs.

VERBRAUCHERINFORMATION: In einigen Staaten, Ländern, oder Provinzen ist der Ausschuß oder die Beschränkung der gesetzlichen Gewährleistungsbestimmungen bzw. die Haftungsbeschränkung hinsichtlich zufälliger Schäden oder hinsichtlich Folgeschäden oder hinsichtlich Körperverletzungen nicht zulässig, so daß die oben vorgenommene Haftungs- und Gewährleistungsbeschränkung auf Sie möglicherweise keine Anwendung findet. Diese Gewährleistungserklärung verleiht Ihnen bestimmte Rechte, die je nach anwendbarem Recht verschieden sein können

Handspring, Inc. Contrat De Licence Utilisateur Final Du Module Springboard

CE PRODUIT CONTIENT UN LOGICIEL PRECHARGE, DONT L'UTILISATION EST REGIE PAR UNE LICENCE ACCORDEE PAR HANDSPRING, INC. ET SES FOURNISSEURS (COLLECTIVEMENT, « HANDSPRING ») A SES CLIENTS POUR LEUR SEULE UTILISATION, DANS LES CONDITIONS ENONCEES CI-APRES.

LICENCE DE LOGICIEL : Handspring vous accorde une licence non exclusive d'utilisation du ou des programme(s) (le « Logiciel ») préchargé(s) sur ce Produit conformément aux termes et restrictions du présent Contrat de licence de logiciel pour Utilisateur Final de la VisorPhone (le « Contrat de licence »). Vous n'êtes pas autorisé à donner en location, ni à louer, distribuer ou accorder de sous-licences du Logiciel, ni à l'utiliser en temps partagé ou de quelque autre façon non autorisée. En outre, aucune licence ne vous est accordée sur le code source du Logiciel. Sous réserve des droits qui vous sont concédés ci-dessous, le présent Contrat de Licence ne vous confère aucun droit sur les brevets, droits d'auteur, secrets de fabrique, marques commerciales, ou autres droits afférents au Logiciel. Vous devez utiliser le Logiciel uniquement avec le Produit dans lequel il est préchargé et seulement en connexion avec les produits Handspring. D'autre part, le Logiciel et la documentation qui l'accompagne ne peuvent être copiés qu'à des fins de sauvegarde ou d'archivage dans le cadre d'une utilisation conforme aux termes du présent Contrat. Vous devez reproduire et inclure sur toutes les copies que vous effectuez toutes les mentions de droits d'auteur et de droits de propriété figurant sur le Logiciel.

REDEVANCE DE LICENCE : La prise d'effet des licences accordées en vertu du présent Contrat est soumise au versement à Handspring des redevances applicables.

INTERDICTION DE CESSION ET D'INGENIERIE INVERSE : Vous êtes autorisé à transférer le Logiciel et le présent Contrat de licence à un tiers avec le Produit sur lequel il est préchargé, à condition que ledit tiers s'engage par écrit à respecter les termes et conditions du présent Contrat de Licence. Si vous procédez à un tel transfert, vous devez fournir toutes les copies du Logiciel et de la documentation qui l'accompagne au tiers à qui vous transférez le Logiciel ou détruire tout élément non transféré. Sous réserve des dispositions qui précèdent, le présent Contrat ne vous autorise pas à transférer ou céder le Logiciel ou vos droits résultant du présent Contrat Il vous est expressément interdit de modifier, d'effectuer de l'ingénierie inverse, de décompiler, de désassembler, ou retirer le Logiciel du Produit sur lequel il est préchargé. Toutefois, si vous êtes un résident de l'Union européenne (« UE »), vous pouvez demander par écrit à Handspring les informations nécessaires à l'interopérabilité du Logiciel avec d'autres programmes au sens de la directive européenne sur la protection légale des programmes d'ordinateur.

RESTRICTIONS A L'EXPORTATION : Vous vous engagez à ne pas exporter ou réexporter le Logiciel, ni la documentation qui l'accompagne (ou les copies de ces documents), ni les produits utilisant le Logiciel ou sa documentation en violation des lois ou réglementations applicables aux Etats-Unis ou dans le pays dans lequel vous les avez acquis. Le Logiciel régi par le présent Contrat peut contenir de fortes clés de chiffrement des données ne pouvant pas être exportées des Etats-Unis ou du Canada. Vous vous engagez à ne pas exporter/réexporter, physiquement ou électroniquement, le logiciel de chiffrement ou la documentation qui l'accompagne sans l'autorisation écrite préalable du U.S. Department of Commerce.

DISPOSITIONS RELATIVES AU GOUVERNEMENT DES ETATS-UNIS : Si vous faites l'acquisition du Logiciel pour le compte d'une entité du gouvernement des Etats-Unis, les dispositions suivantes s'appliquent. Le Logiciel est un « article commercial », tel que défini par l'article 2.101 (Oct. 1995) du FAR (Federal Acquisition Regulation) et se compose du « Logiciel informatique commercial » et de la « Documentation pour logiciel informatique commercial », telles que ces expressions sont utilisées dans les articles 12.212 (Sept. 1995) du FAR, et est fourni au gouvernement des Etats-Unis uniquement en tant qu'article commercial (avec des « Droits restreints », le cas échéant). L'utilisation, la reproduction, ou la divulgation par le gouvernement des Etats-Unis est soumise aux restrictions prévues dans le présent Contrat de licence et les articles DFARS 227.7202-1 (a) et 227.7202-3 (a) (1995), DFARS 252.227-7013 (c)(1)(ii) (OCT 1988), FAR 12.212 (a) (1995), FAR 52.227-19, ou l'article FAR 52.227-14 (ALT III), selon le cas.

DISPOSITIONS ET RESILIATION : Le présent Contrat de licence demeurera en vigueur jusqu'à sa résiliation. Vous pouvez le résilier à tout moment en détruisant le Logiciel et sa documentation ainsi que toutes les copies et les éléments qui y sont intégrés. Ce Contrat sera résilié de plein droit si vous ne respectez pas un de ses termes ou conditions. En cas de résiliation vous vous engagez à détruire le Logiciel et sa documentation ainsi que toutes les copies et les éléments qui y sont intégrés.

LOI APPLICABLE : Le présent contrat est régi par les lois en vigueur dans l'Etat de Californie. Vous reconnaissez que sont expressément exclus l'application des règles de conflit de lois mentionnées ci-dessus ainsi que celle de la Convention des Nations Unies relative aux contrats de vente internationale de marchandises (1980).

LIMITATION DE GARANTIE ; LIMITATION DE RESPONSABILITE : Toutes les garanties et limitations de responsabilité applicables au Logiciel sont mentionnées dans la Limitation de Garantie ou le manuel accompagnant le Logiciel. Lesdites garanties et limitations sont incorporées par référence au présent Contrat. Ces limitations ne s'appliqueront que dans les limites de la loi applicable. En tout état de cause la garantie légale s'appliquera si le client est un consommateur au sens défini par le code français de la consommation.

NULLITE PARTIELLE : Si une disposition du présent Contrat est jugée non valable, illégale ou inopposable, les autres dispositions ne seront pas affectées, et ladite disposition sera remplacée par une disposition légale et opposable ayant une portée et un impact économique similaires.

INTEGRALITE DU CONTRAT : Le présent Contrat de licence constitue l'intégralité du Contrat vous liant à Handspring. Il annule et remplace tout accord antérieur, écrit ou oral, relatif au Logiciel, et ne peut être modifié que par un document écrit signé par les deux parties.

Handspring, Inc. Limitation De Garantie Concernant Les Accessoires

GARANTIE LIMITEE : Handspring, Inc. (« Handspring »), garantit à l'utilisateur final initial (le « Client ») que, dans des conditions d'utilisation normale, (i) les accessoires des matériels Handspring seront exempts de défauts matériels et de fabrication pendant une période d'un an à compter de la date d'acquisition, et que (ii) les accessoires des logiciels Handspring seront pour l'essentiel conformes aux spécifications et que les supports du Logiciel seront exempts de défauts matériels ou de fabrication, pendant une période de quarante-dix (90) jours à compter de la date d'acquisition. Handspring n'accorde aucune garantie en ce qui concerne des logiciels tiers. Pendant la période de garantie, Handspring pourra à son choix réparer, remplacer ou rembourser le prix d'achat des accessoires défectueux.

Handspring et ses fournisseurs ne pourront être tenus pour responsables des pertes ou dommages d'aucune sorte résultant de l'utilisation de cet accessoire ou subis par tout logiciel ou données du Client stockés sur des accessoires retournés à Handspring pour des prestations de service.

GARANTIE DE SERVICES : Le Client doit obtenir pendant la période de garantie applicable une autorisation de fourniture de service auprès de Handspring préalablement au retour des accessoires défectueux. Lesdits accessoires doivent être expédiés port payé et correctement emballés. Il est recommandé de les assurer ou de les expédier via un mode de transport permettant le suivi du colis. Si Handspring expédie un accessoire de remplacement au Client avant de recevoir l'accessoire original et que le Client ne renvoie pas celui-ci dans les trente (30) jours à compter de la date d'autorisation de fourniture de service dans le cadre de la garantie, Handspring facturera au Client le prix de l'accessoire mentionné dans le catalogue en vigueur.

LIMITATIONS : LA PRESENTE GARANTIE LIMITEE REMPLACE LES AUTRES GARANTIES, TERMES OU CONDITIONS ; Y COMPRIS LES GARANTIES, TERMES OU CONDITIONS DE QUALITE, DE CONVENANCE A UN USAGE PARTICULIER, DE QUALITE SATISFAISANTE,

DE CONFORMITE A LA DESCRIPTION ET DE NON CONTREFACON, LESQUELLES SONT EXPRESSEMENT EXCLUES PAR HANDSPRING ET SES FOURNISSEURS. HANDSPRING OU SES FOURNISSEURS NE SAURAIENT EN AUCUN CAS ETRE TENUS POUR RESPONSABLES DES DOMMAGES SPECIAUX, INCIDENTS, CONSECUTIFS OU INDIRECTS RESULTANT DE LA POSSESSION, DE L'UTILISATION DE L'ACCESSOIRE, OU D'UNE DEFAILLANCE DE CE-LUI-CI.

Certains pays, États ou provinces ne permettent pas l'exclusion ou la limitation de garanties implicites ou responsabilité pour dommages consécutifs ou préjudice corporel. Les limitations et exclusions mentionnées ci-dessus ne vous sont donc peut-être pas applicables. Lorsque les garanties implicites ne peuvent pas être exclues dans leur intégralité, elles ne sont valables que pendant la durée de la garantie écrite applicable. Cette garantie vous confère des droits légaux spécifiques qui peuvent varier en fonction du droit local applicable.

Handspring, Inc. Contrato De Licencia Para El Usuario Final Del Software Del Módulo Springboard

ESTE PRODUCTO CONTIENE SOFTWARE PREINSTALADO CUYO USO SE OTORGA BAJO LICENCIA DE HANDSPRING, INC. Y SUS PROVEEDORES (COLECTIVAMENTE DENOMINADO "HANDSPRING") AL CLIENTE, SEGUN LAS CONDICIONES QUE SE ESTABLECEN A CONTINUACION.

LICENCIA DEL SOFTWARE: Handspring le otorga una licencia no exclusiva para utilizar los programas de software (el "Software") preinstalados en este producto, sujeta a las condiciones y restricciones establecidas en este Contrato de licencia para el usuario final de la VisorPhone ("Contrato de licencia"). No se permite el arrendamiento, subarrendamiento, alquiler, distribución o transferencia de la licencia del Software a terceros, ni su uso en tiempo compartido o de cualquier modo no autorizado. Además, no se otorga ninguna licencia sobre el código legible del Software (código fuente). Salvo en las situaciones establecidas a continuación, este Contrato de licencia no le otorga ningún derecho sobre patentes, derechos de autor, secretos comerciales, marcas comerciales o cualquier otro tipo de derechos relativos al Software. La licencia del Software se concede sólo para su uso como programa preinstalado en el Producto y en conexión con otros productos de Handspring. El Software y la documentación adjunta sólo se podrán reproducir como copias de seguridad o para archivarlos durante las operaciones inherentes al uso del Software según lo establecido en este documento. Cada copia que haga deberá reproducir e incluir todas las notas de derechos de autor, así como cualquier otra nota de propiedad de derechos que aparezca en el Software.

PAGO DE DERECHOS: La efectividad de la licencia que se otorga por el presente documento está condicionada al pago de los derechos correspondientes a Handspring.

LIMITACIONES DE TRANSFERENCIA E INGENIERÍA INVERSA: Sólo se podrá transferir el Software y este Contrato de licencia a terceros si transfiere el Producto en el que se encuentre preinstalado el Software, siempre que la otra parte acepte por escrito los términos y condiciones de este Contrato de licencia.

Al transferirse el Software, deberán transferirse al mismo tiempo todas las copias del Software y la documentación adjunta al mismo destinatario o destruir cualquier material no transferido. Salvo en los casos establecidos anteriormente, no se podrá transferir o ceder el Software ni los derechos que otorga este Contrato de licencia. Están expresamente prohibidas la modificación, utilización de técnicas de ingeniería inversa, de compilación, desensamblaje o eliminación del Software del Producto en el que se encuentre preinstalado. No obstante, si usted es residente en la Unión Europea ("UE"), puede solicitar a Handspring por escrito la información necesaria para asegurar la interoperabilidad del Software con otros programas según lo descrito en la Directiva de la UE sobre protección legal de programas informáticos.

LIMITACIONES DE EXPORTACIÓN: Usted se compromete a no exportar o reexportar el Software y la documentación adjunta (o copias de los mismos) u otros productos que utilicen dicho Software y documentación si ello va contra las leyes y regulaciones correspondientes de los Estados Unidos o el país en que los adquirió. El Software cubierto por este Contrato de licencia puede contener códigos de cifrado de datos de alto nivel, que no se puede exportar fuera de los Estados Unidos o Canadá. Usted se compromete a no exportar o reexportar, ya sea por medios físicos o electrónicos, el software de cifrado o la documentación adjunta sin la autorización expresa y por escrito del Departamento de Comercio de los Estados Unidos (U.S. Department of Commerce).

DISPOSICIONES RELATIVAS AL GOBIERNO DE LOS ESTADOS UNIDOS: Si adquiere el Software en nombre de alguna entidad o agencia del gobierno de los Estados Unidos, se aplicarán las disposiciones siguientes. El Software constituye un "artículo comercial" (commercial item), según la definición del término descrita en la Regulación federal sobre adquisiciones (Federal Acquisition Regulation - FAR) 2.101 (Octubre de 1995), que consta de "programas informáticos comerciales" y "documentación de programas informáticos comerciales", según el uso de dichos términos en la FAR 12.212 (Septiembre de 1995), y se le proporciona al gobierno de los Estados Unidos sólo como software comercial (con "derechos limitados" si así se establece). Su uso, duplicación o divulgación por parte del gobierno de los Estados Unidos está sujeto a las limitaciones establecidas en este Contrato de licencia, de acuerdo con lo dispuesto en DFARS 227.7202-1(a) y 227.7202-3(a) (1995), DFARS 252.227-7013(c)(1)(ii) (OCT 1988), FAR 12.212(a) (1995), FAR 52.227-19 o FAR 52.227-14 (ALT III), según corresponda.

DURACIÓN Y FINALIZACIÓN: Este contrato de Licencia estará vigente hasta su finalización. Si se deseara terminarlo en un momento dado, deberá destruirse el Software y la documentación junto con todas las copias y partes combinadas por cualquier medio. El Contrato de licencia también finalizará en caso de incumplimiento de cualquier término o condición del mismo. En tal caso, usted se compromete a destruir el Software y la documentación, junto con todas las copias y partes combinadas por cualquier medio.

LEGISLACIÓN APLICABLE: Este Contrato de licencia se rige por las leyes del Estado de California tal como esas leyes se aplican a los contratos celebrados y ejecutados completamente en California por residentes de California según la legislación de los Estados Unidos. Usted acepta que queda excluida en su totalidad la aplicación de las normas sobre conflicto entre dichas leyes, así como la Convención de las Naciones Unidas sobre Contratos de Compra-Venta Internacional de Mercancías (1980) al presente Contrato de Licencia.

GARANTÍA LIMITADA Y LIMITACIONES DE RESPONSABILIDAD: Todas las garantías y limitaciones de responsabilidad correspondientes al Software se aplicarán según lo establecido en la Garantía Limitada o en el manual del producto que acompaña al Software. Dichas garantías y limitaciones de responsabilidad quedan incorporadas en su totalidad al presente Contrato por la referencia que aquí se hace a ellas.

VALIDEZ DE LAS CLÁUSULAS: : En caso de que alguna disposición de este Contrato de licencia resulte ser no válida, ilegal o no exigible, ello no afectará a la validez, legalidad y exigibilidad de ninguna de las disposiciones restantes. En tal caso, la disposición afectada se sustituirá por otra disposición válida, legal y exigible cuyos efectos e impactos económicos sean similares.

INTEGRIDAD DEL CONTRATO: Este Contrato de Licencia constituye el compromiso y acuerdo íntegro entre usted y Handspring, y sustituye y reemplaza cualesquiera acuerdos previos, ya sea oral o escrito, relativo al Software. Este contrato sólo se podrá modificar mediante un documento escrito firmado por ambas partes.

Handspring, Inc. Garantía Limitada Para Accesorios

GARANTÍA LIMITADA: Handspring, Inc. ("Handspring"), garantiza al usuario final ("Cliente") que, en condiciones de uso normales, (i) los accesorios de hardware de Handspring estarán libres de defectos en cuanto a materiales y mano de obra durante un año desde la fecha de compra y (ii) los accesorios de software de Handspring cumplirán sustancialmente las especificaciones indicadas y los soportes físicos del software estarán libres de defectos en cuanto a materiales y fabricación durante noventa (90) días a partir de la fecha de compra. Handspring no ofrece ninguna garantía para software de terceros. Durante el periodo de garantía, Handspring reparará, reemplazará o devolverá el importe de la compra de accesorios defectuosos.

Handspring y sus proveedores no son responsables de pérdidas o daños de cualquier tipo causados por el uso de este accesorio ni de software o datos del Cliente almacenados en los accesorios devueltos a Handspring.

SERVICIO DE GARANTÍA: Antes de devolver accesorios defectuosos a Handspring, el Cliente deberá obtener autorización del servicio de garantía de Handspring dentro del periodo de garantía correspondiente. Los accesorios devueltos deberán empaquetarse adecuadamente y su envío será a cargo del Cliente. Se recomienda asegurarlos o enviarlos mediante un método que permita su seguimiento. Si Handspring envía un accesorio de repuesto al Cliente antes de recibir el accesorio original y el Cliente no entrega dicho accesorio original a Handspring en treinta (30) días desde la fecha en que emitió la autorización de servicio de garantía, Handspring aplicará al Cliente el precio de dicho accesorio según se indique en el último catálogo publicado.

LIMITACIONES: ESTA GARANTÍA LIMITADA SUSTITUYE A TODAS LAS DEMÁS GARANTÍAS, TÉRMINOS Y CONDICIONES; INCLUYENDO GARANTÍAS, TÉRMINOS Y CONDICIONES DE COMERCIALIZACIÓN, IDONEIDAD PARA UN PROPÓSITO DETERMINADO, CALIDAD SATISFACTORIA, CORRESPONDENCIA CON LA DESCRIPCIÓN (EXCEPTO EN LA MEDIDA EN QUE ASÍ LO PREVEA LA LEGISLACIÓN LOCAL) E INCUMPLIMIENTOS, RE-

NUNCIANDO ESPRESAMENTE HANDSPRING Y SUS PROVEEDORES A OTORGAR NINGUNA DE LAS ANTERIORES GARANTÍAS, TÉRMINOS O CONDICIONES. HANDSPRING O SUS PROVEEDORES NO SERÁN RESPONSABLES EN NINGÚN CASO DE DAÑOS ESPECIALES, FORTUITOS, EMERGENTES O INDIRECTOS CAUSADOS POR LA POSESIÓN, USO O FALLOS DE ESTE ACCESORIO.

Algunos países, estados o provincias no permiten la exclusión o limitación de las garantías implícitas, la limitación de daños fortuitos y perjuicios derivados o la limitación de responsabilidad por daños personales y, por lo tanto, la aplicación de algunas de las limitaciones y exclusiones anteriores puede estar restringida. Si no está permitido excluir limitaciones implícitas en su totalidad, éstas se limitarán a la duración de la garantía escrita correspondiente. Esta garantía le otorga derechos legales específicos que pueden variar según las leyes locales.

Handspring, Inc. Springboard Module Contratto Di Licenza Software Per L'utente Finale

QUESTO PRODOTTO CONTIENE SOFTWARE PRE-CARICATO, L'USO DEL QUALE CONSENTITO IN BASE ALLA LICENZA DELLA HANDSPRING ED I SUOI FORNITORI (COMPLESSIVAMENTE, "HANDSPRING"), AI SUOI CLIENTI ESCLUSIVAMENTE PER LORO USO ED COME DI SEGUITO PREVISTO

LICENZA SOFTWARE: Handspring concede all'utente una licenza non esclusiva per usare il/i programma/i software (il "Software") pre-caricato in questo Prodotto in base ai termini e alle limitazioni previste nel presente Contratto di Licenza Software VisorPhone per l'Utente Finale ("Contratto di Licenza"). All'utente non è consentito concedere in noleggio, distribuire o concedere in sublicenza il Software o usare il Software in condivisione o in qualsiasi altro modo non autorizzato. Inoltre, all'utente non viene concessa alcuna licenza sul codice del Software leggibile da un operatore (codice sorgente). Salvo quanto di seguito previsto, il presente Contratto di Licenza non concede all'utente alcun diritto su brevetti, diritti d'autore, segreti commerciali, marchi commerciali o alcun altro diritto sul Software. Il Software viene concesso in licenza affinché venga usato esclusivamente come pre-caricato nel Prodotto ed esclusivamente in connessione con prodotti Handspring. Inoltre, il Software e la documentazione di supporto potranno essere copiati solo in quanto necessario per fini di backup o archivio, a supporto dell'uso del Software da parte dell'utente secondo quanto previsto. L'utente deve riprodurre e includere tutti gli avvisi sul diritto d'autore e qualsiasi altro diritto di proprietà che appaiono sul Software su qualsiasi copia che l'utente effettuerà.

PAGAMENTO DI CORRISPETTIVI: L'efficacia della licenza concessa è subordinata alla ricezione da parte della Handspring di ogni corrispettivo dovuto.

DIVIETO DI CESSIONE; DIVIETO DI REVERSE ENGINEERING: L'utente potrà cedere il Software e il presente Contratto di Licenza a terzi in connessione ad un trasferimento del Prodotto sul quale il Software è pre-caricato, a patto che i terzi si obblighino per iscritto ad accettare i termini e le condizioni del

presente Contratto di Licenza. Qualora l'utente trasferisca il Software, dovrà allo stesso tempo trasferire tutte le copie del Software così come la documentazione di supporto al cessionario o distruggere tale materiale che non venga trasferito. Salvo quanto sopra previsto, l'utente non potrà trasferire o cedere il Software o i suoi diritti derivanti dal presente Contratto di Licenza. Sono espressamente proibite la modifica, il reverse engineering, la decompilazione, il disassemblamento, o la rimozione del Software dal Prodotto sul quale lo stesso è pre-caricato. Tuttavia, qualora l'utente sia residente nell'Unione Europea ("EU"), le informazioni necessarie per ottenere l'interoperabilità del Software con altri programmi, secondo le previsioni della Direttiva EU sulla Tutela Legale dei Programmi per Computer, saranno rese disponibili all'utente dalla Handspring in base ad una richiesta scritta.

LIMITI ALL'ESPORTAZIONE: L'utente si obbliga a non esportare o ri-esportare il Software o la documentazione di accompagnamento (o qualsiasi copia degli stessi) o qualsiasi Prodotto che utilizzi il Software o tale documentazione, in violazione di qualsiasi legge o regolamento degli Stati Uniti o della nazione nella quale l'utente ha ottenuto gli stessi. Il software oggetto del presente Contratto di Licenza può contenere un particolare codice di crittografia di dati che non può essere esportato al di fuori degli Stati Uniti o del Canada. L'utente si obbliga a non esportare/ri-esportare, sia materialmente che informaticamente, il software di crittografia o la documentazione di accompagnamento senza aver ottenuto un'autorizzazione scritta del Dipartimento di Commercio degli Stati Uniti.

AVVISO PER IL GOVERNO DEGLI STATI UNITI: Qualora l'utente stia ottenendo il Software per conto di qualsiasi ente o istituzione del Governo degli Stati Uniti, si applicheranno le seguenti previsioni. Il Software costituisce "bene commerciale", come questo termine è definito dal Federal Acquisition Regulation (FAR) 2.101 (Oct. 1995), ed è costituito dal "software commerciale" e "documentazione su software commerciale", come questi termini vengono definiti nel FAR 12.212 (Sept. 1995), e viene fornito al Governo degli Stati Uniti solo come software commerciale (con "Limitazione di Diritti", qualora applicabili). L'uso, la duplicazione, o la rivelazione da parte del Governo degli Stati Uniti è subordinato alle limitazioni stabilite nel presente Contratto di Licenza e così come previsto nel DFARS 227.7202-1(a) e 227.7202-3(a) (1995), DFARS 252.227-7013(c)(1)(ii) (OCT 1988), FAR 12.212(a) (1995), FAR 52.227-19, o FAR 52.227-14 (ALT III), in quanto applicabili.

DURATA, RECESSO E RISOLUZIONE: Il presente Contratto di Licenza è a tempo indeterminato. L'utente potrà recedere dallo stesso in qualsiasi momento, distruggendo il Software e la documentazione insieme a tutte le copie e le parti unificate delle stesse in qualsiasi forma. Il presente Contratto di Licenza sarà automaticamente risolto "di diritto e senza necessità di una pronuncia giudiziale" qualora l'utente sia inadempiente ai seguenti termini o condizione del presente Contratto di Licenza: In caso di risoluzione, l'utente si obbliga a distruggere il Software e la documentazione, insieme a tutte le copie le parti unificate delle stesse in qualsiasi forma.

LEGGE APPLICABILE: Al presente Contratto di Licenza si applicherà la legge dello Stato della California. L'utente accetta che i principi sui conflitti di leggi applicabili contenuti in tale legge e la Convenzione

delle Nazioni Unite sulla Vendita Internazionale di Beni (1980) sono espressamente ed integralmente escluse dall'applicazione al presente Contratto di Licenza.

LIMITAZIONE DI GARANZIE; LIMITAZIONE DI RESPONSABILITÀ: Tutte le garanzie e le limitazioni di responsabilità applicabili al Software sono quelle indicate nella Limitazione di Garanzia o nel manuale del prodotto che accompagna il Software. Tali garanzie e limitazioni di responsabilità sono integralmente incorporate nel presente per riferimento. Tale limitazione si applicherà secondo quanto consentito dalla legge. In ogni caso, le garanzie di legge si applicheranno se l'utente è un consumatore, secondo la definizione del Codice dei Consumatori Francese.

NULLITA' PARZIALE: Nel caso in cui qualsiasi previsione del presente Contratto di Licenza sia ritenuta non valida, illegale o inefficace, la validità, legalità ed efficacia di ogni altra previsione non sarà in alcun modo pregiudicata o diminuita e una previsione valida, legale ed efficace con scopo ed impatto economico analogo dovrà essere inserita al suo posto.

INTERO ACCORDO: Il presente Contratto di Licenza stabilisce l'intero accordo tra l'utente e Handspring, sostituisce tutti i precedenti accordi, sia scritti che orali, relativi al Software, e potrà essere modificato solo per iscritto con sottoscrizione di entrambe le parti.

Handspring, Inc. Limitazione Di Garanzia Per Gli Accessori

LIMITAZIONE DI GARANZIE: Handspring garantisce all'originario utente ("Cliente") che in caso di uso normale e previsto (i) gli accessori hardware Handspring saranno privi di difetti di produzione e nei materiali per un anno dalla data di acquisto, e (ii) gli accessori software Handspring saranno sostanzialmente conformi alle loro caratteristiche e che i supporti che contengono il software saranno privi di difetti di produzione e nei materiali, per novanta (90) giorni dalla data di acquisto. Handspring non fornisce alcuna garanzia per il software di terzi. Durante il periodo di garanzia, Handspring riparerà, sostituirà o rimborserà il prezzo di acquisto degli accessori difettosi.

Salvo il caso di dolo o colpa grave, Handspring e i suoi fornitori non saranno responsabili per qualsiasi perdita o danni di alcun tipo derivanti dall'uso di questo accessorio o per qualsiasi software del Cliente o dati registrati su accessori restituiti a Handspring per il servizio di garanzia.

SERVIZIO DI GARANZIA: Il Cliente deve ottenere l'autorizzazione per il servizio di garanzia da Handspring entro il relativo servizio di garanzia prima di restituire gli accessori difettosi ad Handspring. Gli accessori restituiti devono essere inviati con spese di trasporto pre-pagate e opportunamente impacchettati, e si raccomanda che gli stessi siano assicurati o inviati con un metodo che consenta di rintracciare i pacchi. Quando Handspring invii un accessorio in sostituzione al Cliente prima di aver ricevuto l'accessorio originale ed il Cliente non restituisca l'accessorio originale a Handspring entro trenta (30) giorni dalla data in cui l'autorizzazione al servizio di garanzia è stata emessa, Handspring addebiterà al Cliente il prezzo di listino in vigore a tale data per tale accessorio.

LIMITAZIONI: LA PRESENTE LIMITAZIONE DI GARANZIA SOSTITUISCE TUTTE LE ALTRE GARANZIE, TERMINI, O CONDIZIONI, COMPRESI LE GARANZIE, TERMINI O CONDIZIONI DI IDONEITA' AL COMMERCIO, IDONEITA' AD UNO SCOPO PARTICOLARE, QUALITA', CORRISPONDENZA ALLA DESCRIZIONE, E NON VIOLAZIONE DI DIRITTI ALTRUI, LE QUALI VENGONO ESPRESSAMENTE ESCLUSE DA HANDSPRING ED I SUOI FORNITORI. SALVA L'IPOTESI DI DOLO O COLPA GRAVE, IN NESSUN CASO HANDSPRING O I SUOI FORNITORI SARANNO RESPONSABILI PER QUALSIASI DANNO SPECIALE, INCIDENTALE CONSEQUENZIALE O DIRETTO DERIVANTE DAL POSSESSO, USO, O MANCATO FUNZIONAMENTO DI QUESTO ACCESSORIO.

Alcuni paesi, stati o province non consentono l'esclusione o la limitazione di garanzie implicite o la limitazione di danni incidentali o consequenziali o la limitazione di responsabilità per lesioni personali, pertanto le limitazioni ed esclusioni di cui sopra potranno essere limitate nella loro applicazione all'utente. Nel caso in cui non sia consentita l'esclusione integrale delle garanzie implicite, le stesse saranno limitate alla durata della relativa garanzia scritta. La presente garanzia concede all'utente specifici diritti che possono variare in base alla normativa locale applicabile.

Safety and General Information

IMPORTANT INFORMATION ON SAFE AND EFFICIENT OPERATION. Read this information before using your integrated multi-service portable radio.

For the Safe and Efficient Operation of Your Radio, Observe These Guidelines:

Your radio product contains a transmitter and a receiver. When it is ON, it receives and transmits radio frequency (RF) energy. The radio operates in the frequency range of 800 MHz to 1990 MHz and employs digital modulation techniques. When you use your radio, the system handling your call controls the power level at which your radio transmits. The output power level typically may vary over a range from .001 Watts to 2 Watts.

Exposure to Radio Frequency Energy

Your VisorPhone Radio Product is designed to comply with the following national and international standards and guidelines regarding exposure of human beings to radio frequency electromagnetic energy:

- United States Federal Communications Commission, Code of Federal Regulations; 47 CFR part 2 sub-part J
- American National Standards Institute (ANSI) IEEE. C95. 1-1992
- National Council on Radiation Protection and Measurements (NCRP). Report 86
- International Commission on Non-Ionizing Radiation Protection (ICNIRP) 1998
- National Radiological Protection Board of the United Kingdom, GS 11, 1988
- Verband Deutscher Elektrotechniker (VDE) DIN-0848
- Department of Health and Welfare Canada. Safety Code 6

To comply with the above FCC Regulations governing human exposure to radio frequency energy, users **MUST** adhere to the following procedure:

- To comply with FCC RF exposure guidelines during body-worn operation, use the Handspring Belt Clip or the Handspring Holster. Use of other body worn accessories that have not been tested with the VisorPhone for RF exposure compliance may not comply.

To assure optimal radio performance, always adhere to the following procedures:

- When placing or receiving a phone call hold the radio as you would a telephone.
- Speak directly into the microphone and position the antenna up over your shoulder.
- **DO NOT** hold the antenna when the radio is "IN USE." Holding the antenna affects call quality and may cause the radio to operate at a higher power level than needed.

Interference to Medical and Personal Electronic Devices

Most electronic equipment is shielded from RF energy. However, certain equipment may not be shielded against the RF signals from your wireless phone.

Pacemakers

The Health Industry Manufacturers Association recommends that a minimum separation of six inches (6") be maintained between a handheld wireless phone and a pacemaker to avoid potential interference with the pacemaker. These recommendations are consistent with the independent research by the recommendations of Wireless Technology Research.

Persons with pacemakers should:

- ALWAYS keep the phone more than six inches from their pacemaker when the phone is turned ON.
- not carry the phone in a breast pocket.
- use the ear opposite the pacemaker to minimize the potential for interference.
- turn the phone OFF immediately if you have any reason to suspect that interference is taking place.

Hearing Aids

Some digital wireless phones may interfere with some hearing aids. In the event of such interference, you may want to consult your hearing aid manufacturer to discuss alternatives.

Other Medical Devices

If you use any other personal medical device, consult the manufacturer of your device to determine if it is adequately shielded from external RF energy. Your physician may be able to assist you in obtaining this information.

Turn your phone OFF in health care facilities when any regulations posted in these areas instruct you to do so. Hospitals or health care facilities may be using equipment that could be sensitive to external RF energy.

Interference to Other Electronic Devices

RF energy may affect improperly installed or inadequately shielded electronic operating and entertainment systems in motor vehicles. Check with the manufacturer or representative to determine if these systems are adequately shielded from external RF energy. Also check with the manufacturer of any equipment that has been added to the vehicle.

Turn your radio OFF before boarding any aircraft to prevent possible interference to aircraft systems. Regulations of the United States Federal Aviation Administration prohibit use when the aircraft is in the air and require you have permission from a crew member to use your radio while the aircraft is on the ground.

Safety and General Use While Driving

Check the laws and regulations on the use of telephones in the area where you drive. Always obey them.

When using the phone while driving, please:

- Give full attention to driving and to the road
- Use hands-free operation, if available
- Pull off the road and park before making or answering a call if driving conditions so require.

International Safety Statements

Aircraft Safety

Switch off your cellular telephone when in an aircraft. The use of cellular telephones in an aircraft may be dangerous to the operation of the aircraft, disrupt the cellular network and is illegal. Failure to observe this instruction may lead to suspension or denial of cellular services to the offender, or legal action or both.

Non-ionising Radiation

As with other mobile radio transmitting equipment, users are advised that for satisfactory operation of the equipment and for the safety of the personnel, it is recommended that no part of the human body be allowed to come too close to the antenna during operation of the equipment.

FCC Statement

This device complies with part 15 of the FCC rules. Operation is subject to the following two conditions: (1) This device may not cause harmful interference, and (2) this device must accept any interference received, including interference that may cause undesired operation.

Note: This equipment has been tested and found to comply with the limits for a Class B digital device, pursuant to Part 15 of the FCC rules. These limits are designed to provide reasonable protection against harmful interference in a residential installation. This equipment generates, uses, and can radiate radio frequency energy and, if not installed and used in accordance with the instructions, may cause harmful interference to radio communications. However, there is no guarantee that interference will not occur in a particular installation. If this equipment does cause harmful interference to radio or television reception, which can be determined by turning the equipment off and on, the user is encouraged to try to correct the interference by one or more of the following measures:

- Reorient or relocate the receiving antenna.
- Increase the separation between the equipment and receiver.
- Connect the equipment into an outlet on a circuit different from that to which the receiver is connected.
- Consult the dealer or an experienced radio/TV technician for help.

The use of shielded I/O cables is required when connecting this equipment to any and all optional peripheral or host devices. Failure to do so may violate FCC rules.

Caution: Changes or modifications not covered in this manual must be approved in writing by the manufacturer's Regulatory Engineering Department. Changes or modifications made without written approval may void the user's authority to operate this equipment.

Responsible Party:

Handspring, Inc.
189 Bernardo Avenue
Mountain View, California 94043-5203
United States of America
(650) 230-5000



Canadian RFI Statement

This Class B digital apparatus meets all requirements of the Canadian Interference-Causing Equipment Regulations.

Cet appareil numérique de la classe B respecte toutes les exigences du Règlement sur le matériel brouilleur du Canada.

Acknowledgments

We would like to thank the following developers whose contributions were an integral part of the Handspring product:

- OPTION International NV
Kolonel Begaultlaan 45
3012 Leuven
BELGIUM
Tel: +32 16 317 411
info@option.com
www.option.com



Index

Numerics

3-way calling 29

A

Active call 13, 25

Address Book

 adding from Call History 16

 adding to Speed Dial 39

 dialing from 17

 Dialing Preferences 69

Adjusting volume 6

Answering calls 21–23

Antenna 5

B

Battery

 care 92

 charging 8

 disposal 93

 gauge 13

 indicators 8

 inserting 4

 location 5

 specifications 92

Beep tone 23

Buttons

 Phone 6

 power 5

 ringer 6

 scroll 6, 15, 51

 slider 6

 SMS Message Manager 6

C

Call

 Preferences 23, 24, 74, 75, 80

 status 26, 28, 29

 waiting 23, 74

Call History 19

 adding to Address Book 16

 adding to Speed Dial list 16

 deleting items 36

 dialing from 16

 displaying 35

 icon 16

 incoming calls 35

 missed calls 19, 31, 32, 35

 outgoing calls 35

 purging 36

Caller ID 19, 22, 23, 34, 75

Calls

- 3-way 29
- active 13, 25
- answering 21–23
- answering call waiting 23
- conference 29
- forwarding 24
- ignoring 22
- incoming 21–24, 35
- missed 19, 32, 35
- outgoing 13–20, 35, 75
- placing a second 27
- placing from SIM Phonebook 47
- placing on hold 26
- switching 28

Conference calls 29

Coverage area 11, 19, 21, 24, 31, 53

D

Deleting

- Call History 36
- SIM card entries 46
- SMS messages 34, 53, 60
- Speed Dial entries 41

Dialing

- applications 69
- emergency numbers 20
- from Address Book 17
- from Call History 16, 32, 35
- from Memo Pad 18
- from SIM Phonebook 47
- from To Do List 18
- last number 16
- prefixes 68
- previous numbers 15, 16, 35
- with Dialpad 15
- with Speed Dial 14

Dialpad

- dialing numbers 15
- icon 15

E

Edit

- call forwarding number 24
- menu 79, 81, 83
- phone number 15, 17, 18, 39
- SMS messages 58
- Speed Dial 40, 42

Email messages 49, 50, 52, 55

Emergency numbers 20

F

Forwarding

calls 24

SMS Email 50

SMS messages 58, 82

Frequently asked questions 85–91

G

Greetings 56

H

Headset

connecting 77

jack 5

Hold button 26

HotSync operations 61–66, 91

I

Icons

battery 13

Call History 16, 32

Dialpad 15

Phonebook 44, 45

signal strength 13

Speed Dial 14

Voicemail 13

Ignoring calls 22

Incoming calls 21–24, 35

Indicators

battery 6, 8, 13

Call History 35

call status 26, 28, 29

call waiting 23

missed call 19

network service 6, 11, 13

signal strength 13

voicemail 13

K

Key Pad 13, 14, 33

L

LED 5, 6, 8, 11

Light, see LED 6

Limited warranty 95

Locking phone 72

M

Memo Pad 18

Menus

Phone application 79–80

Phonebook 81

SMS Message Manager 82–84

Message

Manager, see SMS
menus 82

Messages

checking 31–35
missed call 19
purging SMS 60
replying 52
sorting SMS 59
text 11, 31, 34, 51
voicemail 11, 33

Missed calls 19, 32, 35

Modem 61–66

Module

inserting 7
removing 7

N

Network

coverage area 11
HotSync operation 65
name 13
selecting 76, 80
status 6, 75
voicemail number 38

Network status 24, 74

O

Options

Call Preferences 74, 75
call waiting 74
menu 80, 81, 84
Phone Preferences 70
Ringer Preferences 71

Outgoing calls 13–20, 35, 47, 75

P

Password 72, 73

Phone application
menus 79–80
starting 15

Phone button 6

Phone number
checking 10
editing 15

Phonebook
menus 81

PIN 72, 73, 86

Power button 5

Preferences

Call 75
call waiting 74
dialing 69

- Phone 70
- ringer 71
- Prefixes 68
- PUK 86
- Purging
 - Call History 36
 - SMS messages 60

R

- Record menu 79
- Redialing a number 16
- Ringer
 - button 6
 - settings 71

S

- Safety 11, 92, 110–112
- Scroll buttons 6, 15, 51
- Security 72
- Setup 2–10
- Signal strength 13, 76
- Signatures 56
- SIM card
 - defined 1, 3
 - IMEI 10
 - inserting 3
 - locking 72

- phone number 10
- Phonebook 43–47
- SMS Message Center number 50
- SIM Phonebook 43–47
- Slider 5, 6, 71
- SMS
 - changing messages 58
 - copying text 57
 - creating messages 53
 - email messages 50, 55
 - forwarding messages 58
 - greetings 56
 - Inbox 51
 - menus 82–84
 - Message Manager button 6
 - messages 31, 34
 - Preferences 50
 - purging messages 60
 - replying to messages 52
 - saving messages 57
 - signatures 56
 - sorting messages 59
- Sorting messages 59
- Speaker 5, 6, 77

Speed Dial

- adding Address Book entries 39
- adding Call History entries 16
- changing entries 40
- copying entries from SIM card 44, 45
- defining buttons 38
- deleting entries 41
- dialing numbers 14
- icon 14
- list 37–42
- organizing 37, 42
- voicemail 33, 38

Support 85

Switching calls 28

T

Text messages, *see* SMS

To Do List 18

Troubleshooting 85–91

U

Unblock code 86

Unlock code 86

V

Vibrate 71

VisorPhone

- inserting 7

- parts of 5

- removing 7

- turning on 9

Voicemail 11, 19, 22, 31, 33, 38

- icon 13

Volume 6

W

Warranty 95

Wireless synchronization, *see*
HotSync operations