

# **DVD-ROM DRIVE UNIT**

**SR-8586-B / SR-8586-C**

## **INSTRUCTION MANUAL**

Please read through these instructions before operating this unit.

Interface : ATAPI

# DVD-ROM DRIVE UNIT SR-8586-B / SR-8586-C INSTRUCTION MANUAL

Please read through these instructions before operating this unit.  
Interface : ATAPI

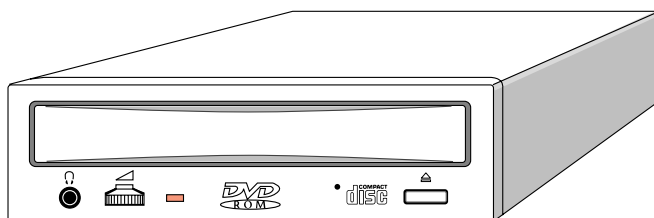

## TABLE OF CONTENTS

<b>IMPORTANT SAFETY NOTICE .....</b>	<b>iv</b>
<b>LASER SAFETY INFORMATION .....</b>	<b>A-1</b>
<b>INTRODUCTION .....</b>	<b>A-4</b>
<b>1. PRECAUTIONS WHEN OPERATING .....</b>	<b>A-5</b>
1.1 PRECAUTIONS WHEN TRANSPORTING .....	A-5
1.2 INSTALLATION LOCATION .....	A-5
1.3 PRECAUTIONS FOR USE .....	A-5
1.4 PRECAUTIONS FOR OPERATION .....	A-5
1.5 PRECAUTIONS WHEN HANDLING DISCS .....	A-5
<b>2. PARTS AND FUNCTIONS .....</b>	<b>A-7</b>
2.1 FRONT VIEW .....	A-7
2.2 REAR VIEW .....	A-7
<b>3. CONNECTIONS .....</b>	<b>A-8</b>
3.1 CONNECTING VIEW .....	A-8
<b>4. GUIDE TO OPERATION .....</b>	<b>A-8</b>
4.1 INSTALLATIONS .....	A-8
<b>5. GENERAL DESCRIPTION .....</b>	<b>A-9</b>
5.1 FEATURE SUMMARY .....	A-9
5.2 SYSTEM SET UP .....	A-9
5.3 POWER SAVING .....	A-9
<b>6. SPECIFICATION SUMMARY .....</b>	<b>A-9</b>
6.1 PERFORMANCE .....	A-9
6.2 ERROR RATES .....	A-10
6.3 AUDIO PERFORMANCE .....	A-10
6.4 GENERAL PERFORMANCE .....	A-11
6.5 ENVIRONMENTAL CONDITIONS .....	A-11
6.6 PICK UP LASER .....	A-11
<b>7. BEFORE REQUESTING SERVICE .....</b>	<b>A-11</b>
7.1 TROUBLESHOOTING .....	A-11

# IMPORTANT SAFETY NOTICE

## NOTICE

- (1) You may not reproduce or transcribe any part of this publication without permission.
- (2) We reserve the right to revise this document at any time without notice.
- (3) If you have any questions about this document, contact your sales representative.

## SAFETY NOTICE

- (1) To prevent fire or electric shock, do not expose this appliance to rain or moisture.
- (2) To avoid electric shock or damage to the eyes due to laser beam, do not attempt to disassemble the cabinet.

**For USA** (Model SR-8586-B only)

## FEDERAL COMMUNICATIONS COMMISSION (FCC) RADIO FREQUENCY INTERFERENCE STATEMENT

### Class B Computing Device

**NOTE** : This equipment has been tested and found to comply with the limits for a Class **B** digital device, pursuant to part 15 of the FCC Rules. These limits are designed to provide reasonable protection against harmful interference in a residential installation. This equipment generates, uses and can radiate radio frequency energy and , if not installed and used in accordance with the instructions, may cause harmful interference to radio communications. However, there is no guarantee that interference will not occur in a particular installation. If this equipment does cause harmful interference to radio or television reception, which can be determined by turning the equipment off and on, the user is encouraged to try to correct the interference by one or more of the following measures :

- - Reorient or relocate the receiving antenna.
- - Increase the separation between the equipment and receiver.
- - Connect the equipment into an outlet on a circuit different from that to which the receiver is connected.
- - Consult the dealer or an experienced radio/TV technician for help.

**FCC WARNING** : Changes or modifications not expressly approved by the party responsible for compliance could void the user's authority to operate the equipment.

## LASER SAFETY INFORMATION

### Class 1 LASER Product

This equipment is certified to comply with DHHS Rule 21 CFR Chapter 1, Subchapter J in effect as of date of manufacture.

Elsewhere, the drive is certified to conform to the requirements of the International Electrotechnical Commission (IEC) 825 and CENELEC EN60825 for Class 1 laser products.

Class 1 laser products are not considered to be hazardous. To ensure continued product safety, the following precautions should be heeded. This equipment has the Optical Pickup which has the Dual Lasers (DVD & CD).

#### Caution :

- (1) The use of controls or adjustments or performance of procedures other than those specified herein may result in hazardous radiation exposure.
- (2) The drive is designed to be incorporated into a computer-based system or unit which has an enclosing cover. The drive may not be used as a stand-alone unit.
- (3) Do not open the drive unit; no user adjustments or serviceable parts are inside.



- This label is attached to the upper shield at the top of the drive unit.
- Märkningen återfinns på den översta kåpan överst på drivenheten. (For Swedish)
- Denne merkelappen er festet til det øverste dekselet på toppen av spilleren. (For Norwegian)
- Denne etiket er sat fast på den øverste skærm på drev-enhedens top. (For Danish)
- Tämä etiketti on liimattu voimayksikön yläosan suojalevyyn. (For Finnish)



- This label is attached to the inner side of the rear wall on the Mechanism chassis in the drive unit.

<p><b>CAUTION-</b> LASER RADIATION WHEN OPEN DO NOT STARE INTO BEAM</p>	<p><b>VORSICHT-</b> LASERSTRAHLUNG, WENN ABDECKUNG GEÖFFNET NICHT IN DEN STRAHL BLICKEN</p>
<p><b>ADVARSEL-</b> LASERSTRÅLING VED ÅBNING SE IKKE IND I STRÅLEN</p>	<p><b>ADVARSEL -</b> LASERSTRÅLING NÅR DEKSEL ÅPNES STIRR IKKE INN I STRÅLEN</p>
<p><b>VARNING -</b> LASERSTRÅLING NÅR DENNA DEL ÅR ÖPPNAD STIRRA EJ IN I STRÅLEN</p>	<p><b>VARO !</b> AVATTAESSA OLET ALTTIINA LASERSÄTEILYLLE ÄLÄ TUJOTA SÄTEESEEN</p>
<p><b>CAUTION -</b> INVISIBLE LASER RADIATION WHEN OPEN DO NOT STARE INTO BEAM OR VIEW DIRECTLY WITH OPTICAL INSTRUMENTS</p>	<p><b>VORSICHT-</b> UNSICHTBARE LASERSTRAHLUNG, WENN ABDECKUNG GEÖFFNET NICHT IN DEN STRAHL BLICKEN AUCH NICHT MIT OPTISCHEN INSTRUMENTEN</p>
<p><b>ADVARSEL-</b> USYNLIG LASERSTRÅLING VED ÅBNING. SE IKKE IND I STRÅLEN - HELLER IKKE MED OPTISKE INSTRUMENTER.</p>	<p><b>ADVARSEL -</b> USYNLIG LASERSTRÅLING NÅR DEKSEL ÅPNES. STIRR IKKE INN I STRÅLEN ELLER SE DIREKTE MED OPTISKE INSTRUMENTER.</p>
<p><b>VARNING -</b> OSYNLIG LASERSTRÅLING NÅR DENNA DEL ÅR ÖPPNAD. STIRRA EJ IN I STRÅLEN OCH BETRAKTA EJ STRÅLEN MED OPTISKA INSTRUMENT.</p>	<p><b>VARO !</b> NÄKYMÄTÖNTÄ AVATTAESSA OLET ALTTIINA LASERSÄTEILYLLE. ÄLÄ TUJOTA SÄTEESEEN ÄLÄKÄ KATSO SITÄ OPTISEN LAITTEEN LÄPI.</p>

- This label is attached to the bottom of the drive unit.
- Märkningen återfinns på drivenhetens undersida. (For Swedish)
- Denne merkelappen er festet til undersiden av spilleren. (For Norwegian)
- Denne etiket er sat fast i bunden af drev-enheden. (For Danish)
- Tämä etiketti on liimattu laitteen pohjaan. (For Finnish)

#### For Finnish

**VAROITUS!** Laitteen käyttäminen muulla kuin tässä käyttöohjeessa mainitulla tavalla saattaa altistaa käyttäjän turvallisuusluokan 1 ylittävälle näkymättömälle lasersäteilylle.

#### For Swedish

**VARNING!** Om apparaten används på annat sätt än i denna bruksanvisning specificerats, kan användaren utsättas för osynlig laserstrålning, som överskrider gränsen för laserklass 1.

**for DVD****LASER Specification**

Type: Semiconductor laser InGaAlP or InGaAlP / GaAs  
 Wave Length: 650 ± 15 nm  
 Divergence:  $\theta = 20^\circ \sim 35^\circ$  (Typical 27 °)  
 Output Power: 0.33 mW

**Laser-Daten: (For German)**

Typ: InGaAlP oder InGaAlP / GaAs-Halbleiter-Laser  
 Wellenlänge: 650 ± 15 nm  
 Divergenz:  $\theta = 20^\circ \sim 35^\circ$  (Typical 27 °)  
 Ausgangsleistung: 0,33 mW

**LASER: (For French)**

Type: Laser semi-conducteur InGaAlP ou InGaAlP / GaAs  
 Longueur d'ondes: 650 ± 15 nm  
 Divergence:  $\theta = 20^\circ \sim 35^\circ$  (Typical 27 °)  
 Puissance de sortie: 0,33 mW

**Laser- specifikationer: (For Swedish)**

Typ: Laserhalvedare InGaAlP eller InGaAlP / GaAs  
 Våglängd: 650 ± 15 nm  
 Divergens:  $\theta = 20^\circ \sim 35^\circ$  (Typical 27 °)  
 Uteffekt: 0,33 mW

**LASER Spesifikasjon: (For Norwegian)**

Type: Halvleder laser InGaAlP eller InGaAlP / GaAs  
 Bølgelengde: 650 ± 15 nm  
 Divergens:  $\theta = 20^\circ \sim 35^\circ$  (Typical 27 °)  
 Utgangseffekt: 0,33 mW

**Laser Specifikationer: (For Danish)**

Type: Semiconductor InGaAlP eller InGaAlP / GaAs  
 Bølge-længde: 650 ± 15 nm  
 Divergens:  $\theta = 20^\circ \sim 35^\circ$  (Typical 27 °)  
 Udgang-effekt: 0,33 mW

**LASERin tekniset tiedot: (For Finnish)**

Tyyppi: Laserpuolijohdin InGaAlP eli InGaAlP / GaAs  
 Aallon pituus: 650 ± 15 nm  
 Hajaantumisen:  $\theta = 20^\circ \sim 35^\circ$   
 (Tyypillinen 27 °)  
 Teho: 0,33 mW

**for CD****LASER Specification**

Type: Semiconductor laser GaAs  
 Wave Length: 790 ± 20 nm  
 Divergence:  $\theta = 20^\circ \sim 45^\circ$  (Typical 39 °)  
 Output Power: 0.33 mW

**Laser-Daten: (For German)**

Typ: GaAs-Halbleiter-Laser  
 Wellenlänge: 790 ± 20 nm  
 Divergenz:  $\theta = 20^\circ \sim 45^\circ$  (Typisch 39 °)  
 Ausgangsleistung: 0,33 mW

**LASER: (For French)**

Type: Laser semi-conducteur GaAs  
 Longueur d'ondes: 790 ± 20 nm  
 Divergence:  $\theta = 20^\circ \sim 45^\circ$  (Environ 39 °)  
 Puissance de sortie: 0,33 mW

**Laser- specifikationer: (For Swedish)**

Typ: Laserhalvedare GaAs  
 Våglängd: 790 ± 20 nm  
 Divergens:  $\theta = 20^\circ \sim 45^\circ$  (Typiskt 39 °)  
 Uteffekt: 0,33 mW

**LASER Spesifikasjon: (For Norwegian)**

Type: Halvleder laser GaAs  
 Bølgelengde: 790 ± 20 nm  
 Divergens:  $\theta = 20^\circ \sim 45^\circ$  (Typisk 39 °)  
 Utgangseffekt: 0,33 mW

**Laser Specifikationer: (For Danish)**

Type: Semiconductor GaAs  
 Bølge-længde: 790 ± 20 nm  
 Divergens:  $\theta = 20^\circ \sim 45^\circ$  (Typisk 39 °)  
 Udgang-effekt: 0,33 mW

**LASERin tekniset tiedot: (For Finnish)**

Tyyppi: Laserpuolijohdin GaAs  
 Aallon pituus: 790 ± 20 nm  
 Hajaantumisen:  $\theta = 20^\circ \sim 45^\circ$   
 (Tyypillinen 39 °)  
 Teho: 0,33 mW

## INTRODUCTION

DVD-ROM is read-only memory using a CD-ROM disc system and an audio compact disc system as a media package which handles digital data. To enjoy audio CD, please insert the Headphone plug into the Headphone jack.(Model SR-8586-B only)

This drive unit uses DVD-ROM discs which bear the following mark.

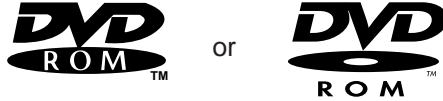

This drive unit uses CD-ROM discs which bear the following mark.



This drive unit uses CD-R discs which bear the following mark (read only).



This drive unit uses audio compact discs which bear the following mark.



## CHAPTER 1 PRECAUTIONS WHEN OPERATING

### 1.1 PRECAUTIONS WHEN TRANSPORTING

To avoid damage

- \* Keep the original packing materials for the drive unit.
- \* Before you transport the drive unit, remove the disc from the drive unit and repack the drive unit in its original packing.

### 1.2 INSTALLATION LOCATION

Do not place unit in the following environments.

- \* High-temperature, high-humidity, extreme temperature changes.
- \* Dusty
- \* Excessive vibration/ sudden shock.
- \* Inclined place.
- \* Direct sunlight.

### 1.3 PRECAUTIONS FOR USE

- \* Never push objects of any kind through the Cabinet slots, never spill liquid of any kind on the unit.
- \* Do not place objects on the product.
- \* Do not attempt to service this product yourself.
- \* Do not open or remove covers.
- \* Do not place foreign objects in the disc insertion slot and attempt to operate.
- \* Do not use DVD-ROM drive when vertically installed. (Horizontal installation type only)

### 1.4 PRECAUTIONS FOR OPERATION

To avoid error

- \* Do not move the drive unit during operation.
- \* Do not operate the unit directly after a sudden increase in temperature.

#### NOTE :

A great proportion of problems are usually caused by the following.

- ① Dust or Finger-prints on the surface of the disc.
- ② Random Electrical Noise.
- ③ Scratches and Defects on the surface of the disc.

### 1.5 PRECAUTIONS WHEN HANDLING DISCS

- ① Hold the disc by the edges, do not touch the surface of the disc.

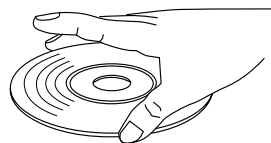

- ② To remove dust or fingerprint, use a clean, soft, dry cloth.

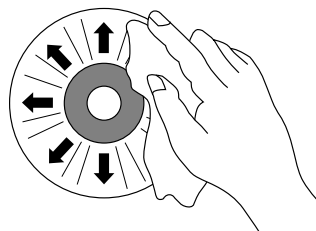



- ③ Do not write on, or paste paper to the surface of the disc.  
Should not paste a large or thick label to the outer back surface (the label side) of the disc, or it generates drive vibration due to imbalance of the disc.

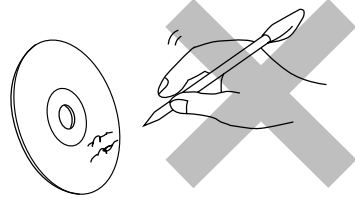

- ④ Do not store the disc in a place where the temperature is high.

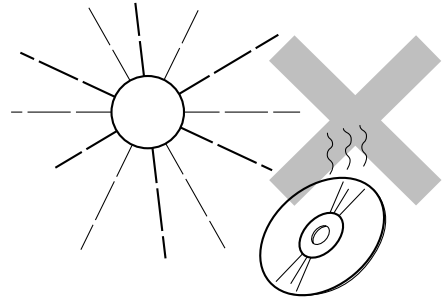

- ⑤ Do not use benzine, thinners and cleaners, etc.

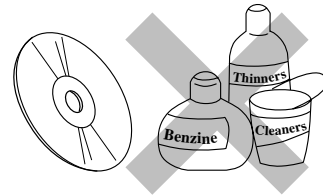

- ⑥ Do not make the center hole larger.

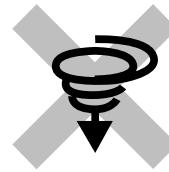

- ⑦ Do not bend the disc.

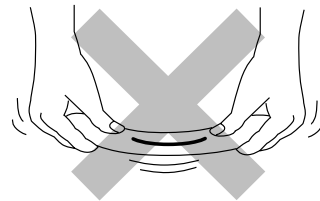

- ⑧ Do not drop the disc, or subject it to shock.

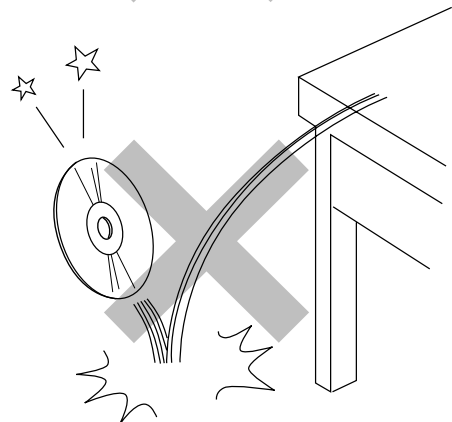

## CHAPTER 2 PARTS AND FUNCTIONS

### 2.1 FRONT VIEW

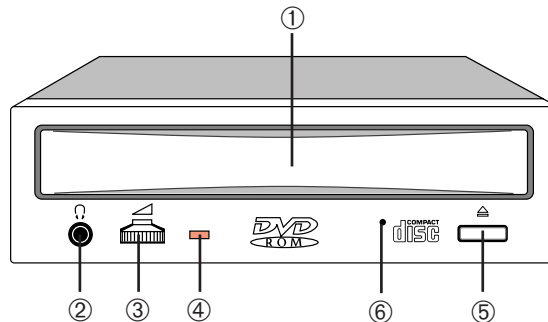

- ① **DISC TRAY**  
Accepts a disc.
- ② **HEAD PHONE JACK** (Model SR-8586-B only)  
Headphone can be connected using a 3.5mm stereo mini plug.
- ③ **VOLUME** (Model SR-8586-B only)  
Adjusts audio output level of Headphone.
- ④ **BUSY INDICATOR**  
Lights when data is being accessed from the disc, or the drive is playing an audio CD.
- ⑤ **EJECT/LOAD BUTTON**  
Ejects and loads the disc tray.
- ⑥ **EMERGENCY EJECT HOLE**  
Insert an instrument such as straightened paper clip into this hole to manually eject the tray. (See 4.1)

### 2.2 REAR VIEW

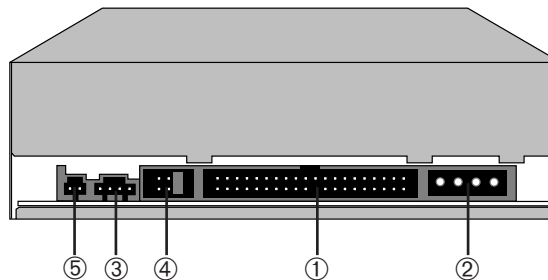

- ① **INTERFACE CONNECTOR**  
Connects to host computer's interface connector.
- ② **DC (IN) CONNECTOR**
- ③ **AUDIO OUT CONNECTOR** (Analog)
- ④ **JUMPER PIN**  
Insert the jumper according to the Master / Slave / CSEL drive.  
(See the figure in the next page.)
- ⑤ **DIGITAL AUDIO OUT CONNECTOR**

**NOTE:**

The serial format of digital data (not Audio data) output functions with some models.

## CHAPTER 3 CONNECTIONS

### 3.1 CONNECTING VIEW

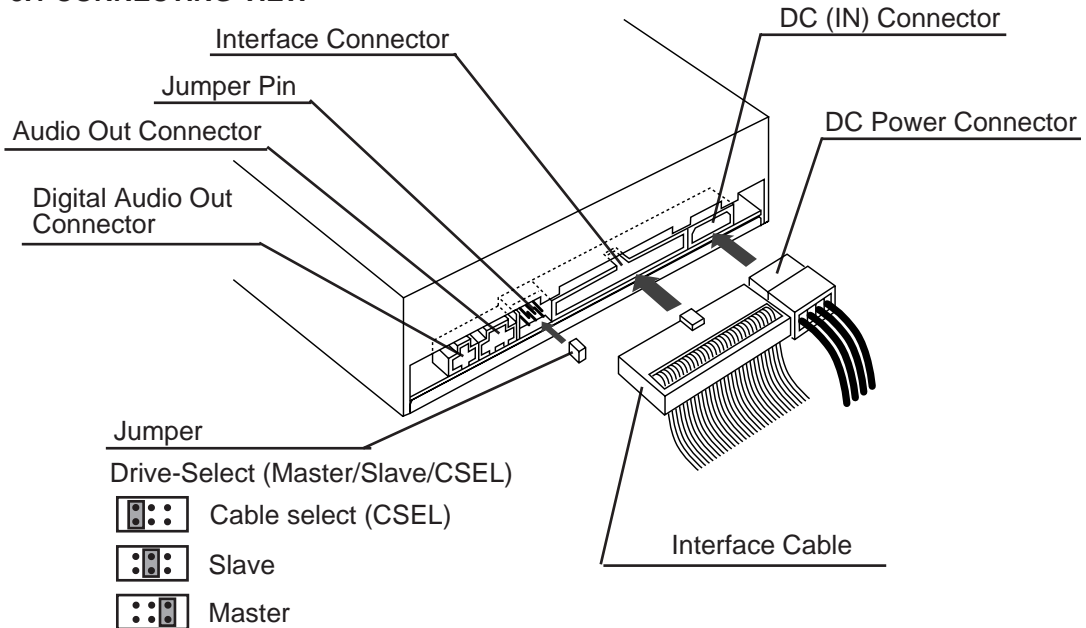

## CHAPTER 4 GUIDE TO OPERATION

### 4.1 INSTALLATIONS

- Starting the drive.

- ① Turn on the power supply.
- ② Press the eject button. The tray is ejected from the drive.
- ③ Place the disc in the tray with the disc's label facing up.
- ④ Press the eject button or press the tray lightly as in the following figure. The tray is retracted automatically.
- ⑤ Loading start.

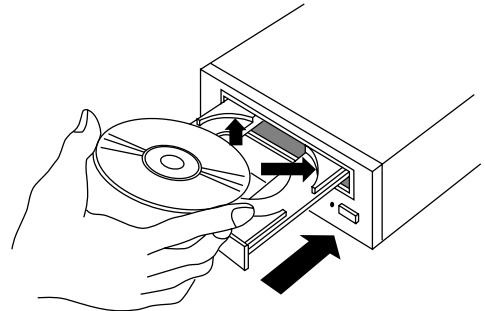

\* This figure shows in case of Horizontal Installation.

#### CAUTION:

- Do not insert any foreign objects into the disc tray. This could result in a malfunction.
- Do not manually force the tray to open.
- When the drive is not in use, keep the tray closed to protect against dust and dirt.
- Do not press down hard on the tray when loading a disc, since this may result in damage to or malfunction of the tray.

- In case of emergency, eject the tray manually. If for some reason the tray will not eject automatically, press the eject-bar (for example, insert a straightened paper clip minimum straight length = 45 mm, Diameter = 1 ~ 1.5 mm) into the emergency eject hole to manually eject the tray. (Before proceeding with this emergency step, make sure that the power is switched OFF.)

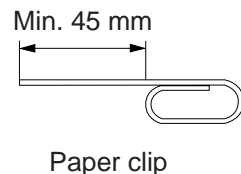

## CHAPTER 5 GENERAL DESCRIPTION

---

### 5.1 FEATURE SUMMARY

- ① Embedded ATAPI Interface.
- ② Automatic Loading with tray.
- ③ Horizontal and Vertical Installation.  
(Vertical : Vertical installation type only, 12 cm Disc only)
- ④ Audio Playback Capability.
- ⑤ MS-DOS CD-ROM Extensions Available.
- ⑥ 5 1/4" Half Height Design.

### 5.2 SYSTEM SET UP

The ATAPI Devices are selected by the Address field in the Drive Select Register. When a single Device is attached to the interface, it shall be set as Device 0. When the ATAPI Device is attached along with an ATA Mass Storage Device, the ATAPI Device will be set as Device 1 and respond as a Slave.

### 5.3 POWER SAVING

- ① When the drive waits for a command from the Host for more than two minutes, then the drive enters Power Save Mode. Laser and Spindle motor stop.
- ② Re-start is automatic when the Host Command is received or eject button is pushed.

#### NOTE :

- **ATAPI** : AT Attachment Packet Interface.
- **MS-DOS** and **MS Windows** are trademarks or registered trademarks of Microsoft Corporation.
- **IBM PC-AT** is a registered trademark of International Business Machines Corporation.

## CHAPTER 6 SPECIFICATION SUMMARY

---

### 6.1 PERFORMANCE

- |  |  |
|--|--|
| ① Disc diameter  | 12cm, 8cm  |
| ② Disc speed<br>(DVD CAV mode)<br>(CD CAV mode)  | 9200 r/min (CAV) *1<br>9480 ~ 11064 r/min (CAV)  |
| ③ Data capacity  | 4.7 GBytes (DVD Single Layer)<br>8.5 GBytes (DVD Dual Layer)<br>540 MBytes typical (12 cm CD Disc)<br>180 MBytes typical (8 cm CD Disc)  |
| ④ Data transfer Rate<br>Sequential (DVD CAV mode)<br>Sequential (CD CAV mode)<br>From buffer | 8960 ~ 21640 KBytes/s<br>3108 ~ 7200 KBytes/s (Mode 1)<br>16.67 MBytes/s (PIO Mode 4 without IORDY)<br>16.67 MBytes/s (Multi-word DMA Mode 2)<br>33.3 MBytes/s (Ultra DMA Mode 2) *2 |

⑤ Access time	
Random access time (DVD CAV mode) *3	110 ms typical
Fullstroke access time (DVD CAV mode) *4	250 ms typical
Random access time (CD CAV mode) *5	90 ms typical
Fullstroke access time (CD CAV mode) *6	180 ms typical

⑥ Buffer Size 512 KBytes

**MTBF** 125,000 POH (duty 20%)

**NOTE:**

- \*1 CAV : Constant Angular Velocity
- \*2 This performance functions with some models.
- \*3 Random access time (DVD) : Average Data read over the complete area from starting data recorded area(LBA:0) to maximum data recorded area(LBA:23197F), more than 2000 times including latency and layered error correction time.
- \*4 Fullstroke access time (DVD) : From starting data recorded area (LBA:0) to maximum data recorded area (LBA:23197F) including latency and layered error correction time.
- \*5 Random access time (CD) : Average Data read over the complete area from 00 min. 02 sec. 00 block to 59 min. 58 sec. 74 blocks, more than 2000 times including latency and layered error correction time.
- \*6 Fullstroke access time (CD) : From 00 min. 02 sec. 00 block to 59 min. 58 sec. 74 blocks including latency and layered error correction time.

**6.2 ERROR RATES**

- Soft read errors Less than  $10^{-9}$
- Hard read errors Less than  $10^{-12}$

**6.3 AUDIO PERFORMANCE**

(1) Analog audio

- ① Number of channels 2
- ② Frequency response 100 Hz ~ 20 kHz (Headphone)  
20 Hz ~ 20 kHz (Line-out)
- ③ SN Ratio More than 80 dB (Headphone/ Line-out)
- ④ Distortion
  - Line-out Less than 0.1 % (1 kHz)
  - Headphone Less than 0.2 % (1 kHz)
- ⑤ Output level 0.60 Vrms typ. (Headphone/ Line-out)

(2) Digital audio

- ① Output level 3.3V CMOS level
- ② Data format Base a decision on IEC-958

## 6.4 GENERAL PERFORMANCE

- |                          |   |
|--------------------------|---|
| ① Power requirement      | +5 V $\bar{\bar{=}}$ 1.0 A<br>+12 V $\bar{\bar{=}}$ 2.0 A |
| ② Dimensions (W x H x D) | 146 x 41.3 x 190 mm(exclude Front Bezel)                  |
| ③ Weight                 | 890 g typical   |

## 6.5 ENVIRONMENTAL CONDITIONS

### Operating

- Temperature 5 ~ 50 °C
- Humidity 5 ~ 90 %RH  
(Max. wet bulb temp. is 29 °C, Non-condensation)

### Non-operating

- Temperature - 30 ~ 65 °C
- Humidity 5 ~ 90 %Rh  
(Non-condensation)

## 6.6 PICK UP LASER

### ① for DVD

- Type Semiconductor laser GaAs
- Wave Length 663 ± 13 nm
- Divergence  $\theta = 73.7^\circ \pm 3^\circ$
- Output power 0.8 mW

### ② for CD

- Type Semiconductor laser GaAlAs
- Wave Length 775 ~ 815 nm (Typical 790 nm)
- Divergence  $\theta = 53.4^\circ \pm 3^\circ$
- Output power 0.28 mW

# CHAPTER 7 BEFORE REQUESTING SERVICE

## 7.1 TROUBLESHOOTING

- (1) There are many kinds of problems caused by misuse. When a problem occurs, check the table below which describes possible problems occurring with your DVD-ROM drive.
- (2) If the DVD-ROM drive is not operating correctly and you cannot restore operation by following the detailed procedures in the table below, do not remove the cover of the units or adjust further.
- (3) In the case of (2) above, unplug the unit and consult with your dealer or the nearest service station.

TROUBLE	CORRECTION
<ul style="list-style-type: none"> <li>• DVD-ROM drive does not operate and Busy Indicator does not light.</li> </ul>	<ol style="list-style-type: none"> <li>① Confirm that the connection between the DVD-ROM drive and the host computer is correct.</li> <li>② Confirm that the program is correct.</li> <li>③ Confirm that the setting drive select switch is correct.</li> <li>④ Confirm that the disc has been inserted label side up.</li> <li>⑤ Confirm that foreign objects have not been inserted.</li> </ol>

Weight and dimensions shown are approximate.  
Specifications are subject to change without notice.