

Safety first

Your new phone is a convenient and effective communications tool, but it can be hazardous when used improperly. To avoid harming yourself or anyone else, please review the following information before using your phone.

Batteries

Batteries can cause property damage, injury, or burns if the terminals are touched with a conductive material (for example, metal jewellery, keys, and so on). Therefore, use caution when handling a charged battery. Additional precautions and notes are listed below:

- Never throw a battery into a fire; it may explode.
- Fully recharge the battery if the battery is low or as soon as the low-battery alert beeps.
- Do not drop the battery.
- Do not allow bridging of battery contacts with metallic objects.
- Do not remove the battery from the phone while the phone is powered on. Settings you have changed may revert to their previous settings.



A recyclable lithium ion/polymer battery powers your phone. Please call 1-800-8-BATTERY for information on how to recycle the battery.

Charging devices

Use only Genuine Panasonic charging accessories. Use of attachments not recommended by Panasonic or your Service Provider may result in fire, electrical shock, or injury. Panasonic is not responsible for damage caused by using non-Panasonic accessories.

- Do not expose charging adapters to moisture, water, or the weather.
- Do not use an adapter with a damaged cord.
- When using a DC adapter in an automobile, a small amount of electricity flows through the adapter, even if the phone is turned off. Remove the plug from the cigarette lighter whenever the phone will be left in the vehicle for long periods of time.
- Always charge the battery in a well ventilated area, not in direct sunlight, between 41°F (5°C) and 95°F (35°C). It is not possible to recharge the battery if it is outside this temperature range.
- Do not incinerate or dispose of the battery as ordinary trash. The battery must be disposed of in accordance with local legislation and may be recycled.

Caution: The cigarette lighter must have a 12V negative ground socket. Do not use the adapter in a vehicle that has a positive ground system.

General

- Do not use the phone in extreme temperature or humidity. The specified operating temperature range is -22°F to +140°F (-30°C to +60°C).
- Extreme temperatures may have a temporary effect on the operation of your phone. This is normal and does not indicate a fault.
- Do not expose the phone (particularly the display) to direct sunlight for extended periods of time or to a humid, dusty or hot area.
- Do not attempt to disassemble the phone. There are no user-serviceable parts inside.

- Do not subject the equipment to excessive vibration or shock.
- Do not expose the phone to rain or spill liquids on it. If the equipment becomes wet immediately remove the battery and charging device and contact your dealer.
- Do not use any accessories other than those designed for use with your phone.
- Use of attachments not recommended or sold by Panasonic or your Service Provider may result in fire, electrical shock, or injury.
- Panasonic is not responsible for damages caused by using non-Panasonic accessories.
- Pressing any of the keys may produce a loud tone. Avoid holding the phone close to the ear while pressing the keys.
- Keep metallic items that may accidentally touch the battery terminals away from the equipment. Battery damage may occur.
- When disposing of any packing materials or old equipment check with your local authorities for information on recycling.
- If connecting the phone to an external source, read the operating instructions of the equipment for the correct connection and safety precautions.
- If connecting the phone to an external source, verify that the phone is compatible with the product to which you are connecting it.

Availability of service

This phone, like any wireless phone, operates using radio signals, wireless and landline networks, and user-programmed functions. Because of this, connection in all conditions cannot be guaranteed. Therefore, you should never rely solely on any wireless phone for essential communications (for example, medical emergencies).

Emergency (911) service

If you need to make an emergency (911) call, power the phone on, dial 911, and press . Emergency calls can be made regardless of lock setting and with or without a SIM card. Remember, to make or receive any call, the phone must be switched on and in a service area that has adequate signal strength. Even if you are within the coverage area of your Service Provider, you may be in an area with insufficient signal strength to place a 911 call. Emergency calls might not be possible on all wireless phone networks or when certain network service and/or phone features are in use.

Safety tips

Following the suggestions in this section will help ensure safe and efficient operation of your Panasonic phone.

This Model Phone Meets The Government's Requirements For Exposure To Radio Waves.

Your wireless phone is a radio transmitter and receiver. It is designed and manufactured not to exceed the emission limits for exposure to radiofrequency (RF) energy set by the Federal Communications Commission of the U.S. Government. These limits are part of comprehensive guidelines and establish permitted levels of RF energy for the general population. The guidelines are based on standards that were developed by independent scientific organizations through periodic and thorough evaluation of scientific studies. The standards include a substantial safety margin designed to assure the safety of all persons, regardless of age and health.

The exposure standard for wireless mobile phones employs a unit of measurement known as the Specific Absorption Rate, or SAR. The SAR limit set by the FCC is 1.6W/kg. Tests for SAR are conducted using standard operating positions specified by the FCC with the phone transmitting at its highest certified power level in all tested frequency bands.

Although the SAR is determined at the highest certified power level, the actual SAR level of the phone while operating can be well below the maximum value. This is because the phone is designed to operate at multiple power levels so as to use only the power required to reach the network. In general, the closer you are to a wireless base station antenna, the lower the power output.

Before a phone model is available for sale to the public, it must be tested and certified to the FCC that it does not exceed the limit established by the government-adopted requirement for safe exposure. The tests are performed in positions and locations (e.g., at the ear and worn on the body) as required by the FCC for each model. The highest SAR value for this model phone when tested for use at the ear is 0.825 W/kg and when worn on the body, as described in this user guide, is 0.687 W/kg. (Body-worn measurements differ among phone models, depending upon available accessories and FCC requirements). While there may be differences between the SAR levels of various phones and at various positions, they all meet the government requirement for safe exposure.

The FCC has granted an Equipment Authorization for this model phone with all reported SAR levels evaluated as in compliance with the FCC RF emission guidelines. SAR information on this model phone is on file with the FCC and can be found under the Display Grant section of <http://www.fcc.gov/oet/fccid> after searching on FCC ID NWJ21C001A.

Additional information on Specific Absorption Rates (SAR) can be found on the Cellular Telecommunications Industry Association (CTIA) web-site at

<http://www.wow-com.com>.

Caution: All Panasonic branded accessories are tested and comply with FCC RF exposure requirements. Non-Panasonic accessories may not comply.

Body-worn operation

This device was tested for body-worn operations with the back of the phone kept 1.5 cm. from the body. To maintain compliance with FCC RF exposure requirements, use only belt-clips, holsters or similar accessories that maintain a 1.5 cm. separation distance between the user's body and the back of the phone. The use of belt-clips, holsters and similar accessories should not contain metallic components in its assembly. The use of accessories that do not satisfy these requirements may not comply with FCC RF exposure requirements, and should be avoided.

Antenna care

This mobile phone incorporates an internal antenna for radio communication. Do not use the phone if it is damaged. Unauthorized antennas, modifications, or attachments could damage the phone and may violate FCC regulations.

Driving

Important: Check the laws and regulations on the use of wireless telephones in the areas where you drive. Always obey them. Also, if using your phone while driving:

- Give full attention to driving - driving safely is your first responsibility;
- Use handsfree operation, if available;
- Pull off the road and park before making or answering a call if driving conditions so require.

Electronic devices

Most modern electronic equipment is shielded from RF signals. However, certain electronic equipment may not be shielded against the RF signals from your wireless phone.

Pacemakers: The Health Industry Manufacturers Association recommends that a minimum separation of 6 inches (6") or 15 centimeters (15 cm) be maintained between a handheld wireless phone and a pacemaker to avoid potential interference with the pacemaker. These recommendations are consistent with independent research and recommendations of Wireless Technology Research.

Persons with pacemakers:

- Should ALWAYS keep the phone more than six inches from their pacemaker when the phone is turned ON;
- Should not carry the phone in a breast pocket;
- Should use the ear opposite the pacemaker to minimize the potential for interference;
- If you have any reason to suspect that interference is taking place, turn your phone OFF immediately.

Hearing Aids: Some digital wireless phones may interfere with some hearing aids. In the event of such interference, consult your Service Provider and hearing aid manufacturer.

Other Medical Devices: If you use any other personal medical device, consult the manufacturer of your device to determine if it is adequately shielded from external RF energy. Your physician may be able to assist you in obtaining this information.

Turn your phone OFF in health care facilities when any regulations posted in these areas instruct you to do so. Hospitals or health care facilities may be using equipment that could be sensitive to external RF energy.

Vehicles: RF signals may affect improperly installed or inadequately shielded electronic systems in motor vehicles. Check with the manufacturer or its representative regarding your vehicle. You should also consult the manufacturer of any equipment that has been added to your vehicle.

Posted Facilities: Turn your phone OFF in any facility where posted notices so require.

Aircraft

FCC regulations prohibit using your phone while in the air; switch off your phone before boarding an aircraft unless otherwise advised by airline personnel.

Blasting areas

To avoid interfering with blasting operations, turn your phone OFF when in a “blasting area” or in other areas posted: “Turn off two-way radio.” Obey all signs and instructions.

Potentially explosive atmospheres

Turn your phone OFF when in any area with a potentially explosive atmosphere and obey all signs and instructions. Sparks in such areas could cause an explosion or fire resulting in bodily injury or even death.

Areas with a potentially explosive atmosphere are often, but not always, clearly marked. They include fueling areas such as gas stations; below deck on boats; fuel or chemical transfer or storage facilities; vehicles using liquefied petroleum gas (such as propane or butane); areas where the air contains chemicals or particles, such as grain, dust or metal powders; and any other area where you would normally be advised to turn off your vehicle engine.

For vehicles equipped with an air bag

An air bag inflates with great force. DO NOT place objects, including both installed or portable wireless equipment, in the area over the air bag or in the air bag deployment area. If in-vehicle wireless equipment is improperly installed and the air bag inflates, serious injury could result.

For U.S. Customers: Vehicles using liquefied petroleum gas (such as propane or butane) must comply with the National Fire Protection Standard (NFPA-58).

For a copy of this standard, contact:

National Fire Protection Association

One Batterymarch Park

PO Box 9101

Quincy, MA 02269

Phone: 1-800-344-3555

Web site: www.nfpa.org E-mail address: Custserv@NFPA.org

FCC/CE/IC STATEMENTS

DECLARATION OF CONFORMITY WITH FCC RULES FOR ELECTROMAGNETIC COMPATIBILITY

We, Panasonic Mobile Communications Co., Ltd., declare under our sole responsibility that the product,

X800

to which this declaration relates, this device complies with Part 15 of the FCC Rules. Operation is subject to the following two conditions: (1) this device may not cause harmful interference, and (2) this device must accept any interference received, including interference that may cause undesired operation.

Caution: Exposure to Radio Frequency Radiation.

This device and its antenna must not be co-located or operating in conjunction with any other antenna or transmitter.

Federal Communications Commission Notice

This equipment has been tested and found to comply with the limits for a Class B digital device, pursuant to Part 15 of the FCC Rules. These limits are designed to provide reasonable protection. This equipment generates, uses and can radiate radio frequency energy and, if not installed and used in accordance with the instructions, may cause

FCC/CE/IC STATEMENTS

harmful interference to radio communications. However, there is no guarantee that interference will not occur in a particular installation. If this equipment does cause harmful interference to radio or television reception, which can be determined by turning the equipment off and on, the user is encouraged to try to correct the interference by one or more of the following measures:

- Reorient or relocate the receiving antenna.
- Increase the separation between the equipment and the receiver.
- Connect the equipment into an outlet on a circuit different from that to which the receiver is connected.
- Consult the dealer or an experienced radio/TV technician for help.

Modifications

The FCC requires the user to be notified that any changes or modifications to this device that are not expressly approved by Panasonic may void the user's authority to operate the equipment.

Canada-Industry Canada (IC)

The wireless radio of this device complies with RSS 139 & RSS 210 Industry Canada. This Class B digital complies with Canadian ICES-003.

Cet appareil numérique de la classe B conforme à la norme NMB-003 du Canada.

Europe-European Union Notice

Radio products with the CE 0560 or CE alert marking comply with the R&TTE Directive (1995/5/EC) issued by the Commission of the European Community.

TEN (10) DRIVER SAFETY TIPS

Your wireless telephone gives you the powerful ability to communicate by voice-almost anywhere, anytime. But an important responsibility accompanies the benefits of wireless phones, one that every user must uphold.

When driving a car, driving is your first responsibility. When using your wireless phone behind the wheel of a car, practice good common sense and remember the following tips:

1. **Get to know your wireless phone and its features such as speed dial and redial.** If available, these features help you to place your call without taking your attention off the road.
2. **When available, use a hands free device.** If possible, add an additional layer of convenience and safety to your wireless phone with one of the many hands free accessories available today.
3. **Position your wireless phone within easy reach.** Be able to access your wireless phone without removing your eyes from the road. If you get an incoming call at an inconvenient time, if possible, let your voice mail answer it for you.
4. **Let the person you are speaking with know you are driving; if necessary, suspend the call in heavy traffic or hazardous weather conditions.** Rain, sleet, snow, ice, and even heavy traffic can be hazardous.
5. **Do not take notes or look up phone numbers while driving.** Jotting down a "to do" list or flipping through your address book takes attention away from your primary responsibility, driving safely.
6. **Dial sensibly and assess the traffic; if possible, place calls when you are not moving or before pulling into traffic.** Try to plan calls when your car will be stationary. If you need to make a call while moving, dial only a few numbers, check the road and your mirrors, then continue.
7. **Do not engage in stressful or emotional conversations that may be distracting.** Make people you are talking with aware you are driving and suspend conversations that have the potential to divert your attention from the road.
8. **Use your wireless phone to call for help.** Dial 9-1-1 or other local emergency number in the case of fire, traffic accident or medical emergencies. Remember, it is a free call on your wireless phone!
9. **Use your wireless phone to help others in emergencies.** If you see an auto accident, crime in progress or other serious emergency where lives are in danger, call 9-1-1 or other local emergency number, as you would want others to do for you.
10. **Call roadside assistance or a special non-emergency wireless assistance number when necessary.** If you see a broken-down vehicle posing no serious hazard, a broken traffic signal, a minor traffic accident where no one appears injured, or a vehicle you know to be stolen, call roadside assistance or other special non-emergency wireless number.

"The wireless industry reminds you to use your phone safely when driving."

For more information, please call 1-888-901-SAFE or visit www.wow-com.com

Information on this page provided by the Cellular Telecommunications Industry Association.



TABLE OF CONTENTS

HIGHLIGHTS	1	NAVIGATING THE APPLICATIONS... 25	
IMPORTANT INFORMATION	2	Multitasking.....27	
Care and Maintenance	4	Search Option.....28	
End-user Software License Agreement.....	6	Shared Phone Memory.....28	
GETTING STARTED	7	APPLICATIONS MENU MAP	29
Installing and Removing SIM Card	7	CONTACTS.....	30
Installing and Removing Battery.....	8	Create New Contact Cards.....	30
Charging Battery.....	9	SIM Directory.....	30
Installing and Removing miniSD Card	10	Find a Contact Card	31
Phone Overview	11	Make a Call.....	31
Key Functions.....	12	Create a Message	32
Icons	14	Edit Contact Cards	32
Standby Mode Displays.....	15	Manage Contacts List.....	34
PHONE BASICS AND MANAGING CALLS	16	Send a Contact Card	34
Switching the Phone on and off.....	16	Service Numbers	34
Making Calls	16	Create and Manage Groups.....	34
Answering Calls.....	18	Take a Picture and Add to Contact Card	35
Active Call Options	19	CALENDAR.....	36
Handsfree Talking	20	Create Calendar Events	36
Call Waiting	20	Browse Calendar.....	37
Ending Calls	22	Edit Calendar Events.....	38
Close the Phone during a Call.....	22	Delete Events	38
ENTERING TEXT	23	Calendar Settings.....	39
Dictionary for Predictive Text Entry	23	Send Calendar Events.....	39
General Text Entry	23	Chinese Lunar Calendar.....	39
		MESSAGES	40
		Voice Mail.....	40

Messages 40

- Create New Text Messages 42
- Create New Multimedia Messages... 42
- Create New E-mail Messages..... 44
- Receive New Messages..... 45
- Inbox (Received Messages)..... 45
- My Folders (Organise Messages)... 47
- Mailbox (E-mail Messages)..... 48
- Drafts..... 51
- Sent..... 52
- Outbox 53
- Reports..... 54
- Message Settings..... 54
- SIM Messages 56
- Cell Broadcast Messages 56
- Service Command..... 57

CAMERA..... 58

- Take a Picture 58
- Take a Self-Portrait 59
- Save Pictures 59
- View Pictures 60
- Name Pictures..... 60
- Picture Quality..... 60
- Send Pictures..... 60

MEDIA..... 62

- Gallery..... 62
- View Image, Sound, and Video Folders..... 62
- View Images, Zoom in, and Set as Wallpaper..... 62
- Play Video, Sound Clips, and Streaming Media..... 63
- Player Controls..... 64

- Send Pictures, Video and Sound Clips..... 65
- Download Pictures, Video and Sound Clips..... 65
- Image Uploader 65
- PhotoBase 66
- Take a Picture using PhotoBase..... 66
- View Photos 67
- Edit Photos..... 67
- Add Clip Art, Frames to Photos..... 68
- RealOne Player 69
- Play Video Clips and Streaming Media..... 69
- RealOne Player Settings..... 70
- Video Recorder..... 71
- Record a Video Clip..... 71
- Send a Video Clip 72
- Video Recorder Settings 72

CONNECTIVITY 74

- Browser..... 74
- Setup to Connect to Browser 75
- Connect to the Internet 75
- Navigate the Internet..... 75
- Bookmark Options 77
- Download Files from the Internet 77
- Browser Settings..... 78
- Saved Pages..... 79
- Operator Menu..... 79
- Modem..... 80
- Bluetooth® Wireless Technology 81
- Set up Bluetooth 82
- Pair with Other Device and Connect..... 82

Send and Receive Data via Bluetooth.....	83	Change Wallpaper or Screensaver	93
Manage Paired Devices	83	Download New Themes	93
Infrared	84	Settings	94
Prepare for Infrared Connection.....	84	Phone Settings	94
Send and Receive Data via Infrared	85	Call Settings	95
USB	85	Connection Settings	96
Connect to PC Software Suite.....	85	Date & Time Settings.....	98
Connect to Modem	85	Security Settings.....	99
Connection Manager	86	Call Divert.....	102
View Connection Details.....	86	Call Barring.....	103
End Connections	86	Network Settings	103
Synchronisation	86	Enhancement Settings	104
Create a New Sync Profile	86	Clock	104
Synchronise.....	87	Set Time and Date.....	104
View or Edit Sync Profiles and Content.....	87	Set Alarms	105
Device Manager.....	88	Speed Dial.....	106
Configuration Session	88	Assign a Speed Dial Number	106
Create a New Server Profile.....	88	Call a Speed Dial Number	106
View or Edit Server Profiles.....	89	Change, Remove, or View Speed Dial Numbers	106
Shortcut to Stop Configuration Sessions	89	Voice Commands	107
SETTINGS	91	Start Voice Commands.....	107
Ringtones.....	91	Voice Dial	107
Activate a Ringtone	91	Name Lookup	108
Change Ringtones, Alert Tones and Volume	91	Open Application	108
Themes.....	92	Voice Commands Settings	108
Preview Themes.....	92	Voice Tags.....	109
Activate a Theme.....	93	PrintBoy Setup	110
		About.....	110
		TOOLS	111
		Calculator	111

Converter	112	Add a Shortcut to Favourites	133
Notepad	113	Manage Favourites	133
Recorder	113	ACCESSORIES	134
miniSD Card (Memory Card).....	115	SPECIFICATIONS	136
To-Do List.....	117	TROUBLESHOOTING.....	138
Application Manager	118	COPYRIGHTS	140
File Manager	119	INDEX	143
PhotoLight.....	121		
SIM Tool Kit.....	122		
CALL LOGS.....	123		
Missed Calls, Received Calls, and Dialled Numbers	123		
Call Duration	124		
GPRS Data Counter.....	124		
Call Logs Settings	124		
General Call Logs	125		
QUICKOFFICE.....	126		
View Documents	126		
View Microsoft® Word Documents	126		
Edit Microsoft® Word Documents	127		
View Microsoft® Excel Documents	128		
Edit Microsoft® Excel Documents	128		
View Microsoft® PowerPoint® Documents	129		
GAMES	131		
MicroGolf Game.....	131		
Balloon-Headed Boy Game	132		
FAVOURITES	133		
Open a Favourites Shortcut	133		

HIGHLIGHTS

Here are just some of the things you can do with the X800 mobile phone.

- **Send colour pictures and video clips** to friends and family via Multimedia messaging and e-mail messaging.
- **Send** pictures, video, electronic business cards, and more using **Bluetooth®**, **Infrared**, or **USB** connections to other phones or devices.
- **Swap content** between appropriate devices with the included miniSD Card and adapter.
- **Surf the Internet** using your XHTML configured wireless Internet browser.
- **Add frames, text, and pop art** to VGA size images.
- **Capture video clips.**
- **Play 40 tone polyphonic ringtones.**
- **No more wired headset!** Use a Bluetooth® wireless headset.
- **Synchronise** your Contacts and Calendar **with your other networked devices.**
- **See who is calling** with **picture** Caller Line ID on the X800 external display.
- **Download games, images, themes, sounds, videos,** and Java™ and Series 60 **applications.**
- **View** all your **media files in one place,** the Media Gallery.
- **Search for your files;** including games, images, install packages, and video and sound clips.
- **Receive, edit, and view Microsoft®** Word, Excel, and PowerPoint® **files.** Beam documents to printers and projectors (with appropriate accessory).
- **Speak a name or number to dial** the number using Voice Commands.
- **Say “open Messages” or “open Camera”** and your phone will go directly to the application using Voice Commands.

IMPORTANT INFORMATION

Thank you for purchasing this Panasonic digital cellular phone. This phone is designed to operate on GSM networks - GSM900, GSM1800 and GSM1900. It also supports GPRS for packet data connections. Please ensure the battery is fully charged before use.

Safety Considerations

Please read and understand the following information as it provides details for operating your phone in a manner which is both safe to you and your environment, and conforms to any legal requirements regarding the use of cellular phones.



Power

This equipment should only be charged with approved charging equipment to ensure optimum performance and avoid damage to your phone. Other usage will invalidate any approval given to this equipment and may be dangerous. Ensure the voltage rating of the Travel Charger is compatible with the area of use when travelling abroad. A Travel Charger (EB-CAX70xx)* is supplied with the main kit. Car Charger (EB-CDX70) is also recommended for charging. *Note: xx identifies the charger region, e.g. AU, CN, EU, UK, US.



Battery

Use of a battery pack other than that recommended by the manufacturer may result in a safety hazard. Never expose the battery to extreme temperatures (over 60° C or 140° F). It is normal for your battery to become warm to the touch when charging. Camera use, keeping Bluetooth switched on, Internet browsing, extended gaming, and downloading data reduces battery life.



Aircraft

Cellular phones can cause interference in an aircraft. Switch off your cellular phone when in an aircraft. The use of cellular phones in an aircraft may be dangerous to the operation of the aircraft, disrupt the cellular network and may be illegal. Failure to observe this instruction may lead to the suspension or denial of cellular phone services to the offender, or legal action or both.



Alarm

Alarms should not be set to switch on the phone when you are in an aircraft, near sensitive medical equipment, at a refuelling point or when it may cause interference or danger.



Disposing of the Battery

Do not incinerate or dispose of the battery as ordinary rubbish. The battery must be disposed of in accordance with local legislation and may be recycled.



Do not use

It is advised not to use the equipment at a refuelling point. You are reminded to observe restrictions on the use of radio equipment in fuel depots, chemical plants or where blasting operations are in progress.

Never expose the battery to extreme temperatures (over 60° C or 140° F).



It is imperative that the driver exercises proper control of the vehicle at all times. Do not hold a phone while you are driving; find a safe place to stop first. Do not speak into a handsfree microphone if it will take your mind off the road. Always acquaint yourself thoroughly with restrictions concerning the use of cellular phones within the area you are driving and observe them at all times.



Care must be taken when using the phone in close proximity to personal medical devices, such as pacemakers and hearing aids.



For most efficient use hold the phone as you would any normal phone. To avoid deterioration of signal quality or antenna performance, do not touch or cup the antenna area while the phone is switched on. Unauthorised modifications or attachments may damage the phone and violate applicable regulations. The use of an unapproved modification or attachment may result in the invalidation of your guarantee – this does not affect your statutory rights.



When your handset, the accompanying battery, or charging accessories are wet, do not put those in any type of heating equipment, such as a microwave oven, a high pressure container, or a drier or similar. It may cause the battery, handset and/or charging equipment to leak, heat up, expand, explode and/or catch fire. Moreover, the product or accessories may emit smoke and their electrical circuits may become damaged and cause the products to malfunction. Panasonic is not responsible for any and all damages, whether direct or indirect, howsoever caused by any misuse.



It is recommended that you create a copy or backup, as appropriate, of any important information and data which you store in your phone's memory. In order to avoid accidental loss of data, please follow all instructions relating to the care and maintenance of your phone and its battery. Panasonic accepts no liability for any and all losses howsoever arising from any loss of data, including but not limited to direct and indirect losses (to include, but not limited to consequential loss, anticipated savings, loss of revenue).

Your phone has the capability of storing and communicating personal information. It is recommended that you take care to ensure that any personal or financial information is stored separately from your phone. You should use security features, such as the SIM lock to protect information held in your phone. Panasonic accepts no liability for any and all losses howsoever arising from any loss of data, including but not limited to direct and indirect losses (to include, but not limited to consequential loss, anticipated savings, loss of revenue).



Your phone has the capability of downloading and storing information and data from external sources. It is your responsibility to ensure that in doing this you are not infringing any copyright laws or other applicable legislation. Panasonic accepts no liability for any and all losses howsoever arising from any loss of data or any such infringement of copyright or intellectual property rights, including but not limited to direct and indirect losses (to include, but not limited to consequential loss, anticipated savings, loss or revenues).



Camera

You are advised to take appropriate care over the use of the internal camera. It is your responsibility to ensure that you have permission to take photographs of people and objects and that you do not infringe any personal or third party rights when using the camera. You must comply with any applicable international or national law or other special restrictions governing camera use in specific applications and environments. This includes not using the camera in places where the use of photographic and video equipment may be prohibited. Panasonic accepts no liability for any and all losses howsoever arising from any infringement of copyright or intellectual property rights, including but not limited to direct and indirect losses.

Do not leave the camera facing direct sunlight, as this may impair its performance.

The colour liquid crystal display (LCD) uses high-precision production technology, and in certain circumstances pixels may appear brighter or darker. This is due to characteristics of the LCD and is not a manufacturing defect.

The display layouts and screenshots within this document are for illustrative purposes and may differ from the actual displays on your phone. Panasonic reserves the right to change the information in this document without prior notice.

This equipment should only be used with Panasonic approved accessories to ensure optimum performance and avoid damage to your phone. Panasonic is not responsible for damages caused by using non-Panasonic approved accessories.

This Panasonic mobile phone is designed, manufactured and tested to ensure that it complies with the specifications covering RF exposure guidelines applicable at the time of manufacture, in accordance with EU, USA FCC, and Australian ACA regulations.

Please refer to our website for latest information/standards and compliance in your country/region of use.
<http://www.panasonicmobile.com>

CARE AND MAINTENANCE



Pressing any of the keys may produce a loud tone. Avoid holding the phone close to your ear while pressing the keys.



Extreme temperatures may have a temporary effect on the operation of your phone. This is normal and does not indicate a fault.

If you use your phone in a temperature over 40°C for a long time, the display quality may deteriorate.



Do not modify or disassemble the equipment. There are no user serviceable parts.



Do not subject the equipment to excessive vibration or shock.



Do not drop the battery.



Avoid contact with liquids. If the equipment becomes wet immediately remove the battery and contact your dealer.



Do not leave the equipment in direct sunlight or a humid, dusty, or hot area.



Never throw a battery into a fire. It may explode.



Keep metallic items that may accidentally touch the terminals away from the equipment/battery.



Batteries can cause property damage, injury, or burns if terminals are touched with a conductive material (i.e. metal jewellery, keys, etc.).



Always charge the battery in a well ventilated area, not in direct sunlight, between +5°C and +35°C. It is not possible to recharge the battery if it is outside this temperature range.



When connecting the phone to an external source, read the operating instructions of the equipment for the correct connection and safety precautions. Ensure the phone is compatible with the product it is being connected to.



When disposing of any packing materials or old equipment check with your local authorities for information on recycling.

END-USER SOFTWARE LICENSE AGREEMENT

By use of this Panasonic cellular phone, including any embedded software features or programs ("Embedded Software"), you agree to the terms and conditions of this End-User Software License Agreement ("EULA").

1. **END-USER RIGHTS:** You are granted a limited end-user right to use the Embedded Software only as part of and together with this Panasonic cellular phone. You agree to use the Embedded Software in a manner that complies with all applicable laws, including laws related to copyright and other intellectual property rights. All other uses are prohibited.

2. **LIMITATIONS ON END-USER RIGHTS:**

- (a) You may not reproduce, copy, or transfer the Embedded Software to any other device;
- (b) You may not create derivative works of any type based on the Embedded Software (unless and except as expressly permitted as part of a feature application);
- (c) You may not reverse engineer, reverse compile, disassemble, or otherwise attempt to discover the source code of the Embedded Software;
- (d) You may not transfer this Panasonic cellular phone other than to a transferee end-user who undertakes to observe the same obligations as those set out in this EULA;
- (e) You may not remove any proprietary notices, such as copyright, trademark, or otherwise, from the Embedded Software.

3. **INTELLECTUAL PROPERTY RIGHTS:** The Embedded Software is protected by copyright, trademark, patent and/or other intellectual property rights and is owned by Panasonic Mobile Communications Co., Ltd. ("PMC") and/or is under license from PMC's licensors.

4. **TERMINATION:** Your right to use the Embedded Software may be terminated for failure to comply with any of the terms of this EULA.

5. **LIMITATION OF LIABILITY/DISCLAIMER OF WARRANTIES:** TO THE MAXIMUM EXTENT PERMITTED BY APPLICABLE LAW, IN NO EVENT SHALL PMC, ITS AFFILIATES, AND THEIR LICENSORS BE LIABLE FOR INCIDENTAL, INDIRECT, SPECIAL OR CONSEQUENTIAL DAMAGES OR ANY DAMAGES WHATSOEVER RESULTING FROM LOSS OF USE, DATA OR PROFITS, ARISING OUT OF OR IN CONNECTION WITH THE USE OR PERFORMANCE OF THE EMBEDDED SOFTWARE. EXCEPT AS EXPRESSLY STATED IN THE RELEVANT WARRANTY CARD, PMC, ITS AFFILIATES, AND THEIR LICENSORS DISCLAIM ALL WARRANTIES, EXPRESS AND IMPLIED, INCLUDING, WITHOUT LIMITATION, THE IMPLIED WARRANTIES OF MERCHANTABILITY AND FITNESS FOR A PARTICULAR PURPOSE. THE REMEDIES PROVIDED TO THE END-USER IN THE RELEVANT WARRANTY CARD ARE EXCLUSIVE.

6. **ADDITIONAL THIRD PARTY TERMS:** The Embedded Software may contain third party software subject to separate third party license terms and conditions set forth in the user manual or associated product documentation and/or displayed on the LCD of this Panasonic cellular phone. You acknowledge and agree that such third party software is governed by the third party license terms, as applicable, and that such terms are solely between you and the applicable licensor.

7. **EXPORT REGULATIONS/RESTRICTED RIGHTS:** The Embedded Software is subject to U.S. export control laws, including the U.S. Export Administration Act and its associated regulations, and may be subject to export or import regulations in other countries. You agree to comply strictly with all such regulations. You confirm that with respect to the Embedded Software, you will not export or re-export it, directly or indirectly, to any countries that are subject to U.S. export restrictions. Use, duplication or disclosure by the U.S. government is subject to the restrictions as set forth in the Rights in Technical Data and Computer Software Clauses in DFARS 252.227-7013(c)(1)(ii) and FAR 52.227-19(c)(2) as applicable.

GETTING STARTED

The Panasonic X800 GSM™/GPRS mobile phone operates on Global System for Mobile Communications (GSM) networks around the world, which provide integrated voice mail, text short message service (SMS), multimedia messaging service (MMS), fraud protection and superior voice quality.

Feature Availability

Some features are network dependent or are available only if you subscribe to the feature. Some functions are SIM card dependent. Note that before you can use or activate many of the network features, you must subscribe to the desired services. For more information, contact your wireless service provider.

Before Using Your Phone

The SIM card must be installed in your phone for it to operate on the cellular network. Insert SIM card, then attach battery and fully charge it.

INSTALLING AND REMOVING SIM CARD

Caution: This product contains small parts. Keep out of reach of small children.
Take care not to scratch or bend SIM card and gold contacts.

Installing SIM Card

1. Use fingernail at base of triangle mark on battery cover to gently slide cover until cover clicks and moves slightly **1**. Then, lift cover to remove **2**. Remove battery (see page 8).
2. Position SIM card as shown, with gold contacts facing phone and notched corner entering phone first. Carefully slide the SIM card into the SIM card pocket until card is all the way seated.
 - If SIM card is inserted incorrectly or damaged, **Insert SIM card** may display. Remove SIM card then install again.
 - If **SIM card rejected** message appears, contact your wireless service provider.

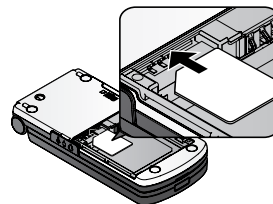
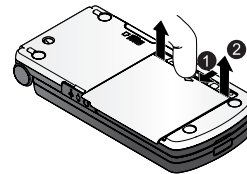

Note: Refer to the label in the battery compartment for location of SIM card pocket and notched corner area.

Removing SIM Card

1. Use fingernail at base of triangle mark on battery cover to gently slide cover until cover clicks and moves slightly. Then, lift cover to remove. Remove battery and remove battery (see page 8).
2. Place finger on bottom edge of SIM card and gently slide out.

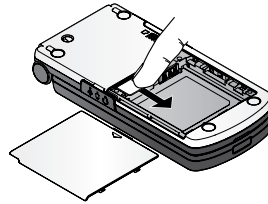

Note: If you are upgrading your phone and your previous phone did not support new services, such as MMS (Multimedia Messaging Service), you may need to insert a new SIM card. Contact your wireless service provider.

INSTALLING AND REMOVING BATTERY

Caution: Using non-Panasonic accessories or accessories not recommended by your wireless service provider may result in poor performance of your phone, or even cause an electrical hazard.

Installing Battery

1. Hold battery at 45° angle; insert tabs on top edge of battery into slots along top edge of battery area ①.
2. Push bottom of battery down until it fits ②.
3. Replace battery cover by sliding cover. Cover clicks when it is correctly shut and should fit snugly with no gaps.

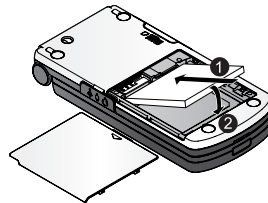

Removing Battery

Note: Before you remove the battery, switch off the phone and disconnect the phone from the charger or any other device.

1. Remove battery cover. Use fingernail at base of triangle mark on battery cover to gently slide cover until cover clicks and moves slightly. Then, lift cover to remove.
2. Use fingernail to pull tab at bottom left of battery to lift and remove battery.

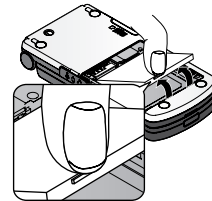



CHARGING BATTERY

Note: First verify that battery is installed.

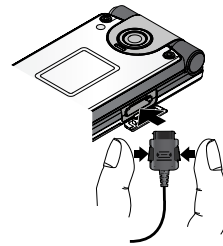
1. Open connector cover at left side of phone as you turn over and upside down phone.
 2. Insert connector. Connect charger into mains power socket.
 3. When charging is complete, remove from mains power socket. You should press and hold release buttons on both side of connector end and pull gently to disconnect the charger from phone.
- DO NOT force connector: it may damage phone or charger.



Charging Icons on Main and External Display

-  bars scroll when charging
-  bars stop scrolling when charging is complete

- If the phone is switched on, **Battery full** message appears when charging is complete.

Low Battery Warning

When the battery power is low, **Battery low** displays and a warning tone sounds; phone will automatically switch off. Fully recharge the battery. If you receive the low battery warning during a conversation, finish your call immediately.

INSTALLING AND REMOVING miniSD CARD

The miniSD Card is a memory card used to expand phone memory and a way to transfer files to other devices.

Installing miniSD Card

1. On left side of phone as you turn over and upside down phone, lift up miniSD Card cover ①.
2. Slide miniSD Card with notched corner entering phone first and gold contacts facing down into the miniSD Card pocket until it clicks. Push down miniSD Card cover until it clicks ②.

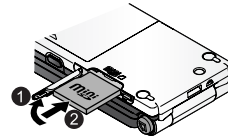

Note: Do not insert any object except a miniSD Card into the miniSD Card pocket.
Do not place labels, etc., onto the miniSD Card. A fine difference in card thickness may result in insertion or removal difficulty, loss of contact or loss of data.
Take care not to scratch or bend miniSD Card and gold contacts.

Removing miniSD Card



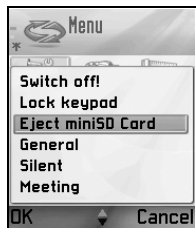
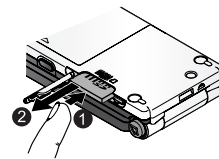



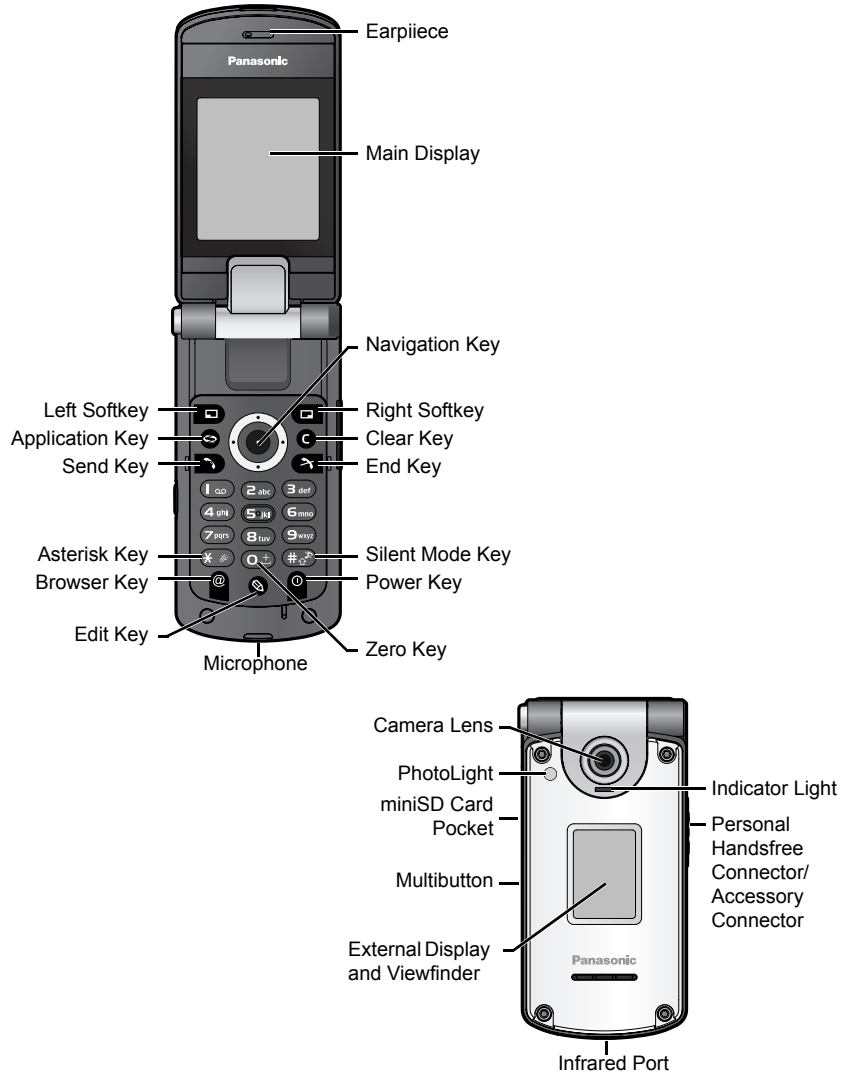





1. Press Power key ①, scroll to **Eject miniSD Card** and press **OK**. Before removing miniSD Card, wait for file saving or copying process to finish.
2. On left side of phone as you turn over and upside down phone, lift up miniSD Card cover.
3. To release miniSD Card, gently push bottom edge of miniSD Card forward into pocket ①.
4. After miniSD Card is ejected, gently remove it ②. Push down miniSD Card cover until it clicks.









PHONE OVERVIEW

















KEY FUNCTIONS

Key	Function
	Power Key Press and hold to switch phone on or off. Press to choose different ringtones, eject miniSD Card, lock keypad, or lock the phone.
	Navigation Key Press outside edges to scroll up ▲, down ▼, left ◀ or right ▶ to move through menus and text. Press centre ● to select option. In standby mode, press centre ● to open Contacts. Take a picture in Camera mode by pressing ●.
	Send Key Make a call. Press in standby mode to recall recently dialed numbers. Scroll ◀ to see received and missed calls lists. Press and hold in standby mode to activate voice commands.
	End Key Ends a call. Return to standby mode.
	Applications Key Enter the main applications menu area. Return to standby mode. Press and hold to view currently open applications.
	Left Softkey Perform action named in lower left of display. Shortcut to open preset application in standby mode. To change shortcut, see page 95. To lock the keys, in standby mode press  , then press  . To unlock the keys, press  , then press  .
	Right Softkey Perform action named in lower right of display. Shortcut to open preset application in standby mode. To change shortcut, see page 95.
	Edit Key Select Dictionary for predictive text including insert and edit words, or alpha mode or number mode. Insert numbers or symbols. Change writing language. Mark multiple items in a list by holding down  , then scrolling ▲ or ▼.

























Key	Function
	Clear Key Erase character in edit mode. Delete highlighted entered item.
	Browser Key Opens Browser.
	Asterisk Key In standby mode, press and hold to switch PhotoLight or flashlight on or off. In numeric and standby modes, press repeatedly for *, +, p and w characters. In Dictionary mode, scroll to other word choices when word is underlined. In edit mode, press to open special character table.
	Zero Key In standby mode, press and hold to enter + character for dialling. In edit mode, enter space.
	Silent Mode Key In standby mode, press and hold to switch Silent mode on/off. In edit mode, shift to upper and lower case letters, or press twice briefly to turn on/off Dictionary for predictive text.
	Multibutton (on side of phone) For external display, press once to switch on backlight, then press as needed to toggle between clock and icon views. Turns off ringer during incoming call. Takes a picture in Camera mode when flip is closed.

Symbols used in this manual

	Press Power key.		Press Applications key.
	Press outside edges of navigation key to scroll up, down, left or right to move through menus and text.		Press navigation key centre.
	Press Send key.		Press End key.
	Press Left softkey.		Press Right softkey.
	Press Edit key.		Press Clear key.
	Press number keys.		Press Browser key.
	Press Asterisk key.		Press Silent Mode key.
	Press Multibutton key (on side of phone).		

ICONS

Different icons appear depending on the features you are using and the options you have selected.

Icon	Indicates	Icon	Indicates
	Seven levels indicate battery charge level. Bars scroll when battery is charging.		Alarm is set
	Seven levels indicate signal strength from network on which phone is currently registered		New voice mail message received (if you have 2 lines, left circle is darkened for line 1, right circle is darkened for line 2)
	GPRS service is available		New message received
	GPRS service is on hold during voice call		Message in Outbox waiting to be sent
	GPRS connection is active		Bluetooth is enabled
	Multiple GPRS connections are active		Bluetooth is active
	Missed call		Infrared is enabled (flashes when active)
	Call divert is active (if you have 2 lines, 1 or 2 also appears)		USB connection enabled
	Line selection 2 (SIM card dependent, if you have 2 phone lines)		Navigation key - scroll and move up or down options
	Data call		Navigation key - scroll left or right, move left or right to view tabs
	Keypad is locked		All ringing tones/ring volume are off (Silent ringtone)
	Earpiece sound on		Private handsfree headset attached
	Loudspeaker sound on		

STANDBY MODE DISPLAYS

MAIN DISPLAY

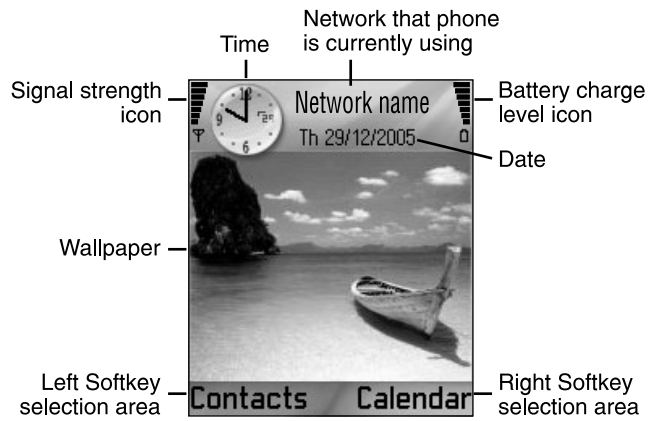

EXTERNAL DISPLAY

Press Multibutton once to switch on backlight, then press as needed to toggle between clock and icon views.

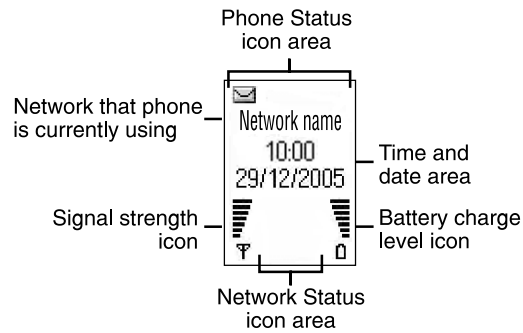

PHONE BASICS AND MANAGING CALLS

SWITCHING THE PHONE ON AND OFF



Press and hold .

Note: If your SIM card is PIN protected, your PIN code will be requested. Enter the PIN code and press **OK**. See *Security Settings* on page 99.

MAKING CALLS

Check that phone is switched on, signal strength icon displays at least one bar , and your network operator logo displays before dialling a call.

Type in the Phone Number to Dial

1. From standby mode, enter the area code and phone number, and press .
2. To end the call, press .

Note: To erase a digit, press .
During a call, scroll  or  to adjust earpiece volume.

Warning: Closing the flip during a call will end the call, when set to default. To set the phone to keep the call connected when you close the flip, see **Active clamshell** in *Call Settings* on page 95.

Use a Contact Card to Dial



From **Contacts** application:

1. Scroll to desired name card, press .
 - If the card has several phone numbers stored, select the one you wish to dial.

To add information to your Contacts, see page 30.

Use a SIM Directory Entry to Dial

From **Contacts** application:

1. Scroll  to **SIM directory** view.
2. Scroll to desired name, press .

To add names and numbers to your SIM directory, see page 30.

Speak the Name to Dial



To dial by saying the name of the person you wish to call:

1. Press and hold .
2. After the prompt to "Say a command", say "Voice Dial".
3. After the prompt to "Say the name or number", say the full name of a person in your Contact list, including first name and last name.
4. The name is repeated, and the phone will begin dialling.

See page 107 for more Voice Command options.

Speed Dialling



If you assigned speed dialling keys (see page 106) to your frequently called numbers, you can dial them with 2 key presses.

1. From standby mode, press the preset speed dial digit key  -  then press .
 - If **Speed dialling** is set to On, (see *Call Settings* on page 95), just press and hold the preset speed dial digit key to dial the assigned number.

Note: Location number 1 may be reserved for voice mailbox number.

Dialled Numbers, Received, or Missed Calls List

You can quickly dial previously dialled numbers, received call numbers, or numbers of calls you missed.

1. From standby mode, press .
2. From the list of Dialled numbers, scroll to desired entry and press  to dial.
 - Scroll  to move to Received calls tab and Missed calls tab to select a number from either of those lists.

Automatic Redial

If you set **Automatic redial** to **On** in the Call Settings menu (see page 95), your phone will automatically redial the number up to 10 times under certain conditions, such as no answer, destination number is busy, network busy, or some connection errors.

Press **Quit** or  to stop automatic redialling.

Dial from Messages

If a received message contains a phone number, you can dial it from the Inbox message. You can also call the sender of an SMS text message.



From **Messages** application:

1. Open **Messages**. Scroll to **Inbox** and open.
2. Scroll to desired message and open.

3. To find the phone number within a message, press **Options** and select **Find > Phone number, E-mail address, or Web address**. When found, text and numbers will be underlined.

- To call the sender of SMS text message from the open message, press  to dial the sender's phone number.

International Calling

From standby mode, press and hold  to enter **+**, the international prefix, which is a shortcut for international dialling access. Then type in the country code, area code, and phone number. Press .

Note: Many countries/regions include an initial 0 in the area code. In most cases, you should omit this when dialling international numbers. For further help, contact your wireless service provider.

Emergency Calls

Dial the local emergency number used in your current location.

1. Switch on the phone if it is off.
2. Verify that the antenna icon is displayed.
3. Enter the local emergency number (such as 112) and press .

Note: You can call the local emergency number even if the keys are locked. Making emergency calls without SIM is country or network operator dependent.

Send Service Command to Network

Ask your wireless service provider to activate a particular service by sending a service command. These commands, which may be called USSD commands, can activate services such as mobile prepay and chat.

1. First, contact your wireless service provider for the proper service command code.
2. Type in the supplied service command code. If the phone recognises it as a supplementary service or USSD request, press **Send service comm**.



ANSWERING CALLS

When there is an incoming call, the phone rings and flashes green.

Note: If the phone is set to a ringtone with vibrating alert on, the phone flashes green and vibrates instead of ringing.

1. Open flip to answer a call.
 - If flip is open, press  to answer a call.

Mute Ringing Tone

To mute ringing tone, press  if flip is closed. If flip is open, press **Silence** . Then answer the call by pressing .

Change Answer Settings

To change the setting so a call will not be answered by opening the flip, see **Active clamshell** in *Call Settings* on page 95.

To answer by pressing any key except , , or , see **Anykey answer** in *Call Settings* on page 95.

Divert Incoming Calls

To divert calls to your voice mailbox or another number, see *Call Divert* on page 102. Then you can press  or **Reject** softkey and incoming calls will be diverted.

If you ignore the call by not pressing any keys, the call details appear on the Missed calls list.

ACTIVE CALL OPTIONS



When on a call, you can put the call on hold, mute the microphone, send touch tones for passwords, etc., and create multi-party calls, depending on network support.



Place Calls on Hold

To put a call on hold or release the call from hold, press **Options** and select **Hold** or **Unhold**.

If you are connected to 2 calls (an active call and a call on hold), press **Options** and select:

Swap	Put active call on hold and activate held call.
Transfer	Connect an active call and held call, or incoming call to active or held call, and disconnect yourself from both calls, leaving the two callers to talk to each other.



Shortcuts: You can also press  to switch between **Hold** and **Unhold** on one call, or switch between one active and one held call (**Swap**).
To end a held call and continue with the active call, press  and .

To end the active call and continue with the held call, press  and .

HANDSFREE TALKING





To hear the caller's voice from the handsfree loudspeaker, press **Loudsp.**. Set the phone down nearby so you and several others can have a conversation without holding the phone.

To go back to the earpiece, select **Handset**.

	Loudspeaker icon -- handsfree is active.
	Earpiece icon -- handsfree is not active.

If you have activated a Bluetooth handsfree headset, press **Options** and select **BT Accessory** to hear the caller's voice in the Bluetooth headset.





Volume Control

Scroll  or  to increase or decrease volume of phone earpiece , phone loudspeaker , or if a headset is attached. Note the volume step bars change as you adjust volume.

To mute or unmute the microphone, press **Options** and select **Mute** or **Unmute**. Mute switches off microphone of phone and any accessory microphones if attached. Unmute switches microphone back on.

CALL WAITING

If you activated Call waiting network service in Call Settings (see page 95), you can answer an incoming call when on an active call.

- During an active call, press  to answer an incoming call. The active call is put on hold.
 - To switch between the calls, press **Swap** or .
 - To end the currently active call and answer the incoming call, press **Replace**.
- To end the currently active call, press . The held call becomes active.
 - Or to end both calls at once, press **Options** and select **End all calls**.
 - If you press and hold , all calls and data connections are ended.



To reject the incoming call, press **Reject**. The caller receives a busy message or goes to voice mail.

Send DTMF Touch Tones

DTMF touch tones can be transmitted during a call just by pressing the keys (0 to 9, #, *) on your phone. Touch tones are often used to access services such as voice mailboxes, calling card calls, and banking.

During a call, press **Options** and select **Send DTMF** if you stored a DTMF touch tone sequence in a Contacts card. Press **Find**, scroll to desired entry and select.

To dial or store touch tone sequences:

1. Type in access phone number.
2. Before entering touch tone digits, press  repeatedly to scroll through *, +, p and w characters to insert:
 - a short pause before the digits are transmitted (p character).
 - a manual wait period (w character) that requires you to press **Send**  during the call to transmit the digits.
 - + character to send a touch tone sequence stored in a speed dial location (see page 106).
3. Enter the touch tone digits, for example, the access codes for your voice mailbox.
4. Press  to immediately dial call, or press **Options** and select **Add to Contacts** to store sequence in your Contacts (see page 30).

Note: You can enter multiple instances of pause, wait, and speed dial characters and touch tone sequences.

Open Applications During a Call

During a call, open the main application menu by pressing , then open the desired application, for example, check your Calendar for an upcoming meeting time. The active call remains connected and is indicated by a small pop-up window. To return to the active call window, exit the application.

If you press , an active call will always disconnect.

Play/Record Sound Clips During a Call

To play a sound clip during a call, open the sound clip from its current location and play. The other person hears the sound clip.

To record the current call, see page 114.

Multi-Party Calls

In a multi-party call, you can have a conversation with up to 5 different parties at the same time if supported by the network.

1. Call the first party.
2. After the call is connected, press **Options** and select **New call** to enter a number or press **Find** to go to the Contacts to dial a number and press . The first call is put on hold.
3. After the new call is answered, press **Options** and select **Conference** to join the held call and the active call together. From then on, there is only one active call, which is the multi-party call.
4. To add another party to the call, repeat step 2, then press **Options** and select **Conference > Add to conference**.

5. To have a private conversation with one of the parties, press **Options** and select **Conference > Private**. Scroll to desired party and press **Private**. The separated party becomes the active call on your phone, the multi-party call is put on hold; however the remaining callers can continue with the multi-party call. To return to multi-call, press **Swap**. To return Private call to multi-call, press **Options** and select **Conference > Add to conference**.
6. To drop a party from the multi-party call, press **Options** and select **Conference > Drop participant**. Scroll to desired party and press **Drop**.
7. To end the multi-party call, press .

Note: If you are on an active call and already have a held call, start at step 3.

ENDING CALLS

There are several ways to end a call:

- Close the flip.
- Press .
- Press **End call** softkey.
- Press **Options** and select **End active call**.

To end all calls if there are more than one:

- Press **Options** and select **End all calls**.

If you press and hold , all calls and data connections are ended.

See *Active Call Options* starting on page 19 for ending held calls, waiting calls, and multi-party calls.

CLOSE THE PHONE DURING A CALL

Closing the flip clamshell ends the call. This is the default setting for **Active clamshell** in Call settings. If you want to close the phone and speak handsfree during a call, change the **Active Clamshell** setting to **Off**. This setting switches the caller's voice to the back loudspeaker so you can speak handsfree.

To keep calls connected when you close the flip clamshell and prevent calls from being answered when the flip is opened, see **Active clamshell** in *Call Settings* on page 95.

ENTERING TEXT

There are two main ways to enter text; using the predictive text dictionary to quickly enter words, or alpha mode in which each key is tapped until the planned letter appears.

DICTIONARY FOR PREDICTIVE TEXT ENTRY

Dictionary uses a predictive text system to enter words by pressing one key per letter to display the planned word, instead of pressing keys multiple times until each planned letter appears.

For example, to enter "Call me." in a message, press:

C a l l m e .

When you press the 6 key and the 3 key, the word "of" appears on screen, because the English dictionary ranks "of" as the most common word associated with the key presses 6 and 3. To change the word "of" to "me", press once, and the word changes.

DISPLAY PLANNED WORD MATCHES

If the correct word does not display, press repeatedly to scroll through an alternate word list. To choose from all the word matches, press and select **Dictionary > Matches**.

ADD WORDS TO PREDICTIVE TEXT DICTIONARY

To add a word that is not already in the dictionary, press and select **Dictionary > Insert word**. You can also add the word to the dictionary when **Spell** softkey appears.

GENERAL TEXT ENTRY

Enter text and numbers in one of three ways:

- Alpha mode - press each key repeatedly until planned letter appears
- Dictionary mode - press one key per letter for dictionary to display planned word
- 123** Numeric mode - enter numbers

Shortcut: To enter numbers while in alpha or dictionary mode, press and hold desired number key - .

In both alpha mode and dictionary mode, choose from:

- Abc** First letter capital **ABC** All capitals
- abc** Lower case

NAVIGATING THE APPLICATIONS



To view the main applications window, press .

Navigation Key

 Press the left, right, top and bottom edges of the navigation key to move around the display.

Press  to:



- Open an application item
- Select a highlighted item
- Confirm a selection
- Take a picture with the camera



If an up or down arrow appears at the bottom of the display, scroll  or  to go to additional items.

Shortcut: To jump to and open one of the first 9 application items (if you have not yet scrolled), simply press the number key corresponding to the desired item's location on the grid view. The grid view numbering system is:

1	2	3
4	5	6
7	8	9

Tabs

There may be more files, folders, or pages associated with an application item, which can be viewed by moving right and left across the screen. This is indicated by tabs , arrows  , or numbers near the top of the screen. For example, if you are viewing page 5 of 12 pages associated with a file, 5/12 and arrows are displayed.

- Scroll  and  to move through the tabs and pages.



Condensed Instructions

In this guide, to condense wording, statements are used such as "Press **Options** and select **Open**." This means to press **Options**, highlight **Open**, and press **Select**. You may need to scroll within the menu to reach **Open**. Many menu items are available within **Options** menus and other menus, thus these shortcut statements will be used throughout the guide to indicate the same type of process.

In this guide, a statement such as 'Select **Send > Via multimedia**', means to scroll to **Send**, then scroll ► to view the pop-up menu containing **Via multimedia**, then press **OK** or **Select** softkey to select **Via multimedia**. Within the pop-up menu, you may need to scroll to highlight **Via multimedia**.

To streamline this guide, some of the basic options are not included in every table.

Options Softkey

At the first level of each menu item, **Options**  appears as a way to organise or customise the menu system. The options change depending on the menu level you are viewing.

To open the **Options** menu:

- Press **Options**, scroll to highlight the desired action, then press **OK** or press **Select**.

Open	Open the item.
List view	View the menu items in a list form. If you select this, the option changes to Grid view to view the menu items in a grid form.
Move	Move the item to another place within the application system.
Move to folder	Move the application item into a folder.
New folder	Create and name a new folder.
Memory details >	View information about items stored in the phone memory and memory card (also referred to as miniSD Card).
Exit	Exit the menu item.

These additional actions may be available in the **Options** menu:

Remove or Delete	Remove or delete an item or a marked item (see <i>Mark/Unmark</i> on page 26) on a list or grid, or press OK .
Rename	Give a new name to the item.
Edit	Change information you have already entered.

Mark/Unmark



In menu items containing many files, you can mark specific files in which to perform an action. For example, you may wish to delete 5 images from your Images folder containing 29 images.





To mark an item or items:

1. Press **Options** and select **Mark/Unmark > Mark** to place a checkmark next to the desired file. Scroll to mark more items as needed, or select **Mark all** to mark all files.
2. Press **Options**, then select desired action such as **Delete**, **Send**, **Move**.

To unmark an item or items:

1. Press **Options** and select **Mark/Unmark > Unmark** on a marked file to remove the checkmark. To unmark all files, select **Unmark all**.

Shortcuts: To mark or unmark an item, hold down  then press .

To mark or unmark multiple items, hold down  then press and hold  or  of navigation key to scroll through desired items. Release  or  to stop marking.

Menus within a Menu

A pop-up menu appears when more than one choice is available. For example, you can send a Contacts entry several ways: via text message, via multimedia, via e-mail, via Bluetooth, and via infrared.

To enter a pop-up menu:

- Scroll , or press , or **Select** softkey.

To close a pop-up menu:

- Scroll , or press **Cancel** softkey.





Save Changes

In many cases when editing text or numbers, or changing a setting; press the **Back** softkey to automatically save changes.

MULTITASKING

You can work with more than one menu item simultaneously. For example, you can start creating a new message, rename an image, and begin creating a Contacts entry, all without losing the data you have already entered.

To keep a menu item open:

Press  to go to the standby screen. Pressing  does not close the open menu item.

Note: During a phone call,  terminates the call instead of acting as a shortcut to the standby screen.

Opening and closing menu items

There are several ways to open menu items:

- Press .
- Press **Options** and select **Open**.

There are several ways to close menu items:

- Press **Options** and select **Exit**.
- Press **Back** until Exit softkey appears, then press **Exit**.
- Press **Close**.

Shortcut to swapping among open items

If you have several menu items open, you can press and hold  to view a pop-up window and scroll to locate the desired open item. When you open the item, you will begin at the point where you were previously.

To close an open item from the pop-up window, scroll to desired item, press  and select **Yes**.



SEARCH OPTION

In certain menu items, a magnifying glass icon  appears which allows you to search for a name, file or item.



To search, enter the first letter of the desired name or file. The phone finds and displays matching entries. To refine the search, enter two or more letters.

SHARED PHONE MEMORY

The phone's memory capacity is shared by all images; text, multimedia and e-mail messages; Contacts cards; video and sound clips; ringtones; Calendar and Notepad notes; and downloaded applications stored on your phone. If you keep more files on the phone, then there is less memory available to store new files or run certain applications.

To decrease the amount of phone memory used: (1) store data on your miniSD Card; (2) delete data that is old, copied elsewhere or not being used; (3) delete messages with attachments from your Inbox after saving attachments to an application; (4) use the portrait format to take pictures with the Camera whenever possible. The portrait format file size is much smaller than standard format.

To view details of the phone memory and miniSD Card use, and amount of free memory:

1. Press .
2. Press **Options**.
3. Scroll to **Memory details**.
4. Then scroll  to choose phone memory or memory card (also referred to as miniSD Card).

Also see *File Manager* on page 119.

APPLICATIONS MENU MAP

The phone's main application menus are listed below. The names listed represent the names in list view. The names may be slightly different in grid view.

Note: The menus may not appear in the order or with the same icons as listed here. The order and icons vary according to your wireless service provider, or if you have customised your settings.



Settings

- Ringtone Profiles
- Themes
- Settings
- Clock
- Speed Dialing
- Voice
- PrintBoy Setup
- About product



Camera



Tools

- Calculator
- Converter
- Notepad
- Voice recorder
- miniSD Card
- To-Do List
- Application Mgr
- File manager
- PhotoLight
- SIM Tool Kit (optional)



Calendar



Contacts



Media

- Media Gallery
- PhotoBase
- RealOne Player
- Video Recorder



Messages

- Voice mailbox
- Messages



Call Logs

- Recent calls
- Call duration
- GPRS counter



Connectivity

- Browser
- Operator Menu
- Modem
- Bluetooth
- Infrared
- USB
- Connection Mgr
- SyncML
- Device Mgr



Games

- MicroGolf
- Balloon-Headed Boy



Favourites



Quickoffice

CONTACTS

Store names, phone numbers, e-mail, web and street addresses, even a thumbnail picture in a Contact card. Call and send messages directly from Contacts. Numbers can also be stored on your SIM card. See *Entering Text* on page 23 to learn how to enter text.

CREATE NEW CONTACT CARDS

From **Contacts** application:

1. Press **Options** and select **New contact**.
2. Enter information in main fields:

Last name	Telephone
First name	Mobile
Company	Fax
Job title	E-mail



3. From main fields, press **Options** to:

Add thumbnail	Place picture from your Images folder into the card.
Add or Delete detail	Choose desired fields and icons from list including Job title, Telephone, Tel. (home), Tel. (business), 3 mobile, 3 fax, pager numbers, 3 E-mail fields, 3 Web addresses, 3 street address fields, DTMF tones, Birthday, and Note.
Edit label	Change the field name.

4. Press **Done** to save entry.

Note: See SIM Directory to create and copy entries into your SIM Directory.

SIM DIRECTORY

The SIM Directory shows you the names and numbers stored on your SIM card. Your wireless service provider can program their service numbers, your wireless phone number and other numbers into your SIM card. You can store personal numbers on your SIM card as well.

Unlike a Contacts entry, a SIM Directory entry consists of only one name and one phone number.

Copy Numbers to SIM Directory

1. From the Contacts list, highlight the desired card.
2. Press **Options** and select **Copy to SIM direct**.
3. Choose one of the phone number fields to copy, press **OK**.

- If you select **All**, the phone creates a separate SIM directory entry for each phone number stored with that Contacts entry name.

Note: To copy SIM entries to your Contacts, highlight the desired SIM entry, then press **Options** and select **Copy to Contacts**.
The first time Contacts is opened after a different SIM card is placed in the phone, press **OK** if you wish to copy SIM contacts into the Contacts memory.

Create and Manage SIM Directory Entries

1. From the Contacts list, scroll ► to **SIM directory** tab.
2. Press **Options** and select from:

Call	Call the highlighted entry.
New SIM contact	Create a new SIM contact entry. Open and enter Name , then enter No. and press Done .
Edit	Edit the highlighted SIM entry. Numbers stored by your wireless service provider cannot be edited.
Delete	Delete the highlighted SIM entry. Numbers stored by your wireless service provider cannot be deleted.
Copy to Contacts	Copy the highlighted SIM entry to your Contacts list.
My numbers	View your own phone numbers.
SIM details	View the number of used and free SIM entries.

FIND A CONTACT CARD

From **Contacts** application:

1. Scroll to desired entry, or enter the first letter of desired entry in . Entries beginning with that letter will display.
2. Press **Enter** to open entry.

MAKE A CALL

From **Contacts** application:

1. Scroll to desired Contacts entry and press **Call**.
Or, press **Options** and select **Call**.
 - If entry contains more than one number, choose desired number to dial before pressing **Call**.

Note: To make a call from the SIM directory, from **Contacts** application scroll ► to **SIM directory** tab. Scroll to the desired entry and press **Call**.

CREATE A MESSAGE

From **Contacts** application:

1. Scroll to the desired Contacts entry and press **Options**.
2. Select **Create message > Text message, Multimedia message, or E-mail**.
3. To complete Text messages, see page 42; or Multimedia messages on page 42; or E-mail messages on page 44.

EDIT CONTACT CARDS

From **Contacts** application:

1. Highlight desired Contacts card.
2. Press **Options** and select **Edit**.
3. Scroll to desired field to edit, begin entering data. If the field already has information, scroll **◀** to move to editing point, press **Ⓢ** to clear a letter or digit.
4. Press **Options** to:

Add thumbnail	Place picture from Images folder in phone memory or miniSD Card.
Add or Delete detail	Choose desired fields and icons from list including Job title, Telephone, Tel. (home), Tel. (business), 3 mobile, 3 fax, pager numbers, 3 E-mail fields, 3 Web addresses, 3 street address fields, DTMF tones, Birthday, and Note.
Edit label	Change the field name.

5. Press **Done** to save entry.

Assign Default Number to Dial

For a Contact card, set a particular phone number or address that the phone will use each time you wish to call or write messages to that person.

From **Contacts** application:

1. Scroll to desired Contact card and open.
2. Press **Options** and select **Defaults**.
3. Highlight a field:
 - Phone number**
 - Text msg. number**
 - MMS number/address**
 - E-mail address**
4. Press **Assign**.
5. Scroll to the desired entry and press **Select**.
 - Repeat steps 4 to 6 to assign default numbers to the other fields.

Note: To remove a default assignment, select **(no default)**.

Assign a Ringing Tone

From **Contacts** application:

1. Scroll to desired Contact card and open.
2. Press **Options** and select **Ring tone**.
3. Scroll to desired tone (after a brief pause tone will play). You can use tones already supplied; sent in messages (see page 46); downloaded (see page 77); or recorded (see page 113).

Note: If tones do not play, change the phone's ringtone to **General** or **Outdoor** to hear the tones.

To assign a ringing tone to a group, scroll ► to move to Groups tab, scroll to desired group, and continue with step 3.

Assign Speed Dial

From **Contacts** application:

1. Scroll to desired Contact card and open.
2. Scroll to desired phone number field in which to assign the speed dial key, press **Options** and select **Assign speed dial**.
3. Press or scroll to desired number key and press **Assign**. An icon ☎* denotes that a speed dial key has been assigned to this number field.

To make a call using speed dial, press the associated number key, then press .

To remove an existing speed dial key, from **Contacts** application:

1. Scroll to desired Contact card and open.
2. Scroll to speed dial phone number field, then press **Options** and select **Remove speed dial**.

See page 106 for speed dial options.

Go to Web Address

If a Contact card contains a web address, you can launch the Browser and go directly to the web address.

From **Contacts** application:

1. Scroll to desired Contact card and open.
2. Press **Options** and select **Go to web address**.

MANAGE CONTACTS LIST

From **Contacts** application:

1. Press **Options** and select **Edit, Delete, or Duplicate**.

Note: See *Mark/Unmark* on page 26 to select more than one entry.

Memory Used in Contacts

To view number of cards, groups used and amount of memory used, from **Contacts** application:

1. Press **Options** and select **Contacts info > Memory**.

Sort List by Last Name or by First Name

From **Contacts** application:

1. Press **Options** and select **Settings**.
2. Open the **Name display** field to sort the list either by **Last name first** or **First name first**.

Note: This feature is not available if the phone contains Chinese language.

SEND A CONTACT CARD

Before a Contact card can be sent by Messaging or to another device, it is converted to an electronic business card format known as vCard.

From **Contacts** application:

1. Scroll to desired Contact entry.
2. Press **Options**, scroll to **Send > Via text message, Via multimedia, Via e-mail, Via Bluetooth, or Via infrared**.
3. To complete text messages, see page 42; or multimedia messages on page 42; or e-mail messages on page 44; or Bluetooth on page 83; or Infrared on page 85.

SERVICE NUMBERS

If your wireless service provider has stored service numbers on your SIM card, you can view and call the service numbers.

From **Contacts** application:

1. Press **Options** and select **Service numbers**.

CREATE AND MANAGE GROUPS

Place Contact entries into one group. Select the group name when addressing a new message, and your message is sent to each member of the group. For example, set up Business or Family group. See *Messages* starting on page 40 to learn how to send messages.

Create New Group

From **Contacts** application:

1. Scroll ► to Groups tab.
2. Press **Options** and select **New group**.
3. Enter a name for the group and press **OK**.
4. Open the group name, press **Options** and select **Add members**.
5. Select desired Contact cards to add.
 - To remove a member from a group, scroll to desired name, then press **Options** and select **Remove from group**.

Manage Groups

From **Contacts** application:

1. Scroll ► to Groups tab.
2. Scroll to desired group, then press **Options** and select from: **Open** to view group, **Delete group**, **Rename group**, add **Ringing tone** for group.

To see if a person belongs to a group; or add a person to a group, from **Contacts** application:

1. Scroll to desired Contact card.
2. Press **Options** and select **Belongs to groups** or **Add to group**. When adding, select desired group and press **Add**.

TAKE A PICTURE AND ADD TO CONTACT CARD

From **Camera** application:

1. The main display acts as a viewfinder when the flip is open. The external display acts as the viewfinder when the flip is closed.
2. To snap the picture, press **●** if the flip is open. Or press the Multibutton **■** on the side of the phone if the flip is closed.
 - The image is saved in your Images folder in Media Gallery.
3. Open **Contacts**.
4. Highlight desired Contacts card.
5. Press **Options** and select **Edit**.
6. Press **Options** and select **Add thumbnail**.
7. Select **Phone memory**.
8. Open Images folder. Scroll to highlight the image and press **Select**.
9. Press **Done**.

CALENDAR

Keep track of upcoming meetings, appointments and special dates. Set alarms to remind you of upcoming events. Calendar events can be sent and received as vCalendar messages and synchronised with other devices to keep track of your schedule.

CREATE CALENDAR EVENTS

From **Calendar** application:

1. Press **Options** and select **New entry > Meeting** -- events with a start and end time, **Memo** -- events such as trips or vacations, or **Anniversary** -- single day events such as birthdays and anniversaries.

2. Enter information in most fields by entering numbers or letters:



Meeting	Memo	Anniversary
Subject	Subject	Occasion
Location	Start date	Date
Start time	End date	Alarm
End time	Synchronisation	Synchronisation
Start date		
End date		
Alarm		
Repeat		
Synchronisation		

3. Press **Done** to save event.

Shortcut: If you start typing after opening the Calendar, you are automatically entering the subject in a Meeting entry.

Set Calendar Alarm

When you set the alarm to **On**, scroll ▼ to set the alarm time and date.

When the alarm rings, press **Stop**  to stop the alarm. Press **Snooze**  or any other key to snooze the alarm.

Set Event Repeat Cycle

When an event occurs regularly; for example, baseball practice or music lessons, open the **Repeat** field to set interval time periods such as **Weekly** or **Monthly**.

Week View

Days of the week are displayed in columns. Each hour of a day is denoted by a cell.

Meeting notes	A bar during the scheduled time periods.
Memo icons	Appear between 7am and 8am
Anniversary icons	Appear between 7am and 8am
Current weekday	Underlined (if you are viewing the current week).
Selected date	Boxed; date also appears in the navigation bar.
Screen title	Either the week number or the week dates of the current week, depending on Calendar setting.

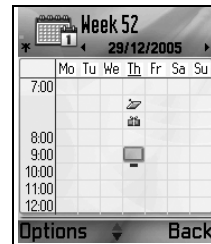

Day View

To view a certain day, scroll to the date and open.

Scheduled events are listed.

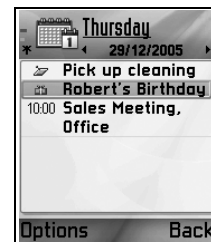

EDIT CALENDAR EVENTS

1. Scroll to desired date in any view and open.
2. Scroll to scheduled event and open. Edit desired fields.
3. Press **Done** when finished.

DELETE EVENTS

1. Scroll to desired date in Month or Week view, and time period in Week view and open.
2. Press **Options** and select **Delete** or press **C**.

To delete multiple events:

1. View the calendar in Month view.
2. Press **Options** and select **Delete entry > Before date** to delete entries before your specified date, or **All entries**.

CALENDAR SETTINGS

From **Calendar** application:

1. Press **Options** and select **Settings**. Open each option:

Calendar alarm tone	Scroll to select desired tone (after a brief pause tone will play).
Default view	Select Month view , Week view , or Day view .
Week starts on	Choose starting day of the week.
Week view title	Choose Week number of the year (e.g. Week 12) or Week dates (e.g. 20.03.05-26.03.05).

Note: **Week view title** setting is available only if **Week starts on** is set to Monday.
Week numbers are shown in layouts only if **Week starts on** is set to Monday.

SEND CALENDAR EVENTS

Before a Calendar event can be sent by Messaging or to another device, it is converted to an electronic scheduling exchange format known as vCalendar.

1. From an open Calendar event in Day view, press **Options** and select **Send > Via text message**, **Via multimedia**, **Via e-mail**, **Via Bluetooth** or **Via infrared**.
2. To complete text messages, see page 42; or multimedia messages on page 42; or e-mail messages on page 44; or Bluetooth on page 83; or Infrared on page 85.

CHINESE LUNAR CALENDAR

Check Chinese Lunar Calendar dates and festivals when still viewing western Calendar information.

Note: Chinese Lunar Calendar will appear only when a Chinese language is selected as the phone display language.

To display Chinese Lunar Calendar information:

1. From the open Calendar, press **Options** and select **Settings**.
2. Scroll to **Lunar calendar**.
3. Select **On**.
4. To view Chinese Lunar Calendar detail, press **Options** and select **View lunar data**.

To turn off Chinese Lunar Calendar information:

1. From the open Calendar, press **Options** and select **Settings**.
2. Scroll to **Lunar calendar**.
3. Select **Off**.

MESSAGES

Messages menu contains these main options:





VOICE MAIL

Voice mail service stores voice messages from callers who could not reach you. The messages are stored on your wireless service provider's network, not on your phone. You must first subscribe to voice mail from your wireless service provider before using this service.

Listen to Voice Mail Messages

When you receive a new voice mail message, an alert sounds if ringtone is not set to silent, and the voice mail icon  displays.

1. Press and hold  in standby mode to dial your voice mail message centre.
 - You can also press  and  in standby mode.
2. Follow the prompts to listen to your voice mail messages.

If the phone asks for the voice mailbox number, enter the voice mail message centre phone number given to you by your wireless service provider.

To change the voice mailbox number, from **Messages** application:

1. Open **Voice mail**.
2. Press **Options** and select **Change number**.

MESSAGES

Send, receive, and store messages from text message (SMS), multimedia (MMS), e-mail, service and cell broadcast.

Messaging Types

SMS: Short Message Service allows you to send and receive short text messages to mobile phones with short text message capability on the same network or any network that has a roaming agreement. A small black and white picture message can be inserted in the message.

MMS: Multimedia Messaging Service allows you to send messages containing images, video clips, sound clips and text. Presentation templates are available to place media objects into prearranged layouts. Multimedia messages can be sent to another mobile phone with multimedia capability or to an e-mail address.

E-mail: Create, send and receive e-mail messages, which can have attachments.

Smart messages: Messages containing data such as electronic business cards, ringing tones, Java™ applications or configuration data such as WAP and multimedia settings.

These services do not work by sending messages directly to the recipient, instead they store and forward messages through specifically designated network servers.

Before Using Messaging Services

Before you can use multimedia or e-mail messaging, your connection settings must be configured.

Your multimedia configuration settings may already be set by your wireless service provider. If settings are not available, contact your wireless service provider.

Your e-mail configuration settings are provided by an Internet Service Provider (ISP) that supports POP3/IMAP4/SMTP protocols.





Before you can send and receive e-mail:

(1) you need a subscription for data services, (2) contract must be set up with an ISP, (3) you must configure an Internet Access Point (see *Access Point Settings* on page 96).

Messages Menu Main Options

New message Create new messages.	Drafts Stores unfinished messages.
Inbox Stores received messages except e-mail and cell broadcast.	Sent Stores sent messages.
My folders Stores moved messages and templates.	Outbox Temporarily stores messages waiting to be sent.
Mailbox Receives and stores e-mail messages.	Reports Delivery status on text, multimedia, and smart messages.

In some main Messages options, icons indicate the message type:

- | | | |
|--|---|---|
|  Text message |  Bluetooth |  Cell broadcast |
|  Multimedia |  Infrared |  Unknown |
|  E-mail |  WAP push |  Attachment |
|  Smart | | |

To view Cell Broadcast messages, see page 56.

CREATE NEW TEXT MESSAGES

From **Messages** application:

1. Open **Messages**.
2. Open **New message** and select **Text message**.
3. In the To field, type in recipient's phone number.
 - To retrieve from Contacts card, press **☺**, or **Options** and select **Add recipient**. Scroll to desired name and press **OK**. Select desired number if entry has several numbers.
 - To separate multiple recipients, enter a semicolon (;) by pressing **☒**.
4. Scroll **▼** to move to text entry field, enter text.
5. If desired, press **Options** and select **Insert >**

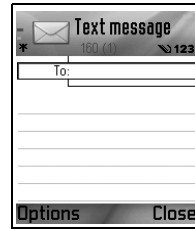

Picture	Picture msg. from Media Gallery
Template	Select from a list of sentences in which you fill in the blank

6. To send, press **☛** or press **Options** and select **Send**.

Note: Text messages have a 160 character limit. The counter keeps track of total characters available. If you use more than 160 characters, a new text message starts, but appears as one message or more at destination. You may be charged for more than one text message.

CREATE NEW MULTIMEDIA MESSAGES

From **Messages** application:

1. Open **Messages**.
2. Open **New message** and select **Multimedia message**.
3. In the To field, type in recipient's phone number or e-mail address.
 - To retrieve from Contacts card, press **☺**, or **Options** and select **Add recipient**. Scroll to desired name and press **OK**. Select desired number if entry has several numbers. Card must have a phone number or e-mail address to be visible.
 - To separate multiple recipients, enter a semicolon (;) by pressing **☒**.
4. Scroll **▼** to move to text entry field, enter text.
5. If desired, press **Options** and select **Insert >**

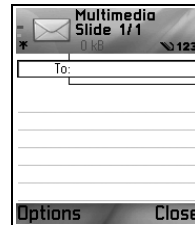

Image	Image from your Images folder
Sound clip	Sound clip from your Sound clips folder
Video clip	Video clip from your Video clips folder
New image	New image from Camera
New sound clip	New sound clip from Voice Recorder

Slide	Add new slide to message
--------------	--------------------------

6. To send, press  or press **Options** and select **Send**.

Note: If multimedia messages are sent to devices without multimedia or e-mail capabilities, the recipient may receive a message containing a link to a web page.

Create Presentation

Choose from four presentation templates to create an impressive multimedia show.

1. Complete steps 1, 2 and 3 in *Create New Multimedia Messages* on page 42.
2. Press **Options** and select **Create presentation**.
3. Select from the list of templates:
 - Image template
 - Video template
 - Sm. image tem.
 - Temp. with title
4. Highlight desired template, press **Select**.
5. Scroll to the video, text, or image region of the template to highlight it.
6. If desired, press **Options** and select **Insert >**

Image	Image from your Images folder
Sound clip	Sound to play at start of show
Video clip	Video clip from your Video clips folder
Note	Note from Notepad (if a text region is highlighted)
New image	New image from Camera
New slide	Add new slide to show

Note: Available choices depend on region highlighted.

7. Press **Options** and select:

Send	Send completed presentation
Full screen	Edit in full screen view
Normal screen	Edit in normal screen view with signal icon, slide number, and softkey labels in view
Edit text	Start or stop text editing, change text colour
Preview message	Preview entire message before sending
Remove >	Remove image, sound clip, video clip, or current slide
Backgrnd. settings >	Set background colour, add background image to current slide or entire presentation, remove background image

Effect settings >	Set transition effect between images and between slides
-----------------------------	---

- To send, press **Send** or press **Options** and select **Send**.

CREATE NEW E-MAIL MESSAGES

Before you can write an e-mail message, at least one mailbox must be configured. See page 48.

From **Messages** application:

- Open **Messages**.
- Open **New message** and select **E-mail**.
- In the To field, type in recipient's e-mail address.
 - To retrieve from Contacts card, press **Options** and select **Add recipient**. Scroll to desired name and press **OK**. Card must have an e-mail address to be visible.
 - To separate multiple recipients, enter a semicolon (;) by pressing **Options**.
- Scroll **Down** to enter recipients in Cc (courtesy copy) field and type subject in subject field (both fields optional).
- Scroll **Down** to move to text entry field, enter text.
- If desired, press **Options** and select **Insert >**

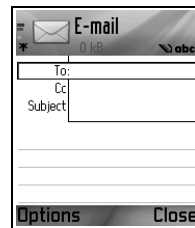



Image	Image from your Images folder
Sound clip	Sound clip from Sound clips folder
Video clip	Video clip from Video clips folder
Note	Note from Notepad
Template	Select from a list of sentences in which you fill in the blank

- To send, press **Send**, or press **Options** and select **Send**.
 - To view, add, or remove attachments before sending, press **Options** and select **Attachments**.
 - If phone is set to send e-mail during next connection to mailbox, then pending e-mail will be stored in Outbox. Change setting by pressing **Options** and selecting **Sending options**.

COMMON WRITING TASKS

- To cut, copy and paste text, see page 24.
- To save before sending, press **Close**. Message is automatically stored in Drafts folder.
- To match names in To and Cc fields to names in Contacts, press **Options** and select **Check contacts**.

RECEIVE NEW MESSAGES

When you receive a new message, the standby screen displays a new message icon  and a note indicating the number of new messages. Press **Show** to read the message. If there is more than one message, press **Show** to open the Inbox, then scroll to the desired message header and open.

INBOX (RECEIVED MESSAGES)

Inbox stores received text, multimedia, and smart messages. Incoming Bluetooth; Infrared; WAP push; SIM; and voicemail, e-mail waiting messages are also placed here.

The messages remain in the Inbox until you move them to My folders or delete them.



 Unread messages have incoming arrow appearing with icon that identifies type of message.

 Read messages have no arrow with icon.

Read or Play Inbox Messages

From **Messages** application:

1. Open **Messages**.
2. Scroll to **Inbox** and open.
3. A list of message headers displays, indicating type of message sender (Multimedia, Bluetooth, etc.) and icon. Scroll to desired message header and open.
 - The message may first need to be retrieved from the network server depending on the message type or if it contains large files.
 - Press **Play** if needed for video clips, sound clips and presentations.
 - If the message contains an image, it opens automatically.

Note: Scroll   to decrease or increase audio volume.

Reply to and Forward Inbox Messages

From **Messages** application:

1. Open **Messages**.
2. Select **Inbox**.
3. Scroll to desired message, press **Options** and select **Reply > To sender** or **To all** or **Forward**.
4. To reply, enter text in text field.
To forward, enter recipient(s) phone numbers or e-mail addresses.
5. Press .

Note: The phone may not allow you to copy, modify, transfer, or forward some copyrighted images, ringtones and other content.

Store Inbox Messages

From **Messages** application:

1. Open **Messages**.
2. Select **Inbox**.
3. Highlight desired message.
4. Press **Options** and select **Move to folder**.
5. Choose a folder and press **OK**.

Save Attachment or Data

You can save images and media clips from messages. Attachments to e-mail, links to streaming media, Contacts cards, Calendar items, ringtones, and configuration data can also be saved.

1. Open desired message.
2. Press **Options** and select **Save**.
 - If needed, the data is directed to the appropriate application.
3. If needed, select to save either in phone memory or miniSD Card, press **OK**.
4. If needed, scroll to desired folder to place object or attachment, press **Open** or **Save**. If desired, rename the file. Press **Save**.

Note: Received applications or games can be installed directly from the Inbox. When you open the message, the phone asks if you want to install it now.
An attachment or object remains in the Inbox after it is saved to another application. To save memory space, delete message from Inbox.

Find Phone number, E-mail or Web Address in Message

Within received messages, you can find a phone number, e-mail or web address within message text and use it to call, write, access a service or create a Contacts card.

From **Messages** application:

1. Open **Messages**.
2. Scroll to **Inbox** or **My folders** and open.
3. Scroll to desired message and open.
4. Press **Options** and select **Find > Phone number, E-mail address, or Web address**.
5. Text and numbers are highlighted when found. If more than one is found, scroll to highlight desired item.
6. Press **Send** to **Send** a message, **Add to Contacts** to add or update Contacts, **Call** a number, **Go to web address**, or **Add to bookmarks** to add web address to bookmarks.

MY FOLDERS (ORGANISE MESSAGES)

Store your messages in My folders. You can also create and name new folders. For example, create a folder for Friends and one for Family messages. Folders can also be created by message type or by subject.

From **Messages** application:

1. Open **Messages**.
2. Select **My folders**.
3. Press **Options** and select **New folder**.
4. Enter a name for your folder and press **OK**.

Note: You cannot create folders within a folder.

To rename or delete a folder, from **Messages** application:

1. Open **Messages**.
2. Select **My folders**.
3. Scroll to desired folder, press **Options** and select **Rename folder** or **Delete**.

Templates

Templates are short sentences in which you fill in the blank, then send the message. Template sentences can also be inserted into longer messages.

From **Messages** application:

1. Open **Messages**.
2. Select **My folders**. Select **Templates**.
3. Scroll to desired text. Press **Options** and select **Send > Via text message**, **Via multimedia**, or **Via e-mail**.
4. Press **⬤** and a new message opens with template text already placed.
5. Fill in needed information and press **↵**.

Note: In longer messages, at cursor, press **Options** and select **Insert > Template**. Template text is placed at cursor.

To create your own template text, from **Messages** application:

1. Open **Messages**.
2. Select **My folders**. Select **Templates**.
3. Press **Options** and select **New template**.
4. Enter text, numbers, or symbols, and press **Done**.

MAILBOX (E-MAIL MESSAGES)

E-mail is received and stored in a separate mailbox. Once you set up a mailbox, Mailbox will be renamed and appear with its new name in the main Messages list. You can set up to 6 mailboxes, each appears separately in the main Messages list.

After your e-mail is set up, use the mailbox to view and send e-mail. Files such as images, sound and video clips can be attached from phone memory or miniSD Card. Supported e-mail clients include a standard POP3, IMAP4, SMTP, MIME client. E-mail messaging takes place over CSD and GPRS bearerset using standard Internet e-mail protocols over TCP/IP.

Note: Before you can send or retrieve e-mail, you must first set up a mailbox.

Configure Mailboxes

From **Messages** application:

1. Open **Messages**.
2. Press **Options** and select **Settings**.
3. Scroll to **E-mail** and open.
4. Highlight **Mailboxes** and open.
5. Press **Options** and select **New mailbox**.
6. Enter information in fields. Fields marked in the phone with a red asterisk (*) must have an entry.

Mailbox name	Use default name or enter a name for your mailbox and press OK .
* Access point in use	Default Access Point supplied by wireless service provider
* My e-mail address	Enter your own e-mail address and press OK . May be supplied by wireless or Internet service provider.
* Outgoing mail server	Enter SMTP mail server address.
Send message	Choose During next conn. or Immediately .
Send copy to self	Select Yes or No .
Include signature	Select Yes to enter a signature for outgoing messages.
User name	Enter a name to log into service provider remote mailbox.
Password	Enter password.
* Incoming mail server	Enter address of incoming mail server (POP or IMAP), supplied by service provider.
Mailbox type	Select POP3 or IMAP4 .
Security	Select Off or TLS (Transport Layer Security). TLS ensures privacy. Determined by Internet service provider.