

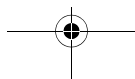

Contents

Important information	5
Overview of features	9
SIM and battery	10
Quick start	13
Your phone	17
Display icons	19
Menu structure	21
Voice calls	23
Text entry	30
Settings	33
Contacts list	51
Games	59
Browser	61
Camera	66
Messaging	72
Data folders	90
Organiser	101
Connect	111
Accessories	116
Care and maintenance	119
Troubleshooting	121
Glossary	124

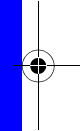

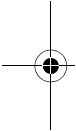
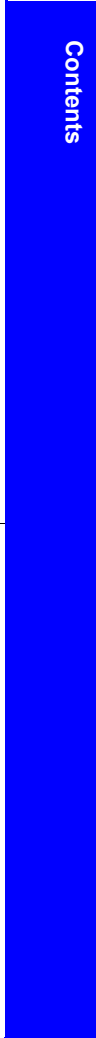

Contents

Specifications 126
EU warranty and licensing 128
Personal settings and notes . . . 136
Index 139

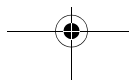
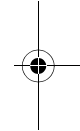
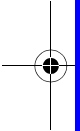



Important information

Thank you for purchasing this Panasonic digital cellular phone. This phone is designed to operate on GSM networks – GSM900, GSM1800 and GSM1900. It also supports GPRS for packet data connections. Please ensure the battery is fully charged before use. We, Panasonic Mobile Communications Development of Europe Ltd., declare, that the EB-X70 conforms with the essential and other relevant requirements of the directive 1999/5/EC.

A Declaration of Conformity to this effect can be found at <http://www.panasonicmobile.com>

Safety considerations

You should read and understand the following information as it provides details for operating your phone in a manner which is both safe to you and your environment, and conforms to any legal requirements regarding the use of cellular phones.



A Fast Travel Charger (EB-CAX70UK or EB-CAX70EU) is supplied with the phone. Other recommended equipment for charging is the Car Charger (EB-CDX70).

This equipment should only be charged with approved charging equipment, to ensure optimum performance and avoid damage to your phone. Other usage will invalidate any approval given to this apparatus and may be dangerous. Ensure the voltage rating of the Fast Travel Charger is compatible with the area of use when travelling abroad.



Use of a battery pack other than that recommended by the manufacturer may result in a safety hazard.

If you use a feature that keeps the key backlight on continuously for a long time, for example, Camera, Games, or Browser, you will reduce your battery life. To maintain longer battery life, set the key backlight off. See Setting the key backlight on page 34.



Switch off your cellular phone when in an aircraft. The use of cellular phones in an aircraft may be dangerous to the operation of the aircraft, disrupt the cellular network and may be illegal. Failure to observe this instruction may lead to the suspension or denial of cellular phone services to the offender, or legal action or both.



Do not incinerate or dispose of the battery as ordinary rubbish. The battery must be disposed of in accordance with local legislation and may be recycled.

Important information

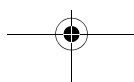

Important information



It is advised not to use the equipment at a refuelling point. Users are reminded to observe restrictions on the use of radio equipment in fuel depots, chemical plants or where blasting operations are in progress.

Never expose the battery to extreme temperatures (in excess of 60°C).



It is imperative that the driver exercises proper control of the vehicle at all times. Do not hold a phone while you are driving; find a safe place to stop first. Do not speak into a handsfree microphone if it will take your mind off the road. Always acquaint yourself thoroughly with restrictions concerning the use of cellular phones within the area you are driving and observe them at all times.



Care must be taken when using the phone in close proximity to personal medical devices, such as pacemakers and hearing aids.

Do not leave the camera facing direct sunlight, as this may impair its performance.



For most efficient use hold the phone as you would any normal phone. To avoid deterioration of signal quality or antenna performance, do not touch or cup the antenna area while the phone is switched on. (See SAR on page 8). Unauthorised modifications or attachments may damage the phone and violate applicable regulations. The use of an unapproved modification or attachment may result in the invalidation of your guarantee – this does not affect your statutory rights.

This equipment should only be used with Panasonic approved accessories to ensure optimum performance and avoid damage to your phone. Panasonic is not responsible for damages caused by using non-Panasonic approved accessories. This Panasonic mobile phone is designed, manufactured and tested to ensure that it complies with the specifications covering RF exposure guidelines applicable at the time of manufacture, in accordance with EU, USA FCC, and Australian ACA regulations.

Please refer to our website for latest information/standards compliance in your country/region of use.

<http://www.panasonicmobile.com>



Important information

This phone must be used in compliance with any applicable international or national law governing its use in specified applications and environments. This includes use in hospitals, aircraft, and whilst driving or refuelling a vehicle.

It is recommended that you create a copy or backup as appropriate for any important information and data which you store in your phone's memory. In order to avoid accidental loss of data, please follow all instructions relating to the care and maintenance of your phone and its battery. Panasonic Mobile Communications will not accept any liability for loss of data if these instructions are not followed.

Your phone has the capability of storing and communicating personal information such as a credit card number. It is recommended that you take care to ensure that this information is secure and protected with any security features provided. Panasonic Mobile Communications will not accept any liability for damages resulting from misuse of such personal information.

Your phone has the capability of downloading and storing information and data from external sources, and from the internal camera. It is your responsibility to ensure that in doing this you are not infringing any copyright laws. Panasonic Mobile Communications will not accept any liability for damages resulting any such infringement.

You are advised to take appropriate care over the use of the internal camera. It is your responsibility to ensure that you have permission to take photographs of people and objects and that you do not infringe any personal and public rights in the use of the camera. You must comply with any applicable international or national law governing camera use in specified applications and environments. This includes not using the camera in places where the use of photographic and video equipment is prohibited.

The display layouts and screenshots within this document are for illustrative purposes and may differ from the actual displays on your phone. Panasonic Mobile Communications reserve the right to change the information in this document without prior notice.

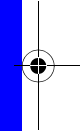
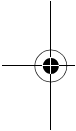

Important information

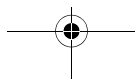



Important information

SAR

European union - RTTE

THIS PANASONIC PHONE (MODEL EB-X70) MEETS THE EU REQUIREMENTS FOR EXPOSURE TO RADIO WAVES.

Your mobile phone is a radio transmitter and receiver. It is designed and manufactured not to exceed the limits for exposure to radio frequency (RF) energy recommended by The Council of the European Union. These limits are part of comprehensive guidelines and establish permitted levels of RF energy for the general population. The guidelines were developed by independent scientific organisations through periodic and thorough evaluation of scientific studies. The limits include a substantial safety margin designed to assure the safety of all persons, regardless of age and health.

The exposure standard for mobile phones employs a unit of measurement known as the Specific Absorption Rate, or SAR. The SAR limit recommended by The Council of the European Union is 2.0 W/kg.* Tests for SAR have been conducted using standard operating positions with the phone transmitting at its highest certified power level in all tested frequency bands. Although the SAR is determined at the highest certified power level, the actual SAR level of the phone while operating can be well below the maximum value. This is because the phone is designed to operate at multiple power levels so as to use only the power required to reach the network. In general, the closer you are to a base station antenna, the lower the power output.

Before a phone model is available for sale to the public, compliance with the European R&TTE directive must be shown. This directive includes as one essential requirement the protection of the health and the safety for the user and any other person. The SAR value for this model phone, when tested for use at the ear, for compliance against the standard was 0.459 W/kg. While there may be differences between the SAR levels of various phones and at various positions, they all meet the EU requirements for RF exposure.

* The SAR limit for mobile phones used by the public is 2.0 watts/kilogram (W/kg) averaged over ten grams of tissue. The limit incorporates a substantial margin of safety to give additional protection for the public and to account for any variations in measurements. SAR values may vary depending on national reporting requirements and the network band.

For SAR information in other regions please look under product information at <http://www.panasonicmobile.com/health.html>

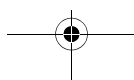
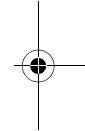
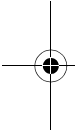

Overview of features

Your phone has the following features:

Bluetooth® connectivity

Use this to transfer information between your phone and another Bluetooth® device.

Calculator

Use this to perform basic calculations.

Camera

Use the digital camera to take pictures to send in your messages or use as your wallpaper.

Converter

Use this to convert currency values when you are abroad.

Games

Use this to play games on your phone.

Infrared connectivity

Use this to transfer information between your phone and another device that has an infrared port.

MMS (Multimedia Messaging)

Use this to send and receive pictures and sounds.

Schedule

Use this to set reminders for important events.

SMS (text messaging)

Use this to send and receive text messages.

SMS Chat

Use this to have a text conversation.

Synchronization

Use this to synchronize your Schedule and Contacts List with an external server.

Voice dial

Use this to dial a number by talking to the phone.

WAP browser

Use this to access the Internet.



SIM and battery

Fitting and removing the SIM

You insert the SIM into the back of the phone, underneath the battery.

If your SIM contains contact details, the first time that you turn the phone on after you have fitted the SIM, you are asked whether you want to transfer the SIM data to your phone.

Fitting the SIM

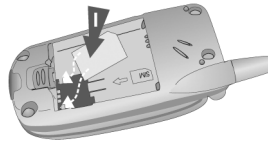

Removing the SIM

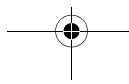
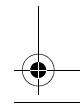
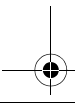
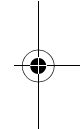
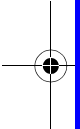
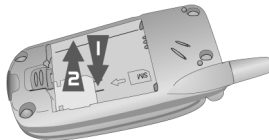

SIM and battery

Fitting and removing the battery

Before you remove the battery, ensure that the phone is switched off and that the charger is disconnected from the phone.

Fitting the battery

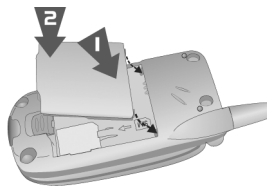

Removing the battery

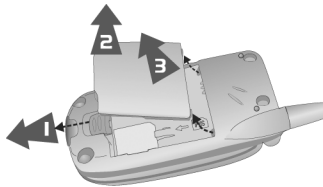

Charging the battery

The battery must be fitted in the phone before you connect the charger. Press the button on the top of the connector and insert it into the base of the phone.

Note: Do not force the connector as this may damage the phone and/or the charger.

Connect the charger to the mains power supply. When the phone is charging, the charging indicator will light and a flashing plug icon will appear in the main display and the case screen.

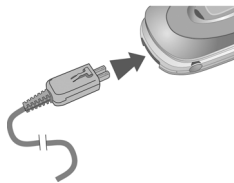

When charging is complete, turn off the mains power supply and disconnect the charger.



SIM and battery

While the battery is charging, the following icons appear on the phone's display and case screen:

	While charging	Charging complete
Phone on	Flashing	
Phone off	Flashing	No icon.

Low battery warning

When the battery power is low, a warning tone sounds, and a flashing low battery icon () is displayed. If this happens during a conversation, end your call immediately. The power automatically shuts off after the warning tone. You need to fully recharge your battery, see Charging the battery on page 11. You can still make and receive calls while the battery is charging.

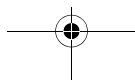
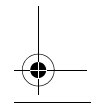
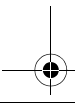
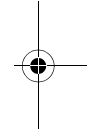
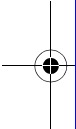

Quick start

Note: Some services are network dependent or may only be available on a subscription basis. Some functions are SIM dependent. For more information contact your service provider.

Switching the phone on and off

To switch the phone on or off, press and hold .



If you have set an animation and greeting, these are displayed. The phone starts in idle mode.

Making calls

Ensure that the phone is switched on, the network operator logo is displayed and the signal strength icon shows that network coverage is available in the current area.

- ▶ From idle mode, enter the area code and phone number.
- ▶ Press .

Camera mode

To change to camera mode either select **Camera** from the main menu (press  twice), or press  from idle mode if the shortcut key is set for camera.

Leaving camera mode

To leave camera mode press  to return to idle mode.

Taking a picture

- ▶ When you are in camera mode, move the phone around until you can see the image you want on the preview screen.
- ▶ Press  to capture the image.

If you decide that you do not want the image that you have taken, you can press  to delete it.



Quick start

Setting the wallpaper

The wallpaper is a picture that displays when the phone is in idle mode.

- ▶ Select **Menu > Data Folders**.
- ▶ Find a picture.
- ▶ Select **Menu > Use As > Wallpaper**.

Or

- ▶ Select **Menu > Settings > Display > Wallpaper**.
- ▶ Select the folder where the picture is stored.
- ▶ Select your picture.

Setting the ring type

- ▶ Select **Menu > Data Folders**.
- ▶ Find a sound.
- ▶ Select **Menu > Use As**.
- ▶ Select the type of call.

Or

- ▶ Select **Menu > Settings > Alerts > Ring Type**.
- ▶ Select the type of call that you want to change.
- ▶ Select the folder where your sound is stored.
- ▶ Select your sound.

Setting quiet mode

In quiet mode the microphone amplifies your voice, so you can whisper and still be heard by the person on the other end of the call. You should use quiet mode in situations where you do not want to disturb the people around you.

In quiet mode, the phone will not ring when you receive a call or message, unless you set a ring volume for quiet mode.

From idle mode, press and hold .

Or

Select **Menu > Settings > Alerts > Quiet Mode > On/Off > On**.

Using your browser

Before you can start using your browser, you need to contact your service provider. When your phone is set up to access the internet see Start browser on page 62 for information about using the browser.

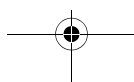
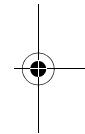
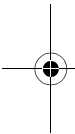

Quick start

Creating a multimedia message



Use the **Create** option on the **Messaging** menu to create a multimedia (MMS) message.

- ▶ Select **Create > MMS**.
- ▶ Press **OK**.
- ▶ Select the item that you want to enter.
- ▶ When your message is complete, select **OK**.
- ▶ Select **Addr:**.
- ▶ Select **Edit** to enter an address.
- ▶ Enter an address.
- ▶ Select **Subj:**.
- ▶ Select **Edit** to enter a subject.
- ▶ Enter a subject.

To send your message, press **Send** or press **OK** and select **Send**.

To save your message press **Save** and select **Save**. Your message is stored in the **Outbox**, so you can send it or edit it later.

Creating a text message



Use the **Create** option on the **Messaging** menu to create a text (SMS) message.

- ▶ Select **Create > SMS**.
- ▶ Enter your text.
- ▶ Press **OK**.
- ▶ Select **Ok** or **Cancel**.
- ▶ Press **Send** to send the message.
- ▶ Enter the phone number.
- ▶ Press **OK**.
- ▶ Select **Ok** or **Cancel**.
- ▶ You are asked '**Request Delivery Confirmation?**' Press **OK**.
- ▶ Select **No** or **Yes**.

Menu > Messaging > Create

Quick start



Quick start

Setting up the Bluetooth® headset

The headset gives you wireless, hands free operation.

Before you can use the headset you need to pair the headset and the phone.

First you need to turn on Bluetooth® on the phone:

Select **Menu > Connect > Bluetooth > On/Off > On**.

The Bluetooth® icon appears on the screen.

You now need to set up the headset:

- ▶ Turn on the headset. (See headset instructions).
- ▶ Make the headset discoverable. (See headset instructions).

Note: The headset is only discoverable for a short time. If it is not discovered during this period, the pairing will fail. You can try again by making the headset discoverable again.

Finally you need to pair the devices:

- ▶ On the phone select **Discover & Pair**.
As the phone discovers devices it displays them on the screen.
- ▶ When the headset appears in the list you can select **Stop** to stop the search.
- ▶ If the phone does not discover your headset, press  to try again.
- ▶ Highlight the headset in the list.
- ▶ Select **Pair**.
- ▶ Enter the Bluetooth® Passkey provided with the headset.

Note: The pairing will fail if you enter the wrong passkey, or if the headset is already paired with another device.

You can select **Paired Devices** to confirm that the devices are paired. This lists all the devices that are paired with the phone.

Once the headset and phone are paired, you can answer calls using the headset. If the headset is on when you receive a call, the headset rings. For information on how to answer a call with the headset, see the headset instructions.

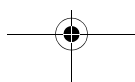

Your phone



Your phone



Your phone

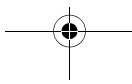
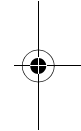
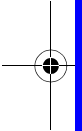
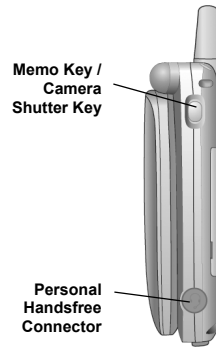
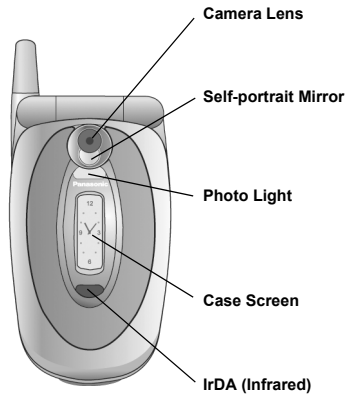



Display icons

After some operations, the display automatically clears after three seconds or when you press any key.

Status icons

The status icons are displayed according to the currently activated functions. The antenna, GSM signal strength and battery icons are displayed when the phone is switched on and connected to a network.

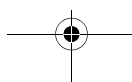
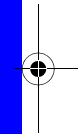
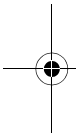
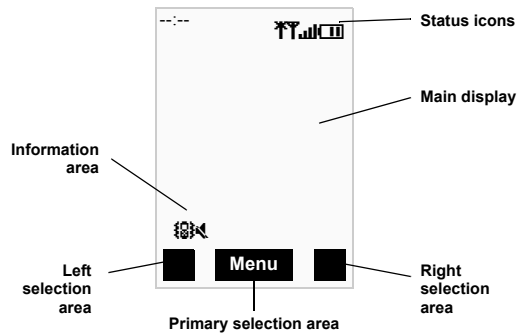



Display icons



Registered to a non-home network - Roaming.



The number of the current call when connected to two calls.



Call divert on.



New message received.



Message store is full.



GPRS service available.



Antenna. Indicates that you can make a call. If it is the only icon displayed, you can only make emergency calls.



GSM signal strength: - weak signal, - strong signal.



Battery level: - full, (flashing) - low.



All tones off or ring volume off.



Vibration alert on.



Quiet mode on.



Phone lock on.



Alarm set.



Bluetooth® enabled



Menu structure

The nine main menus are as follows:

Note: The menus may not display in the same order or with the same icons as listed here. The order and icons vary according to your service provider.



Settings

- 1 Display
- 2 Alerts
- 3 Keys
- 4 Phone Settings
- 5 Clock
- 6 Call Service
- 7 Call Divert
- 8 Security
- 9 Network
- 10 Defaults



Contacts List

- 1 Browse
- 2 Create
- 3 Voice Dial
- 4 Groups
- 5 Settings
- 6 SIM
- 7 Storage



Games

- 1



Browser

- 1 Home Page
- 2 Bookmarks
- 3 Enter URL
- 4 Page Memo
- 5 Push Message
- 6 Browser Settings
- 7 Server List
- 8 Cookie
- 9 Last Status



Camera



Messaging

- 1 Settings
- 2 Inbox
- 3 Broadcasts
- 4 Voice Mail
- 5 Create
- 6 e-mail
- 7 Data Folders
- 8 Outbox
- 9 SMS Chat



Data Folders

- 1 My Pictures
- 2 My Sounds
- 3 My Themes
- 4 User 1 - 5



Organiser

- 1 Synchronization
- 2 Contacts List
- 3 Converter
- 4 Business Card
- 5 Schedule
- 6 Calculator
- 7 Alarm
- 8 Memo
- 9 Receive object



Connect

- 1 Bluetooth
- 2 Infrared Dialup
- 3 Receive Object

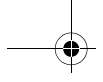

Menu structure

Navigation key

The navigation key is a multi-function key. You use the top, bottom, left and right edges to move around the display. These actions are indicated by , , and in this user guide. You press the centre of the navigation key to:

- Access the menu system.
- Display a submenu.
- Select a highlighted menu item.
- Confirm a selection.
- Select the item in the primary selection area.
- Take a picture with the camera

Menu shortcuts

When you are familiar with the menu system, you can enter the menu number instead of navigating through the display menus. For example, to browse your contacts list:

From idle mode, press , 2, 1.

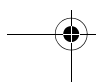
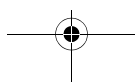
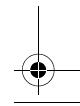
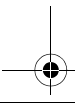
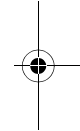
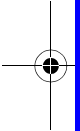

Voice calls

Making calls

Ensure that the phone is switched on, the network operator logo is displayed, and the antenna and signal strength icons (📶) show that network coverage is available in the current area.

- ▶ From idle mode, enter the area code and phone number.
- ▶ Press .

Ending calls

Press .

Answering a call

To receive a call the phone must be switched on and the signal strength icon (📶) must be displayed.

To answer a call, press any key except .

Answering a call handsfree

Press and hold .

Note: Do not hold the phone to your ear when in handsfree mode.

Sending DTMF tones during a call

You can send DTMF tones during a call to access voice mail, paging and computerised home banking. For example, you may need to enter a number to remotely access voice mail messages.

To send DTMF tones during a call, press the required digit keys.

Rejecting a call

If you do not want to answer an incoming call, press .



Note: If you do not answer a call, or reject a call, the number of incoming calls missed is displayed. Press any key to clear the display.

Voice calls

Making international calls

If you know the international number, you can enter it in the normal way, followed by the area code and phone number.

You can use the automatic international access code (+), to dial international numbers without knowing the code for the international exchange.

- ▶ From idle mode, press and hold  until + is displayed.
- ▶ Use  to scroll through a list of country codes.
- ▶ Select the code you want.
- ▶ Enter the area code and phone number.
- ▶ Press .

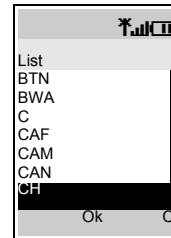

Note: Many countries/regions include an initial 0 in the area code. In most cases, you should omit this when dialling international numbers. If you have difficulties making international calls, contact your service provider.



Making emergency calls

To make an emergency call, the antenna symbol () must be present.

If a SIM is installed, enter 112 and press .

If a SIM is not installed, press , select **SOS**, press .

Note: Making Emergency calls without a SIM installed is country or SIM dependent.

Using automatic redial

If a connection is unsuccessful, press  when **Ok** is displayed.

To stop redialling, press  when **Cancel** or **C** is displayed.

Using hotkey dialling

If you have set up hotkey dialling, you can press and hold a digit key to call contacts on your **Contacts List**. As each entry in your **Contacts List** is stored in a numbered location, press and hold the digit key relating to that location. To turn on hotkey dialling see Enabling and disabling hotkey dialling on page 57.

Voice calls

Displaying caller ID

Note: This is network dependent.

If the caller's number and name are stored in your **Contacts List**, they can be displayed during an incoming call.

Note: Caller ID may not always be available.

Setting the ear piece volume

During a call press **Q** to adjust the ear piece volume.

Note: You can adjust the volume for the personal handsfree accessory in the same way.

Swapping between handsfree and handheld modes

From handheld to handsfree

- ▶ Press **Q**.
- ▶ Select **H*free**.

From handsfree to handheld

Press **Q** twice.

Holding a call

- ▶ Press **Q**.
- ▶ Select **Hold**.

Resuming a call

- ▶ Press **Q**.
- ▶ Select **Resume**.
- ▶ Press **Q**.

Voice calls



Voice calls



Making a second call

Note: This is network dependent .

If **Call Waiting** is enabled, you can make a second call. You can check your call waiting status from **Settings > Call Service > Calls > Call Waiting**.

Note: You cannot make more than one fax or data call at a time.

You must end all voice calls before you can make or receive a fax or data call.

- ▶ Press .
- ▶ Select contact number to dial.
- ▶ Select **Recall**.
- ▶ Press .
- ▶ Press .

The first call is put on hold.

Receiving a second call

Note: This is network dependent .

If **Call Waiting** is enabled, you can receive a second call. You can check your call waiting status from **Settings > Call Service > Calls > Call Waiting**.

Note: You cannot receive more than one fax or data call at a time.



You must end all voice calls before you can make or receive a fax or data call.

Accept or reject a second call

- ▶ Press .
- ▶ Select **Accept** or **Reject**.

Note: If you accept the second call, the current call is put on hold.

End current call and receive second call

- ▶ Press .
- ▶ Press  to answer the second call.

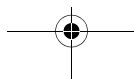
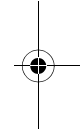
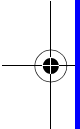

Operating during two calls

Swapping between calls

An icon (1 or 2) indicates the current call.

- ▶ Press .
- ▶ Select **Swap** to change to the other call.

Ending current call

- ▶ Press .
- ▶ Select **End**.

Ending both calls

Press .

Transferring a call

When you are connected to two calls, you can connect them together, and end your connections, leaving the two callers to talk to each other.

- ▶ Press .
- ▶ Select **Trans**.

Note: You cannot do this while in multi-party mode.

Multi-party calls

Note: This is SIM dependent .

In a multi-party call three to five people can have a conversation at the same time. You can swap between a multi-party call and another call as you do for two separate calls.

Enabling a multi-party call

- ▶ With two calls connected (one active and one on hold), press .
- ▶ Select **Merge**.

All three parties can now talk to each other.



Voice calls

Adding people

You can add people to the multi-party call (up to a maximum of five), either by making a call or accepting an incoming call. You can then merge the new call into the multi-party.

- ▶ Press .
- ▶ Select **Merge**.

Note: When you make a call or accept an incoming call, the multi-party call is placed on hold. The other callers in the multi-party call can continue to talk to each other while on hold from you.

Splitting a multi-party call

You can select a caller from the multi-party call and remove their connection, so that you can talk privately to them.

- ▶ Press .
- ▶ Select **Option**.
- ▶ Select a caller.
- ▶ Select **Split**.

The selected caller is split from the multi-party and the multi-party call is placed on hold. The remaining multi-party callers can still talk to each other.

Rejoining a multi-party call

When you have finished talking to an individual you can rejoin the multi-party call:

- ▶ Press .
- ▶ Select **Merge**.

Ending a single connection to a multi-party call

- ▶ Press .
- ▶ Select **Option**.
- ▶ Select a caller.
- ▶ Select **End**.

Note: You cannot end an individual caller if you have a call on hold or another call is incoming.

Ending all connections to a multi-party call

Press .

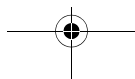





Voice calls

Using the notepad

During a call you can enter numbers that you may want to dial when you have finished the call. You can make a note of these numbers on the notepad.

- ▶ Enter the number.
- ▶ When you have finished your call, press  to dial the number.
or
- ▶ Press  while the number is displayed to store the number in your **Contacts List**.
The current call remains active.

In call options

During a call select **Menu > Menu** to access the following menus:



Schedule, Browser, Contacts List, Messaging and Memo.

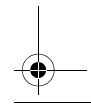
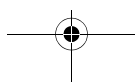
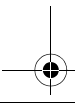
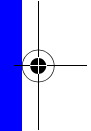
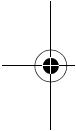











For information on using these menus, see the relevant section in this user guide.



Text entry

You use alphanumeric characters to enter details into the **Contacts List**, to create text and e-mail messages.

There are five different text entry modes: normal (ABC or abc), Greek (ABΓ), extended alphabet (AĀĂ), numbers (0-9) and T9® (T9). To change your text entry mode press , or select **Menu > Input Mode**, and select the mode that you want. The icon for the current mode appears in the information area on the display. To change between upper and lower case letters press . The table below shows the characters that you can enter in the different text modes.

Text Mode					
Key	T9®	Normal (ABC)	Greek	Extended	Numeric (0 - 9)
	Alternatives	+ _			0
	Punctuation	. @ / : ; * # + - = < > ! , ' ? [] { } ' & % \ ^ ~ < > = € £ \$ ¥ ¢ §			1
	abc	ABCabc	ABΓ	AĀĂÆBCÇ aāăæabc	2
	def	DEFdef	ΔEZ	DEÉFdeèèf	3
	ghi	GHIghi	HΘI	GHIghii	4
	jkl	JKLjkl	KΛM	JKLjk	5
	mno	MNOmno	NΞO	MNŃOŃm nñoóo	6
	pqrs	PQRSpqrs	ΠΡΣ	PQRSpqrsß	7
	tuv	TUVtuv	TYΦ	TUÚVtuúv	8
	wxyz	WXYZwxyz	XΨΩ	WXYZwxyz	9
	Shift/Lock	Shift/Lock		Shift/Lock	*
		Space			#

Text entry

T9®



Using T9® reduces the number of key presses required.

When in T9® mode:

- ▶ Press a key once for any letter you require on that key. The desired letter may not be displayed.
- ▶ Continue pressing other keys until the end of a word is reached.
- ▶ Check that the word has been typed correctly before continuing to the next word.
- ▶ If the combination of letters typed has produced a word which is not the one you require, press  until the correct word is displayed.
- ▶ Continue to the next word.
- ▶ If the word you require is not in the internal dictionary, you can enter it using the Normal mode, or add it to the internal T9® dictionary.



Adding entries to the T9® dictionary

If the internal T9® dictionary does not contain a word, name, or abbreviation that you require, you can add it. Words that you add to the T9® dictionary are available for future use.

- ▶ From T9® entry mode, press the key 2 - 9 that displays the character required.
- ▶ Use  to select the required character.
- ▶ Use  to move to the next character.
- ▶ Repeat these steps until the word is complete.
- ▶ Press  to add the word to the internal dictionary.

T9® is a trademark of Tegic Communications Inc. T9® Text Input is licensed under one or more of the following: U.S. Pat Nos. 5,818,437, 5,953,541, 5,187,480, 5,945,928, and 6,011,554; Canadian Pat No. 1,331,057; United Kingdom Pat No. 2238414B; Hong Kong Standard Pat. No. HK0940329; Republic of Singapore Pat No. 51383; Euro. Pat No. 0 842 463 (969272260.8) DE/DK, FI, FR, IT, NL, PT, ES, SE, GB; and additional patents are pending worldwide.

Entering text

In Normal, Greek and Extended modes, each time you press a key in quick succession the next character available on that key is displayed. For example, to enter 'c' you need to press  three times in quick succession. To enter the displayed character, release the key or press another key. The cursor then moves to the next position. If you want to enter two consecutive letters from the same key, for example 'on' or 'll', you may need to press  to move to the next position.

You can also select **Menu > Char.List** and choose a character. Only the characters available in your current text entry mode are displayed.

Text entry



Text entry

Editing text

Press **↑** to move up or down one line of text.

Press **←** or **→** to move left or right one character.

Press **⌫** to delete the character to the left of the cursor.

Press and hold **⌫** to delete the current line.

If you move the cursor over a character and press another key, the new character is inserted immediately before the selected character.

Cut, copy and paste

You can cut, copy and paste text from other messages or contacts list entries on your phone.

To cut text:

- ▶ Select **Menu > Cut**.
- ▶ Move to the start of the text that you want to cut, and select **Start**.
- ▶ Use **⌫** to highlight the text that you want to cut, and select **Stop**.

To copy text:

- ▶ Select **Menu > Copy**.
- ▶ Move to the start of the text that you want to copy, and select **Start**.
- ▶ Use **⌫** to highlight the text that you want to copy, and select **Stop**.

You can only paste text if you have previously cut or copied some text. To paste text:

- ▶ Move where you want to paste the text.
- ▶ Select **Menu > Paste**.

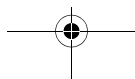
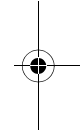
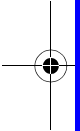



Settings

Use the **Settings** menu to personalise your phone.

Display

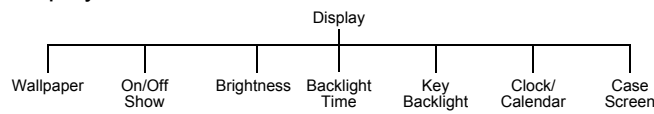

Setting the wallpaper

The wallpaper is a picture that displays when the phone is in idle mode.

- ▶ Select **Wallpaper**.
- ▶ Select the folder where the picture is stored.
- ▶ Select your picture.

Changing the start up events

The start up events are an animation that you can select and a greeting that you enter. These appear when you turn on the phone. The animation is also shown when you turn off the phone.

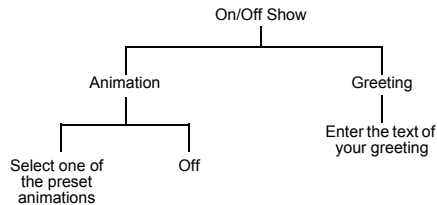

Setting the brightness

You can adjust the brightness of the display. To make the display brighter select +1, to dim the display select -1.

- ▶ Select **Brightness**.
- ▶ Use \odot to move between +1, 0 and -1.
- ▶ Press \ominus .

Settings

Setting the backlight time

The **Backlight Time** is the time that your screen remains lit when you are not using your phone.

- ▶ Select **Backlight Time**.
- ▶ Select from **10 seconds, 30 seconds** and **60 seconds**.

Note: Setting the **Backlight Time** to 60 seconds, can reduce the talk and standby time of your battery.

Setting the key backlight

The **Key Backlight** illuminates your phone's keys.

- ▶ Select **Key Backlight**.
- ▶ Select **On** or **Off**.

Note: Turning on the **Key Backlight** can reduce the talk and standby time of your battery.

Displaying the clock/calendar in idle mode

You can choose whether or not to display a clock or calendar on the screen when in idle mode. Use **9** to move between the options.

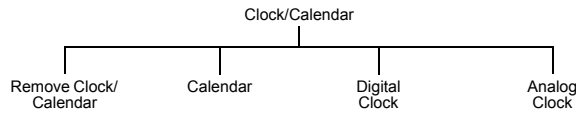

Changing the case screen settings

The **Case Screen** is the screen on the front of the phone. It has a clock, icon area, incoming message area and call alerts area.

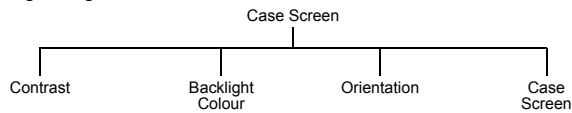



Settings



Changing the contrast

- ▶ Select **Contrast**.
- ▶ Use \odot to move between 0 and 10.
- ▶ Select **Ok**.

Changing the backlight colour

You set the backlight colour, to see what type of call you are receiving, or what mode you are in when the phone is closed. You can set the backlight colour for:

- Alarm/Schedule
- Voice Calls
- Fax Calls
- Data Calls
- Messages
- MMS Notify
- WAP Services
- Voice Mail
- Camera Mode
- Others

To set your backlight colours:

- ▶ Select **BacklightColour**.
- ▶ Select the item you want to change.
- ▶ Select a colour.

Changing the orientation

The orientation changes the alignment of the information on the case screen.

- ▶ Select **Orientation**.
- ▶ Select **Left** or **Right**.

Changing the case screen display

- ▶ Select **Case Screen**.
- ▶ Select from **Clock/Status**, **Analog** and **Digital**.

If you select **Clock/Status** the battery level and GSM signal strength appear in the information area.

Menu > Settings > Display > Case Screen

Settings

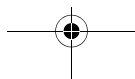
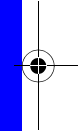
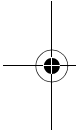

Settings

Alerts

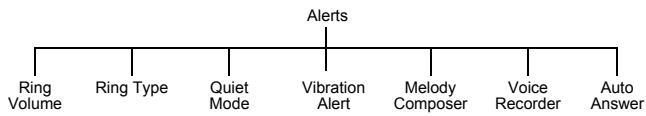

Changing the ring volume

You can change the ring volume so that you can hear your phone ring. For example, in a noisy environment you may want to set the volume to maximum.

- ▶ Select **Ring Volume**.
- ▶ Use \uparrow to move between 0 and 4 on the volume scale.
- ▶ Press \odot to select the new volume level.

Note: This option is unavailable if you are in quiet mode.

Setting the ring type

Use ring type to select the sound you want to hear when you receive a call.

- ▶ Select **Ring Type**.
- ▶ Select the type of call that you want to change.
- ▶ Select the folder where your sound is stored.
- ▶ Select your sound.

Setting quiet mode

In quiet mode the microphone amplifies your voice, so you can whisper and still be heard by the person on the other end of the call. You should use quiet mode in situations where you do not want to disturb the people around you.

In quiet mode, the phone will not ring when you receive a call or message, unless you set a ring volume for quiet mode.

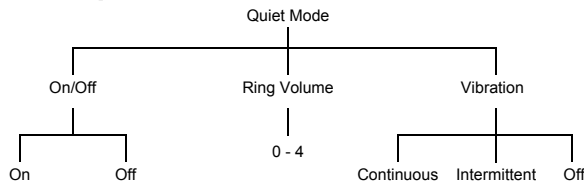

Settings

Setting a vibration alert

If you set a vibration alert, the phone vibrates when you receive a call or message. This setting is separate from the vibration alert that you set for quiet mode.

- ▶ Select **Vibration Alert**.
- ▶ Select from **Continuous**, **Intermittent** and **Off**.

Creating a ring type

- ▶ Select **Melody Composer > Create**.
- ▶ Using the following table, enter the notes, rests and durations to create your melody.

Key	1 st press	2 nd press	3 rd press	4 th press	5 th press
1	C2	C3	C4	C5	
2abc	D2	D3	D4	D5	
3def	E2	E3	E4	E5	
4ghi	F2	F3	F4	F5	
5jkl	G2	G3	G4	G5	
6mno	A2	A3	A4	A5	
7pqrs	B2	B3	B4	B5	
0+	Rest				
⌘	1/8	1/4	1/2	1	1/16
#	Sharp				

When you have completed your melody, you can save it:

- ▶ Press **0**.
- ▶ Select **Ok**.
- ▶ Enter a name.
- ▶ Select **Save**.
- ▶ Select the folder where you want to save your melody.

At any time during your composing, you can press **⌘** to play back your melody.

Menu > Settings > Alerts

Settings



Settings

Once you have saved your melody you can edit it.

- ▶ Select **Edit** from the **Melody Composer** menu.
- ▶ Select the data folder where your melodies are stored.
- ▶ Select the melody you want to edit.
- ▶ Select **Edit**.
- ▶ Use the relevant keys to insert new notes and rests.

Recording a voice message

You can record a message to use as your ring type.

- ▶ Select **Voice Recorder > Record**.
- ▶ Record your message.
- ▶ Store the recording in a data folder.

You can now select and use this sound in the same way as you do for any other ring types.

Once you have recorded a voice message you can edit it. Select **Edit** from the **Voice Recorder** menu, then edit it as necessary.

Setting auto answer

When auto answer is on, and your phone is connected to a car kit or personal handsfree adaptor, incoming calls are automatically answered.

Select **Auto Answer > On**.

To turn off auto answer:

Select **Auto Answer > Off**.

Keys

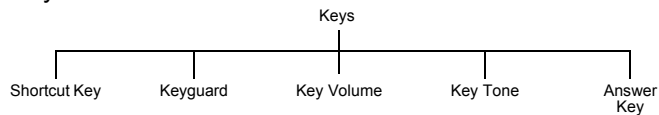

Choosing the function for the shortcut key

The right soft key () is a shortcut key from idle mode. You can choose which function you want this key to access. The default is camera.

- ▶ Select **Shortcut Key**.
- ▶ Select the function that you want.



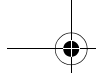

Settings



Setting the keyguard

The keyguard stops the keypad being accessed.

Note: When the keyguard is on, you must turn it off before you can use the phone.

- ▶ Select **Keyguard**.
- ▶ You are asked '**Guard Keypad?**'. Press .

To turn off the keyguard:

- ▶ From idle mode press .
- ▶ You are asked '**Free keypad?**'. Press .

Changing the key volume

The key volume is the volume of the tone made when you press a key.

- ▶ Select **Key Volume**.
- ▶ Use  to move the volume level between 0 and 4.

Changing the key tone

The key tone is the sound made when you press a key.

- ▶ Select **Key Tone**.
- ▶ Select the tone you want.

Choosing the key to use for the answer key

You can choose whether to use any key or just the send key () to answer a call.

- ▶ Select **Answer Key**.
- ▶ Select **Any Key** or **Send Key**.

Menu > Settings > Keys

Settings

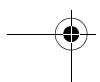
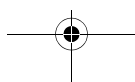
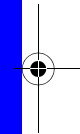
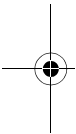

Settings

Phone settings

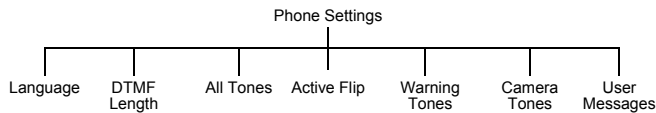

Changing the language

You can change the language that the phone uses for display messages and text entry.

- ▶ Select **Language**.
- ▶ Select **Display Language** or **Tegic Language**.
- ▶ Select the language.

Note: Tegic language is the language used by T9® text entry. For more information on T9® text entry, see Entering text on page 31.

Changing the DTMF length

DTMF stands for Dual Tone Multi-Frequency. You can send DTMF tones during a conversation to access voice mail, paging and computerised home banking. For example, you may need to enter a number to remotely access voice mail messages.

- ▶ Select **DTMF Length**.
- ▶ Select **Long** or **Short**.

Turning tones on and off

You can turn on or off all tones or just warning tones.

- ▶ Select **All Tones** or **Warning Tones**.
- ▶ Select **On** or **Off**.

Active flip

If you enable active flip, you can answer a call by opening the phone, end the call by closing the phone and reject a call by pressing the memo/camera shutter key.

- ▶ Select **Active Flip**.
- ▶ Select **On** or **Off**.

Selecting camera tones

The camera tone is the sound the phone makes when you take a picture.

- ▶ Select **Camera Tones**.
- ▶ Select a tone type.

Settings

Editing user messages

The phone contains some standard user messages that you can send to other people. You can edit these messages to suit you.

- ▶ Select **User Messages**.
- ▶ Select the message you want to edit.
- ▶ Edit the message.

Clock

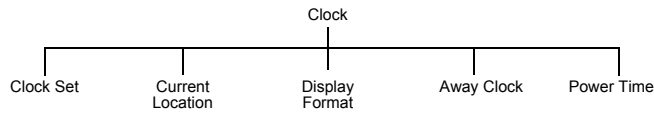

Setting the clock

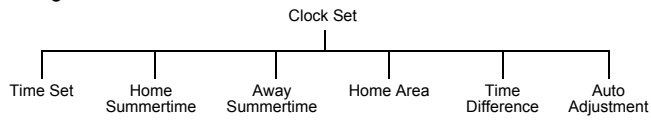

Setting the time

Use this to set the current time and date on your phone.

- ▶ Enter the date (day/month/year).
- ▶ Enter the time (24 hour clock)

Setting summertime

You can set summertime when you are at home or away. When you set summertime, the clock automatically moves on by one hour.

- ▶ Select **Home Summertime** or **Away Summertime**.
- ▶ Select **On** or **Off**.

Setting your home area

- ▶ Select **Home Area**.
- ▶ Select **World List** to choose a country. Select the country you are in.
- ▶ Select **City List** to choose a city. Select the city closest to your current location.

Menu > Settings > Phone Settings

Menu > Settings > Clock > Clock Set

Settings

Settings

Auto adjusting the time difference

If you are away, in a country with one time zone, then the time difference can be adjusted automatically.

Select **Clock Set > Auto Adjustment > On**.

The phone gets your location from the local network provider, and adjusts the clock automatically.

Setting the time difference

If you are away, in a country with more than one time zone, then you can set the time difference manually.

- ▶ Select **Clock Set > Time Difference**.
- ▶ Select the difference from your home area.

Changing your location

You can change your location so that the phone's clock automatically adjusts depending on whether you are at home or abroad. All the clocks on the phone display the time of the selected location.

- ▶ Select **Current Location**.
- ▶ Select **Home** or **Away**.

If you select **Away**, you may need to adjust the time difference, so your clock is correct. To do this see Setting the time difference on page 42.

Changing the display format

You can choose how you want the time and date to display.

- ▶ Select **Display Format**
- ▶ Select from the displayed list of date and time formats.

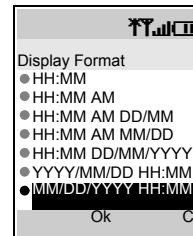

Changing the appearance of the away clock

You can choose how you want the away clock to display.

- ▶ Select **Away Clock**.
- ▶ Select from **Off**, **Large Clock** or **Case Clock**.

Setting the power on and off times

You can use this to set the phone to turn itself on or off automatically at a specified time.



- ▶ Select **Power Time**.
- ▶ Select **--:-- On** or **--:-- Off**.
If times are already set then these times appear before the words **On** and **Off**.
- ▶ Select **--:--** or the existing time.
- ▶ Enter the time you want the phone to power on or off.
- ▶ Set whether these power on/off times are **Repeat Daily**, **Once** or **Disabled**.
- ▶ Press **OK** to save your settings.

Settings

Disabling the power on and off times

- ▶ Select the power on or off time.
- ▶ Select the frequency option.
- ▶ Select **Disabled**.
- ▶ Press  to save your alarm settings.

Or

- ▶ Highlight the power on or off time.
- ▶ Press  to cycle through **Repeat Daily**, **Once** or **Disabled**.
- ▶ Stop at **Disabled**.
- ▶ Press  then  to save your alarm settings.

Caution: You need to ensure that the times you set will not automatically power on when you are in an aircraft, medical facility etc. See Important information on page 5.

Call service

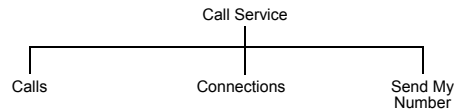

Calls

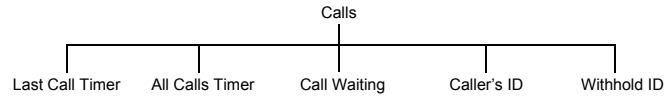

Viewing the length of your last call

- ▶ Select **Calls > Last Call Timer**.
- ▶ The length of your last call is displayed.

Viewing the combined length of all your outgoing or incoming calls

- ▶ Select **Calls > All Calls Timer**.
- ▶ Select **Incoming** or **Outgoing**.
- ▶ The combined length of all your incoming or outgoing calls since the timer was last reset, is displayed.



Menu > Settings > Clock > Power Time

Menu > Settings > Call Service

Settings

Settings

Once you have seen the total time you can reset the timer:

- ▶ Press .
- ▶ You are asked 'Reset?'. Press .
- ▶ You are asked 'Reset Total Time?'. Press .
- ▶ Enter the lock code.

Note: The lock code is preset to 0000. For security you should change this to a four figure number that you can remember, see Changing the phone lock code on page 47.

Checking the status of call waiting, caller's id and withhold id

Note: This is network dependent .

- ▶ Select **Calls**.
- ▶ Select **Call Waiting, Caller's ID or Withhold ID**.
- ▶ The status is displayed.

For **Call Waiting**, you can change the status:

If **Call Waiting** is disabled and you want it enabled, select **Menu > Enable**.

If **Call Waiting** is enabled and you want it disabled, select **Menu > Disable**.

Connections

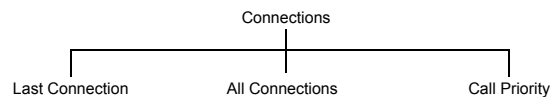

Viewing details of your last connection

Select **Connections > Last Connection**.

The time and data transfer details are displayed.

Viewing the combined details of your previous connections

Select **Connections > All Connections**.

The combined length of all your incoming or outgoing calls since the timer was last reset, is displayed.

Once you have seen all the details you can reset the total time and data:

- ▶ Press .
- ▶ You are asked 'Reset Total Time and Data?'. Press .
- ▶ Enter the lock code.

Settings

Note: The lock code is preset to 0000. For security you should change this to a four figure number that you can remember, see Changing the phone lock code on page 47.

Allowing incoming calls during data transfer

With this enabled, you can transfer data and accept incoming calls on your phone. With this disabled, you cannot answer incoming calls while you are transferring data.

- ▶ Select **Connections > Call Priority**.
- ▶ Select **On** or **Off**.

Sending your number

Note: This is network dependent.

If your network supports this function, you can decide whether you want your phone number to be sent when you make a call.

Note: You must be registered with a service provider before you can choose to send your number.

- ▶ Select **Send My Number**.
- ▶ Select from **Network Set, On** and **Off**.

If you select **Network Set**, your network's default setting is used.

Call divert

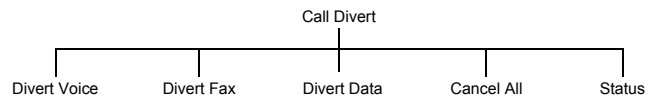

Setting and cancelling diverts

To set diverts for specific call types:

- ▶ Select the type of call you want to divert.
- ▶ Select **Set**.
- ▶ Select from **All, Busy, No Reply** and **Unreachable**.
- ▶ Enter the number to divert to.

Menu > Settings > Call Service

Settings Menu > Settings > Call Divert

Settings

To cancel diverts for specific call types:

- ▶ Select the type of call you want to cancel the divert on.
- ▶ Select **Cancel**.
- ▶ Select from **All**, **Busy**, **No Reply** and **Unreachable**.

To cancel all diverts:

- ▶ Select **Cancel All**.
- ▶ Confirm that you want to cancel all the diverts you have set.

Viewing the divert status

- ▶ Select **Status**.
- ▶ Use \odot to scroll through the list, only one item at a time appears on the screen.

Security

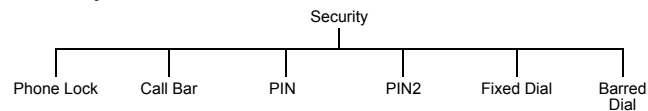

Setting and cancelling the phone lock

When the phone lock is set you can only use the phone to receive incoming calls and to make emergency calls.

- ▶ Select **Phone Lock > On/Off > On**.
- ▶ Enter the lock code.

The lock icon (🔒) is displayed on the screen.

When the phone lock is on you have to enter the lock code from the idle screen before you can use the phone.

Note: The phone lock code is preset to 0000. For security, you should change this to your own four-figure number, see Changing the phone lock code on page 47.

To cancel the phone lock:

- ▶ Select **Phone Lock > On/Off > Off**.
- ▶ Enter the lock code.

Settings

Changing the phone lock code

You can change the phone lock code to a four figure number that you find easy to remember.

- ▶ Select **Phone Lock > Change Code**.
- ▶ Enter the current phone lock code.
- ▶ Enter the new phone lock code.
- ▶ Verify the new phone lock code.

Setting and cancelling call bar

Call barring restricts certain types of incoming and/or outgoing calls, using a password provided by your service provider. When you check the status of the Call Bar, your phone must be registered with a network. You can set call barring for voice, fax and data calls.

- ▶ Select **Call Bar**.
- ▶ Select the type of call that you want to bar.
- ▶ Select **Set** or **Cancel**.
- ▶ Select when you want to bar the calls.
- ▶ Enter the password, provided by your service provider.

Note: You can change your password to something that you find easy to remember, see Changing the password on page 47.

To cancel all the current call bars:

- ▶ Select **Call Bar > Cancel All**.
- ▶ Enter the password.
- ▶ Confirm that you want to cancel all the set call bars.

Viewing the call bar status

You can see whether you have any call types barred.

- ▶ Select **Call Bar > Status**.
- ▶ Use \uparrow to scroll through the list, only one item at a time appears on the screen.

Changing the password

You can change the password to something that you find easy to remember.

- ▶ Select **Call Bar > Password**.
- ▶ Enter the password, supplied by your service provider.
- ▶ Enter the new password.
- ▶ Verify the new password.

Menu > Settings > Security

Settings



Settings

Enabling and disabling PIN and PIN2

The PIN protects your phone against unauthorised use. If you enable the PIN, you have to enter it every time you turn on the phone.

You need PIN2 to set fixed dial numbers.

Your PIN and PIN2 are supplied by your service provider.

Note: If you enter the PIN or PIN2 incorrectly three times, the phone will lock and you will need to enter the PUK or PUK2 code. If you enter the PUK or PUK2 code incorrectly ten times, your phone will no longer operate. All information stored in the SIM will be lost, and you will need to replace the SIM. Contact your service provider for the PUK and PUK2 codes. Contact your service provider for more details.

- ▶ Select **PIN** or **PIN2**.
- ▶ Select **Enable/Disable**.
- ▶ Select **On** or **Off**.
- ▶ Enter the **PIN** or **PIN2**.

Changing the PIN

You can change the PIN to an eight figure number that you find easy to remember.

- ▶ Select **PIN**.
- ▶ Select **Change**.
- ▶ Enter the PIN.
- ▶ Enter the new PIN.
- ▶ Verify the new PIN.

Note: You can only change the PIN when it is enabled.

Enabling and disabling fixed dial

Fixed dial is part of the **Contacts List**, but with added security. When you enable fixed dial:

- You can only dial numbers that are in the fixed dial store
- If you manually dial a number, it must match one in the fixed dial store.
- If you store, edit or delete a phone number, you have to enter your PIN2.

To enable or disable fixed dial:

- ▶ Select **Fixed Dial**.
- ▶ Select **On** or **Off**.
- ▶ Enter your PIN2, provided by your service provider.

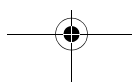

Settings

When you enable fixed dial, in the **Contacts List** you can only browse the numbers that are in the fixed dial store.

Enabling and disabling barred dial

When you enable barred dial you can no longer dial the numbers that you entered as barred dial numbers. You can use this to stop certain numbers being dialled.

To enable or disable barred dial:

- ▶ Select **Barred Dial**.
- ▶ Select **On** or **Off**.
- ▶ Enter your password.

Network

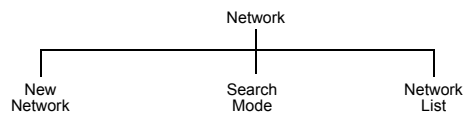

Changing to a new network

When you are not in your home country or region, you may be able to use a network that you are not directly subscribed to. This is called *roaming*.

Note: National Law may not permit roaming in your home region.

Use the options on the **Network** menu to select a network that is available in your current location.

- ▶ Select **New Network**.
- ▶ Select a new network.

An X appears in the information area if you cannot register with the selected network.

Search mode

You can set the **Search Mode** to **Automatic** or **Manual**. When the **Search Mode** is **Manual**, the phone only uses the selected network. If coverage is lost, you need to select another network. When the **Search Mode** is **Automatic**, the phone automatically reselects a new network to maintain network availability.

Menu > Settings > Security

Menu > Settings > Network

Settings



Settings

Menu > Settings > Network

Menu > Settings > Defaults

Settings

Network list

In **Automatic Mode**, the phone uses the **Network List** to find a new network. The location numbers in the **Network List** show the search priority. You can change the list as follows:

Insert stores a new network in the currently displayed location, and moves other networks down.

Edit overwrites the old network with a new one.

Delete deletes the currently displayed network.

Ok selects the currently displayed network.

Defaults

Use this to return your personal settings to their factory default. You cannot return the **Phone Lock** or **Language** to their default settings.

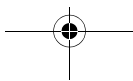
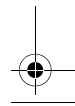
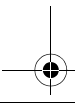
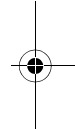
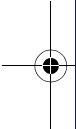





Contacts list

Use the **Contacts List** menu to store a person's phone numbers, e-mail addresses, company name, picture and other information. You can also set up how your contacts list is organised and displayed.

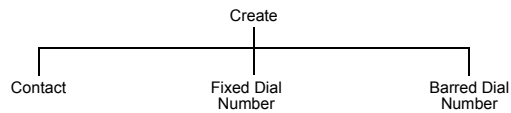
Create



Note: Fixed Dial Number and Barred Dial Number are only available if you have enabled Fixed Dial (see Enabling and disabling fixed dial on page 48) or Barred Dial (see Enabling and disabling barred dial on page 49).

When you create or edit any entries, you must remember to press  to save your changes, or they will be lost.

Creating a new contact

- ▶ Select **Contact**.
- ▶ Select an item.
- ▶ Enter the data using the keypad, or select an item from the list available.

For each contact you can enter:

Item	Number of characters
First name	16
Last name	16
Home number	40
Work number	40
Mobile number	40
Other number	40
Home e-mail	80
Work e-mail	80
Other e-mail	80

Contacts list

Item	Number of characters
URL	80
Title	16
Company	16
Note	32
Picture	Select a picture from the list or take a picture with the camera
Group name	Select a group from the list.
Ring type	Select a tone from the list.
Vibration alert	Select a vibration type from the list.
Case screen colour	Select a colour from the list.
Location	3 (up to 500 locations)

When you have entered all the details, press  to save the contact.

Note: Location is the location number in your **Contacts List**.

If you put a contact in a group which has a ring type, case screen colour and vibration alert, then these options are not available for the individual contact.

Entering DTMF digits in a phone number

You can enter DTMF digits at the end of a phone number, so that these numbers are automatically sent after the main phone number.

- ▶ Enter the phone number.
- ▶ Press and hold  until a P is displayed at the end of the phone number.
- ▶ Enter the DTMF digits, for example, the number to access voice mail messages.

When you call this number the DTMF tones will be sent after 3 seconds.

Entering a picture

You can choose from **Camera** and **Select**. Choose **Camera** to take a picture with the phone's camera.

- ▶ Select **Camera**.
- ▶ Take the picture.
- ▶ Rename the picture.
- ▶ Press  to return to the **Contact**.

Choose **Select** to select a picture from your **Data Folders**. The default folder is **My Pictures**. If you want to select a picture from another folder, press  to see the list of **Data Folders**.

Contacts list

Setting fixed dial numbers

Note: Fixed Dial Number is only available if you have enabled Fixed Dial (see Enabling and disabling fixed dial on page 48).

Fixed dial is part of the **Contacts List**, but with added security. When you enable fixed dial:

- You can only dial numbers that are in the fixed dial store
- If you manually dial a number, it must match one in the fixed dial store.
- If you store, edit or delete a phone number, you have to enter the PIN2, provided by your service provider.

To enter a fixed dial number:

- ▶ Select **Fixed Dial Number**.
- ▶ Enter the number.
- ▶ Enter your PIN2.

The number is stored in your fixed dial store.

Setting barred dial numbers

Note: Barred Dial Number is only available if you have enabled Barred Dial (see Enabling and disabling barred dial on page 49).

When you enable barred dial you can no longer dial the numbers that you entered as barred dial numbers. You can use this to stop certain numbers being dialled.

- ▶ Select **Barred Dial Number**.
- ▶ Enter the number that you want to bar.
- ▶ Enter your password.

'Wild' numbers

Wild numbers are spaces that you can store in a phone number. You must fill the wild numbers before you can dial that phone number. You can use wild numbers in conjunction with fixed dial, to, for example, restrict calls to a specific area by storing the area code then adding the remainder of the number when it is recalled.

To enter a wild number:

While entering a phone number, press and hold **0+**, until **_** is displayed.

When you recall this phone number, enter the required number to replace the wild number.

Contacts list

Browse

This menu only applies to contacts stored on your phone. For contacts stored on the SIM see SIM on page 58.

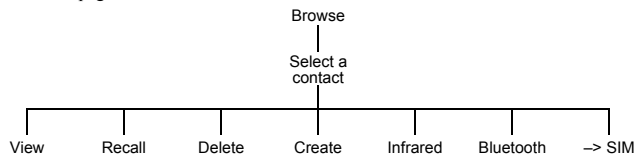

Note: When you create or edit any of your entries, you must press  to save your changes, or they will be lost.

View. Displays all the details for the entry you selected. You need to scroll down the screen to see all the information.

Recall. Displays the phone number for the entry you selected. You can either call it or change it. To call it press .

Delete. Deletes the entry.

Create. Creates a new entry in the **Contacts List**.

Infrared. Sends the details of the current entry to another device via the infrared port.

Bluetooth. Sends the details of the current entry to another Bluetooth device.

-> SIM. Copies the details of the current entry to the SIM.

Voice dial

With voice dial you can save a number using your voice. You can then dial the number by saying the name that you want to call.

Creating a voice dial entry

- ▶ Select **Voice Dial**.
- ▶ Select **Add**.
- ▶ Select a contact.
- ▶ Select **Recall**.
- ▶ Select **Ok**.
- ▶ Hold the phone about 20cm away from your mouth.
- ▶ Speak clearly into the microphone to record the required name.

Each entry will prompt you to record the name a second time so that the phone will recognise your voice and intonation.

Contacts list

When you have finished recording, the display shows whether or not the recording was successful. If the recording failed, you need to try again. You can try as many times as you need to.

Note: Each recording is short, so be ready to speak soon after initiating the recording.

Recalling a voice dial entry

- ▶ From idle mode press and hold **0** or **9**.
- ▶ Say clearly the name that you want to recall.
- ▶ Press **0** to call the number.

Dialling a voice dial entry

You can set up voice dial to dial a voice dial number directly from idle mode, so you don't have to press **0** to call the number.

- ▶ Select **Voice Dial**.
- ▶ Select **On/Off**.
- ▶ Select **Enable**.

To turn it off select **Disable**.

Editing a voice dial entry

- ▶ Select **Voice Dial**.
- ▶ Select an entry.
- ▶ Select from **Add**, **Play** and **Delete**.

Add. Add a new **Voice Dial** entry.

Play. Listen to the recording for the selected entry.

Delete. Delete the selected entry.

Groups

From the **Groups** menu, you can set up groups of contacts. You can use groups to collect together types of entries, for example, business, friends and family. You can give each group a suitable title, for quick access to the entries.

Creating a group

- ▶ Select a preset group name or one of the available user group names from the list.
- ▶ You can enter a name, ring type, vibration alert and case screen colour.

Note: If you already have ring type, vibration alert and case screen colour set for an individual that you add to the group, then the group's settings are used in preference to those set for the individual.

Menu > Contacts List > Voice Dial

Menu > Contacts List > Groups

Contacts list



Contacts list

Viewing a group

Once you have created a group, you can view its settings.

- ▶ Select the group on the list.
- ▶ Select **View** from the menu.

From this view you can then edit the group settings:

- ▶ Select the item that you want to edit.
- ▶ Select **Edit**.
- ▶ Make your changes.
- ▶ Select **Ok** to make your changes or **Cancel** to revert to the original.

You can revert to the original settings by selecting **Reset**.

Previewing a group

This simulates an incoming call, so that you can review your settings and see if they are what you want.

- ▶ Select a group.
- ▶ Select **Preview**.

You can then adjust your settings using **View**.

Adding and removing members

Once you have created a group, you can add or remove members.

To add a new member:

- ▶ Select the group on the list.
- ▶ Select **Members** from the menu.
- ▶ Select **Add**.
- ▶ Select a contact from your list.

Or

- ▶ Highlight the group on the list.
- ▶ Press .
- ▶ Select **Add**.
- ▶ Select a contact from your list.

To remove a member:

- ▶ Select the group on the list.
- ▶ Select **Members** from the menu.
- ▶ Highlight a contact.
- ▶ Select **Remove** to remove this contact from the group.

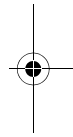
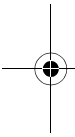

Contacts list

Or

- ▶ Highlight the group on the list.
- ▶ Press .
- ▶ Highlight a contact.
- ▶ Select **Remove** to remove this contact from the group.

Settings

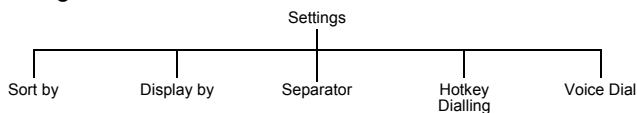

Setting how to sort or search entries

You can choose how to sort and search the entries in your **Contacts List**.

- ▶ Select **Sort by** or **Display by**.
- ▶ Select **First Name** or **Surname**.

Setting how to display entries

You can choose how to display the entries in your **Contacts List**.

- ▶ Select **Separator**.
- ▶ Select **Space** or **Comma**.

Enabling and disabling hotkey dialling

With hotkey dialling, you can press and hold the digit key that relates to a location number to call contacts on your **Contacts List**. For example, to call the contact in location 3 of your **Contacts List**, press and hold .

To enable hotkey dialling, select **Hotkey Dialling**, then select either **SIM Phonebook** or **Mobile Phonebook**.

To disable hotkey dialling, select **Hotkey Dialling > Off**.

Enabling and disabling voice dialling

With voice dialling, you can call a contact by speaking into the microphone.

- ▶ Select **Voice Dial**.
- ▶ Select **On** or **Off**.

To set up voice dial numbers see *Creating a voice dial entry* on page 54.

Contacts list

SIM

This shows the contacts stored on your SIM.

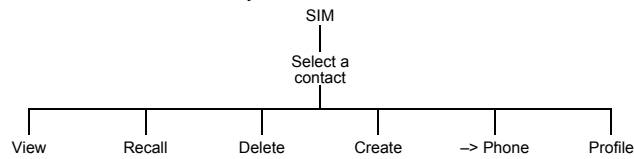

Note: When you create or edit any of your entries, you must press to save your changes, or they will be lost.

View. Displays all the details for the entry you selected. You need to scroll down the screen to see all the information.

Recall. Displays the phone number for the entry you selected. You can either call it or change it. To call it press .

Delete. Deletes the entry.

Create. Creates a new entry in the **Contacts List**.

-> **Phone.** Copies the details of the current entry to the phone.

Profile. Displays the entry's profile.

Storage

This shows the amount of space you have used on your SIM and your phone. Use to move between the two.

You can copy all the SIM contacts to the phone or copy all the phone contacts to the SIM:

- ▶ Select **Menu > Copy All**.
- ▶ Select **SIM to phone** or **Phone to SIM**.

You can delete all the SIM contacts or all the phone contacts:

- ▶ Select **Menu > Delete All**.
- ▶ Select **SIM Contacts** or **Phone Contacts**.



Games

The games that are on your phone are **network dependent**. If you have four games listed then you have embedded games and should follow the instructions in the Embedded games section. If you have one game listed then you have downloadable games and should follow the instructions in the Downloadable games section.

Embedded games

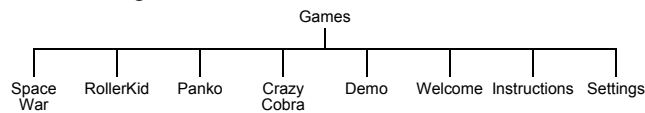

To play the embedded games, select the required game, then follow the on-screen instructions.

Demo

Select this to see a demonstration of a game.

Welcome

Select this to read the welcome screen.

Instructions

Select this to see general instructions for playing the games.

Settings

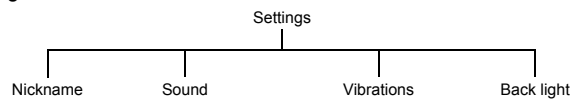

Nickname

Use this to create a name to use when you play games. When you first select this item, it displays **no pseudo**. Use  to delete the existing text, then enter your nickname.

Sound

Use this to set the sound level for your games. You can select from **Off**, **Low**, **Medium** and **High**.



Games

Vibrations

If you turn vibrations on, the phone vibrates when a target is hit in the game. You can select from **On** and **Off**.

Backlight

Use this to set your key back light. You can select from **Off**, **On 30s** and **Always on**.

Note: If you select **Always on**, this may affect the talk and standby time of your battery.

Downloadable games

Note: This is network dependent.

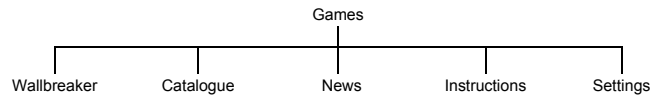

You have one embedded game - Wallbreaker. You can download one other game.

Note: When you download a new game it overwrites the previously downloaded game.

Catalogue

This displays a list of the games that you can download. To download a game:

- ▶ Select a game.
- ▶ Details of the game are displayed.
- ▶ Press  to download the game.
- ▶ Confirm that you want to download the game.

The game is downloaded to your phone.

News

Displays SMS broadcast messages from Infusio™, the games provider.

Instructions

Select this to see information about downloading games, and general instructions for playing the games.

Settings

This is the same as the **Settings** menu for embedded games. See Settings on page 59.





Browser

Use the Browser menu to access Internet services supported by the network, such as news, weather reports and sport.

Server list

Before you can access the Internet, your SIM must be data enabled and the configuration information must be entered.

Note: The configuration information may have been pre-programmed by your service provider. If you modify these settings, your browser may no longer work.

You can manually set up five servers on your phone.

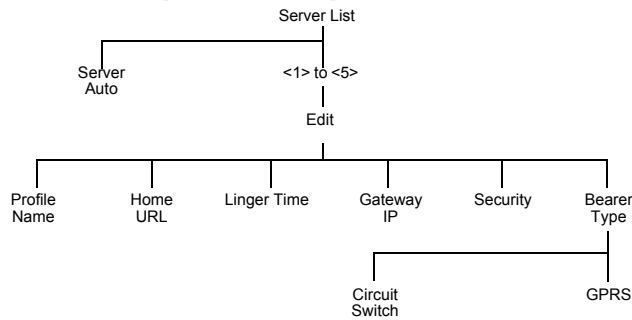

For **Circuit Switch**, select **Set**, then select **Edit** and set:

- Digital Dial number
- Analog Dial number
- Circuit Type. Select from **Digital** and **Analog**.
- User ID
- User Password

For **GPRS**, select **Set**, then select **Edit** and set:

- Access Point Name
- User ID
- User Password
- Authentication. Select from **Normal**, **Encrypted** and **None**.

Browser

Start browser

To start the browser, select **Home Page** (to start the browser from idle mode press the **OK** key).

This opens the browser at your service provider's home page. This is recalled from the cache each time you start the browser. The cache is the phone's memory where pages that you have previously downloaded are stored.

The phone remains off line (i.e. not connected to a server) when it recalls pages from the cache.

The browser menu

The browser has its own menu, which you use when an Internet page is currently displayed, either on line or off line. To access this menu press **OK**.

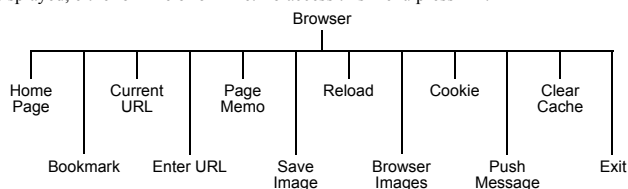

Home Page. Displays the page defined by your service provider.

Bookmark. Saves the current page as a bookmark, so you can return to it another time.

Current URL. Displays the current URL.

Enter URL. Enter the address of the URL that you want to go to.

Page Memo. Saves the currently displayed page.

Save Image. Saves the currently displayed image.

Reload. Reloads and updates the current page.

Browser Images. Disables images, to display a page more quickly.

Cookie. Enable, disable or delete cookies.

Push Message. View all your push messages.

Clear Cache. Deletes the page(s) in the cache, and displays the **Home Page**.

Exit. Stops the browser.

Browser

Navigating pages

Use  to scroll up and down.

Use  to return to previous page.

Use  to return to next page. This is only available if you have gone back to a previous page.

Press  to follow a highlighted link.

 indicates a table. Select **View**.

 indicates an image that cannot be displayed.

 indicates on line browsing (non secure).

 indicates on line browsing (secure).

Bookmarks

This lists the bookmarks that you have stored. Select a bookmark from the list to go directly to that page.

Adding a bookmark

- ▶ While viewing content, select **Bookmark** from the **Browser** menu.
- ▶ Select **<Register>**.

Deleting bookmarks

- ▶ While viewing content, select **Bookmark** from the **Browser** menu.
- ▶ Press  to select **Menu**.
- ▶ Select from **Delete This**, **Delete Any** and **Delete All**.

Renaming a bookmark

- ▶ Select **Bookmark** from the **Browser** menu.
- ▶ Select **Menu > Edit Title**.
- ▶ Press and hold  to delete the current name.
- ▶ Enter the new name.

Grouped bookmarks

If you have set your bookmarks to display in groups (see Bookmarks on page 65), then you can highlight a group and select **Menu**, to make changes to that group. The options are:

Edit Title. Change the title of the group.

Display. Select **List** to display your bookmarks as one list.

Delete All. Delete all the bookmarks in that group.

Menu > Browser > Home Page

Menu > Browser > Bookmarks

Browser

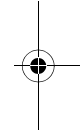
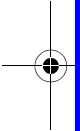

Browser

Enter URL

Use this to enter a URL to go to a known site.

Page memo

Use this to view a previously saved page.

Push message

Push messages are SMS messages that the phone receives that relate to the browser. Use this to view the received messages.

Browser settings

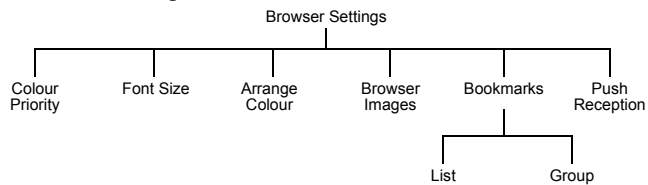

Use this to customise the browser interface.

Setting the colour priority

You can choose whether to use your colour settings, or those set by the Internet site that you are viewing.

- ▶ Select **Colour Priority**.
- ▶ Select from **Prefer Content** and **Prefer User's**.

Setting the font size

You can choose the font size of the text.

- ▶ Select **Font Size**.
- ▶ Select from **Large**, **Standard** and **Small**.

Arranging the colour

You can set the colours for your background, text, visited site and new site.

- ▶ Select **Arrange Colour**.
- ▶ Select from **Background**, **Text Colour**, **Visited Site** or **New Site**.
- ▶ Select a colour.



Browser

Enabling and disabling the browser images

If you disable browser images, pages display more quickly.

- ▶ Select **Browser Images**.
- ▶ Select from **On** and **Off**.

Bookmarks

You can choose whether to have one list of bookmarks, or whether to group your bookmarks.

- ▶ Select **Bookmarks**.
- ▶ Select from **List** and **Group**.

If you select **Group**, you can set up five different groups to store your bookmarks.

Enabling and disabling push reception

If you enable **Push Reception**, you will receive all the push messages sent by your service provider.

- ▶ Select **Push Reception**.
- ▶ Select from **On** and **Off**.

Cookie

Cookies are information saved about a site to allow you to access it more quickly when you return to it.

If you want the phone to save cookies, select **Cookie > Enable > On**.

If you do not want the phone to save cookies, select **Cookie > Enable > Off**.

To delete an existing cookie, select **Cookie > Delete**.

Last status

This displays the status of the last site that you visited. If your browser stops working, you may need this information to find the problem.

Menu > Browser > Browser Settings

Menu > Browser

Browser



Camera

You can take pictures with the built-in camera, and send them in multimedia (MMS) and e-mail messages, or use them as wallpaper.

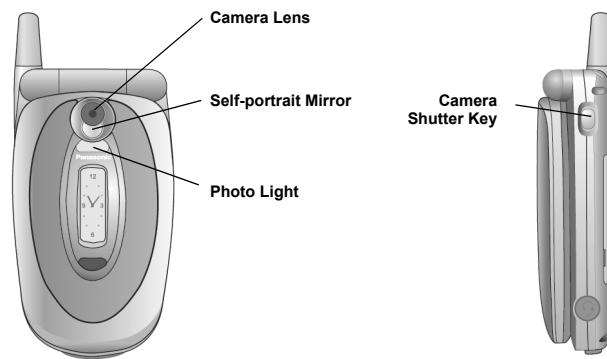

Changing to camera mode

To change to camera mode either select **Camera** from the main menu, or press from idle mode.

Leaving camera mode

To leave camera mode press to return to idle mode.

Taking a picture

- ▶ When you are in camera mode, move the phone around until you can see the image you want on the preview screen.
- ▶ Press to capture the image.

If you decide that you do not want the image that you have taken, you can press to delete it.

Camera

Taking a self-portrait

You can take a self-portrait using the shutter button on the side of the phone.

- ▶ Ensure that the phone is in camera mode.
- ▶ Close the phone.
- ▶ View the image in the self-portrait mirror.
- ▶ Press the shutter button on the side of the phone.

You can use this image in the same way as any other picture that you take with the camera.

Saving a picture

When you take a picture, it is automatically given a default name and stored in a data folder. You can change the name of the picture using **Rename**, see Renaming the picture on page 69.

Incoming calls when in camera mode

If you receive an incoming call while you are in camera mode, the phone leaves camera mode and switches to the incoming call. If a captured image is on the preview screen, it is temporarily saved. If you want to store the image, you need to do this when you return to camera mode.

Using your picture

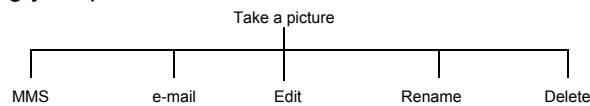

Once you have taken a picture, press  to access the menu.

Sending the picture in a multimedia or e-mail message

Select **MMS** or **e-mail**.

A multimedia or e-mail message is opened, with the picture already embedded or attached.

Menu > Camera

Camera



Camera

Editing the picture

When you have finished editing the picture, you must press to save your changes.

- ▶ Select **Edit**.
- ▶ Select **Menu**.

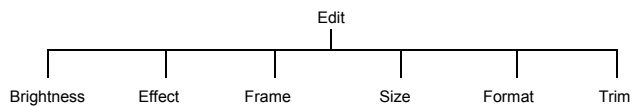

Changing the brightness

- ▶ Select **Brightness**.
- ▶ Press to make it lighter or to make it darker.

Changing the effect

Use this to change your picture's colours by using an effect.

- ▶ Select **Effect**.
- ▶ Select from **Sepia**, **Monochrome** and **Negative**.

Selecting a frame

Use this to enhance your picture, by adding one of the predefined frames.

- ▶ Select **Frame**.
- ▶ Select from a list of frames. You can preview the frame by highlighting it then pressing .

Changing the size

Use this to make your picture larger or smaller.

- ▶ Select **Size**.
- ▶ Choose **Width** or **Height**.
- ▶ Select **Edit**.
- ▶ Enter the percentage by which you want to change the size.
- ▶ Press .

Note: This does not cut your image, it compresses and/or stretches it. To cut your image, use Trim.

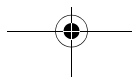

Camera

Changing the format

- ▶ Select **Format**.
- ▶ Choose from **JPEG Fine**, **JPEG Normal**, **JPEG Economy** and **PNG**.





JPEG Economy produces a small file but with a low resolution.

JPEG Normal produces a file which is acceptable for most uses.



JPEG Fine and **PNG** produce large files with high resolution.

Trimming your picture



Use this to select and save just a small part of your picture.

- ▶ Select **Trim**.
- ▶ Use  to increase and decrease the size of the box to include just the part of the picture that you want.
- ▶ First adjust up and left, then press  to adjust down and right. The white corner of the box indicates the directions that you can go.
- ▶ When you have the selection you want, press  to select the area.
- ▶ Press .



Renaming the picture

- ▶ Select **Rename**.
- ▶ Use  to remove the existing text.
- ▶ Enter the new text.
- ▶ Press .
- ▶ Select **Ok** to save your changes or **Cancel** to revert to the old name.

Deleting the picture

- ▶ Select **Delete** or press .
- ▶ Press  to confirm, or  to cancel.



Close up picture

When the image is on the preview screen, press  to see a close up picture. This zooms in on the centre of the image. Press  to return to the original image.

Brightness adjustment

You can set the brightness of an image both before and after taking the picture. The brightness can be increased or decreased by two levels.

Changing brightness while taking a picture

When the image is on the preview screen, press  to make it lighter or  to make it darker. The brightness icon at the top of the screen changes to show how much lighter or darker you have made the image.

Menu > Camera >  >  >  >  > Edit > Menu

Camera



Camera

Changing brightness after taking a picture

See Changing the brightness on page 68.

Preview screen menu

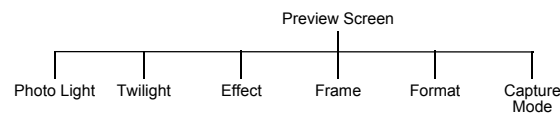

These are all set up using the same basic method:

- ▶ When the required image is shown in the preview screen, press
- ▶ Select the required option.
- ▶ Select the required setting.
- ▶ Press to leave the menu.

Photo light

Turns on a light on the front of the phone. **Twilight mode**

Turn **Twilight Mode** on when taking pictures in low light conditions.

Effect

With **Effect** you can choose from **Off**, **Sepia**, **Monochrome** or **Negative**.

Frame

This places a border round the image. You can preview the frame by highlighting it then pressing .

Format

With **Format** you can choose the format for saving your image.

JPEG Economy produces a small file but with a low resolution.

JPEG Normal produces a file which is acceptable for most uses.

JPEG Fine and **PNG** produce large files with high resolution.





Camera



Capture mode

With **Capture Mode** you can choose from:

Single Shot takes a single picture.

Multi Shot captures images at 1 second intervals while you hold  down, to a maximum of six images.

Self Timer delays the taking of an image.

Remote takes a picture immediately, then returns to the capture screen.

Photo light

Turns on a light on the front of the phone.

