

# Abridged English Manual

<b>Package Contents</b> .....	<b>19-2</b>
<b>Safety Precautions</b> .....	<b>19-3</b>
<b>Handling Precautions</b> .....	<b>19-11</b>
<b>Minding Mobile Manners</b> .....	<b>19-15</b>
<b>USIM Card</b> .....	<b>19-16</b>
<b>Charging Battery</b> .....	<b>19-17</b>
Battery & Charger .....	19-17
Battery Installation & Removal .....	19-18
Charging Battery .....	19-19
<b>Handset Parts &amp; Functions</b> .....	<b>19-20</b>
Display .....	19-22
Using This Manual .....	19-24
Quick Keys .....	19-24
<b>Handset Security</b> .....	<b>19-25</b>
USIM PINs .....	19-25
Codes .....	19-25
<b>Basic Operations</b> .....	<b>19-26</b>
Power On/Off .....	19-26
Language ( 言語設定 ) .....	19-26
My Phone Number .....	19-27
Date & Time .....	19-27
Network Settings .....	19-27
Voice Calls .....	19-27
Manner Mode .....	19-28
Close-to-Enable Keypad .....	19-28
Answer Phone .....	19-28

<b>Text Entry</b> .....	<b>19-29</b>
Key Assignments .....	19-29
Character Input Modes .....	19-30
Symbols & Pictographs .....	19-30
Copy/Cut & Paste .....	19-30
<b>Phone Book</b> .....	<b>19-31</b>
Phone Book Entry Items .....	19-31
New Phone Book Entries .....	19-32
Editing Phone Book Entries .....	19-32
Saving Numbers from Call Log .....	19-32
<b>Video Call</b> .....	<b>19-33</b>
Video Call Window .....	19-33
Making Video Calls .....	19-33
Answering Video Calls .....	19-33
<b>Camera</b> .....	<b>19-34</b>
Capturing Still Images .....	19-34
Recording Video .....	19-34
<b>Media Player</b> .....	<b>19-34</b>
Playing Media Files .....	19-34
<b>Memory Card</b> .....	<b>19-35</b>
Format Memory Card .....	19-35
<b>Data Folder</b> .....	<b>19-36</b>
Viewing Data Folder .....	19-36
<b>Connectivity</b> .....	<b>19-37</b>
Infrared .....	19-37
Bluetooth® .....	19-38
USB Cable .....	19-38
<b>Optional Services</b> .....	<b>19-39</b>

<b>Messaging</b> .....	<b>19-39</b>
Customizing Handset Address .....	19-40
Sending S! Mail & SMS .....	19-40
Receiving S! Mail & SMS .....	19-41
Reply & Forward .....	19-42
<b>Yahoo! Keitai Web</b> .....	<b>19-43</b>
Opening Yahoo! Keitai Main Menu .....	19-43
Using PC Browser .....	19-44
Live Monitor (Japanese) .....	19-43
Web Options Menu .....	19-44
<b>S! Appli</b> .....	<b>19-45</b>
Downloading S! Appli .....	19-45
Using S! Appli .....	19-46
<b>Communication</b> .....	<b>19-46</b>
S! Town (Japanese) .....	19-46
S! Loop (Japanese) .....	19-47
Near Chat (Japanese) .....	19-47
<b>Software Update</b> .....	<b>19-48</b>
<b>Specifications</b> .....	<b>19-49</b>
<b>Customer Service</b> .....	<b>19-50</b>

For more information about handset operations and functions, please go to the SOFTBANK MOBILE Corp. Website (<http://www.softbank.jp>) for the full manual\* or dial 157 from a SoftBank handset for Customer Service.

\* Please note that the full manual may not be available in English at time of purchase. In this case, call Customer Service or check SoftBank Website again at a later date.

# Package Contents

## □ Handset



## □ Battery (PMBAC1)

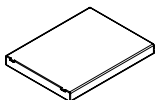

## □ AC Charger (PMCAA1)

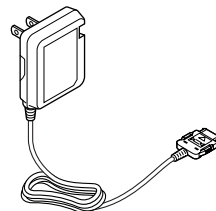

- Operating Instructions
- First Step Guide (Japanese)
- Utility Software (CD-ROM)\*



\* Utility software updates/upgrades may become available on SoftBank Website (<http://www.softbank.jp>) without prior notification. Please check for the newest versions of utility applications and download if required.









- For further information about accessories, please contact SoftBank Customer Center, General Information (☎ P.19-50).
- Optional battery and AC Charger are available for separate purchase.
- 810P accepts microSD Memory Card (not included). Purchase microSD Memory Card to use related functions.
  - Use microSD Memory Cards up to 2GB (February, 2007). Memory Card compatibility is not guaranteed.
- microSD Memory Card is referred to as "Memory Card" in this manual.

## Safety Precautions

- Before use, read these safety precautions carefully and use your handset properly. Keep this manual in a safe place for future reference.
- These safety precautions contain information intended to prevent bodily injury to the user and to surrounding people, as well as damage to property, and must be observed at all times.
- These symbols indicate exposure levels to bodily harm from failure to observe cautions or improper usage:

	<b>Danger</b>	Great risk of death or serious injury from improper use
	<b>Warning</b>	Risk of death or serious injury from improper use
	<b>Caution</b>	Risk of injury or damage to property from improper use

## ■ Symbol Explanations

	Prohibited Action
	Disassembly Prohibited
	Avoid Moisture
	Always Dry Hands First
	Compulsory Action
	Disconnect Power Source

## Handset, Battery & Charger



### Danger



Use specified battery, charger and holder. The use of devices other than those specified may result in malfunction of handset or battery. Leaking, overheating, explosion or fire may occur. Battery PMBAC1, Desktop Holder PMEAC1, AC Charger PMCAA1, In-Car Charger PMJAA1



Do not get handset, battery and charger wet. If liquids such as water or pet urine get into battery and charger, they may cause overheating, electric shock or malfunction. Do not use handset in damp places like bathrooms.



Do not disassemble or modify handset. May cause accidents such as fire, bodily injury, electric shock or equipment malfunction.



### Warning



Do not place handset, battery or charger inside cooking appliances, such as microwave ovens or high-pressure containers. Battery may leak, overheat, explode or catch fire, and handset and charger may overheat, emit smoke or catch fire. The internal circuit may also be damaged.



Do not throw or otherwise subject to strong force or impacts. Battery may leak, overheat, explode, catch fire, or cause damage to handset.



Keep handset off and charger disconnected near filling stations or places with fire/explosion risk. Handset use near petrochemicals or other flammables may lead to fire or explosion.



### Caution



Do not use or leave handset, battery or charger in locations subject to high temperature, such as under in sunlight or inside a car on an extremely hot day. Battery may leak, overheat, explode, catch fire, or deform handset and cause damage. Part of the casing may also become hot and cause burns.



Do not store handset in humid or dusty places, or in high temperature environments. May cause malfunction.



Keep handset out of the reach of young children. May result in electric shock or bodily injury.



If for use by child, guardian should teach proper handling and ensure handset is used as directed. May result in bodily injury.

## Battery



### Danger

See battery label to confirm battery type.

Label	Battery Type
Li-ion	Lithium-ion

	Do not throw battery into fire. Battery may leak, overheat, explode or catch fire.
	Do not pierce battery with a nail or other sharp object, hit it with a hammer, or step on it. Battery may leak, overheat, explode or catch fire.
	Do not use excessive force to attach battery to handset even when you cannot attach it successfully. Also, check that battery is the right way round when you attach it. Battery may leak, overheat, explode or catch fire.
	Do not use or leave battery in places where it is exposed to high temperatures, such as near an open flame or heating appliance. Battery may leak, overheat, explode or catch fire.



Do not touch terminals with metallic objects or carry/store battery with metal jewelry, etc.  
Battery may leak, overheat, explode or catch fire.



If battery fluid gets into eyes, do not rub; flush with clean water and see a doctor immediately.  
Failure to do so may cause blindness.



### Warning



If battery does not charge after specified time, stop charging.  
Battery may leak, overheat, explode or catch fire.



If battery leaks or emits an unusual odor, immediately stop use and move it away as far as possible from any flame or fire.  
Battery fluid is flammable and could ignite, causing fire or explosion.



If battery leaks or emits an unusual odor, immediately remove it away from handset.  
Battery may leak, overheat, explode or catch fire.



If battery fluid comes into contact with your skin or clothing, stop using handset immediately and rinse it off with clean water.  
Battery fluid is harmful to your skin.



## Caution



Do not dispose of battery with ordinary refuse. May cause fire and environmental damage. Place tape over the terminals to insulate battery, and take it to a SoftBank retailer or institution that handles used batteries in your area.

## Handset



## Warning



Do not use handset while driving a vehicle. Doing so may interfere with safe driving and cause an accident. Stop your vehicle to park in a safe place before using handset. Drivers using handsets while driving are subject to prosecution.



Turn off handset near high-precision electronic devices or devices using weak electronic signals. Handset may possibly cause these devices to malfunction.

\*Electronic devices that may be affected: Hearing aids, implantable cardiac pacemakers, implantable cardioverter defibrillators, other medical electronic devices, fire alarms, automatic doors and other automatically controlled devices.

Persons using an implantable cardiac pacemaker or cardioverter defibrillator, or other electronic medical devices, should consult the device manufacturer or vendor for advice on possible radio wave effects.



Do not turn up the headphone volume to a level where you cannot hear the sounds around you while you are walking. Also, look out for the surrounding traffic and road surface conditions. May cause an accident.



Turn off handset where use is prohibited, such as aboard aircraft or in hospitals.

Handset may interfere with the operation of sensitive devices and electronic medical equipment. Follow the instructions given by the respective medical facilities regarding the use of mobile phones on their premises. In addition, actions such as speaking on a mobile phone aboard aircraft are prohibited and may be punishable by law.



If you are using electronic medical equipment, do not put handset in your breast pocket or in the inside pocket of your jacket.

Using handset in close proximity to electronic medical equipment may cause the equipment to malfunction.



If you have a weak heart, take extra precautions when setting functions such as Vibration or Ringer Volume for incoming transmissions.



Do not aim the infrared port at eyes when using infrared communication.

Doing so may affect eyes. Also, aiming it towards other infrared devices may interfere with the operation of these devices.



## Caution



Handset may become hot while in use. Avoid prolonged skin contact that may result in burns.



Using handset in a vehicle may sometimes affect the electronic equipment of some models.  
In such cases, stop using handset, as this could impede safe driving.



Do not swing handset by its strap, etc.  
Handset may strike you or others resulting in injury or damage to handset or other property.



Do not place your ear too close to the speaker while ringer sounds or sound files play.  
May impair hearing.







Do not turn up the volume unnecessarily high when using headphones.  
Using headphones with volume turned up for an extended period may impair hearing or injure ears.



In a thunderstorm, immediately turn off handset and seek shelter.  
There is a risk of being struck by lightning and suffering electric shock.









Do not place a magnetic card near or in handset.  
The stored magnetic data in cash cards, credit cards, telephone cards and floppy disks, etc. may be erased.

	Do not expose camera lens to direct sunlight or a powerful light source for an extended period. Lens may focus the beam, causing fire or malfunction.
	Do not touch broken display/camera lens glass. Display and camera lens are designed not to shatter, however, touching the broken glass may cause injury.
	Avoid closing handset on fingers or objects when opening it. May result in injury or damage to display.
	Handset use may cause itching, rashes, eczema or other symptoms depending on the user's physical condition. In this case, immediately stop use and seek medical treatment.
	Be careful when handling USIM Card Holder. Sharp edges on metallic holder may cause injury.

## Charger



### Warning

	Do not use if charger cord is damaged. May cause electric shock, overheating, or fire.
	Place charger and Desktop Holder on a stable surface during charging. Do not cover or wrap charger or Desktop Holder. May cause overheating, fire or malfunction.
	Do not handle charger with wet hands. May result in electric shock.
	Always use the specified power supply/voltage. Using incorrect voltage may cause malfunction/fire. AC Charger: AC100V-240V In-Car Charger: DC12V, 24V (vehicles with a negative earth only)
	Do not use handset/charger in thunderstorms. There is a risk of being struck by lightning and suffering electric shock.
	Do not short-circuit or touch charging terminals. May result in fire, electric shock, equipment malfunction or bodily injury.





Use In-Car Charger in vehicles with a negative (-) earth. Do not use In-Car Charger if vehicle has a positive (+) earth.  
May cause fire.



Avoid wires and other metal objects and secure the plug when plugging in AC outlet.  
May cause electric shock, short-circuiting or fire.



Unplug AC Charger during periods of disuse.  
May cause electric shock, malfunction or fire.



If In-Car Charger fuse blows, always replace it with specified fuse.  
Using the incorrect fuse may cause fire or malfunction. Refer to the respective manuals for information on the correct fuse specifications.



If liquid such as water or pet urine get into charger, unplug it immediately.  
May cause electric shock, smoke emission or fire.



Wipe off any dust on the plug.  
May cause fire.



## Caution



Do not place heavy objects on charger cord.  
May cause electric shock or fire.



Always unplug charger before cleaning it.  
May result in electric shock.



Pull plug (not cord) to unplug charger.  
Pulling on the cord may damage the cord and cause electric shock or fire.



Do not charge battery if it is wet.  
May cause battery to overheat, catch fire or explode.

## Near Electronic Medical Equipment



### Warning

This section is based on "Guidelines on the Use of Radio Communications Equipment such as Cellular Telephones and Safeguards for Electronic Medical Equipment" (Electromagnetic Compatibility Conference, April 1997) and "Report of Investigation of the Effects of Radio Waves on Medical Equipment, etc." (Association of Radio Industries and Businesses, March 2001).



If you use an implantable cardiac pacemaker or cardioverter defibrillator, keep handset more than 22 cm away from the implant at all times. Handset radio waves may affect implantable cardiac pacemaker or cardioverter defibrillator operations.



Observe the following in medical facilities.

- Do not take handset into operating rooms, Intensive Care Units or Coronary Care Units.
- Turn off handset inside hospital wards.
- Turn off handset even outside hospital wards (in hospital lobbies, etc.); electronic medical equipment may be in use nearby.
- Where a medical facility has specific instructions prohibiting the carrying and use of mobile phones, observe those instructions strictly.



Turn off handset in crowded places such as rush hour trains; implantable cardiac pacemakers or cardioverter defibrillators may be in use nearby. Handset radio waves may affect implantable cardiac pacemaker or cardioverter defibrillator operations.



Persons using electronic medical equipment outside medical facilities should consult the vendor about possible radio wave effects.

# Handling Precautions

## General Notes

- SoftBank is not liable for damages from accidental loss/alteration of handset/Memory Card information (Phone Book entries, images/sound files, etc.). Back-up important information.
- Handset transmissions may be disrupted inside buildings, tunnels or underground, or when moving into/out of such places.
- Use handset without disturbing others.
- Handsets are radios as stipulated by the Radio Law. Under the Radio Law, handsets must be submitted for inspection upon request.
- Handset use near landlines, TVs or radios may cause interference.
- Beware of eavesdropping.  
Digital signals reduce interception, however transmissions may be overheard. Deliberate/accidental interception of communications constitutes eavesdropping.  
"eavesdropping" means radio communication is received by another receiver deliberately or accidentally.

## Handling in Vehicles

- Do not use handset while driving.
- Do not park illegally to use handset.
- Handset use may affect vehicle electronic equipments.

## Handling Aboard Aircraft

- Never use handset aboard aircraft. (Keep handset power off.) Handset use may impair aircraft operation.

## Electromagnetic Waves

- For body worn operation, this mobile phone has been tested and meets RF exposure guidelines when used with an accessory containing no metal and positioning the handset a minimum 15 mm from the body. Use of other accessories may not ensure compliance with RF exposure guidelines.

## FCC Notice

- This device complies with part 15 of the FCC Rules. Operation is subject to the following two conditions:  
(1) This device may not cause harmful interference, and  
(2) this device must accept any interference received, including interference that may cause undesired operation.

- Changes or modifications not expressly approved by the manufacturer responsible for compliance could void the user's authority to operate the equipment.

## FCC RF Exposure Information

Your handset is a radio transmitter and receiver. It is designed and manufactured not to exceed the emission limits for exposure to radio frequency (RF) energy set by the Federal Communications Commission of the U.S. Government.

The guidelines are based on standards that were developed by independent scientific organisations through periodic and thorough evaluation of scientific studies. The standards include a substantial safety margin designed to assure the safety of all persons, regardless of age and health.

The exposure standard for wireless handsets employs a unit of measurement known as the Specific Absorption Rate, or SAR. The SAR limit set by the FCC is 1.6 W/kg. The tests are performed in positions and locations (e.g. at the ear and worn on the body) as required by the FCC for each model.

The highest SAR value for this model handset when tested for use at the ear is 0.964 W/kg and when worn on the body, as described in this user guide, is 0.314 W/kg.

Body-worn Operation; This device was tested for typical body-worn operations with the back of the handset kept 1.5 cm from the body. To maintain compliance with FCC RF exposure requirements, use accessories that maintain a 1.5 cm separation distance between the user's body and the back of the handset. The use of beltclips, holsters and similar accessories should not contain metallic components in its assembly.

The use of accessories that do not satisfy these requirements may not comply with FCC RF exposure requirements, and should be avoided. The FCC has granted an Equipment Authorisation for this model handset with all reported SAR levels evaluated as in compliance with the FCC RF emission guidelines. SAR information on this model handset is on file with the FCC and can be found under the Display Grant section of <http://www.fcc.gov/oet/fccid> after searching on FCC ID UCE207001B. Additional information on Specific Absorption Rates (SAR) can be found on the Cellular Telecommunications & Internet Association (CTIA) website at <http://www.phonefacts.net>.

## European RF Exposure Information

Your mobile device is a radio transmitter and receiver. It is designed not to exceed the limits for exposure to radio waves recommended by international guidelines. These guidelines were developed by the independent scientific organization ICNIRP and include safety margins designed to assure the protection of all persons, regardless of age and health.

The guidelines use a unit of measurement known as the Specific Absorption Rate, or SAR. The SAR limit for mobile devices is 2 W/kg and the highest SAR value for this device when tested at the ear was 1.36 W/kg\*. As mobile devices offer a range of functions, they can be used in other positions, such as on the body as described in this user guide\*\*. In this case, the highest tested SAR value is 0.552 W/kg. As SAR is measured utilizing the devices highest transmitting power the actual SAR of this device while operating is typically below that indicated above. This is due to automatic changes to the power level of the device to ensure it only uses the minimum level required to reach the network.

The World Health Organization has stated that present scientific information does not indicate the need for any special precautions for the use of mobile devices. They note that if you want to reduce your exposure then you can do so by limiting the length of calls or using a hands-free device to keep the mobile phone away from the head and body.

\*The tests are carried out in accordance with international guidelines for testing.

\*\* Please see General Note (Electromagnetic Waves) on page 19-11 for important notes regarding body worn operation.

## Declaration of Conformity

### CE0168

We, Panasonic Mobile Communications Development of Europe Ltd., declare that SoftBank 810P conforms with the essential and other relevant requirements of the directive 1999/5/EC.

A declaration of conformity to this effect can be found at <http://panasonic.co.jp/pmc/products/en/support/index.html>

## Handset Care

- If handset is left with no battery or an exhausted one, data may be altered/lost. SoftBank is not liable for any resulting damages.
- Use handset within temperatures of 5°C to 35°C and humidity 35% to 85%. Avoid extreme temperatures/direct sunlight.
- Handset may become warm during use or charging. This is not malfunction.
- Exposing lens to direct sunlight may damage color filter and affect image color.
- Do not drop or subject handset to shocks.
- Soiled terminals may cause poor connection and loss of power. If the terminals are dirty, use a dry cloth or cotton swab to wipe them clean.
- Clean handset with dry, soft cloth. Using alcohol, thinner, etc. may damage it.
- Do not expose handset to rain, snow or high humidity.
- 810P is a radio communication device assembled with precision components. Never disassemble or modify handset.
- Avoid forceful rubbing or scratching handset displays.
- Be conscious of sound bleed from headphones.

- 810P is not water-proof. Avoid exposure to liquids and high humidity.
  - Do not expose handset to precipitation.
  - Air conditioned air may condense causing corrosion.
  - Do not put handset in damp places like bathrooms.
  - On the beach, keep handset away from sun and surf.
  - Perspiration in handset may cause malfunction.
- Do not subject handset to excessive force; may cause malfunction or bodily injury.
  - Do not sit down with handset in a back pocket.
  - Do not place heavy objects on handset in a bag.
- Do not remove nameplate; doing so invalidates warranty.
- Always turn off handset before removing battery. If battery is removed while saving or sending mail, data may be altered or lost.
- LCD is manufactured with high precision technology, however, some pixels may appear darker/brighter.
- Connect only specified products to Earphone Port.

## Function Usage Limits

These functions are disabled after handset replacement/ upgrade or service cancellation: Camera; Media Player; S! Applications.

After a period of disuse, these functions may become unusable.

## Copyrights

Sounds, images, computer programs, databases, other copyrighted materials, their respective works and copyright holders are protected by copyright laws. Duplicated materials are limited to private use only. If duplications (including conversion of data types), modifications, transfer of duplicates or distribution on networks are made without permission of copyright holders, this constitutes "Literary Piracy" and "Infringement of Copyright Holder Rights" and a criminal action for reparations and criminal punishment may be filed. If duplicates are made using handset, please observe the copyright laws. 810P is equipped with a camera. Materials captured with the camera are also subject to the above.

## Minding Mobile Manners

Please use your handset responsibly. Use these basic tips as a guide. Inappropriate handset use can be both dangerous and bothersome. Please take care not to disturb others when using your handset. Adjust handset use according to your surroundings.

- Turn it off in theaters, museums and other places where silence is the norm.
- Refrain from using it in restaurants, hotel lobbies, elevators etc.
- Observe signs and instructions regarding handset use aboard trains, etc.
- Refrain from use that interrupts the flow of pedestrian or vehicle traffic.

## Manner-related Features

<b>Manner Mode</b>	Press Manner key (☰ P.19-20) to mute 810P tones and activate vibration for incoming transmissions and Answer Phone.
<b>Vibration Mode</b>	Activate in public places, meetings, etc. for silent call/message alerts.
<b>Ringer Volume</b>	Mute call/message tones or S! Appli sounds.
<b>Offline Mode</b>	Suspend all 810P transmissions; when active, all calls/messages and incoming information are temporarily blocked.
<b>Answer Phone</b>	Use to handle incoming calls when inappropriate/unsafe to answer.
<b>Drive Mode</b>	Press Drive Mode key (☰ P.19-20) to handle incoming calls while driving. Change ringtones or ringer volume to customize.

# USIM Card

Universal Subscriber Identity Module (USIM) Card is an IC card containing customer and authentication information, including handset number, and limited Phone Book entry and SMS message storage. USIM must be inserted to use 810P or Network services (calling, messaging, Web, etc.). Turn handset off before inserting/removing USIM Card.

## Inserting/Removing

- Remove battery (☞ P.19-18) then follow steps below.

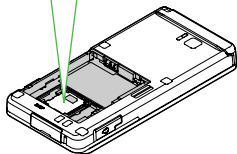
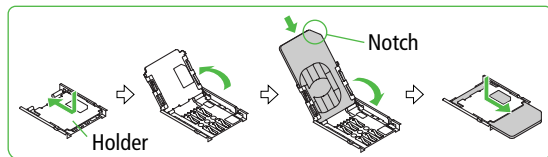

- 1 Press on Holder lightly, slide and lift it as shown
- 2 Insert USIM Card into Holder as shown
  - To remove USIM Card, grasp top portion (without touching the IC) and pull gently.

## 3 Replace Holder and slide it in as shown



- If 810P is dropped/subjected to shock, **Restarting USIM Please wait** may appear; 810P returns to Standby. This is not malfunction.
- If **Insert USIM** appears, clean and properly reinsert USIM Card then restart 810P.
- Do not force USIM Card into or out of 810P as it may damage handset/USIM Card.
- Be careful not to lose the removed USIM Card.
- Avoid touching USIM Card terminals or IC chip; doing so may hinder performance.
- If USIM Card/810P (USIM Card inserted) is lost/stolen, contact SoftBank Customer Center (☞ P.19-50) immediately to prevent misuse.
- Some downloaded files may be inaccessible after repairs, USIM Card replacement or handset upgrade/replacement.
- USIM Card specifications/performance may change without prior notice.
- Pre-installed S! Applications (BookSurfing, Near Chat, etc.) may be unusable while a different or replacement USIM Card is inserted into 810P.
- Be careful when handling USIM Card Holder. Sharp edges on metallic holder may cause injury.



# Charging Battery

## Battery & Charger

Charge battery before use or after a period of disuse.

### Battery Life

- Use or store battery between 5°C - 35°C.
- Use specified charger only. Battery may deteriorate, overheat or cause fire.
- Replace battery if operating time shortens noticeably.

### Charging

- Do not use charger for other purposes.
- Battery may short-circuit, overheat or burst from contact with metal objects.
- Charger, battery and handset may become warm during charging.
- Move charger away from TV/radio if interference occurs.

### Precautions

- Clean 810P, battery & charger with dry cotton swab.
- Charge battery at least once every six months.
- Use a case when carrying battery separately.

### Battery Disposal

- Do not dispose of exhausted batteries with ordinary refuse. Tape over battery terminals before disposal, or bring them to a SoftBank shop. Follow local regulations regarding battery disposal.

## Battery Installation & Removal

- Always turn off handset power before opening handset to remove battery (👉 P.19-26).

**1** Slide battery cover, then lift to remove

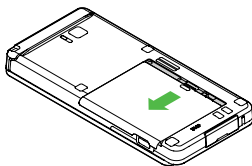

**2** **Insert Battery**  
Align battery contacts with handset pins.

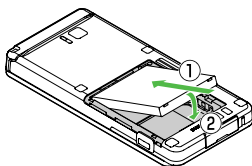

**Remove Battery**  
Lift battery out as shown.

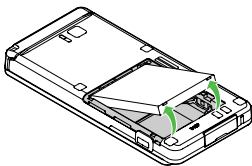

**3** Replace battery cover  
Cover should click into place.

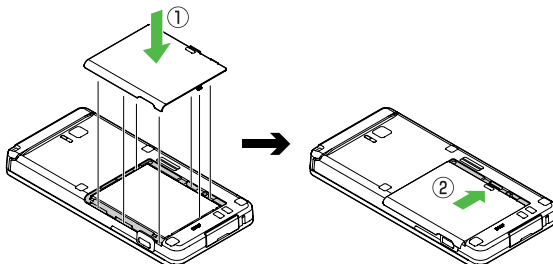

**Note**

When battery is removed just after changing handset settings, changes may not take effect.



**Tip**

Lithium-ion batteries are valuable and recyclable resources.

- Recycle used lithium-ion battery at a shop displaying the symbol shown to the right.
- To avoid fire or electric shock, do not:
  - Short-circuit battery
  - Disassemble battery



**Li-ion**

## Charging Battery

Charging takes approximately 160 minutes.

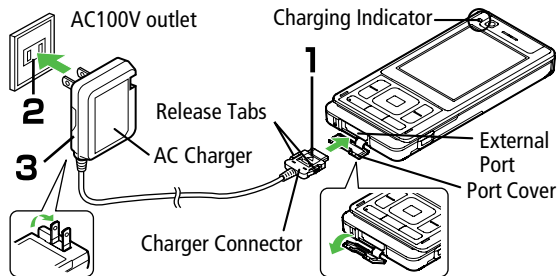

- 1** Connect AC Charger to handset  
Insert Charger Connector (printed side up) into External Port.
- 2** Plug AC Charger into AC outlet  
Extend Charger blades. (Fold back when not in use.)  
Charging Indicator illuminates and charging starts.  
When Charging is complete, Charging Indicator goes out.

- 3** When charging is complete, unplug AC Charger, then disconnect handset  
Squeeze Release Tabs to remove Charger Connector, and replace Port Cover.



- Use only the specified charger.
- Do not pull, bend or twist AC Charger cord.
- AC Charger is compatible with household currents between AC 100V and 240V.
- SoftBank is not liable for problems resulting from charging 810P abroad.



Desktop Holder and In-Car Charger are available for separate purchase.

# Handset Parts & Functions

## Internal

### Internal Camera

Use during video calls

### Illumination Light/Charging Indicator

Lights for incoming transmissions, charging, etc.

### Display

### Left Softkey

Execute Left Softkey function



### Video Call/Input Mode/Drive Mode Key

Initiate Video Call to number on Display  
Toggle input mode in text entry windows  
Press and hold in Standby to toggle Drive mode



### Clear Key

Delete characters or highlighted items



### Send/Redial & A/a Key

Initiate or answer calls; toggle upper/lower case roman letters in text entry windows



### Keypad

### \* /Symbol Key





Open Symbols/Pictographs in text entry windows



### Earpiece

### Multi Selector



Scroll up , down , left , right  to navigate menus and text. Press  to select a menu item, release shutter or start recording

### Right Softkey



Execute Right Softkey function

### Camera & Line Break/Mic Mute Key



Activate Camera in Standby or enter a line break in a text entry window

### End/Escape & Power Key



Reject/end calls; return to Standby  
Press and hold to turn power on/off

### Side Key



While 810P is ringing, press to mute ringer  
Release shutter or start recording

### # /Manner Key



Press and hold in Standby to toggle Manner mode

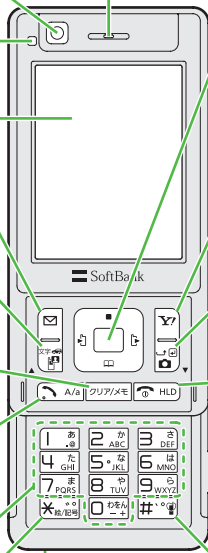

## External

### Memory Card Slot

Insert microSD Memory Card here

### Infrared Port

Transfer data via Infrared

### Strap Eyelet

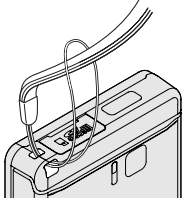

### Antenna

### Portrait/Macro Selector

### External Camera

### Camera Mode Indicator

Illuminates while Camera/Video Camera is active

### Speaker

### Earphone Port

Connect earphone/microphones here

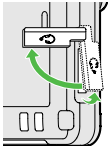

### Charging Terminals



### External Port

Connect AC Charger or other accessories here

### Opening/Closing 810P

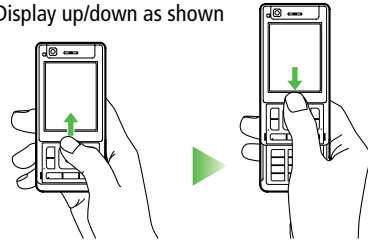
Slide Display up/down as shown



- Closing 810P in Standby activates Keyguard automatically (Close-to-Enable Keyguard:  P. 19-28). When opening, Keyguard is released. To use with 810P closed,  → .

# Display

## Display Indicators

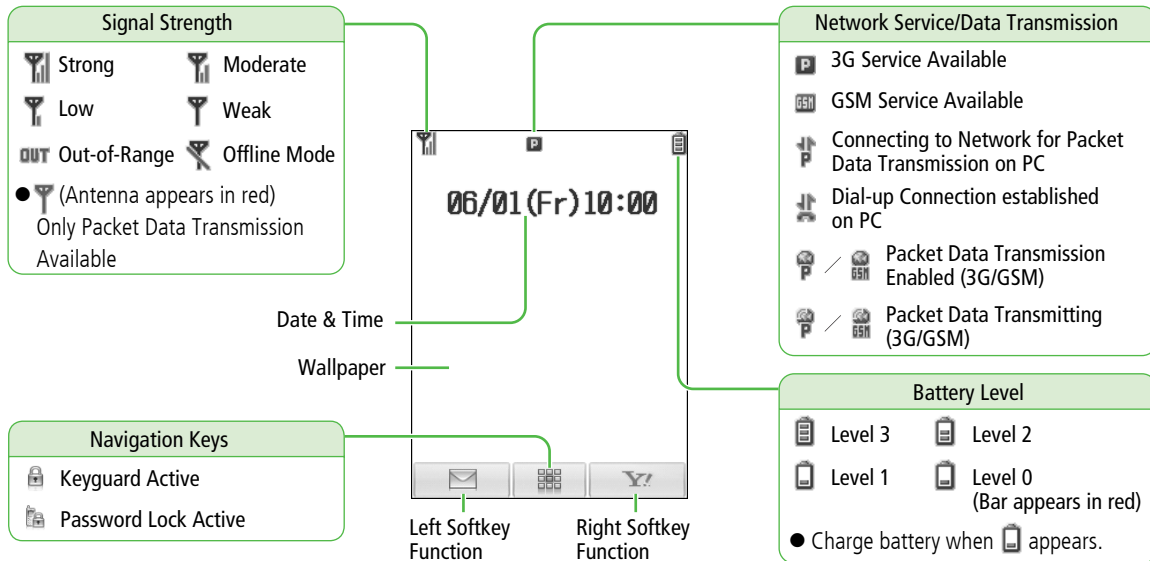

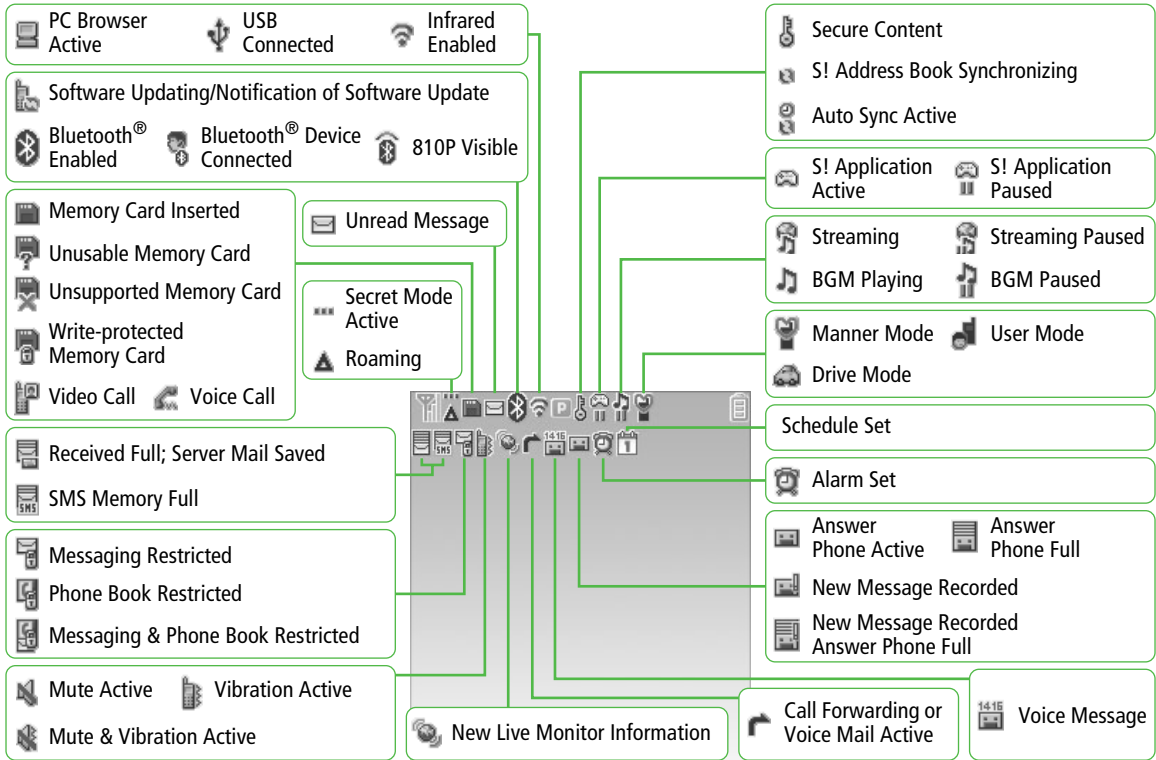

## Using This Manual

### Multi Selector & Softkeys

Use Multi Selector to select items, navigate menus, etc. Softkeys correspond to functions/commands appearing at the bottom of Display.

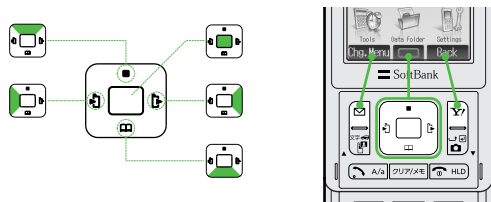

### Menu Navigation

In this manual, handset operations required before steps appear as shown and described in the example below:

**Main menu** ► **設定** ► **一般設定** ► **Language**







Open Main menu and navigate sub menus. "►" means "scroll menu and select the menu item, then press .







### Japanese Functions & Services

Japanese ability is required to use the full range of some functions or services. "(Japanese)" appears in the titles.

## Quick Keys

### In Standby

Short Press		Open Main Menu/ Release Keyguard
		Open Phone Book
		Open Messaging menu list
		Access Yahoo! Keitai top menu
		Open Call Log
		Open Answer Phone Message List
		Open Camera

Long Press (more than one second)		Activate Keyguard
		Press and hold for a few seconds to turn handset power on or off
		Open S! Mail Composition window
		Open Yahoo! Keitai menu list
		Enter + (International Code)
		Activate or cancel Manner mode
		Toggle Answer Phone ON/OFF



# Handset Security

## USIM PINs

### PIN1 & PIN2

<b>PIN1</b>	Prevent unauthorized 810P use.
<b>PIN2</b>	Required to clear Total Call Cost or set Cost Limit and Price/unit.

- PIN1 & PIN2 are 9999 by default.
- PIN1 & PIN2 can be changed.
- When PIN1 Entry is **ON**, PIN1 (4-8 digits) is required each time 810P is turned on (with USIM Card inserted).

### PIN Lock & Cancellation (PUK)

PIN1 Lock or PIN2 Lock is activated if PIN1 or PIN2 is incorrectly entered three times. Cancel PIN Lock by entering the Personal Unblocking Key (PUK).

- For information on PUK, contact SoftBank Customer Center, General Information (☎ P.19-50).



- If PUK is incorrectly entered ten times, USIM Card is locked and handset is disabled. Write down PUK.
- For procedures required to unlock USIM Card, contact SoftBank Customer Center, General Information (☎ P.19-50).
- When PIN1 Entry is **ON**, emergency numbers (110, 119, 118) cannot be dialed without entering PIN1.

## Codes

### Handset Code

[Default] 9999

Required to use/change some handset functions.

- \* appears when Handset Code is entered.

### Center Access Code

4-digit number specified at initial subscription; required to access Voice Mail via landlines or subscribe to fee-based information.

## Call Barring Password

4-digit number specified at initial subscription, required to restrict handset services.

If entered incorrectly three times, Call Barring settings lock; Call Barring Password & Center Access Code must be changed. Reach SoftBank Customer Center, General Information (☎ P.19-50) for details.





Note





- Write down Handset Code, Center Access Code and Call Barring Password.
- Do not reveal Handset Code, Center Access Code or Call Barring Password. SoftBank is not liable for misuse or damages.
- For further information about Codes, contact SoftBank Customer Center, General Information (☎ P.19-50).

## Basic Operations

### Power On/Off

- 1 Press and hold  for more than three seconds to turn power on
- 2 To turn power off, press and hold  for more than two seconds

### Retrieving Network Information

When , ,  or  is pressed for the first time, 810P initiates Network Information retrieval;  to retrieve it.

- Update Network Information manually: **Main Menu**  
▶ **Settings** ▶ **Connectivity** ▶ **Retrieve NW Info**

### Language (言語設定)

**Main menu** ▶ **設定** ▶ **一般設定** ▶ **Language**



- 1 自動, *English* or 日本語 → 

## My Phone Number

- 1 In Standby,  

## Date & Time

Main menu ► Settings ► Phone Settings  
► Date & Time ► Home Clock ► Date & Time

- 1 Enter date →  → Enter time → 

## Network Settings

Main menu ► Settings ► Call Settings  
► Optional Services ► International Setting  
► Select Network

- 1 *3G/GSM, 3G, GSM* or *Automatic* → 

## Voice Calls



### Making Voice Calls

- 1 In Standby:





#### Standard Dialing

Enter a phone number and 





#### Calling from Phone Book

 → Select an entry →  → Select a phone number → 

#### Calling from Call Log



  →  to switch to *All Calls, Outgoing* or *Incoming* → Select a record → 

#### International Dialing





Enter a phone number →  [Menu] → *International Call* →  → Select a country →  → 

- 2  HLD to end call

## Answering Voice Calls

- 1 When a call is received,  to talk
- 2  to end call

## Manner Mode

- 1 In Standby, press and hold  or 
  - To cancel, press and hold  or  again.

## Close-to-Enable Keyguard

[Default] ON

Closing 810P in Standby activates Keyguard automatically.  
When opening, Keyguard is released.

Main menu ► Settings ► Phone Settings  
► Keyguard ► Close-to-Enable Keyguard



- 1 *ON* or *OFF* → 

## Answer Phone

Record up to eight voice messages on 810P.







- Unavailable when handset is off, out-of-range or Offline.
- Answer Phone is not available for incoming Video Calls.

## Setting/Canceling Answer Phone

- 1 In Standby, press and hold 
  - To cancel, press and hold  again.

## Playing Messages

When a new message is recorded,  appears in Standby.

- 1 In information window, **Answer Phone** → 
- 2 Select a message →   
Playback starts.
  - To delete a message/all messages: Select a message →  [Menu] → *Delete* or *Delete All* →  →  [YES] → When selecting *Delete All*, enter 4-digit Handset Code → 

# Text Entry

## Key Assignments

Key	Input Modes	
	Alphanumerics	Numbers
	. - @ _ / : ~ 1	1
	a b c A B C 2	2
	d e f D E F 3	3
	g h i G H I 4	4
	j k l J K L 5	5
	m n o M N O 6	6
	p q r s P Q R S 7	7
	t u v T U V 8	8
	w x y z W X Y Z 9	9
	Single-byte space/0	0
		[Press and hold] + *
	Pictograph List/ Symbol List	✖
	[Press and hold] Mail Address & URL List	
	, ! ? ¥ & ( ) * # " ' = ^ + ;	# - , ! ? ¥ & ( ) " ' = ^ + ;

Key	Input Modes	
	Alphanumerics	Numbers
	Toggle input modes	
	Press and hold to toggle double-byte and single-byte characters	
	Line break	
	Toggle upper and lower case characters	
	Press to delete one character after cursor (Delete one character before cursor when cursor is at the end of a sentence)	
	Press and hold to delete all characters after cursor (Delete all characters before cursor when cursor is at the end of a sentence)	

\* Available only in single-byte mode

## Character Input Modes

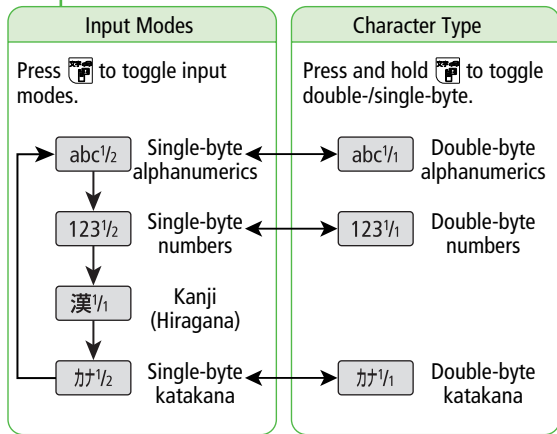
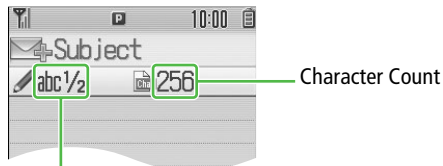

## Symbols & Pictographs

- 1 In alphanumeric mode, to open Pictographs
  - to toggle Pictographs and Symbols.
  - Log list may appear first.
- 2 to select a list → to select a symbol or pictograph →

## Copy/Cut & Paste

Copy or cut text and paste it into text entry windows.

- 1 In a text entry window, [Menu] → **Copy** or **Cut** →
- 2 Place cursor before (or after) text to copy/cut → → Place cursor after (or before) text to copy/cut →
- 3 Place cursor at target location to paste text → [Menu] → **Paste** →

# Phone Book

## Phone Book Entry Items

Save up to 1000 entries in Phone Book. Save phone numbers or mail addresses etc. in USIM Card Phone Book (maximum number of savable entries varies by card).

Item	Description	810P	USIM Card
Last Name / First Name	Enter up to 25 characters (When saving to USIM Card, enter last name and first name in <i>Name</i> .)	<input type="radio"/>	<input type="radio"/>
Reading	Holds up to 25 characters (Automatically entered when <i>Last Name</i> and <i>First Name</i> are entered)	<input type="radio"/>	<input type="radio"/>
Phone Number	Save up to three entries in Phone Book; two in USIM Card Phone Book	<input type="radio"/>	<input type="radio"/>
Email Address	Save up to three entries in Phone Book; one in USIM Card Phone Book	<input type="radio"/>	<input type="radio"/>
Birthday	Enter birth date	<input type="radio"/>	-
Address	Enter postal code, country, state/province, city, street address, additional information	<input type="radio"/>	-
Note	Enter up to 32 characters	<input type="radio"/>	-
Voice Call Ringtone	Set incoming Voice Call ringtone	<input type="radio"/>	-
Video Call Ringtone	Set incoming Video Call ringtone	<input type="radio"/>	-
Message Ringtone	Set incoming message ringtone	<input type="radio"/>	-
Illuminations	Set incoming call/message light color	<input type="radio"/>	-
Picture	Save a still image to appear for incoming calls	<input type="radio"/>	-
Group	Sort Phone Book entries by groups	<input type="radio"/>	<input type="radio"/>
Secret Setting	Restrict access to Phone Book entries by saving them as Secret Mode entries	<input type="radio"/>	-



### Back-up Important Information

Keep a separate copy of Phone Book entry information. When battery is exhausted or removed for extended periods, entries may be lost. Handset damage may also affect data recovery. SoftBank is not liable for damages from lost/altered entries.

## New Phone Book Entries

Main menu ► Phone Book ► Create New Entry

- 1 Select an item → → Enter text →
  - Repeat Step 1 to fill in other fields.
  - Fill in at least one of the following fields: *Last Name*, *First Name*, *Phone Number* and *Email Address*.
- 2 [Save]

## Editing Phone Book Entries

- 1 In Standby, → Select an entry → [Menu] → *Edit* →
- 2 Select an item → → Edit → → [Save]

## Saving Numbers from Call Log

- 1 In Standby, → to switch to *All Calls*, *Outgoing* or *Incoming*
- 2 Select a record → [Menu] → *Add to Phone Book* →
- 3 **New Entry**  
*Create New Entry* → → Add name, etc.  
**Add to Existing Entry**  
Select a Phone Book entry →
- 4 [Save]



# Video Call

Exchange video/sound with video call-compatible mobiles.

- Only available within 3G network coverage.

## Video Call Window

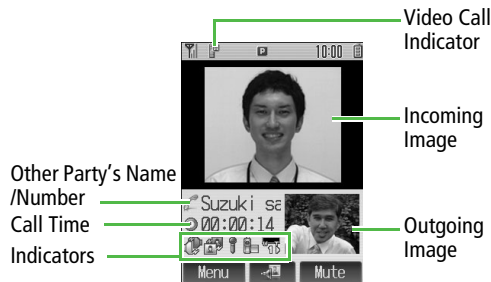

## Making Video Calls

- 1 In Standby, enter a phone number →
- 2 to end call

## Answering Video Calls

- 1 When a video call is received, or
- 2 **Send Internal Image**  
 [YES]  
**Send Alternative Image**  
 [NO]
- 3 to end call

### Video Call Operations

- To adjust volume:
- To zoom outgoing image in or out:
- To toggle Internal Camera and External Camera:





### Selecting a File for Alternative Image

**Main Menu** ▶ **Settings** ▶ **Call Settings** ▶ **Video Call**  
▶ **Alternative Picture** → Select a file → [Decide]

# Camera





## Capturing Still Images

Main menu ► Entertainment ► Camera

- 1 Frame subject →  (Side key) or  to capture the image
- 2 To save the image, [Save]
- 3  to exit

## Recording Video





Main menu ► Entertainment ► Video Camera

- 1 Frame subject →  to start recording
- 2  to end recording
- 3 To save the video clip, *Save to Data Folder*  
→ 
- 4  to exit

# Media Player

## Playing Media Files

Main menu ► Entertainment ► Media Player

- 1 **Playing Music Files**  
*Audio* →  → *All Music List, Music, Ring Song* or *Playlist* →   
**Playing Video Files**  
*Video* →  → *List All, Video Folder* or *Playlist* → 
- 2 Select a file →   
Playback starts.

## Key Assignments

Item	Operation
Adjust Volume	(Increase) /  (Decrease)
Replay Track	
Play Previous	twice (once, within first three seconds of a track)
Play Next	
Rewind* <sup>1</sup>	Press and hold
Forward* <sup>1</sup>	Press and hold
Pause/Resume	
Stop	Music:  twice or  → Video:  or
Show Full Screen* <sup>2</sup>	

\*1 Rewind/Forward may not be available when playing files directly from Data Folder, etc.

\*2 Supported during video playback only

## Memory Card

Save captured images, recorded clips or downloaded files.

- SoftBank is not liable for damages from accidental loss/alteration of Memory Card information. Keep a copy of Phone Book entries, etc. in a separate place.

### Format Memory Card

- Memory Cards formatted on other devices may not be used. Format Memory Card on 810P before use.
- Do not remove Memory Card or battery while formatting; may damage handset or Memory Card.

### Main menu ► Settings ► Memory Card Settings ► Format Memory Card

- 1 → Enter 4-digit Handset Code →
  - Handset Code: P.19-25

# Data Folder

Save captured images, recorded clips, downloaded files, etc. here.

Folder	File Format
Pictures	JPEG (.jpg/.jpeg/.jpe/.jfif), GIF (.gif), PNG (.png), WBMP (.wbmp), BMP (.bmp) JPEG(.jpg) saved in Digital Camera
Sounds	SMAF (.mmf), SP-MIDI (.mid/.midi), Mobile XMF (.mxmf) AMR-NB (.amr) MPEG-4 (.3gp/.mp4/.m4a)
S! Appli	Java
Music	MPEG-4 (.3gp/.mp4/.m4a)
Videos	MPEG-4 (.3gp/.mp4)
Books	CCF (.ccf), XMDF (.zbf/.zbk/.zbs)
Familiar Usability	UIE (.uie)
Message Templates	HTML (.hmt)
Text Memo	Text
Flash (R)	SWF (.swf)
Other Documents	Other format files

## Viewing Data Folder

### Main menu ► Data Folder

- Select a folder → Pictures and Videos appear in Thumbnail view by default.

To Download Site  
 To Memory Card Folder  
 To Digital Camera Folder

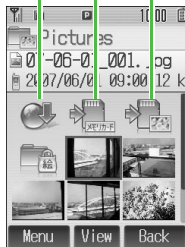

Pictures (Thumbnail)

To Download Site  
 To Phone Folder  
 To Memory Card Folder



Sounds (List)

- Select a file → File appears/plays.

# Connectivity

Transfer Phone Book/Schedule entries, messages, bookmarks and Data Folder files between 810P and compatible devices wirelessly via infrared or Bluetooth®, or connect 810P to PCs via USB Cable.



Some downloaded files may be protected under copyright laws. These files should not be sent.

## Infrared

- Place handset and other device within the effective range of 20 cm, and align the infrared ports.



Infrared is canceled if no transmission is made within three minutes or handset power is turned off.

## Sending

- 1 Select an item → [Menu] → *Send* or *Local Connectivity* →
- 2 Prepare recipient device
- 3 *Infrared* →   
Transfer starts.

## Receiving

Main menu ► Settings ► Connectivity  
► Infrared

- 1 *ON* → → to return to Standby  
 appears in Standby.
  - Acquire infrared transmission within three minutes.
- 2 When sender starts transfer, confirmation appears →
- 3 *Phone* or *Memory Card* →
  - For Phone Book or Schedule entries: [Save]

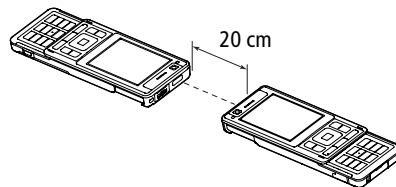



## Bluetooth®

- Wireless transmission security protocols comply with Bluetooth® specifications. However, always take care when transferring files via Bluetooth®; security may be compromised by operating environment/configuration.



### Searching & Pairing Devices

Main menu ► Settings ► Connectivity  
► Bluetooth ► Add New Device

Device search starts.

- 1 Select a device →  → Enter Bluetooth®  
Passcode (4-16 digits) → 

### Sending

- 1 Select an item →  [Menu] → *Send* or  
*Local Connectivity* →  → *Bluetooth* →  

If Paired Device list is empty, device search starts.

- 2 Prepare recipient device

- 3 Select a device → 

Transfer starts.



- When selecting an unpaired device, enter Bluetooth®  
Passcode (4-16 digits) for handset and the other device  
→ 

### Receiving

Main menu ► Settings ► Connectivity  
► Bluetooth ► Settings ► ON/OFF

- 1 *ON* →  → 

 appears in Standby.

- 2 Connection is requested →  → 

- 3 *Phone* or *Memory Card* → 

- For Phone Book or Schedule entries:  [Save]

### USB Cable

Connect 810P to PCs to transfer Data Folder files.

- Install Utility Software on PC before connecting handset.
- See "Utility Software Set Up Guide" for installation/usage details.

## Optional Services

<b>Call Forwarding</b>	Forward unanswerable calls to a preset number when 810P is off/out-of-range.
<b>Voice Mail</b>	Unanswered calls are forwarded to Voice Mail Center as set or when 810P is off/out-of-range. ● Missed Call Notification Information appears for calls missed while 810P was off, out-of-range, etc.
<b>Call Waiting*</b>	Place the current call on hold and answer a second, or alternate between calls.
<b>Multiparty Call*</b>	Call another party during a call and alternate between calls. Add other parties to talk on up to five lines simultaneously.
<b>Call Barring</b>	Restrict calls by condition.
<b>Caller ID</b>	Show or hide your number when calling.

\* Separate subscription required

## Messaging

SoftBank messaging services are available in Japan and overseas.

<b>S! Mail</b>	Exchange longer text messages of up to 30KB with SoftBank or e-mail compatible handsets, PCs, etc.; attach image/sound files.
<b>SMS</b>	Exchange short text messages of up to 70 characters with SoftBank handsets.

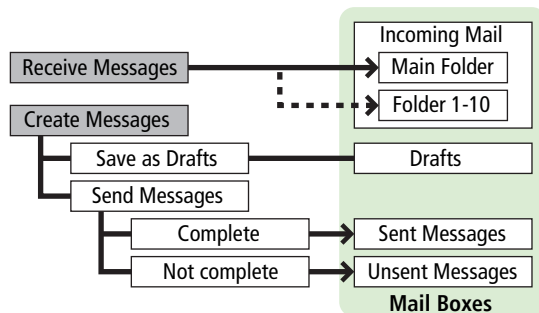

- Separate subscription required to use S! Mail and to receive e-mail.
- The Center resends undeliverable messages at regular intervals until delivered. Messages not delivered by specified expiry are deleted.

## Customizing Handset Address

Change your mail address (alphanumerics before @) to reduce the risk of receiving spam.

Main menu ► Messaging ► Settings

### 1 Custom Mail Address →

Follow onscreen instructions.

## Sending S! Mail & SMS



### Sending S! Mail

Main menu ► Messaging ► Create New S! Mail

### 1 Enter an address

*Add Address* → 



### 2 Select From Phone Book

*Phone Book* →  → Select a Phone Book entry →  → Select a SoftBank handset number or mail address → 



### Enter Directly

*Direct Entry* →  → Enter a SoftBank handset number or mail address → 



### Select From Call Log

*Send Logs* →  → Select a record → 



### 3 Enter a subject

*Add Subject* →  → Enter subject → 

### 4 Enter a message

*Input Text* →  → Enter text → 

### 5 Attach a file

*Add Attachment* →  → Select a folder in Data Folder →  → Select a file →  [Decide]

### 6 [Send]





## Sending SMS

Main menu ► Messaging ► Create New SMS



### 1 Enter an address

*Add Address* → 



### 2 Select From Phone Book

*Phone Book* →  → Select a Phone Book entry →  → Select a SoftBank handset number → 



**Enter Directly**

*Enter Number* →  → Enter a SoftBank handset number → 

**Select From Call Log**

*Send Logs* →  → Select a record → 

### 3 Enter a message

*Input Text* →  → Enter text → 

### 4 [Send]



## Receiving S! Mail & SMS

When a new message is received, Information window appears in Standby.

### Reading S! Mail & SMS

1 In Information window, *Mail* → 

2 *Incoming Mail* → 



3 Select a folder →  → Select a message → 

#### 3D Pictogram

Animate compatible message text, Pictograms and Emoticons.

1 In Message window,  [Menu] → **3D**





*Preview* → 

- To pause/resume: 
- To Cancel:  [Stop]









## Retrieving Complete S! Mail

When the Center sends the initial portion of a message, follow these steps to retrieve the complete message.

Main menu ► Messaging ► Incoming Mail

- 1 Select a folder → 
- 2 Select a message with  or  →  → At the end of message text, highlight ***There are sequels*** → 

### Retrieving Multiple Messages





Select a message with  or  →  [Menu] → ***Retrieve*** →  → ***Selected Messages*** →  → (Select messages → )\* →  [Retrieve] → 

\* When selected,  appears. Repeat as required.

## Reply & Forward





### Replying to Messages

Main menu ► Messaging ► Incoming Mail

- 1 Select a folder → 
- 2 Select a message →  →  [Reply]
  - Step 2 is also available in Message window.
  - To reply to a Cc/Bcc S! Mail: ***To Sender*** or ***Reply to All*** → 
- 3 Complete message →  [Send]

## Forwarding Messages

### Main menu ► Messaging ► Incoming Mail

- 1 Select a folder → 
- 2 Select a message →  [Menu] → *Forward*  
→ 
  - Step 2 is also available in Message window.
  - Attachments are also forwarded.
- 3 Enter recipient's address and complete message  
→  [Send]







Copy protected attachments are not forwardable.

## Yahoo! Keitai Web

Access Mobile Internet or PC sites directly from 810P.

### Opening Yahoo! Keitai Main Menu

#### Main menu ► Yahoo! Keitai ► Yahoo! Keitai

- 1 メニューリスト →  → Select **English** → 
- 2 Select a menu item → 
  - Repeat Step 2 as required.
- 3 To end the session,  → 



Yahoo! Keitai Main menu content is subject to change.

### Live Monitor (Japanese)

Add news headlines, weather forecasts, etc. via Live Monitor List or S! Loop List to scroll across Display in Standby. Update content automatically or manually.

## Using PC Browser

- Some websites may not be viewable.



### Main menu ► Yahoo! Keitai ► PC Site Browser

1 **Homepage** →  → 

- For **Show Every Time**, confirmation appears next time PC Browser is activated.

2 Select an item → 

- Repeat Step 2 as required.

3 To end the session,  → 

## Web Options Menu

In Yahoo! Keitai, press  [Menu] for these options:

Forward	Go to next page
Bookmarks	View Bookmarks list or add a new bookmark to the list
Saved Pages	View Saved Pages list or add a new saved page to the list
Text Copy	Copy text from a web page
Reload Page	Update information
Small Screen/ PC Screen*1	Toggle display size
Page Operation	<b>Frame In/Frame Out:</b> Select a frame to fit full screen <b>Jump to Top:</b> Jump to top of a web page <b>Jump to Bottom:</b> Jump to end of a web page <b>Zoom In/Out:</b> Zoom in/out on a web page
Select item	View or play files, or save them to Data Folder
More	<b>Search:</b> Search text on a web page <b>History:</b> Select an access history to open previously viewed page <b>Send Bookmark:</b> Send URL via S! Mail/SMS <b>Enter URL:</b> Enter URL directly to access websites <b>Property:</b> View detailed information of a web page or electronic certificates for a secure page <b>Flash(R) Menu:</b> Playback/pause Flash® files

To PC Site Browser* <sup>2</sup> / Change Browser* <sup>1</sup>	Toggle Yahoo! Keitai/PC site
Yahoo! Keitai* <sup>2</sup> / Homepage* <sup>1</sup>	View top menu
Settings	Font Size: Change character size Encoding: Change encoding type

\*1 PC Site Browser only

\*2 Yahoo! Keitai only





## S! Appli

S! Appli are Java™-based applications designed to run on SoftBank handsets. Download games and other real-time applications for use on 810P.

- For further information, visit SoftBank Website (<http://www.softbank.jp>).

### Downloading S! Appli

Main menu ► S! Appli ► S! Appli Library

- 1 **Download S! Appli** → 
- 2 Select an S! Application → 
- 3 Follow onscreen instructions
- 4 **Phone** or **Memory Card** → 
  - After downloading, S! Application is saved to Data Folder automatically.
- 5  **[YES]** to activate
  - To exit:  **[NO]**



## Using S! Appli

### Activating S! Appli

Main menu ► S! Appli ► S! Appli Library

- 1 Select an S! Application →   
For operations, see application Help menu.

### Terminating/Pausing S! Appli

- 1 While running an S! Application, 
- 2 *Terminate* or *Suspend* → 

### Resuming/Terminating Paused S! Appli

Main menu ► S! Appli ► S! Appli Library

- 1 *Resume* or *Terminate* → 

## Communication

### S! Town (Japanese)

S! Town is an online communication application. Enjoy events or meeting other users in 3D virtual town.

- Internet connection is required; may incur high packet communication charges.
- S! Town is not available if Internet access is restricted by subscription.
- User agreement and registration are required to use S! Town.

Main menu ► Communication

- 1 *S! Town* →   
810P connects to the Network and S! Town appears.
  - See S! Town Help for usage information.

## S! Loop (Japanese)

A SoftBank Mobile handset communication service.

### Main menu ► Communication

#### 1 *S! Loop* →

810P connects to the Network and S! Loop appears.

- See S! Loop Help for usage information.

## Near Chat (Japanese)

Exchange text messages with other SoftBank handsets or compatible devices wirelessly via Bluetooth®. Transmission/connection fees do not apply.

- Effective range is approximately ten meters.
- Range may vary with ambient signal conditions.
- Requires pre-installed Near Chat S! Application.

### Main menu ► Communication

#### 1 *Near Chat* →

- See application Help menu for usage information.

#### 2 To end Near Chat, → *Suspend* or *Terminate* →

- To resume: Start Near Chat → *Resume* → 



When Bluetooth® is active, compatible Bluetooth® device names appear. Unsolicited device connection requests may be received; reject unwanted requests.

## Software Update

Check for 810P software updates and download as required.

- Connection fees do not apply to updates (including checking for updates, downloading and rewriting).
- Fully charge battery beforehand. Even if  appears, low battery message may appear. In this case, charge battery until Charging Indicator goes out.
- Select a place where signal is strong and stable.
- Do not remove battery during the update. Update will fail.
- Other functions are not available during Software Update.
- 810P is disabled until the update is complete. The update may take some time.

**Main menu ► Tools ► Software Update ► Start**

### 1 Follow onscreen instructions

After download is complete, 810P automatically turns off and restarts before Software Update begins. (This process takes approximately 15 seconds).

#### Checking Update Results

- In Information window, select **Update Results**.
- In Standby, **Main menu ► Tools ► Software Update ► Information**

#### Scheduled Update

Follow onscreen instructions for setup.

Confirmation appears at scheduled update time.

Press  or wait ten seconds for update to start.

- Software Update will not start while 810P is in use. Continuing handset usage for ten minutes or more cancels Scheduled Update.



- Software Update failure may disable 810P. Contact SoftBank Customer Center, Customer Assistance ( P. 19-50).
- Software Update does not affect Phone Book entries, files saved in Data Folder or other content, but it is recommended that you create a backup, as appropriate, of any important information and data (note that some files cannot be copied).
- SoftBank is not liable for damages resulting from loss of data, information, etc.
- Update may automatically cancel Keyguard.



For further information, visit SoftBank Website (<http://www.softbank.jp>).



# Specifications

## 810P

<b>Weight (including battery)</b>	Approx. XXX g	
<b>Dimensions (closed)</b>	Approx. XX x XXX x XXX mm	
<b>Standby Time (closed)</b>	<b>3G</b>	Approx. 350 hours
	<b>GSM</b>	Approx. 270 hours
<b>Talk Time</b>	<b>3G</b>	Approx. 180 minutes
	<b>Video Call</b>	Approx. 90 minutes
	<b>GSM</b>	Approx. 180 minutes
<b>Charging Time</b>	<b>AC Charger</b>	Approx. 160 minutes
	<b>In-Car Charger</b>	Approx. 160 minutes
<b>Maximum Output</b>	<b>3G</b>	0.25 W
	<b>GSM</b>	2.0 W

- Talk Time is an average measured with a new, fully charged battery, with stable signals.
- Standby Time is an average measured with a new, fully charged battery, with handset closed without calls or operations, in Standby with stable signals.
- Talk Time and Standby Time may vary by environment (battery status, temperature, etc.).
- Talk Time and Standby Time may decrease when a S! Application is active.

- Talk Time and Standby Time decrease with handset use in poor signal conditions.

## Battery

<b>Voltage</b>	3.7 V
<b>Battery Type</b>	Lithium-ion
<b>Capacity</b>	730 mAh
<b>Dimensions</b>	Approx. 36 x 4.5 x 46 mm

## AC Charger

<b>Power Source</b>	AC 100 V - 240 V, 50/60 Hz
<b>Input Current</b>	0.12 A
<b>Output Voltage/Current</b>	DC 6.0 V / 650 mA
<b>Charging Temperature</b>	5°C - 35°C
<b>Dimensions (excluding protrusions and cord)</b>	Approx. 49 x 53 x 20 mm

- Specifications subject to change without notice.

# Customer Service

If you have questions about SoftBank handsets or services, please call General Information.

For repairs, please call Customer Assistance.









## SoftBank Customer Centers

From a SoftBank handset, dial toll free at  
157 for General Information or  
113 for Customer Assistance

## SoftBank International Call Center

From outside Japan, dial +81-3-5351-3491  
(Please take care to dial the correct number.  
International charges will apply to this call.)

Call these numbers toll free from landlines.

Subscription Area	Service Center	Phone Number
Hokkaido, Aomori, Akita, Iwate, Yamagata, Miyagi, Fukushima, Niigata, Tokyo, Kanagawa, Chiba, Saitama, Ibaraki, Tochigi, Gunma, Yamanashi, Nagano, Toyama, Ishikawa, Fukui	General Information	 0088-240-157
	Customer Assistance	 0088-240-113
Aichi, Gifu, Mie, Shizuoka	General Information	 0088-241-157
	Customer Assistance	 0088-241-113
Osaka, Hyogo, Kyoto, Nara, Shiga, Wakayama	General Information	 0088-242-157
	Customer Assistance	 0088-242-113
Hiroshima, Okayama, Yamaguchi, Tottori, Shimane, Tokushima, Kagawa, Ehime, Kochi, Fukuoka, Saga, Nagasaki, Oita, Kumamoto, Miyazaki, Kagoshima, Okinawa	General Information	 0088-250-157
	Customer Assistance	 0088-250-113