

Panasonic®



CD Player/Weather Band Receiver with Built-in Bluetooth®

Model: **CQ-BT5107U**

Operating Instructions



MP3



- Please read these instructions (including “Limited Warranty” and “Customer Services Directory”) carefully before using this product and keep this manual for future reference.

Safety Information

- Read the operating instructions for the unit and all other components of your car audio system carefully before using the system. They contain instructions about how to use the system in a safe and effective manner. Panasonic assumes no responsibility for any problems resulting from failure to observe the instructions given in this manual.
- This manual uses pictographs to show you how to use the product safely and to alert you to potential dangers resulting from improper connections and operations. The meanings of the pictographs are explained below. It is important that you fully understand the meanings of the pictographs in order to use this manual and the system properly.

 **Warning** This pictograph intends to alert you to the presence of important operating instructions and installation instructions. Failure to heed the instructions may result in severe injury or death.

 **Caution** This pictograph intends to alert you to the presence of important operating instructions and installation instructions. Failure to heed the instructions may result in injury or material damage.

Warning

Observe the following warnings when using this unit.

- ❑ **The driver should not operate the system while driving.**
Operating the system will distract the driver from looking ahead of the vehicle and can cause accidents. Always stop the vehicle in a safe location and use the parking brake before operating the system.
- ❑ **Use the proper power supply.**
This product is designed for operation with a negative grounded 12 V DC battery system. Never operate this product with other battery systems, especially a 24 V DC battery system.
- ❑ **Keep accessories out of reach of infants.**
Accessories can be ingested, so keep them out of the reach of infants. If an infant ingests accessories, please seek immediate medical attention.
- ❑ **Do not use the product where it is exposed to water, moisture, or dust.**
Exposure of the unit to water, moisture, or dust may lead to smoke, fire, or other damage to the unit. Make especially sure that the unit does not get wet in car washes or on rainy days.
- ❑ **Protect the Deck Mechanism.**
Do not insert any foreign objects into the slot of this unit.
- ❑ **Do not disassemble or modify the unit.**
Do not disassemble, modify the unit or attempt to repair the product yourself. If the product needs to be repaired, consult the shop where you purchased this unit or an authorized Panasonic Servicenter.
- ❑ **Do not use the unit when it is out of order.**
If the unit is out of order (no power, no sound) or in an abnormal state (has foreign matter in it, is exposed to water, is smoking, or smells), turn it off immediately and consult the store where you purchased it.
- ❑ **Refer fuse replacement to qualified service personnel.**
When the fuse blows out, eliminate the cause and have it replaced with the fuse prescribed for this unit by a qualified service engineer. Incorrect replacement of the fuse may lead to smoke, fire, and damage to the product.
- ❑ **Any NOAA broadcast weather report, including current and forecasts, may not reflect your actual weather conditions at your exact time and location. You should always pay attention to your actual weather conditions to make safe decisions accordingly.**

Observe the following warnings when installing.

- ❑ **Disconnect the lead from the negative (-) battery terminal before installation.**
Wiring and installation with the negative (-) battery terminal connected may cause electrical shock and injury due to a short circuit.
Some cars equipped with the electrical safety system have specific procedures of battery terminal disconnection. FAILURE TO FOLLOW THE PROCEDURE MAY LEAD TO THE UNINTENDED ACTIVATION OF THE ELECTRICAL SAFETY SYSTEM RESULTING IN DAMAGE TO THE VEHICLE AND PERSONAL INJURY OR DEATH.
- ❑ **Never use safety-related components for installation, grounding, and other such functions.**
Do not use safety-related vehicle components (fuel tank, brake, suspension, steering wheel, pedals, airbag, etc.) for wiring or fixing the product or its accessories.
- ❑ **Installing the product on the air bag cover or in a location where it interferes with airbag operation is prohibited.**
- ❑ **Check for piping, gasoline tank, electric wiring, and other items before installing the product.**
If you need to open a hole in the vehicle chassis to attach or wire the product, first check where the wire harness, gasoline tank, and electric wiring are located. Then open the hole from outside if possible.
- ❑ **Never install the product in a location where it interferes with your field of vision.**
- ❑ **Never have the power cord branched to supply other equipment with power.**
- ❑ **After installation and wiring, you should check the normal operation of other electrical equipment.**
The continuation of their using in abnormal conditions may cause fire, electrical shock or a traffic accident.
- ❑ **In the case of installation to an airbag-equipping car, confirm warnings and cautions of the vehicle manufacturer before installation.**
- ❑ **Make sure the leads do not interfere with driving or getting in and out of the vehicle.**
- ❑ **Insulate all exposed wires to prevent short circuiting.**

Caution

Observe the following cautions when using this unit.

- Keep the sound volume at an appropriate level.**
Keep the volume level low enough to be aware of road and traffic conditions while driving.
- Do not insert or allow your hand or fingers to be caught in the unit.**
To prevent injury, do not get your hand or fingers caught in moving parts or in the disc slot. Especially watch out for infants.
- This unit is designed for use exclusively in automobiles.**
- Do not operate the unit for a prolonged period with the engine turned off.**
Operating the audio system for a long period of time with the engine turned off will drain the battery.
- Do not expose the unit to direct sunlight or excessive heat.**
Otherwise these will raise the interior temperature of the unit, and it may lead to smoke, fire, or other damage to the unit.
- To ensure safety, never attempt to preset stations while you are driving.**
- Depending upon the transmission condition of electro-magnetic waves, the geographical reasons and/or the weather conditions, you may not receive the NOAA radio partially or at all.**
- Make sure that your weather radio can receive properly before driving, especially, before use in a critical condition.**
- Set the volume level to low enough before the AUX connection is completed.**
Failure to observe this, the loud noise may come out and damage your speakers and your hearing. Direct connection of the speaker/headphone output of an external device without any attenuator may distort sound or damage the connected external device.

Observe the following cautions when installing.

- Refer wiring and installation to qualified service personnel.**
Installation of this unit requires special skills and experience. For maximum safety, have it installed by the shop where you purchased it. Panasonic is not liable for any problems resulting from your own installation of the unit.

- Follow the instruction to install and wire the product.**

Not following the instructions to properly install and wire the product could cause an accident or fire.

- Take care not to damage the leads.**
When wiring, take care not to damage the leads. Prevent them from getting caught in the vehicle chassis, screws, and moving parts such as seat rails. Do not scratch, pull, bend or twist the leads. Do not run them near heat sources or place heavy objects on them. If leads must be run over sharp metal edges, protect the leads by winding them with vinyl tape or similar protection.
- Use the designated parts and tools for installation.**
Use the supplied or designated parts and appropriate tools to install the product. The use of parts other than those supplied or designated may result in internal damage to the unit. Faulty installation may lead to an accident, a malfunction or fire.
- Do not block the air vent or the cooling plate of the unit.**
Blocking these parts will cause the interior of the unit to overheat and will result in fire or other damage.
- Do not install the product where it is exposed to strong vibrations or is unstable.**
Avoid slanted or strongly curved surfaces for installation. If the installation is not stable, the unit may fall down while driving and this can lead to an accident or injury.
- Installation Angle**
The product should be installed in a horizontal position with the front end up at a convenient angle, but not more than 30°. The user should bear in mind that in some areas there may be restrictions on how and where this unit must be installed. Consult your dealer for further details.
- Wear gloves for safety. Make sure that wiring is completed before installation.**
- To prevent damage to the unit, do not connect the power connector until the whole wiring is completed.**
- Do not connect more than one speaker to one set of speaker leads. (except for connecting to a tweeter)**

The following applies only in the U.S.A.

Part 15 of the FCC Rules

FCC Warning:

This device complies with Part 15 of the FCC Rules for Radio Receiver. Operation is subject to the condition that this device may not cause harmful interference. Any unauthorized changes or modifications to this equipment may void the user's authority to operate this device.

Caution

**THIS PRODUCT IS A CLASS I LASER PRODUCT.
USE OF CONTROLS OR ADJUSTMENTS OR PERFORMANCE OF PROCEDURES OTHER THAN THOSE SPECIFIED HEREIN MAY RESULT IN HAZARDOUS RADIATION EXPOSURE.
DO NOT OPEN COVERS AND DO NOT REPAIR BY YOURSELF.
REFER SERVICING TO QUALIFIED PERSONNEL.**

Safety Information (continued)

Notice:

The changes or modifications not expressly approved by the party responsible for compliance could void the user's authority to operate the equipment.

IMPORTANT NOTE:

To comply with the FCC RF exposure compliance requirements, no change to the antenna or the device is permitted. Any change to the antenna or the device could result in the device exceeding the RF exposure requirements and void user's authority to operate the device.

This equipment complies with FCC radiation exposure limits set forth for uncontrolled equipment and meets the FCC radio frequency (RF) Exposure Guidelines in Supplement C to OET65. This equipment has very low levels of RF energy that it deemed to comply without maximum permissive exposure evaluation (MPE). But it is desirable that it should be installed and operated with at least 20 cm and more between the radiator and person's body (excluding extremities: hands, wrists, feet and legs).

This transmitter must not be co-located or operated in conjunction with any other antenna or transmitter.

Accessories

1. Operating Instructions/NOAA Weather Radio Brochure 1
2. Installation hardware.....1 set (→ page 33)

Customer Services Directory

U.S.A.

Customer Services Directory (United States and Puerto Rico)

Obtain Product Information and Operating Assistance; locate your nearest Dealer or Servicer; purchase Parts and Accessories; or make Customer Service and Literature requests by visiting our Web Site at:

<http://www.panasonic.com/support>

or, contact us via the web at:

<http://www.panasonic.com/contactinfo>

You may also contact us directly at:

1-800-211-PANA (7262),

Monday-Friday 9 am-9 pm; Saturday-Sunday 10 am-7 pm, EST.

For hearing or speech impaired TTY users,
TTY: 1-877-833-8855

Accessory Purchases:

(United States and Puerto Rico)

Purchase Parts, Accessories and Instruction Books online for all Panasonic Products by visiting our Web Site at:

<http://www.pasc.panasonic.com>

or, send your request by E-mail to:

npcparts@panasonic.com

You may also contact us directly at:

1-800-332-5368 (Phone) 1-800-237-9080 (Fax Only) (Monday-Friday 9 am to 8 pm, EST.)

Panasonic Services Company

20421 84th Avenue South, Kent, WA 98032

(We accept Visa, MasterCard, Discover Card, American Express, and Personal Checks)

For hearing or speech impaired TTY users,
TTY: 1-866-605-1277

Limited Warranty

U.S.A.

Limited Warranty (For USA and Puerto Rico Only)

PANASONIC AUTOMOTIVE SYSTEMS COMPANY OF AMERICA,
DIVISION OF PANASONIC CORPORATION OF NORTH AMERICA
776 HIGHWAY 74 SOUTH, PEACHTREE CITY, GA 30269

PANASONIC AUTO PRODUCTS LIMITED WARRANTY

LIMITED WARRANTY COVERAGE

If your product does not work properly because of defects in materials and workmanship.

Panasonic Automotive Systems Company of America (referred to as "the warrantor") will, for the length of the period indicated in the chart below, which starts with the date of original purchase ("warranty period"), at its option either (a) repair your product with new or refurbished parts, or (b) replace it with a new or refurbished product. The decision to repair or replace will be made by the warrantor.

Categories	Parts	Labor
Audio Components (except items listed below)	One (1) Year	One (1) Year
Speakers Defective Car Audio Speakers under warranty must be exchanged at the place of purchase. Contact your Dealer for details.	One (1) Year	Not Applicable
Accessories (in exchange for defective items)	Ninety (90) Days	Not Applicable

During the "Labor" warranty period, there will be no charge for labor. during the "Parts" warranty period, there will be no charge for parts. You must carry in or mail in your product during the warranty period. If non-rechargeable batteries are included, they are not warranted. This warranty only applies to products purchased and serviced in the United States or Puerto Rico. This warranty is extended only to the original purchaser of a new product which was not sold "as is". A purchase receipt or other proof of the original purchase date is required for warranty service.

CARRY-IN OR MAIL-IN SERVICE

For Carry-In or Mail-In Service in the United States and Puerto Rico, call 1-800-211-PANA (7262) or visit
Panasonic Web Site: <http://www.panasonic.com>

LIMITED WARRANTY LIMITS AND EXCLUSIONS

This warranty ONLY COVERS failures due to defects in materials and workmanship, and DOES NOT COVER normal wear and tear or cosmetic damage. The warranty ALSO DOES NOT COVER damages which occurred during shipment, failures which are caused by products not supplied by the warrantor, failures which result from accident, misuse, abuse, neglect, bug infestation, mishandling, misapplication, alteration, faulty installation, set-up adjustment, maladjustment of consumer control, improper maintenance, improper antenna, inadequate signal reception or pickup, power line

surge, improper voltage supply, lightning, modification, commercial use (such as use in hotels, offices, restaurants, or other business uses) or rental use of the product, or service by anyone other than the technician from Factory Servicenter or other authorized service centers, or damage that is attributable to acts of God.

THERE ARE NO EXPRESS WARRANTIES EXCEPT AS LISTED UNDER "LIMITED WARRANTY COVERAGE". THE WARRANTOR IS NOT LIABLE FOR INCIDENTAL OR CONSEQUENTIAL DAMAGES RESULTING FROM THE USE OF THIS PRODUCT, OR ARISING OUT OF ANY BREACH OF THIS WARRANTY.

(As examples, this excludes damages for lost time, cost of having someone remove or re-install an installed unit if applicable, travel to and from the servicer, and loss of media, data or other memory contents. The items listed are not exclusive, but are for illustration only.) **ALL EXPRESS AND IMPLIED WARRANTIES, INCLUDING THE WARRANTY OF MERCHANTABILITY, ARE LIMITED TO THE PERIOD OF THE LIMITED WARRANTY.**

Some states do not allow the exclusion or limitation of incidental or consequential damages, or limitations on how long an implied warranty lasts, so the exclusions may not apply to you.

This warranty gives you specific legal rights and you may also have other rights which vary from state to state. If a problem with this product develops during or after the warranty period, you may contact your dealer or Servicenter. If the problem is not handled to your satisfaction, then write to warrantor's Consumer Affairs Department at the addresses of the warrantor.

PARTS AND SERVICE WHICH ARE NOT COVERED BY THIS LIMITED WARRANTY ARE YOUR RESPONSIBILITY.

Customer's Record

Model

No. _____

Serial

No. _____

Dealer's

No. _____

Code

No. _____

Dealer's

Address _____

Date of

Purchase _____

Contents

Safety Information	2	Alarm Setting	21
Accessories	4	Alarm time setting	
Customer Services Directory	4	Turning ON/OFF the alarm	
Limited Warranty	5	Activating snooze	
Features	7	Troubleshooting	22
Front AUX terminal		If you suspect something wrong	
Sound control		Common	
Bluetooth®		Radio	
Controls Layout	8	CD	
Preparation	9	MP3	
First time power on		Bluetooth®	
Clock adjustment		Product servicing	
General	10	Error Display Messages	26
Source selection		CD/MP3	
Power		Bluetooth®	
Volume		Maintenance	27
Sound Controls	11	Cleaning this unit	
Audio modes (Bass/Treble/Balance/Fader/SQ)		Fuse	
Radio	12	Notes on MP3	28
Band		Cautions as to compressed audio files	
Preset station selection		Cautions as to the display of this unit	
Frequency adjustment		Recording MP3 files on a CD-Media	
Auto preset memory (APM)		Common	
Manual preset memory		Notes on Discs	30
Tuning in a weather band station		How to hold the disc	
CD/MP3 Player	14	Unusable discs	
Pause		Disc insert	
Disc loading/ejection		Disc cleaning	
Folder selection (MP3)		Notes on CD-Rs/RWs	
Track/File selection		Notes on Bluetooth®	31
Display change		Frequency band used	
Scan, repeat, random		Usage limitations	
Bluetooth® - General	16	Influence from other devices	
Display change		Application limitations	
Registration of a Bluetooth® device with this unit		Installation Guide	32
Setting of PIN (Personal Identity Number) code		Overview	
Connection of the registered Bluetooth® device to this unit		Dashboard specifications	
Disconnection of the Bluetooth® device		Preparation	
Deletion of the registered data		Dashboard installation	
Bluetooth® - Hands-Free Phone	18	Installation hardware	
Switching between the private mode and hands-free mode		Securing of the main unit	
Phone answering		Removing the unit from the vehicle's dashboard	
Phone hanging up		Securing of the Microphone with Bracket	
Incoming call rejection		Electrical Connections	36
Outgoing call termination		Wiring diagram	
Setting of automatic answering function		Speaker Connections	
Use of voice dial		Specifications	38
Use of receiving/calling records or telephone directory (phonebook)		General	
Bluetooth® - Music Player	20	Front AUX Input	
Pause		FM Stereo Radio	
Music mode activation		AM Radio	
Song selection		Weather Band Radio	
		CD Player	
		Bluetooth®	

Features

Front AUX terminal

Your mobile audio player and other devices are connectable to this unit without any difficulty.

Sound control

SQ (Sound Quality)

You have four preset modes (FLAT, ROCK, POP and VOCAL).

Bluetooth®

This feature allows users to use a hands-free phone and Bluetooth® audio systems.

Compatible Bluetooth® devices

- Bluetooth® Version: 2.1+EDR
- HFP1.5 (Hands-Free Profile)
- OPP (Object Push Profile)
- A2DP (Advanced Audio Distribution Profile) v 1.2
- AVRCP1.0 (Audio/Video Remote Control Profile)
- HSP v 1.1 (Headset Profile)

Controls Layout

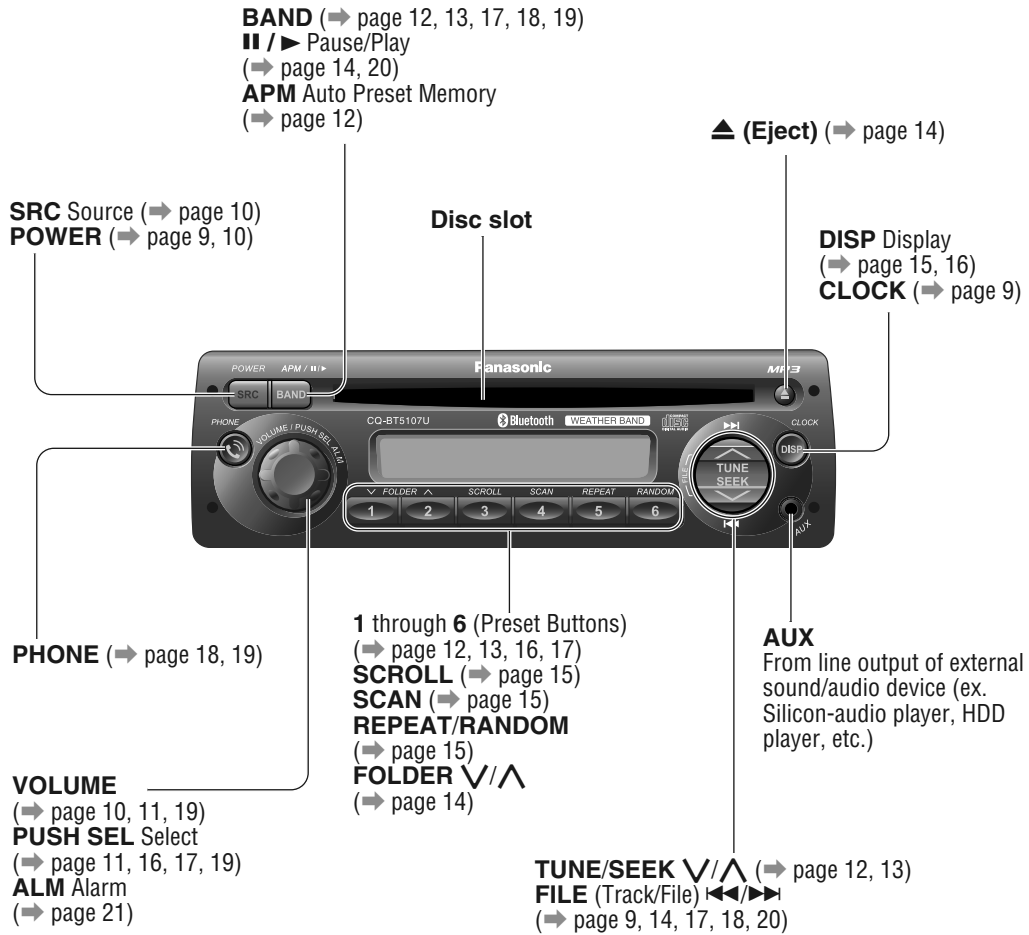

Preparation

First time power on

- 1 Turn the key in the ignition until the accessory indicator lights.
- 2 Press **[POWER]**.

Clock adjustment

The 12-hour (AM/PM) system is used for the clock adjustment.

- 1 Press **[CLOCK]**.

 (Clock display)

- 2 Hold down **[CLOCK]** for more than 2 seconds.

 Hour blinks

- 3 Adjust the hour.

[▶▶]: Sets ahead.
[◀◀]: Sets back.

 Hour entered

*Indicator for AM or PM time

- 4 Press **[CLOCK]**.

 Minute blinks

- 5 Adjust the minute.

[▶▶]: Sets ahead.
[◀◀]: Sets back.

 Minute entered

- 6 Press **[CLOCK]**.

 Completed

Notes:

- Clock can not be adjusted when the unit is power off, to perform clock setting when the unit is power on.
- Clock time is displayed when the unit is power off.
- "CLK ADJ" is displayed when the clock is not adjusted.
- Hold down **[▶▶]** or **[◀◀]** to change numbers rapidly.
- When you want to readjust the time, repeat steps **2** to **6**.
- When the unit is power off, press **[DISP]** to turn ON/OFF the key illumination of this unit.

General

Source selection

The source changes as follows every time [SRC] (Source) is pressed.

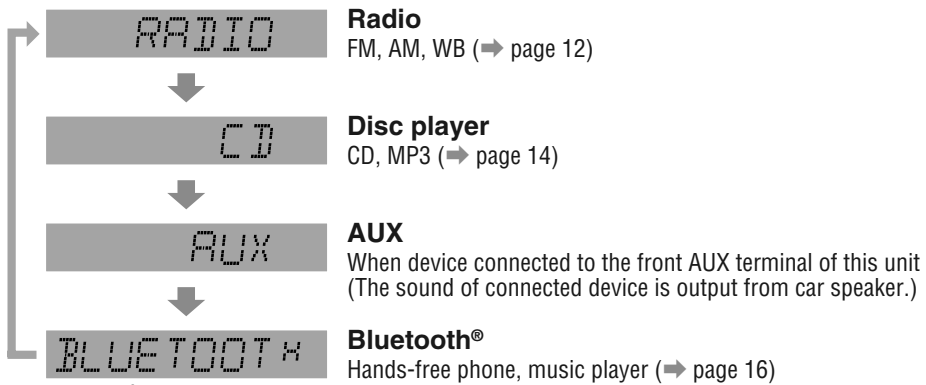

Power

Turn the key in the ignition until the accessory indicator lights.

Power on: Press [POWER] (Power).

WELCOME

Power off: Hold down [POWER] for more than 1 second.

Volume

Turn [VOLUME] clockwise to increase volume, and counterclockwise to decrease volume.

VOL 18

Volume level (0 to 40)
(default:18)

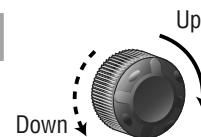

Note: To mute the sound, set volume level to 0.

Sound Controls



Audio modes (Bass/Treble/Balance/Fader/SQ)

1 Push [SEL] (Select) to select the audio mode in sequence.

2 Turn [VOLUME] clockwise or counterclockwise to change each level or select a setting.

VOL 18 (Volume)

(Setting Range: 0 to 40, default: 18)

VOL 20

①: Up
②: Down

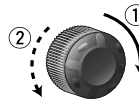

BASS (Bass)

(Setting Range: -12 dB to +12 dB by 2 dB, default: 0 dB)

BAS+ 6dB

①: Increased
②: Decreased

TREBLE (Treble)

(Setting Range: -12 dB to +12 dB by 2 dB, default: 0 dB)

TRE+ 6dB

①: Increased
②: Decreased

BALANCE (Balance)

(Setting Range: 15 levels each and 0 (center), default: CNT)

BAL L 15

①: Right enhanced
②: Left enhanced

FADER (Fader)

(Setting Range: 15 levels each and 0 (center), default: CNT)

FAD F 15

①: Front enhanced
②: Rear enhanced

SQ (SQ)

(Selectable setting: FLAT/ROCK/POP/VOCAL, default: FLAT)

SQ-FLAT

Turn to select
(Refer to the below)

Note: If no operation takes place for more than 5 seconds in audio mode (2 seconds in volume mode), the display returns to the regular mode.

About SQ

(Sound Quality)

SQ is a function that can call up various sound types in accordance with your listening music type.

SQ indicator



SQ-FLAT

(FLAT) flat frequency response: does not emphasize any part. (default)

SQ-ROCK

(ROCK) speedy and heavy sound: exaggerates bass and treble.

SQ-POP

(POP) wide-ranged and deep sound: slightly emphasizes bass and treble.

SQ-VOCAL

(VOCAL) clear sound: emphasizes middle tone and slightly emphasizes treble.

Radio

Band

Press **[BAND]** to change the band.

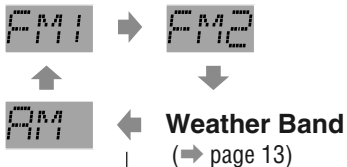

Caution
 To ensure safety, never attempt to preset stations while you are driving.

ST (FM stereo) indicator
 lights while receiving an FM stereo signal.

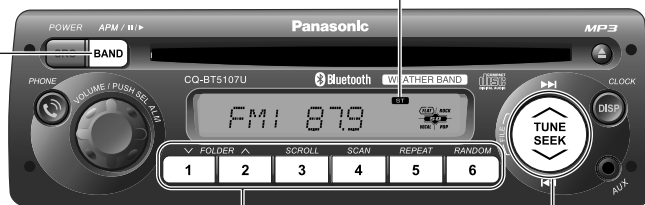

Preset station selection

Press the corresponding preset button **[1]** through **[6]** to tune in a preset station.

Frequency adjustment

[TUNE/SEEK ▲]: Higher
[TUNE/SEEK ▼]: Lower

Note: Hold down for 0.5 sec. or more and release for station search.

Auto preset memory (APM)

Press and hold **[APM]** (Auto Preset Memory) for more than 2 seconds.

- The 6 stations with good reception will be automatically saved in the memory under preset buttons **[1]** through **[6]**.
- Once set, the preset stations are sequentially scanned for 5 seconds each.
- Press one of the buttons **[1]** through **[6]** to stop sequentially scan.

Note: New stations overwrite existing saved stations.

Manual preset memory

- 1 Use manual or seek tuning to find a station.
- 2 Press and hold one of the preset buttons **[1]** through **[6]** until the display blinks once.

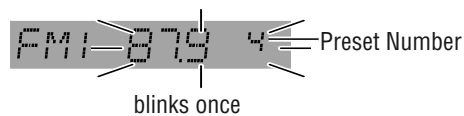

Note: New stations overwrite existing saved stations.

Tuning in a weather band station

- 1 Press **[BAND]** to select WB (Weather Band). (→ page 12)
 - 2 Press any of the buttons **[1]** through **[6]** to monitor the preset station.
- Note:** The weather band (CH1-6) has been preset. CH7 is selected by pressing **[TUNE^]** or **[TUNE∨]**.

Weather Band Stations

National Weather Radio Broadcasts from over 380 locations throughout the U.S. on seven VHF/FM frequencies.

Tune to weather band to receive continuous weather information 24 hours a day on one of the following frequencies.

1. 162.550 MHz
2. 162.400 MHz
3. 162.475 MHz
4. 162.425 MHz
5. 162.450 MHz
6. 162.500 MHz
7. 162.525 MHz

Note: Further and updated information about the National Weather Radio station listing, please visit the web site:
<http://www.nws.noaa.gov/nwr/nwrbro.htm>

Occasionally the frequency of an existing or planned station must be changed because of unexpected radio frequency interfere with adjacent NOAA weather Radio Stations and/or with other Government or commercial Operations within the area. If you have a question concerning NOAA Weather Radio, please contact your nearest National Weather Service Office.

Warning

Any NOAA broadcast weather report, including current and forecasts, may not reflect your actual weather conditions at your exact time and location. You should always pay attention to your actual weather conditions to make safe decisions accordingly.

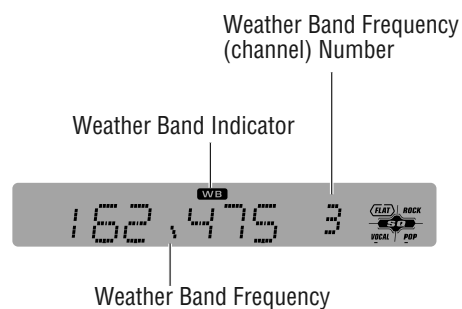

CD/MP3 Player

⚠ Cautions

- Do not insert a disc when the **DISC** indicator lights.
- This unit does not support 8 cm {3"} discs.
- Do not use irregularly shaped discs. (⇒ page 30)
- Do not use discs that have a seal or label attached.
- Do not insert foreign matter into the disc slots.
- This unit does not support WMA disc playback.
- Refer to the section on "Notes on CD-Rs/RWs" (⇒ page 30).
- Refer to the section on "Notes on MP3". (⇒ page 28)
- This unit does not support a MIX mode CD (a CD containing both CD-DA and compressed audio data). In case of using such a CD, problems may occur such as anacoustic playback.

Pause

Press [**II / ▶**] (Pause/Play)
Press again to cancel.

Disc loading/ejection

Loading

Load a disc in with the printed side facing up.

Notes:

- The power will be turned on automatically when a disc is loaded.
- Playback will start automatically after the player recognized the loaded disc as an ordinary music CD or MP3 disc.

Ejection

Press [**▲**] (Eject) to eject the disc.

**REP (Repeat)/
R▶ (Random)/
FOLDER** indicator

DISC (DISC) indicator

Display Change
(⇒ page 15)

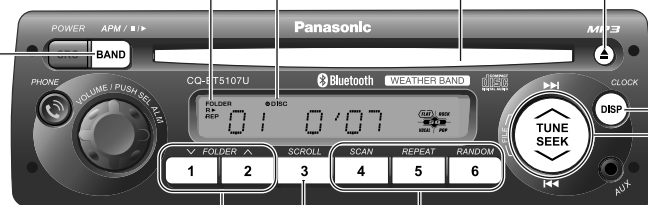

Text Scroll

Scan, Repeat, Random (⇒ page 15)

Folder selection (MP3)

[**FOLDER ▲**]: Next folder
[**FOLDER ▼**]: Preceding folder

Track/File selection

[**FILE ▶▶**]: Next track/file
[**FILE ◀◀**]: Back to the beginning of the current track/file.
Back to the previous track/file. (press twice)

Note: Hold down for fast forward/reverse. Release to resume the regular play.

Display change

Press **[DISP]** (Display) to change the display.

Notes:

- For scrolling text, press **[SCROLL]**.
- "NO TEXT" is displayed when there is no information on the disc.

CD-DA

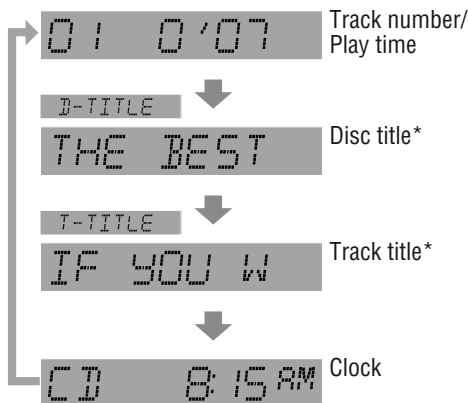

* CD TEXT Display

Disc title and Track title name are displayed.

MP3

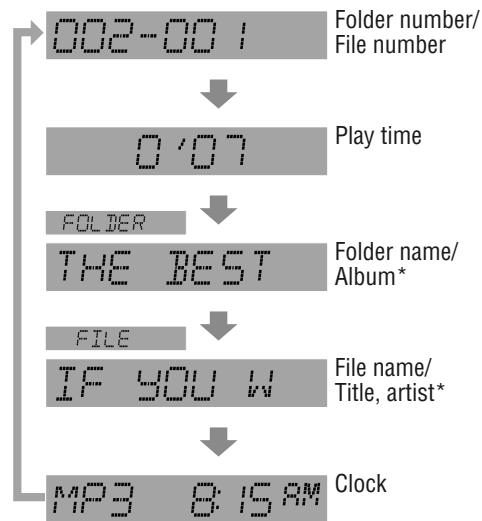

* ID3 Tag ON/OFF

Hold down **[SCROLL]** for more than 2 seconds.

TAG ON: album title and song title/artist name are displayed.

TAG OFF: folder name/file name are displayed. (Default)

Scan, repeat, random

Scan play

The first 10 seconds of each track/file is played in sequence.

Press **[SCAN]**. Track/file number blinks.

Press again to cancel.

Folder scan play (MP3)

From the next folder, the first 10 seconds of the first file in each folder is played in sequence.

Hold down **[SCAN]** for more than 2 seconds.

FOLDER lights and folder number blinks.

Hold down again to cancel.

Repeat play

The current track/file is repeated.

Press **[REPEAT]**. **REP** lights.

Press again to cancel.

Folder repeat play (MP3)

The current folder is repeated.

Hold down **[REPEAT]** for more than 2 seconds.

REP, **FOLDER** lights.

Hold down again to cancel.

Random play

All the available tracks/files are played in a random sequence.

Press **[RANDOM]**. **R▶** lights.

Press again to cancel.

Folder random play (MP3)

All the available files in current folder are played in a random sequence.

Hold down **[RANDOM]** for more than 2 seconds.

R▶, **FOLDER** lights.

Hold down again to cancel.

Bluetooth® - General

Bluetooth® indicator
lights when a Bluetooth® device is connected, and blinks during a call.

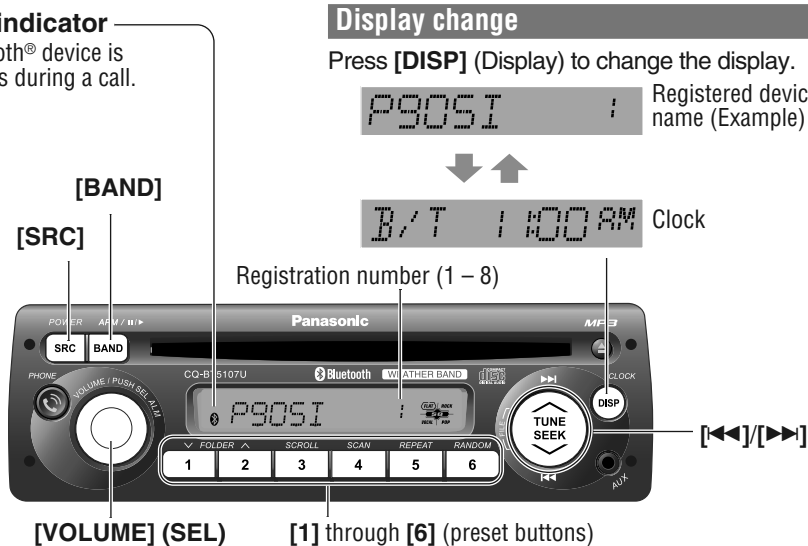

Registration of a Bluetooth® device with this unit

- 1 Press one of the preset buttons from [1] through [6] to select a registration number assigned to the Bluetooth® device to be registered.
Note: Up to 8 devices memory registered with preset buttons.
[1] – [5] : Selects a registration number (1st page: 1 – 5, 2nd page: 6 – 8)
[6] : Turns the registration pages
For registration No.6: press [6], then press [1].
For registration No.7: press [6], then press [2].
For registration No.8: press [6], then press [3].
- 2 Hold down the selected preset button for more than 2 seconds.
- 3 Push [SEL] (Select) button to make this unit standby for registration with waiting status.
Note: To exit waiting status, press [DISP] button.
- 4 Operate your Bluetooth® device to input the PIN code for connection. (Default PIN code is "0000")
Once pairing/registration is successful, the registered Bluetooth® device can automatically communicate with this unit.

Notes:

- The text display of Bluetooth device name and telephone directory on this unit is only supported with English characters, other languages and undisplayable characters/symbols will be converted into an asterisk (*).
- If registration is not successfully completed within 1 minute, "TIME OUT" appears and the screen for registration number selection resumes.
- If registration fails because of mismatched PIN code, "PAIR ERR" appears and the screen for registration number selection resumes.
- Depending on the communication status, it may takes 5 to 40 seconds for device connection.

Notes:

- We shall not guarantee all the functions of the Bluetooth® device to be connected. When operations cannot be performed via this unit, operate the system via the Bluetooth® device.
- Be aware that the battery of a Bluetooth® device drains faster if the Bluetooth® device is connected to this unit.
- Even when the Bluetooth® device that is connected to this unit is located near this unit, sound may be interrupted or noise may be generated.
- The Bluetooth® device with over 5-digit PIN code is not operated with this unit.
- "DISCONN." (DISCONNECT) is displayed when the Bluetooth® device is disconnected.

Setting of PIN (Personal Identity Number) code

- 1 Hold down [6] for more than 2 seconds to call the PIN code entry mode.

PIN 0000

- 2 Enter a number for each digit.
[◀]/[▶] : Selects number (0 – 9).
[6] : Selects next digit to be entered.

PIN 1234

- 3 Press [6] to determine the PIN code entry when last digit is entered.

PIN SET : Completed

Connection of the registered Bluetooth® device to this unit

- 1 Press the preset button(s) [1] through [6] to select the registration number of the Bluetooth® device of interest. (Refer to the above.)
- 2 Hold down [BAND] for more than 2 seconds for connection.

CONNECTE



P905I

The Bluetooth® indicator (Ⓜ) lights.

Notes:

- Even if [SRC] (Source) is pressed to change the source, the connection stays connected.
- Depending on the communication status, it may takes 5 to 40 seconds for device connection.

Disconnection of the Bluetooth® device

- 1 Hold down [BAND] for more than 2 seconds.

DISCONN

The Bluetooth® indicator (Ⓜ) turns off.

Note: When the Bluetooth® device is out of reception range or encounter serious interference by outer signal, "ERROR" appears and this unit will automatically disconnect the connections.

Deletion of the registered data

- 1 Press the preset button(s) [1] through [6] to select a registration number assigned to the Bluetooth® device whose data is to be deleted. (Refer to the above.)

P905I

- 2 Hold down the preset button [1] through [5] selected above for the registration number for more than 2 seconds.

NEW PAIR

- 3 Press the preset button that was pressed at the step above again.

DEL REG

- 4 Push [SEL].

DELETED

NO PAIR

Deletion completed

Bluetooth® - Hands-Free Phone

Phone answering

Press **[PHONE]** during a call incoming.
The Bluetooth® indicator (📶) blinks during a call incoming/making a call.

Notes:

- During a call incoming, the volume of this unit automatically switches to 18, it restores to the original volume setting when phone answering or call rejecting.
- If the automatic answering function is activated, conversation can be automatically started after receiving a call. (Refer to the below.)

Phone hanging up

Press **[PHONE]** during a call.

Switching between the private mode* and hands-free mode

Press **[BAND]** during a call.

The private mode and hands-free mode switch alternately every time **[BAND]** is pressed.

PRIVATE 1 (Private mode)



HANDSFRE 1 (Hands-free mode)

* The private mode is defined as the mode where conversation is conducted with the mobile phone in a usual manner without the hands-free function.

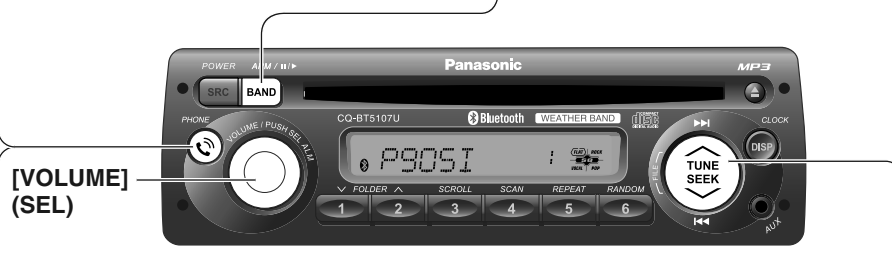

Incoming call rejection

Hold down **[PHONE]** for more than 2 seconds during a call incoming.

REJECTED 1

Outgoing call termination

Hold down **[PHONE]** for more than 2 seconds during making a call. (When other party does not answer the call.)

TERMINAT 1

Setting of automatic answering function

Hold down **[PHONE]** for more than 2 seconds at the standby state.

The automatic answering function toggles between ON and OFF every time **[PHONE]** is held down for more than 2 seconds.

ANS OFF 1

(Automatic answering deactivated)



ANS ON 1

(Automatic answering activated)

Use of voice dial

1 Hold down **[▶▶]** for more than 2 seconds at the standby state.

VOICE DI 1

2 Pronounce the name registered on the telephone directory.

If the name matches with a piece of data on the telephone directory registered with the mobile phone, the telephone number of the name is dialed.

Note: The Bluetooth® mobile phone itself must be equipped and support voice dial function.

Note: To have a mobile phone conversation with use of this unit, the mobile phone shall be compatible with the Hands-Free Profile.

Use of receiving/calling records or telephone directory (phonebook)

1 Press **[BAND]** at the standby state.

2 Push **[SEL]** (Select).

The display changes as follows:

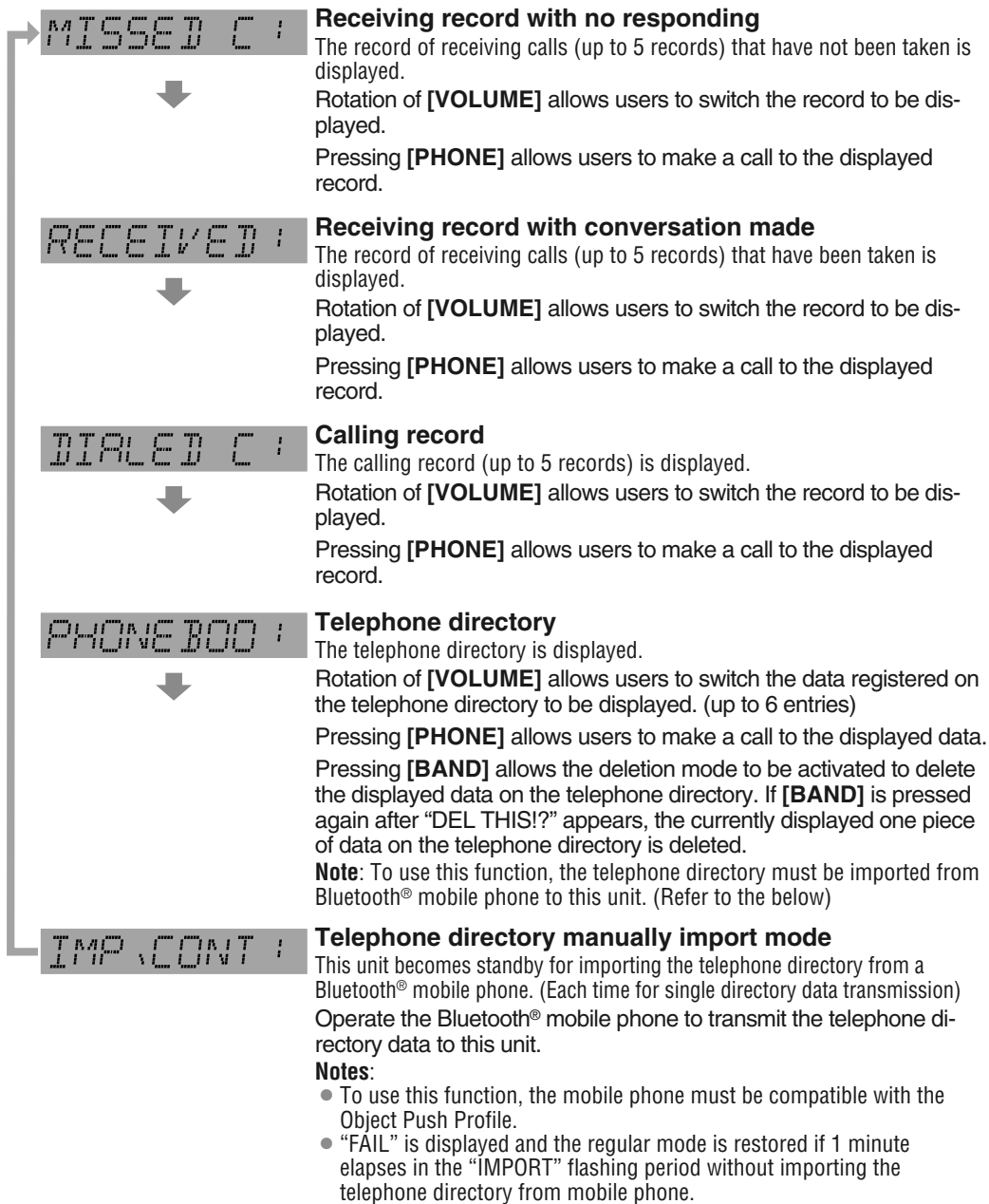

Bluetooth® - Music Player

Pause

Press [|| / ▶] (Pause/Play)

Press again to cancel.

Note: Some mobile phones automatically switch to energy saving mode or sleep mode when pause the music playback, and automatically disconnected the Bluetooth® connection ("DISCONN." is displayed on this unit).

But if you want to reconnect the Bluetooth® connection, performing playback on the mobile phone itself.

Note: The Bluetooth® audio devices that can be played with this unit must be compatible with A2DP (Advanced Audio Distribution Profile) or AVRCP (Audio/Video Remote Control Profile).



Music mode activation

Hold down [◀◀] for more than 2 seconds.

MUSIC (Music mode)

If [◀◀] is held down for more than 2 seconds again, the phone mode is activated.

PHONE (Phone mode)

Note: "INVALID" is displayed and the Phone mode is restored if 1 minute elapse in the Music mode without detecting A2DP compatible device.

Song selection

[FILE ▶▶]: Next file

Hold down for fast forward. Release to resume the regular play.

[FILE ◀◀]: Back to the beginning of the current file.

Back to the previous file. (press twice)

Notes:

- The control of pressing [FILE ▶▶]/[FILE ◀◀] in music mode depends on the key definitions of connected device.
- Depending on the specifications of the connected audio device, operations may not work.

Alarm Setting



Alarm time setting

- 1 Hold down **[ALM]** (Alarm) for more than 2 seconds.

ALM ADJ (Alarm time display)

“ALM ADJ” is displayed when the alarm time is not adjusted.

- 2 Hold down **[ALM]** for more than 2 seconds after the above display is shown.

ALM - 12:00 AM Hour blinks

- 3 Adjust the hour.

[▶▶] : Sets ahead.

[◀◀] : Sets back.

ALM - 8:00 AM Hour entered

- 4 Push **[ALM]**.

ALM 8:00 AM Minute blinks

- 5 Adjust the minute.

[▶▶] : Sets ahead.

[◀◀] : Sets back.

ALM 8:15 AM Minute entered

- 6 Push **[ALM]** to complete.

ALM 8:15 AM Completed

The alarm is set to ON automatically after complete alarm time setting.

Alarm indicator (🔊) lights.

Notes:

- When the clock (⇒ page 9) is not set, perform and complete the alarm time setting, the clock time will set to “PM 1:00” automatically. Please readjust the clock time depending on the actual clock time.
- Hold down **[▶▶]** or **[◀◀]** to change numbers rapidly.
- When you want to readjust the alarm time, repeat steps **1** to **6**.

Turning ON/OFF the alarm

- 1 Hold down **[ALM]** for more than 2 seconds.

ALM 12:00 AM (Alarm time display)

- 2 Push **[ALM]**.

ALM OFF (Alarm ON/OFF setting)

- 3 Turn **[ALM]** clockwise or counterclockwise to select alarm ON or OFF, then push **[ALM]** again to confirm the setting. (Select alarm ON, 🔊 lights.)

Notes:

- Before turn ON the alarm, make sure the alarm time is set. Failure to heed this will cause invalid selection of alarm ON.
- Hold down **[ALM]** for more than 2 seconds when the alarm is sounding also turns off the alarm.
- Access of alarm ON/OFF is available by push **[ALM]** in the “Alarm time display”.

Activating snooze

Press any button on this unit when the alarm is sounding.

SNOOZE

The alarm will sound again in 9 minutes.

Note: If you do not turn the alarm off when the alarm is sounding, the alarm sound will shut off after an hour. (including the amount of time the alarm was postponed (snooze))

Troubleshooting

If you suspect something wrong

Check and take steps as described below. If the described suggestions do not solve the problem, it is recommended to take the unit to your nearest authorized Panasonic Servicenter. The product should be serviced only by qualified personnel. Please refer the checking and the repair to professionals. Panasonic shall not be liable for any accidents arising out of neglect of checking the unit or your own repair after your checking.

Never take measures especially for those other than indicated by *italic* letters in "Possible Solution" described below because those are too dangerous for users to handle themselves.

Warning

- Do not use the unit in an irregular condition, for example, without sound, or with smoke or a foul smell, which can cause ignition or electric shock. Immediately stop using the unit and consult your nearest Servicenter.
- Never try to repair the unit by yourself because it is dangerous to do so.

Common

Problem	Possible cause → Possible solution
No power to the unit	The power cord (battery, power and ground) is connected in the wrong way. → Check the wiring.
Sound is not generated.	The sound volume level is zero (MUTE). → Turn [VOLUME] clockwise to increase the sound volume. The wiring of speaker lines are not correct, or a break or poor contact arises. → Check the wiring in accordance with the wiring diagram.
Noise	There is an electromagnetic-wave generator such as a mobile phone near the unit or its electrical lines. → Keep an electromagnetic-wave generator such as a mobile phone away from the unit and the wiring of the unit. In case that noise cannot be eliminated due to the wiring harness of the truck, consult your nearest Servicenter. The contact of the ground lead is poor. → Make sure that the ground lead is connected to an unpainted part of the chassis securely.
Noise is made in step with engine revolutions.	Alternator noise comes from the truck. → Change the wiring position of the ground lead. → Mount a noise filter on the power supply.
Some operations are not executable.	Some operations are not executable in particular modes such as menu mode. → Read the operating instructions carefully and cancel the mode. If the unit is still out of order, consult your nearest Servicenter.
No sound from speaker(s)	BALANCE/FADER setting is not appropriate. → Readjust BALANCE/FADER. There is a break, a short circuit, poor contact or wrong wiring regarding the speaker wiring. → Check the speaker wiring.



The speaker channels are reversed between right and left.	▶ The speaker wiring is confused between right and left. ➔ Perform the speaker wiring in accordance with the wiring diagram.
The sound field is not clear in the stereo mode. Central sound does not settled.	▶ The plus and minus terminals at right and left channels of speakers are connected reversely. ➔ Perform the speaker wiring in accordance with the wiring diagram.
The power fails unintentionally.	▶ The safety device works. ➔ Consult your nearest Servicenter.
Clock time is reset.	▶ Battery cable is not correctly connected. ➔ Connect the battery cable to the terminal that is always active.

Radio

Poor reception or noise	▶ Antenna installation or wiring of antenna cable is faulty. ➔ Check whether the antenna mounting position and its wiring are correct. In addition, check to see whether the antenna ground is securely connected to the chassis. ▶ No power is supplied to the antenna amplifier (when using a film antenna, etc.). ➔ Check the wiring of the antenna battery lead.
The number of auto preset stations is less than 6.	▶ The number of receivable stations is less than 6. ➔ Move to an area where receivable stations number is maximum, and try presetting.

CD

No playback or disc ejected	▶ The disc is inserted upside down. ➔ Insert a disc correctly. ▶ There is a flaw or foreign material on the disc. ➔ Remove the foreign material, or use a flawless disc.
Sound skipping or noise	▶ There is a flaw or foreign material on the disc. ➔ Remove the foreign material, or use a flawless disc.
Sound skipping due to vibration	▶ The unit is not sufficiently secured. ➔ Secure the unit to the console box. ▶ The unit is tilted at over 30° in the front-to-end direction. ➔ Make the angle 30° or less.
Disc unejectable	▶ Something such as a peeled label obstructs the disc coming out. ➔ Consult your nearest Servicenter. ▶ The microcontroller in the unit operates abnormally due to noise or other factors. ➔ Unplug the power cord and plug it again. In case the unit is still out of order, consult your nearest Servicenter.

Troubleshooting (continued)

MP3

<p>No playback or disc ejected</p>	<p>The disc has unplayable formatted data. ➔ Check the file format.</p>
<p>The CD-R/RWs that are playable on other devices are not playable on this unit.</p>	<p>The playability of some CD-Rs/RWs may depend on the combination of media, recording software and recorder to be used even if these CD-Rs/RWs are playable on other devices such as a PC. ➔ Make CD-R/RWs in different combination of media, recording software and recorder after referring to the description about the compressed audio player.</p>
<p>Sound skipping or noise</p>	<p>There is a flaw or foreign material on the disc. ➔ Remove the foreign material, or use a flawless disc.</p> <p>Playing VBR (Variable Bit Rate) files may cause sound skipping. ➔ Play Non-VBR files.</p>

Note: Refer to “Notes on MP3”. (➔ Page 28)

Bluetooth®

<p>Unable to register, connect, or call.</p>	<p>Devices incompatible with HFP (Hands-Free Profile) cannot be used. ➔ Use devices compatible with HFP (Hands-Free Profile).</p> <p>The mobile phone is not registered on this product. ➔ Connecting and calling with an unregistered mobile phone is not possible. Register the mobile phone on this product.</p> <p>The mobile phone is not connected. ➔ Calling is not possible if the mobile phone is not connected to this product. Connect the mobile phone to this product.</p> <p>The Bluetooth® device can not pair/register with this unit successfully. ➔ Check the device Bluetooth® setting is set to ON. ➔ Delete the paired memory within Bluetooth® device and main unit, then pair again. ➔ Switch OFF and ON with device Bluetooth® function, then pair again. ➔ Check the device PIN code, then input the correct PIN code for connection.</p> <p>This unit and Bluetooth® device are too far apart. ➔ Bring this unit and Bluetooth® device closer together and try to pair again.</p>
<p>The other party in the call complains of echoing or noise.</p>	<p>The voice of the other party heard from the car speakers is being picked up by the microphone and returned to the other party. ➔ Close the windows. ➔ Move the microphone away from the car speakers. ➔ Lower the volume.</p>
<p>Phone voice is of poor quality. Phone voice is inaudible.</p>	<p>Mobile phone reception is poor. ➔ Check mobile phone reception.</p>
<p>Bluetooth® audio does not work.</p>	<p>The Bluetooth® audio-compliant device does not support AVRCP (Audio/Video Remote Control Profile). ➔ Check the instruction manual of the Bluetooth® audio-compliant device for support conditions.</p>



Bluetooth® audio cannot be heard.	▶ The main unit is not in the Bluetooth® music mode. ➔ Check and switch to the Bluetooth® music mode.
Telephone voice dial does not work.	▶ The mobile phone does not support the voice dial function. ➔ Change to another mobile phone which supports the voice dial function. ▶ The distance between user and microphone is too far apart, the sound is low, or the surrounding is noisy. ➔ Speak toward the microphone closer and keep the surrounding quiet.
Sound skipping with Bluetooth® audio	▶ This unit and Bluetooth® device are too far apart. ➔ Bring the Bluetooth® device closer to this unit. ▶ There is another wireless device near this unit and interference occurs. ➔ Switch off the other wireless device and keep it away from this unit. ▶ Other wireless device is using the Bluetooth® profile excluding from main unit. (Ex. All phonebook transmission) ➔ Switch off the transmission with wireless device.
Unable to import the telephone directory.	▶ The mobile phone does not support Bluetooth® OPP (Object Push Profile) function. ➔ Change to another mobile phone which supports Bluetooth® OPP function. ▶ There is no telephone or name information within exported directory. ➔ Confirm the directory information is completely and correctly. ▶ The mobile phone is too far apart or communication interference occurs. ➔ Bring the mobile phone closer to this unit or switch off the other wireless device and keep it away from this unit.

Product servicing

If the suggestions in the charts do not solve the problem, we recommend that you take it to your nearest authorized Panasonic Servicenter. The product should be serviced only by a qualified technician.

Error Display Messages

CD/MP3

Display	Possible cause → Possible solution
CD -E1-	The disc is dirty, or is upside down. → Check the disc.
CD -E2-	The disc has scratches. → Check the disc.
CD -E3-	No operation by some cause. → Unplug the power cord and plug it again. In case the unit is still out of order, consult your nearest Servicenter.
CD -E4-	The player for some reason cannot read the file you are trying to play. (File recorded in an unsupported file system, compression scheme, data format, file name extension, damaged data, etc.) → Select a file that the player can read. Check the type of data recorded on the disc. Create a new disc if necessary.
NO DISC	No disc in the player. → Insert disc into the disc slot.

Bluetooth®

B/T ERR	The Bluetooth® module for some reason cannot function. → Unplug the power cord and plug it again. In case the unit is still out of order, consult your nearest Servicenter.
COMM \ERR	Bluetooth® communication error (Module and System) → Switch the power or ACC ON/OFF. In case the unit is still out of order, consult your nearest Servicenter.

Maintenance

Cleaning this unit

Your product is designed and manufactured to ensure a minimum of maintenance. Use a dry soft cloth for routine exterior cleaning. Never use benzene, thinner or other solvents.

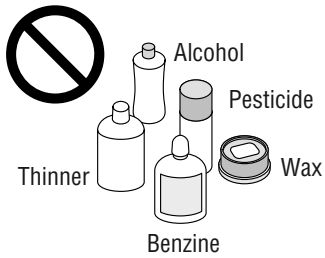

To remove stubborn stains

- ① Moisten the soft cloth in dishwashing soap diluted with water and wring well.
- ② Wipe lightly. Go over the same surface with a dry cloth.



Notes:

- Since there is the possibility of water drops getting inside of the unit, do not directly apply cleanser to the surface.
- Do not scratch the screen with your nails or other hard objects. The resulting scratches or marks will obscure the images.

⚠ Caution

- If water drops or similar wet substances get inside the unit, it may cause a malfunction.

Fuse

If the replaced fuse fails, contact your nearest authorized Panasonic Servicenter.

⚠ Warning

Use fuses of the same specified rating (**15 A**). Using substitutes or fuses with higher ratings, or connecting the unit directly without a fuse could cause fire or damage to the unit. **If the replaced fuse fails, contact your nearest authorized Panasonic Servicenter.**

Notes on MP3

MP3 (MPEG Audio Layer-3) is a format for compressed audio file. These formats allow users to save all the files contained in approximately 10 pieces of existing CDs on one piece of CD-R/RW.

Note: Each of encoding software is not included with this unit.

*MPEG Layer-3 audio coding technology licensed from Fraunhofer IIS and Thomson.

Cautions as to compressed audio files

- High bit rate and high sampling frequency are recommended for high quality sounds.
- Selecting VBR (Variable Bit Rate) is not recommended because playing time is not displayed properly and sound may be skipped.
- The playback sound quality differs depending on the encoding circumstances. For details, refer to the user manual of your own encoding software and writing software.
- Be sure to put an extension compatible with the format.
- It is recommended to set the bit rate to “128 kbps or more” and “fixed”.

Compression formats

Compression method	Bit rate	VBR	Sampling frequency
MPEG 1 audio layer 3 (MP3)	32 k – 320 kbps	Yes	32, 44.1, 48 kHz
MPEG 2 audio layer 3 (MP3)	8 k – 160 kbps	Yes	16, 22.05, 24 kHz
MPEG 2.5 audio layer 3 (MP3)	8 k – 160 kbps	Yes	8, 11.025, 12 kHz

Caution

Never put an extension indicating compressed audio (such as “.mp3”) to files other than compressed audio files. This may not only produce noise from the speaker damage, but also damage your hearing.

Cautions as to the display of this unit

Display Information

- **CD-TEXT**
Disc title
Track title
- **MP3**
Folder name,
File name
- **MP3 (ID3 tag)**
Album name,
Title name/artist
name

Displayable characters

- Displayable length of file name/folder name: within 30 characters. (Unicoded file and folder names are reduced by half in the number of displayable characters.)
- Name files and folders in accordance with the standard of each file system. Refer to the instructions of writing software for details.
- ASCII character set and special characters in each language can be displayed.

ASCII character set

A to Z, a to z, digits 0 to 9, and the following symbols:
(space) ! " # \$ % & ' () * + , - . / : ; < = > ? @ [\]
^ _ ` { | } ~

Notes:

- Characters may be garbled depending on encoding software to be used
- Undisplayable characters and symbols will be converted into an asterisk (*).

Recording MP3 files on a CD-Media

Compressed audio file writing

- Do not save an audio file (CD-DA file) and a compressed audio file on the same disc. Failure to observe this may result in difficulty in playing.
- If compressed audio files formatted with two or more types are saved on the same disc, each format shall have a different folder.
- Do not write files other than compressed audio files.
- Playability may depend on the combination of writing software and disc writer to be used.
- This unit does not support the play list function.
- Write files in a disc-at-once manner unless otherwise needed.
- You can shorten the duration between data read and playback by decreasing the quantity of files or folders, or the depth of the hierarchy.

Supported file systems

ISO 9660 Level 1/Level 2, Apple Extension to ISO 9660, Joliet, Romeo

Note: Apple HFS, UDF 1.50, Mix CD and CD Extra are not supported.

Folder selection order/file playback order

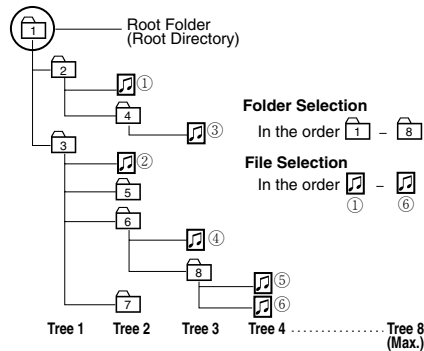

Maximum number of files/folders

- Maximum number of files: 999
- Maximum number of files in one folder: 255
- Maximum depth of trees: 8
- Maximum number of folders: 256 (Root folder is included.)

Notes:

- This unit counts the number of folders irrespective of the presence or absence of a compressed audio file.
- If the selected folder does not contain any compressed audio file, the nearest compressed audio file in the order of playback will play.
- Playback order of this unit may be different from that of other compressed audio players even if the same disc is used
- "ROOT" appears when displaying the root folder name.

Common

Copyright

It is prohibited by copyright laws to copy, distribute and deliver copyrighted materials such as music without the approval of copyright holder except enjoying yourself personally.

No warranty

Above description complies with our investigations as of September 2010. It has no warranty for reproducibility and displayability of MP3.

Notes on Discs

How to hold the disc

- Do not touch the underside of the disc.
- Do not scratch the disc.
- Do not bend disc.
- When not in use, keep disc in the case.

Printed side



Unusable discs

Do not use discs that fit any of the descriptions given below. Using these discs may damage the discs or cause the unit to malfunction.

- Special discs in a shape which is not round



- Partly or wholly transparent disc

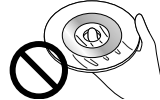

Wholly transparent disc* Partly transparent disc

*Wholly semi-transparent disc may not be played back.

- Discs with adhered labels, etc. on them



Disc with adhered stickers or tape

Labels created by a printer



Protective films or sheets

Disc accessories (stabilizers, etc.)

- Damaged or deformed discs

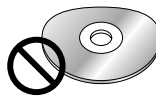

Shoddily made discs

Discs with cracks, scratches or parts missing



Discs with burrs
Please remove the burrs before use.

Disc insert

The surfaces of new discs tend to be slippery. Therefore, when using such a disc for the first time, it may not load satisfactorily even when it has been inserted into the unit. At a time like this, insert the disc into the unit as far as it will go until it is loaded properly.

- When inserting a disc into or ejecting and removing it from the unit, insert it straight in or eject and remove it straight out in parallel with the unit. Otherwise, the disc may be scratched or marked in the process.
- When inserting a disc, do not put one disc on another. Failure to observe this may cause the discs to be jammed.

Do not leave discs in the following places:

- Direct sunlight
- Near truck heaters
- Dirty, dusty and damp areas
- On seats and dashboards

Disc cleaning

Use a dry, soft cloth to wipe from the center outward.

Do not attach any seals or labels to your discs. Do not write on the disc label in a heavy pen or ballpoint pen.



<Correct>

<Wrong>

Notes on CD-Rs/RWs

- You may have trouble playing back some CD-R/RW discs recorded on CD recorders (CD-R/RW drives), either due to their recording characteristics or dirt, fingerprints, scratches, etc. on the disc surface.
- CD-R/RW discs are less resistant to high temperatures and high humidity than ordinary music CDs. Leaving them inside a truck for extended periods may damage and make playback impossible.
- The unit may not successfully playback a CD-R/RW that was made by the combination of writing software, a CD recorder (CD-R/RW drives) and a disc if they are incompatible with one another.
- This player does not play CD-R/RW discs if the session is not closed.
- Be sure to observe the handling instructions of CD-R/RW discs.
- This player does not play CD-R/RW discs which contain other than CD-DA or MP3 data.

Notes on Bluetooth®

Frequency band used

This product uses the 2.4 GHz frequency band, but other wireless devices may also use the same frequency. Note the following to prevent radio waves interfering with other wireless devices. Microwave ovens and other industrial, scientific, and medical equipment, in-plant radio stations used for mobile object identification on, for example, the production lines of factories, specified low power radio stations that do not require a license, amateur radio stations, and the like (hereafter abbreviated as "other radio stations") operate in the same frequency band as this product.

Usage limitations

- This product is not guaranteed to be able to perform wireless communication with all Bluetooth® compatible devices.
- Bluetooth® compatible devices for wireless communication comply with the standard defined by Bluetooth® SIG, Inc., and need to receive certification. However, even if a Bluetooth® compatible device complies with the standard, a connection may not be possible, or the operating procedure, display, or operation may differ because of the specifications or settings of the device.
- This product includes support for security functions compliant with the Bluetooth® standard, but security may sometimes be insufficient depending on the operating environment and settings.
Be careful during wireless communication.
- Panasonic assumes no responsibility whatsoever for data generated or information leaked during wireless communication.

Influence from other devices

- If this product is used near another Bluetooth® compatible device or a device that uses the 2.4 GHz frequency band, problems such as the device not working properly and noise generation are likely to occur because of radio wave interference.
- This product may not work properly if there is a broadcasting station or the like nearby, and the surrounding signal is too strong.

Application limitations

- To use this product for listening to music or for a Hands-Free call, the Bluetooth® compatible device needs to support the following Bluetooth® version.
Bluetooth® Standard Ver. 2.1
- To use this product for calling with a mobile phone, the mobile phone needs to support the Hands-Free Profile.
- To transfer the contacts of a mobile phone to this product, the mobile phone needs to support the Object Push Profile.

- A connection may not be possible, or the operating procedure, display, or operation may differ because of the specifications or settings of the Bluetooth® compatible device.
- Even if this product and Bluetooth® compatible device are close to each other, sound may be intermittent or affected by noise because of the state of the signal.

Bluetooth®

The Bluetooth word mark and logo are owned by the Bluetooth SIG, Inc. and any use of such marks by Panasonic Corporation is under license. Other trademarks and trade name are those of their respective owners.

NOTICE

This equipment has been tested and found to comply with the limits for a Class B digital device, pursuant to part 15 of the FCC Rules. These limits are designed to provide reasonable protection against harmful interference in a residential installation. This equipment generates, uses and can radiate radio frequency energy and, if not installed and used in accordance with the instructions, may cause harmful interference to radio communications. However, there is no guarantee that interference will not occur in a particular installation. If this equipment does cause harmful interference to radio or television reception, which can be determined by turning the equipment off and on, the user is encouraged to try to correct the interference by one or more of the following measures:

- Reorient or relocate the receiving antenna
- Increase the separation between the equipment and receiver.
- Connect the equipment into an outlet on a circuit different from that to which the receiver is connected.
- Consult the dealer or an experienced radio/ TV technician for help.

Installation Guide



WARNING

❑ This installation information is designed for professional installers with knowledge of automobile electrical safety systems and is not intended for non-technical, do-it-yourself individuals. It does not contain instructions on the electrical installation and avoidance of potential harm to air bag, anti-theft and ABS braking or other systems necessary to install this product.

Any attempt to install this product in a motor vehicle by anyone other than a professional installer could cause damage to the electrical safety system and could result in serious personal injury or death.

❑ If your car is equipped with air bag and/or anti-theft systems, specific procedures may be required for connection and disconnection of the battery to install this product.

Before attempting installation of this electronic component against the manufacturer's recommendation, you must contact your car dealer or manufacturer to determine the required procedure and strictly follow their instructions.

FAILURE TO FOLLOW THE PROCEDURE MAY RESULT IN THE UNINTENDED DEPLOYMENT OF AIR BAGS OR ACTIVATION OF THE ANTI-THEFT SYSTEM RESULTING IN DAMAGE TO THE VEHICLE AND PERSONAL INJURY OR DEATH.

Overview

This product should be installed by a professional. However, should you decide to install the product against the manufacturer's recommendation, these operating Instructions do not contain electrical installation instructions. You must contact your car dealer or manufacturer for electrical connection instructions to avoid possible damage to your electrical safety systems and resulting injury or death. **(Please refer to the "WARNING" statement above).**

Your next step is to decide where to install the unit. The instructions in these pages will guide you through the remaining steps:

- Identify and label the car wires.
- Connect the vehicle wires to the wires of the power connector.
- Install the unit in the dashboard.
- Check the operation of the unit.

If you encounter problems, please consult your nearest professional installer.

Before you begin installation, look for the following items which are packed with your unit.

- **Operating Instructions** (including "Limited Warranty" and "Customer Services Directory").
- **Installation hardware**Needed for Installation.

Dashboard specifications

Thickness Min. 4.75 mm $\{3/16''\}$
Max. 5.56 mm $\{2/32''\}$

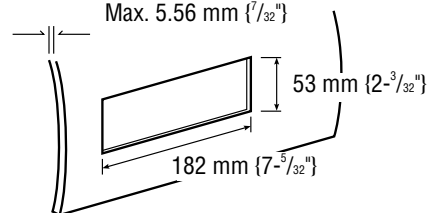

Warning

- This unit operates with a 12 V DC negative \ominus ground auto battery system only. Do not attempt to use it with any other system. Doing so could cause serious damage.

Preparation

⚠ Warning

If your vehicle is equipped with air bag and/or anti-theft systems, specific procedures may be required for connection and disconnection of the battery to install this product.

Before attempting installation of this electronic component, contact your vehicle dealer or manufacturer to determine the required procedure and strictly follow their instructions.

FAILURE TO FOLLOW THE PROCEDURE MAY RESULT IN THE UNINTENDED DEPLOYMENT OF AIR BAGS OR ACTIVATION OF THE ANTI-THEFT SYSTEM RESULTING IN DAMAGE TO THE VEHICLE AND PERSONAL INJURY OR DEATH.

- Disconnect the cable from the negative ⊖ battery terminal (see caution below).
- Remove Mounting Collar ① from the main unit temporarily, which are already mounted at shipment.*

⚠ Caution

Various settings that have been stored in the memory in other on-board equipment (vehicle navigation etc.) may be lost if the battery terminals are disconnected. Therefore, we recommend to make a record of or to back up the settings before disconnecting the terminals.

After completing installation of the main unit, set the equipment again according to the record.

- Unit should be installed in a horizontal position with the front end up at a convenient angle, but not more than 30°.

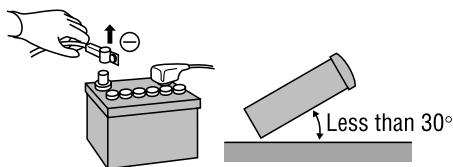

Dashboard installation

Installation Opening

This unit can be installed in any dashboard having an opening as shown below. The dashboard should be 4.75 mm {3/16"} – 5.56 mm {7/32"} thick in order to be able to support the unit.

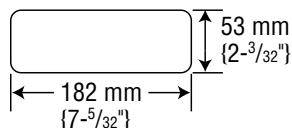

Installation hardware

No.	Item	Diagram	Q'ty
①	Mounting Collar*		1
②	Plain Washer (5 mm ø)		2
③	Spring Washer (5 mm ø)		2
④	Hex. Nut (5 mm ø)		2
⑤	Rear Support Strap		1
⑥	Hex. Bolt (5 mm ø × 25 mm)		1
⑦	Toothed Lock Washer (5 mm ø)		1
⑧	Removal Tool (U-shaped)		2
⑨	Microphone with Bracket		1
⑩	Adhesive Sponge		1

(a) Using the rear support strap ⑤

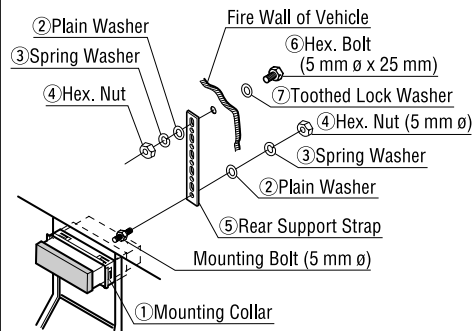

(b) Using the rubber cushion (option)

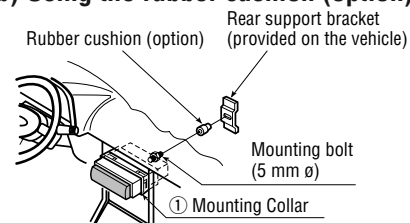

Installation Guide (continued)

Securing of the main unit

Caution

- We strongly recommend that you wear gloves for installation work to protect yourself from injuries.
- When bending the mounting tab of the mounting collar with a screwdriver, be careful not to injure your hands and fingers.

First complete the electrical connections, and then check them for correctness. (→ page 36)

The included Mounting Collar ① is designed specially for this unit. Do not use it to attach any other model.

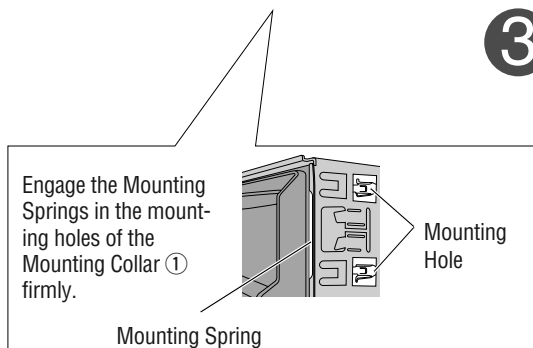
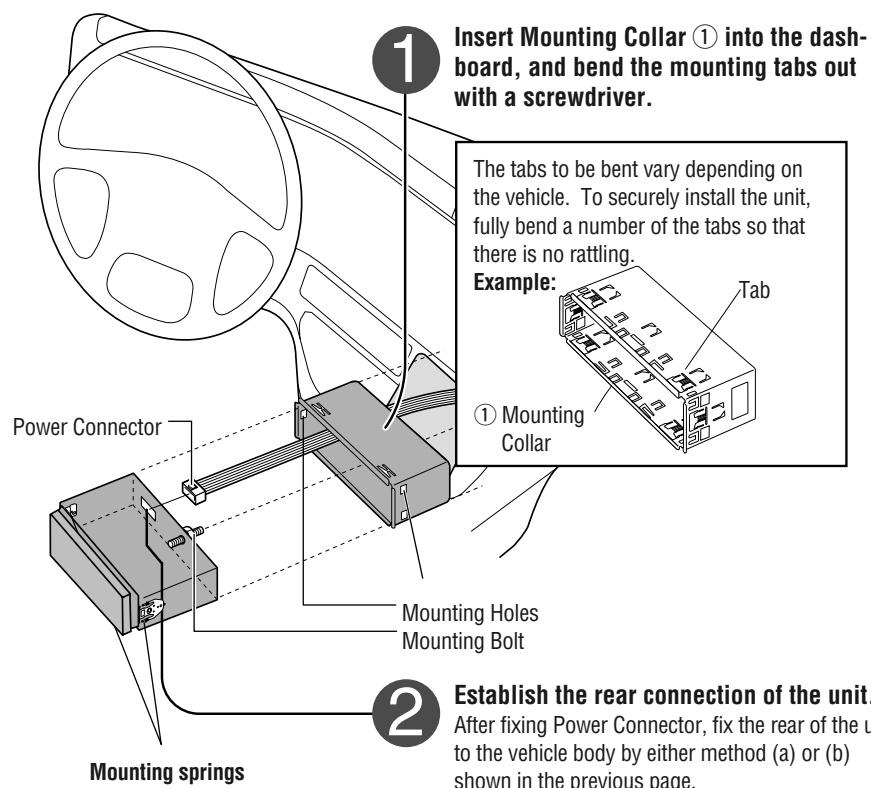

3 After installation reconnect the negative (-) battery terminal.

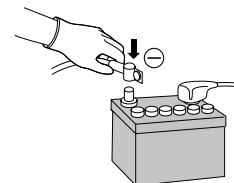

Removing the unit from the vehicle's dashboard

Insert each Removal Tool ⑧ and pull.

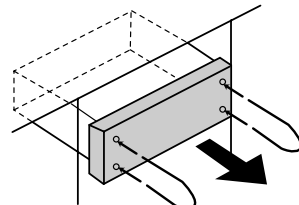

⑧ Removal Tool
(U-shaped)

Note: Do not lose Removal Tools. They will be needed to remove the unit from the vehicle's dashboard.

Securing of the Microphone with Bracket

- 1 Attach the Microphone with Bracket ⑨ by clipping it on the sun visor etc.
- 2 Secure the cable with a cable clamp (option).

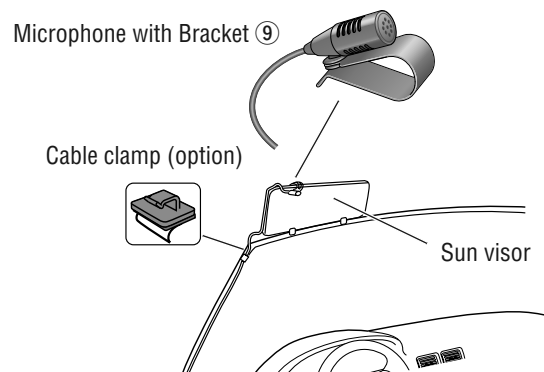

Notes:

- Install the Microphone at least 20 cm away from the mobile phone to prevent noise generation.
- To ensure the quality on making calls, speak toward the Microphone unit.
- To prevent unintended pull out of microphone cord, make sure to wind the supplied Adhesive Sponge ⑩ around the connecting portion with microphone connector for reinforcement.

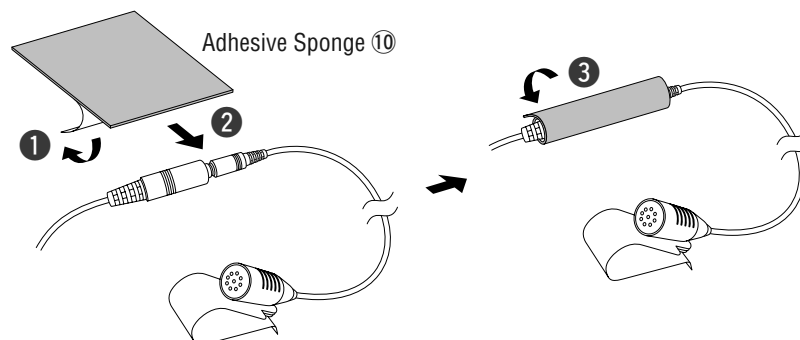

Electrical Connections

⚠ Caution

- This wiring information is for experienced technical individual, for safety reason, please your dealer wire this connection.
- This product is designed to operate with a 12 V DC, negative ⊖ ground battery system.
- To prevent damage to the unit, be sure to follow the connection diagram below.
- Do not insert the power connector into the unit until the wiring is completed.
- Be sure to insulate any exposed wires from a possible short-circuit from the vehicle chassis. Bundle all cables and keep cable terminals free from touching any metal parts.
- Remember, if your vehicle has a drive computer or a navigation computer, the data of its memory maybe erased when the battery terminals are disconnected.

Wiring diagram

Microphone Input Connector

(Connect to supplied Microphone with Bracket ⑨)

Note: Make sure to wind the attached Adhesive Sponge ⑩ around the connecting portion for reinforcement. (⇒ page 35)

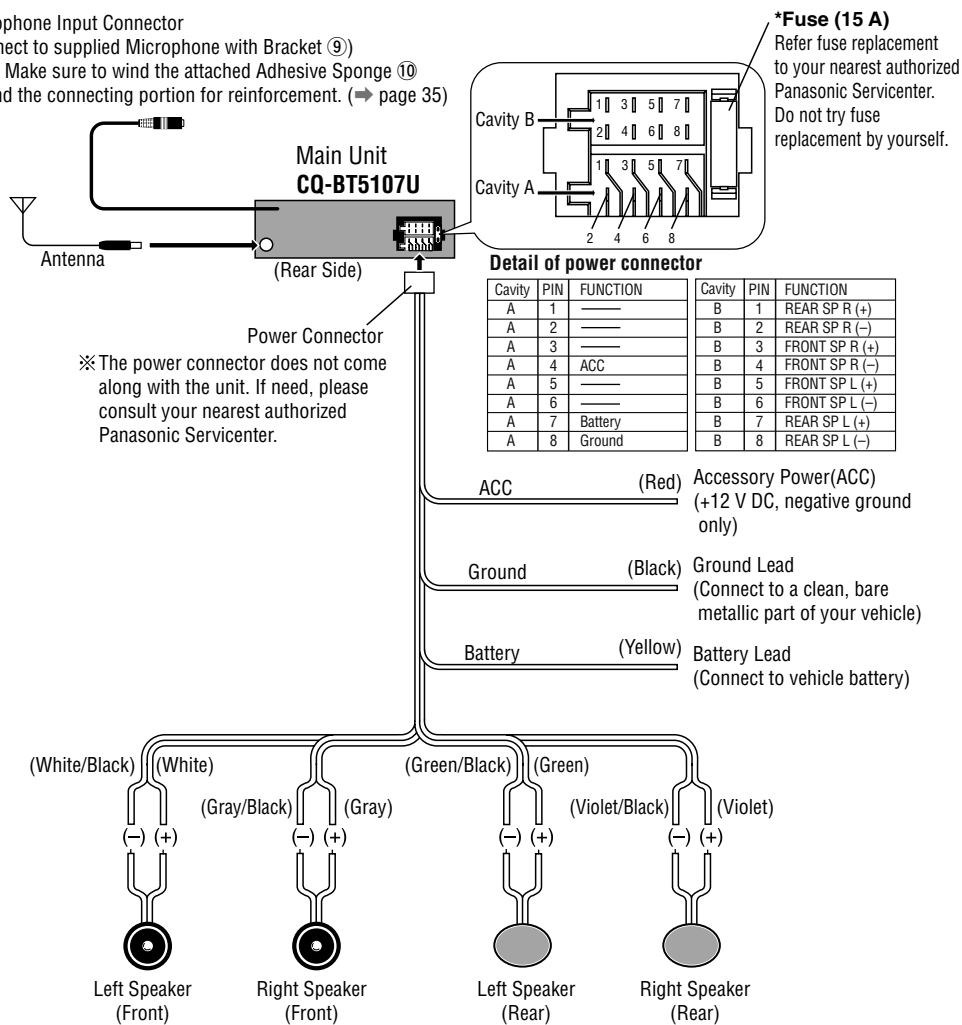

Speaker Connections

Caution

Please follow the instructions given below. Failure to do so will cause damage to the unit and speakers.

<Right>

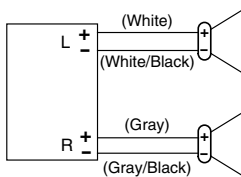

- Use ungrounded speaker only.
- The maximum speaker input should be 45 W or more. (If used with the optional power amplifier, the speaker input should be higher than the maximum amplifier output.)
- The speaker impedance should be 4 - 8 Ω .
- This unit uses the BTCL circuit, so each speaker should be connected separately using parallel vinyl insulated cords.
- The speaker cords and the power amplifier unit should be kept away (about 30 cm apart) from the antenna and antenna extension cord.

<Wrong>

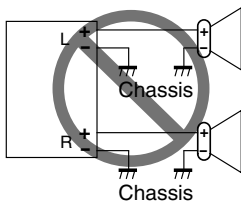

- Never connect the speaker cord to the body of the car.

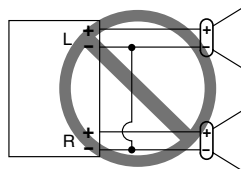

- Do not use a 3-wire type speaker system having a common earth lead.

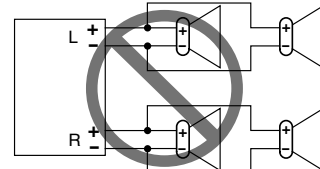

- Do not connect more than one speaker to one set of speaker leads.

Specifications

General

Power Supply:	12 V DC (11 V – 16 V), test Voltage 14.4 V, Negative ⊖ ground
Current consumption:	Less than 2.5 A (CD mode, 0.5 W 4-speaker)
Maximum Power Output:	45 W × 4 channels at 400 Hz, Volume Control maximum
Tone adjustment range:	
Bass:	± 12 dB at 100 Hz
Treble:	± 12 dB at 10 kHz
Power Output:	18 W per channel into 4 Ω, 40 to 30 000 Hz at 3 % THD
Suitable Speaker	
Impedance:	4 – 8 Ω
Dimensions (W x H x D):	178(W) x 50(H) x 160(D) mm {7" x 1-15/16" x 6-5/16"}
Weight:	1.4 kg {3 lbs. 1 oz.}

Front AUX Input

Input impedance:	10 kΩ
Maximum input level:	2.0 V
Connector:	3.5 mm ø stereo mini pin
Input sensitivity:	200 mVrms

FM Stereo Radio

Frequency Range:	87.9 – 107.9 MHz
Usable Sensitivity:	12 dBf (1.1 μV/ 75 Ω, S/N 30 dB)
50 dB Quieting Sensitivity:	17 dBf (1.8 μV/ 75 Ω)
Frequency Response:	30 – 15 000 Hz ± 3 dB
Alternate Channel Selectivity:	75 dB
Stereo Separation:	35 dB at 1 kHz
Signal/Noise Ratio:	70 dB (Mono)

AM Radio

Frequency range:	530 kHz – 1 710 kHz
Usable sensitivity:	28 dB/μV (25 μV, S/N 20 dB)

Weather Band Radio

Frequency range:	162.400 – 162.550 MHz
Usable sensitivity:	3 dB/μV (S/N 20 dB)
Signal/Noise Ratio (40 dB/μV):	50 dB

CD Player

Sampling Frequency:	8 times oversampling
DA Converter:	1 bit DAC System
Pick-Up Type:	Astigma 3-beam
Light Source:	Semiconductor laser
Wavelength:	790 nm
Frequency Response:	20 – 20 000 Hz (±1 dB)
Signal to Noise Ratio:	96 dB
Wow and Flutter:	Below measurable limits
Channel Separation:	75 dB

Bluetooth®

Communication Frequency:	2 402 MHz – 2 480 MHz
Number of Channels:	79 Channels
Communication Mode:	Frequency Hopped Spread Spectrum Communication
RF Output:	0 dBm (0.8 mW)
Service Area:	Within 10 m
Applicable Bluetooth® Version:	Version 2.1 + EDR

Above specifications comply with EIA standards.

Note: Specifications and the design are subject to modification without notice due to improvements in technology.

Power Output:
16 W RMS x 4 Channels at 4 Ω and ≤ 1% THD+N
Signal to Noise Ratio:
85 dBA (reference: 1 W into 4 Ω)



**Panasonic Automotive
Systems Company of America,
Division of Panasonic
Corporation of North America**
776 Highway 74 South, Peachtree
City, GA 30269

© Panasonic Corporation 2010

YFM264C224ZA PTW0910-0 Printed in Taiwan