

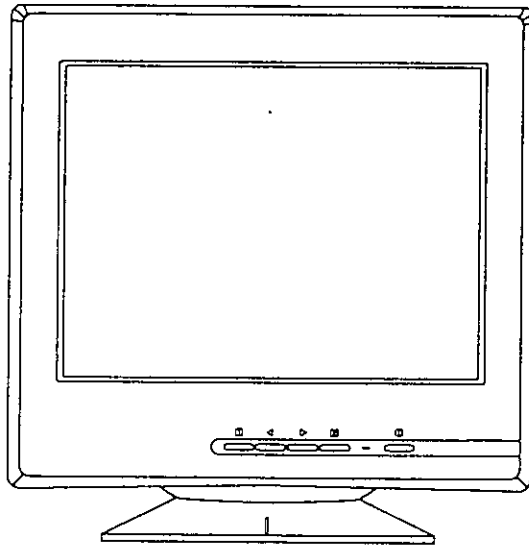

**Operating Instructions**  
**Mode d'emploi**  
**Bedienungsanleitung**  
**Instruzioni d'uso**  
**Manual de Instrucciones**

Multi-Scan Color Monitor

MODEL TX-D7S54NM



Please read these instructions thoroughly before operating the display monitor.

English

Chapter I

ENGLISH

Français

Chapitre II

FRANÇAIS

Deutsch

Kapitel III

DEUTSCH

Italiano

Capitolo IV

ITALIANO

Español

Capítulo V

ESPAÑOL

**ENGLISH**

**Precautions:**

● **AC PLUG CORD ( FOR U.K. )**

FOR YOUR SAFETY PLEASE READ THE FOLLOWING TEXT CAREFULLY.

IF THE FITTED MOULDED PLUG IS UNSUITABLE FOR THE SOCKET OUTLET THEN THE PLUG SHOULD BE CUT OFF AND DISPOSED OF SAFELY.

THERE IS A DANGER OF SEVERE ELECTRICAL SHOCK IF THE CUT OFF PLUG IS INSERTED INTO AN APPROPRIATE SOCKET.

If a new plug is to be fitted, please observe the wiring code as shown below. If in any doubt, please consult a qualified electrician.

**WARNING: THIS APPLIANCE MUST BE EARTHED.**

**IMPORTANT:** The wires in this mains lead are coloured in accordance with the following code:

- Green-and-Yellow:.....Earth
- Blue: .....Neutral
- Brown: .....Live

If the coloured wires of the mains lead of this appliance do not correspond with the coloured markings identifying the terminals in your plug, proceed as follows:

The wire which is coloured GREEN-AND-YELLOW must be connected to the terminal in the plug which is marked by the letter E or by the Earth symbol  $\perp$  or coloured GREEN or GREEN-AND-YELLOW.

The wire which is coloured BLUE must be connected to the terminal in the plug which is marked with the letter N or coloured BLACK.

The wire which is coloured BROWN must be connected to the terminal in the plug which is marked with the letter L or coloured RED.

## CE Conformity



This device complies with the requirements of the EEC directive 89/336/EEC as amended by 92/31/EEC and 93/68/EEC Art.5 with regard to " Electromagnetic compatibility ", and 73/23/EEC as amended by 93/68/EEC Art. 13 with regard to " Safety ".

Required item	Relative to Standard Value	Relative to those Exceeding Standard Value	Remarks
EM I	#1		#4
ESD	#2	#3	X
RADIATED RF	#1	#3	
TRANSIENT F/B	#1	#3	
LINE HARMONICS	#1		

- #1 : Satisfies standards with no problems in performance and reliability.
  - #2 : Effects may appear temporarily on the screen but there will be no problem in reliability.
  - #3 : There is fear of the product breaking down.
  - #4 : If a signal cable other than that specified is used, it may be the cause of electromagnetic wave interruption of peripheral devices.
- To assure continued CE compliance the user must use the provided 1.5 m shielded video signal cable with bonded ferrite cores at both ends of the cable.

Handle correctly in accordance with the instruction manual.  
 EMI : Electromagnetic Interference      ESD : Electrostatic Discharge  
 RF : Radio Frequency                      F/B : Fast Burst

As an ENERGY STAR® partner, Display Monitor Division, AVC Company, Matsushita Electric Industrial Co., Ltd. has determined that this product meets the ENERGY STAR® guidelines for energy efficiency.

## Features

- 1) Digital adjustment using the on-screen display
  - The on-screen menu is available in 5 languages.  
One of English, French, German, Italian or Spanish can be selected.
  - Adjustments can be performed easily with the 4 control buttons and on-screen menu.
  - Set the on-screen menus at any preferred location on the display screen (six locations).
- 2) Environment-friendly
  - The display power consumption can be suppressed by using this unit in combination with a computer that conforms to the VESA DPMS (Video Electronics Standards Association Display Power Management Signaling) standards.
  - This product conforms to the ENERGY STAR® program.
  - It conforms to Sweden's MPR II standards (low-frequency electro-magnetic field standards) and TCO'92 standards.
- 3) VESA DDC 1/2B is used.
  - By using this unit in combination with a computer that conforms to the VESA (Video Electronic Standards Association) DDC (Display Data Channel) standard, the display monitor can be used in the optimum condition.
- 4) Monitor stand removal.
  - The monitor stand can be removed and the monitor can be installed upon a desktop computer.
- 5) High quality CRT is used
  - The screen is 17-inch (16.0 inches viewable with 0.25 mm dot pitch), Advanced AGRAS (Anti-Glare, anti-Reflection and Anti-Static) Coat, and dark face, providing low reflection, static electricity prevention, high resolution and high contrast.
- 6) Digital multiscan
  - Automatic following is done with horizontal frequency of 30 kHz to 95 kHz and vertical frequency of 50 Hz to 180 Hz; capable of matching VGA, SVGA, VESA and Macintosh 13", 16", 19", 21" modes and 1600 (H) × 1200 (V) / (fv=75 Hz) high resolution.

## Dimensions

**When adjusting the angle, hold the bottom corners of the display with both hands and turn it slowly. (See figure at down) Do not press on the upper part of the display.**

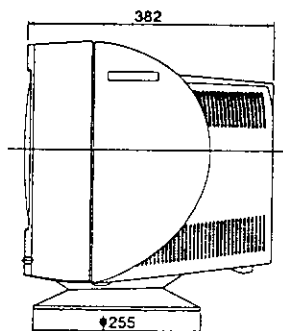
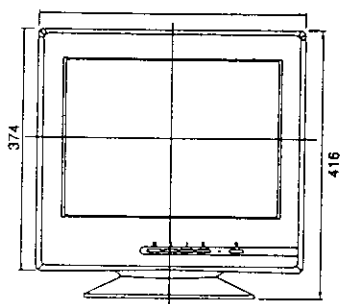

Dimension unit : mm

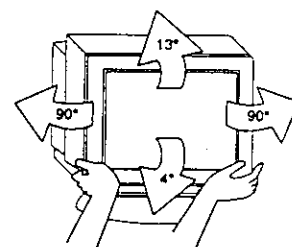

Width : 410mm, Height : 416mm, Depth : 382mm  
Tilt angle : Up 13°, Down 4°  
Swivel angle : 90°each Left and Right

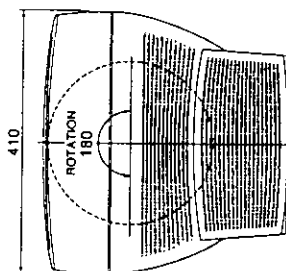
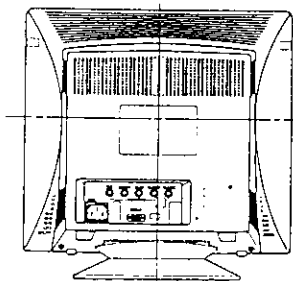

**The color of the screen may become distorted due to magnetic influence when the display angle is adjusted while power supply is turned on. Perform the demagnetization operation if this condition occurs. See page 1 - 10.**

# Connections

**Always turn off the power supply of the computer and the monitor before performing the connection procedures.**

## 1. Signal Cable Connection

Connection method will differ in accordance with the computer in use. Connect one end of the supplied signal cable to the mini D-Sub 15-pin connector on the rear of the unit, and then connect the other end to the computer's video connector. Refer to the following if connection is to be made to any other computer, refer to the instruction manual of the machine in question.

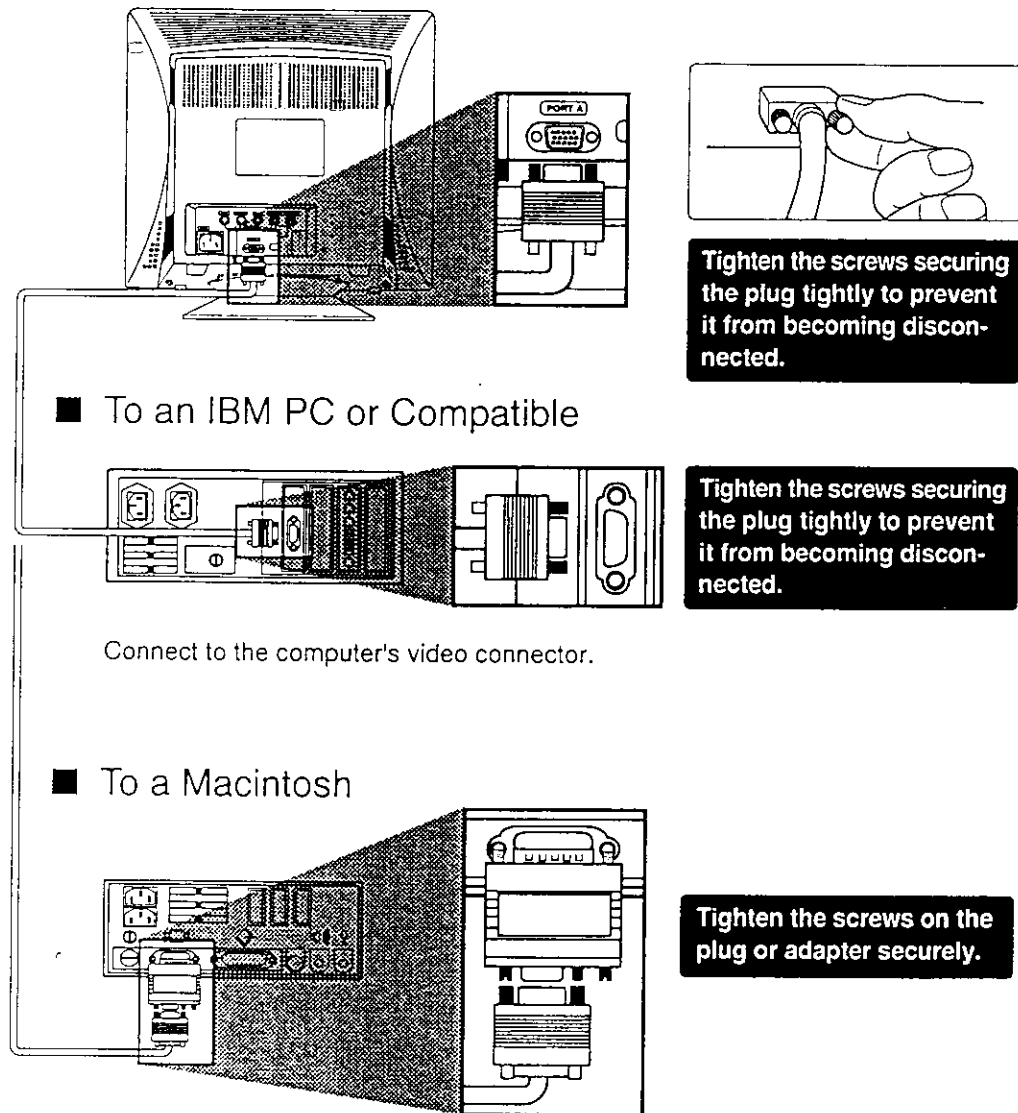

A commercially available conversion adapter is required for connection to Apple computers.

Connect the conversion adapter for Apple computers to the plug on the cable on the rear side of the display unit. Connect the other side of the cable to the video connector of the computer.

## 2. Attached power cord

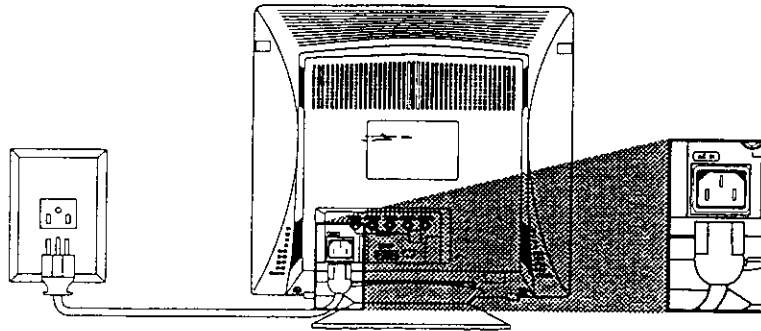

Find the power supply cord enclosed in the shipping carton. Connect the power supply cord to the connector marked "AC IN" on the rear side of the monitor. Connect the other side of the cable to an electrical outlet.

**Always use the power supply cord with the ground line attached. Connect the ground line properly to use the monitor safely. Use the power supply cord enclosed the shipping carton to use this unit safely.**

## 3. Power on

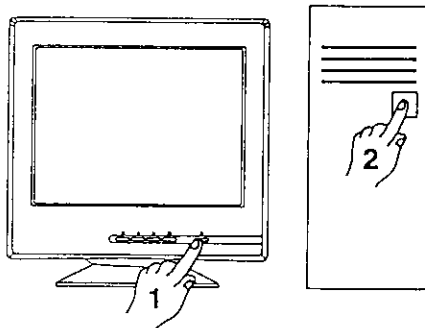

The monitor can use an AC power voltage of either 50 or 60 Hz. Turn the power switch of this unit (1 in the figure on the left) on, then turn the switch of the computer (2 in the figure on the left) on. Refer to the item "Operation" on page I-7 to perform the desired settings.

## AC power cord

**Always use the power supply cord that was enclosed with the unit.**

If the enclosed power supply cord is not used, use a power cord that conforms to the following regional standards.

- |                 |                                                             |
|-----------------|-------------------------------------------------------------|
| U.S.A .....UL   | Switzerland...SEV                                           |
| Canada .....CSA | Britain .....BASEC/BS                                       |
| Germany ....VDE | Japan.....According to the Electrical Appliance Control Act |

In other regions, for safety please use an AC plug cord that complies with each country's safety regulations.

# Adjustments

## Self-Test menu (No Signal screen)

This display indicates that the monitor is operating normally. When one of the following conditions occurs, press one of the 4 operation keys to call the appropriate display.

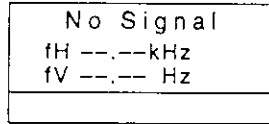

No signal ( The computer is not connected or the mains power to the computer is disconnected.)

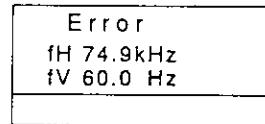

The horizontal or vertical sync. signal are outside of the permitted range ( the value of the horizontal sync. signal will be displayed in red and the value of the vertical sync. signal will be displayed in white.)

## Adjustment menu

### ● Contrast

Adjust the screen contrast to match the brightness level in the room. Pressing the [2] key toggles between brightness and contrast.

#### Direct operation

Even if the menu screen does not appear, the contrast can be adjusted by pressing the [4] or [5] key. If the [4] and [5] keys are pressed at the same time, the maximum level (100) will be set.

### ☀ Brightness

Adjust the brightness to match the brightness level in the room so that the level will be easy to see. Pressing the [2] key toggles between contrast and brightness.

Note: If the [4] and [5] keys are pressed at the same time on the Brightness adjustment screen, the standard level (50) will be set.

### ⏏ Size & Pos.

Press the [2] key to select the horizontal position / horizontal size / vertical position / vertical size adjustments.

#### ⏏ Horizontal position

The horizontal position of the image can be adjusted.

#### ⏏ Horizontal size

The horizontal size of the image can be adjusted.

Note: Setting the image in the center of the screen to start will make the adjustment easier.

#### ⏏ Vertical position

The vertical position of the image can be adjusted.

#### ⏏ Vertical size

The vertical size of the image can be adjusted.

Note: Setting the image in the center of the screen to start will make the adjustment easier.





## Adjustment menu

### Video Level





The video input signal level can be matched to the computer being used. Either 0.7V or 1V can be selected with the  (0.7V/1V) key.

### H. Moire reduction

Moire patterns are caused by interference of the CRT dot pitch and video signal due to the resolution of the input signal, video pattern, etc., producing patterns of horizontal stripes (Horizontal moire pattern) or vertical stripes (Vertical moire pattern).

- The moire correction circuit can be switched On and Off with the  key.
- When the moire correction circuit is switched On with the  (On/Off) key, the adjustment screen menu appears.
- Adjust with the  and  keys so that the striped moire pattern is in its optimum condition.



### V. Moire reduction

- The moire correction circuit can be switched On and Off with the  key.
- When the moire correction circuit is switched On with the  (On/Off) key, the adjustment screen menu appears.
- Adjust with the  and  keys so that the striped moire pattern is in its optimum condition.

**Caution:**

**If the moire reduction is overcorrected, the picture quality (for example focus, vertical line stability, etc.) will sometimes be affected. Keep this adjustment within the range in which the picture quality is not affected.**

### Language

The language of the On-Screen Display can be selected from among German, French, English, Italian and Spanish (Japanese is not available). Select with the  or  keys.

### OSD Position

It is possible to adjust the position that the on-screen panel is to be displayed. The panel will rotate in a counter-clockwise direction every time the  key is pressed.



### Degauss

Use this function to reduce the irregular colors in the image. The degaussing operates for approximately five seconds after selection.

Use this function when irregular colors occur in the image after moving the monitor or the changing the screen angle.

Note: The front panel keys do not operate when the power is turned on or the manual degaussing operation (approx. 5 seconds) is performed.

### Input select

Use the  and  keys to select either the rear panel input terminal port A (Mini D-Sub type) or port B (BNC type).

This displays the input synchronization signal frequency.

Information on the input screen mode (resolution, horizontal and vertical synchronization frequency) will be displayed on the display monitor. There are occasions sometimes when some screen modes in use do not display any resolution. Direct displayed allow this to be displayed on screen by pressing the  key even when the menu screen is not displayed.





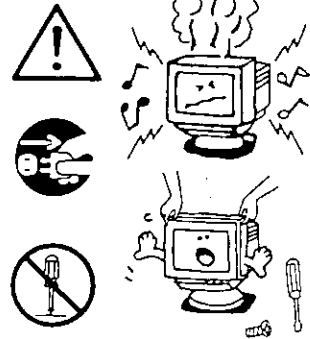

# If Trouble Occurs

**For safety, please observe the following points.**

- **When trouble occurs, turn the power OFF immediately and contact your dealer.**  
If smoke comes out of this unit or a bad odor or strange noise comes out, continuing to use the unit can cause a fire or electrical shock. Turn the power OFF immediately, unplug the power cord from the outlet and contact your dealer.
- **Absolutely do not remove the rear cover.**  
There are parts at high voltage inside, so touching them can cause an electrical shock. Leave inspection, adjustment and cleaning of the interior to your dealer.
- **Do not put anything inside.**  
If liquid or a foreign object should get inside accidentally, immediately turn the power OFF, unplug the power cord from the outlet and contact your dealer. Continuing to use the unit can cause a fire, electrical shock or breakdown of the unit.



If trouble occurs with the display unit, perform the following checks and take the indicated action; if the trouble persists, please consult with your dealer.

Symptom	Check	Action
 There is no display	power cord/plug power switch signal cable The power saving function might have acted (if so the pilot LED will be yellow).	Plug the power cord into the outlet correctly. Press the power switch. Connect the signal cable correctly. Release the power saving function by operating the mouse or keyboard. For additional details please read the Operation Manual of the hardware you are using.
 The image is too large or too small, or it is displaced from the correct position.	The mode is not registered.	Perform the desired settings and then save them by waiting 20 seconds or pressing the [Exit] key.
 The display color is abnormal. (Example) The color is uneven or off-color. The image distortion and or tilt is large.	Is there something that produces a magnetic field nearby? (Examples) Television monitor, another computer display unit, speaker, etc.; was the orientation of the monitor perhaps changed while it was in use?	Remove the source of the magnetic field. Perform degaussing. Make sure your cable is correct. Connect the signal connector correctly. Try a different orientation.
 The background of the image is bright. The background of the image is colored. The character gets partially distorted. The image is dark.	The computer in use is Macintosh. The signal output of the computer in use is improper.	Press the operating keys [1] and [2] together at the same time. You can then adjust this unit with the signal output of the computer. One more pressing or execution of recall can cancel this function. *This function is effective for a specified computer. If there is no problem in normal use, avoid the use of this function.
 Characters cannot be seen clearly; the image is too dark.	Is the image signal level correctly adjusted? Is the brightness or contrast adjustment turned all the way down?	Check the video signal level from the computer and adjust it in the correct direction. Adjust the brightness and contrast.
The screen size and position do not change.	Is the input synchronization signal within the operating range?	Check the video output mode from the computer, and select a mode within the display unit operating range. For details, please read the Operation Manual of the hardware you are using.
The front panel keys fail to operate.	Are 2 or more keys being operated at the same time?	Operate only one key at a time.

# Specifications

**Specifications are subject to change without notice for the purpose of improvement.**

CRT	Type	17-inch (16.0 inches / 40.6 cm viewable) flat screen
	Dot pitch	0.25 mm
	Fluorescent body / glass	RGB medium short persistence (Hi-EU RED) / Dark TINT
	Surface treatment	Advanced AGRAS (Anti-Glare, anti-Reflection and Anti-Static) Coat
Input signal	Video	RGB analog
	Signal level	0.7 Vp-p (without sync. signal), 1.0 Vp-p (with sync. signal)
	Synchronization	H/V separation (TTL level), H/V composit (TTL level), sync-on-green
	Operating Range	Horizontal Frequency Range: 30.0 kHz to 95.0 kHz Vertical Frequency Range: 50.0 Hz to 180.0 Hz
Connectors	Signal	15-pin mini D-Sub connector (female pins), BNC x 5
	Power supply	CEE 22 type 3-pin connector
Controls	Front panel	Power ON/OFF [1], [2] key
	On-Screen Display	Contrast, Brightness, Size & Pos. (H.Position, H.Size, V.Position, V.Size), Geometry (V.Pincushion, Side Pin.Bal., Trapezoid, Parallelogram), Rotation, Color Temp (9300K+8MPCD, 7500K, 6500K, 9300K+27MPCD, User), User color adjustment, Recall, Video Level (0.7V/1.0V), H.Moire, V.Moire, Language, OSD Position, Degauss, Input select (Port A, Port B, Display frequency)
Maximum pixelclock	158 MHz (typ.)	
Maximum resolution	1600 dots (H) x 1200 lines (V) / 75 Hz	
Display area	300 x 225 mm (1024 x 768)	
Operating conditions	Temperature: 5 to 35°C (41 to 95°F) Humidity: 5 to 90% (No condensation)	
Input power	AC 100 - 240 V (50/60 Hz)	
Power consumption	110 W typ / < 4 W (during power saving operation)	
Dimensions width x height x depth	410 x 416 x 382 mm	
Weight (main unit only)	17.2 kg	
Screen angle adjustment	13° (Up), 4° (Down), 90° (Left and Right)	



# Monitor stand

**After the display stand has been removed, store it in the box the display was shipped in.**

Observe the following instructions if the unit is to be used with the display stand removed. Repeat this procedure in the reverse order if the display stand is to be reattached.

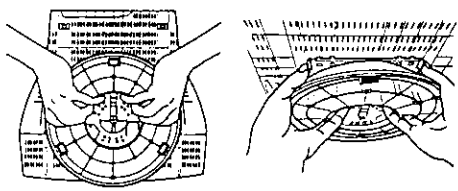
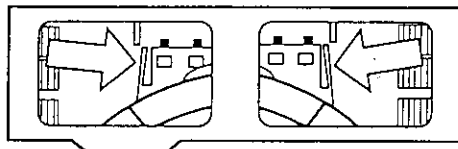
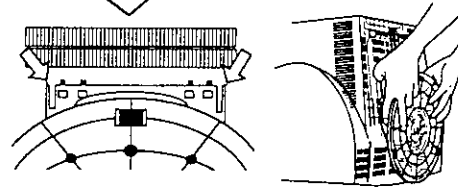
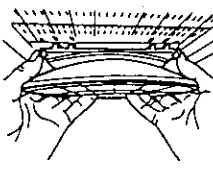
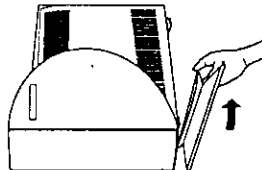
<p><b>1</b> Lay the screen down onto a soft object (cushion, etc.) to avoid scratching.</p>		
<p><b>2</b> Grasp the bottom of the display stand as indicated in the illustration.</p>  		
<p><b>3</b> Apply pressure with your fingers to the area shown in the illustration and lift the stand slightly in an upward direction. This will release the lock.</p> 		
<p><b>4</b> Once the lock has been released, remove your fingers and firmly lift upwards at an angle.</p> 	<p><b>5</b> This will separate the stand from the main unit.</p> 	<p><b>6</b> Place the unit on top of the computer to be used or on a tabletop.</p> <p>Store the display stand in the box or other receptacle in which the computer was purchased.</p>

## Index

(In alphabetical order)	(page)
Apple .....	I-4
Brightness .....	I-8
CE .....	I-ii
Color Temp .....	I-9
Contrast .....	I-8
DDC .....	I-2
Degauss .....	I-10
Dimensions .....	I-2
DPMS .....	I-2
ENERGY STAR® .....	I-ii
Geometry .....	I-9
Horizontal Frequency Range .....	I-14
Horizontal position .....	I-8
Horizontal size .....	I-8
H. Moire reduction .....	I-10
IBM .....	I-4
Input select .....	I-10
Language .....	I-10
Macintosh .....	I-2
Operating Range .....	I-14
OSD Position .....	I-10
Parallelogram .....	I-9
Pedestal adjustment angle .....	I-2
Pin assignments .....	I-5
Power Management System .....	I-11
Preset Mode .....	I-11
Recall .....	I-9
Rotation .....	I-9
Side pincushion balance .....	I-9
Size & Pos. ....	I-8
Specifications .....	I-14
TCO'92 .....	I-2
Trapezoid .....	I-9
Trouble shooting .....	I-12
UL .....	I-6
User color .....	I-9
Vertical Frequency Range .....	I-14
Vertical pincushion .....	I-9
Vertical position .....	I-8
Vertical size .....	I-8
Video Level .....	I-10
V. Moire reduction .....	I-10

# Precaution *Always observe the following precautions and use this unit safely.*

## 1) Installation location

- Avoid direct sunlight and heat sources such as heaters.  
Heat adversely affects the cabinet and the parts. Keep the power cord away from heat sources; failing to do so could cause fire or electrical shock.
- Install in a well ventilated location.  
To prevent the temperature from rising inside the set, there are ventilation holes in the cabinet. Make sure that they are not obstructed. Install the unit at least 10cm from walls, and do not install it in a book cabinet or lying on its side, which could block the ventilation holes. Failure to observe this precaution could cause fire or equipment breakdown.
- Do not install in a location with a great deal of moisture or dust.  
Avoid wet locations such as a kitchen drainboard, bathroom or washing machine; also avoid locations with a great deal of steam, water vapor or dust. Failure to observe this precaution could cause fire, electrical shock or equipment breakdown.

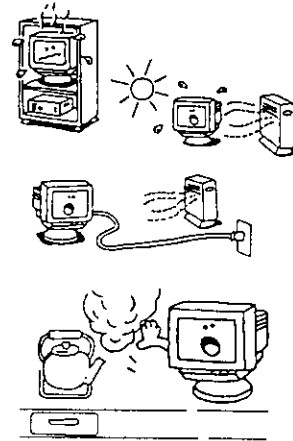

## 2) Precautions in use

- Handle the power cord carefully.  
Do not place any heavy objects on top of the power cord, add legs to it, tie knots in it or pull on the cord when unplugging it. If the power cord is damaged (for example if the wires are exposed or broken) there is danger of causing fire or electrical shock.
- Do not place anything on top of the main unit.  
Do not place any foreign object such as a container containing water or another liquid, or a solvent or cloth soaked in a solvent, or a metal object such as a paper clip, on the unit. If the object is knocked over the liquid can spill and enter the interior of the unit, causing fire, electrical shock or equipment breakdown.
- Handle the cabinet carefully.  
If a volatile solvent or adhesive comes into contact with the cabinet, the surface can be damaged or the paint might come off. If a rubber or vinyl object is in contact with the cabinet for a long time, the surface can be stained.
- Avoid magnetism.  
Use the unit removed from any object such as a speaker that uses a magnet or an object such as a motor or transformer that generates a strong magnetic field. The magnetism can distort the color or cause tearing of the image in the screen.
- Avoid disrupting reception.  
Use of this unit near a television or other display unit can result in both interfering with the other's reception, tearing of the images and noise. Keep them as far apart as possible.
- When moving this unit, be careful not to apply shock to it. Always unplug the power cord from the outlet and disconnect all other external cables and cords. Be especially careful with the CRT.

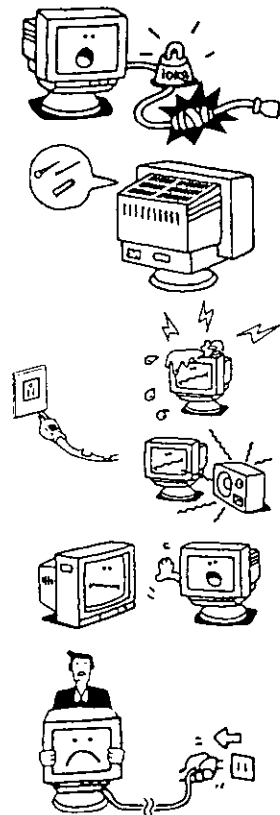

## 3) Care of this unit

- Clean this unit with a soft, dry cloth.  
If it becomes very dirty, wipe it with a cloth that has been soaked in neutral detergent diluted with water and then wrung out thoroughly, then dry with a dry cloth.  
Use of a chemically treated cloth or gloss-producing cleaner can damage the surface or cause the paint to come off.  
Do not rub the surface of the CRT with a hard object or strike it with anything. Doing so can scratch it.

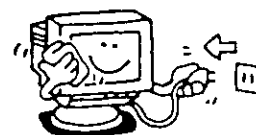

## Power Management System

This monitor conforms to the VESA DPMS standard.

This function can suppress power consumption by the display unit.

The computer and video board being used must also conform to the VESA DPMS standard.

Note: Regarding operation, please consult the Operation Manuals for the hardware being used.

Modes change in response to input signals as indicated in the table below.

APM state	Screen status	LED color	Power consumption	Return time	Input signal		
					Video	Horizontal	Vertical
ON STATE	Active	Green	Normal	-	ON	ON	ON
STAND-BY	Black out	Yellow	< 15Watts	< 3sec.	OFF	OFF	ON
SUSPEND	Black out	Yellow	< 15Watts	< 3sec.	OFF	ON	OFF
OFF STATE	Black out	Yellow	< 4Watts	< 20sec.	OFF	OFF	OFF

APM : Advanced Power Management

### Caution

How to release the system from the power management function.

1) Read the Operation Manuals for the hardware you are using.

2) Press one of the [1], [4], [5], [2] keys on the front panel.

The No Signal screen appears, and the monitor side power management function is released (only in OFF STATE).

## Display Modes Memory

• Up to 13 modes can be newly registered as user's preset modes.

• If the new adjustment data differ from any of the following 4, they can be registered as new data.

Horizontal frequency	Horizontal sync. polarity	Vertical frequency	Vertical sync. polarity
----------------------	---------------------------	--------------------	-------------------------

• The data that can be registered are those in the following table.

Horizontal frequency	Horizontal sync. polarity	Horizontal position	Horizontal size
Vertical frequency	Vertical sync. polarity	Vertical position	Vertical size
Vertical pincushion	Side pincushion balance	Trapezoid	Parallelogram
Video Level	Horizontal moire	Vertical moire	

• How to register adjustment data

- 1) Input the computer signal to be registered to the display unit.
- 2) Select the item to be adjusted from the OSD screen and then adjust it.
- 3) When the [1] key is pressed, the adjusted value is registered.  
If a front panel key is not operated for about 20 seconds, the adjustment is registered.

## Preset Mode

The timing in the following table has been preset.

Mode	Resolution	Horizontal frequency (kHz)	Vertical frequency (kHz)	Sync. signal polarity	
				Horizontal	Vertical
VGA 640 × 480 at 60 Hz	640 × 480	31.47	59.94	-	-
VESA 640 × 480 at 75 Hz	640 × 480	37.50	75.00	-	-
VESA 800 × 600 at 75 Hz	800 × 600	46.88	75.00	+	+
Mac 832 × 624 at 75 Hz	832 × 624	49.73	74.55	-	-
VESA 1024 × 768 at 70 Hz	1024 × 768	56.48	70.07	-	-
VESA 1024 × 768 at 75 Hz	1024 × 768	60.02	75.03	+	+
Mac 1024 × 768 at 75 Hz	1024 × 768	60.24	74.93	-	-
VESA 1280 × 1024 at 75 Hz	1280 × 1024	79.98	75.03	+	+

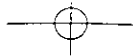

## Adjustment menu

---

### Geometry

Press the  key to select the vertical pincushion / side pincushion balance / trapezoid / parallelogram adjustments.

---

#### Vertical pincushion

The image can be corrected for barrel distortion.

---

#### Side pincushion balance

It is possible to adjust the side pincushion balance to the left and right.

---

#### Trapezoid

The image can be corrected for trapezoidal distortion.

---



#### Parallelogram

The image can be corrected for parallelogram distortion.

---

### Rotation





This control adjusts the evenness of the screen image relative to a horizontal line.

Note: If the  and  keys are pressed at the same time, the standard level (50) will be set.

---



### Color Temp

It is possible to switch the whiteness of the image.

- 1) Press the  and  keys to select 1 (9300K + 8MPCD) / 2 (7500K) / 3 (6500K) / 4 (9300K+27MPCD) / 5 (User color).
  - 2)  will be displayed at the bottom right-hand side of the on-screen panel when 5 (User color) has been selected. Press the  key on the front operation area to enter the User color adjustment screen.
- 



### User color

It is possible to adjust the whiteness of the image to suit personal preference.

- 1) Select R (red), G (green), B (blue) with the  key.
  - 2) Adjust the color to match personal preference with  and  keys.
- \* As user colors cannot be recalled, take notes of the set values beforehand.
- 

### Recall

It is possible to return to the initial settings (the settings at the time of factory shipment).

- 1) When the  key (Yes) is pressed, the settings are recalled and the menu screen returns. (Recall = return to initial settings (settings at time of factory shipment).)
- 2) When the  key (No) is pressed, the menu screen returns without the settings being recalled. (The settings return to what they were immediately before the recall.)

If there are no operations performed for about 30 seconds, the screen goes off without a recall.

# Operation

## Basic operation

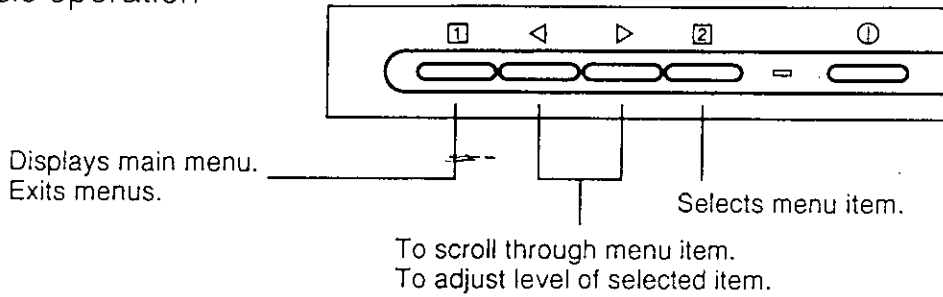

## Menu screen

The functions that can be adjusted for this unit are displayed as icons.

- 1) Press the ① key to return to the menu screen.
- 2) This is modified by pressing the ◀ and ▶ keys at the front.
- 3) Press the ② key to enter the adjustment screen.

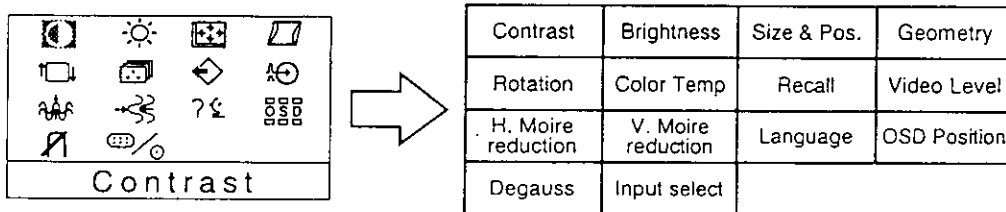

## Operation procedure

### Horizontal position adjustment

1. Press the ① key to display the menu.

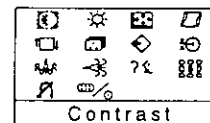
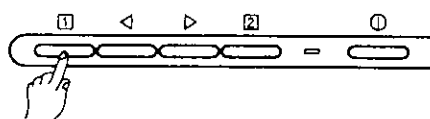

2. Press the ◀ key to select the Size & Pos. from the menu screen. Press the ② key to display the menu.

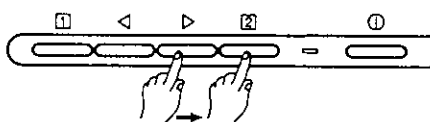

3. Press the front ◀ or ▶ keys to reach the desired condition.

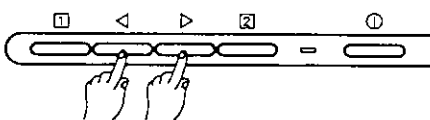

4. Press the ① key to memory the settings and complete the adjustments. Press the ① key once more to clear the menu screen.

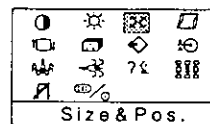
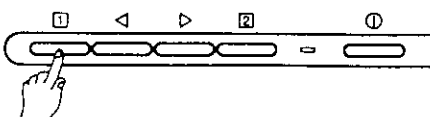

### ■ Case of BNC type

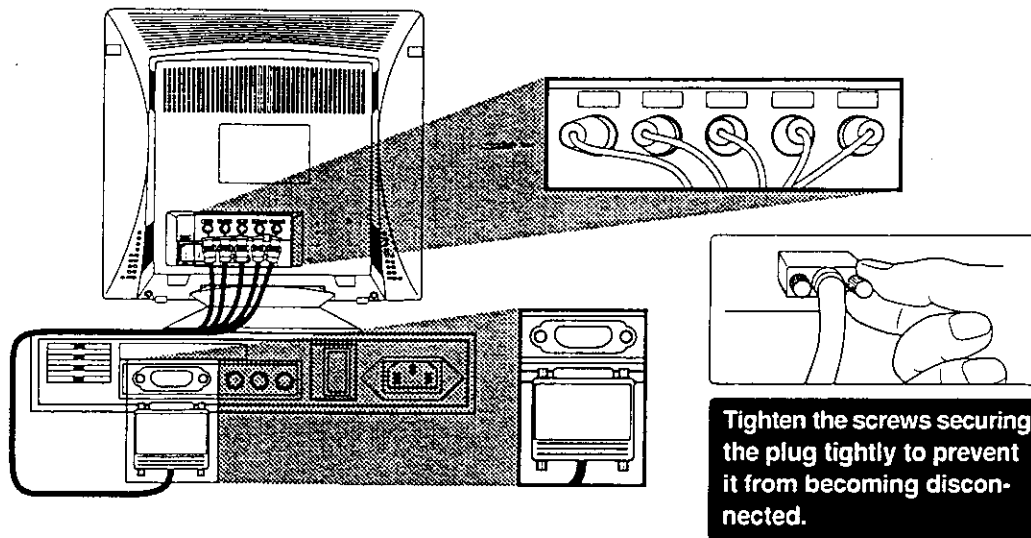

Please read that system's operation manual.  
Connect according to the signal system of the computer you are using.

## Connectors **Do not modify the cable or attempt to manufacture a cable by yourself. A non-standard cable may damage the computer.**

### Mini D-Sub connector

Pin assignments of 15-pin mini D-Sub connector.

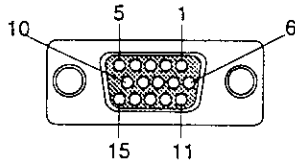

Pin number	Signal name	Pin number	Signal name
1	Red signal	9	Open
2	Green signal	10	Ground
3	Blue signal	11	Ground
4	Ground	12	SDA*
5	Ground*	13	Horizontal sync.signal
6	Red signal ground	14	Vertical sync. signal
7	Green signal ground	15	SCL*
8	Blue signal ground		

\* : VESA DDC standard.

### BNC connector

Referring to the figure below, connect according to the signal system of the computer you are using.

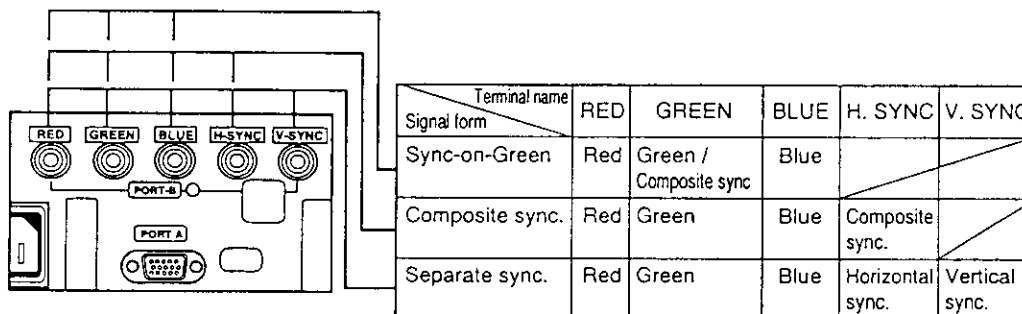



# Names

## Front view

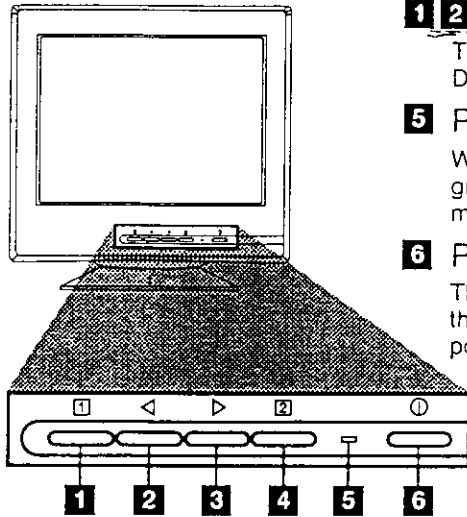

### 1 2 3 4 Operation Keys

These keys are used for screen adjustment. Details are given starting on the I-7 page.

### 5 Pilot LED

When power is turned ON, the lamp lights up green; when the unit goes into power management mode, the light turns yellow.

### 6 Power switch

This turns the power ON and OFF. Press to turn the power ON; press again to turn the power OFF.

## Rear view

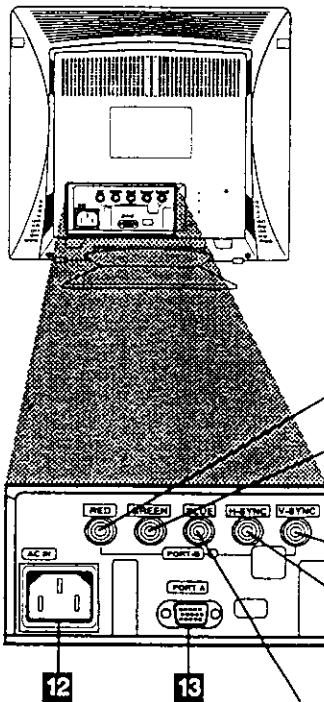

### 7 8 9 10 11 PORT-B(BNC connector)

To the computer video output.

### 12 PORT-A (Mini D-Sub15 pin connector)

To the computer video output.

### 13 AC inlet

Connect the power cord.

7 Red BNC connector

8 Green or Sync. on Green BNC connector

11 V.sync. BNC connector

10 H.sync. or Composite sync. BNC connector

9 Blue BNC connector

## Federal Communications Commission Requirements

This equipment has been tested and found to comply with the limits for Class B digital devices, pursuant to Part 15 of the FCC Rules. These limits are designed to provide reasonable protection against harmful interference in a residential installation. This equipment generates, uses, and can radiate radio frequency energy and, if not installed and used in accordance with the instructions, may cause harmful interference to radio communications. However, there is no guarantee that interference will not occur in a particular installation. If this equipment does cause harmful interference to radio or television reception, which can be determined by turning the equipment off and on, the user is encouraged to try to correct the interference by one or more of the following measures:

- Reorient or relocate the receiving antenna.
- Increase the separation between the equipment and receiver.
- Connect the equipment into an outlet on a circuit different from that to which the receiver is connected.
- Consult the dealer or an experienced radio/TV technician for help.

### FCC Warning:

To assure continued FCC compliance, the user must use grounded power supply cord and the provided shielded video interface cable with bonded ferrite cores. Also, any unauthorized changes or modifications to this monitor would void the users authority to operate this device.

## Customer's Record

The serial number of this product may be found on its back cover.

You should note this serial number of this unit in the space provided and retain this booklet as a permanent record of your purchase to aid in identification in the event of theft or loss.

Model number : TX-D7S54NM

Serial number :

## Table of Contents

*Product names listed here are company trademarks or registered trademarks.*

Features	I-2
Dimensions	I-2
Names	I-3
Connections	I-4
Connectors	I-5
AC power cord	I-6
Operation	I-7
Operation procedure	I-7
Adjustments	I-8
Power Management System	I-11
Display Modes Memory	I-11
Preset Mode	I-11
If Trouble Occurs	I-12
Precaution	I-13
Specifications	I-14
Monitor stand	I-15
Index	I-15

**ENGLISH**

### IMPORTANT NOTICE CONCERNING POWER CORD SELECTION

The power cord for this unit has been packed separately and has been selected according to the country of destination and must be used to prevent electric shock. Use the following guidelines if it is necessary to replace the original cord set.

The female receptacle of the cord set must meet CEE-22 requirements and will look like Figure 1:

#### For the United States and Canada

In the United States and Canada the male plug is a NEMA 5-15 style (Figure 2) and is UL listed and CSA labelled. For units which are mounted on a desk or table, type SVT or SJT cord sets may be used. For units which sit on the floor, only SJT type cord sets may be used. The cord set must be selected according to the current rating for your unit. Please consult Table A for the selection criteria for power cords used in the United States and Canada. (The cord set is marked with its Cord Type.)

#### For European Countries:

In Europe you must use a cord set which is appropriate for the receptacles in your country. The cord set is HAR-Certified, and the mark ◀HAR▶ will appear on the outer sheath, or on the insulation of one of the inner conductors.

If you have any questions concerning the proper power cord to use, please consult with the dealer from whom you purchased your unit.

Table A

Cord Type	Size of Conductors In Cord	Maximum Current Rating of Unit
Kabeltyp	Größe der Kabeladern	Max. Stromaufnahme des Geräts
Tipo de cable	Tamaño de los conductores del cable	Máximo voltaje de acuerdo a la unidad
Type de cordon	Taille des conducteurs dans le cordon	Ampérage maximum de l'unité
SJT	18AWG 16AWG 14AWG	10Amps 12Amps 12Amps
SVT	18AWG 17AWG	10Amps 12Amps



Figure 1

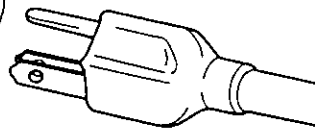
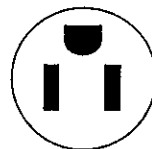

Figure 2