

Panasonic[®]

Operating Instructions

SIP Phone

Model No. **KX-HDV430**



Thank you for purchasing this Panasonic product.

Please read this manual carefully before using this product and save this manual for future use.

Note

- In this manual, the suffix of each model number is omitted unless necessary.
- The illustrations such as some keys may differ from the appearance of the actual product.
- Certain products and features described in this document may not be available in your country or area. Contact your phone system dealer/service provider.
- The contents and design of the software are subject to change without notice.

Document Version: 2016-05

Introduction

Outline

This manual describes information about the installation and operation of KX-HDV430.

Related Documentation

- **Quick Start Guide**

Describes basic information about the installation and safety precautions to prevent personal injury and/or damage to property.

- **Administrator Guide**

Describes detailed information about the configuration and management of this unit.

Manuals and supporting information are provided on the Panasonic Web site at:

<http://www.panasonic.net/pcc/support/sipphone/>

For Future Reference

Record the information in the space below for future reference.

Note

- The serial number and MAC address of this product may be found on the label affixed to the bottom of the unit. You should note the serial number and MAC address of this unit in the space provided and retain this manual as a permanent record of your purchase to aid in identification in the event of theft.

MODEL NO.	_____
SERIAL NO.	_____
MAC ADDRESS	_____
DATE OF PURCHASE	_____
NAME OF DEALER	_____
DEALER'S ADDRESS	_____ _____ _____
DEALER'S TEL. NO.	_____

Other Information

Trademarks

- The Bluetooth® word mark and logos are owned by the Bluetooth SIG, Inc. and any use of such marks by Panasonic Corporation is under license.
- All other trademarks identified herein are the property of their respective owners.

Important Information

Important Information4
 For Users in European Countries5
 For Users in the United Kingdom5
 For Users in Australia5
 For Users in Australia and the United Kingdom6
 For Users in New Zealand6
 For Users in the United States6
 For Users in Canada8
 For Best Performance9

Before Operating the Telephones

Accessory Information10
 Location of Controls12
 The Display and Icons19
 Adjusting the Volume26
 Incoming/Outgoing Call Log26
 Setting the Password27
 Selecting the Display Language27
 Entering Characters28
 Bluetooth Headset29
 Basic Operation29

Making Calls

Making Calls31
 Basic Calling31
 Easy Dialing32
 Making a Multicast Voice Paging call34

Receiving Calls

Receiving Calls35
 Answering Calls35
 Hands-free Mode36
 Training Mode36

During a Conversation

During a Conversation37

Before Leaving Your Desk

Call Forwarding/Do Not Disturb44
 Listening to Voice Mail Messages44
 Xsi Visual Voice Mail44

Using the Phonebook

Using the Phonebook46
 Using the Personal Phonebook47
 Using the Shared Phonebook53

Checking the Line Status

Checking the Line Status54

Network Camera

Network Camera56
 Configuring Display Properties59
 Receiving Alarms from Network Cameras61

Communication Camera

Communication Camera63

Customizing the Telephone

Customizing the Telephone65

Installation and Setup

Installation and Setup73
 Updating the software81

Appendix

Appendix82

Important Information

Data Security

We cannot be responsible for damages resulting from the misuse of this product.

- Keep a copy of all important data (such as the phonebook list) in case the machine malfunctions and data cannot be recovered.
- This product can store your private/confidential information. To protect your privacy/confidentiality, we recommend that you erase the information such as the phonebook or call log from the memory before you dispose of, transfer or return the product, or have the product repaired.
- To avoid unauthorized access to this product:
 - Keep the password secret.
 - Change the default password.
 - Set a password that is random and cannot be easily guessed.
 - Change the password regularly.
- Security settings, such as passwords, cannot be undone at Panasonic service centers. Take measures to prevent passwords from being lost or forgotten.
- If a password is forgotten, initialize the unit and configure the settings again. For details, consult your administrator or dealer.
- It is recommended that you lock the phonebook to prevent stored information from being leaked.

Disposal of Old Equipment and Batteries

Only for European Union and countries with recycling systems



These symbols on the products, packaging, and/or accompanying documents mean that used electrical and electronic products and batteries must not be mixed with general household waste.

For proper treatment, recovery and recycling of old products and batteries, please take them to applicable collection points in accordance with your national legislation.

By disposing of them correctly, you will help to save valuable resources and prevent any potential negative effects on human health and the environment.

For more information about collection and recycling, please contact your local municipality.

Penalties may be applicable for incorrect disposal of this waste, in accordance with national legislation.



Note for the battery symbol (bottom symbol)

This symbol might be used in combination with a chemical symbol. In this case it complies with the requirement set by the Directive for the chemical involved.

For Users in European Countries

The following declaration is applicable to KX-HDV430NE/KX-HDV430X only

CE 0470

Panasonic System Networks Co., Ltd. declares that this equipment is in compliance with the essential requirements and other relevant provisions of Radio & Telecommunications Terminal Equipment (R&TTE) Directive 1999/5/EC.

Declarations of Conformity for the relevant Panasonic products described in this manual are available for download by visiting:

<http://www.ptc.panasonic.eu>

Contact to Authorized Representative:
Panasonic Testing Center
Panasonic Marketing Europe GmbH
Winsbergring 15, 22525 Hamburg, Germany

Ecodesign information

Ecodesign information under EU Regulation (EC) No.1275/2008 amended by (EU) Regulation No. 801/2013.

=====
Please visit here: www.ptc.panasonic.eu
click [Downloads]

→ Energy related products information (Public)

=====
Power consumption in networked standby and guidance are mentioned in the web site above.

For Users in the United Kingdom

- This unit is designed to be installed under controlled conditions of ambient temperature and a relative humidity.
- Avoid installing the unit in damp or humid environments, such as bathrooms or swimming pools.
- 999 and 112 can be dialed on the product after accessing the outside line for the purpose of making outgoing calls to the BT emergency (999) and (112) services.
The method for accessing an outside line differs depending on the SIP server. For details, confirm the features of the SIP server.

For Users in Australia

WARNING

- Please ensure that a separate telephone, not dependent on local power, is available for emergency use.
- This equipment will be inoperable when mains power fails.
- No "000" or other calls can be made from this device during a mains power failure.

For Users in Australia and the United Kingdom

- This unit is capable of being used in conjunction with hearing aids fitted with inductive coil pick-ups. The handset should be held as for normal conversation. For operation, the hearing aid should be set to its "T" position or as directed in the operating instructions for the hearing aid.
- This unit is designed to aid the visually handicapped to locate dial keys and buttons.



For Users in New Zealand

- This equipment shall not be set to make automatic calls to the Telecom '111' Emergency Service.

PTC General Warning

- The grant of a Telepermit for any item of terminal equipment indicates only that Telecom has accepted that the item complies with minimum conditions for connection to its network. It indicates no endorsement of the product by Telecom, nor does it provide any sort of warranty. Above all, it provides no assurance that any item will work correctly in all respects with another item of Telepermitted equipment of a different make or model, nor does it imply that any product is compatible with all of Telecom's network services.

The Use of IP Networks through the PSTN

- Internet Protocol (IP) by its nature introduces delay into speech signals as each data packet is formulated and addressed. Telecom Access Standards recommends that suppliers, designers and installers using this technology for calls to or from the PSTN refer to ITU E Model requirements in the design of their networks. The overall aim is to minimize delay, distortion and other transmission impairments, particularly for those calls involving cellular and international networks, which already suffer extensive delay.

Echo cancellation

- Echo cancelers are not normally required in the Telecom PSTN because geographic delays are acceptable where CPE return loss is maintained within Telepermit limits. However, those private networks making use of Voice over IP technology are required to provide echo cancellation for all voice calls. The combined effect of audio/VoIP conversion delay and IP routing delay can cause the echo cancellation time of ≥ 64 ms to be required.

Important Notice

- Under power failure conditions this appliance may not operate. Please ensure that a separate telephone, not dependent on local power, is available for emergency use.
- No "111" or other calls can be made from this device during a mains power failure.

For Users in the United States

Note

- This equipment has been tested and found to comply with the limits for a Class B digital device, pursuant to Part 15 of the FCC Rules. These limits are designed to provide reasonable protection against harmful interference in a residential installation. This equipment generates, uses, and can radiate radio frequency energy and, if not installed and used in accordance with the instructions, may cause harmful interference to radio communications. However, there is no guarantee that interference will not occur in a particular installation. If this equipment does cause harmful interference to radio or

television reception, which can be determined by turning the equipment off and on, the user is encouraged to try to correct the interference by one or more of the following measures:

- Reorient or relocate the receiving antenna.
- Increase the separation between the equipment and receiver.
- Connect the equipment to an outlet on a circuit different from that to which the receiver is connected.
- Consult the dealer or an experienced radio/TV technician for help.

This device complies with Part 15 of the FCC Rules. Operation is subject to the following two conditions:

(1) this device may not cause harmful interference, and (2) this device must accept any interference received, including interference that may cause undesired operation.

WHEN PROGRAMMING EMERGENCY NUMBERS AND/OR MAKING TEST CALLS TO EMERGENCY NUMBERS:

1. Remain on the line and briefly explain to the dispatcher the reason for the call before hanging up.
2. Perform such activities during off-peak hours, such as early morning or late evening.

CAUTION

Any changes or modifications not expressly approved by the party responsible for compliance could void the user's authority to operate this product.

FCC RF Exposure Warning:

- This product complies with FCC radiation exposure limits set forth for an uncontrolled environment.
- To comply with FCC RF exposure requirements, this product must be installed and operated 20 cm (8 inches) or more between the product and all person's body.
- This product may not be collocated or operated in conjunction with any other antenna or transmitter.

FCC ID can be found on the bottom of the units.

Privacy of communications may not be ensured when using this phone.

Hearing Aid Compatibility

This telephone provides magnetic coupling for hearing aids as defined by the FCC in 47 CFR Section 68.316. Use only handsets or other acoustic devices with this equipment that are compliant with the hearing aid compatibility requirements of FCC Part 68.

When you hold the phone to your ear, noise might be heard in your Hearing Aid. Some Hearing Aids are not adequately shielded from external RF (radio frequency) energy. If noise occurs, use an optional headset accessory or the speakerphone option (if applicable) when using this phone. Consult your audiologist or Hearing Aid manufacturer about the availability of Hearing Aids which provide adequate shielding to RF energy commonly emitted by digital devices.

Compliance with TIA-1083 standard:



Telephone handsets identified with this logo have reduced noise and interference when used with T-Coil equipped hearing aids and cochlear implants.

Important Information

Responsible Party

Panasonic Corporation of North America
Two Riverfront Plaza, Newark, NJ 07102-5490

Technical Support

Panasonic Corporation of North America
Two Riverfront Plaza, Newark, NJ 07102-5490
Telephone: 1 (800) 528-6747 Option 1

For Users in Canada

Industry Canada Notices and Other Information

This product meets the applicable Innovation, Science and Economic Development Canada technical specifications.

Notice

- This device complies with Industry Canada licence-exempt RSS standard(s). Operation is subject to the following two conditions: (1) this device may not cause interference, and (2) this device must accept any interference, including interference that may cause undesired operation of the device.
- This Class B digital apparatus complies with Canadian ICES-003.

CAUTION

Any changes or modifications not expressly approved by the party responsible for compliance could void the user's authority to operate this product.

Compliance with TIA-1083 standard:



Telephone handsets identified with this logo have reduced noise and interference when used with T-Coil equipped hearing aids and cochlear implants.

RF Exposure Warning:

- This product complies with IC radiation exposure limits set forth for an uncontrolled environment.
- To comply with IC RF exposure requirements, this product must be installed and operated 20 cm (8 inches) or more between the product and all person's body.
- This product may not be collocated or operated in conjunction with any other antenna or transmitter.

Privacy of communications may not be ensured when using this phone.

For Best Performance

Environment

- Keep the product away from heating appliances and devices that generate electrical noise, such as fluorescent lamps, motors and televisions. These noise sources can interfere with the performance of the product.
- Do not place the product in rooms where the temperature is less than 0 °C (32 °F) or greater than 40 °C (104 °F).
- Allow 10 cm (3–15/16 in) clearance around the product for proper ventilation.
- Avoid environments with excessive smoke, dust, moisture, mechanical vibration, shock, or direct sunlight.
- The apparatus is designed to be installed and operated under controlled conditions of ambient temperature and a relative humidity.

Routine Care

- Unplug the AC adaptor from the AC outlet and disconnect the Ethernet cable before cleaning.
- Wipe the product with a soft cloth.
- Do not clean the product with abrasive powder or with chemical agents such as benzine or thinner.
- Do not use liquid cleaners or aerosol cleaners.

Touch Display

- Touch the display only with the end of your finger. Do not touch the display with sharp objects, such as a pen or your fingernails.
- Use only one finger. Touching the display with more than one finger can result in unexpected behavior.

Placement





- Do not place heavy objects on top of the product.
- Care should be taken so that objects do not fall onto, and liquids are not spilled into, the product.

Optional Equipment

- A KX-HDV20 (20 Key Expansion Module) can be used with the product.
- The KX-HDV20 can be used only when the product receives power from the optional AC adaptor; it cannot be used when the product receives power via Power-over-Ethernet (PoE).
- Up to 5 KX-HDV20 units can be connected to the product.
To mount a second KX-HDV20 unit or more, mount each in turn, unattached to the main unit.

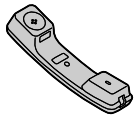
Accessory Information

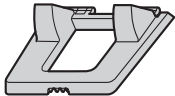
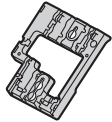
Included Accessories

Handset: 1 	Handset Cord: 1 	Stand: 1 
Wall Mounting Adaptor: 1 	Screws for wall mounting: 3*1 	

*1 The two large screws are for mounting the unit on the wall. The small screw is for attaching the wall mounting adaptor to the unit.

Optional Accessories



Item	Model	AC Adaptor Model No.*2
AC Adaptor*1	KX-HDV430NE/ KX-HDV430RU	KX-A424CE (PNLV6508)
	KX-HDV430X	KX-A424X (PNLV6508)/KX-A424AL (PNLV6508)/ KX-A424BR (PNLV6508)/KX-A424CE (PNLV6508)/ KX-A424E (PNLV6508)/KX-A424AG (PNLV6508)/ KX-A424TW (PNLV6508)
	KX-HDV430SX	KX-A424SX (PNLV6508)
	KX-HDV430/ KX-HDV430C	KX-A424 (PNLV6508)

*1 This unit complies with the IEEE 802.3af Power-over-Ethernet (PoE) standard. If PoE is available on your network, this unit can receive the necessary power from the network through the Ethernet cable. In this case, no AC adaptor is needed. However, if PoE is not available or if you will use a KX-HDV20 (20 Key Expansion Module), you will need to connect an AC adaptor to the unit.

*2 To order an optional AC adaptor, please order using the "KX-A424xx" model number. For details about which AC adaptor model number you should order, consult your dealer.

Item	Model	20 Key Expansion Module Model No.
20 Key Expansion Module	KX-HDV430NE	KX-HDV20NE
	KX-HDV430RU	KX-HDV20RU
	KX-HDV430X	KX-HDV20X
	KX-HDV430/ KX-HDV430C	KX-HDV20

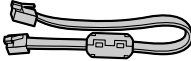
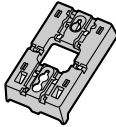
KX-HDV20 Included Accessories

<p>Stand: 1</p> 	<p>Connection cable: 1</p> 	<p>Wall mount adaptor for KX-HDV20: 1</p> 
<p>Screws for wall mounting: 3*1</p> 	<p>Screw for attaching the KX-HDV20 to the unit: 1</p> 	

*1 The two large screws are for mounting the unit on the wall. The small screw is for attaching the wall mounting adaptor to the unit.

Note

For users in the United States only

To order accessories, call toll-free **1-800-332-5368**.

Location of Controls

KX-HDV430NE

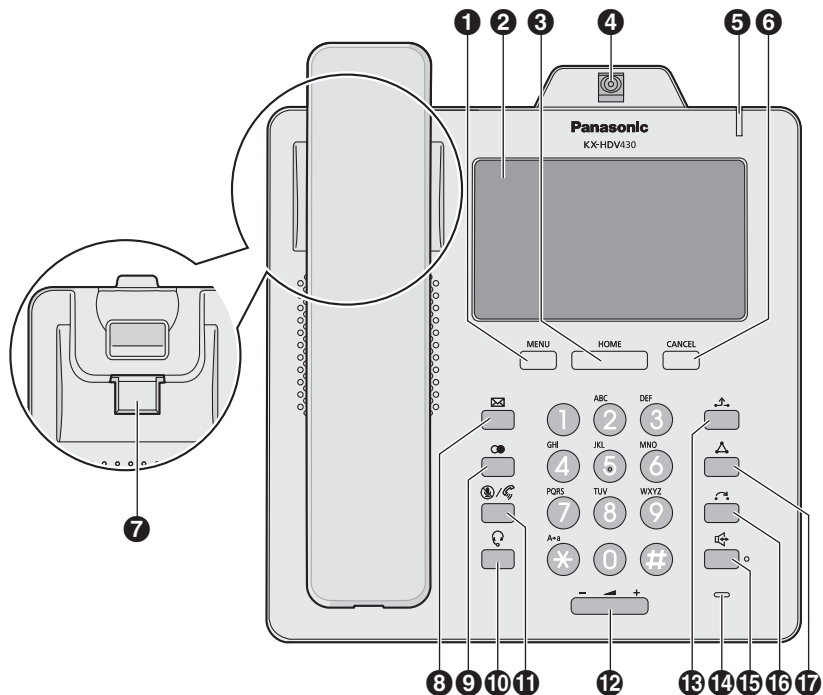

KX-HDV430X/KX-HDV430SX

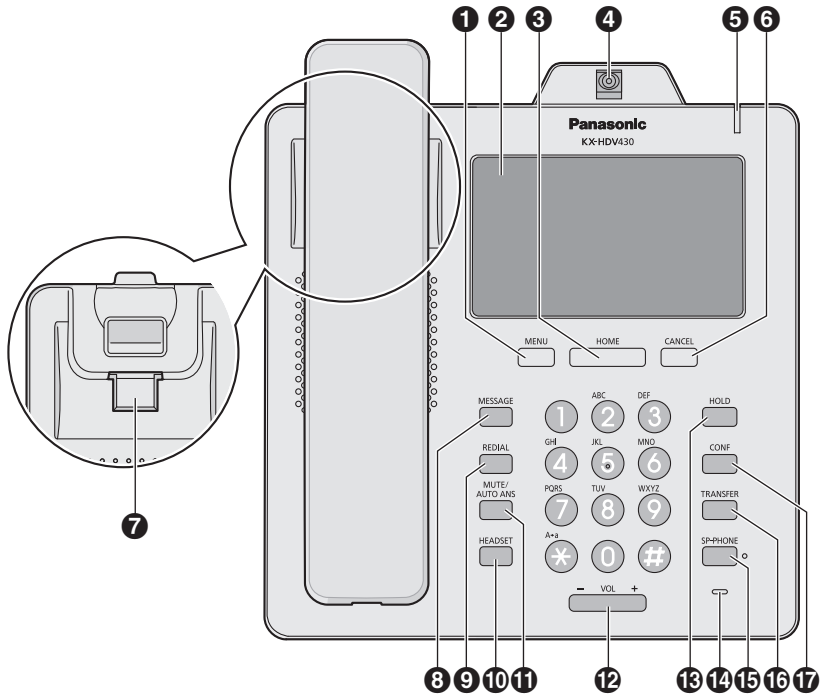

Before Operating the Telephones

KX-HDV430RU

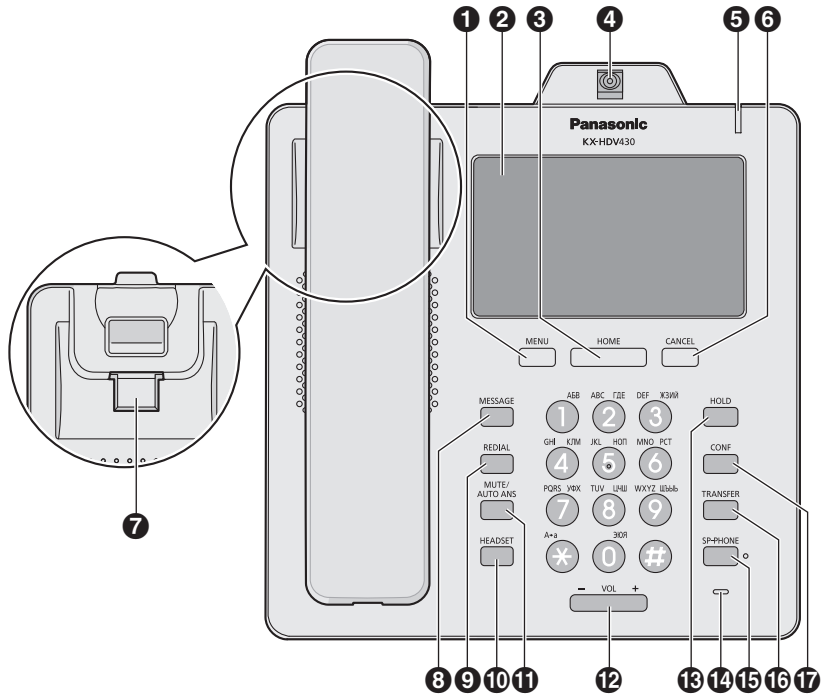

KX-HDV430

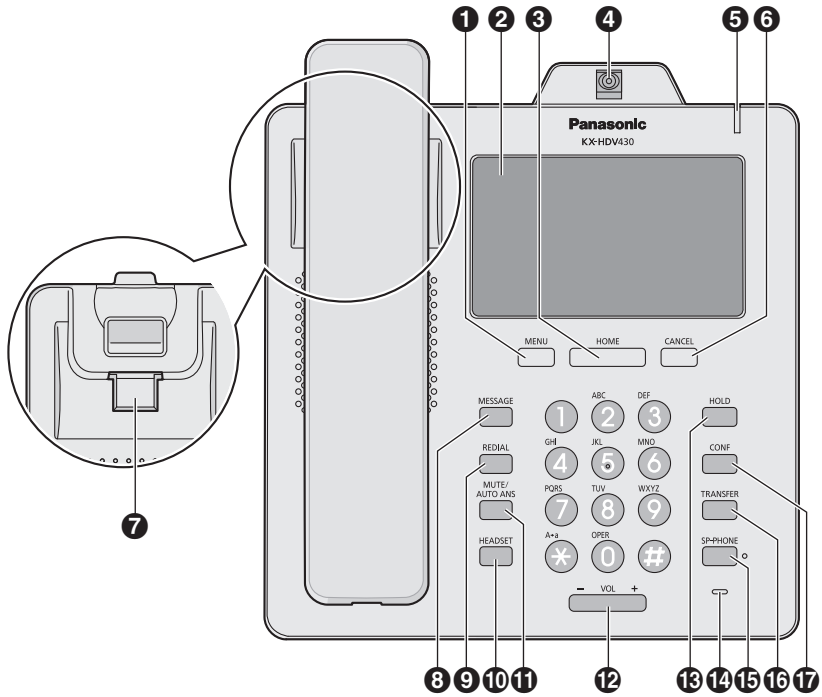

Before Operating the Telephones

KX-HDV430C

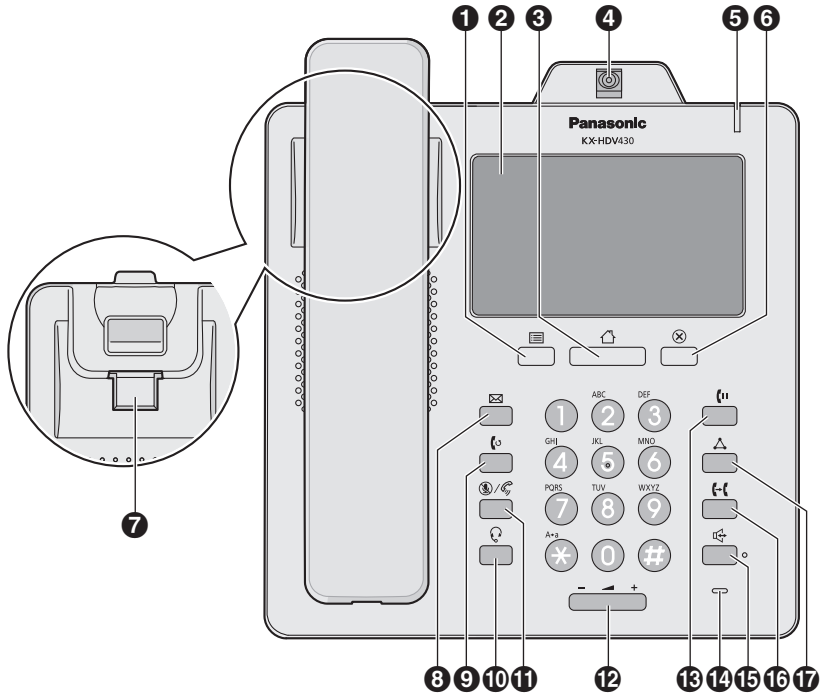

KX-HDV20NE/KX-HDV20X/KX-HDV20RU/KX-HDV20

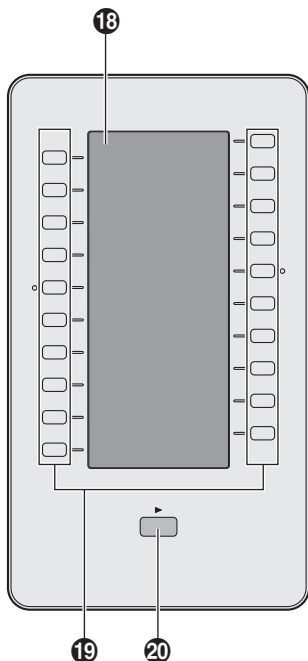

1 /MENU

Display the menu. The contents of the menu differ depending on the settings and mode. For details about the settings displayed in the menu, see “Settings Displayed in the Menu”, Page 84.

2 Touch display

For details about the display, see “Display”, Page 19.

3 /HOME

Return to the Home screen.

Depending on the mode, the screen you return to and other operations differ. Pressing this key in standby mode displays function keys 1 to 4.

4 Camera

Used for video communication. The other party can view the video feed from your camera if they have a compatible device. You can tilt the camera’s angle by turning the wheel on the back of the camera. For details about the camera, see “Adjusting the Camera Angle”, Page 75.

5 Ringer/Message Waiting/Missed Call Indicator

The lamp flashes when you are receiving a call, or when you have an unread message or missed call notification.

6 /CANCEL

Used to cancel the selected item.









7 Handset Hook

Keeps the handset stable when the unit is mounted on a wall. For details, see “Hooking the Handset”, Page 81.

8 /MESSAGE

Used to access your voice mailbox.

Before Operating the Telephones

- 9 /REDIAL
Used to redial the last dialed number.
 - 10 /HEADSET
Used for performing headset operations.
 - 11 /MUTE/AUTO ANS
Used to receive an incoming call in hands-free mode or mute the microphone/handset during a conversation.
 - 12 /VOL
Used to adjust the ringer/receiver volume.
 - 13 /HOLD
During talking, used to place a call on Hold. In standby mode, used to retrieve a call on hold if there is one.
 - 14 **Microphone**
Used for hands-free conversation.
 - 15 /SP-PHONE
Used for performing hands-free operations.
 - 16 /TRANSFER
Used to transfer a call to another party.
 - 17 /CONF
Used to establish a multiple-party conversation.
 - 18 **Self-labeling LCD**
For details about the self-labeling LCD, see "KX-HDV20 Self-labeling LCD", Page 23.
 - 19 **DSS Keys [01–20]*1**
Used to perform the assigned function. When a key is assigned as a Line key, it can be used to confirm the status of the line. The key name that you assigned is displayed on the KX-HDV20's self-labeling LCD. For details about changing the DSS keys, see "Changing the Function Keys (Program Keys and DSS Keys)", Page 66.
 - 20 **DSS Page Key*1**
Used to switch the page of DSS keys displayed on the KX-HDV20 self-labeling LCD. There are two pages of 20 DSS keys.
- *1 These keys can be used when you connect a KX-HDV20 to the unit.
"DSS" stands for "Direct Station Selection".

The Display and Icons

Display

[Example]



1 Status bar

Displays the number and name of the telephone line, status icons, communication method icons, the mute icon, and the time.

On the settings screens, the screen title is displayed.

Tapping this area has no effects.

If 4 or more icons are displayed, the status bar will alternate between 2 display patterns.

2 Operation area

Displays the screens for all functions. Tapping here operates the telephone.









The touch display responds only to tap operations.

The icons for the top screen change depending on the phone's status.

















Icons displayed in the status bar

Suffix		Meaning
(none)/C	NE/RU/SX/X	
		Handset in use
		Headset in use
		Using speakerphone
		Off-hook monitor
		Training mode
		Fwd enabled
		DND enabled
		Auto answer enabled
		Mute

Before Operating the Telephones













Suffix		Meaning
(none)/C	NE/RU/SX/X	
		Ringer off
		Call on hold
		Call on hold in a Call Park zone
		Conference hold
		ECO mode enabled
		Receiving an incoming call
		Network error
		Bluetooth® connection established
		Bluetooth connection not established

Operation icons displayed in the operation area







Icon	Meaning
	New message (Top menu screen)
	Missed call (Top menu screen)
	Phonebook lock (Top menu screen)
	Back
	Personal Phonebook
	Shared Phonebook
	Add contact
	Enter delete mode
	Execute delete
	Enter edit mode
	Select all items
	Save
	Cancel
	Scroll up
	Scroll down
	Scroll left (general screens) Pan the Camera left (Network Camera viewer)

Icon	Meaning
	Scroll right (general screens) Pan the Camera right (Network Camera viewer)
	Tilt the Network Camera up (Network Camera viewer)
	Tilt the Network Camera down (Network Camera viewer)
	Move the cursor left
	Move the cursor right
	Backspace
	Pause
	Selected
	Unselected
	Search
	Category
	Missed calls
	Incoming calls
	Outgoing calls
	Network Camera alarm
	New missed call
	Confirmed missed call
	Number of unchecked messages/notifications
	Unchecked message/notification
	Checked message/notification
	Call Forwarding
	Do Not Disturb
	Anonymous call
	Anonymous call rejection
	Change a message between read and unread
	Go on-hook
	Mute
	Ringer off

Before Operating the Telephones

Icon	Meaning
	Move to the camera's home position (Network Camera viewer)
	Zoom in (Network Camera viewer, Communication Camera)
	Zoom out (Network Camera viewer, Communication Camera)
	Paging (Network Camera viewer)
	Switch the screen mode (during a video call)
	Pause sending your video feed (during a video call)
	Resume sending your video feed (during a video call)
	Display the function keys (during a video call)
	Rotate the image 90 degrees (Visual Voice Mail)
	Unlock a door (Communication Camera)
	Voice call (Communication Camera)
	Increase a setting's value
	Decrease a setting's value

Character input icons

Suffix		Meaning
(none)/C	NE/RU/SX/X	
		Latin character entry mode
		Numeric character entry mode
		Special character (Extended 1) entry mode
		Special character (Extended 2) entry mode
		Greek character entry mode
		Cyrillic character entry mode

Note

- Example images of the display in this manual are samples only, and the actual screen on your phone may vary in color and/or appearance.
- Descriptions of icons displayed with text are not included.

KX-HDV20 Self-labeling LCD

[Example]

KX-HDV20 (Optional model)*1

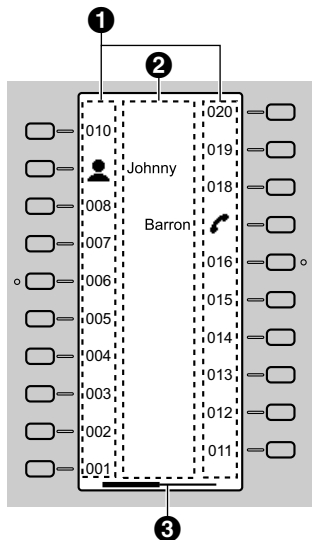

*1 Up to 40 keys (20 keys × 2 pages) can be registered.



1 Pictographs

Pictograph	Meaning	Pictograph	Meaning
(Number)	No function is assigned.		Phonebook
	One Touch Dial		Call History
	Line		
Line Status	Wrap Up		
	BLF		Directed Call Pickup
	ACD (Login/Logout)		
	Hoteling/Hospitality	Transfer	
	Conference		
			Park
	Park Retrieve		
		Network Camera	

2 Function Label Name

Before Operating the Telephones

③ Page Information

Indication	Meaning
	Displaying page 1
	Displaying page 2

Note

- Images of the display in this manual are samples only. The actual screen on your phone may vary in color and/or appearance.

Main Menu

The following menu items are displayed in standby mode.

Function

Displays the function keys.

See “Changing the Function Keys (Program Keys and DSS Keys)”, Page 66.

Voice Message

Used to access your voice mailbox.

See “Listening to Voice Mail Messages”, Page 44.

FWD/DND*1

Sets the Call Forwarding or Do Not Disturb features.

See “Call Forwarding/Do Not Disturb”, Page 44.

Paging*1

Makes a Multicast Voice Paging call.

See “Making a Multicast Voice Paging call”, Page 34.

Call History

Used to display the call log.

See “Incoming/Outgoing Call Log”, Page 26.

Phonebook

Used to access the Personal or Shared Phonebook.

See “Using the Phonebook”, Page 46.

Line Status

Used to display the status of each line on the LCD.

See “Checking the Line Status”, Page 54.

Basic Settings

Used to access the basic settings menu.

See “Changing the Basic Settings”, Page 70.

System Settings

Used to access the system settings menu.

See “Changing the System Settings”, Page 71.

Advanced Settings

Used to access the advanced settings menu.

See “Changing the Advanced Settings”, Page 71.

Network Camera

Used to access the Network Camera feature.

See “Network Camera”, Page 56.

Comm. Camera

Used to access the Communication Camera feature.

See “Communication Camera”, Page 63.

Call Center/Call Centre*1

Used to access the Call Center feature.

Before Operating the Telephones

Presence*1

Used to access the Presence feature.

Application*1

Used to access the Application feature.

*1 This item is displayed only when the feature is enabled. Contact your administrator for further information.

Adjusting the Volume

Adjusting the Receiver/Speaker/Headset Volume

1. Press [−]/[+] volume key: Adjust the volume during a conversation.

Note

- Both receiver volume and headset volume are adjusted in training mode. See "Training Mode", Page 36.

Adjusting the Ringer Volume or Turning the Ringer Off

[In standby mode]

1. Press [−]/[+] volume key: Adjust the ringer volume.
2. Tap "OK".

Note

- For details about setting the ringer pattern, see "Incoming Option", Page 85.

Adjusting the Ringer Volume or Turning the Ringer Off while Ringing

While receiving a call, do the following to adjust the ringer volume or turn the ringer off:

Note

- If you attach a headset while receiving an incoming call, ringing will be heard from the speaker.

To adjust the ringer volume

1. Press [−]/[+] volume key: Adjust the ringer volume.

Note

- The adjusted volume level will also be used for subsequent calls.
- The volume can also be adjusted in the pop-up window.





To turn the ringer off

1. Tap .

Incoming/Outgoing Call Log

Displaying the Incoming/Outgoing Call Log

[In standby mode]

1. Tap  /  → "Call History"
2. Missed Call Log: Tap 
Incoming Call Log: Tap 

Outgoing Call Log: Tap .

Making a call using the Incoming/Outgoing Call Log





See "Using the Incoming/Outgoing Call Log", Page 32.

Storing an item using the Incoming/Outgoing Call Log

See "Storing an Item Using the Incoming or Outgoing Call Log", Page 48.

Deleting Items in the Incoming/Outgoing Call Log

[When the Incoming or Outgoing Call Log is displayed]

1. Tap .
2. Tap  /  : Tap the check boxes of the items you want to delete.
3. Tap . → "OK"

Note

- You can select all items in the list by tapping .

Setting the Password

The telephone password is not set by default. You must register a password (4 digits) before use. You cannot use the following features without setting a password:





- Phonebook lock (See "Locking the Phonebook", Page 52).

Note

- To avoid unauthorized access to this product:
 - Set a password that is random and cannot be easily guessed.
 - Change the password regularly.
- Make a note of the password so that you will not forget it.

To set

[In standby mode]

1. Tap  /  → "Basic Settings"
 2. Tap  /  → "Other Option"
 3. Tap "Change Password".
 4. Enter a new password (4 digits [0–9]).*1 → "OK"
 5. Verify the password by entering it again as in step 4.
- *1 If a password is already set, you will need to enter the old password first.

Selecting the Display Language

You can select the language displayed on your LCD.

[In standby mode]

1. Tap  /  → "Basic Settings"
2. Tap  /  → "Display Option"
3. Tap  /  → "Language"

Before Operating the Telephones

4. Tap  /  : Select a language. → "OK"

- For a list of the languages that can be selected, see "Display Option", Page 87.













Entering Characters

You can enter characters and digits using the dialing keys.

You can select one of the character modes by tapping the desired character mode while entering a name.





For available characters, see "Character Mode Table", Page 82.

To change the character mode while editing a name in the phonebook, tap the desired character mode.

Model No.	Character Mode
KX-HDV430NE, KX-HDV430X, KX-HDV430SX	 (Latin)  (Numeric)  (Greek)  (Extended 1)  (Extended 2)
KX-HDV430RU	 (Cyrillic)  (Numeric)  (Latin)  (Extended 1)  (Extended 2)
KX-HDV430, KX-HDV430C	 (Latin)  (Numeric)  (Extended 1)

Example: To enter "Anne" in Latin Mode.

 →  →  →  →  →  →  →  →  →  → 

- To switch between uppercase and lowercase, press .
- To enter a character located on the same dialing key as the previous character, move the cursor by tapping , then enter the desired character.
- If you enter a different character by mistake, tap  or  to highlight the character, tap  to delete it, then enter the correct character.
- To clear an entire line, tap "Delete".

Bluetooth Headset

Before using a Bluetooth headset, you need to register it to the unit.

Registering a Bluetooth headset

Set the headset to pairing mode by following the instructions in the headset's documentation.





1. Tap  /  → "Basic Settings"
2. Tap  /  → "Bluetooth Headset"
3. Tap "Add New Device".
4. Enter the PIN.*1 → "OK"

*1 For more information regarding the PIN, see the documentation for your headset.



Deregistering a Bluetooth headset

1. Tap  /  → "Basic Settings"
2. Tap  /  → "Bluetooth Headset"
3. Tap "Registration". → "Yes"

Connecting a Bluetooth headset

1. Tap  /  → "Basic Settings"
2. Tap  /  → "Bluetooth Headset"
3. Tap "Connection". → "On" → "OK"

Disconnecting a Bluetooth headset

1. Tap  /  → "Basic Settings"
2. Tap  /  → "Bluetooth Headset"
3. Tap "Connection". → "Off" → "OK"



Note

- During a conversation using a Bluetooth headset, the receiver volume can be adjusted using the volume key on either the headset or the main unit.
- The connection status can be viewed on the status bar.
- Signals are transmitted between the unit and the Bluetooth headset using radio waves. For maximum distance and noise free operation, it is recommended that the unit be situated away from electrical appliances such as faxes, radios, personal computers, and microwaves.
- Privacy of communications may not be ensured when using the unit.

Basic Operation

Going off-hook

In this manual, when you see the phrase "off-hook", you can do any of the following:



- Lift the corded handset off its cradle.
- Press /[SP-PHONE] while the corded handset is on its cradle. This enables hands-free mode.
- Press /[HEADSET] when using a headset.
- Tap the corresponding function key to select a line.*1

*1 When a function key is assigned as a Line key or Line Status key, this feature is available.

Before Operating the Telephones

Going on-hook

In this manual, when you see the phrase "on-hook", you can do any of the following:

- Replace the corded handset on its cradle.
- Press /[SP-PHONE] when you are in hands-free mode.
- Press /[HEADSET] when using a headset.
- Press /[CANCEL].
- Tap "Off".

Making Calls

- You can select whether to make a voice call or a video call. If you make a call by going off-hook, the type of call that is established depends on the "Call Mode" setting (Page 88).
 - You can confirm that the number was dialed correctly before calling (Predialing) by entering the number, then going off-hook.
 - If an outside call is received from a phone number stored in the phonebook, the number and name of the caller will be displayed in the call log.
 - To cancel dialing, press /[CANCEL].
 - To insert a 3 second pause between phone numbers, tap "Pause".*1
It is useful when you want to operate voice mail service without listening to pre-recorded announcement, for example. Repeat as needed to create longer pauses.
 - The "+" symbol (international dialing code) can be entered by pressing and holding the "☎" key.
- *1 This icon is displayed only when configured on the telephone. Contact your administrator for further information.
-

Basic Calling

Calling by Dialing

[In standby mode]

1. Go off-hook.
2. Dial the outside party's number.
3. Tap "Voice Call" to make a voice call.
Tap "Video Call" to make a video call.
4. Go on-hook to end the call.

Note

- You can use a specific line by pressing a function key assigned to a line (see "Changing the Function Keys (Program Keys and DSS Keys)", Page 66) or by using the Line Status screen (see "Checking the Line Status", Page 54).
- To dial a new number without going on-hook, follow the procedure below.

[During a Conversation]

1. Press /[MENU].
 2. Tap "Flash"/"Recall".
-

Predialing

[In standby mode]

1. Dial while still on-hook.
2. Do one of the following:
 - Go off-hook.*1
 - Tap "Voice Call" to make a voice call.
 - Tap "Video Call" to make a video call.

*1 The type of call that is established depends on the "Call Mode" setting.

Easy Dialing

Making a call using the redial list

The last phone number dialed is stored in the redial list (32 digits max.).

[In standby mode]

1. Press /[RE-DIAL].
2. Go off-hook.

Note

- The type of call (voice or video) is the same as the previous outgoing call.
- If this procedure is performed during a conversation, the conversation will end, and then redialing is performed.



Hot Key Dialing

You can assign a phone number to each number key and then access the desired phone number by simply pressing and holding the assigned number key.

1. Press and hold the dialing key (0–9) assigned as a Hot Key for more than 1 second.
2. Do one of the following:
 - Go off-hook.*1
 - Tap "Phone Number".
 - Tap "Voice Call" to make a voice call.
 - Tap "Video Call" to make a video call.

*1 The type of call that is established depends on the "Call Mode" setting.

Note

- While the Hot Key's information is displayed, you can tap  or  to select another Hot Key number.
- If Hot Key dialing is set to "Auto", a Hot Key number can also be dialed by pressing and holding the assigned dialing key for a specified number of seconds. For details, see "Selecting the Type of Hot Key Dialing", Page 66.
- For details about assigning Hot Keys, see "Assigning Hot Keys From Phonebook", Page 65.

Using the Hot Line

If your administrator has configured this function, you can make a call to a registered phone number automatically. Contact your administrator for further information.







[In standby mode]

1. Go off-hook.

Using the Incoming/Outgoing Call Log

Using the Incoming Call Log





[In standby mode]

1. Tap  /  → "Call History"
2. Missed Call Log: Tap .
Incoming Call Log: Tap .
3. Tap  /  : Select an incoming call log.

4. Do one of the following:
 - Go off-hook.*1
 - Tap "Voice Call" to make a voice call.
 - Tap "Video Call" to make a video call.
- *1 The type of call that is established depends on the "Call Mode" setting.

Using the Outgoing Call Log





[In standby mode]

1. Tap  /  → "Call History"
 2. Tap .
 3. Tap  /  : Select an outgoing call log.
 4. Do one of the following:
 - Go off-hook.*1
 - Tap "Voice Call" to make a voice call.
 - Tap "Video Call" to make a video call.
- *1 The type of call that is established depends on the "Call Mode" setting.

Using the Phonebook

Using the Personal Phonebook

[In standby mode]





1. Tap  /  → "Phonebook"
 2. Search for the desired item.*1
 3. Tap  /  : Select the desired item.
 4. Select the desired phone number.
 5. Do one of the following:
 - Go off-hook.*2
 - Tap "Phone Number".
 - Tap "Voice Call" to make a voice call.
 - Tap "Video Call" to make a video call.
- *1 For details, see "Searching for an Item in the Personal Phonebook", Page 51.
 *2 The type of call that is established depends on the "Call Mode" setting.

Note

- If the Personal Phonebook is not permitted, this feature cannot be used. Contact your administrator for further information.

Using the Shared Phonebook

[In standby mode]

1. Tap  /  → "Phonebook"
2. If "Phonebook" is displayed as the title, tap .*1
3. Search for the desired item.*2
4. Tap  /  : Select the desired item.
5. Select the desired phone number.
6. Do one of the following:
 - Go off-hook.*3
 - Tap "Phone Number".
 - Tap "Voice Call" to make a voice call.
 - Tap "Video Call" to make a video call.

Making Calls

- *1 If only Shared Phonebook is permitted, this step is skipped.
- *2 For details, see "Searching for an Item in the Shared Phonebook", Page 53.
- *3 The type of call that is established depends on the "Call Mode" setting.

Note

- If the Shared Phonebook is not permitted, this feature cannot be used. Contact your administrator for further information.

Making a Multicast Voice Paging call

When you make a paging call, the voice will be heard through the speaker phone of the other telephones.

[In standby mode]

1. Tap  /  → "Paging"*1



2. Select a desired channel group.*2

3. Go off-hook, or tap "Call".

*1 Paging is available only when the feature is enabled. Contact your administrator for further information.

*2 If there is only 1 channel group, paging will start immediately.

Receiving Calls

- If you receive an incoming video call, you can select whether to receive that call as a video call. If you go off-hook, the type of call that is established depends on the "Call Mode" setting (Page 88).
- You can select the ringer for each type of incoming call. See "Incoming Option", Page 85.
- You can also use Auto Answer to answer a call. In standby mode, press  / /[MUTE/AUTO ANS] to toggle Auto Answer on or off. See "Answer Option", Page 86.
- The volume of the ringer can be adjusted, or turned off. See "Adjusting the Ringer Volume or Turning the Ringer Off", Page 26.
- If you attach a headset while receiving an incoming call, ringing will be heard from the speaker. Depending on the headset, ringing may be heard through the headset.
- Up to 24 calls can be received at the same time. The 25th caller will hear a busy tone.

Caller ID

If an outside call that contains Caller ID information (a caller's name and telephone number) is received, this information will be logged in the Incoming Call Log and displayed on the LCD.

If a call from a number matching a number entered in the phonebook is received, the name registered in the phonebook for that number will be displayed along with the number.

If caller information is sent by the phone system and there is also information stored in the phonebook for the same number, the information stored in the phonebook will be displayed.

Answering Calls

To answer an incoming call

1. Do one of the following:
 - Go off-hook.*1
 - Tap "Voice Call" to make a voice call.
 - Tap "Video Call" to make a video call.*2
- *1 When the handset is already off-hook, press and release the hook switch. The type of call that is established depends on the "Call Mode" setting.
- *2 This option is available if the incoming call is a video call.

Note

- When a call is received while another call is on hold, pressing and releasing the hook switch will answer the call.

To answer an incoming call on a specific line when receiving multiple incoming calls

[While receiving a call]

1. Tap "Line".
2. Tap  /  : Select an incoming call.

To reject an incoming call

1. While an incoming call is ringing, tap "Reject".
2. The call will be rejected, and the telephone will return to standby mode.

Note

- Calls from specific numbers can be automatically rejected. For details, see "Incoming call barring (Caller ID service users only)", Page 69.

Hands-free Mode

In hands-free mode, you can talk and hear the other party in a conversation without using the handset. This mode is useful for performing other tasks during a conversation, such as writing.

Enabling hands-free mode

If you press \star /[SP-PHONE] in standby mode, you can enable hands-free mode.

During a conversation using a headset, you can enable hands-free mode by pressing \star /[SP-PHONE].

Canceling hands-free mode

You can cancel hands-free mode in one of the following ways:

- During a conversation in hands-free mode, go off-hook.
 - While you are talking in hands-free mode and a headset is attached to the unit, press \mathcal{Q} /[HEADSET] to continue the conversation using the headset.
-

Training Mode

In training mode, you can hear the other party in a conversation from both a headset and the handset. This mode is useful for training an operator. While the operator talks to the other party on the headset, a trainer also can listen to the other party on the handset and teach the operator how to respond to the caller.

Starting training mode

[During a conversation using a headset]

1. Go off-hook by lifting the handset off its cradle.
 2. Press \mathcal{Q} /[HEADSET] to start training mode.
-

Ending training mode

1. Replace the handset on its cradle.
The conversation will continue using the headset.

During a Conversation

Video Call Screen

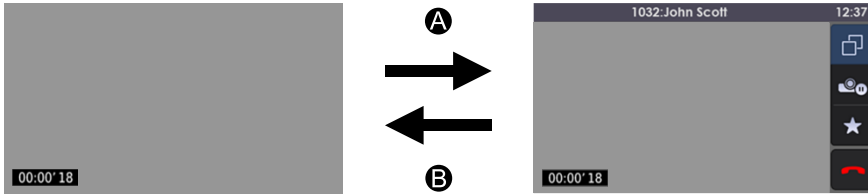

A : Tap the screen.

B : After a certain amount of time.

Normally, the video feed is displayed in full screen. If you tap the screen, the status bar and operation area are displayed. After a certain amount of time, the display returns to full screen. (Tap the screen again to show the status bar and operation area.)

Video Call Options

During a video call, you can switch the screen mode and pause/resume sending your video feed.

Switching the screen mode

[During a video call]

1. Tap the screen.
2. Tap .

The screen mode cycles through normal mode (PiP off) → normal mode (PiP on) → split mode.

During a Conversation

[Example]

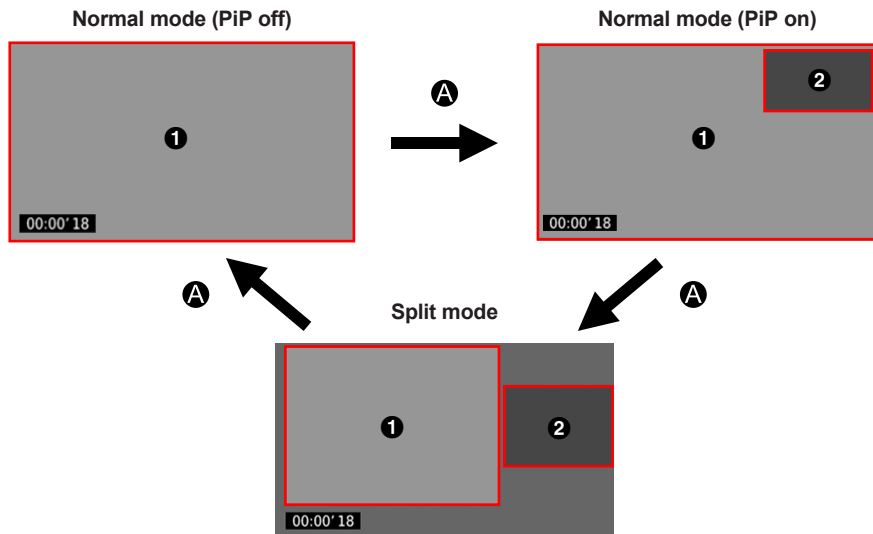

A : Tap the screen → Tap .

- 1** The other party's video feed
- 2** Your video feed

In normal mode, you can toggle the display of your video feed (Picture-in-Picture).

Turning PiP on and off

[During a video call]

1. Press /[MENU].
2. Tap "PiP".
3. Tap "On" or "Off". → "OK"

Pausing and resuming sending your video feed

To pause sending your video feed

[While sending your video feed]

1. Tap the screen.
2. Tap .

 is displayed on your video feed, and sending of your video feed is stopped.

To resume sending your video feed

[While your video feed is paused ( is displayed)]

1. Tap the screen.
2. Tap .

Your feed will be displayed, and sending of your feed will resume.

Switching the call type during a conversation

To switch from a voice call to a video call

[During a voice call]

1. Tap "Video Call".

To switch from a video call to a voice call









[During a video call]

1. Press /[MENU].
 2. Tap "Voice Call".
-



Adjusting the Quality of the Picture

You can adjust the quality of your video feed in standby mode or during a video call.

[In standby mode]

1. Tap  /  → "Basic Settings"
2. Tap  /  → "Video Options"
3. Tap  /  → "Camera Settings"
4. Tap the item you want to adjust.
5. Tap  /  : Change the value of the item. → "OK"
6. Tap "Save".

[During a video call]

1. Press /[MENU].
2. Tap "Picture Quality".
3. Tap the item you want to adjust.
4. Tap  /  : Change the value of the item. → "OK"
5. Tap "Save".

Note

- You can adjust the following values:

Brightness	Default: 3
Saturation	Default: 3
Contrast	Default: 2
Sharpness	Default: 3
Anti-flicker	Default: 50Hz

- You can reset the values to their defaults by tapping "Reset".
-

Transferring a Call (Call Transfer)

You can transfer a call to another destination (extension or outside party).

Note

- Operation for this feature may differ depending on the telephone's configuration. If the following procedure does not work, contact your administrator for further information.
-

To transfer

1. Press /[TRANSFER] during a conversation.
-

During a Conversation

2. Dial the party you want to transfer to.*1 →
Tap "Voice Call" to make a voice call.
Tap "Video Call" to make a video call.
 3. Wait until the other party answers to announce the transfer.
 4. Go on-hook.
- *1 You can also select a phone number from the call history or the phonebook.

Note

- To return to the call before the transfer destination answers, press ⊗/[CANCEL].
-

To do a blind transfer

1. Tap "Blind"*1 during a conversation.
 2. Dial the party you want to transfer to.*2 →
Tap "Voice Call" to make a voice call.
Tap "Video Call" to make a video call.
- *1 If blind transfers are not permitted, this icon is not displayed. Contact your administrator for further information.
- *2 You can also select a phone number from the call history or the phonebook.
-

Holding a Call

You can put a call on hold by holding the call at your extension.

Note

- Operation for this feature may differ depending on the telephone's configuration. If the following procedure does not work, contact your administrator for further information.
-

Holding

To hold the current call

1. Press /[HOLD].

Note



- When a function key is assigned as a Line key, if you press a Line key other than the one for the current call, the call is put on hold or is disconnected depending on the Automatic Call Hold settings. For details, contact your phone system dealer/service provider.

To retrieve a call on hold at your line

[When one line is on hold]

1. Press /[HOLD].

[When two or more lines are on hold]

1. Press /[HOLD].
2. Tap  /  : Select a line on hold.

Note

- When a call is received while another call is on hold, pressing and releasing the hook switch will answer the call.
 - If a function key is assigned as a Line key, and a call is on hold on that line, you can retrieve the call on hold by following the step below.
 1. Press the corresponding function key.
-

Holding in a System Parking Zone (Call Park)

You can use this feature as a transferring feature.

When Call Park is permitted, the "Park" icon is displayed. However, the Call Park feature number must be set beforehand. Also, depending on your phone system, you may need to enter a parking zone number to retrieve a parked call. The feature depends on your phone system. Contact your administrator for further information.

To set



1. Press /[MENU] during a conversation.
2. Tap "Park".

To retrieve (Call Park Retrieve)

[In standby mode]

1. Enter the Call Park Retrieve feature number.
2. Go off-hook.





Note

- Depending on the telephone system,  may be displayed in the status bar. In this case, you can retrieve the call by pressing /[MENU] and then tapping "Park". However, to retrieve a parked call using the icon, the Call Park Retrieve feature number must be set beforehand. Contact your administrator for further information.

Talking to Two Parties Alternately (Call Splitting)

When talking to one party while the other party is on hold, you can swap the calls back and forth (alternately).

To alternate between the parties leaving one party on hold temporarily

1. Press /[HOLD] during a conversation.
2. Dial the other party's extension number.
 - Tap "Voice Call" to make a voice call.
 - Tap "Video Call" to make a video call.
3. Talk to the other party.
4. During a voice call: Tap "Line Status".
During a video call: Press /[MENU]. → Tap "Line Status".
5. Tap  /  : Select the original party.
6. Talk to the party.



Three-party Conference

During a conversation, you can add an additional party to your call and establish a conference call.

Note

- Your phone system may support advanced conference features, such as conference calls with four or more parties. In this case, the procedures for handling a conference call may be different from those explained in this section. For details, contact your phone system dealer/service provider.

Making a Conference Call

1. Press /[CONF] during a conversation.
 2. Dial the party you want to transfer to.*1 →
 - Tap "Voice Call" to make a voice call.
 - Tap "Video Call" to make a video call.
 3. Press /[CONF] after the other party has answered.
- *1 You can also select a phone number from the call history or the phonebook.





During a Conversation

Note

- When you make a video conference call, images of the other two parties are displayed at the top of the screen.

Removing a Party from the Conference

During a conference, you can remove other parties from the conference. However, this operation is available only during conference calls you initiate.

1. During a conference call, press /[HOLD].
2. Press /[HOLD] again to show the conference parties on hold.
3. Tap  / : Select the party to remove.
4. Talk to the party and go on-hook to end the call.
5. Press /[HOLD].

Ending a Conference Call

To end the conference call, go on-hook.

Mute

You can disable the microphone or the handset to consult privately with others in the room while listening to the other party on the phone through the speaker or the handset.

To set/cancel

1. Press  / /[MUTE/AUTO ANS].

Note

- When the  icon is displayed in the status bar, Mute is on.
- During Mute, even if you switch from/to speakerphone, Mute will continue.
- During Mute, even if you connect/disconnect a headset, Mute will continue.

Call Waiting

During a conversation, if a second call arrives, you will hear a call waiting tone. You can answer the second call by disconnecting or holding the current call.

This is an optional telephone company service. You can receive a call waiting tone and the caller's information. For details, contact your phone system dealer/service provider.

To disconnect the current call and then talk to the new party

1. Go on-hook.
2. Go off-hook.

To hold the current call and then talk to the new party

1. Tap "Voice Call" to make a voice call.
Tap "Video Call" to make a video call.
Tap "Camera" to make a voice call with Communication Camera.

Off-hook Monitor

During a two-party conversation with the corded handset, you can allow other people to listen to the conversation through the speaker while you continue the conversation using the corded handset.

To start/To cancel

1. Press /[SP-PHONE] during a conversation.

Note







- When off-hook monitor is active, replacing the corded handset to its cradle enables hands-free mode.

Call Forwarding/Do Not Disturb





You can have incoming calls automatically forwarded to another destination. You can also have incoming calls rejected (Do Not Disturb).

To access the FWD/DND settings

[In standby mode]

1. Tap  /  → "FWD/DND"
 2. If the unit has multiple lines, tap  /  to select the desired line.
 3. Tap  /  : Select the type of FWD or DND setting to apply.
The settings are as follows:
 - DND: Enable Do Not Disturb
(All incoming calls are automatically rejected.)
 - Fwd(All): Enable Forward All Calls
(All incoming calls are forwarded.)
 - Fwd(Busy): Enable Forward Busy
(Incoming calls are forwarded only when your extension is in use.)
 - Fwd(NA): Enable Forward No answer*1
(An incoming call is forwarded if you do not answer the call within a certain amount of time.)
 4. (Fwd) Tap "On/Off": Select On or Off. → "Next" or "OK"
(DND) Tap "On/Off": Select On or Off. → "OK"
 5. If a Forward setting is selected, enter a new forward phone number, or confirm and modify a previously set forward phone number. → "OK"
- *1 Tap "Ring Count" to specify the number of rings before the call is forwarded.





Note

- When Call Forwarding and/or Do Not Disturb is enabled,  /  and/or  /  appears in the status bar in standby mode.
 - This feature is only available when enabled. Contact your administrator for further information.
-

Listening to Voice Mail Messages

When you receive a voice message,  is displayed, or the Message Waiting indicator flashes slowly. You can check your new messages by accessing your mailbox.

[In standby mode]

1. Press /[MESSAGE] or tap "Voice Message".
 2. Tap  /  : Select the line on which  is displayed.
-

Xsi Visual Voice Mail

With the Voice Messaging service of Broadsoft-Xsi, you can receive detailed information about messages from the Xsi server. The following operations are available:

- Download messages
- Mark messages as read or unread
- Delete messages

For details, contact your phone system dealer/service provider.

The following limitations apply:

- Video messages are not supported.
- Voice message format: WAV only (MP3 is unavailable)
- Voice message recording time: Maximum 5 minutes

Using the Phonebook

The KX-HDV430 has 2 types of phonebook.

1. Personal Phonebook

This phonebook is stored in the telephone.

2. Shared Phonebook

If your telephone company provides a shared phonebook service, you can use it. For details, contact your phone system dealer/service provider.

	Personal Phonebook	Shared Phonebook
Storing new items	✓	—
Editing stored items	✓	—
Deleting store items	✓	—
Searching the phonebook by name	✓	✓
Searching the phonebook by category	✓	—
Phone numbers for each item	Up to 5	Up to 5*1
Private Ring	✓	—
Locking the phonebook	✓	—

*1 This number depends on the service being used.

Using the Personal Phonebook

You can store up to 500 items (5 phone numbers per item, max. 2500 phone numbers) in the telephone along with names for easy access. You can also set unique ringer patterns for different categories to identify incoming calls. All phonebook items are stored in alphabetical order. For security purposes, you can lock the phonebook.

- To search for an item in the phonebook, see “Searching for an Item in the Personal Phonebook”, Page 51.
- To refer to another phonebook that can contain more than 500 items via the network, see “Using the Shared Phonebook”, Page 53.

Note

- We recommend that backups are made of the phonebook data, in case the data becomes unrecoverable due to product malfunction.
- You can store information for a maximum of 500 contacts.
- Phonebook data can be imported and exported. Contact your administrator for further information. A name can have up to 24 characters. A telephone number can have up to 32 digits.

Private Ring

You can organize entries in the phonebook into one of 9 Private Ring Categories. It is possible to set a different ringer pattern*1 for each category. When the displayed Caller ID*2 matches a phone number or name stored in the phonebook, the telephone rings according to the Private Ring Category settings.









*1 For Ringer patterns, see “Incoming Option”, Page 85.

*2 For Caller ID information, see “Caller ID”, Page 35.

Storing an Item in the Personal Phonebook

Storing a New Item

[In standby mode]

1. Tap  /  → "Phonebook"
2. Tap . → The number of remaining entries is displayed. → "OK"
3. Tap "<Enter Name>".
4. Enter a name (max. 24 characters). → "OK"
5. Tap "<Enter Phone No>".
6. Enter the phone number (max. 32 digits). → "OK"
7. Repeat steps 5 and 6 to add additional phone number types.
8. Tap "Category Off".
9. Tap  /  : Select a category. → "OK"
10. Tap  of the phone number you want to use as the entry's default number.
The color of the icon for the selected item changes to .
11. Tap .

Note

- Steps 8 and 9 can be omitted if you do not want to assign a category.
- Step 10 can be omitted if you do not want to assign a default number. (The first number entered for an entry will automatically be assigned as the default number.)
- The valid digits are "0" through "9", "✳", "†", "+", "P".
- If an item with the same name and number exists, the new information added will be merged with the existing item.

Using the Phonebook





- To enter characters, see "Entering Characters", Page 28.

Storing an Item Using the Dialing

You can dial a number first and then add it as a phonebook entry.

To add a new entry:

[In standby mode]







1. Dial a number.
2. Tap "Phonebook".
3. Tap "Create New Item". → "OK"
4. The number of remaining entries is displayed. → "OK"
5. Tap "<Enter Name>".
6. Enter a name (max. 24 characters). → "OK"
7. Tap "Category Off".
8. Tap  /  : Select a category. → "OK"
9. Tap  of the phone number you want to use as the entry's default number.
The color of the icon for the selected item changes to .
10. Tap .

Note

- Steps 7 and 8 can be omitted if you do not want to assign a category.
- Step 9 can be omitted if you do not want to assign a default number. (The first number entered for an entry will automatically be assigned as the default number.)
- The valid digits are "0" through "9", "✳", "†", "+", "P".
- If an item with the same name and number exists, the new information added will be merged with the existing item.
- To enter characters, see "Entering Characters", Page 28.

To add the phone number to an existing entry:

[In standby mode]

1. Dial a number.
2. Tap "Phonebook".
3. Tap "Add Number". → "OK"
4. Tap .
5. Enter the name or the first character(s) of the desired name. → "OK"
6. Tap  /  : Select the desired name.
7. Tap  of the phone number you want to use as the entry's default number.
The color of the icon for the selected item changes to .
8. Tap .

Note







- Step 7 can be omitted if you do not want to assign a default number. (The first number entered for an entry will automatically be assigned as the default number.)
- The valid digits are "0" through "9", "✳", "†", "+", "P".
- If an item with the same name and number exists, the new information added will be merged with the existing item.
- To enter characters, see "Entering Characters", Page 28.

Storing an Item Using the Incoming or Outgoing Call Log

You can add a number listed in the Incoming or Outgoing Call Log to the Personal Phonebook.

To add a new entry:









[In standby mode]

1. Display the Incoming or Outgoing Call Log. For details, see "Incoming/Outgoing Call Log", Page 26.
2. Tap  /  : Select the desired item.
3. Tap "Save Phonebook".
4. Tap "Create New Item". → "OK"
5. The number of remaining entries is displayed. → "OK"
6. Tap "<Enter Name>".
7. Enter a name (max. 24 characters). → "OK"
8. Tap "Category Off".
9. Tap  /  : Select a category. → "OK"
10. Tap  of the phone number you want to use as the entry's default number.
The color of the icon for the selected item changes to .
11. Tap .

Note

- Steps 8 and 9 can be omitted if you do not want to assign a category.
- Step 10 can be omitted if you do not want to assign a default number. (The first number entered for an entry will automatically be assigned as the default number.)
- The valid digits are "0" through "9", "✳", "☎", "✚", "P".
- If an item with the same name and number exists, the new information added will be merged with the existing item.
- To enter characters, see "Entering Characters", Page 28.

To add the phone number to an existing entry:**[In standby mode]**

1. Display the Incoming or Outgoing Call Log. For details, see "Incoming/Outgoing Call Log", Page 26.
2. Tap  /  : Select the desired item.
3. Tap "Save Phonebook".
4. Tap "Add Number". → "OK"
5. Tap .
6. Enter the name or the first character(s) of the desired name. → "OK"
7. Tap  /  : Select the desired name.
8. Tap  of the phone number you want to use as the entry's default number.
The color of the icon for the selected item changes to .
9. Tap .

Note





- Step 8 can be omitted if you do not want to assign a default number. (The first number entered for an entry will automatically be assigned as the default number.)
- The valid digits are "0" through "9", "✳", "☎", "✚", "P".
- If an item with the same name and number exists, the new information added will be merged with the existing item.
- To enter characters, see "Entering Characters", Page 28.

Editing a stored item in the Personal Phonebook

Editing a Stored Item**[In standby mode]**





1. Tap  /  → "Phonebook"

Using the Phonebook

2. Tap .
3. Enter the name or the first character(s) of the desired name. → "OK"
4. Tap  /  : Select the desired name.
5. Tap .*1
6. Tap the desired name, phone number, category or default telephone number.
7. Edit the data as necessary.
8. Repeat steps 5 to 7 and edit the items you want to change.
9. Tap .

*1 If this icon is not displayed, you are currently viewing the Shared Phonebook. You must be viewing the Personal Phonebook to edit items. Contact your administrator for further information.









Note

- To change a character or digit, tap  or  to highlight it, tap  to delete it, and then enter the new character or digit.
- To clear an entire line, tap "Delete".
- To move the cursor to the left or right, tap  or  respectively.
- For details about entering characters, see "Entering Characters", Page 28.

Editing Category Names

You can edit the names of the categories in the phonebook.

[In standby mode]

1. Tap  /  → "Basic Settings"
2. Tap  /  → "Display Option"
3. Tap  /  → "Category Name"
4. Tap  /  : Select the desired category number (1–9).
5. Enter a name for the category (max. 13 characters). → "OK"
6. Repeat steps 4 and 5 for each category name to edit.









Note

For details about entering characters, see "Entering Characters", Page 28.

Deleting a Stored Item in the Personal Phonebook

Deleting a Stored Item

[In standby mode]

1. Tap  /  → "Phonebook"
2. Tap .
3. Enter the name or the first character(s) of the desired name. → "OK"
4. Tap  /  : Select the desired name.
5. Tap .*1
6. Tap  /  : Tap the check boxes of the items you want to delete.*2
7. Tap  → "OK"

*1 If this icon is not displayed, you are currently viewing the Shared Phonebook. You must be viewing the Personal Phonebook to edit items. Contact your administrator for further information.

*2 You can select all items in the list by tapping .





Searching for an Item in the Personal Phonebook

You can search for an item in the phonebook by following the steps below.

Searching by Name

You can also search for an item in the phonebook by entering a name:









[In standby mode]

1. Tap  /  → "Phonebook"
 2. Tap .
 3. Enter the name or the first character(s) of the desired name. → "OK"
 4. Tap  /  : Select the desired name.
 5. Select the desired phone number.
 6. To make a call, do one of the following:
 - Go off-hook.*1
 - Tap "Voice Call" to make a voice call.
 - Tap "Video Call" to make a video call.
- *1 The type of call that is established depends on the "Call Mode" setting.

Searching by Category

If items in the phonebook have been assigned categories, you can search by category.

[In standby mode]

1. Tap  /  → "Phonebook"
 2. Tap .
 3. Tap  /  : Select a category. → "OK"
 4. Tap .
 5. Enter the name or the first character(s) of the desired name. → "OK"
 6. Tap  /  : Select the desired name.
 7. Select the desired phone number.
 8. To make a call, do one of the following:
 - Go off-hook.*1
 - Tap "Voice Call" to make a voice call.
 - Tap "Video Call" to make a video call.
- *1 The type of call that is established depends on the "Call Mode" setting.

Searching by pressing Dial Keys

You can also search for an item in the phonebook by pressing multiple dial keys when the phonebook list is displayed:

[When the phonebook is displayed]

1. Press the dial keys to enter the first character(s) of the desired name in accordance with the character tables.*1
- *1 For details about the characters assigned to the dial keys, see the following table.

Suffix	NE/X/SX/C/(none)	NE/X/SX	RU
Keys	ABC (Latin)	ABГ (Greek)	АБВ (Cyrillic)
[1]	‡→*→1	‡→*→1	A→Б→В→‡→*→1
[2]	A→B→C→2	A→B→Г→2	Г→Д→Е→Ё→2→A→B→C→2

Using the Phonebook

Suffix	NE/X/SX/C/(none)	NE/X/SX	RU
Keys	ABC (Latin)	ΑΒΓ (Greek)	АБВ (Cyrillic)
	D→E→F→3	Δ→Ε→Ζ→3	Ж→З→И→Й→3→D→E→F→3
	G→H→I→4	Η→Θ→Ι→4	К→Л→М→4→G→H→I→4
	J→K→L→5	Κ→Λ→Μ→5	Н→О→П→5→J→K→L→5
	M→N→O→6	Ν→Ξ→Ο→6	Р→С→Т→6→М→N→O→6
	P→Q→R→S→7	Π→Ρ→Σ→7	У→Ф→Х→7→P→Q→R→S→7
	T→U→V→8	Τ→Υ→Φ→8	Ц→Ч→Ш→8→T→U→V→8
	W→X→Y→Z→9	Χ→Ψ→Ω→9	Щ→Ъ→Ы→Ь→9→W→X→Y→Z→9
	0→Space	0→Space	Э→Ю→Я→0→Space

- Pressing a key repeatedly will cycle through the characters associated with that key. For example, to enter the letter "C" in Latin Mode, press 3 times.
- The illustrations of the keys in the table may differ in appearance from the actual keys on the telephone.

Example: To enter "ANNE" in Latin Mode.

→ → → → → → →

Note

- Availability depends on your phone system. Contact your administrator for further information.

Locking the Phonebook

You can lock/unlock the phonebook while in standby mode. If no password has been set, you cannot lock the phonebook. For details about setting the password, see "Setting the Password", Page 27.

Note

- If you lock either the Personal Phonebook or the Shared Phonebook, the other one is also locked. If you unlock the phonebook, both phonebooks are unlocked.

Locking/Unlocking the Phonebook

[In standby mode]

To lock

1. Tap / → "Phonebook"
2. Press /[MENU].
3. Tap "Lock Phonebook". → "OK"*1

To unlock

1. Tap / → "Phonebook"
2. Enter your password.*2 → "OK"
3. Press /[MENU].
4. Tap "Unlock Phonebook". → "OK"
5. Enter your password.*2 → "OK"

Unlocking the Phonebook Temporarily

1. Tap / → "Phonebook"
2. Enter your password.*2 → "OK"

*1 The call log is also locked.

- *2 If you enter an incorrect password 3 times, you cannot enter another password for approximately 30 seconds.

Using the Shared Phonebook

You can refer to the Shared Phonebook in addition to the Personal Phonebook, if the Shared Phonebook is available.







Note

We recommend setting this feature with your administrator. Contact your administrator for further information.

Searching for an Item in the Shared Phonebook

Searching by Name

[In standby mode]





1. Tap  /  → "Phonebook"
 2. If "Phonebook" is displayed as the title, tap .*1
 3. Tap .
 4. Enter the name or the first character(s) of the desired name. → "OK"
 5. Tap  /  : Select the desired name.
 6. Select the desired phone number.
 7. To make a call, do one of the following:
 - Go off-hook.*2
 - Tap "Voice Call" to make a voice call.
 - Tap "Video Call" to make a video call.
- *1 If only Shared Phonebook is permitted, this step is skipped.
- *2 The type of call that is established depends on the "Call Mode" setting.

Checking the Line Status



You can check the status of each line (up to 16 lines) on the display.

Checking the Line Status

[In standby mode]

1. Tap  /  → "Line Status"
2. Tap  /  : Select the line whose status you want to check.
3. Press /[CANCEL] to end checking the line status or tap the line to perform an action. See "Line status indication" below for details.

[During a conversation]

1. Tap "Line Status".
2. Tap  /  : Select the line whose status you want to check.
3. Press /[CANCEL] to end checking the line status or tap the line to perform an action. See "Line status indication" below for details.





Note

- When a function key is assigned as a Line Status key, you can press that function key to display the line status screen. See "Line status indication" below for details.

Line status indication

Status Display	Meaning
Free* ¹	The line is idle. Action: seize the line for dialing.
In Use	The line is on a call. Action: none.
Line On Hold	The line is on hold. Action: retrieve the call on hold.
Incoming Call	The line is receiving a call. Action: answer the call.
Recall	The line is receiving a Hold Recall signal. Action: answer the call.
<x> In Use* ²	A shared line is in use at another unit. Action: join the call.
<x> Line On Hold* ²	A shared line is on hold at another unit. Action: retrieve the call on hold.

*¹ The following icons are also displayed if the corresponding feature is enabled.

Icon	Meaning
	Call Forwarding
	Do Not Disturb
	Making an anonymous call
	Block anonymous calls

- *2 If the shared line is set, <x> (index number) is also displayed. We recommend setting this with your administrator. Contact your administrator for further information.

Network Camera

Registering Network Cameras allows you to use the phone to view those cameras' video feeds. You can also control the camera's pan and tilt, zoom in, zoom out, etc.

If a Network Camera is associated with a phone number (Paging Number), you can call that number while viewing the camera's video feed.

Also, if a Network Camera is associated with phone numbers (Linked Numbers), when you begin a conversation, Network Camera viewer starts automatically and you can view the camera's video feed during the conversation.









Note



- To view a Network Camera's video feed from this unit, the Network Camera must be configured to use H.264 as its video codec.
- Depending on the camera model, some operations may not be available.
- Calls with phone numbers that are associated with Network Cameras are available only as voice calls.
- For up-to-date information about Network Cameras that have been tested with this unit, refer to the following web site:
<http://www.panasonic.net/pcc/support/sipphone/>

Registering a Network Camera

You can register up to 16 Network Cameras connected to the network.

[In standby mode]

1. Tap  /  → "Basic Settings"
2. Tap  /  → "Network Camera"
3. Tap "Camera Registration".
4. Tap  /  : Select the number you want to register.
5. Enter the necessary information.
 - **Name**
Specify the Network Camera's name. You can enter up to 20 characters.
If you do not specify a name, one is automatically assigned.
 - **Address**
Specify the Network Camera's IP address (IPv4/IPv6) or host name (FQDN). You can enter up to 256 characters.
 - **Port Number**
Enter the Network Camera's port number (1–65535).
The default value is 80.
 - **User ID**
Enter the user ID to use when connecting to the Network Camera (max. 32 characters).
 - **Password**
Enter the password to use when connecting to the Network Camera (max. 32 characters).
 - **Paging Number**
Enter the name and phone number associated with the Network Camera (name: max. 24 characters, phone number: max. 32 characters).
 - To select a number from the phone book: Tap .
 - To select a number from the call history: Tap .
 - **Linked Numbers**
Enter the names and phone numbers to associate with the Network Camera so that the video feed automatically displays when making or receiving a call. You can make up to 5 entries (name: max. 24 characters, phone number: max. 32 characters).

- To select a number from the phone book: Tap .
- To select a number from the call history: Tap .



- **Stream**

Select "Stream 1" or "Stream 2" if the Network Camera is configured to output multiple streams. For details, refer to your Network Camera's documentation.

Network Camera Viewer

Starting Network Camera Viewer

[In standby mode]

1. Tap  /  → "Network Camera"

Note





- The video feed of the Network Camera to which you most recently registered is displayed.
- No video feed is displayed if no Network Cameras have been registered.

Closing Network Camera viewer

1. Press "Home" or "Cancel". → "OK"

Selecting a Network Camera

[In standby mode]

1. Tap  /  → "Network Camera"
2. Press /[MENU].
3. Tap  /  : Select the desired camera name. → "OK"

Controlling a Network Camera

[While displaying a video feed from a Network Camera (operation screen)]

Centering: While the status bar and operation area are displayed on the screen, tap the spot where you want to center the video feed.*1

Tap the screen to display the icons before performing the following operations.

Pan: Tap  / .

Tilt: Tap  / .

Zoom in: Tap .

Zoom out: Tap .

Home position: Tap .

*1 Depending on the Network Camera, this feature may not be available.

Note

- If an icon is grayed out, that feature is not available.

Switching Automatically among Multiple Network Cameras

You can automatically cycle through the video feeds from registered Network Cameras at a set time interval.

[While displaying a video feed from a Network Camera (operation screen)]

1. Press /[MENU].
2. Tap "Camera Selection".
3. Tap "Sequential".

Network Camera

To stop switching





1. Tap any camera name.

Note

- The order in which video feeds are displayed follows the order in which the Network Cameras are registered.

Interval switching settings

[While displaying a video feed from a Network Camera (operation screen)]

1. Press /[MENU].
2. Tap "Camera Selection".
3. Press /[MENU].
4. Tap "Sequential Interval".
5. Tap  /  : Select the desired item. → "OK"

Using Phone Numbers Associated with a Network Camera

Paging Number

Paging can be performed using a phone number (Paging Number) associated with a Network Camera.

[While displaying a video feed from a Network Camera (operation screen)]

1. Tap the screen.
2. Tap .

Note

- A call is a voice call using the speakerphone from the default line.

Linked Number

The video feed of the Network Camera can be viewed by making or receiving a call using a phone number (Linked Number) associated with the Network Camera.

[In standby mode]

1. Dial the Linked Number.
2. Tap "Voice Call".
The video feed of the Network Camera associated with the Linked Number is displayed.

[While receiving a call]

1. Tap "Voice Call".
If the call received was made using a Linked Number, the video feed of the associated Network Camera is displayed.



Network Camera Presets

You can select a viewing position that has been registered in the Network Camera's settings beforehand. These registered viewing positions are called "presets".

Note

- Depending on the Network Camera, this feature may not be available.

[While displaying a video feed from a Network Camera (operation screen)]

1. Press /[MENU].
2. Tap "Preset".
3. Tap  /  : Select the desired item.
4. Tap "OK".
Displays the selected position image.

5. To return to the preset selection screen:

- Tap .

To return to the operation screen:

- Tap "OK".



Note

- Tapping "Favourites/Favorites" in step 3 displays the presets registered as favorites.
- Tapping  in step 3 displays the camera's position before a preset was selected.

Adding a Preset to Your Favorites



You can register a preset to your favorites.

[While displaying a video feed from a Network Camera (operation screen)]

1. Press /[MENU].
2. Tap "Preset".
3. Tap  /  : Select the preset you want to register.
4. Tap "Edit".
5. Tap "Add to Favourites/Favorites". → "OK"



Deleting a Preset from Your Favorites

[While displaying a video feed from a Network Camera (operation screen)]

1. Press /[MENU].
2. Tap "Preset".
3. Tap  /  : Select the preset you want to delete.
4. Tap "Edit".
5. Tap "Remove from Favourites/Favorites". → "OK"

Editing a Preset's Name

[While displaying a video feed from a Network Camera (operation screen)]

1. Press /[MENU].
2. Tap "Preset".
3. Tap  /  : Select the preset to edit its name.
4. Tap "Edit".
5. Tap "Edit Preset Name".
6. Enter the name. → "OK"

Note

- In step 3, you can jump directly to a specific page by tapping "Page Jump" and entering the page number.
- You can edit the name of a preset registered as a favorite by tapping "Favourites/Favorites" after step 2.
- To reset a preset's name:
 1. Select the preset name.
 2. Tap "Edit".
 3. Tap "Delete Preset Name". → "OK"

Configuring Display Properties

You can adjust the brightness of the Network Camera and set up Automatic Mode.

Network Camera

Note

- Depending on the Network Camera, this feature may not be available.

Adjusting the Brightness of the Picture

[While displaying a video feed from a Network Camera (operation screen)]

1. Press /[MENU].
2. Tap "Camera Settings".
3. Tap "Brightness".
4. Brighter: Tap "+".
Darker: Tap "-".
Default: Tap "Reset".
Back: Tap "OK".

Note

- The range of brightness and default value depend on the Network Camera.

Automatic Mode

Note

- Depending on the Network Camera, this feature may not be available.

Auto Pan

The Network Camera can be set to pan horizontally (left–right) repeatedly over its entire viewing range.

[While displaying a video feed from a Network Camera (operation screen)]

1. Press /[MENU].
 2. Tap "Camera Settings".
 3. Tap "Auto Mode".
 4. Tap "Auto Pan".*1 → "OK"
- *1 To cancel Automatic Mode, tap "Off" → "OK".

Preset Sequence

You can have the Network Camera display multiple preset viewing positions in a repeating cycle.

[While displaying a video feed from a Network Camera (operation screen)]

1. Press /[MENU].
 2. Tap "Camera Settings".
 3. Tap "Auto Mode".
 4. Tap "Preset Sequence".*1 → "OK"
- *1 To cancel Automatic Mode, tap "Off" → "OK".

Automatic Tracking

You can have the camera automatically follow a moving object.

[While displaying a video feed from a Network Camera (operation screen)]

1. Press /[MENU].
 2. Tap "Camera Settings".
 3. Tap "Auto Mode".
 4. Tap "Auto Tracking".*1 → "OK"
- *1 To cancel Automatic Mode, tap "Off" → "OK".

Receiving Alarms from Network Cameras

When an alarm from a Network Camera (movement detection, error, abnormality, etc.) is detected, this unit can display the video feed from the camera that issued the alarm.

Note

- Alarms can be indicated by a sound and/or a pop-up message on the display.
- Depending on the Network Camera, this feature may not be available.

When an Alarm Notification Appears in a Pop-up Message

To connect the Network Camera where the alarm occurred



1. Tap "OK" on the pop-up message.

Note

- Tap "Cancel" to not connect to the Network Camera.
If you received an alarm during a video call, the call is automatically switched to a voice call.

Checking an Alarm



[In standby mode]

1. Tap  /  → "Call History"
2. Tap *1

3. Tap an item to connect to the camera and view its video feed.

*1 A list of Network Cameras where an alarm has occurred is displayed.



Note

- To delete an item from the list, tap  → tap the check boxes of the items you want to delete → tap  → "OK"

Configuring an Alarm Notification

Alarm Notification Settings







[In standby mode]

1. Tap  /  → "Basic Settings"
2. Tap  /  → "Network Camera"
3. Tap "Alarm Settings".
4. Tap "Notification".
5. Tap "Pop Up". → "OK"

Alarm Disarm Period Settings

You can set the period of time in which other alarm notifications are stopped (disarmed) after an alarm occurs.

[In standby mode]





1. Tap  /  → "Basic Settings"
2. Tap  /  → "Network Camera"
3. Tap "Alarm Settings".
4. Tap "Disarm Time".
5. Tap  /  : Set the disarm time (in seconds). → "OK"

Network Camera

Alarm Port Number Settings

You can set the port number for receiving alarms.

[In standby mode]

1. Tap  /  → "Basic Settings"
2. Tap  /  → "Network Camera"
3. Tap "Alarm Settings".
4. Tap "Port Number".
5. Enter a port number. → "OK"

Communication Camera

By registering a Communication Camera and then selecting it from the list, you can make a call to monitor the camera's video feed and allow voice communication.

When a call is received from a Communication Camera, you can monitor video feed of the other party. You can operate the Communication Camera (pan/tilt), zoom in/zoom out the video feed, and control devices connected to the Communication Camera (for example, to unlock a door). These features can be used with KX-NTV150 and KX-NTV160 models.







This chapter describes the special functions and operations of the Communication Camera. Refer to the relevant sections of this manual for operations not described here.

Using a Communication Camera

Registering a Communication Camera

You can register up to 16 Communication Cameras connected to the network.





[In standby mode]

1. Tap  /  → "Basic Settings"
2. Tap  /  → "Comm. Camera"
3. Tap  /  : Select the number you want to register.
4. Enter the necessary information.
 - **Name**
Specify the camera's name. You can enter up to 20 characters.
 - **Phone Number**
Enter the phone number of the Communication Camera.
 - **Ringer Type**
Set the ringtone for when a call is received by the Communication Camera.
The default is "Ringtone 10".

Calling a Communication Camera

After dialing the phone number of a registered Communication Camera, the following operations are possible.

[In standby mode]

1. Tap  /  → "Comm. Camera"
2. Tap  /  : Select the Communication Camera to call.
3. Tap "Camera Monitor" to monitor the video.
Tap "Camera Call" or go off-hook to make a voice call.

Note

- To make a voice call while monitoring a video feed, tap  or go off-hook.

Receiving a Call from a Communication Camera

- When a call is received, only one ring will be heard from the speaker.
- When a call is received, the camera's video feed is displayed. Then, to enable voice communication, tap .
- While on a voice call with a Communication Camera and a call is received from a Communication Camera, tap "Camera" to answer the call. The current call will be put on hold.

Communication Camera

Transferring a Call with a Communication Camera

For details about this operation, see “Transferring a Call (Call Transfer)”, Page 39.

Note

- If the Communication Camera is registered at the transfer destination, the video monitor screen is shown. If it is not registered, the video call screen or voice call screen is shown.

Conference Calls when Connected to a Communication Camera

For details about this operation, see “Three-party Conference”, Page 41.

Note

- When another party is added while monitoring the video feed of a Communication Camera, a call will start with that party.
- When a third party is added during a call with a Communication Camera, a three-party conference starts.

Operation Icons of the Communication Camera Screen

Normally, the video feed is displayed in full screen. If you tap the screen, the status bar and operation area are displayed. After a certain amount of time, the display returns to full screen. (Tap the screen again to show the status bar and operation area.)

[While displaying the video feed from a Communication Camera (operation screen)]

Tap the screen to display the icons before performing the following operations.

Pan: Tap  / .

Tilt: Tap  / .

Zoom in: Tap .

Zoom out: Tap .

Unlock*1: Tap .

Switch from monitoring the video feed to a call: Tap .

Disconnect: Tap .

*1 Controlling devices connected to a Communication Camera (for example, unlocking a door).

Customizing the Telephone

ECO Mode





Enabling this mode reduces the amount of electricity consumed by the unit.

Note

- When ECO mode is enabled, the "Link Speed" setting (Page 92) changes as follows:
 - Link Speed: "10M/Full"
 - PC port cannot be used
- When the ECO mode setting is changed, the unit will restart.
- When ECO mode is enabled,  is displayed in the status bar.

Setting ECO Mode



[In standby mode]

1. Tap  /  → "System Settings"
 2. Tap "System Settings".
 3. Tap  /  → "ECO Mode"
 4. Tap "On".*1 → "OK"
- *1 To disable ECO mode, select "Off" (default).

Changing the Telephone's LCD Display

You can change what is displayed on the telephone's LCD while the telephone is in standby mode.

[In standby mode]

1. Tap  /  → "Basic Settings"
2. Tap  /  → "Display Option"
3. Tap  /  → "Standby Display"
4. Select the desired item. → "OK"





Hot Keys

By assigning phone numbers to dial keys, you can make a call by pressing and holding a dial key.

- "Hot Key Dialing", Page 32

Assigning Hot Keys From Phonebook

You can assign a phone number stored in the Personal Phonebook to a key to be used as a Hot Key.



1. In standby mode, press and hold a dial key (0–9) for more than 1 second.
2. Tap .
3. Tap .
4. Enter the desired name.
5. Tap  /  : Select the desired name.
6. Select a desired phone number.
7. Tap .

Customizing the Telephone





Note

- For details about searching for an item in the phonebook, see "Searching for an Item in the Personal Phonebook", Page 51.
-

Editing Hot Keys

1. In standby mode, press and hold a dial key (0–9) for more than 1 second.
 2. Tap .
 3. Tap "Name", if necessary.
 4. Edit the name. → "OK"
 5. Tap "Phone Number", if necessary.
 6. Edit the phone number. → "OK"
 7. Tap .
-

Deleting a Hot Key

1. In standby mode, press and hold the dialing key assigned as a Hot Key for more than 1 second.*1
 2. Tap .
 3. Tap the check boxes of the items you want to delete.*2
 4. Tap . → "OK"
- *1 While the Hot Key's information is displayed, you can tap  or  to select another Hot Key number.
- *2 You can select all items in the list by tapping .
-

Selecting the Type of Hot Key Dialing

You can select one of 2 types of Hot Key Dialing for each assigned Hot Key.









1. In standby mode, press and hold a dial key (0–9) for more than 1 second.
2. Tap .
3. Tap "Automatic Call".
4. Select "Manual" or "Auto". → "OK"
 - Manual:
Press and hold the dialing key (0–9) assigned as a Hot Key for more than 1 second, and then go off-hook. For details, see "Hot Key Dialing", Page 32.
 - Auto:
Pressing and holding an assigned Hot Key for the set number of seconds will dial that Hot Key's assigned number immediately.

Note

- To select the number of seconds before the call is automatically made, see "Hot Key Time" in "Key Option", Page 86.
-

Changing the Function Keys (Program Keys and DSS Keys)

[In standby mode]

1. Tap  /  → "Basic Settings"
2. Tap  /  → "Key Option"
3. Tap "Program Key".*1
4. Tap  /  : Select the key to change.
5. Tap "Function".
6. Tap  /  : Select the new item to assign.*2 → "OK"

7. Specify additional settings, such as "Line", "Label" and "Phone Number" as necessary.
8. Tap .
- *1 To assign functions to the DSS keys on a KX-HDV20, tap "DSS Key". You can also assign a function by pressing the desired DSS key for 3 or more seconds.
- *2 To clear the current setting, tap "None".

Note

- In addition to the Line function, other functions can be assigned to individual lines. However, only lines that have been set up in advance can be selected.

Each of the function keys can be assigned one of the following functions.

- One Touch Dial
Used to dial a previously set phone number with one touch.
The type of call that is established depends on the "Call Mode" setting.
- BLF (Busy Lamp Field)
Used to transfer calls to the extension assigned to the key while receiving an incoming call or during a conversation. The indicator of a BLF key also shows the current status of the extension assigned to the key.

Status		Meaning
Color	Light pattern	
Red	Off	Available
	On	Unavailable
	Quick Flashing	Ringing
Blue	On	Call Park

Note

- More than 48 BLF keys can be programmed, but status indication is available only up to 48 keys.
- Line
Used to seize a line in order to make or receive a call. The color of each key's indicator shows the status of the line.

Status		Meaning
Color	Light pattern	
Blue	On	In Use ● You are on a call.
	Slow Flashing	"Line On Hold" ● A call is on hold.
	Quick Flashing	"Incoming Call" or "Recall" ● A call (including Hold Recall) is being received. Name or number of caller ● A call to a shared line is being received.
Red	On	In Use ● A shared line is in use or a call is on private hold at another unit.
	Slow Flashing	"Line On Hold" ● A shared line is on hold at another unit.

Customizing the Telephone

Status		Meaning
Color	Light pattern	
Off	—	Free ● The line is idle.

- ACD[Login]/ACD[Wrap Up]^{*1}
ACD[Login]: Used to log in/log out of an Automatic Call Distribution Group.
ACD[Wrap Up]: Used to change the phone's status from unavailable → wrap up → available.
The color of each key's indicator shows the status of the key.

Status		Meaning	
Color	Light pattern	ACD[Login]	ACD[Wrap Up]
Red	Off	Logged In	Available
	On	Logged Out	Unavailable
	Slow Flashing	—	Wrap Up

- Line Status
Used to confirm the status of each line. This allows the function key to work as a Line key such as seizing a line in order to make or receive a call.
- Call Forward
Used to forward incoming calls to the extension assigned to the key.
- Phonebook^{*2}
Used to open the phonebook.
- Call History^{*2}
Used to open the Incoming/Outgoing Call Log.
- Simultaneous Ring^{*1}
Enables parallel ringing. Up to 10 locations can be specified to ring simultaneously when you receive a call.

Status		Meaning
Color	Light pattern	
Blue	On	Simultaneous Ring feature: On
	Off	Simultaneous Ring feature: Off

- Hoteling/Hospitality^{*1}
Used to log in/log out of the Call Center Hoteling Event.
- Transfer
Used to transfer a call to the extension assigned to the key with confirmation during a conversation.
- Blind Transfer^{*1}
Used to transfer a call to the extension assigned to the key without confirmation during a conversation.
- Conference
Used to establish a multiple-party conversation (conference).
- Directed Call Pickup^{*1}
Used to answer an incoming call arriving at the specified telephone number.
- Call Park/Park Retrieve^{*1}
Used to park a call or to retrieve a parked call (Call Parking).
- Network Camera
Used to connect to a Network Camera. This specifies the name of Network Camera to connect to.

^{*1} This item can be used only when the feature is enabled. Contact your administrator for further information.

*2 This item can be selected when the list is registered on the telephone. Contact your administrator for further information.









Block anonymous calls

This feature allows the unit to reject calls when the unit receives a call without phone number. The default setting is "Off".

IMPORTANT

- A password may be required for these settings. We recommend setting with your administrator. Contact your administrator for further information.
- This feature is not available on shared lines.

[In standby mode]

1. Tap  /  → "Advanced Settings"
2. Tap  /  → "Call Settings"
3. Tap  /  → "Block Anonymous"
4. Tap  /  : Select a desired line.
5. Select "On" or "Off". → "OK"

Incoming call barring (Caller ID service users only)

This feature allows the unit to reject calls from specified phone numbers that you do not want to answer such as junk calls.

When a call is received, the unit does not ring while the caller is being identified. If the phone number matches an entry in the call barred list, the unit rejects the call.









IMPORTANT

- A password may be required for these settings. We recommend setting with your administrator. Contact your administrator for further information.

Storing unwanted callers









You can store up to 30 phone numbers in the call barred list by using the caller list or by entering the numbers directly.

[In standby mode]

1. Tap  /  → "Advanced Settings"
2. Tap  /  → "Call Settings"
3. Tap  /  → "Block Caller ID"
4. Tap  /  : Select a blank line.
5. Enter the phone number (32 digits max.). → "OK"

Editing the phone numbers to reject











[In standby mode]

1. Tap  /  → "Advanced Settings"
2. Tap  /  → "Call Settings"
3. Tap  /  → "Block Caller ID"
4. Tap  /  : Select a desired phone number.
5. Edit the phone number. → "OK"

Customizing the Telephone

Deleting the phone numbers to reject

[In standby mode]

1. Tap  /  → "Advanced Settings"
2. Tap  /  → "Call Settings"
3. Tap  /  → "Block Caller ID"
4. Tap .
5. Tap  /  : Tap the check boxes of the items you want to delete.*1
6. Tap . → "OK"

*1 You can select all items in the list by tapping .









Making an anonymous call

Before making a call, specify the following:

IMPORTANT

- A password may be required for these settings. We recommend setting with your administrator. Contact your administrator for further information.

[In standby mode]

1. Tap  /  → "Advanced Settings"
2. Tap  /  → "Call Settings"
3. Tap  /  → "Anonymous Call"
4. Tap  /  : Select a line.
5. Select "On" or "Off". → "OK"

Changing the Basic Settings

To select the main item in standby mode

1. Tap  /  → "Basic Settings"
2. Tap  /  : Select the main item.

Main Item	Sub Item			Page
Incoming Option	Ringer Volume	Ringer Type		Page 85
Talk Option	Speaker Volume	Handset Volume	Headset Volume	Page 85
Answer Option	Auto Ans Device	Auto Ans Delay	Auto Answer	Page 86
Key Option	Program Key	DSS Key	Hot Key Time	Page 86
Display Option	Language	Backlight	Standby Display	Page 87
	Category Name	Date Format	Time Format	
	Screen Saver	DSS Control		
Key Tone	—			Page 88
Bluetooth Headset	Connection	Registration		Page 88
Video Options	Call Mode	Screen Mode	Image Sending	Page 88
	Rate Settings	Camera Settings		

Main Item	Sub Item			Page
Network Camera	Alarm Settings	Camera Registration		Page 89
Comm. Camera	—			Page 90
Other Option	Change Password	Embedded Web		Page 90

Changing the System Settings

IMPORTANT

- The feature depends on your phone system. Contact your administrator for further information.

To select the main item in standby mode



1. Tap  /  → "System Settings"
2. Tap  /  : Select the main item.

Main Item	Sub Item			Page
Status	Line Status	Firmware Version	IP Mode	Page 90
	IPv4 Settings	IPv6 Settings	MAC Address	
	LLDP	VLAN		
Network Settings	IP Mode Select	IPv4 Settings	IPv6 Settings	Page 91
	LLDP	VLAN	Link Speed	
System Settings	Set Time & Date* ¹	Authentication	Access Code	Page 92
	ECO Mode	Restart	DSS Restart	

*1 Availability depends on your phone system. Contact your administrator for further information.

Changing the Advanced Settings

To select the main item in standby mode

1. Tap  /  → "Advanced Settings"
2. Select the main item.

Main Item	Sub Item			Page
Xsi Setting* ¹	—			Page 93
UC Setting* ¹	—			Page 93
Call Settings* ²	Block Anonymous	Anonymous Call	Block Caller ID	Page 93
	Anywhere* ¹	Remote Office* ¹	SimultaneousRing* ¹	
	System Lock			
Executive Filtering* ¹	—			Page 94
Assistant Settings* ¹	Assistant Filtering	Divert Setting		Page 94

*1 This item is displayed only when the feature is enabled. Contact your administrator for further information.

*2 A password may be required for these settings.

Web User Interface Programming

The product provides a Web-based interface for configuring various settings and features, including some that are not programmable directly. The following list contains some useful features that are programmable through the Web user interface.

Contact your administrator for further information.

- Language Settings (IP Phone/Web)
- User Password (for access to Web user interface)
- Default Line for Outgoing
- Call Rejection Phone Numbers
- Call Features
 - Enable Anonymous Call
 - Enable Block Anonymous Call
 - Enable Do Not Disturb
 - Enable Call Forwarding Always
 - Forwarding Number (Always)
 - Enable Call Forwarding Busy
 - Forwarding Number (Busy)
 - Enable Call Forwarding No Answer
 - Forwarding Number (No Answer)
 - Ring Counts (No Answer)
- Hotline Number
- Flexible Key Setting
- Phonebook Import and Export
- DSS Console
- Video call
- Communication Camera

Note

- Each time you want to access the Web user interface, you must enable Web programming (Embedded Web). See "Other Option", Page 90.

Installation and Setup

Note

- Panasonic assumes no responsibility for injuries or property damage resulting from failures arising out of improper installation or operation inconsistent with this documentation.

WARNING

- To reduce the risk of fire or electric shock, do not overload AC outlets and extension cords.
- Completely insert the AC adaptor/power plug into the AC outlet. Failure to do so may cause electric shock and/or excessive heat resulting in a fire.
- Regularly remove any dust, etc. from the AC adaptor/power plug by pulling it from the power outlet, then wiping with a dry cloth. Accumulated dust may cause an insulation defect from moisture, etc. resulting in a fire.

Attaching the Stand

Attach the stand to the desk phone.

1. Insert the stand into the slots located in the unit.
2. Gently rotate the stand in the direction indicated until it is fixed.

KX-HDV430 stand

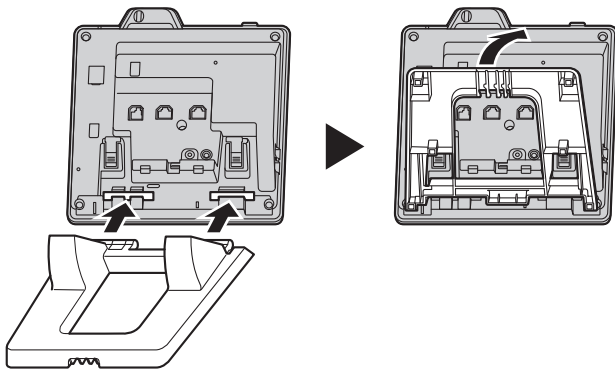

Installation and Setup

KX-HDV20 (option) stand

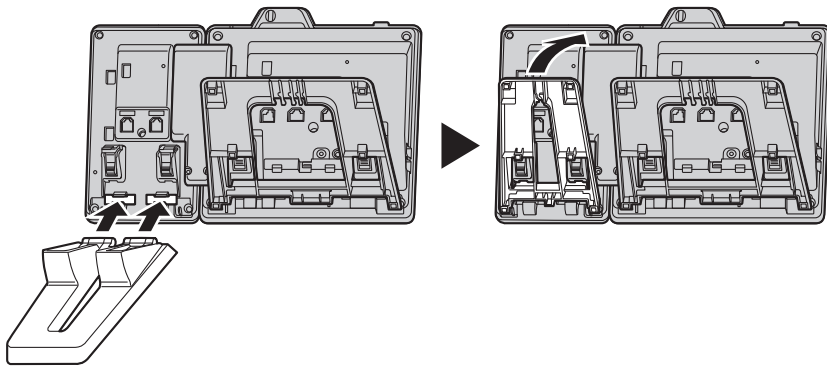

Adjusting the Stand Position

Push the PUSH marks in the direction indicated, with both hands, and tilt and slide the stand until it becomes fixed in the desired position.

- Lowering the stand

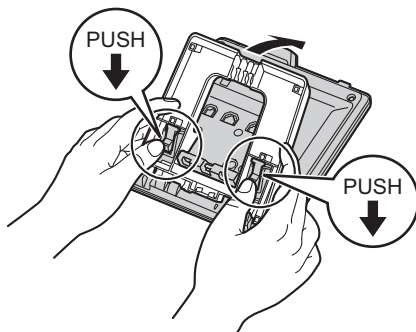

- Raising the stand

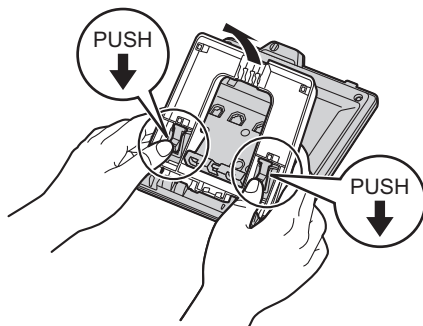

Removing the Stand

Tilt the stand in the direction indicated while pushing the PUSH marks with both hands.

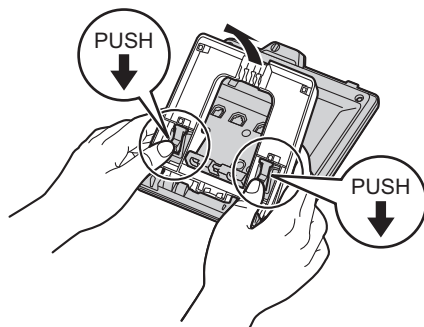

Adjusting the Camera Angle

You can tilt the camera's angle by turning the wheel on the back of the camera.

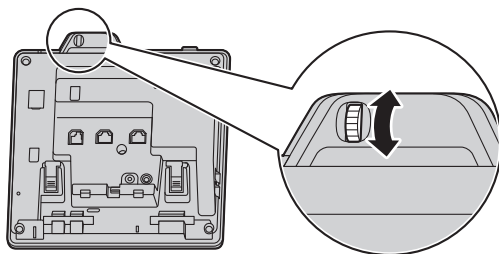

↑: Tilt the camera upward. To hide the camera lens, tilt the camera as far upward as possible.

↓: Tilt the camera downward.

Attaching the Optional KX-HDV20 to the Unit

The optional KX-HDV20 has 20 DSS keys, and it adds 40 function keys (20 keys × 2 pages) to the unit. These keys can be used to seize a line to make or receive a call or to perform a feature that has been assigned to the key.

1. Remove the stand from both the KX-HDV430 and KX-HDV20. See "Removing the Stand", Page 75.
2. Insert the tabs of the KX-HDV20 into the designated openings in the base, and then slide the KX-HDV20 in the direction of the arrow.
3. Fasten the KX-HDV20 to the unit with the included screw.
4. Attach the stand to both the KX-HDV430 and the KX-HDV20. See "Attaching the Stand", Page 73. Or, if the unit will be mounted on a wall, perform wall mounting. See "Wall Mounting", Page 79.
5. Connect the KX-HDV20 to the unit with the included cable. See "Connections (including optional KX-HDV20)", Page 77.

Installation and Setup

6. Turn on the KX-HDV430.

2

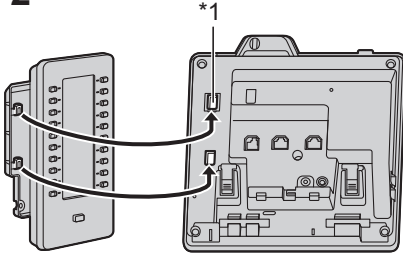

3

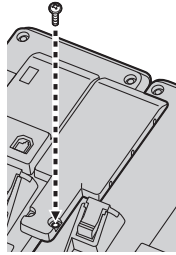

*1 Remove the hole cover.



Note

- Up to 5 KX-HDV20 units can be connected to the product.

Connections (including optional KX-HDV20)

Connect the Ethernet cable, the Handset Cord and the AC adaptor (Option) to the unit.

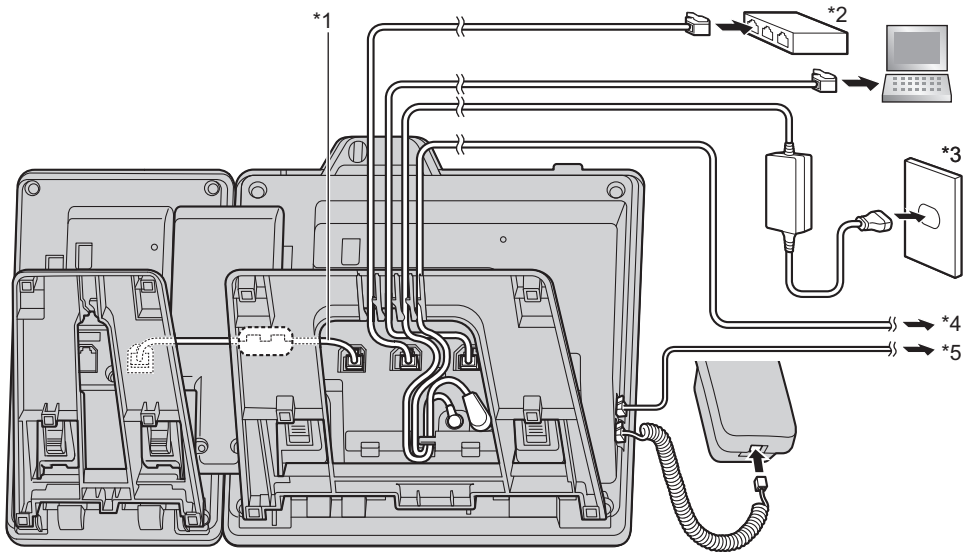

*1 Connection cable

Connect the connection cable as shown in the illustration.

*2 PoE HUB

*3 Optional AC adaptor

*4 Optional EHS headset

For up-to-date information about EHS headsets that have been tested with this unit, refer to the following web site:

<http://www.panasonic.net/pcc/support/sipphone/>

*5 Optional headset

For up-to-date information about headsets that have been tested with this unit, refer to the following web site:

<http://www.panasonic.net/pcc/support/sipphone/>

- The initial setting for the IP address is "DHCP—Auto". For information about your network environment, contact your administrator. For details, see "Network Settings", Page 91.

When selecting Ethernet cables (not included)

- Use flexible cables without jack covers. Do not use cables with a hard coating that may tear or crack when bent.

To prevent damage to the cables, use cables that do not protrude from the bottom of the base.

Installation and Setup

Connect the cables as shown in the following illustration.

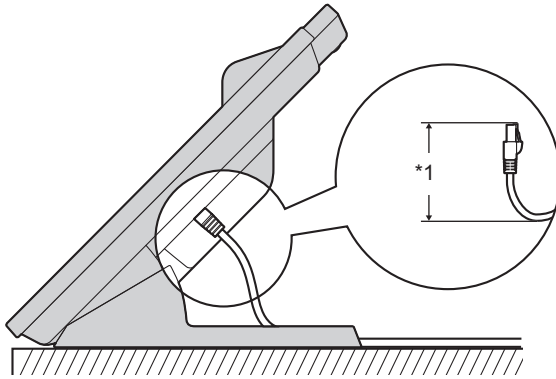

*1 60 mm (2 3/8 in) or less

- Use a straight CAT 5e (or higher) Ethernet cable (not included) that is 6.5 mm (1/4 in) in diameter or less.

When connecting to a switching hub

- If PoE is available, an AC adaptor is not needed.
- This unit complies with the PoE Class 2 standard.

When connecting a PC

- The PC port does not support PoE for connected devices.

When connecting cables and the AC adaptor

- Pass the Ethernet cable and the AC adaptor cord under the stand.

Wall Mounting

The KX-HDV430 and up to 5 optional KX-HDV20 units can be mounted on a wall.

IMPORTANT

- Make sure that the wall and the fixing method are strong enough to support the weight of the unit. (See "Specifications", Page 95.)
1. Insert the tabs of the wall mounting adaptor into the designated openings in the base, and then slide the wall mounting adaptor in the direction of the arrow until it clicks.
KX-HDV430

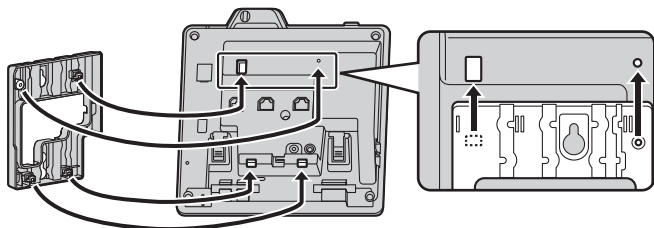

With optional KX-HDV20

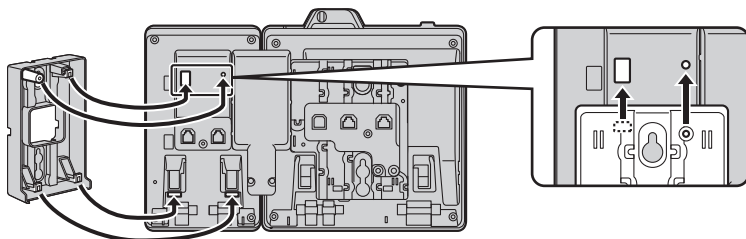

For 2nd to 5th KX-HDV20

Remove the screw from the DSS cover of the KX-HDV20, and then slide the cover up to remove it.

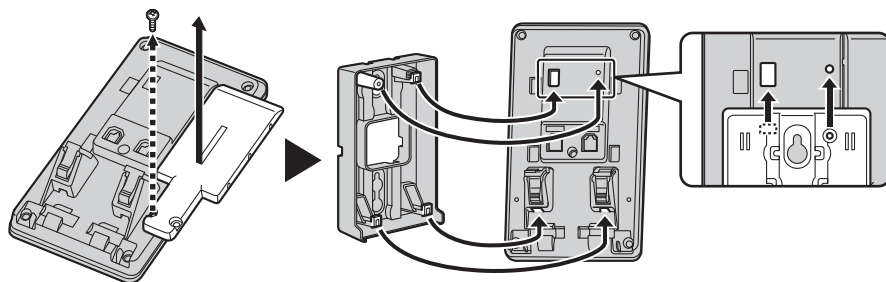

2. Fasten the wall mounting adaptor to the base with the included small screw.
(Recommended torque: 0.4 N·m [4.08 kgf·cm/3.54 lbf·in] to 0.6 N·m [6.12 kgf·cm/5.31 lbf·in])
3. Connect the AC adaptor, handset cord, Ethernet cables, and connection cable as necessary.
4. Drive the large screws into the wall either 83 mm (3 1/4 in) or 100 mm (3 15/16 in) apart, and mount the unit on the wall.

Installation and Setup

KX-HDV430

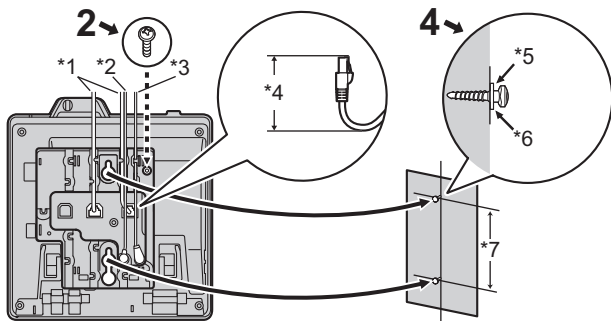

With optional KX-HDV20

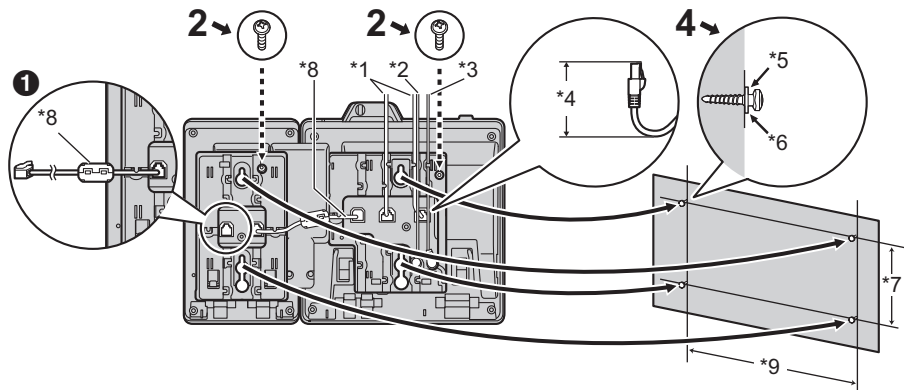

- 1 If you will mount additional KX-HDV20 units, connect the connection cable for the next unit to the unit you are attaching.

For 2nd to 5th KX-HDV20

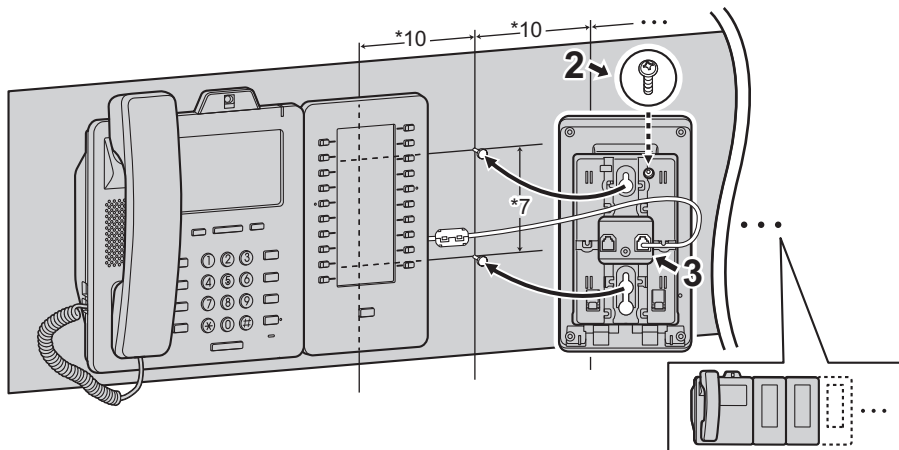

*1 Ethernet cables

- *2 EHS headset cable
 - *3 AC adaptor
 - *4 40 mm (1 37/64 in) or less
 - *5 Washer
 - *6 Drive the screw to this point
 - *7 83 mm (3 1/4 in) or 100 mm (3 15/16 in)
 - *8 Connection cable
 - Connect the connection cable as shown in the illustration.
 - *9 152 mm (6 in)
 - *10 111 mm (4 3/8 in)
- You can find a wall mounting template at the end of this manual.

Hooking the Handset

To Hook the Handset During a Conversation

1. Hook the handset over the top edge of the unit.

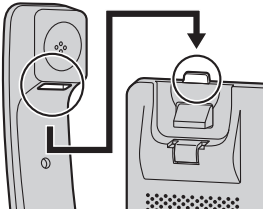

To Lock the Handset Hook when the Unit is Wall Mounted

1. Remove the handset hook from the slot.
2. Turn it up-side-down.
3. Slide the handset hook back into the slot until it locks.
4. Handset is safely hooked when it is in the cradle.

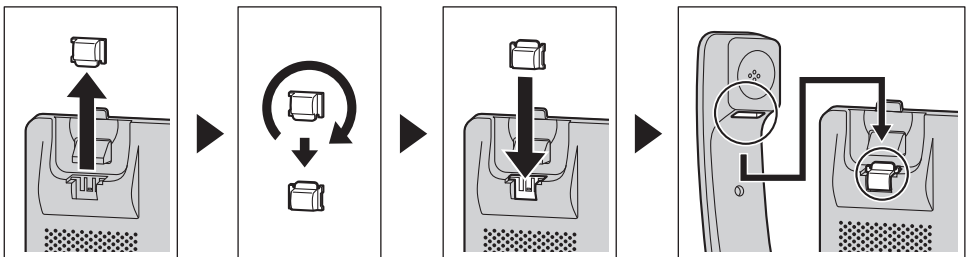

Updating the software

Your phone system dealer may offer new features and improve its software version from time to time. Contact your administrator for further information.

Appendix

Character Mode Table

KX-HDV430 (Suffix: NE/X/SX)

Keys	ABC (Latin)	0-9 (Numeric)	ΑΒΓ (Greek)	ÄÅÄ (Extended 1)	ŠŠŠ (Extended 2)
[1]	Space ¶ & ' () * , - . / 1	1	Space ¶ & ' () * , - . / 1		
[2]	ABC2	2	ΑΒΓ2	ÄÄÄÄÄÄÄ ÆBCÇ2	ÄÄÄÄÄÄBCČČ2
	abc2		αβγ2	aàáâãäå æbcç2	aáääåąbcčč2
[3]	DEF3	3	ΔΕΖ3	DÐEÈÉÊËËF3	DĎEÉÉĚĚF3
	def3		δεζ3	dðeèèêëëf3	dďeééěěf3
[4]	GHI4	4	ΗΘΙ4	GǦHIÍÎÏÏÎÏ4	GHIÍ4
	ghi4		ηθι4	gǧhiíîïïîï4	ghii4
[5]	JKL5	5	ΚΛΜ5	JKL5	JKLĹĹĹĹ5
	jkl5		κλμ5	jkl5	jkliĺĺĺ5
[6]	MNO6	6	ΝΞΟ6	MNŃŃŃŃŃŃŃ ŐŐøœ6	MNŃŃŃŃŃŃŃŃŃ Ő6
	mno6		νξο6	mñňoóóóóó øœ6	mnnňňoóóóó6
[7]	PQRS7	7	ΠΡΣ7	PQRSSŞß7	PQRŘŘŠŠŠ7
	pqrs7		πρσ7	pqrsşß7	pqrřřššš7
[8]	TUV8	8	ΤΥΦ8	TUÚÚÚÚÚÚV8	TŤŤUÚÚÚÚV8
	tuv8		τυφ8	tuúúúúúúv8	tťťuúúúúv8
[9]	WXYZ9	9	ΧΨΩϺ9	WŴXYŶZ9	WXYŸŸZZŽŽ 9
	wxyz9		χψωϻ9	wŵxyŷz9	wxyÿÿzžžž9
[0]	Space ! ? " : ; + = < > 0	0	Space ! ? " : ; + = < > 0		
[#]	\$ % & @ € £	#	\$ % & @ € £		

- Press [X] before or after entering a character to change between uppercase and lowercase.
- Pressing a key repeatedly will cycle through the characters associated with that key. For example, to enter the letter "C" in Latin Mode, press [2] 3 times.
- Characters that are entered using the [#] key (for example, "\$") cannot be entered when searching the phonebook. See "Searching for an Item in the Personal Phonebook", Page 51.

- The illustrations of the keys in the table may differ in appearance from the actual keys on the telephone.

KX-HDV430 (Suffix: RU)

Keys	АБВ (Cyrillic)	0–9 (Numeric)	ABC (Latin)	АĂĂ (Extended 1)	ŠŠŠ (Extended 2)
[1]	А Б В Space * + - / = < > 1 а б в Space * + - / = < > 1	1		Space † & ' () * , - . / 1	
[2]	Г Д Е Ё 2 где ё 2	2	ABC 2 abc 2	AĂĂĂĂĂĂĂ ÆBCÇ 2 a à á â ã ä å æbcç 2	AĂĂĂĂĂBCĆČ 2 a á â ã a b c ć č 2
[3]	Ж З И Й 3 ж з и й 3	3	DEF 3 def 3	DĎEĚÉÉĚĚĚF 3 d ě e è é ê ë ě f 3	DĎEĚĚĚĚF 3 d ě e é ě ě f 3
[4]	К Л М 4 к л м 4	4	GHI 4 ghi 4	GĜHIIÎÎÎÎI 4 g ĝ h i î ï ï ï ï 4	GHIÍ 4 g h i í 4
[5]	НОП 5 но п 5	5	JKL 5 jkl 5	JKL 5 jkl 5	JKLŁŁŁ 5 jklłłł 5
[6]	РСТ 6 р ст 6	6	MNO 6 mno 6	MNŃOÓÓÓ ŃŃøœ 6 m n ñ o ó ó ó ø œ 6	MNŃŃŃOÓÓ Ń 6 m n ñ ñ o ó ó ó 6
[7]	УФХ 7 у ф х 7	7	PQRS 7 p q r s 7	PQRSŞß 7 p q r s ş ß 7	PQRŘŔSŠŠ 7 p q r ř ŕ s š š 7
[8]	ЦЧШ 8 ц ч ш 8	8	TUV 8 t u v 8	TUÛÚÛÛÛV 8 t u ù ú û ü v 8	TŤŦUÚÛÛÛV 8 t ť ŧ u ú û ü v 8
[9]	Щ Ъ Ы Ь Space ! ? " 9 щ ъ ы ь Space ! ? " 9	9	WXYZ 9 w x y z 9	WŴXYŶZ 9 w ŵ x y ŷ z 9	WXYZŶŶZŽŽŽ 9 w x y ŷ ŷ z ž ž ž 9
[0]	Э Ю Я Space . , ' ; () 0 э ю я Space . , ' ; () 0	0		Space ! ? " ; , + = < > 0	
[#]	\$ % & @ € £ Ğ € ¡ ÿ # \$ % & @ € £ Ğ € ¡ ÿ #	#		\$ % & @ € £	

Appendix

- Press **[X]** before or after entering a character to change between uppercase and lowercase.
- Pressing a key repeatedly will cycle through the characters associated with that key. For example, to enter the letter "C" in Latin Mode, press **[2]** 3 times.
- Pressing a key repeatedly will cycle through the characters associated with that key. For example, to enter the letter "E" in Cyrillic Mode, press **[2]** 3 times.
- Characters that are entered using the **[#]** key (for example, "\$") cannot be entered when searching the phonebook. See "Searching for an Item in the Personal Phonebook", Page 51.
- The illustrations of the keys in the table may differ in appearance from the actual keys on the telephone.

KX-HDV430 (Suffix: [none]/C)

Keys	ABC (Latin)		0-9 (Numeric)	+ÂÂ (Extended 1)	
	Upper	Lower		Upper	Lower
[1]	Space ¶ & ' () * , - . / 1		1	Space ¶ & ' () * , - . / 1	
[2]	A B C 2	a b c 2	2	À Á Â Ã Ä Å Æ B C Ç 2	à á â ã ä å æ b c ç 2
[3]	D E F 3	d e f 3	3	Ð Æ È É Ê Ë Ì Í Î Ï 3	ð æ è é ê ë ì í î ï 3
[4]	G H I 4	g h i 4	4	Ĝ Ğ Ĥ Ħ Ĩ Ĵ Ķ 4	ğ ğ ĥ ħ ĩ ĵ ķ 4
[5]	J K L 5	j k l 5	5	J K L 5	j k l 5
[6]	M N O 6	m n o 6	6	M N Ñ O Ó Ô Ö Ø œ 6	m n ñ o ó ô ö ø œ 6
[7]	P Q R S 7	p q r s 7	7	P Q R S Ş ß 7	p q r s ş ß 7
[8]	T U V 8	t u v 8	8	T U Û Ú Ü Û V 8	t u ù ú ü ù v 8
[9]	W X Y Z 9	w x y z 9	9	W Ŵ X Y Ŷ Z 9	w ŵ x y ŷ z 9
[0]	Space ! ? " ' : ; + = < > 0		0	Space ! ? " ' : ; + = < > 0	
[#]	\$ % & @ € £		#	\$ % & @ € £	

- Press **[X]** before or after entering a character to change between uppercase and lowercase.
- Pressing a key repeatedly will cycle through the characters associated with that key. For example, to enter the letter "C" in Latin Mode, press **[2]** 3 times.
- Characters that are entered using the **[#]** key (for example, "\$") cannot be entered when searching the phonebook. See "Searching for an Item in the Personal Phonebook", Page 51.
- The illustrations of the keys in the table may differ in appearance from the actual keys on the telephone.

Settings Displayed in the Menu

Mode	Menu Items
During a voice call	<ul style="list-style-type: none"> ● Call History ● Phonebook ● Flash/Recall ● Park*1 ● Call Center/Call Centre*1 ● Network Camera

Mode	Menu Items
During a video call	<ul style="list-style-type: none"> ● Call History ● Phonebook ● Flash/Recall ● Park*1 ● Call Center/Call Centre*1 ● Line Status ● Blind*1 ● Voice Call ● Picture Quality ● PiP
While viewing a Network Camera video feed	<ul style="list-style-type: none"> ● Camera Registration ● Camera Selection ● Reset ● Favourites/Favorites ● Camera Settings
During a call with a Communication Camera	<ul style="list-style-type: none"> ● Call History ● Phonebook ● Flash/Recall ● Park*1 ● Call Center/Call Centre*1 ● Line Status ● Blind*1
With a call on hold in a Call Park zone	<ul style="list-style-type: none"> ● Park*1
When the phonebook is displayed	<ul style="list-style-type: none"> ● Lock Phonebook ● Unlock Phonebook

*1 This item is displayed only when the feature is enabled. Contact your administrator for further information.

Basic Settings Menu Layout

Incoming Option

Sub Item	Description	Setting	Default
Ringer Volume	Adjusts the ringer volume	Level 0 (off)–8	Level 5
Ringer Type <ul style="list-style-type: none"> ● Line 1–16 ● Private Ring (Category 1–9) 	Ringer Pattern Selects the ringtone for each type of call.*1	Ringtone 1–32	Ringtone 1*2

*1 The preset melodies in this product are used with permission of © 2010 Copyrights Vision Inc.

*2 The default ringtone is different depending on the line number.

Talk Option

Sub Item	Description	Setting	Default
Speaker Volume	Adjusts the speaker volume.	Level 1–8	Level 5
Handset Volume	Adjusts the handset volume.	Level 1–8	Level 5

Appendix

Sub Item	Description	Setting	Default
Headset Volume	Adjusts the headset speaker volume.	Level 1–8	Level 5

Answer Option

Sub Item	Description	Setting	Default
Auto Ans Device	Selects the types of devices that can be answered by Auto Answer.	<input type="checkbox"/> Speaker Phone <input type="checkbox"/> Headset	Speaker Phone
Auto Ans Delay	Selects the number of seconds before a call is automatically answered when Auto Answer is turned on.	0s–20s	6s
Auto Answer	Selects the types of calls that can be answered by Auto Answer.	<input type="checkbox"/> Voice Call <input type="checkbox"/> Voice and Video	Voice Call

Key Option

Sub Item	Description	Setting	Default
<ul style="list-style-type: none"> • Program Key • DSS Key 	Assigns a function to each program key or DSS key. Refer to “Changing the Function Keys (Program Keys and DSS Keys)”, Page 66.	<input type="checkbox"/> One Touch Dial <input type="checkbox"/> BLF <input type="checkbox"/> Line <input type="checkbox"/> ACD[Login] <input type="checkbox"/> ACD[Wrap Up] <input type="checkbox"/> Line Status <input type="checkbox"/> Call Forward <input type="checkbox"/> Phonebook <input type="checkbox"/> Call History <input type="checkbox"/> Simultaneous Ring <input type="checkbox"/> Hoteling/Hospitality <input type="checkbox"/> Transfer <input type="checkbox"/> Blind Transfer <input type="checkbox"/> Conference <input type="checkbox"/> Directed Call Pickup <input type="checkbox"/> Call Park <input type="checkbox"/> Park Retrieve <input type="checkbox"/> Network Camera	Not stored
Hot Key Time	Selects the number of seconds before a call is automatically made when a Hot Key assigned to "Auto" is pressed and held.	1s–20s	2s

Display Option

Sub Item	Description	Setting	Default
Language	Selects the display language. Up to 10 languages can be downloaded from the server or Web as necessary. Contact your administrator for further information.	Suffix: NE/X/SX <input type="checkbox"/> Auto <input type="checkbox"/> English <input type="checkbox"/> Deutsch <input type="checkbox"/> Español <input type="checkbox"/> FRANÇAIS <input type="checkbox"/> Italiano <input type="checkbox"/> Svenska <input type="checkbox"/> Nederlands <input type="checkbox"/> Português <input type="checkbox"/> Čeština	Auto
		Suffix: (none)/C <input type="checkbox"/> Auto <input type="checkbox"/> English <input type="checkbox"/> Español <input type="checkbox"/> FRANÇAIS	Auto
		Suffix: RU <input type="checkbox"/> Auto <input type="checkbox"/> English <input type="checkbox"/> РУССКИЙ <input type="checkbox"/> Українська	Auto
Backlight	Selects the length of time before the backlight turns off after returning to the standby display, the level of the backlight when it's active, and the level of the backlight when it's inactive.	<input type="checkbox"/> Screen Timeout <input type="checkbox"/> 30 sec. <input type="checkbox"/> 1 min. <input type="checkbox"/> 5 min. <input type="checkbox"/> 10 min. <input type="checkbox"/> 30 min. <input type="checkbox"/> 60 min. <input type="checkbox"/> 120 min. <input type="checkbox"/> 180 min. <input type="checkbox"/> 300 min. <input type="checkbox"/> Always On <input type="checkbox"/> Active Level Level 1–8 <input type="checkbox"/> Inactive Level <input type="checkbox"/> Low <input type="checkbox"/> Off	Screen Timeout: 1 min. Active Level: Level 8 Inactive Level: Off
Standby Display	Selects what is shown on the display while in standby mode.	<input type="checkbox"/> Phone Number <input type="checkbox"/> Phone No&Name <input type="checkbox"/> Name <input type="checkbox"/> Off	Phone Number
Category Name	Edits the names of the categories.	Max. 13 characters x Category (1–9)	Not stored

Appendix

Sub Item	Description	Setting	Default
Date Format	Selects the format for the date shown on the display in standby mode.	<input type="checkbox"/> DD-MM-YYYY <input type="checkbox"/> MM-DD-YYYY	Suffix: NE/X/ SX/RU DD-MM-YYYY Suffix: (none)/C MM-DD-YYYY
Time Format	Selects the format for the time shown on the display in standby mode.	<input type="checkbox"/> 12H <input type="checkbox"/> 24H	Suffix: NE/X/ SX/RU 24H Suffix: (none)/C 12H
Screen Saver	Selects the length of time before the screen saver activates.	<input type="checkbox"/> Off <input type="checkbox"/> 10 sec. <input type="checkbox"/> 30 sec. <input type="checkbox"/> 1 min. <input type="checkbox"/> 3 min. <input type="checkbox"/> 5 min.	Off
DSS Control	Adjusts the backlight and LCD contrast of connected KX-HDV20 units.	<input type="checkbox"/> Backlight <input type="checkbox"/> Auto <input type="checkbox"/> On Level 1–6 <input type="checkbox"/> Off <input type="checkbox"/> LCD Contrast Level 1–6	Backlight: Auto Level 6 LCD Contrast: Level 3

Key Tone

Sub Item	Description	Setting	Default
Key Tone	Turns the key tone on or off.	<input type="checkbox"/> On <input type="checkbox"/> Off	On

Bluetooth Headset

Sub Item	Description	Setting	Default
Bluetooth Headset	Registers and deregisters a Bluetooth headset.	Refer to “Bluetooth Headset”, Page 29.	Not registered

Video Options

Sub Item	Description	Setting	Default
Call Mode	Sets the type of call to make when calls are automatically connected.	<input type="checkbox"/> Voice Call <input type="checkbox"/> Video Call	Voice Call
Screen Mode	Sets the display mode of the other party's video feed when a video call is connected.	<input type="checkbox"/> Normal <input type="checkbox"/> Split	Normal
Image Sending	Sets whether the camera's video feed is sent when a video call is started.	<input type="checkbox"/> On <input type="checkbox"/> Off	On

Sub Item	Description	Setting	Default
Rate Settings	Sets the bit rate, frame rate, and image size for the video feed sent and received during a video call. You can also select whether the set bit rate is used as the maximum bit rate or as a fixed bit rate.	<input type="checkbox"/> Bit Rate <input type="checkbox"/> 128 kbps <input type="checkbox"/> 256 kbps <input type="checkbox"/> 384 kbps <input type="checkbox"/> 512 kbps <input type="checkbox"/> 768 kbps <input type="checkbox"/> 1024 kbps <input type="checkbox"/> 2048 kbps <input type="checkbox"/> Bit Rate Usage <input type="checkbox"/> Maximum <input type="checkbox"/> Fixed <input type="checkbox"/> Frame rate <input type="checkbox"/> 15 fps <input type="checkbox"/> 30 fps <input type="checkbox"/> Image Size <input type="checkbox"/> QCIF <input type="checkbox"/> QVGA <input type="checkbox"/> CIF <input type="checkbox"/> HVGAW <input type="checkbox"/> VGA	Bit Rate: 2048 kbps Bit Rate Usage: Maximum Frame rate: 30 fps Image Size: HVGAW
Camera Settings	You can adjust the quality of your video feed.	Brightness 0–6 Saturation 0–6 Contrast 0–3 Sharpness 0–6 Anti-flicker 50Hz/60Hz	Brightness: 3 Saturation: 3 Contrast: 2 Sharpness: 3 Anti-flicker: 50Hz

Network Camera

Sub Item	Description	Setting	Default
Alarm Settings	Sets Network Camera alarm notifications, the alarm disarm time, and the alarm port number.	<input type="checkbox"/> Notification <input type="checkbox"/> Off <input type="checkbox"/> Pop Up <input type="checkbox"/> Disarm Time –Disarm Time 2–10 (sec) <input type="checkbox"/> Port Number –Port Number 1024–65535	Notification: Off Disarm Time: 2 Port Number: Not stored
Camera Registration	Registers a Network Camera.	Refer to “Registering a Network Camera”, Page 56.	Not registered

Appendix

Comm. Camera

Sub Item	Description	Setting	Default
Comm. Camera	Registers a Communication Camera.	Refer to "Using a Communication Camera", Page 63.	Not registered

Other Option

Sub Item	Description	Setting	Default
Change Password*1*2	Changes the telephone password (4 digits) used for unlocking the phonebook.	Enter Old Password.*3*4 ↓ Enter New Password. ↓ Verify New Password.	Not registered
Embedded Web	Selects whether the web function and the logging function are available or not.	<input type="checkbox"/> On <input type="checkbox"/> Off	Off

*1 To avoid unauthorized access to this product:

- Set a password that is random and cannot be easily guessed.
- Change the password regularly.

*2 Make a note of the password so that you will not forget it.

*3 If a password has not already been set, you can skip the first step.

*4 For details about setting the password, see "Setting the Password", Page 27.

System Settings Menu Layout

Status

Sub Item	Description	Status
Line Status	Displays the line status.	Line 1–16 Registered/Registering/(NULL)
Firmware Version	Displays the firmware version of the telephone.	—
IP Mode	Displays the IP network mode.	IPv4/IPv6/IPv4&IPv6
IPv4 Settings	Displays information about IPv4 settings.	–IP Address*1 –Subnet Mask*1 –Default Gateway*1 –DNS 1*1 –DNS 2*1
IPv6 Settings	Displays information about IPv6 settings.	–IP Address*2 –Prefix*2 –Default Gateway*2 –DNS 1*2 –DNS 2*2
MAC Address	Displays the MAC address of the telephone.	—
LLDP	Displays the LLDP status.	On/Off

Sub Item	Description	Status
VLAN	Displays the VLAN ID and priority.	—

*1 If this item is not set, “. . .” is displayed. If the telephone is not connected to the network, “. . .” is displayed.

*2 If this item is not set, “0:0” is displayed. If the telephone is not connected to the network, “:.” is displayed.

Network Settings

Sub Item	Description	Setting	Default
IP Mode Select	Changes the network settings of the telephone. Current settings are displayed as a highlight.	<input type="checkbox"/> IPv4 <input type="checkbox"/> IPv6 <input type="checkbox"/> IPv4&IPv6	IPv4
IPv4 Settings	Specifies the IPv4 settings.	Connection Mode <input type="checkbox"/> DHCP DNS <input type="checkbox"/> Auto <input type="checkbox"/> Manual –DNS 1 –DNS 2 <input type="checkbox"/> Static –IP Address –Subnet Mask –Default Gateway –DNS 1 –DNS 2	Connection Mode: DHCP DNS: Auto
IPv6 Settings	Specifies the IPv6 settings.	Connection Mode <input type="checkbox"/> DHCP DNS <input type="checkbox"/> Auto <input type="checkbox"/> Manual –DNS 1 –DNS 2 <input type="checkbox"/> RA –DNS 1 –DNS 2 <input type="checkbox"/> Static –IP Address –Prefix –Default Gateway –DNS 1 –DNS 2	Connection Mode: DHCP DNS: Auto
LLDP	Specifies the LLDP settings.	<input type="checkbox"/> PC Port –VLAN ID –Priority <input type="checkbox"/> On/Off <input type="checkbox"/> On <input type="checkbox"/> Off	PC Port: VLAN ID: 0 Priority: 0 LLDP: On

Appendix

Sub Item	Description	Setting	Default
VLAN	Specifies the VLAN settings.	<input type="checkbox"/> Enable VLAN <input type="checkbox"/> Yes <input type="checkbox"/> No <input type="checkbox"/> IP Phone –VLAN ID –Priority <input type="checkbox"/> PC –VLAN ID –Priority	Enable VLAN: No IP Phone: VLAN ID: 2 Priority: 7 PC: VLAN ID: 1 Priority: 0
Link Speed	Specifies the Ethernet PHY mode settings.	<input type="checkbox"/> IP Phone <input type="checkbox"/> Auto <input type="checkbox"/> 100M/Full <input type="checkbox"/> 100M/Half <input type="checkbox"/> 10M/Full <input type="checkbox"/> 10M/Half <input type="checkbox"/> PC <input type="checkbox"/> Auto <input type="checkbox"/> 100M/Full <input type="checkbox"/> 100M/Half <input type="checkbox"/> 10M/Full <input type="checkbox"/> 10M/Half	Auto

System Settings

Sub Item	Description	Setting	Default
Set Time & Date* ¹	Specifies the time and date of the telephone.	–Date –Time	—
Authentication	Specifies the ID and password for HTTP authentication.	–ID* ² –Password* ²	Not stored
Access Code* ³	Specifies the access code to access the redirect server.	Max. 16 characters	Not stored
ECO Mode	Selects whether to enable ECO mode.	<input type="checkbox"/> On <input type="checkbox"/> Off	Off
Restart* ⁴	Restart the unit.	—	—
DSS Restart* ⁴	Restart any connected DSS units.	—	—

*1 Availability depends on your phone system. Contact your administrator for further information.

*2 Max. 128 characters

*3 This item is displayed only during initial setup.

*4 The unit will restart even if it is being accessed through the Web user interface or on a call.

Advanced Settings Menu Layout

Xsi Setting

Sub Item	Description	Setting	Default
Xsi Setting* ¹	Specifies the ID and password for the Xsi service.	Line 1–16 –ID* ² –Password* ²	Not stored

*1 This item is displayed only when the feature is enabled. Contact your administrator for further information.

*2 Max. 128 characters

UC Setting

Sub Item	Description	Setting	Default
UC Setting* ¹	Specifies the ID and password for the Broadsoft UC service (IM&P).	–ID* ² –Password* ²	Not stored

*1 This item is displayed only when the feature is enabled. Contact your administrator for further information.

*2 Max. 128 characters

Call Settings

Sub Item	Description	Setting	Default
Block Anonymous	Specifies whether or not to block incoming anonymous calls.	Line 1–16 <input type="checkbox"/> On <input type="checkbox"/> Off	Off
Anonymous Call* ¹	Specifies whether or not to make outgoing anonymous calls.	Line 1–16 <input type="checkbox"/> On <input type="checkbox"/> Off	Off
Block Caller ID	Edits/deletes the phone numbers to reject incoming calls.	Enter Number* ² , edit number* ² , delete number, delete all numbers	Not stored
Anywhere* ³	Specifies/edits the Xsi's Anywhere settings.	Line 1–16 Registration: –Name –Phone Number* ² Edit: –Status <input type="checkbox"/> On <input type="checkbox"/> Off –Name –Phone Number* ² –Alt. Number* ²	—

Appendix

Sub Item	Description	Setting	Default
Remote Office* ³	Specifies the Xsi's Remote Office setting.	Line 1–16 –Status <input type="checkbox"/> On <input type="checkbox"/> Off –Phone Number* ²	—
SimultaneousRing* ³	Specifies the Xsi's Simultaneous Ring setting.	Line 1–16 –Status <input type="checkbox"/> On <input type="checkbox"/> Off –Phone Number* ²	—
System Lock	Selects whether to lock the Call Settings menu.	<input type="checkbox"/> On* ⁴ <input type="checkbox"/> Off	Off

*1 This item is displayed only when the feature is enabled. Contact your administrator for further information.

*2 In a phone number that exceeds 32 digits, the exceeding digits will not be displayed.

*3 If the Xsi's service is available, you can select this item. Contact your administrator for further information.

*4 Password is required (4 digits).

Executive Filtering

Sub Item	Description	Setting	Default
Executive Filtering* ¹	Sets whether to filter calls to an executive terminal using the Broadsoft Executive-Assistant feature.	Line 1–16 <input type="checkbox"/> On <input type="checkbox"/> Off	Off

*1 This item is displayed only when the feature is enabled. Contact your administrator for further information.

Assistant Settings

Sub Item	Description	Setting	Default
Assistant Filtering* ¹	Sets whether to filter calls to an assistant terminal using the Broadsoft Executive-Assistant feature.	Line 1–16 Specify a line as "Executive". <input type="checkbox"/> On <input type="checkbox"/> Off	Off
Divert Setting* ¹	Sets the transfer feature for an executive terminal using the Broadsoft Executive-Assistant feature.	<input type="checkbox"/> On Phone Number <input type="checkbox"/> Off	Off

*1 This item is displayed only when the feature is enabled. Contact your administrator for further information.

Specifications

KX-HDV430

Item	Specifications
Power Supply	AC adaptor / PoE (IEEE 802.3af)
Power Consumption	PoE Stand-by: approx. 2.7 W (ECO mode off), approx. 2.2 W (ECO mode on) Talking: approx. 3.5 W (ECO mode off), approx. 2.8 W (ECO mode on) AC Adaptor Stand-by: approx. 2.6 W (ECO mode off), approx. 1.9 W (ECO mode on) Talking: approx. 3.4 W (ECO mode off), approx. 2.7 W (ECO mode on)
Maximum Power Consumption	Approx. 4.4 W
Operating Environment	0 °C (32 °F) to 40 °C (104 °F)
Ethernet Port	LAN: 1 (RJ45), PC: 1 (RJ45)
Ethernet Interface	10Base-T/100Base-TX/1000Base-T (Auto / 100MB-FULL / 100MB-HALF / 10MB-FULL / 10MB-HALF) Auto MDI / MDIX
Wideband Codec	G.722/G.722.2 (AMR-WB)
Narrowband Codec	G.711a-law / G.711μ-law / G.729a
Multiple Line	16
LCD Display	4.3-inch color TFT with touch panel 16,772,216 colors (Full color)
LCD Size	480 × 272 pixels
LCD Backlight	8 levels
VoIP Connection Method	SIP
Speaker	1
Microphone	1
Headset Jack	1 (RJ9)
EHS Jack	1 (ø3.5 mm [1/8 in], for EHS only)
Bluetooth	1 (Class 1)
Compatible Communication Camera	KX-NTV150/KX-NTV160
Dimensions (Width × Depth × Height; stand attached)	"High" position: 195 mm × 190 mm × 209 mm (7.7 in × 7.5 in × 8.3 in) "Low" position: 195 mm × 184 mm × 188 mm (7.7 in × 7.3 in × 7.4 in)
Weight (with handset, handset cord and stand)	870 g (1.92 lb)

Appendix

KX-HDV20

Item	Specifications
Power Supply*1	Power is supplied from the KX-HDV430.
Power Consumption	Stand-by: approx. 0.5 W
Maximum Power Consumption	Approx. 1.5 W
Operating Environment	0 °C (32 °F) to 40 °C (104 °F)
LCD Display	Monochrome graphical
LCD Size	160 × 384 pixels, 12 lines
LCD Backlight	6 levels (Always On/Automatic/Always Off)
Dimensions (Width × Depth × Height; stand attached)	"High" position: 110 mm × 176 mm × 178 mm (4.3 in × 6.9 in × 7.0 in) "Middle" position: 110 mm × 176 mm × 154 mm (4.3 in × 6.9 in × 6.1 in) "Low" position: 110 mm × 175 mm × 121 mm (4.3 in × 6.9 in × 4.8 in)
Weight (with stand)	430 g (0.95 lb)

*1 The KX-HDV20 can be used only when the KX-HDV430 is receiving power from the optional AC adaptor.

Troubleshooting

Common Issues and Solutions

General Use

Issue	Possible Cause	Solution
The display is blank.	The unit is not receiving power.	The unit is not designed to function when there is a power failure. Make sure that the device supplying PoE is receiving power and that the Ethernet cable is properly connected. If an AC adaptor is connected, confirm that the AC adaptor is connected and receiving power.
The unit is not performing properly.	Cables or cords are not connected properly.	Check all connections.
	Your connection settings are incorrect.	<ul style="list-style-type: none"> ● Consult your administrator to confirm that your settings are correct. ● If the problem persists, consult your dealer.
	An error has occurred.	Restart the unit.
I cannot hear a dial tone.	—	Confirm that the LAN cable is properly connected.
I cannot cancel the phonebook lock.	The password you entered was incorrect.	Enter the correct password.
I forgot my password.	—	Consult your administrator or dealer.
The date and time are not correct.	—	Adjust the date and time of the unit.
The Message/Ringer lamp is lit.	You received a voice message while you were on the phone or away from your desk.	Check the voice message.
The KX-HDV20 will not turn on.	The KX-HDV430 is receiving power via Power-over-Ethernet (PoE).	Connect the KX-HDV430 to an AC power outlet using the optional AC adaptor.



Making and Receiving Calls

Issue	Possible Cause	Solution
I cannot make calls.	The phone number was entered incorrectly.	<ul style="list-style-type: none"> ● Confirm that you have entered the phone number of the other party correctly. ● Consult your administrator or dealer.
	The phonebook list is being imported or exported.	<ul style="list-style-type: none"> ● Wait a few minutes for the operation to complete. ● Confirm with your administrator or dealer.

Appendix

Issue	Possible Cause	Solution
I cannot make long distance calls.	Your telephone service does not allow you to make long distance calls.	Make sure that you have subscribed to your telephone company's long distance service.
The unit does not ring when a call is received.	The ringer is turned off.	Press the [+] volume key while a call is being received, or change the ringer volume setting.
While talking to an outside party, the line is disconnected.	Your phone system/service may impose a time limit on outside calls.	Consult your dealer to extend the time limit, if necessary.

Sound Quality

Issue	Possible Cause	Solution
The other party cannot hear my voice.	The unit is muted.	Press  /  /[MUTE/AUTO ANS] to turn off the mute feature.
	If you are using the speakerphone, objects may be obstructing the microphone.	Do not obstruct the unit's microphone during calls. Keep your hands, as well as common objects such as folders, cups, and coffee pots away from the unit during calls.
Sound cuts out; I can hear myself through the speaker.	You are too far away from the microphone.	Try speaking closer to the microphone.
	The environment is not suited to speakerphone calls.	<ul style="list-style-type: none"> ● Do not use the unit within 2 m (6 ft 7 in) of projectors, air conditioning devices, fans, or other audible or electrical noise emitting devices. ● If using the unit in a room with windows, close the curtains or blinds to prevent echoes. ● Use the unit in a quiet environment.
	The unit was moved during a call.	Do not move the unit while on a call.
	Objects are obstructing the microphone.	Do not obstruct the unit during calls. Keep your hands, as well as common objects such as folders, cups, and coffee pots away from the unit during calls.
	The other party is using a half-duplex speakerphone.	If the other party is using a half-duplex speakerphone, sound may cut out occasionally during calls. For best performance, the other party should use a full-duplex speakerphone.

Phonebook List

Issue	Possible Cause	Solution
I cannot add or edit entries to the phonebook list.	The phonebook list is full.	Delete any unnecessary entries. The maximum number of entries in the phonebook list is 2500.

Bluetooth Headset

Issue	Possible Cause	Solution
I cannot have a conversation using the Bluetooth headset.	The headset is not registered.	Make sure that the headset is properly registered to the unit.
	An EHS headset is connected.	Remove the EHS headset from the headset jack. Priority is given to the EHS headset when both are connected.
	The headset is not charged.	Make sure that the headset is properly charged by following the instructions in the headset's documentation.

Error Messages

During operation, error messages might appear on the unit. The following table lists these messages and possible causes and solutions.

Error Message	Possible Cause	Solution
Error:001 Check LAN cable.	The LAN cable is not connected.	Check all connections.
Error:002 IP Address Collision	The unit's network settings are incorrect.	Consult your system administrator or dealer.
Error:002 IP Address		
Error:003 Not Registered	Failed to register to SIP server.	Consult your system administrator or dealer.
Memory Full	The phonebook is full and cannot store the new item.	Remove unnecessary data in the phonebook and try again.
No Entries	When trying to view the phonebook: No items have been stored. See "Storing an Item in the Personal Phonebook", Page 47. When trying to view the Incoming or Outgoing Call Log: No logs have been stored.	
Need Repair	Device fault.	Contact your phone system dealer/service provider.
Phonebook Error	The memory became full during a phonebook download.	<ul style="list-style-type: none"> ● Remove unnecessary data in the phonebook, or consult your administrator regarding the number of items being downloaded. ● This message disappears if you access the phonebook.



WALL MOUNTING TEMPLATE 1
(KX-HDV430, optionally with 1 attached KX-HDV20)

1. Drive the screws into the wall as indicated.
2. Hook the unit onto the screw heads.

Note:

Make sure to set the print size to correspond with the size of this page. If the dimensions of the paper output still deviate slightly from the measurements indicated here, use the measurements indicated here.

For KX-HDV20

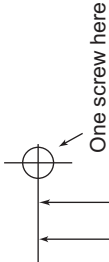

For KX-HDV430

100 mm (3 ¹⁵/₁₆ in)

83 mm (3 ¹/₄ in)

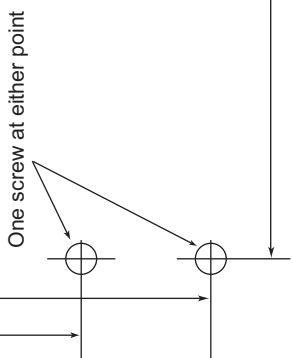
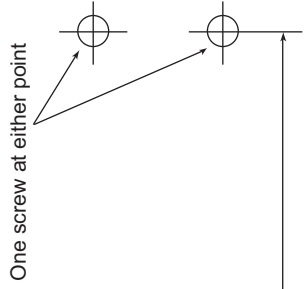
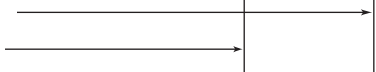

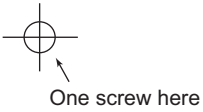

Previously mounted KX-HDV20
(for reference)

WALL MOUNTING TEMPLATE 2
(For mounting 2 or more KX-HDV20 units)

1. Drive the screws into the wall as indicated.
2. Hook the unit onto the screw heads.

Note:

Make sure to set the print size to correspond with the size of this page. If the dimensions of the paper output still deviate slightly from the measurements indicated here, use the measurements indicated here.

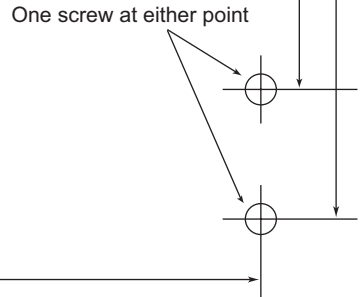
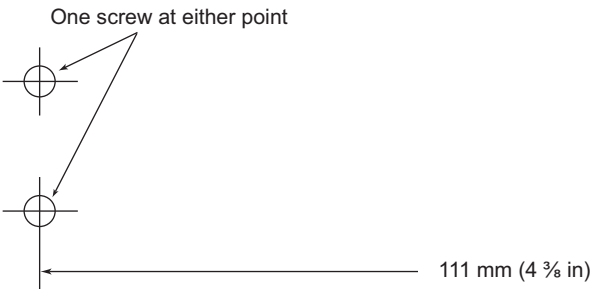
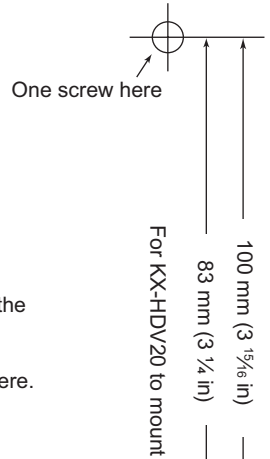

Panasonic System Networks Co., Ltd.

1-62, 4-chome, Minoshima, Hakata-ku, Fukuoka 812-8531, Japan

Web Site: <http://www.panasonic.net/pcc/support/sipphone/>

Panasonic Corporation of North America

Two Riverfront Plaza, Newark, NJ 07102-5490

Web Site: <http://www.panasonic.net/pcc/support/sipphone/>

Panasonic Canada Inc.

5770 Ambler Drive, Mississauga, Ontario, L4W 2T3

Web Site: <http://www.panasonic.com/ca/>

Copyright:

This material is copyrighted by Panasonic System Networks Co., Ltd., and may be reproduced for internal use only. All other reproduction, in whole or in part, is prohibited without the written consent of Panasonic System Networks Co., Ltd.