

## Test Report

<b>Product</b>	UPCS Transceiver in Outdoor Camera	
<b>Name and address of the applicant</b>	Panasonic Corporation of North America	
<b>Name and address of the manufacturer</b>	Panasonic System Networks Co., Ltd. 1-62, 4-chome, Minoshima, Hakata-ku Fukuoka 812-8531, Japan	
<b>Model</b>	KX-HNC600	
<b>Rating</b>	120 V AC (Mains)	
<b>Trademark</b>	Panasonic	
<b>Serial number</b>	/	
<b>Additional information</b>	DECT 6.0	
<b>Tested according to</b>	<b>FCC Part 15, subpart D</b> Isochronous UPCS Device, 1920 – 1930 MHz <b>Industry Canada RSS 213, Issue 2</b> 2 GHz License-exempt Personal Communications Service Devices (LE-PCS)	
<b>Order number</b>	258223	
<b>Tested in period</b>	2014.05.07 to 2014.05.14	
<b>Issue date</b>	2014.05.26	
<b>Name and address of the testing laboratory</b>	 FCC No: 994405 IC OATS: 2040D-1  Instituttveien 6 Kjeller, Norway  TEL: (+47) 22 96 03 30 FAX: (+47) 22 96 05 50	
	 Prepared by [Frode Sveinsen]	 Approved by [G.Suhanthakumar]
This report shall not be reproduced except in full without the written approval of Nemko. Opinions and interpretations expressed within this report are not part of the current accreditation. This report was originally distributed electronically with digital signatures. For more information contact Nemko.		

## CONTENTS

<b>1</b>	<b>INFORMATION .....</b>	<b>3</b>
1.1	Tested Item.....	3
1.2	Description of Tested Device.....	3
1.3	Exposure Evaluation.....	3
1.4	Test Environment .....	4
1.5	Test Engineer(s).....	4
1.6	Test Equipment .....	4
1.7	Other Comments .....	4
<b>2</b>	<b>TEST REPORT SUMMARY .....</b>	<b>5</b>
2.1	General.....	5
2.2	Test Summary .....	6
<b>3</b>	<b>TEST RESULTS.....</b>	<b>7</b>
3.1	Power Line Conducted Emissions.....	7
3.2	Coordination with fixed microwave .....	10
3.3	Digital Modulation Techniques .....	10
3.4	Labeling Requirements .....	10
3.5	Antenna Requirement.....	11
3.6	Channel Frequencies .....	11
3.7	Automatic Discontinuation of Transmission .....	12
3.8	Peak Power Output .....	13
3.9	Emission Bandwidth <i>B</i> .....	16
3.10	Power Spectral Density .....	19
3.11	In-Band Unwanted Emissions, Conducted .....	22
3.12	Out-of-band Emissions, Conducted.....	24
3.13	Carrier Frequency Stability .....	30
3.14	Frame Repetition Stability .....	31
3.15	Frame Period and Jitter .....	31
3.16	Monitoring Threshold, Least Interfered Channel .....	33
3.17	Threshold Monitoring Bandwidth .....	35
3.18	Reaction Time and Monitoring Interval.....	36
3.19	Time and Spectrum Window Access Procedure .....	38
3.20	Acknowledgements and Transmission Duration .....	39
3.21	Dual Access Criteria Check.....	41
3.22	Alternative Monitoring Interval .....	45
<b>4</b>	<b>TEST SETUPS .....</b>	<b>46</b>
4.1	Frequency Measurements.....	46
4.2	Timing Measurements .....	46
4.3	Conducted Emission Test.....	46
4.4	Power Line Conducted Emissions Test.....	46
4.5	Monitoring Tests .....	47
<b>5</b>	<b>TEST EQUIPMENT USED .....</b>	<b>48</b>

## 1 INFORMATION

### 1.1 Tested Item

Name :	Panasonic
Model name :	KX-HNC600
FCC ID :	ACJ96NKX-HNC600
Industry Canada ID :	216A-KXHNC600
Serial number :	/
Hardware identity and/or version:	PNLB2371xx
Software identity and/or version :	SW401
Tested to IC Radio Standard (RSS) :	RSS-213 Issue 2, RSS-GEN Issue 3
Test Site IC Reg. Number :	IC 2040D-1
Frequency Range :	1921.536 – 1928.448 MHz
Number of Channels :	5 RF Channels, 5x12 = 60 TDMA Duplex Channels
Type of Modulation :	Digital (Gaussian Frequency Shift Keying)
Conducted Output Power :	62 mW (Peak)
Antenna Connector :	None
Number of Antennas :	1
Antenna Diversity Supported :	No
Power Supply :	AC Adaptor Model: PNLV236

### 1.2 Description of Tested Device

The EUT is an Indoor Camera with DECT Transmitter and is an initiating device as described in ANSI C63.17 and is designed to operate together with a DECT fixed part (i.e. a base station), which is the responding device.

### 1.3 Exposure Evaluation

The EUT is a fixed device and the user manual contains a statement that it should be installed at least 20cm away from any persons.

## 1.4 Test Environment

Temperature:	20.7 – 21.8 °C
Relative humidity:	36 - 43 %
Normal test voltage:	120 V AC (with AC Adaptor PNLV236)

The values are the limit registered during the test period.

## 1.5 Test Engineer(s)

Frode Sveinsen  
Thanh Tran

## 1.6 Test Equipment

See list of test equipment in clause 6.

## 1.7 Other Comments

The Monitoring and Time and Spectrum Window Access tests were performed with Test Set-Up 6 (Ref. clause 5). A clock signal from the companion device was used to synchronize the Pulse Pattern Generator and the Spectrum Analyzer to the start of the DECT time window. The EUT was limited by administrative commands to operate on only two frequency carriers. For the tests where the EUT was required to operate on only one frequency carrier, one carrier was blocked by applying a CW interfering signal from RF Generator 3. The Pulse Pattern Generator was used to apply time synchronized interference to time windows where this was required.

This EUT supports Least Interfered Channel procedure (LIC), the Monitoring and Time and Spectrum Window Access tests were conducted as specified for EUTs that support LIC procedure.

All tests except Power-Line Conducted Emissions were performed in conducted mode with a temporary antenna connector.

## 2 TEST REPORT SUMMARY

### 2.1 General

All measurements are traceable to national standards.

The tests were conducted on a sample of the equipment for the purpose of demonstrating compliance with FCC CFR47 Part 15D for Isochronous UPCS Devices and Industry Canada RSS-213 Issue 2 / RSS-GEN Issue 3.

All tests were conducted in accordance with ANSI C63.4-2009 and ANSI C63.17-2006. Antenna Gain tests were made in a 3m fully-anechoic chamber.

A description of the test facility is on file with the FCC and Industry Canada.

New Submission

Production Unit

Class II Permissive Change

Pre-production Unit

**PUB** Equipment Code

Family Listing



#### **THIS TEST REPORT APPLIES ONLY TO THE ITEM(S) AND CONFIGURATIONS TESTED.**

Deviations from, additions to, or exclusions from the test specifications are described in "Summary of Test Data".

Nemko Group authorizes the above named company to reproduce this report provided it is reproduced in its entirety and for use by the company's employees only. Any reproduction of parts of this report requires approval in writing from Nemko Group.

Any use which a third party makes of this report, or any reliance on or decisions to be made based on it, are the responsibility of such third parties. Nemko Group accepts no responsibility for damages suffered by any third party as a result of decisions made or actions based on this report.

## 2.2 Test Summary

Name of test	FCC CFR 47 Paragraph #	IC RSS-213 Paragraph #	Verdict
Power Line Conducted Emission	15.107(a) 15.207(a)	6.3 RSS-GEN 7.2.2	Complies
Coordination with fixed microwave	15.307(b)	N/A	Complies
Digital Modulation Techniques	15.319(b)	6.1	Complies
Labeling requirements	15.19(a)(3)	3 RSS-GEN 5.2	Complies
Antenna Requirement	15.317, 15.203	RSS-GEN 7.1.2	Complies
Channel Frequencies	15.303	1	Complies
Automatic discontinuation of transmission	15.319(f)	4.3.4(a)	Complies
Emission Bandwidth	15.323(a)	6.4	Complies
In-band emissions	15.323(d)	6.7.2	Complies
Out-of-band emissions	15.323(d)	6.7.1	Complies
Output Power and Antenna Gain	15.319(c)(e), 15.31(e)	6.5 and 4.1(e)	Complies
Power Spectral Density	15.319(d)	4.3.2.1	Complies
Carrier frequency stability	15.323(f)	6.2	Complies
Frame repetition stability	15.323(e)	4.3.4(c)	Complies
Frame period and jitter	15.323(e)	4.3.4(c)	Complies
Monitoring threshold, Least interfered channel	15.323(c)(2);(5); (9)	4.3.4(b)	Complies
Monitoring of intended transmit window and maximum reaction time	15.323(c)(1)	4.3.4(b)	Complies
Threshold monitoring bandwidth	15.323(c)(7)	4.3.4(b)	Complies
Reaction time and monitoring interval	15.323(c)(1);(5); (7)	4.3.4(b)	Complies
Access criteria test interval	15.323(c)(4);(6)	4.3.4(b)	N/A <sup>1</sup>
Access Criteria functional test	15.323(c)(4);(6)	4.3.4(b)	N/A <sup>1</sup>
Acknowledgements	15.323(c)(4)	4.3.4(b)	Complies
Transmission duration	15.323(c)(3)	4.3.4(b)	Complies
Dual access criteria	15.323(c)(10)	4.3.4(b)	Complies
Alternative monitoring interval	15.323(c)(10);(11)	4.3.4(b)	N/A <sup>2</sup>
Spurious Emissions (Radiated)	15.319(g) 15.109(a) 15.209(a)	4.3.3 RSS-GEN 7.2.3	N/A <sup>3</sup>

<sup>1</sup> Only applies for equipment that transmits unacknowledged control and signaling information

<sup>2</sup> The client declares that the tested equipment does not implement this provision

<sup>3</sup> Not required if the Conducted Out-of-Band Emissions test is Passed

### 3 TEST RESULTS

#### 3.1 Power Line Conducted Emissions

Para. No.: 15.207 (a)

Test Performed By: Thanh Tran	Date of Test: 13-May-2014
-------------------------------	---------------------------

Measurement procedure: ANSI C63.4-2009 using 50  $\mu$ H/50 ohms LISN.

Test Results: Complies

Measurement Data: See attached graph, (Peak detector).

Highest measured value (L1 and N):

(Plots show maximum of Phase L1 and N)

**Standby Mode with PNLV236 Adaptor, 120V 60Hz:**

Frequency [MHz]	Level [dBuV]	Af [dB]	Limit [dBuV]	Margin [dB]	Det	Position	Verdict [Pass/Fail]
0.395000	39.00	10.20	58.00	19.00	QP	L1	Pass
0.370000	29.00	10.20	48.50	19.50	AV	L1	Pass
0.395000	36.50	10.20	48.00	11.50	AV	L1	Pass
0.445000	20.20	10.20	47.00	26.80	AV	L1	Pass
0.480000	11.20	10.20	46.30	35.10	AV	L1	Pass
0.740000	22.10	10.20	46.00	23.90	AV	L1	Pass
0.760000	19.40	10.20	46.00	26.60	AV	L1	Pass
0.785000	17.40	10.20	46.00	28.60	AV	N	Pass
0.815000	19.90	10.20	46.00	26.10	AV	N	Pass
0.840000	18.90	10.20	46.00	27.10	AV	N	Pass
0.945000	15.10	10.20	46.00	30.90	AV	N	Pass
1.155000	17.10	10.20	46.00	28.90	AV	N	Pass
1.180000	15.00	10.20	46.00	31.00	AV	N	Pass
1.240000	11.70	10.20	46.00	34.30	AV	L1	Pass
1.455000	13.90	10.20	46.00	32.10	AV	L1	Pass
22.325000	14.30	11.30	50.00	35.70	AV	N	Pass

**Transmit Mode with PNLV236 Adaptor, 120V 60Hz:**

Frequency [MHz]	Level [dBuV]	Af [dB]	Limit [dBuV]	Margin [dB]	Det	Position	Verdict [Pass/Fail]
0.395000	39.20	10.20	58.00	18.80	QP	L1	Pass
0.750000	30.30	10.20	56.00	25.70	QP	N	Pass
0.170000	16.00	10.10	55.00	39.00	AV	L1	Pass
0.370000	28.40	10.20	48.50	20.10	AV	L1	Pass
0.395000	36.50	10.20	48.00	11.50	AV	L1	Pass
0.570000	17.30	10.20	46.00	28.70	AV	N	Pass
0.750000	9.00	10.20	46.00	37.00	AV	N	Pass
0.785000	18.00	10.20	46.00	28.00	AV	N	Pass
0.830000	6.90	10.20	46.00	39.10	AV	N	Pass
0.865000	17.00	10.20	46.00	29.00	AV	N	Pass
0.950000	12.00	10.20	46.00	34.00	AV	N	Pass
1.695000	10.70	10.20	46.00	35.30	AV	L1	Pass
1.925000	12.20	10.20	46.00	33.80	AV	L1	Pass
8.670000	15.10	10.60	50.00	34.90	AV	L1	Pass
12.200000	13.00	10.70	50.00	37.00	AV	L1	Pass
18.000000	11.30	11.00	50.00	38.70	AV	L1	Pass
22.205000	15.20	11.30	50.00	34.80	AV	N	Pass



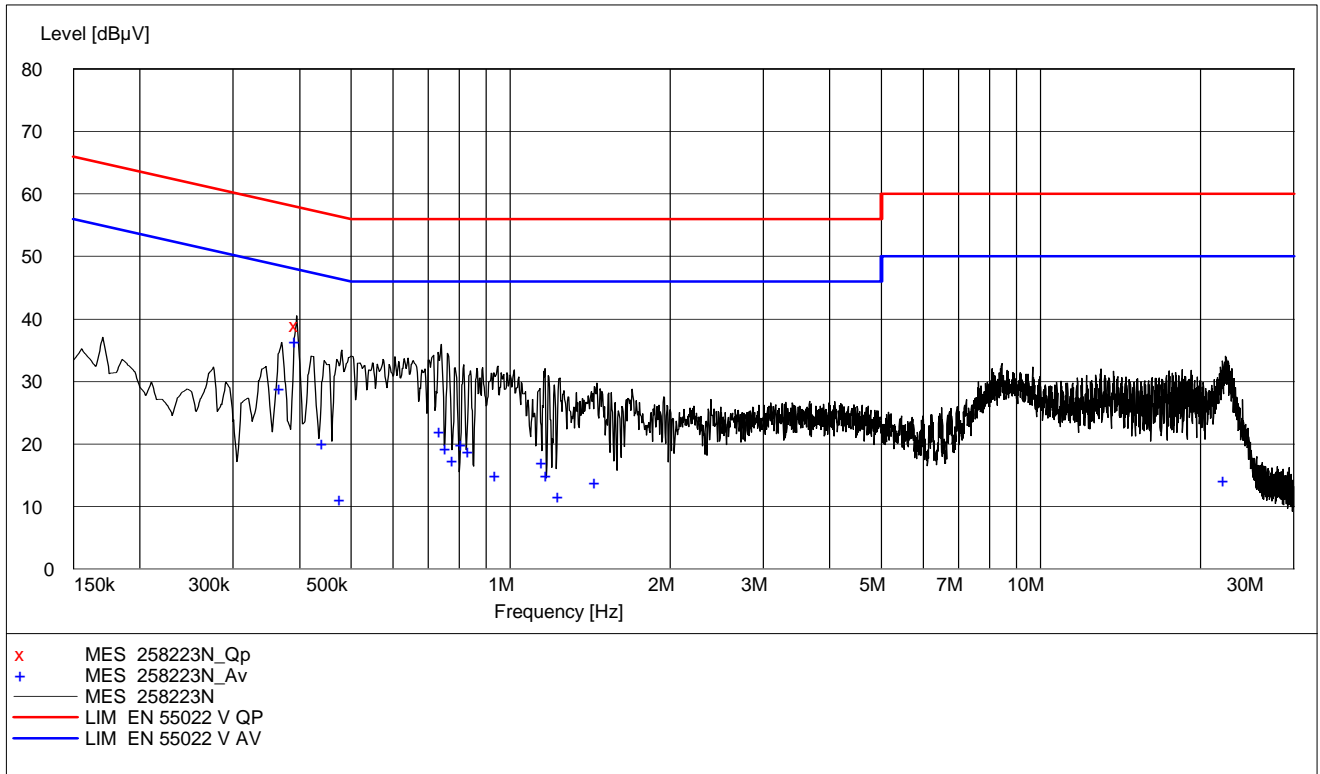

**Standby Mode with PNLV236 Adaptor, 120V 60Hz**

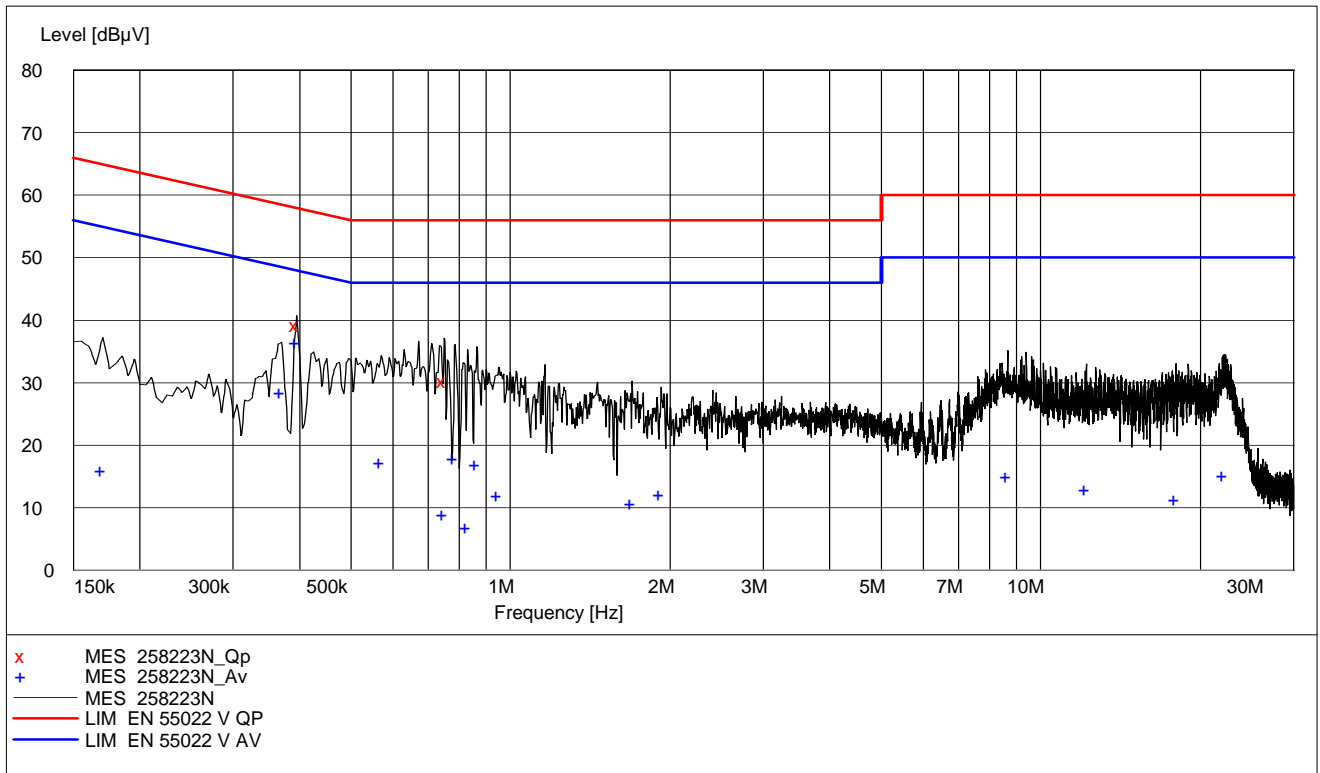

**Transmit Mode with PNLV236 Adaptor, 120V 60Hz**

### 3.2 Coordination with fixed microwave

The affidavit from UTAM, Inc. is included in the documentation supplied by the applicant:

Yes

No

#### Requirement, FCC 15.307 (b):

Each application for certification of equipment operating under the provisions of this Subpart must be accompanied by an affidavit from UTAM, Inc. certifying that the applicant is a participating member of UTAM, Inc. In the event a grantee fails to fulfill the obligations attendant to participation in UTAM, Inc., the Commission may invoke administrative sanctions as necessary to preclude continued marketing and installation of devices covered by the grant of certification, including but not limited to revoking certification.

### 3.3 Digital Modulation Techniques

The EUT uses Multi Carrier / Time Division Multiple Access / Time Division Duplex and Digital GFSK modulation. For further details see the operational description provided by the applicant.

#### Requirement, FCC 15.319(b):

All transmissions must use only digital modulation techniques.

### 3.4 Labeling Requirements

See separate documents showing the label design and the placement of the label on the EUT.

#### Requirements FCC 15.19

The FCC Identifier shall be displayed on the label, and the device(s) shall bear the following statement in a conspicuous location on the device or in the user manual if the device is too small:

*This device complies with Part 15 of the FCC Rules. Operation is subject to the following two conditions: (1) this device may not cause harmful interference, and (2) this device must accept any interference received, including interference that may cause undesired operation.*

The label itself shall be of a permanent type, not a paper label, and shall last the lifetime of the equipment.

### 3.5 Antenna Requirement

Does the EUT have detachable antenna(s)?

Yes  No

If detachable, is the antenna connector(s) non-standard?

Yes  No

The tested equipment has only integral antennas. The conducted tests were performed on a sample with a temporary antenna connector.

**Requirement: FCC 15.203, 15.204, 15.317.**

### 3.6 Channel Frequencies

UPCS CHANNEL	FREQUENCY (MHz)
Upper Band Edge	1930.000
0 (Highest)	1928.448
1	1926.720
2	1924.992
3	1923.264
4 (Lowest)	1921.536
Lower Band Edge	1920.000

**Requirement: FCC 15.303**

Within 1920 -1930 MHz band for isochronous devices.

### 3.7 Automatic Discontinuation of Transmission

Does the EUT transmit Control and Signaling Information?	<input type="checkbox"/> YES	<input checked="" type="checkbox"/> NO
TYPE OF EUT :	<input checked="" type="checkbox"/> INITIATING DEVICE	<input type="checkbox"/> RESPONDING DEVICE

The following tests simulate the reaction of the EUT in case of either absence of information to transmit or operational failure after a connection with the companion device is established.

Number	Test	EUT Reaction	Verdict
1	Power removed from EUT	C	Pass
2	Switch Off EUT	N/A	Pass
3	Hook-On by EUT	N/A	Pass
4	Power Removed from Companion Device	A	Pass
5	Switch Off Companion Device	N/A	Pass
6	Hook-On by Companion Device	N/A	Pass

- A - Connection breakdown, Cease of all transmissions
- B - Connection breakdown, EUT transmits control and signaling information
- C - Connection breakdown, Companion Device transmits control and signaling information
- N/A - Not Applicable (Neither EUT nor Companion Device have On/Off switch or can perform Hook-On)

#### Requirements, FCC 15.319(f)

The device shall automatically discontinue transmission in case of either absence of information to transmit or operational failure. These provisions are not intended to preclude transmission of control and signaling information or use of repetitive codes used by certain digital technologies to complete frame or burst intervals.

### 3.8 Peak Power Output

**Test Method:**

ANSI C63.17, clause 6.1.2.

**Test Results: Complies**

**Measurement Data:**

**Maximum Conducted Output Power**

Channel No.	Frequency (MHz)	Maximum Conducted Output Power (dBm)	Maximum Antenna Gain (dBi)	Maximum Radiated Output Power (dBm)
4	1921.536	17.6	0.0*	17.6
2	1924.992	18.0	0.0*	18.0
0	1928.448	17.8	0.0*	17.8

\*Antenna gain value is declared by the manufacturer.

**Limit:**

Conducted:  $100 \mu\text{W} \times \text{SQRT}(B)$  where  $B$  is the measured Emission Bandwidth in Hz

FCC 15.319(c)(e): 20.76 dBm (119 mW)

RSS-213, Issue 2: 20.51 dBm (113 mW)

The antenna gain is below 3 dBi, no reduction in transmit power is necessary.

**Requirements, FCC 15.319(c)(e), RSS-213, Issue 2**

Peak transmit power shall not exceed 100 microwatts multiplied by the square root of the emission bandwidth in Hertz.

The peak transmit power shall be reduced by the amount in decibels that the maximum directional gain of the antenna exceeds 3 dBi.

### Conducted Peak Output Power

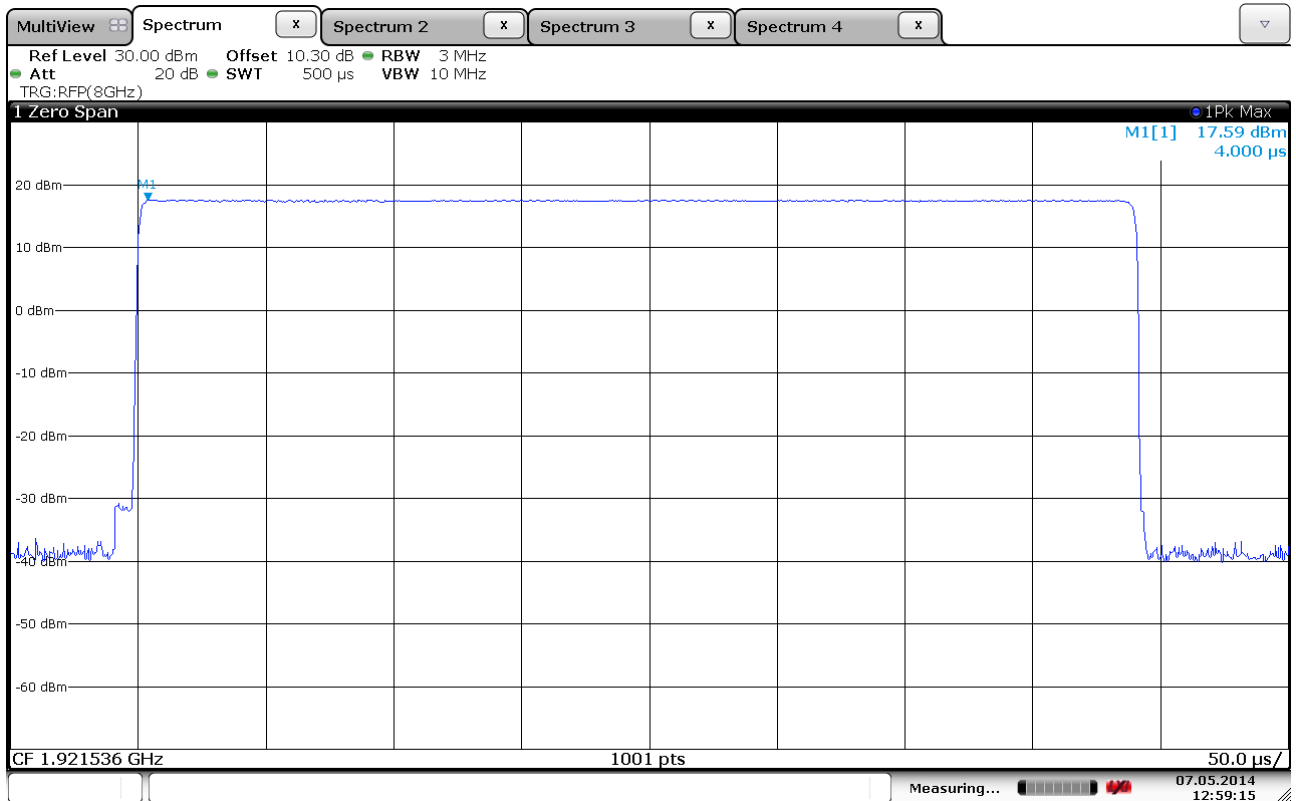

### Lower Channel

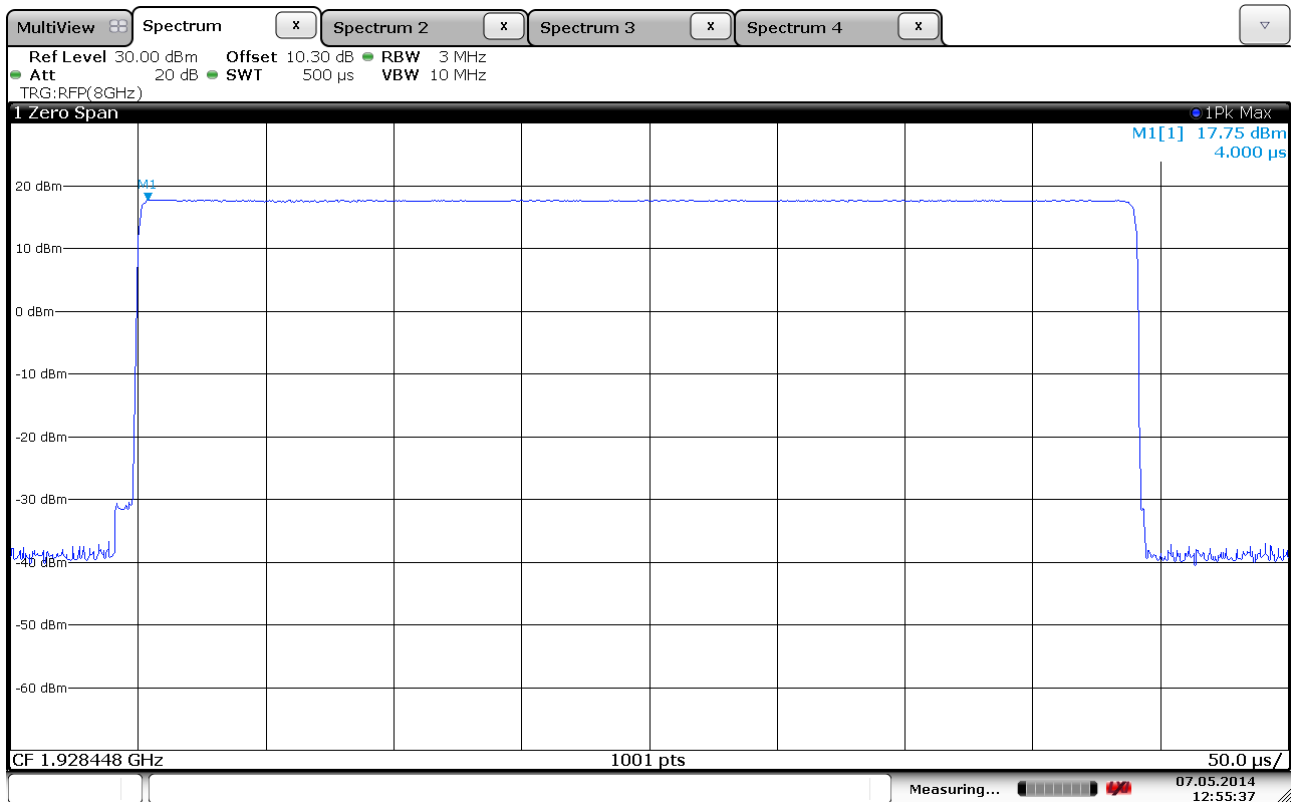

### Upper Channel

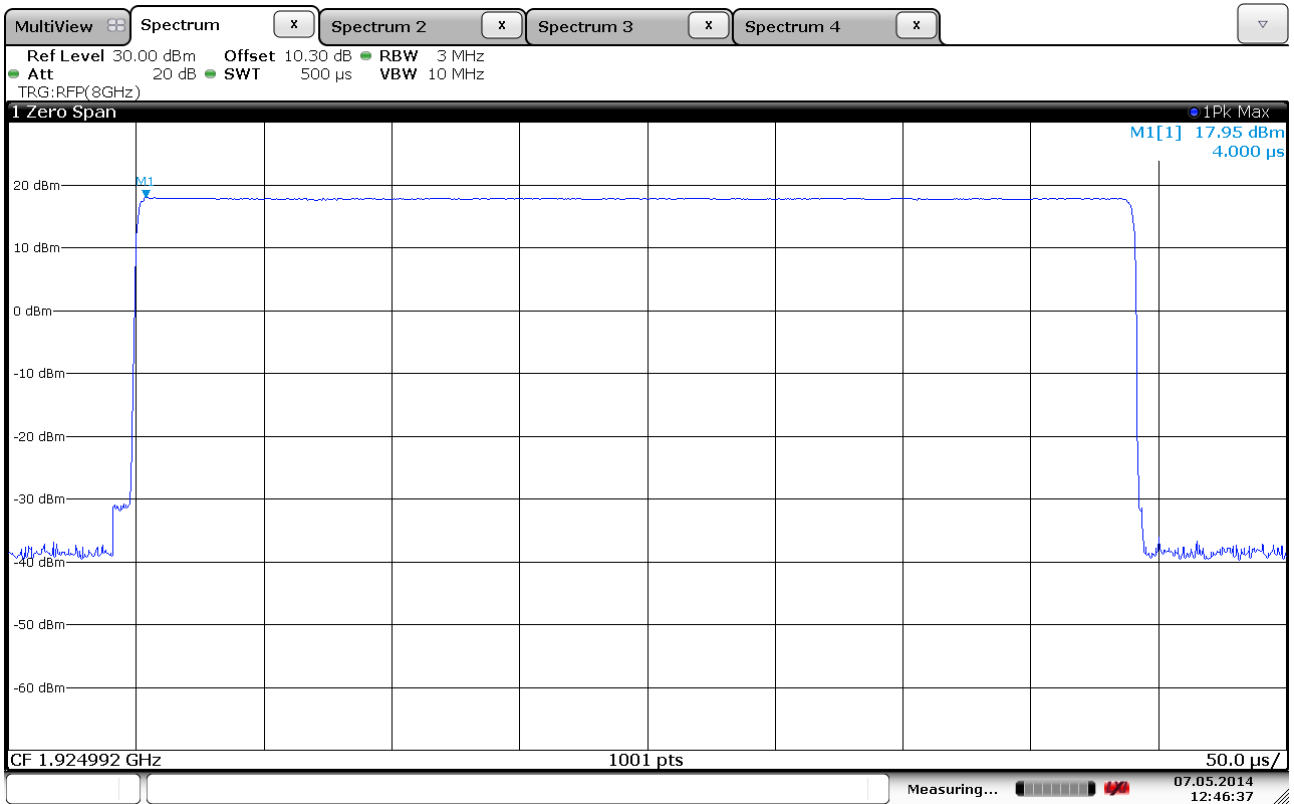

**Middle Channel**

### 3.9 Emission Bandwidth *B*

**Test Method:**

ANSI C63.17, clause 6.1.3.

**Test Results: Complies**

**Measurement Data:**

Channel No.	Frequency (MHz)	26 dB Bandwidth <i>B</i> (kHz)
4	1921.536	1420
0	1928.448	1410

Channel No.	Frequency (MHz)	99% Bandwidth (kHz)
2	1924.992	1266

Channel No.	Frequency (MHz)	6 dB Bandwidth (kHz)
4	1921.536	N/A
0	1928.448	N/A

Channel No.	Frequency (MHz)	12 dB Bandwidth (kHz)
4	1921.536	N/A
0	1928.448	N/A

**Requirements, FCC 15.323(a)**

The 26 dB Bandwidth *B* shall be larger than 50 kHz and less than 2.5 MHz.

**Requirements, RSS-213 Issue 2, clause 6.4**

The 99% Bandwidth shall be larger than 50 kHz and less than 2.5 MHz.

No requirements for 6 and 12 dB Bandwidth, these values are only used for testing Monitoring Bandwidth if the Simple Compliance test fails (ANSI C63.17, clause 7.4).



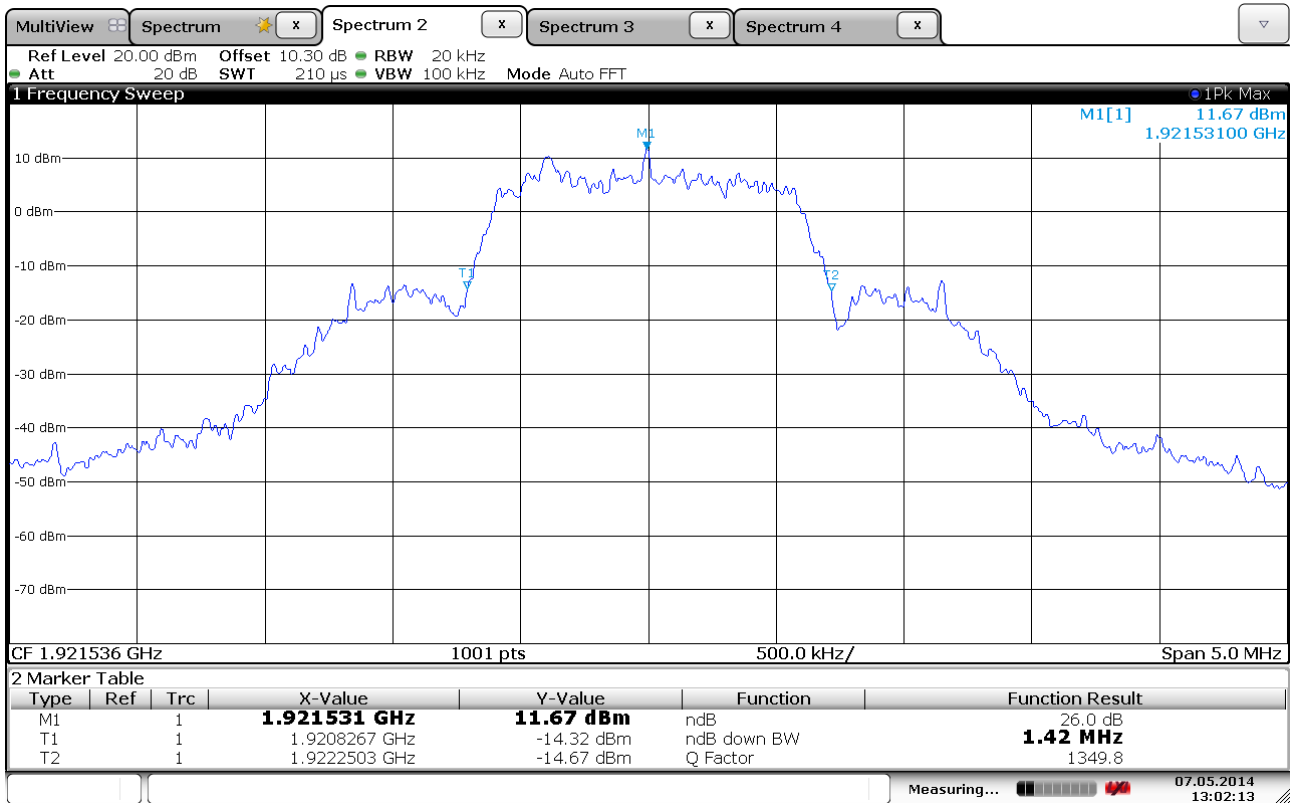

Emission Bandwidth B, Lower Channel

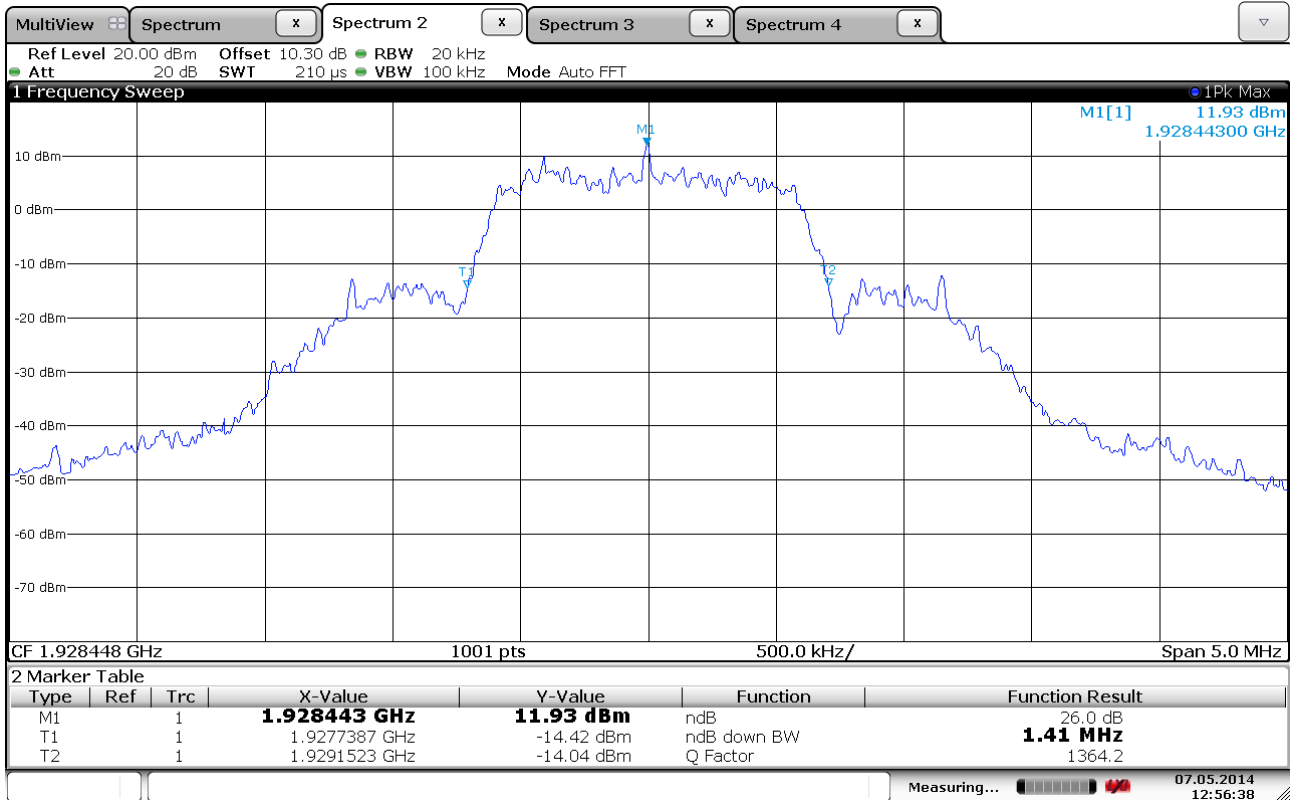

Emission Bandwidth B, Upper Channel

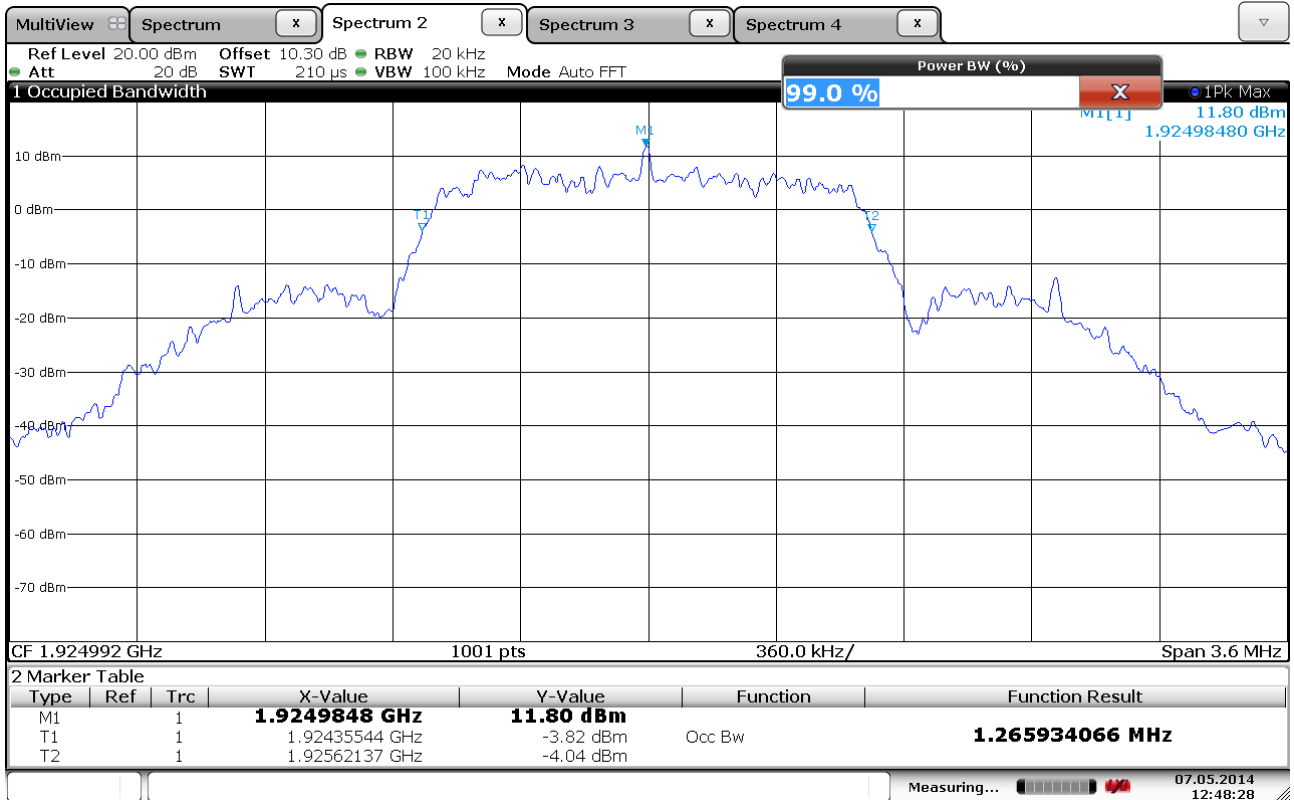

**99% Bandwidth, Middle Channel**

### 3.10 Power Spectral Density

**Test Method:**

ANSI C63.17, clause 6.1.5.

**Test Results: Complies**

**Measurement Data:**

Channel No.	Frequency (MHz)	Power Spectral Density (dBm)
4	1921.536	1.1
0	1928.448	1.3

Averaged over 1000 sweeps.

**Requirements, FCC 15.319(d)**

The Power Spectral Density shall be less than 3 mW (4.77 dBm) when averaged over at least 100 sweeps.

## Power Spectral Density

### Lower Channel:

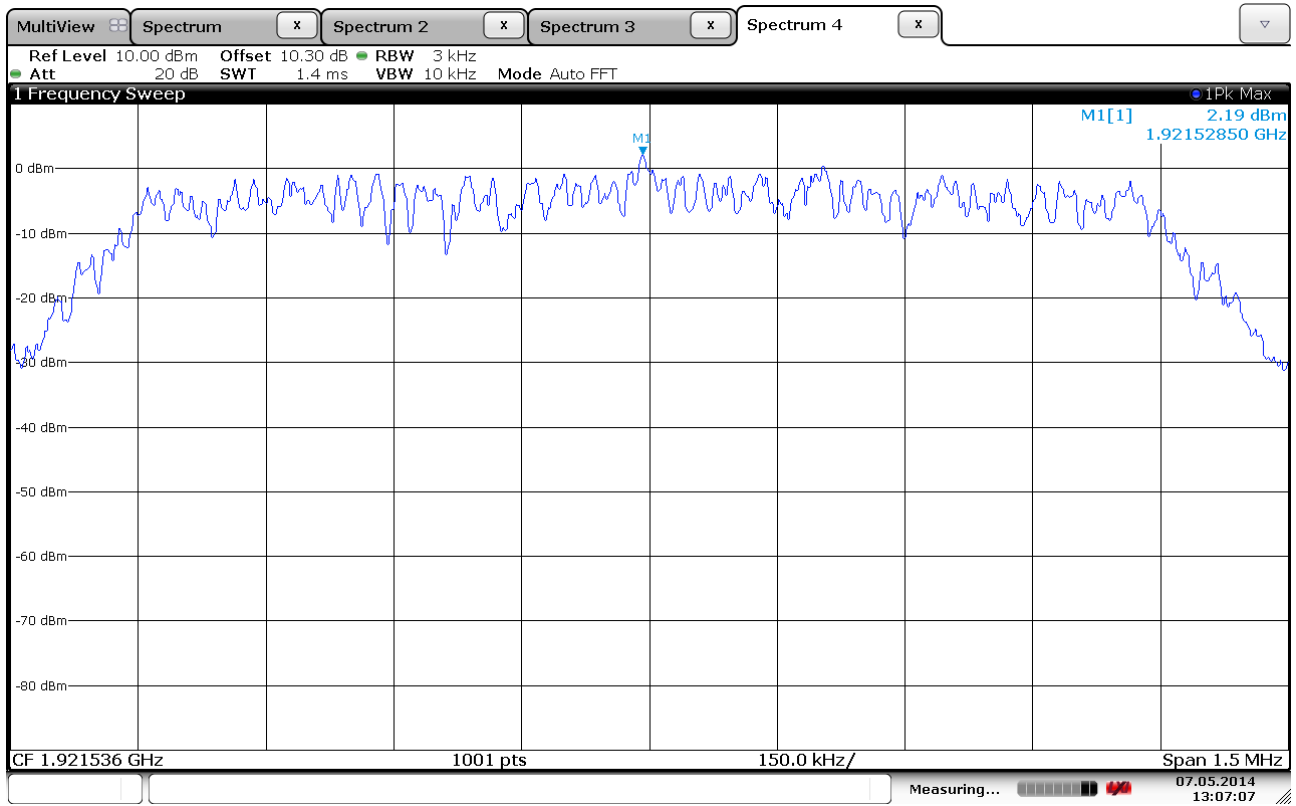

### Overview

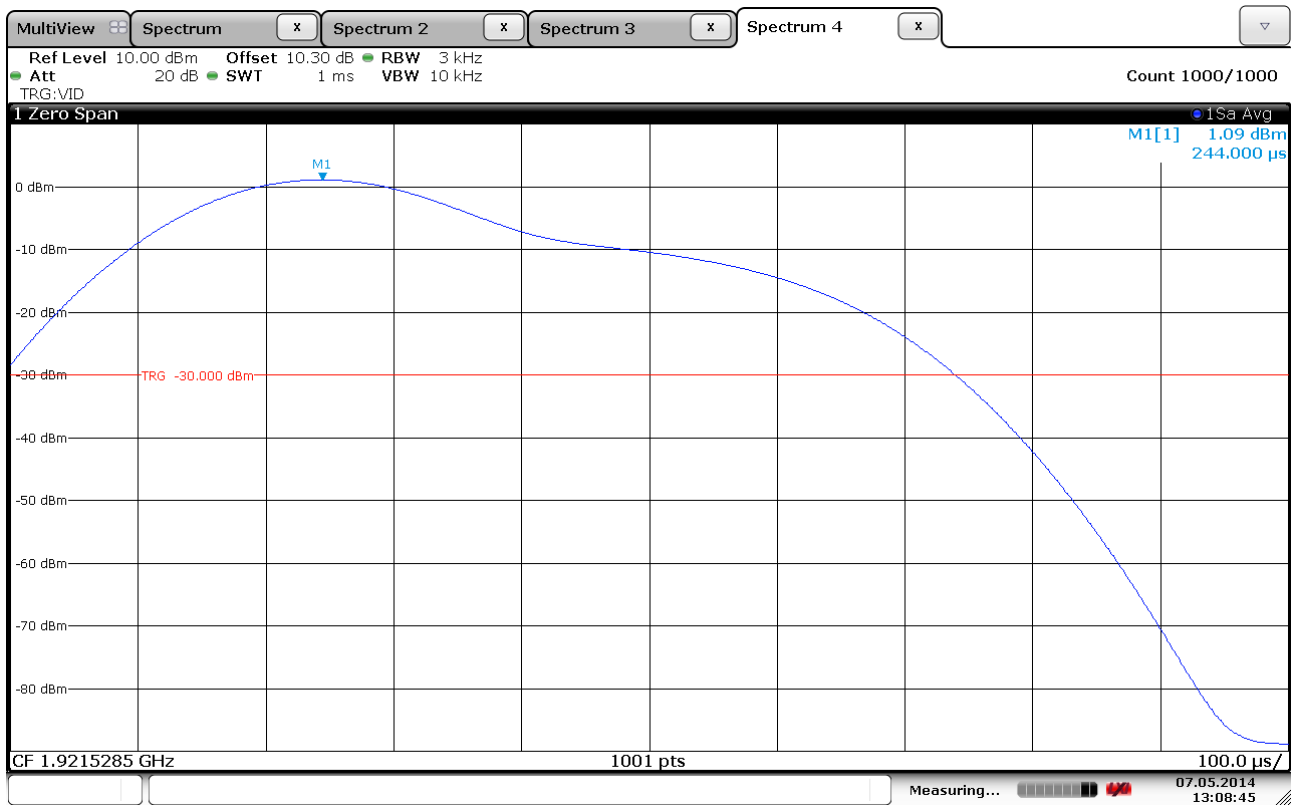

### Averaged, 1000 Sweeps

### Upper Channel:

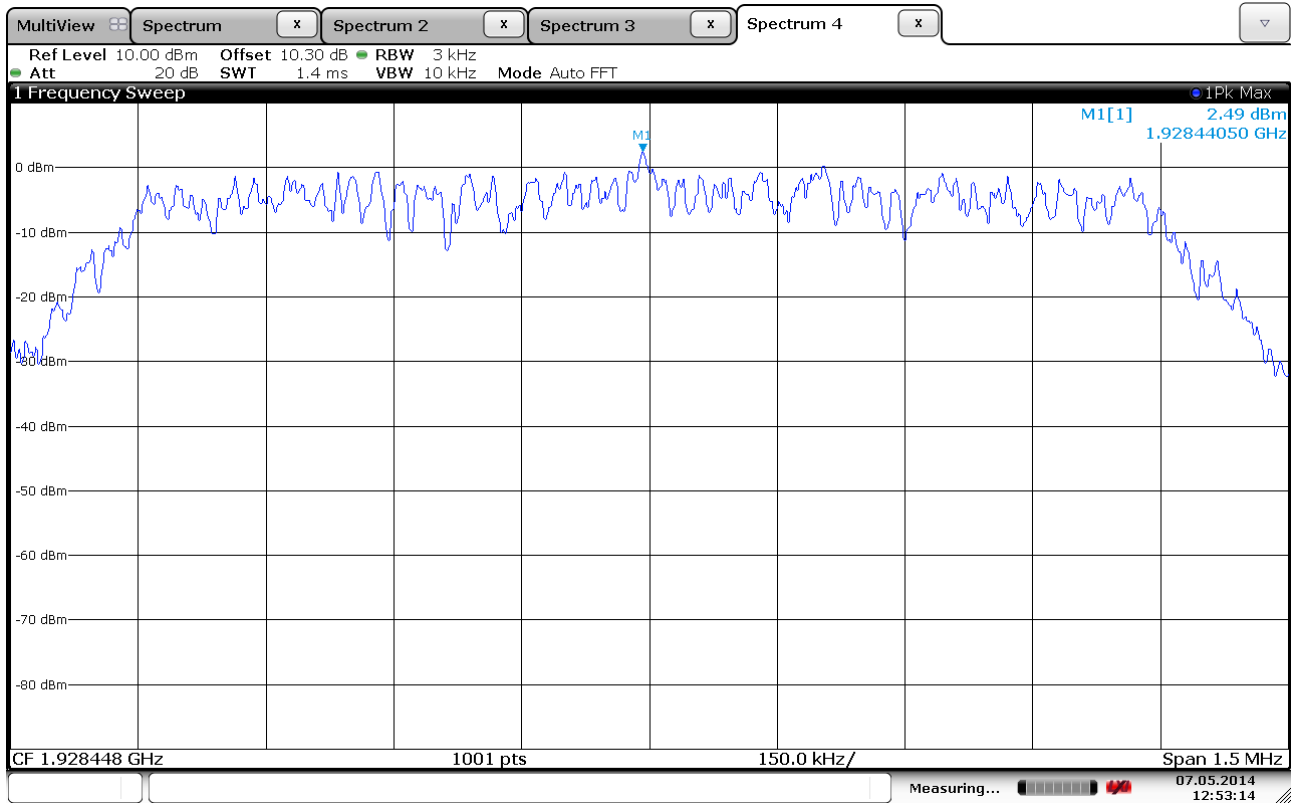

### Overview

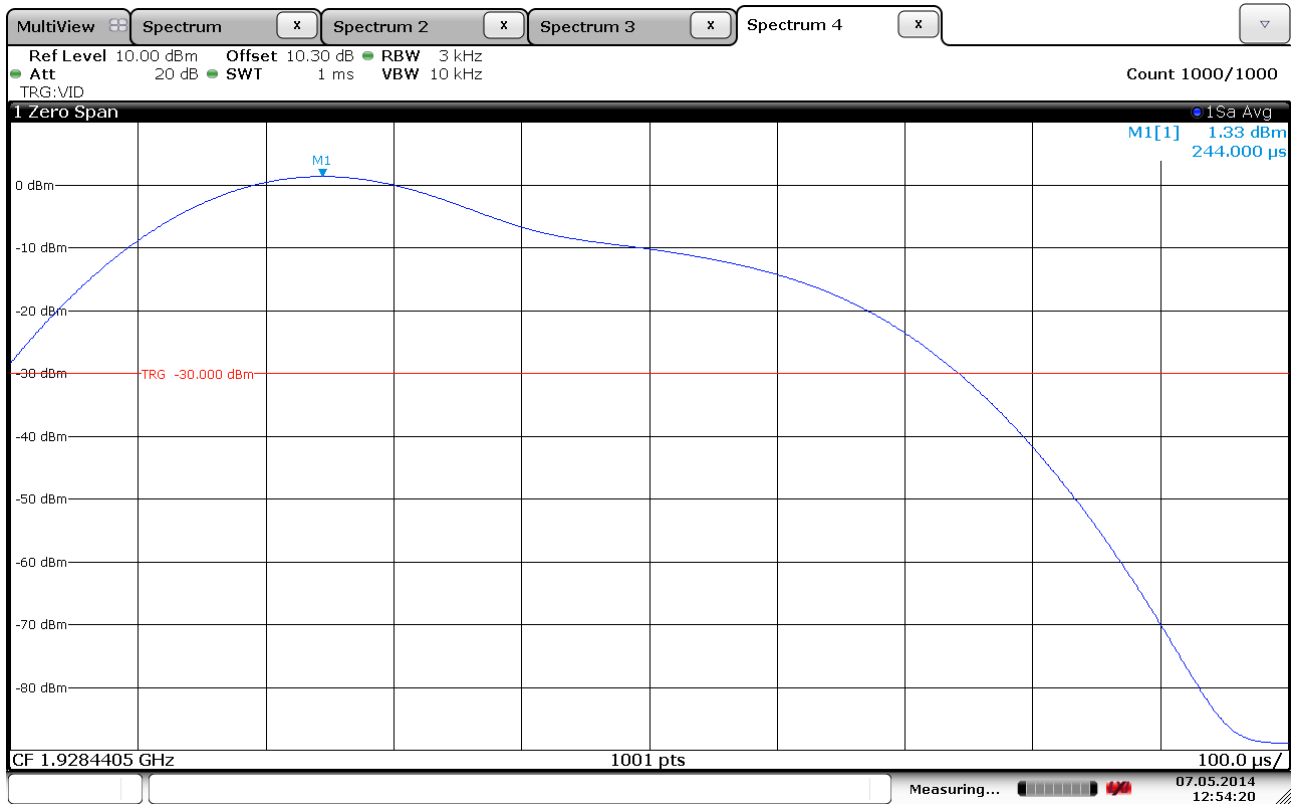

### Averaged, 1000 Sweeps

### 3.11 In-Band Unwanted Emissions, Conducted

**Test Method:**

ANSI C63.17, clause 6.1.6.1.

**Test Results: Complies**

**Measurement Data:**

See plots.

**Requirements, FCC 15.323(d):**

- $B < f \leq 2B$  : at least 30 dB below max. permitted peak power
- $2B < f \leq 3B$  : at least 50 dB below max. permitted peak power
- $3B < f \leq$  UPCS Band Edge : at least 60 dB below max. permitted peak power

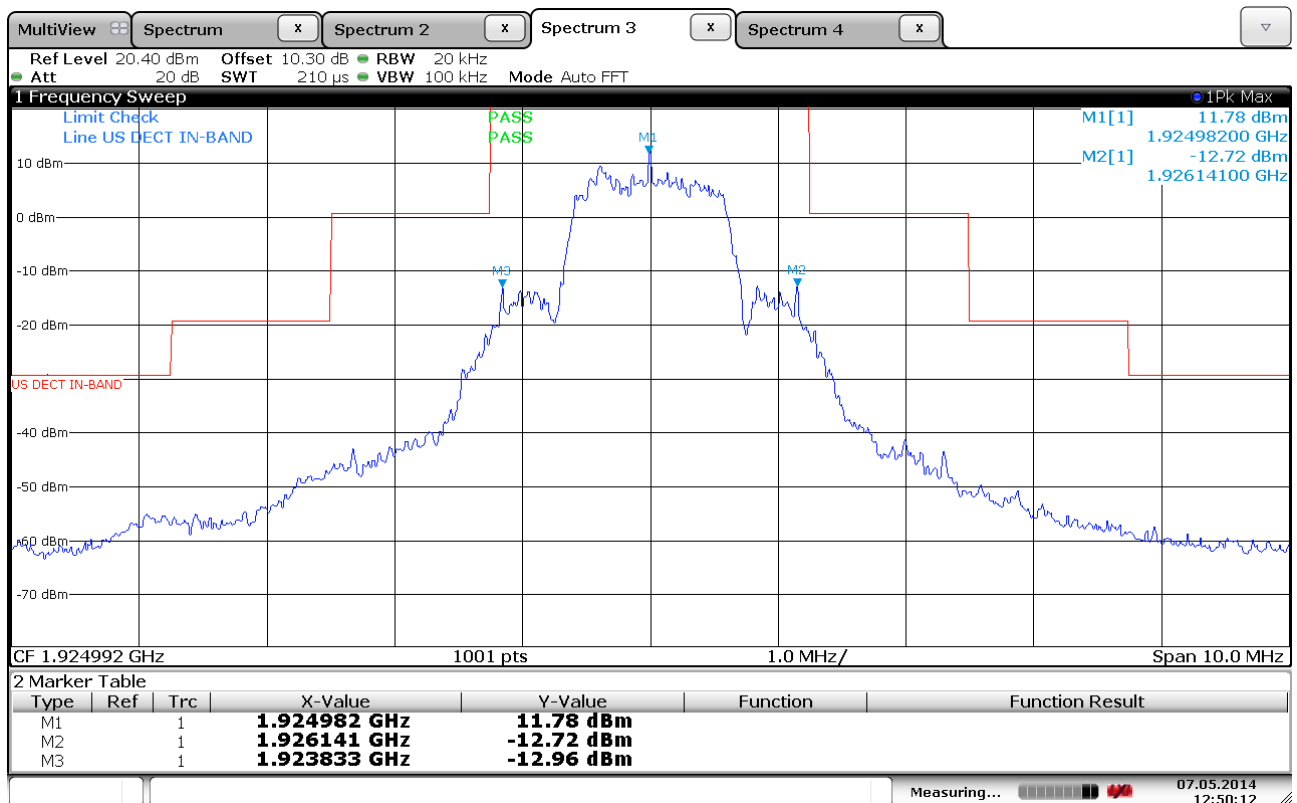

**Middle Channel**

### In-Band Unwanted Emissions, Conducted

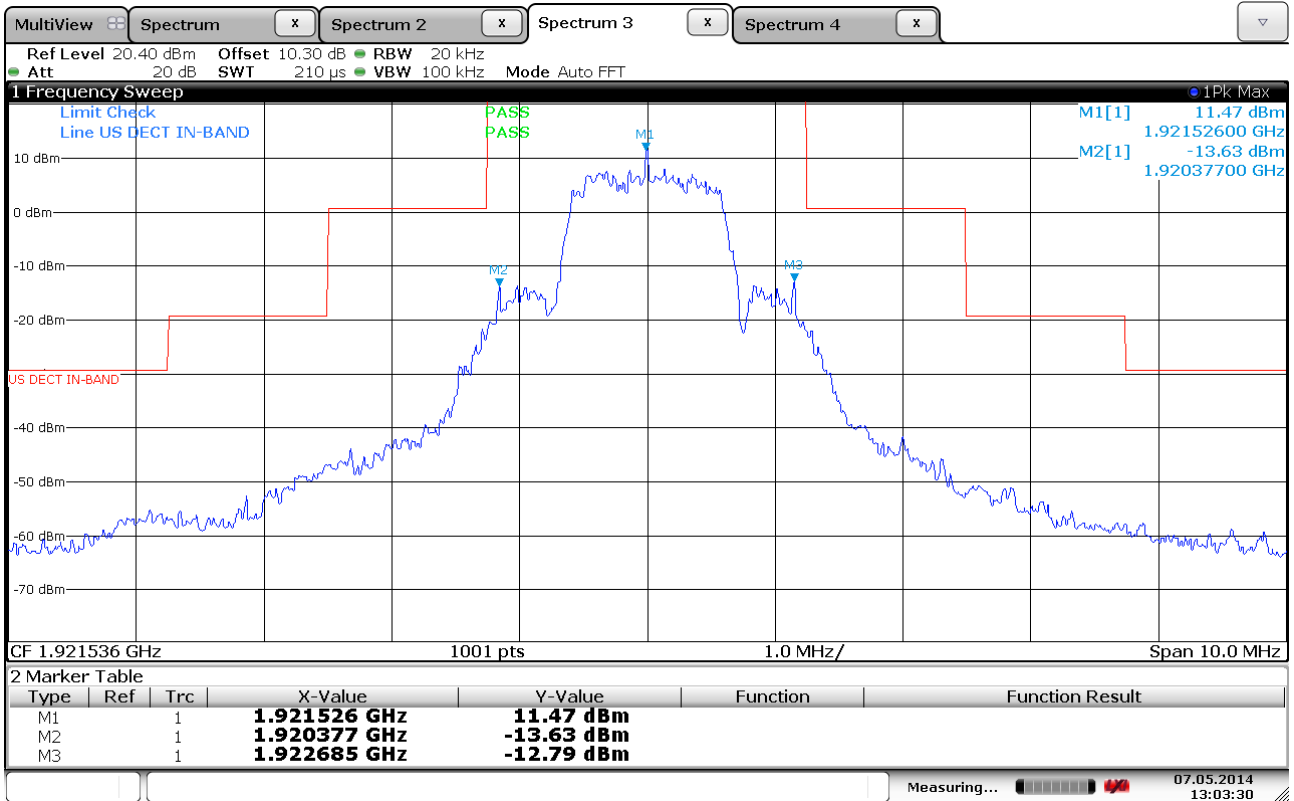

### Lower Channel

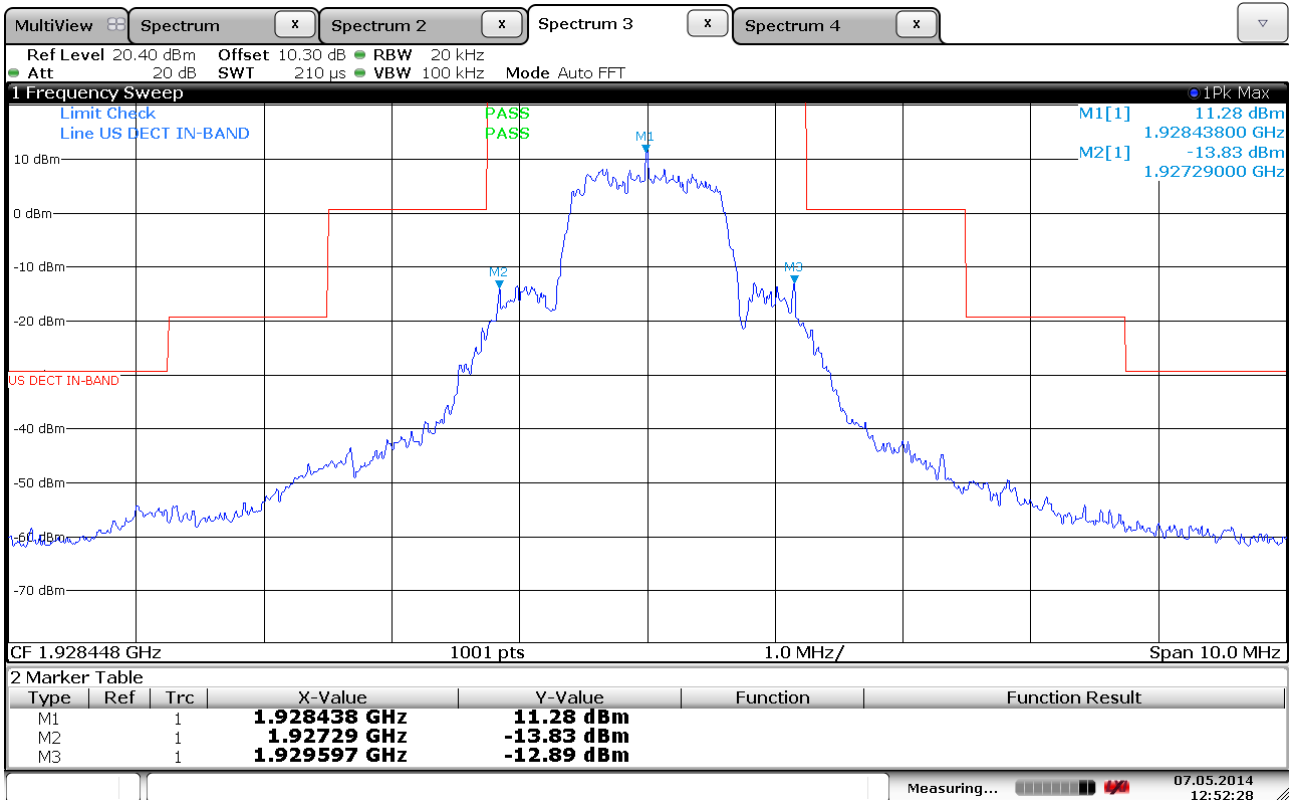

### Upper Channel

### 3.12 Out-of-band Emissions, Conducted

**Test Method:**

ANSI C63.17, clause 6.1.6.2.

**Test Results: Complies**

**Measurement Data:**

See plots.

**Requirements, FCC 15.323(d):**

- $f \leq 1.25\text{MHz}$  outside UPCS band :  $\leq -9.5\text{dBm}$
- $1.25\text{MHz} \leq f \leq 2.5\text{MHz}$  outside UPCS band :  $\leq -29.5 \text{ dBm}$
- $f \geq 2.5\text{MHz}$  outside UPCS band :  $\leq -39.5 \text{ dBm}$

**Lower Channel:**

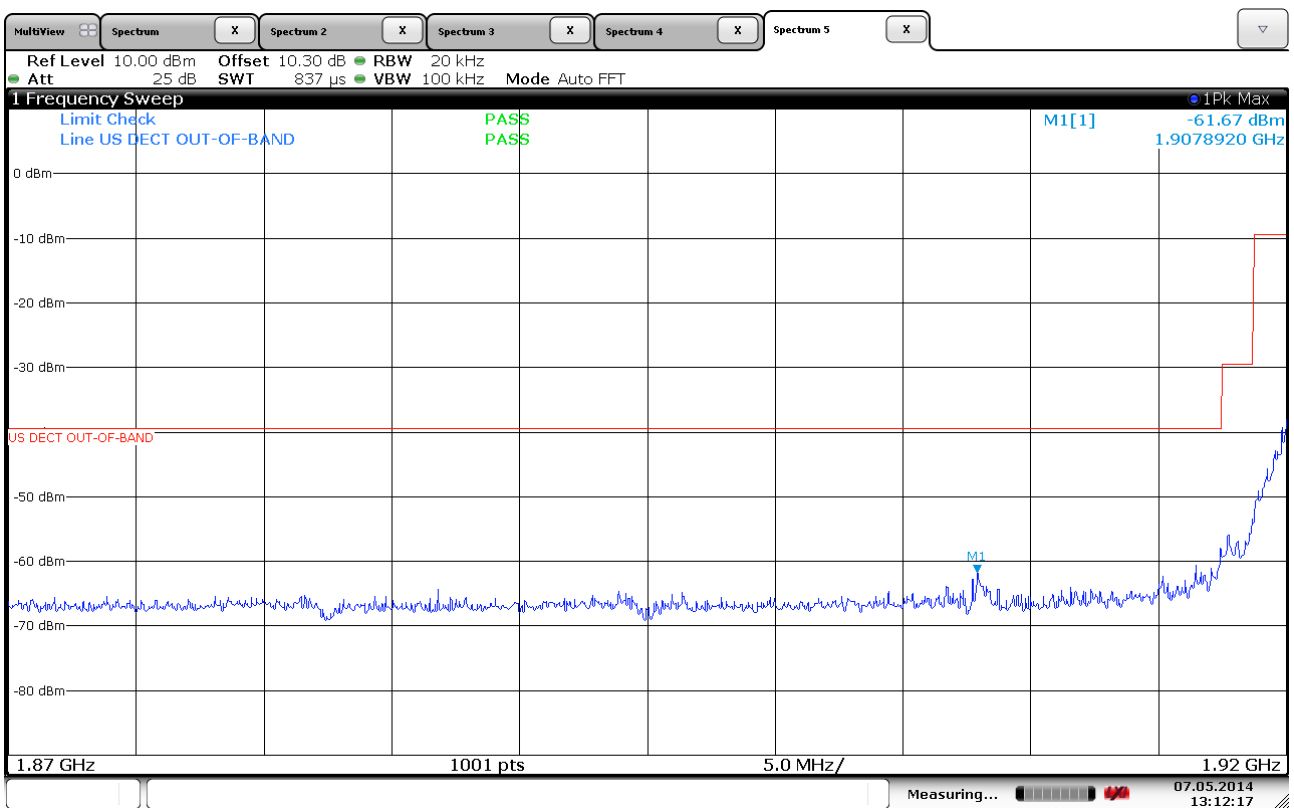



## Out-of-Band Emissions, Conducted

### Lower Channel:

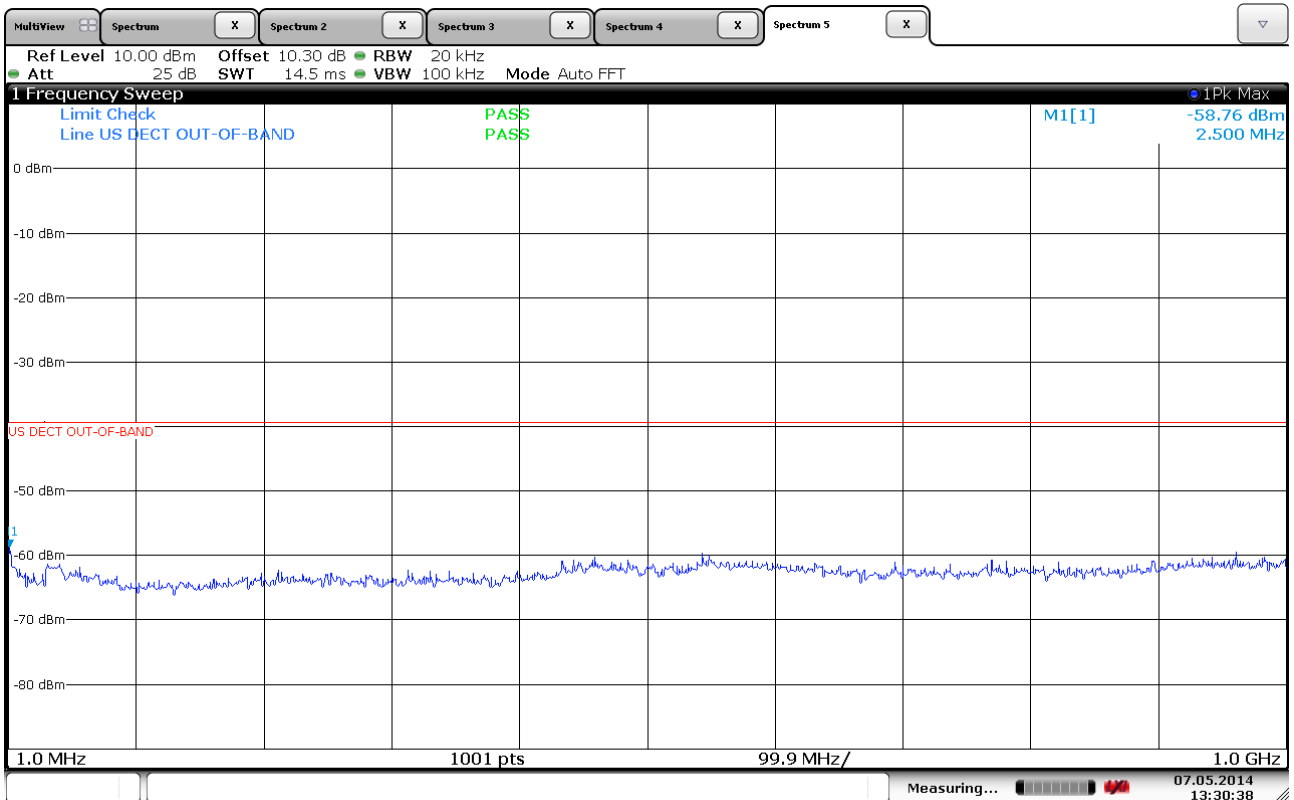
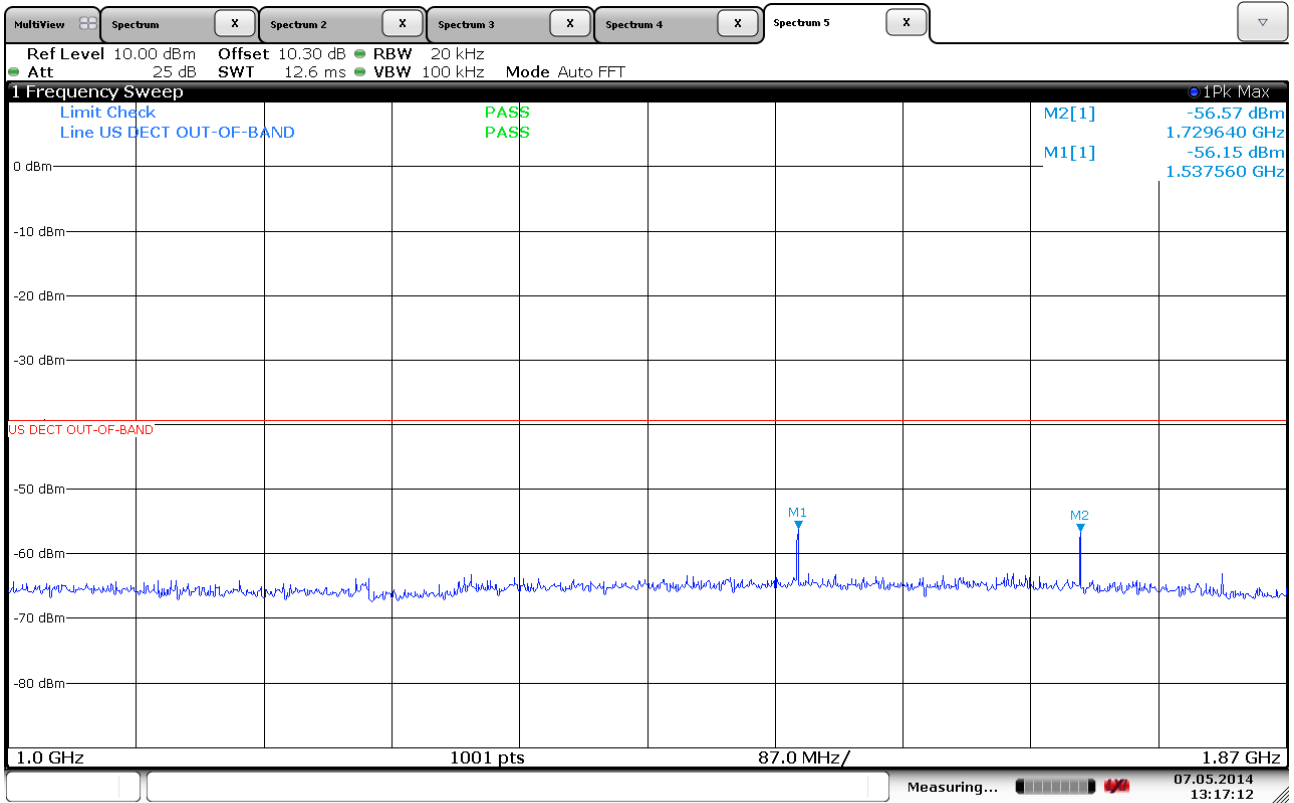

## Out-of-Band Emissions, Conducted

### Upper Channel:

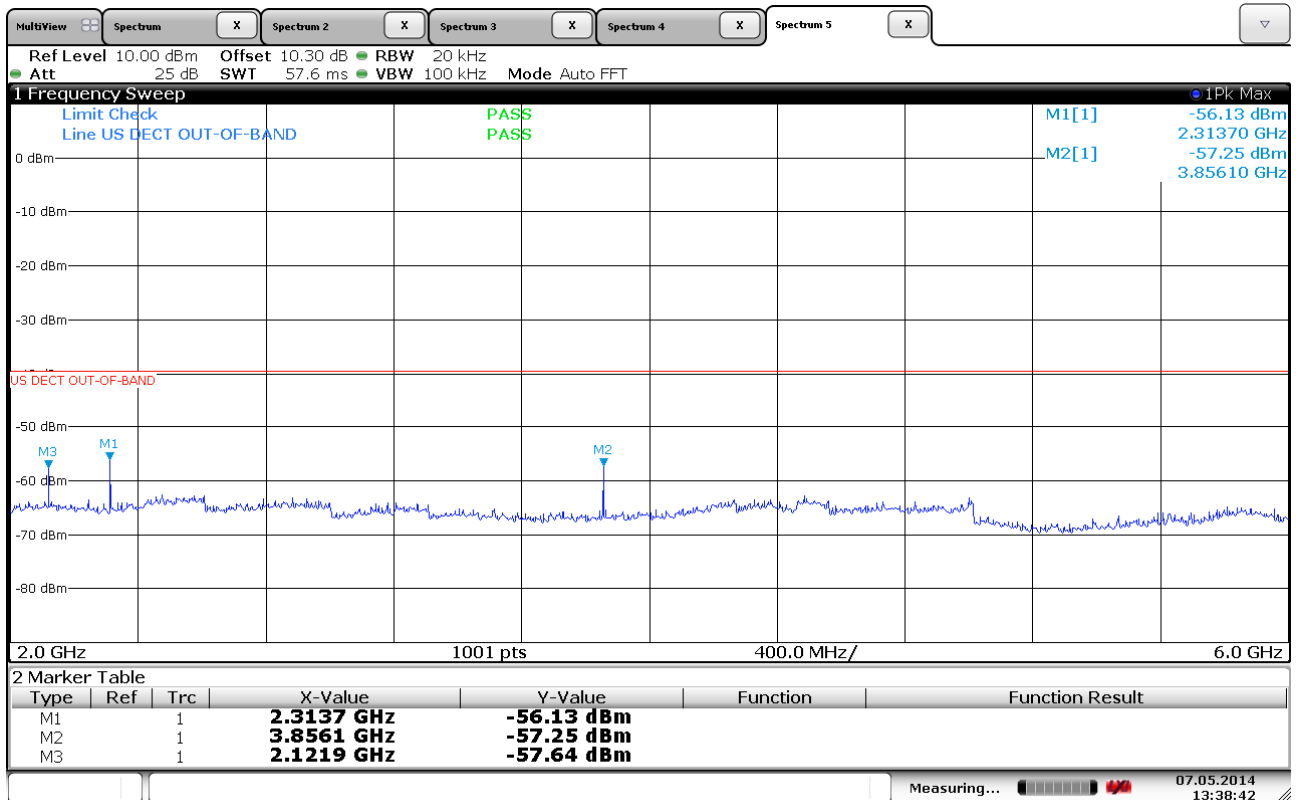
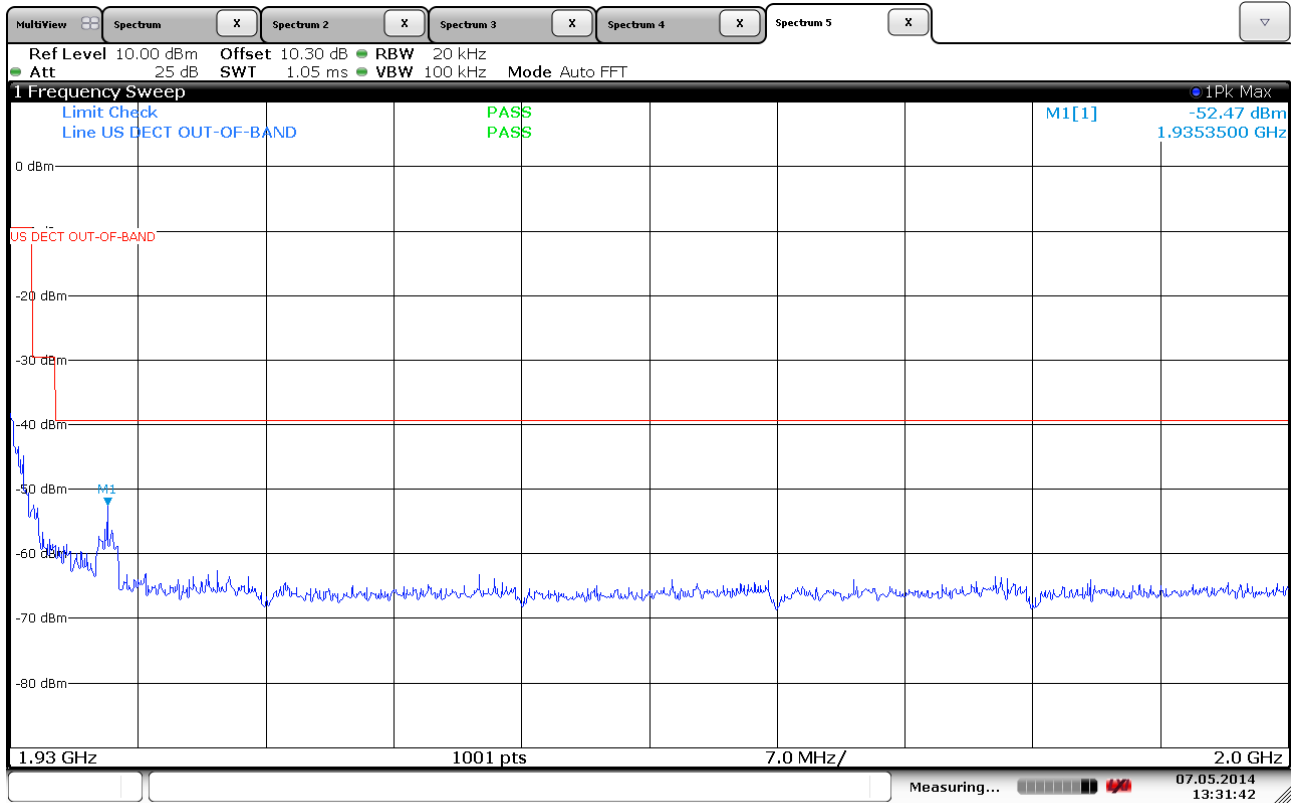

## Out-of-Band Emissions, Conducted

### Upper Channel:

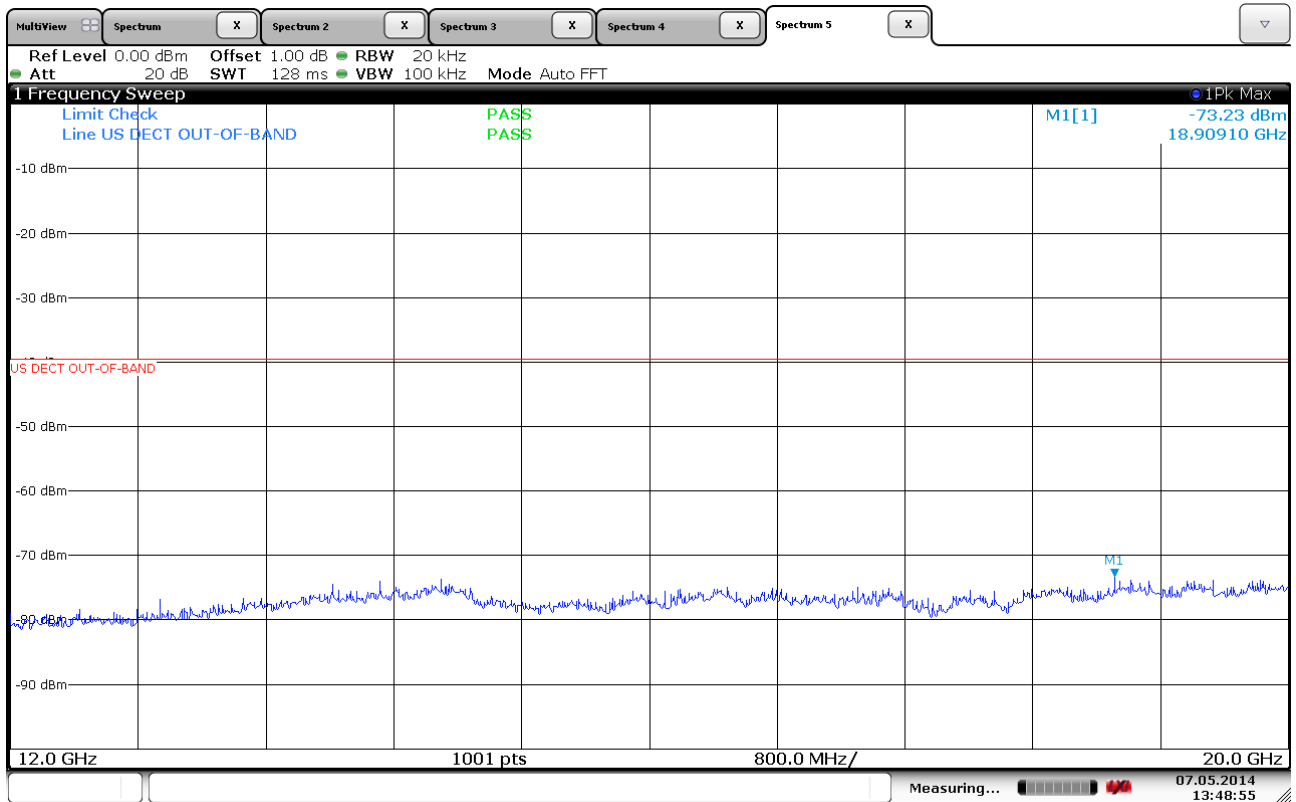
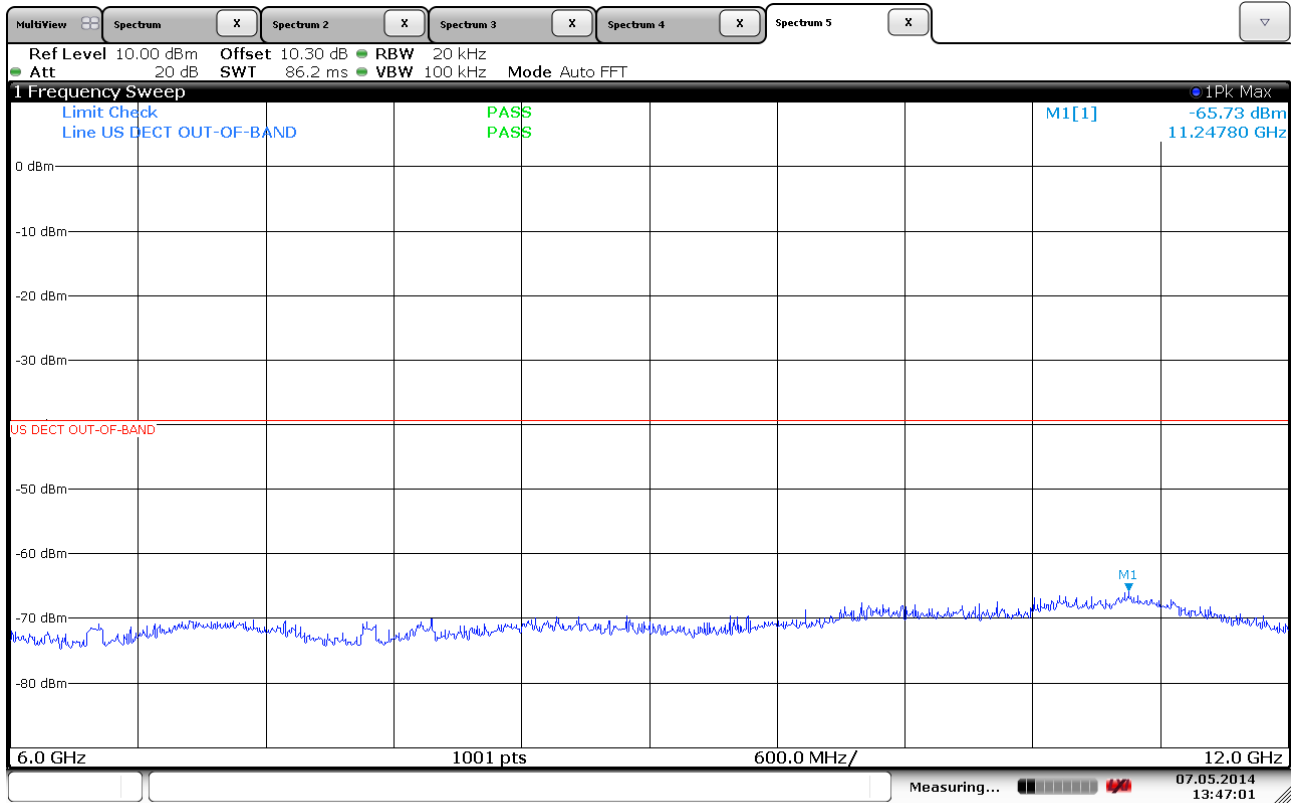

## Out-of-Band Emissions, Conducted

### Upper Channel:

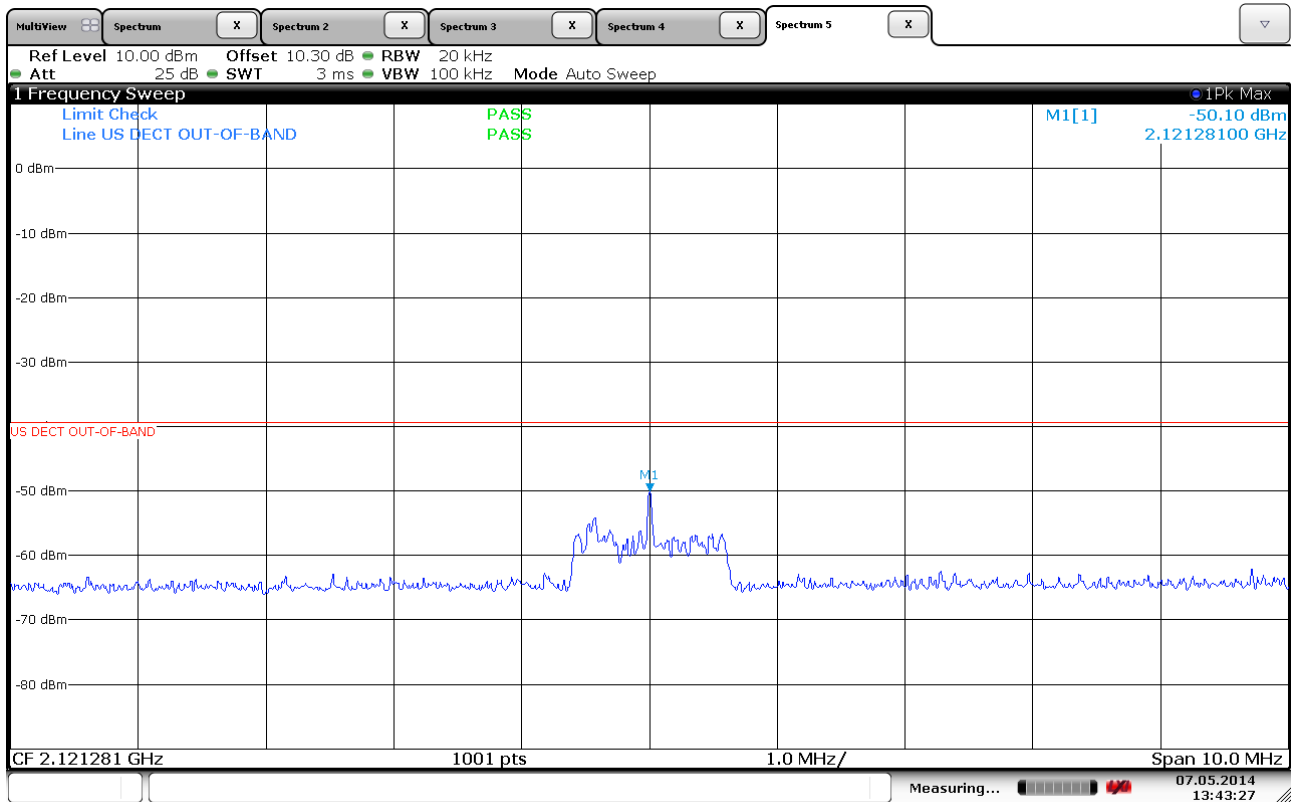
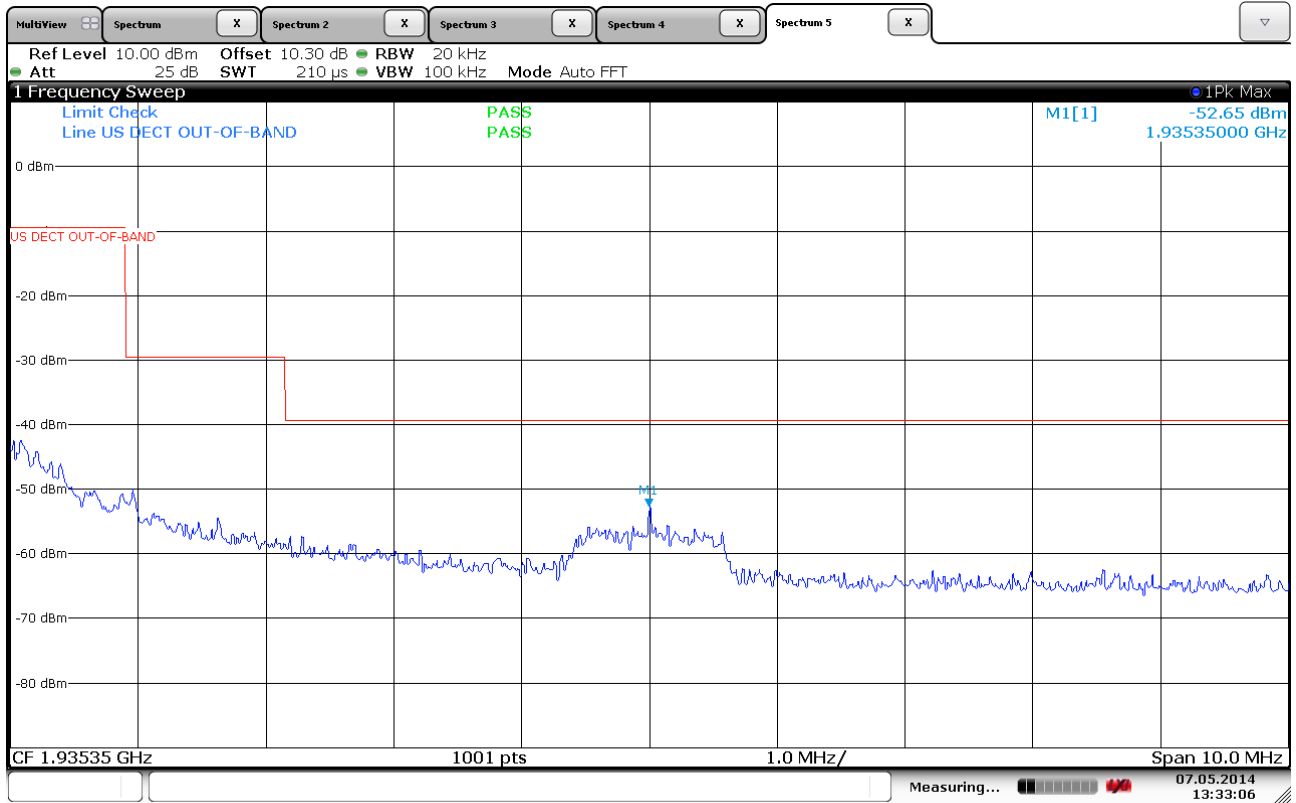

## Out-of-Band Emissions, Conducted

### Upper Channel:

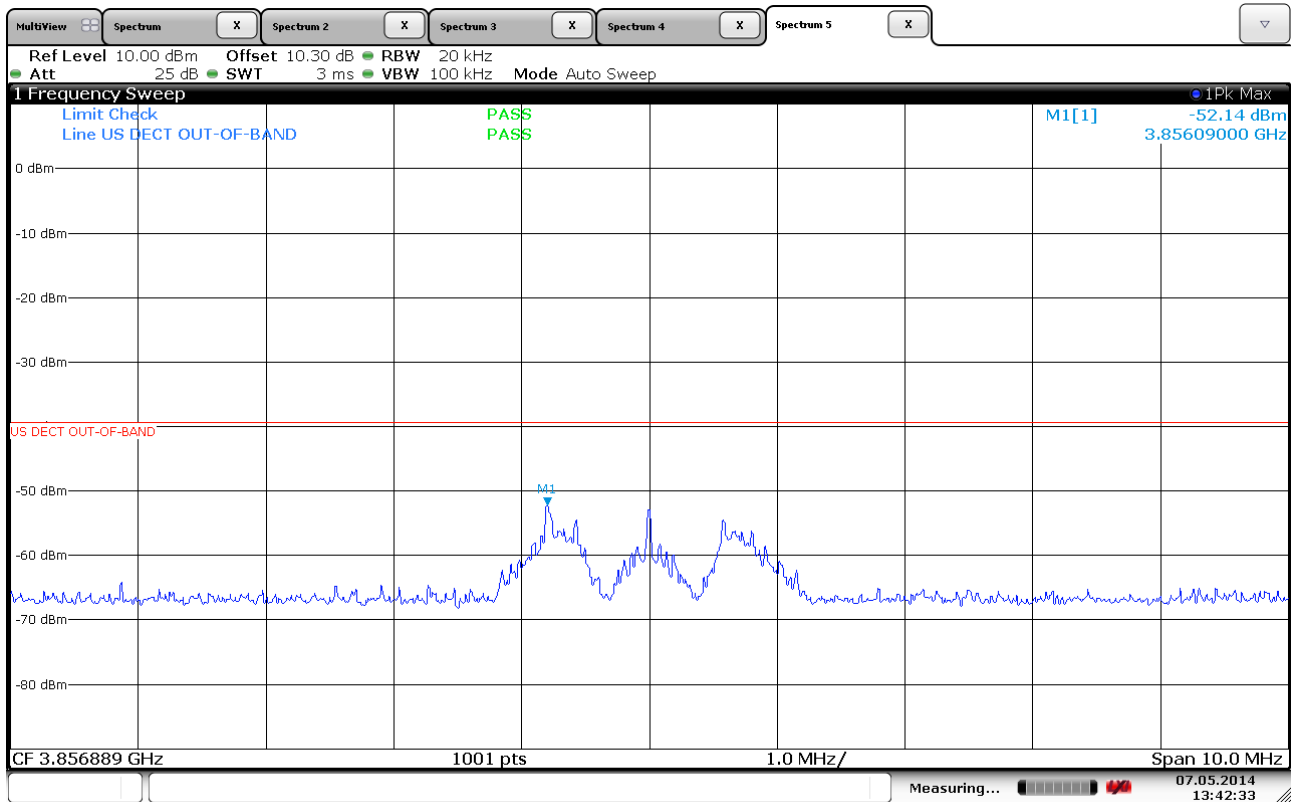
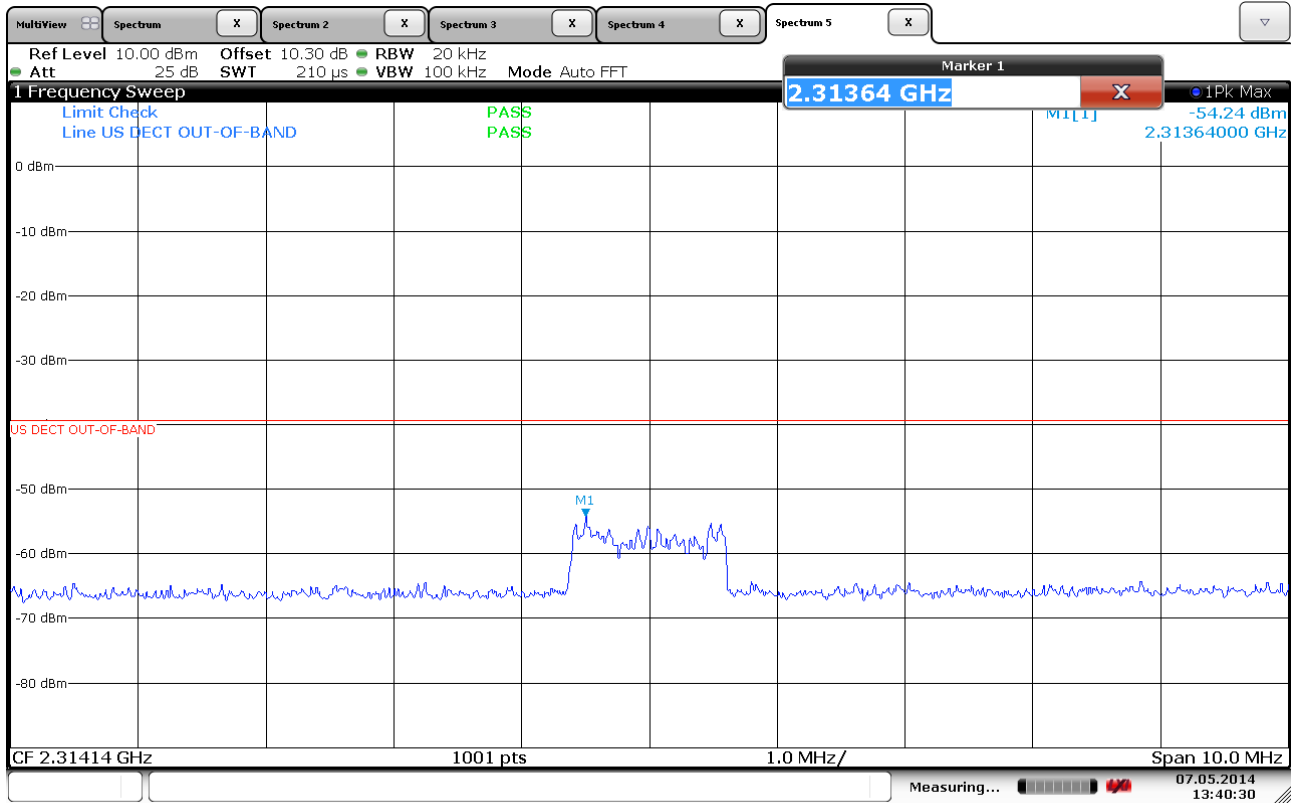

### 3.13 Carrier Frequency Stability

**Test Method:**

ANSI C63.17, clause 6.2.1.

**Test Results: Complies**

**Measurement Data:**

The Frequency Stability is measured with a R&S CMD60 DECT Tester. The CMD60 was logged by a computer programmed to get new readings as fast as possible (about 3 readings per second) over the noted time period or number of readings. The peak-to-peak difference was recorded and the mean value and deviation in ppm was calculated.

The Carrier Frequency Stability over Power Supply Voltage and over Temperature is measured with a Frequency Domain Analyzer in histogram mode.

**Carrier Frequency Stability over Time at Nominal Temperature**

Average Mean Carrier Frequency (MHz)	Max. Diff. (kHz)	Min. Diff. (kHz)	Max. Dev. (ppm)	Limit
1926.726782	7.793	5.690	0.5	±10 ppm

Deviation ppm = ((Diff.) / Mean Carrier Freq.) x 10<sup>6</sup>

Deviation (ppm) is calculated from 3000 readings.

**Frequency Stability over Power Supply Voltage at Nominal Temperature**

Voltage	Measured Carrier Frequency (MHz)	Difference (kHz)	Deviation (ppm)	Limit
V <sub>nom</sub>	1924.979167	/	/	±10 ppm
85% of V <sub>nom</sub>	1924.976549	-1.1	-0.6	
115% of V <sub>nom</sub>	1924.977240	-1.6	-0.8	

Deviation ppm = ((Mean – Measured Frequency) / Mean) x 10<sup>6</sup>

**Frequency Stability over Temperature**

Temperature	Measured Carrier Frequency (MHz)	Difference (kHz)	Deviation (ppm)	Limit
T = +20 °C	1924.979167	0	0	±10 ppm
T = -20 °C	1924.978079	-2.6	-1.4	
T = +50 °C	1924.977585	-1.9	-1.0	

Deviation ppm = ((Mean – Measured Frequency) / Mean) x 10<sup>6</sup>

### 3.14 Frame Repetition Stability

**Test Method:**

ANSI C63.17, clause 6.2.2.

**Test Results: Complies**

**Measurement Data:**

The envelope of the RF signal from the EUT is detected with a Crystal Detector and the mean and standard deviation of the frame repetition frequency is then gated over 100 frames and measured with a Frequency Domain Analyzer. The frame repetition stability is 3 times the standard deviation.

Carrier Frequency (MHz)	Mean (Hz)	Standard Deviation (Hz)	Frame Repetition Stability (ppm)
1924.992	99.999466	0.000015	0.455

**Limit:**

<b>Frame Repetition Stability</b>	±10 ppm (TDMA)
-----------------------------------	----------------

Ref. FCC 15.323(e), ANSI C63.17, clause 6.2.2

### 3.15 Frame Period and Jitter

**Test Method:**

ANSI C63.17, clause 6.2.3.

**Test Results: Complies**

**Measurement Data:**

Carrier Frequency (MHz)	Frame Period (ms)	Max Jitter (µs)	3xStandard Deviation of Jitter (µs)
1924.992	99.999	-0.037	-0.025

Max Jitter = (1/ (Frame period + Pk-Pk/2)) - (1/Frame Period), when Pk-Pk and Frame Period are in Hz

$$3xSt.Dev.Jitter = 3x (1/(Frame Period + St.Dev) - 1/St.Dev) \times 10^6$$

**Limit:**

<b>Frame Period</b>	20 or 10 ms
<b>Max Jitter</b>	25 µs
<b>3 times St.Dev of Jitter</b>	12.5 µs

Ref. FCC 15.323(e), ANSI C63.17, clause 6.2.3

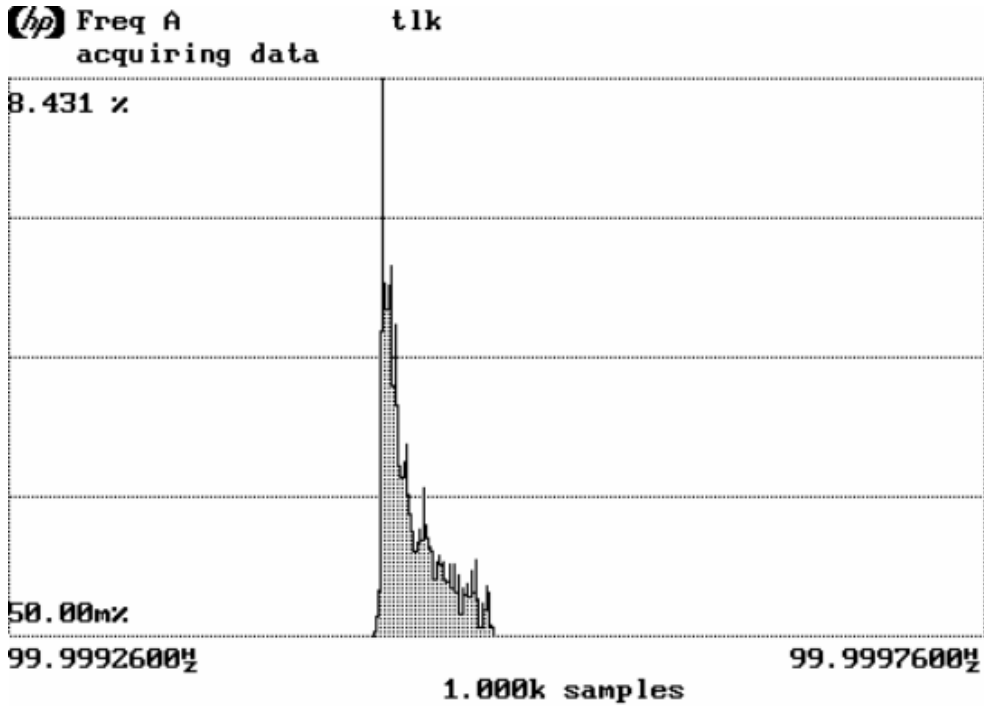

Mean 99.999466439µs 1/Mean 10.000ms  
 Pk-Pk 61.2µs Std Dev 15.161µs

Frame Repetition Stability, Gated over 100 Frames

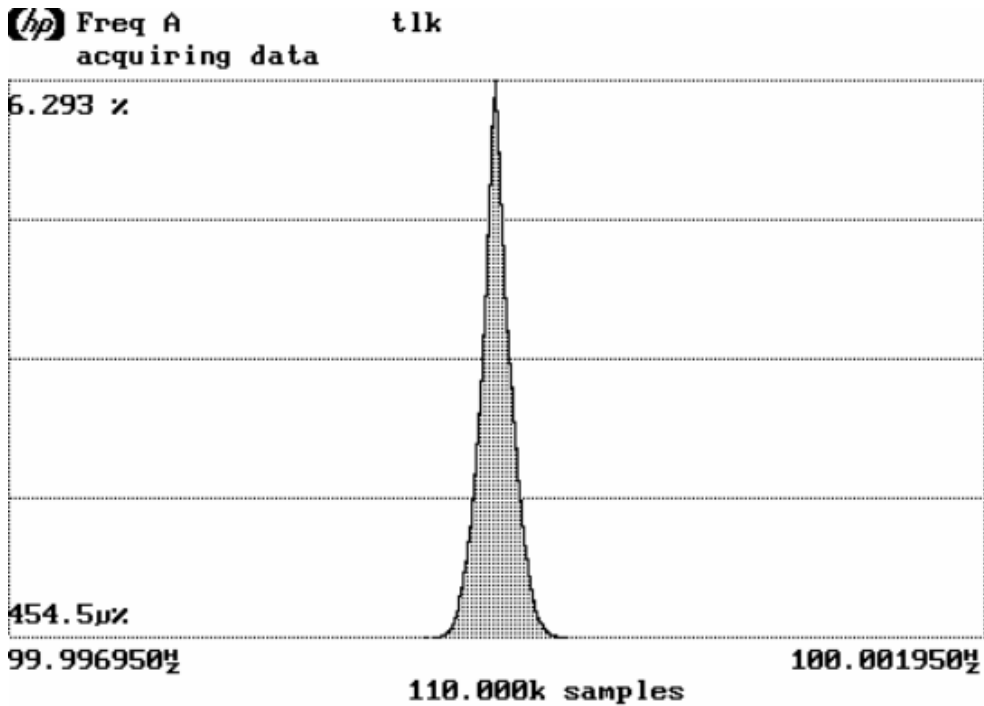

Mean 99.999448404µs 1/Mean 10.000ms  
 Pk-Pk 735µs Std Dev 84.335µs

Frame Period and Jitter



### 3.16 Monitoring Threshold, Least Interfered Channel

#### Monitoring Threshold Limits:

Lower Threshold:

$$T_L = 15 \log B - 184 + 30 - P_{EUT} \quad (\text{dBm})$$

Upper Threshold:

$$T_U = 15 \log B - 184 + 50 - P_{EUT} \quad (\text{dBm})$$

$B$  is measured Emission Bandwidth in Hz  
 $P_{EUT}$  is measured Transmitter Power in dBm

Calculated values:

	FCC 15.323	RSS-213, Issue 2
Lower Threshold	-79.7 dBm	-80.4 dBm
Upper Threshold	N/A	-60.4 dBm

Least Interfered Channel Procedure (LIC) may only be used by systems with more than 20 duplex system access channels. Systems with less than 20 duplex system access channels are not allowed to transmit when interferer level is above Lower Threshold.

Upper Threshold has been removed from FCC 15D but still exists in the current Industry Canada RSS-213.

#### Measurement Procedure:

The Upper or Lower Threshold is found by the procedure defined in ANSI C63.17 clause 7.3.1 or 7.3.2.

Least Interfered Channel Procedure NOT used:	
Lower Threshold	N/A dBm
Least Interfered Channel Procedure:	
Upper Threshold	-63.0 dBm

#### Least Interfered Channel (LIC) Procedure Test, FCC 15.323(b), (c)(2) and (c)(5)

ANSI C63.17 clause 7.3.3 ref.	Observation	Verdict
b) $f_1$ $T_L + 13$ dB, $f_2$ at $T_L + 6$ dB	Transmission always on $f_2$	Pass
c) $f_1$ $T_L + 6$ dB, $f_2$ at $T_L + 13$ dB	Transmission always on $f_1$	Pass
d) $f_1$ $T_L + 7$ dB, $f_2$ at $T_L$	Transmission always on $f_2$	Pass
e) $f_1$ $T_L$ , $f_2$ at $T_L + 7$ dB	Transmission always on $f_1$	Pass

**Selected Channel Confirmation, FCC 15.323(c)(1) and (5)**

ANSI C63.17 clause 7.3.4	Observation	Verdict
b) Shall <b>not</b> transmit on $f_1$	EUT transmits on $f_2$	<b>Pass</b>
d) Shall <b>not</b> transmit on $f_2$	EUT transmits on $f_1$	<b>Pass</b>

**Limits:**

	FCC 15.323	RSS-213, Issue 2
Lower Threshold + 6 dB margin	-73.7 dBm	-74.4 dBm
Upper Threshold + 6 dB margin	N/A	-54.4 dBm

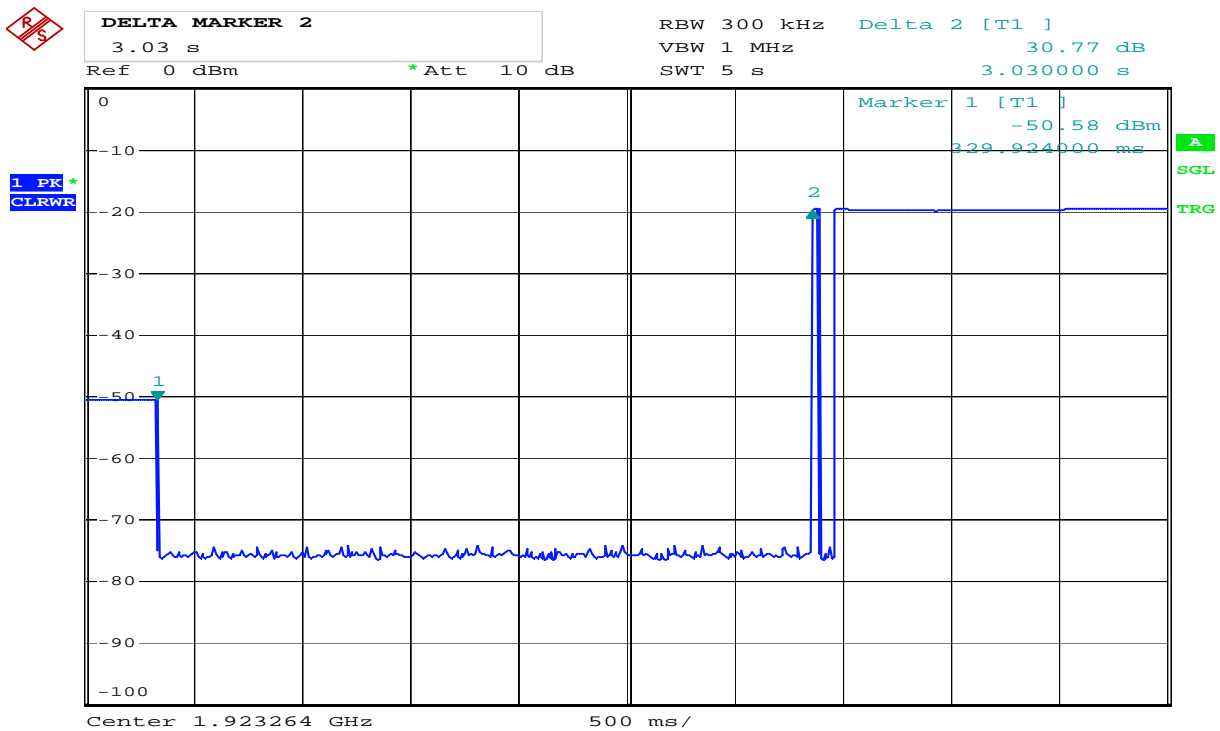

Date: 12.MAY.2014 14:33:00

**7.3.4 Selected Channel Confirmation, Connection 3.0s After Interferer Removed**

### 3.17 Threshold Monitoring Bandwidth

This test is only required if a dedicated monitoring receiver is used. However, if the test is not carried out the manufacturer shall declare and provide proper evidence that the monitoring is made through the radio receiver used for communication.

**Measurement Procedure:**

Simple Compliance Test, ANSI C63.17, clause 7.4.1

More Detailed Test, ANSI C63.17, clause 7.4.2

The test is passed if **either** the Simple Compliance Test or the More Detailed test is passed.

During this test the spectrum analyzer is observed visually to see if the EUT transmits or not.

**Test Results:**

Test performed	Observation	Verdict
Simple Compliance test, at $\pm 30\%$ of $B$	No transmissions	<b>Pass</b>
More Detailed Test, at -6 dB points	N/A	<b>N/A</b>
More Detailed Test, at -12 dB points	N/A	<b>N/A</b>

The more detailed test must be pass at both the -6 and -12 dB points if the Simple Compliance test fails.

**Comment:** The Simple Compliance Test was performed with the level at  $T_U + U_M + 10$  dB to check that the EUT did not transmit at all.

The tested EUT uses the same receiver for monitoring and communication, this test is therefore not required. However the test has been performed nonetheless and the test is passed.

**Limits, FCC 15.323(c)(7):**

The monitoring system bandwidth must be equal to or greater than the emission bandwidth of the intended transmission.

### 3.18 Reaction Time and Monitoring Interval

#### Measurement Procedure

ANSI C63.17, clause 7.5

#### Test results:

By administrative commands and out-of-operating region interference, the EUT is restricted to operate on a single carrier frequency.

Time-synchronized pulsed interference was then applied on the carrier at pulsed levels  $T_U + U_M$  to check that the EUT does not transmit at all. The level was raised 6 dB for part d) with 35  $\mu$ s pulses.

The pulses are synchronized with the EUT timeslots and applied centered within all timeslots.

Pulse Width, ref. to ANSI C63.17 clause 7.5	Observation	Verdict
c) > largest of 50 $\mu$ s and $50 \cdot \text{SQRT}(1.25/B)$	No transmissions	Pass
d) > largest of 35 $\mu$ s and $35 \cdot \text{SQRT}(1.25/B)$ , and with interference level raised 6 dB	No transmissions	Pass

**Comment:** Since  $B$  is larger than 1.25 MHz the test was performed with pulse lengths of 50  $\mu$ s and 35  $\mu$ s.

#### Limits, FCC 15.323(c)(1), (5) and (7)

The maximum reaction time must be less than  $50 \cdot \text{SQRT}(1.25/\text{emission bandwidth in MHz})$  microseconds for signals at the applicable threshold level but shall not be required to be less than 50 microseconds.

If a signal is detected that is 6 dB or more above the applicable threshold level, the maximum reaction time shall be  $35 \cdot \text{SQRT}(1.25/\text{emission bandwidth in MHz})$  microseconds but shall not be required to be less than 35 microseconds.

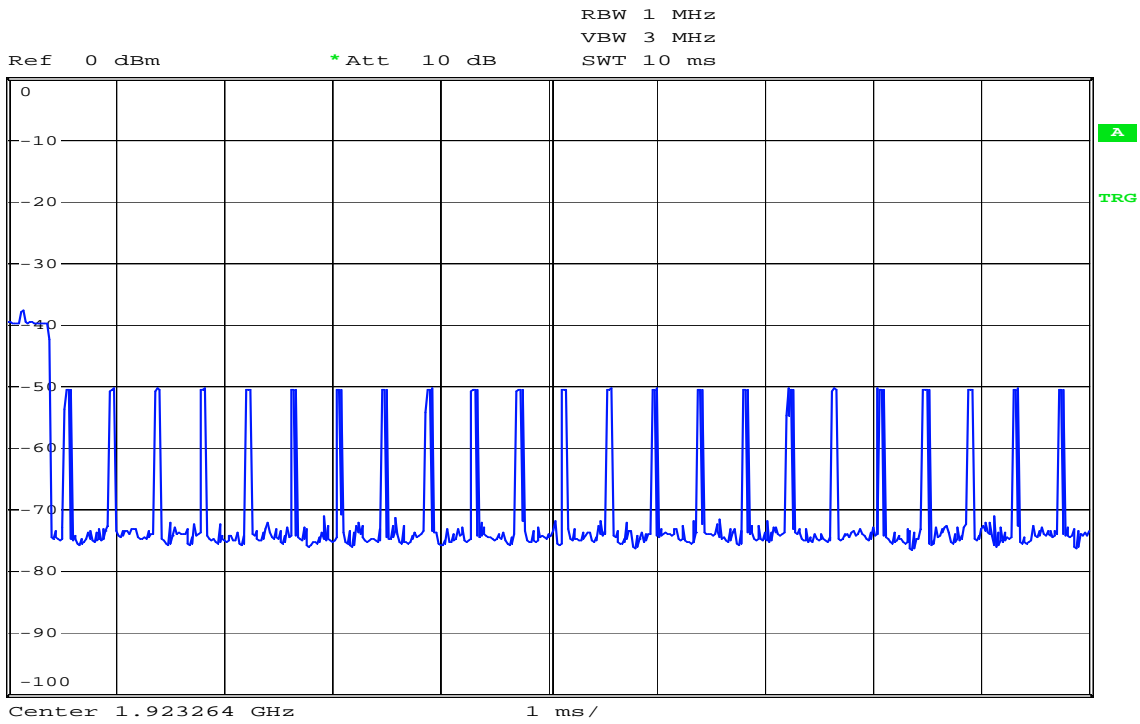

Date: 12.MAY.2014 14:26:59

**50 µs Pulses**

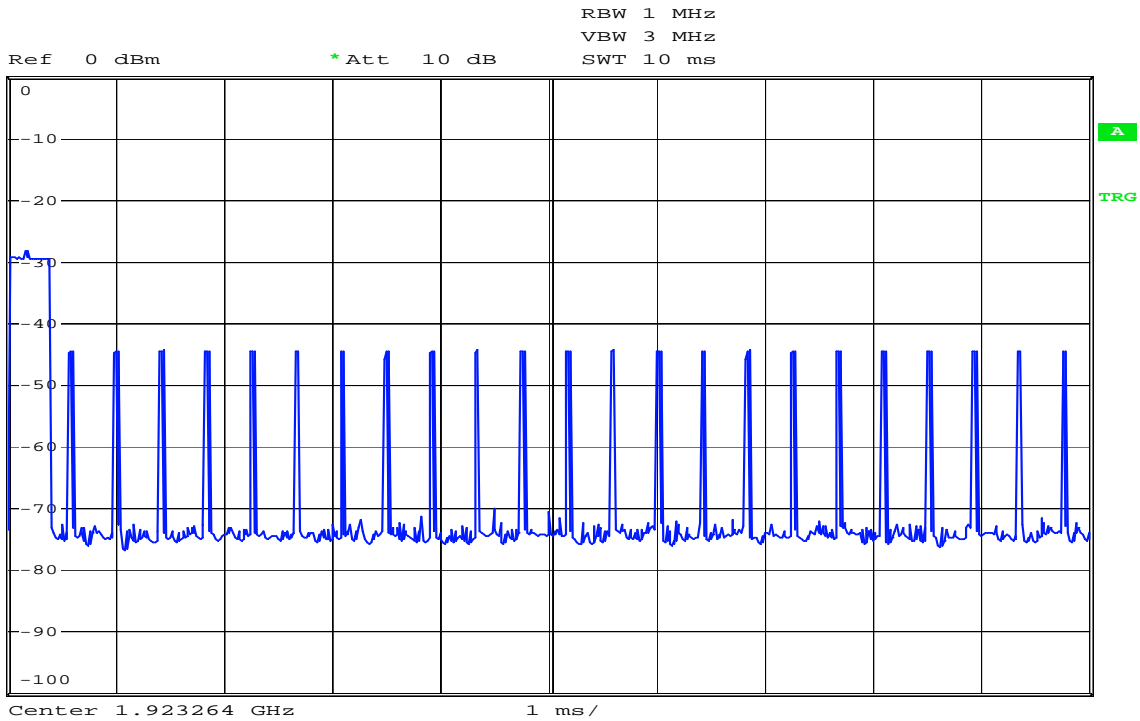

Date: 12.MAY.2014 14:27:36

**35 µs Pulses**

### 3.19 Time and Spectrum Window Access Procedure

This requirement is only for EUTs which transmit unacknowledged control and signaling information.

**Measurement Procedure:**

Timing for EUTs using control and signaling channel type transmissions: ANSI C63.17, clause 8.1

**Test results:**

Access Criteria, ref. to ANSI C63.17 clause 8.1.1	Observation	Verdict
b) Check that the EUT transmits on the interference free time-slot	N/A	N/A
b) The EUT must terminate or pause in its repetitive transmission of the control and signalling channel on the open channel to repeat the access criteria not less frequently than every 30 s	N/A	N/A

If FCC 15.323(c)(6) option, **If Random Waiting Interval is NOT implemented**

Access Criteria, ref. to ANSI C63.17 clause 8.1.2	Observation	Verdict
b) Check that the EUT changes to an interference-free slot when interference is introduced on the time slot in use	N/A	N/A

If FCC 15.323(c)(6) option, **Only if Random Waiting Interval is implemented**

Access Criteria, ref. to ANSI C63.17 clause 8.1.3	Observation	Verdict
b-d) Check that the EUT uses random waiting interval before continuing transmission on an interfered time slot	N/A	N/A

Comment: The tested EUT does not transmit unacknowledged control and signaling information.

**Limits:**

**FCC 15.323(c)(4):**

Once access to specific combined time and spectrum windows is obtained an acknowledgement from a system participant must be received by the initiating transmitter within one second or transmission must cease. Periodic acknowledgements must be received at least every 30 seconds or transmission must cease. Channels used exclusively for control and signaling information may transmit continuously for 30 seconds without receiving an acknowledgement, at which time the access criteria must be repeated.

**FCC 15.323(c)(6):**

If the selected combined time and spectrum windows are unavailable, the device may either monitor and select different windows or seek to use the same windows after waiting an amount of time, randomly chosen from a uniform random distribution between 10 and 150 milliseconds, commencing when the channel becomes available

### 3.20 Acknowledgements and Transmission Duration

**Measurement Procedure:**

Acknowledgements: ANSI C63.17, clause 8.2.1

Transmission Duration: ANSI C63.17, clause 8.2.2

During the test **Initial transmission without acknowledgements** the signal from the EUT to the companion device is blocked by circulators in addition to the tunable attenuator.

The test **Transmission time after loss of acknowledgements** is performed by cutting-off the signal from the companion device by a RF switch and measuring the time until the EUT stops transmitting.

The **Transmission Duration** test is performed by monitoring the slot in use and measuring the time until the EUT changes to a different slot.

**Test Results:**

**Acknowledgements**

Test ref. to ANSI C63.17 clause 8.2.1	Observation	Verdict
a) Initial transmission without acknowledgements	0.32 sec	Pass
c) Transmission time after loss of acknowledgements	10.0 sec	Pass

**Transmission Duration**

Test ref. to ANSI C63.17 clause 8.2.2	Observation	Verdict
b) Transmission duration on same time and frequency window	2 minutes*	Pass

Comment: \*EUT stops transmitting after 2 minutes.

**Limits, FCC 15.323(c)(3) and (4)**

Occupation of the same combined time and spectrum windows by a device or group of cooperating devices continuously over a period of time longer than 8 hours is not permitted without repeating the access criteria.

Once access to specific combined time and spectrum windows is obtained an acknowledgement from a system participant must be received by the initiating transmitter within one second or transmission must cease.

Periodic acknowledgements must be received at least every 30 seconds or transmission must cease. Channels used exclusively for control and signaling information may transmit continuously for 30 seconds without receiving an acknowledgement, at which time the access criteria must be repeated.

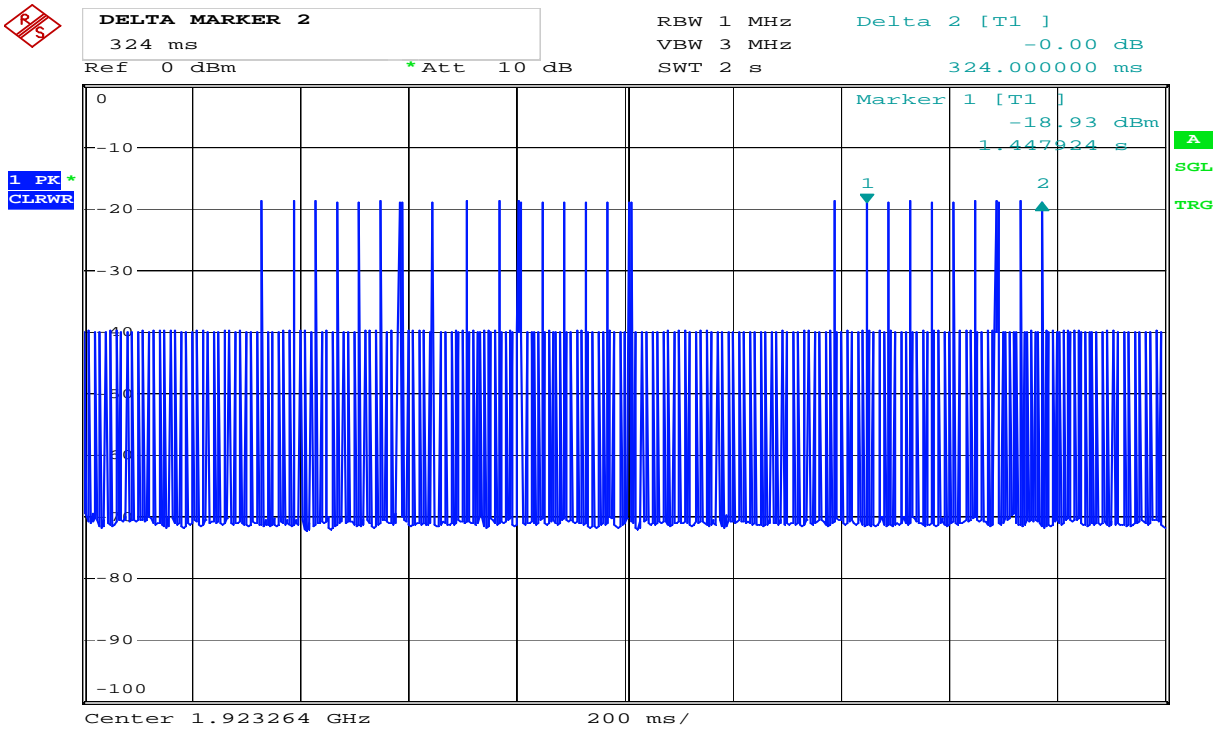

Date: 12.MAY.2014 14:05:34

### 8.2.1a) Initial Transmission Without Acknowledgements

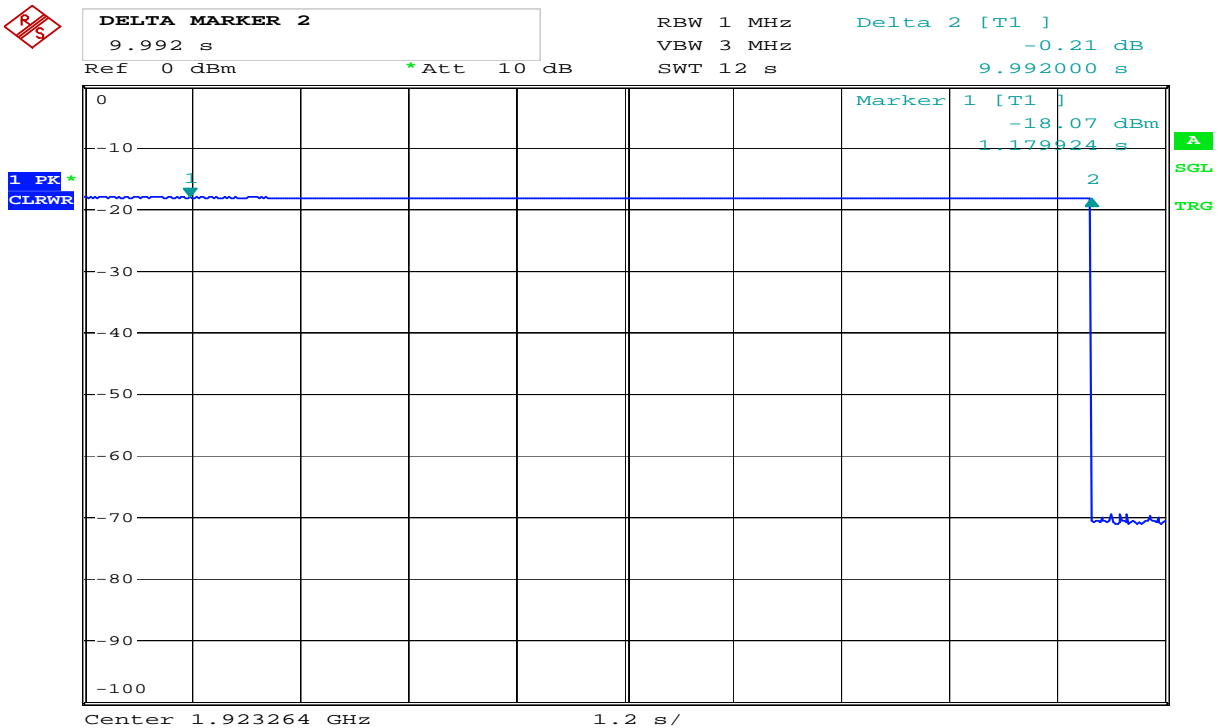

Date: 12.MAY.2014 13:43:01

### 8.2.1c) Transmission Time After Loss of Acknowledgements



### 3.21 Dual Access Criteria Check

**Measurement Procedure:**

EUTs that does not implement the Upper Threshold: ANSI C63.17, clause 8.3.1

EUTs that implement the Upper Threshold: ANSI C63.17, clause 8.3.2

This test is required for equipment that uses the access criteria in FCC 15.323(c)(10).

**Test Results:**

**EUTs that Implements the Upper Threshold:**

Test ref. to ANSI C63.17 clause 8.3.2	Observation	Verdict
b) EUT is restricted to a single carrier $f_i$ for TDMA systems. The Test is Pass if EUT can transmit	EUT can transmit	<b>Pass</b>
c) d) Transmission on interference-free <b>receive</b> time/spectrum window	EUT transmits on interference free <b>receive</b> slot	<b>Pass</b>
e) f) Transmission on interference-free <b>transmit</b> time/spectrum window	EUT transmits on interference free <b>transmit</b> slot	<b>Pass</b>
g) Transmission not possible on any time/spectrum window	No connection possible	<b>Pass</b>

Comment: See plots.

**Limits, FCC 15.323(c)(10)**

An initiating device may attempt to establish a duplex connection by monitoring both its intended transmit and receive time and spectrum windows. If both the intended transmit and receive time and spectrum windows meet the access criteria, then the initiating device can initiate a transmission in the intended transmit time and spectrum window. If the power detected by the responding device can be decoded as a duplex connection signal from the initiating device, then the responding device may immediately begin transmitting on the receive time and spectrum window monitored by the initiating device.



**RESOLUTION BANDWIDTH**  
 300 kHz  
 Ref 0 dBm \*Att 10 dB

RBW 300 kHz  
 VBW 1 MHz  
 SWT 10 ms

1 PK\*  
 CLRWR

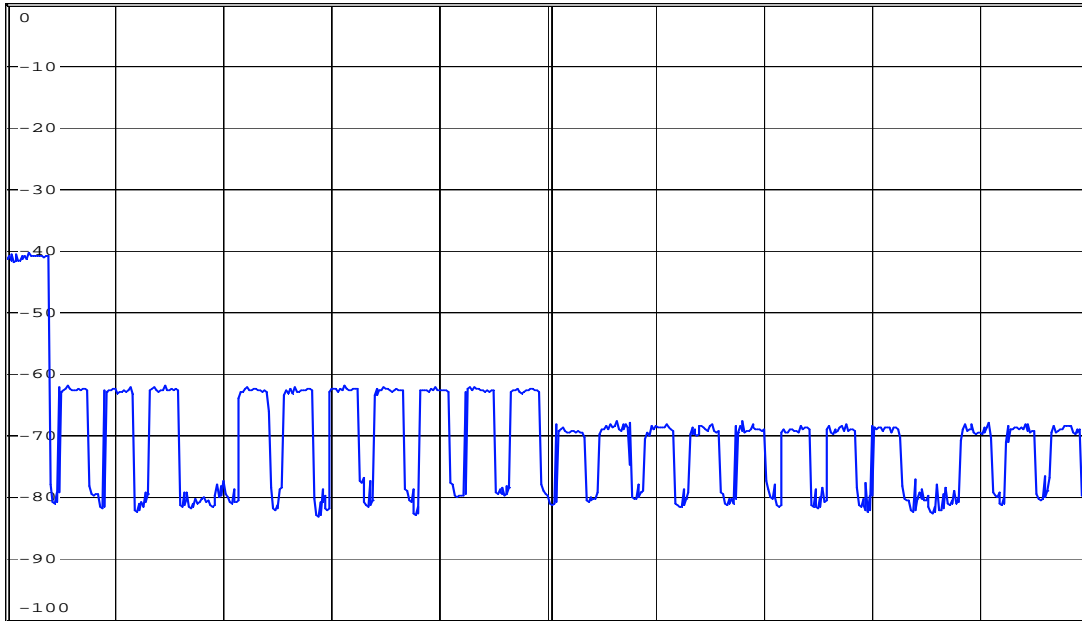

Center 1.923264 GHz 1 ms/

Date: 12.MAY.2014 14:09:13

**8.3.2c) EUT Transmits on Interference Free RECEIVE Slot, BEFORE**



**RESOLUTION BANDWIDTH**  
 300 kHz  
 Ref 0 dBm \*Att 10 dB

RBW 300 kHz  
 VBW 1 MHz  
 SWT 10 ms

1 PK\*  
 CLRWR

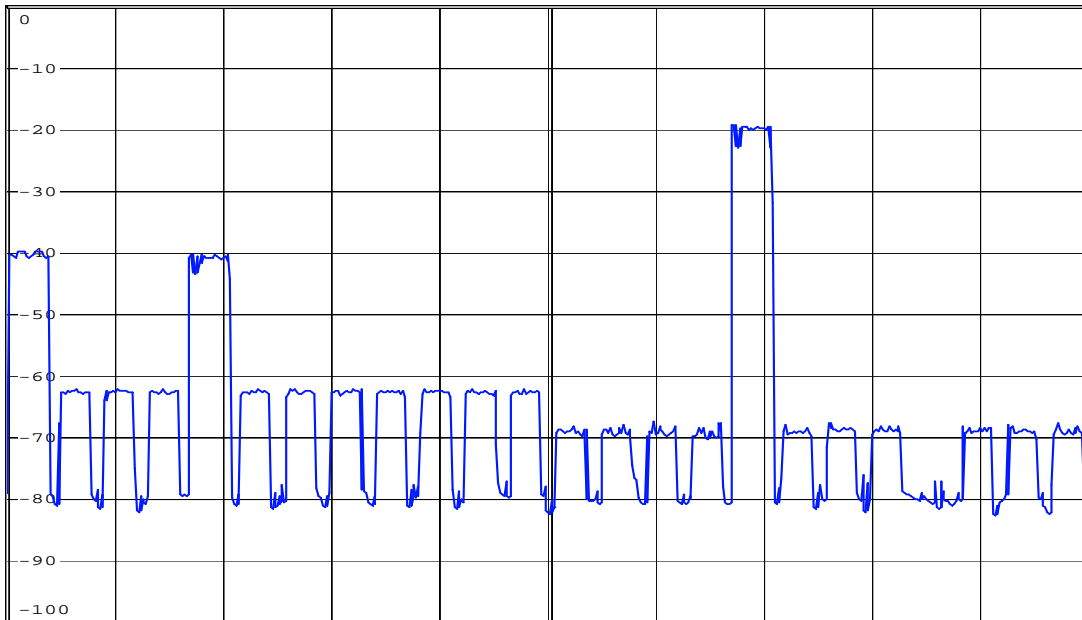

Center 1.923264 GHz 1 ms/

Date: 12.MAY.2014 14:10:22

**8.3.2c) EUT Transmits on Interference Free RECEIVE Slot, AFTER**



**RESOLUTION BANDWIDTH**  
 300 kHz  
 Ref 0 dBm \* Att 10 dB

RBW 300 kHz  
 VBW 1 MHz  
 SWT 10 ms

1 PK \*  
 CLRWR

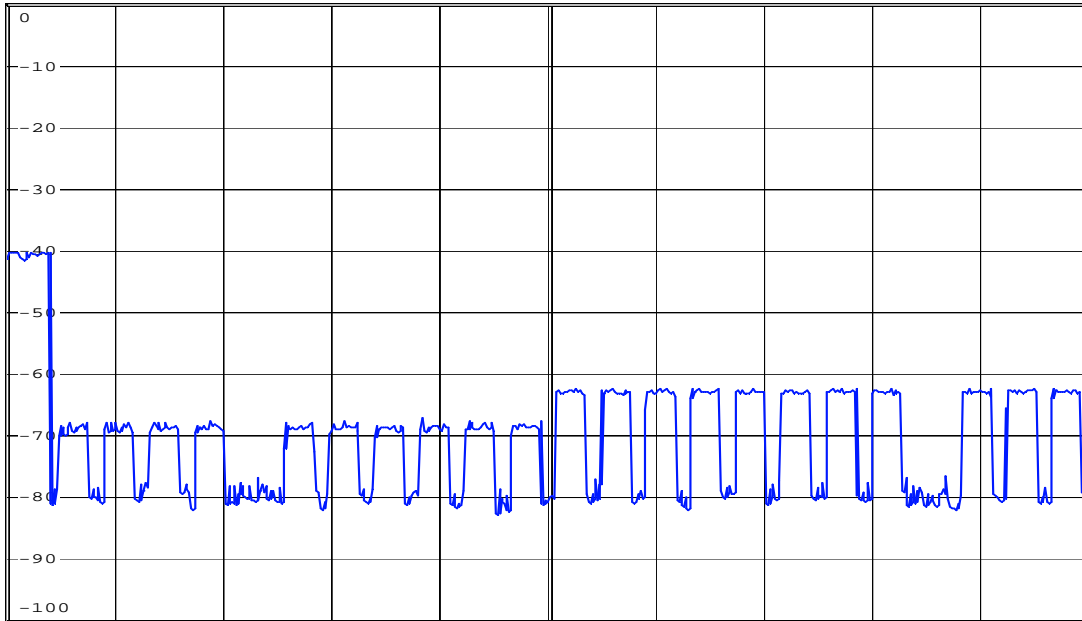

Date: 12.MAY.2014 14:12:33

**8.3.2e) EUT Transmits on Interference Free TRANSMIT Slot, BEFORE**



**RESOLUTION BANDWIDTH**  
 300 kHz  
 Ref 0 dBm \* Att 10 dB

RBW 300 kHz  
 VBW 1 MHz  
 SWT 10 ms

1 PK \*  
 CLRWR

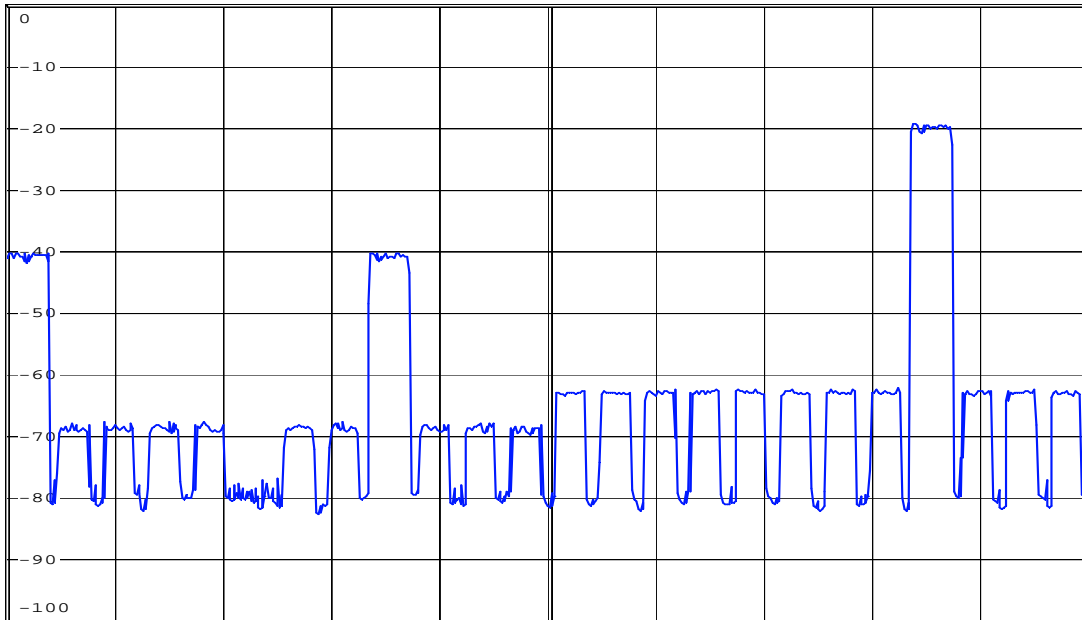

Date: 12.MAY.2014 14:13:07

**8.3.2e) EUT Transmits on Interference Free TRANSMIT Slot, AFTER**



RESOLUTION BANDWIDTH  
300 kHz  
Ref 0 dBm \*Att 10 dB

RBW 300 kHz  
VBW 1 MHz  
SWT 10 ms

L PK  
CLRWR

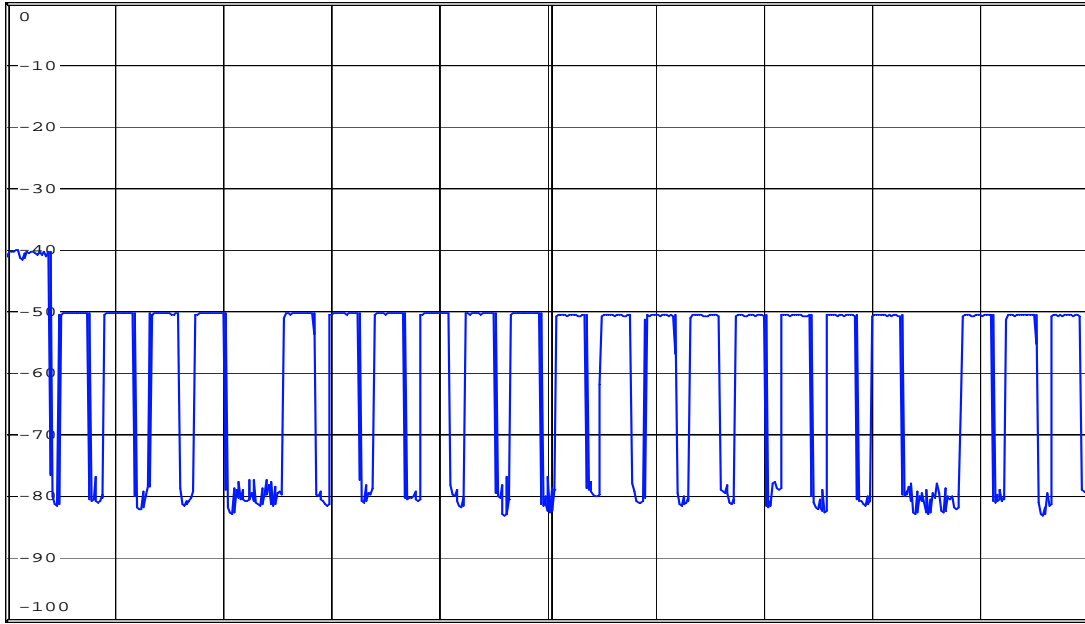

A  
TRG

Date: 12.MAY.2014 14:11:57

8.3.2g) No Connection

### **3.22 Alternative Monitoring Interval**

Test procedure described in ANSI C63.17 clause 8.4.

This test is required if the EUT implements the provisions of FCC 15.323(c)(11).

**Test result:**

Not Tested. The tested EUT does not implement this provision. See manufacturers' declaration.

## 4 Test Setups

### 4.1 Frequency Measurements



Test equipment included: 5, 9, 19, 22, 28

#### Test Set-up 1

This setup is used for measuring Carrier frequency stability at normal and extreme temperatures.

### 4.2 Timing Measurements

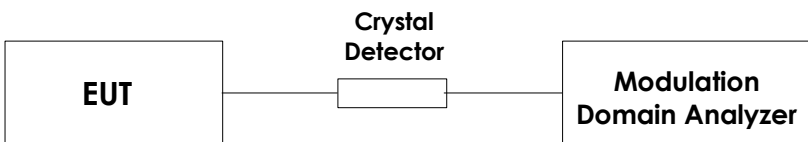

Test equipment included: 5, 7, 9, 19, 22

#### Test Set-up 2

This setup is used for measuring Frame repetition stability, Frame period and Jitter.

### 4.3 Conducted Emission Test

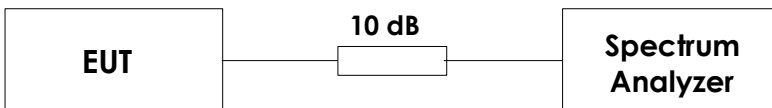

Test equipment included: 1, 2, 9, 19, 22, 26

#### Test Set-up 3

This setup is used for all conducted emission tests.

### 4.4 Power Line Conducted Emissions Test

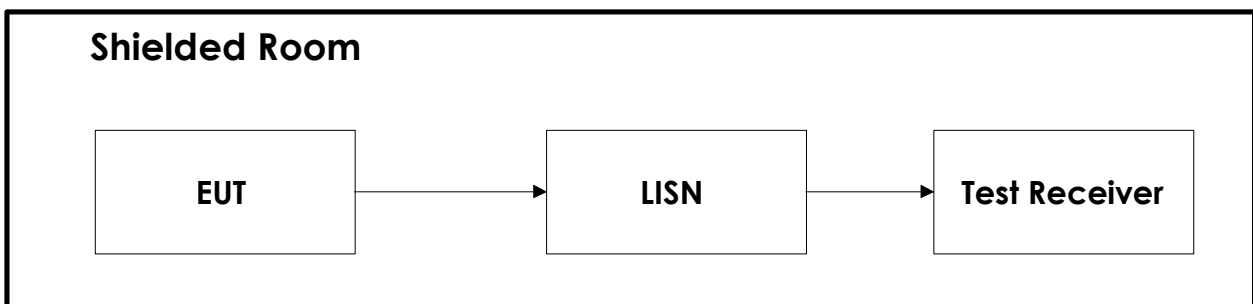

Test equipment: 8, 17, 19, 22, 27

#### Test Set-Up 5

## 4.5 Monitoring Tests

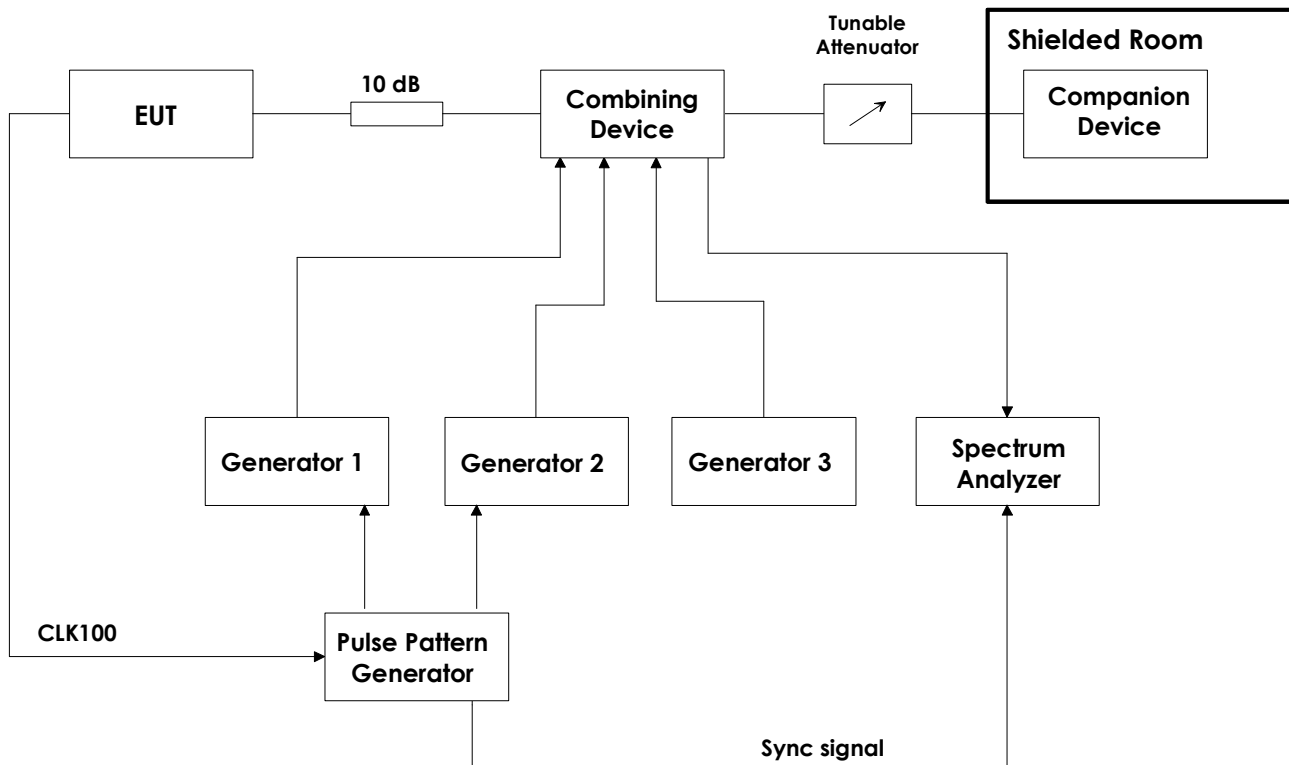

Test equipment: 2, 3, 4, 6, 9, 10, 11, 12, 13, 14, 15, 19, 23, 24, 25, 26, 29

### Test Set-Up 6

This test setup is used for all Monitoring and Time and Spectrum Access Procedure tests. The path loss from the signal generators to the EUT is measured with a power meter before the testing is started.

The CLK100 is used to synchronize the Pulse-/ Pattern generator to the start of the DECT frame, this signal always comes from the base station. If the EUT is a DECT Portable Part (i.e. a handset) the CLK100 signal will come from the Companion Device.

The sync signal to the Spectrum Analyzer is the CLK100 signal that is regenerated in the Pulse-/ Pattern Generator, this is used to synchronize the Spectrum Analyzer to the DECT frame when in zero span. The Pulse-/ Pattern Generator is used for tests that require time synchronized pulses or blocking of specific time slots.

## 5 Test Equipment Used

To facilitate inclusion on each page of the test equipment used for related tests, each item of test equipment and ancillaries are identified (numbered) by the Testhouse.

No.	Model number	Description	Manufacturer	Ref. no.	Cal. date	Cal. Due
1	FSW26	Spectrum Analyzer	Rohde & Schwarz	LR 1504	2013.08.30	2014.08.30
2	SME03	Signal generator	Rohde & Schwarz	LR 1238	2013.03.19	2015.03.19
3	SMIQ03B	Signal generator	Rohde & Schwarz	LR 1516	2012.11.02	2014.11.02
4	SMHU52	Signal generator	Rohde & Schwarz	LR 1240	Cal b4 use	
5	53310A	Modulation Domain Analyzer	Hewlett Packard	LR 1483	2013.08.14	2015.08.14
6	81104A	Pulse-/ Pattern Generator	Agilent	LR 1502	2013.03.19	2015.03.19
7	8470B	Crystal Detector	Hewlett Packard	LR 1207	N/A	
8	ESHS10	Measuring Receiver	Rohde & Schwarz	N- 3528	2012.06.28	2014.06.28
9	4768-10	Attenuator	Narda	LR1356	Cal b4 use	
10	745-69	Step Attenuator	Narda	LR 1442	N/A	
11	WE 1506A	Power Splitter	Weinchel	LR 244	Cal b4 use	
12	WE 1506A	Power Splitter	Weinchel	LR 245	Cal b4 use	
13	H-9	Hybrid	Anzac	LR 86	Cal b4 use	
14	H-9	Hybrid	Anzac	LR 257	Cal b4 use	
15	S212DS	RF Switch	Narda	LR 1244	N/A	
17	ESH3-Z5	Two Line V-Network	Rohde & Schwarz	LR 1076	Cal b4 use	
19	6812B	AC Power Source	Agilent	LR 1515	2013.10.28	2014.10.28
22	Model 87 V	Multimeter	Fluke	N-4670	2013.10.07	2014.10.07
23	87H35-1	Circulator	Racal-MESL	s.no.: 140	N/A	
24	87H35-1	Circulator	Racal-MESL	s.no.: 141	N/A	
25	87H35-1	Circulator	Racal-MESL	s.no.: 142	N/A	
26	U2000A	USB Average Power Sensor	Agilent	LR 1523	2013.10.23	2015.10.23
27	ESH3-Z2	Pulse Limiter	Rohde & Schwarz	LR 1074	Cal b4 use	
28	CMD60	DECT Tester	Rohde & Schwarz	LR 1335	2012.11.01	2014.11.01
29	FSP30	Spectrum Analyzer	Rohde & Schwarz	LR1551	2013.02.25	2015.02.25