

Panasonic[®]

Operating Instructions

Link-to-Cell Cellular Convergence Solution

Model No. **KX-TG7622**

KX-TG7623

KX-TG7624

KX-TG7642

KX-TG7643

KX-TG7644

KX-TG7645

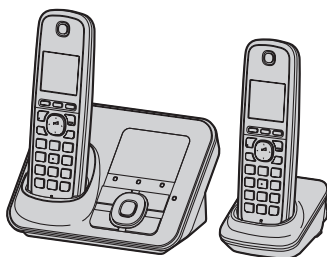

Model shown is KX-TG7622.

DECT
6.0



Before initial use, see "Getting Started" on page 11.

Thank you for purchasing a Panasonic product.

Please read these operating instructions before using the unit and save them for future reference.

Consulte Guía Rápida Española.

This unit is compatible with Caller ID. You must subscribe to the appropriate service offered by your service provider/telephone company.

For assistance, visit our Web site: <http://www.panasonic.com/help> for customers in the U.S.A. or Puerto Rico.

Please register your product: <http://www.panasonic.com/prodreg>

Table of Contents

Introduction		Caller ID Service	
Model composition	4	Using Caller ID service	53
Accessory information	5	Caller list	54
Expanding your phone system	6	Using Bluetooth Devices	
Important Information		Copying phonebook from a cellular phone (phonebook transfer)	57
For your safety	8	Using a Bluetooth wireless headset (optional) for landline calls	58
Important safety instructions	9	Answering System for Landline	
For best performance	9	Answering system for landline	60
Other information	10	Turning the answering system on/off	60
Specifications	10	Greeting message	61
Getting Started		Listening to messages using the base unit	61
Setting up	11	Listening to messages using the handset	62
Note when setting up	12	Voice memo	63
Intelligent eco mode	13	Remote operation	63
Controls	13	Answering system settings	65
Initial settings	18	Voice Mail Service for Landline	
Link to Cell		Voice mail service for landline	67
Link to cell feature	20	Intercom/Locator	
Registering a cellular phone	20	Intercom	69
Link to cell settings	21	Handset locator	69
Making/Answering Calls Using the Handset		Transferring calls, Conference calls	69
Making cellular calls	25	Useful Information	
Making landline calls	25	Wall mounting	71
Answering calls	26	Error messages	74
Useful features during a call	26	Troubleshooting	75
During a power failure	29	FCC and other information	83
Making/Answering Calls Using the Base Unit		Guía Rápida Española	
Making cellular calls	31	Guía Rápida Española	85
Making landline calls	31	Appendix	
Answering calls	32	Customer services	94
Useful features during a call	32	Warranty (For United States and Puerto Rico)	95
Shared Phonebook		Index	
Shared phonebook	35		
Programming			
Programmable settings	39		
Special programming	50		
Registering a unit	52		

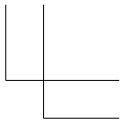
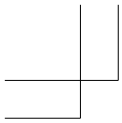
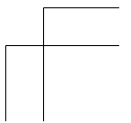
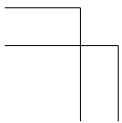
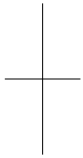

Table of Contents

Index.....97



Introduction

Model composition

■ KX-TG7621 series

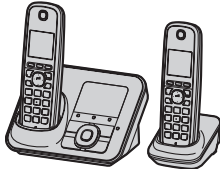

■ KX-TG7641 series

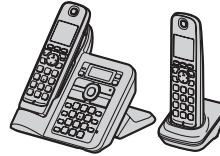

● Model shown is KX-TG7622.

● Model shown is KX-TG7642.

Series	Model No.	Base unit	Handset	
		Part No.	Part No.	Quantity
KX-TG7621 series	KX-TG7622	KX-TG7621	KX-TGA410	2
	KX-TG7623	KX-TG7621	KX-TGA410	3
	KX-TG7624	KX-TG7621	KX-TGA410	4
KX-TG7641 series	KX-TG7642	KX-TG7641	KX-TGA660	2
	KX-TG7643	KX-TG7641	KX-TGA660	3
	KX-TG7644	KX-TG7641	KX-TGA660	4
	KX-TG7645	KX-TG7641	KX-TGA660	5

Feature differences

Series	Power supply mode during power failure	Message counter on base unit*1	Base unit LCD*2	Call with base unit*3	Intercom  *4
KX-TG7621 series	–	●	–	–	–
KX-TG7641 series	●	–	●	●	●

*1 Message counter on base unit shows the number of messages recorded on the answering system.

*2 Displays date and time, phonebook entries, caller information, and messages recorded on the answering system.

*3 Calls can be made or answered with the base unit.

*4 Intercom calls can be made between the base unit and handset.

Accessory information

Supplied accessories

No.	Accessory item/ Order number	Quantity			
		KX-TG7622 KX-TG7642	KX-TG7623 KX-TG7643	KX-TG7624 KX-TG7644	KX-TG7645
①	AC adaptor/ PNLV226Z	2	3	4	5
②	Telephone line cord/ PQJA10075Z	1	1	1	1
③	Rechargeable batteries/ HHR-4DPA	4	6	8	10
④	Wall mounting adaptor/ PQKL10078Z2	1/(-)*1	1/(-)*1	1/(-)*1	1/(-)*1
⑤	Handset cover*2*3	2	3	4	5
⑥	Belt clip/ PNKE1098Z1	(-)*4/2	(-)*4/3	(-)*4/4	(-)*4/5
⑦	Charger/ PNLC1017ZB	1	2	3	4

*1 The wall mounting adaptor is not supplied with KX-TG7641 series (page 4).

*2 The handset cover comes attached to the handset.

*3 PNYNTGA401BR: Black, PNYNTGA660BR: Black,
PNYNTGA660MR: Metallic gray

*4 The belt clip is not supplied with KX-TG7621 series (page 4).

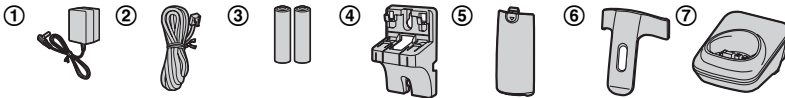

Introduction

Additional/replacement accessories

Please contact your nearest Panasonic dealer for sales information (page 94).

Accessory item	Order number
Rechargeable batteries	HHR-4DPA*1 ● To order, please call 1-800-332-5368 or visit http://www.panasonic.com/batterystore
	Battery type: – Nickel metal hydride (Ni-MH) – 2 x AAA (R03) size for each handset
Headset	KX-TCA60, KX-TCA93, KX-TCA94, KX-TCA400, KX-TCA430
T-adaptor	KX-J66
Range extender	KX-TGA405*2

*1 Replacement batteries may have a different capacity from that of the supplied batteries.



*2 By installing this unit, you can extend the range of your phone system to include areas where reception was previously not available. Up to 2 range extenders can be registered to the base unit. This product can be purchased online. Please visit our Web site: <http://www.panasonic.com/RangeExtender>

Expanding your phone system

Optional handset feature overview

You can expand your phone system by registering optional handsets (6 max.) to a single base unit.

- Optional handsets may be a different color from that of the supplied handsets.

Feature	KX-TGA410	KX-TGA660
Handset		
Display size	1.8 inches	1.8 inches
Button size	Large	Large
Speed dial*1	–	–



Introduction

Feature	KX-TGA410	KX-TGA660	KX-TGA659
Power supply mode during power failure*2	–	●	–

- *1 You can make a call using a speed dial key on the handset as well as the base unit.
- *2 During a power failure, this feature allows you to make or receive calls by temporarily powering the unit with a charged handset placed on the base unit if both the base unit and handset have the power supply feature.

Bluetooth ® devices

You can expand your phone system by registering the following units to a single base unit.

Your Bluetooth cellular phone*1: 2 max. (for cellular calls: page 20)	
Your Bluetooth headset*1: 1 max. (for a wireless hands-free conversation: page 57)	

- *1 Your cellular phone and headset must be Bluetooth wireless technology compatible. For more details and the list of compatible cellular phones, please visit our Web site: <http://www.panasonic.com/LinkToCell>

Important Information

For your safety

To prevent severe injury and loss of life/property, read this section carefully before using the product to ensure proper and safe operation of your product.

WARNING

Power connection

- Use only the power source marked on the product.
- Do not overload power outlets and extension cords. This can result in the risk of fire or electric shock.
- Completely insert the AC adaptor/power plug into the power outlet. Failure to do so may cause electric shock and/or excessive heat resulting in a fire.
- Regularly remove any dust, etc. from the AC adaptor/power plug by pulling it from the power outlet, then wiping with a dry cloth. Accumulated dust may cause an insulation defect from moisture, etc. resulting in a fire.
- Unplug the product from power outlets if it emits smoke, an abnormal smell, or makes an unusual noise. These conditions can cause fire or electric shock. Confirm that smoke has stopped emitting and contact the Panasonic Call Center at 1-800-211-PANA (1-800-211-7262).
- Unplug from power outlets and never touch the inside of the product if its casing has been broken open.
- Never touch the plug with wet hands. Danger of electric shock exists.

Installation

- To prevent the risk of fire or electrical shock, do not expose the product to rain or any type of moisture.
- Do not place or use this product near automatically controlled devices such as automatic doors and fire alarms. Radio waves emitted from this product may cause such devices to malfunction resulting in an accident.
- Do not allow the AC adaptor or telephone line cord to be excessively pulled, bent or placed under heavy objects.

Operating safeguards

- Unplug the product from power outlets before cleaning. Do not use liquid or aerosol cleaners.
- Do not disassemble the product.
- Do not spill liquids (detergents, cleansers, etc.) onto the telephone line cord plug, or allow it to become wet at all. This may cause a fire. If the telephone line cord plug becomes wet, immediately pull it from the telephone wall jack, and do not use.

Medical

- Consult the manufacturer of any personal medical devices, such as pacemakers or hearing aids, to determine if they are adequately shielded from external RF (radio frequency) energy. (The product operates in the frequency range of 1.92 GHz to 1.93 GHz, and the RF transmission power is 115 mW (max.).)
- Do not use the product in health care facilities if any regulations posted in the area instruct you not to do so. Hospitals or health care facilities may be using equipment that could be sensitive to external RF energy.

CAUTION

Installation and location

- Never install telephone wiring during an electrical storm.
- Never install telephone line jacks in wet locations unless the jack is specifically designed for wet locations.
- Never touch uninsulated telephone wires or terminals unless the telephone line has been disconnected at the network interface.
- Use caution when installing or modifying telephone lines.
- The AC adaptor is used as the main disconnect device. Ensure that the AC outlet is installed near the product and is easily accessible.
- This product is unable to make calls when:
 - the handset batteries need recharging or have failed.
 - there is a power failure.

Battery

- We recommend using the batteries noted on page 6. **USE ONLY rechargeable Ni-MH batteries AAA (R03) size.**
- Do not mix old and new batteries.

Important Information

- Do not open or mutilate the batteries. Released electrolyte from the batteries is corrosive and may cause burns or injury to the eyes or skin. The electrolyte is toxic and may be harmful if swallowed.
- Exercise care when handling the batteries. Do not allow conductive materials such as rings, bracelets, or keys to touch the batteries, otherwise a short circuit may cause the batteries and/or the conductive material to overheat and cause burns.
- Charge the batteries provided with or identified for use with this product only, in accordance with the instructions and limitations specified in this manual.
- Only use a compatible base unit (or charger) to charge the batteries. Do not tamper with the base unit (or charger). Failure to follow these instructions may cause the batteries to swell or explode.

Attention:



A nickel metal hydride battery that is recyclable powers the product you have purchased. Please call 1-800-8-BATTERY (1-800-822-8837) for information on how to recycle this battery.

Important safety instructions

When using your product, basic safety precautions should always be followed to reduce the risk of fire, electric shock, and injury to persons, including the following:

1. Do not use this product near water for example, near a bathtub, washbowl, kitchen sink, or laundry tub, in a wet basement or near a swimming pool.
2. Avoid using a telephone (other than a cordless type) during an electrical storm. There may be a remote risk of electric shock from lightning.
3. Do not use the telephone to report a gas leak in the vicinity of the leak.

4. Use only the power cord and batteries indicated in this manual. Do not dispose of batteries in a fire. They may explode. Check with local codes for possible special disposal instructions.

SAVE THESE INSTRUCTIONS

For best performance

Base unit location/avoiding noise

The base unit and other compatible Panasonic units use radio waves to communicate with each other.

- For maximum coverage and noise-free communications, place your base unit:
 - at a convenient, high, and central location with no obstructions between the handset and base unit in an indoor environment.
 - away from electronic appliances such as TVs, radios, personal computers, wireless devices, or other phones.
 - facing away from radio frequency transmitters, such as external antennas of mobile phone cell stations. (Avoid putting the base unit on a bay window or near a window.)
- Coverage and voice quality depends on the local environmental conditions.
- If the reception for a base unit location is not satisfactory, move the base unit to another location for better reception.

Environment

- Keep the product away from electrical noise generating devices, such as fluorescent lamps and motors.
- The product should be kept free from excessive smoke, dust, high temperature, and vibration.
- The product should not be exposed to direct sunlight.
- Do not place heavy objects on top of the product.
- When you leave the product unused for a long period of time, unplug the product from the power outlet.
- The product should be kept away from heat sources such as heaters, kitchen stoves, etc. It should not be placed in rooms where the temperature is less than 0 °C (32 °F) or greater than 40 °C (104 °F). Damp basements should also be avoided.
- The maximum calling distance may be shortened when the product is used in the

Important Information

- following places: Near obstacles such as hills, tunnels, underground, near metal objects such as wire fences, etc.
- Operating the product near electrical appliances may cause interference. Move away from the electrical appliances.

Routine care

- **Wipe the outer surface of the product with a soft moist cloth.**
- Do not use benzine, thinner, or any abrasive powder.

Other information

CAUTION: Risk of explosion if battery is replaced by an incorrect type. Dispose of used batteries according to the instructions.

Notice for product disposal, transfer, or return

- This product can store your private/confidential information. To protect your privacy/confidentiality, we recommend that you erase information such as phonebook or caller list entries from the memory before you dispose of, transfer, or return the product.

Notice

- This product is designed for use in the United States of America. Sale or use of this product in other countries may violate local laws.
- Cet appareil est conçu pour être utilisé aux États-Unis d'Amérique. La vente ou l'emploi de cet appareil dans certains autres pays peut constituer une infraction à la législation locale.
- Este producto está diseñado para usarse en

los Estados Unidos de América.

La venta o el empleo de este producto en ciertos países puede constituir violación de la legislación local.

- 本產品專為美國使用而設。若在其他國家銷售或使用，可能會違反當地法例。
- この製品は、日本国外での使用を目的として設計されており、日本国内での使用は法律違反となります。従って、当社では日本国内においては原則として修理などのサービスは致しかねます。

ENERGY STAR

As an ENERGY STAR Partner, Panasonic has determined that this product meets the ENERGY STAR guidelines for energy efficiency. ENERGY STAR is a U.S. registered mark.



Specifications

■ **Standard:**
DECT 6.0 (Digital Enhanced Cordless Telecommunications 6.0)
Bluetooth wireless technology 2.0

■ **Frequency range:**
1.92 GHz to 1.93 GHz (DECT)
2.402 GHz to 2.48 GHz (Bluetooth)

■ **RF transmission power:**
115 mW (max.)

■ **Power source:**
120 V AC, 60 Hz

■ **Power consumption:**

Base unit*1:
Standby: Approx. 1.2 W
Maximum: Approx. 4.5 W

Base unit*2:
Standby: Approx. 1.2 W
Maximum: Approx. 4.5 W

Charger:
Standby: Approx. 0.1 W
Maximum: Approx. 2.6 W

Operating conditions:
0 °C – 40 °C (32 °F – 104 °F), 20 % – 80 %
relative air humidity (dry)

*1 KX-TG7621 series: page 4

*2 KX-TG7641 series: page 4

Note:

- Design and specifications are subject to change without notice.
- The illustrations in these instructions may vary slightly from the actual product.

Setting up

Connections

- Use only the supplied Panasonic AC adaptor PNLV226.
- If you do not connect the telephone line cord and use only cellular lines, set the cellular line only mode to use this unit more conveniently (page 22).

Base unit (KX-TG7621 series: page 4)

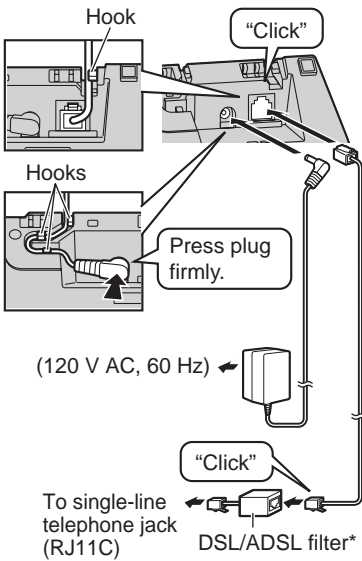

Base unit (KX-TG7641 series: page 4)

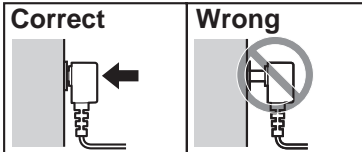
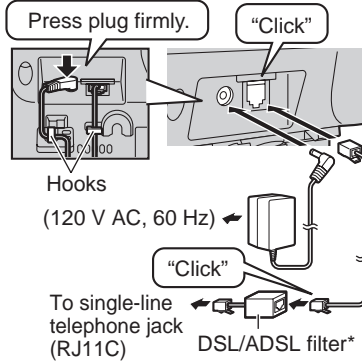

*DSL/ADSL filter (not supplied) is required if you have DSL/ADSL service.

- When the date and time setting is displayed, see page 18.

Charger

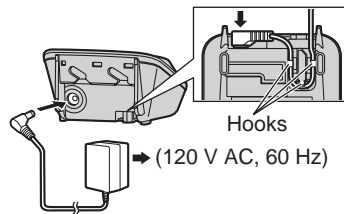

Battery installation

- USE ONLY Ni-MH batteries AAA (R03) size.
- Do NOT use Alkaline/Manganese/Ni-Cd batteries.

Getting Started

- Confirm correct polarities (⊕, ⊖).

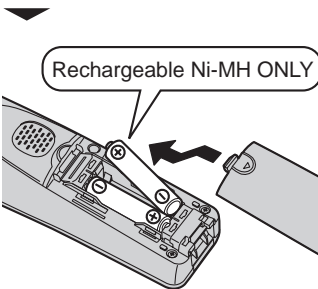
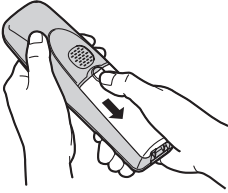

- When the date and time setting is displayed, see page 18.

Battery charge

Charge for about 7 hours.

- When the batteries are fully charged, the charge indicator goes off and "Fully charged" is displayed.

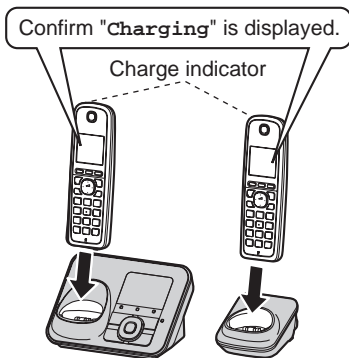

Note when setting up

Note for connections

- The AC adaptor must remain connected at all times. (It is normal for the adaptor to feel warm during use.)
- The AC adaptor should be connected to a vertically oriented or floor-mounted AC outlet. Do not connect the AC adaptor to a ceiling-mounted AC outlet, as the weight of the adaptor may cause it to become disconnected.





Note for battery installation

- Use the supplied rechargeable batteries. For replacement, we recommend using the Panasonic rechargeable batteries noted on Rechargeable batteries Battery.
- Wipe the battery ends (⊕, ⊖) with a dry cloth.
- Avoid touching the battery ends (⊕, ⊖) or the unit contacts.

Note for battery charge

- It is normal for the handset to feel warm during charging.
- Clean the charge contacts of the handset, base unit, and charger with a soft and dry cloth once a month. Clean more often if the unit is exposed to grease, dust, or high humidity.

Battery level

Icon	Battery level
	High
	Medium
	Low
	Needs charging.
	Empty

Panasonic Ni-MH battery performance (supplied batteries)

Operation	Operating time
In continuous use	13 hours max.*1
Not in use (standby)	11 days max.*1

*1 If Eco mode is on.

Note:

- Actual battery performance depends on usage and ambient environment.
- Even after the handset is fully charged, the handset can be left on the base unit or charger without any ill effect on the batteries.
- The battery level may not be displayed correctly after you replace the batteries. In this case, place the handset on the base unit or charger and let it charge for at least 7 hours.

Intelligent eco mode

This feature automatically reduces handset power consumption by suppressing handset transmission power when the handset is close to the base unit.

- When this feature is activated, **ECO** is displayed. However, during a cellular call, **ECO** is not displayed even though this feature is activated.
- Eco mode is turned off when the clarity booster is activated (Handset clarity booster).

Controls

Handset

■ KX-TG7621 series (page 4)

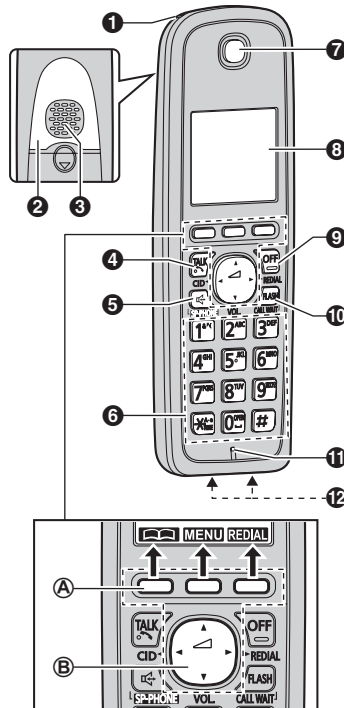

- Charge indicator**
Ringer indicator Message indicator
- Nonslip pad**
 - Nonslip pad offers support when you cradle the handset between your shoulder and ear.
- Speaker**
- [TALK] (TALK)**
- [SP-PHONE] (SP-PHONE: Speakerphone)**
- Dial keypad ([*]: TONE)**
- Receiver**
- Display**

Getting Started

- 9 [OFF]
- 10 [FLASH] [CALL WAIT]
- 11 Microphone
- 12 Charge contacts

■ KX-TG7641 series (page 4)

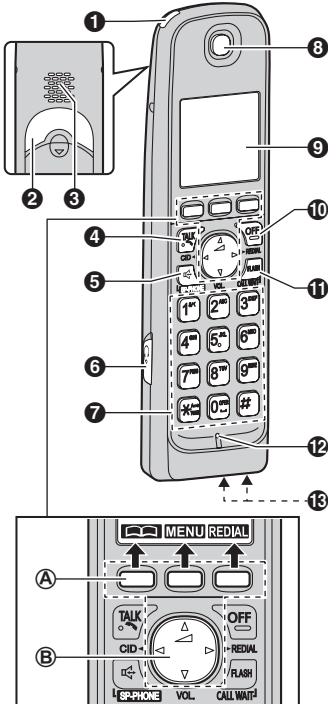

- 1 Charge indicator
Ringer indicator Message indicator
- 2 Nonslip pad
 - Nonslip pad offers support when you cradle the handset between your shoulder and ear.
- 3 Speaker
- 4 [TALK] (TALK)
- 5 [SP-PHONE] (SP-PHONE: Speakerphone)
- 6 Headset jack
- 7 Dial keypad ([*]: TONE)

- 8 Receiver
- 9 Display
- 10 [OFF]
- 11 [FLASH] [CALL WAIT]
- 12 Microphone
- 13 Charge contacts

■ Control type

Ⓐ Soft keys

The handset features 3 soft keys. By pressing a soft key, you can select the feature shown directly above it on the display.

Ⓑ Navigator key

- [▲],[▼],[◀], or [▶]: Scroll through various lists and items.
- VOL. (Volume: [▲], or [▼]): Adjust the receiver or speaker volume while talking.
- [◀]CID (Caller ID): View the caller list.
- [▶]REDIAL: View the redial list.

Base unit

■ KX-TG7621 series (page 4)

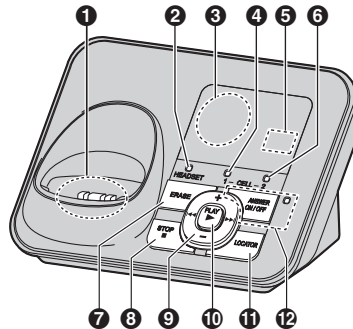

- 1 Charge contacts
- 2 HEADSET indicator
- 3 Speaker
- 4 CELL 1 indicator
- 5 Message counter

- ⑥ CELL 2 indicator
- ⑦ [ERASE]
- ⑧ [■] (STOP)
- ⑨ [+]/[-] (Volume up/down)
[⏪]/[⏩] (Repeat/Skip)
- ⑩ [▶] (PLAY)
Message indicator
- ⑪ [LOCATOR]
- ⑫ [ANSWER ON/OFF]
ANSWER ON/OFF indicator

■ KX-TG7641 series (page 4)

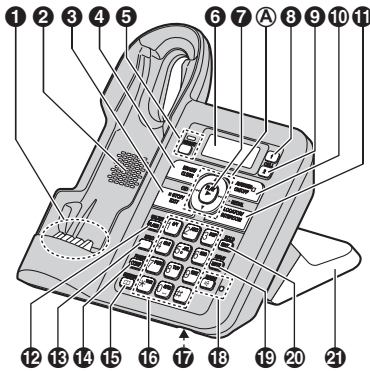

- ① Charge contacts
- ② Speaker
- ③ [■] (STOP) (EXIT)
- ④ [ERASE] [CLEAR]
- ⑤ [HEADSET]
HEADSET indicator
- ⑥ Display
- ⑦ [▶] (PLAY)
Message indicator
- ⑧ [CELL 1]
CELL 1 indicator
- ⑨ [CELL 2]
CELL 2 indicator
- ⑩ [ANSWER ON/OFF]
ANSWER ON/OFF indicator

- ⑪ [LOCATOR] [INTERCOM]
- ⑫ [FLASH] [CALL WAIT]
- ⑬ [MEMO]
- ⑭ [CONF] (Conference)[PAUSE]
- ⑮ [PHONEBOOK]
- ⑯ Dial keypad ([*]: TONE)
- ⑰ Microphone
- ⑱ [☎] (SP-PHONE: Speakerphone)
SP-PHONE indicator
- ⑲ [MUTE] [DISPLAY]
- ⑳ [EDIT] [HOLD]
- ㉑ Bracket*1

*1 The base unit has an unremovable bracket for desk or wall mounting.
To mount on a wall, see page 71.

■ Control type

Ⓐ Navigator key

- [▲],[▼],[◀], or [▶]: Scroll through various lists and items.
- [▲], or [▼] (Volume): Adjust the receiver or speaker volume while talking.
- [◀] CID (Caller ID): View the caller list.
- [▶] REDIAL: View the redial list.

Belt clip

■ To attach

■ To remove

















Display/Indicators

Handset display items

Item	Meaning
▽	Within base unit range
▽	Out of base unit range

Getting Started

Item	Meaning
	The landline is in use. <ul style="list-style-type: none"> When flashing: The call is put on hold. When flashing rapidly: An incoming call is now being received.
	A cellular line is in use. <ul style="list-style-type: none"> When flashing: the cellular call is put on hold. When flashing rapidly: a cellular call is being received.
	A cellular phone is connected.* ¹ Ready to make/receive cellular calls. <ul style="list-style-type: none"> When turned off: a cellular phone is not connected to the base unit (page 22).
 	<ul style="list-style-type: none"> The cellular line is selected for the ringer setting. A cellular call is being received on that line.
	Eco mode is on.* ² (page 13)
	Voice enhancer is set. (page xx)
	Speakerphone is on. (page 25)
	Ringer volume is off.* ³ (page 48)
	Silent mode is on. (page 50)
	Privacy mode is on. (page xx)
	Alarm is on. (page 50)

Item	Meaning
	Handset number
	Battery level
	Blocked call (page 51)
	Clarity booster is on.* ² (page 28)
In use	Answering system is being used by another handset or the base unit.
Cell1 in use	Someone is using the cellular line.
Cell2 in use	
Line in use	Someone is using the landline.



*¹ Corresponding cellular line(s) is indicated next to the item.

*² During a cellular call, the item is not displayed even though the feature is activated.

*³ Corresponding lines (1, 2: cellular line, L: landline) are indicated next to the item. If all lines are turned off, no line is indicated.

Base unit display items

■ KX-TG7621 series: page 4

Item	Meaning
	Answering system answers calls with a greeting message and caller messages are not recorded. ("Selecting "Greeting only"", page 66)
	Handset number is displayed when being paged.

CELL 1/CELL 2 indicators on the base unit

The CELL 1/CELL 2 indicators show each cellular line status.

Status		Meaning
Color	Light pattern	
Green	On	A cellular phone is connected. Ready to make/receive cellular calls.
	Flashing	<ul style="list-style-type: none"> – The cellular line is in use. – Phonebook entries are being copied from a cellular phone (page 57).
	Flashing rapidly	A cellular call is being received.
Amber	On	A cellular phone is not connected to the base unit (page 22).
	Flashing rapidly	The base unit is searching for the registered cellular phone.
Red	Flashing	<ul style="list-style-type: none"> – The base unit is registering a cellular phone. – A cellular call is put on hold.
Light off	–	A cellular phone is not registered to the base unit.

HEADSET indicator on the base unit

The HEADSET indicator shows the Bluetooth headset status.

Status		Meaning
Color	Light pattern	
Green	On	A Bluetooth headset is connected to the base unit. Ready to use it.
	Flashing	A Bluetooth headset is in use.
	Flashing rapidly	A landline call is being received.
Amber	On	The Bluetooth headset is not connected to the base unit.
	Flashing rapidly	The base unit is searching for the registered Bluetooth headset.
Red	Flashing	<ul style="list-style-type: none"> – The base unit is registering a headset. – Mute is turned on.
Light off	–	A Bluetooth headset is not registered to the base unit.

Getting Started

Initial settings



■ Direct commands:

The features can be accessed by pressing **[MENU]**, **[#]** and then the corresponding code on the dial keypad.

Example:

Press **[MENU] [#] [1] [1] [0]**

■ Symbol meaning:

Symbol	Meaning
	Perform with the handset.
	Perform with the base unit.
Example: [▼]/[▲]: "OFF"	Press [▼] or [▲] to select the words in quotations.

Important:

- When you install the batteries for the first time, the handset prompts you to set date and time. First press **[OK]**, then proceed to step 2 in "Date and time", page 18.

Date and time

- 1 **[MENU]→[#] [1] [0] [1]**
- 2 Enter the current month, date, and year by selecting 2 digits for each.
Example: July 15, 2011
[0] [7] [1] [5] [1] [1]
- 3 **[OK]**
- 4 Enter the current hour and minute (12-hour clock format) by selecting 2 digits for each.
Example: 9:30
[0] [9] [3] [0]
- 5 **[AM/PM]:** Select "AM" or "PM".
- 6 **[SAVE]→[OFF]**

Note:

- When English is selected as the display language, 12-hour clock format is used. When Spanish is selected, 24-hour clock format is used.
- The date and time may be incorrect after a power failure. In this case, set the date and time again.

Display language

You can select either "English" or "Español" as the display language. The default setting is "English".

Handset

- 1 **[MENU]→[#] [1] [1] [0]**
- 2 **[▼]/[▲]:** Select the desired setting.
- 3 **[SAVE]→[OFF]**

Handset / Base unit*1

*1 KX-TG7641 series:page 4

Available for:

KX-TG7641 series (page 4)

- 1 **[DISPLAY]**
- 2 **[▼]/[▲]:** "Change language"→**[▶]**
- 3 **[▼]/[▲]:** Select the desired setting.→**[▶]**

Voice guidance language

You can select either "English" or "Español" as the voice guidance language of the answering system. The default setting is "English".

- 1 **[MENU]→[#] [1] [1] [2]**
- 2 **[▼]/[▲]:** Select the desired setting.
- 3 **[SAVE]→[OFF]**

Dialing mode

If you cannot make calls, change this setting according to your telephone line service. The default setting is “**Tone**”.

“**Tone**”: For tone dial service.

“**Pulse**”: For rotary/pulse dial service.

- 1** [MENU] → [#] [1] [2] [0]
- 2** [▼]/[▲]: Select the desired setting.
- 3** [SAVE] → [OFF]

Link to Cell

Link to cell feature

To use this feature, you must first register and connect your cellular phones to the base unit (page 20). Your cellular phones must be Bluetooth wireless technology compatible with this product.

This feature allows you to:

- make or answer cellular calls using your home phone (handset or base unit) with better reception.
- maximize the benefits of cellular services (such as free night and weekend calls, or cellular to cellular call plans) by utilizing unused peak minutes with your home phone.
- conserve the battery power of your cellular phone while the unit is on a cellular call. (We recommend charging your cellular phone during the cellular call as your cellular phone battery is being consumed.)

Important:

- Up to 2 cellular phones can be registered. However, only one Bluetooth device (cellular phone or headset) can be connected to the base unit at a time.
- Locate your cellular phone near the base unit. If the cellular phone is too close to the base unit during a cellular call, you may hear noise. For best performance, we recommend placing the cellular phone between 0.6 m to 3 m (2 feet to 10 feet) away from the base unit.

Trademarks

- The Bluetooth® word mark and logos are owned by the Bluetooth SIG, Inc. and any use of such marks by Panasonic Corporation is under license. Other trademarks and trade names are those of their respective owners.

Registering a cellular phone

Important:

- For more details and the list of compatible cellular phones, please visit our Web site:
<http://www.panasonic.com/LinkToCell>
- Before registering a Bluetooth enabled cellular phone to the base unit:
 - we recommend you change the PIN (page 23).
 - make sure that no Bluetooth device such as a Bluetooth headset is connected to your cellular phone.

1 Handset:

[MENU] →

For CELL 1: **[#] [6] [2] [4] [1]**

For CELL 2: **[#] [6] [2] [4] [2]**

- After the CELL 1 or CELL 2 indicator on the base unit starts flashing red, the rest of the procedure must be completed within 5 minutes.

2 Your cellular phone:

While the CELL 1 or CELL 2 indicator is flashing red, follow the instructions of your cellular phone to enter the registration mode.

- Depending on your cellular phone, it may ask you to enter the base unit PIN (default: "0000").

3 Handset:

Wait until a long beep sounds.

- It may take more than 10 seconds to complete registration.
- When the CELL 1 or CELL 2 indicator lights green, the cellular phone is connected to the base unit. You are ready to make cellular calls.

4

To select which unit receives calls for the cellular line, press **[OK]** then continue from step 3, "Selecting

which unit receives cellular calls”, page 21.

- If not required, go to step 5.

5 [OFF]

Note:

- Make sure that your cellular phone is set to connect to this product automatically. Refer to your cellular phone's operating instructions.
- Make sure you cancel your cellular phone's current registration if you want to register it to the other line (page 24).

Link to cell settings

Selecting which unit receives cellular calls

You can select which unit rings and receives calls for a cellular line. When “**A11**” is selected, all handsets and the base unit ring.

1 [MENU]

- 2 For CELL 1: [**#**] [**6**] [**2**] [**7**] [**1**]
For CELL 2: [**#**] [**6**] [**2**] [**7**] [**2**]

- 3 [**▼**] / [**▲**]: Select the desired handset or “**A11**”.

4 [SAVE] → [OFF]

Note:

- When you select a specific handset to receive calls for a cellular line:
 - other handsets cannot answer the calls.
 - the base unit can answer the calls even though it does not ring. However, you can make the base unit ring by adjusting the base unit ringer volume (page 45).
- When you change the setting to “**A11**”, the base unit ringer volume also returns to the lowest level even if the ringer volume has been changed.

Ring as cell mode

Once this feature is turned on, the handset and base unit ring using the same ringer tone as your cellular phone. The following settings are available:

- “**OFF**”: Turn this feature off to use the ringer tones of the handset and base unit. Caller information is announced depending on the Talking Caller ID setting (page 44).
- “**On (with Talking CID)**” (default): The handset and base unit use your cellular phone's ringer tone. Caller information is announced even if the Talking Caller ID is turned off.
- “**On (without Talking CID)**”: The handset and base unit use your cellular phone's ringer tone. Caller information is not announced even if the Talking Caller ID is turned on.

Important:

- To use this feature, your cellular phone must support Bluetooth in-band ringtone. Refer to your cellular phone's operating instructions.

1 [MENU]

- 2 For CELL 1: [**#**] [**6**] [**1**] [**4**] [**1**]
For CELL 2: [**#**] [**6**] [**1**] [**4**] [**2**]

- 3 [**▼**] / [**▲**]: Select the desired setting.

4 [SAVE] → [OFF]

Note:

- The units use the preset ringer tones (page 45) instead of your cellular phone's ringer tone when a cellular call is being received if:
 - your cellular phone is in silent mode. (depending on your cellular phone)
 - the base unit or 2 or more handsets are on a landline call or an intercom call.

Link to Cell

- If your cellular phone is in silent mode with “On (with Talking CID)” set, the unit announces caller information even when Talking Caller ID is turned off (page 44).

To use the handset ringer tone instead of your cellular phone's ringer tone

Select “OFF” in step 3, “Ring as cell mode”, page 21.

To change the handset ringer tone for a cellular line, see page 45.

Auto connection to the cellular phone

After registration, your cellular phone is connected to the base unit. If you move the cellular phone out of base unit range, the cellular phone is disconnected from the base unit. This feature allows the base unit to try to reconnect the cellular phone at regular intervals when it returns within base unit range. You can set the interval. The default setting is “1 min”.

Important:

- When you are using a cellular line or a Bluetooth headset, the base unit loses its connection from other Bluetooth devices (cellular phone or headset). To automatically resume the connection to cellular phones, leave the auto connection on.
- Some cellular phones lose connection after usage, please check the specification of your cellular phone for more details.

- 1 [MENU] → [#] [6] [3] [2]
- 2 [▼]/[▲]: Select the desired setting.
- 3 [SAVE] → [OFF]

Note:

- Some cellular phone may ask you if you accept the connection requirement from the base unit. In that case, select “OFF” in step 2. Check the specification of your cellular phone.

Connecting/disconnecting the cellular phone manually

When you make or answer calls with your cellular phone, we recommend disconnecting it from the base unit, otherwise received audio may not be heard on your cellular phone.

You can also manually reconnect the cellular phone to the base unit without waiting for the auto connection feature to resume the connection.

- 1 [MENU]
- 2 To connect/disconnect:
For CELL 1: [#] [6] [2] [5] [1]
For CELL 2: [#] [6] [2] [5] [2]
 - A long beep sounds.
- 3 [OFF]

Cellular line only mode (If you do not use the landline)



If you do not use the landline, we recommend setting the unit to the cellular line only mode.

- 1 [MENU] → [#] [1] [5] [7]
- 2 To turn on:
[▼]/[▲]: “On” → [SELECT] →
[▼]/[▲]: “Yes” → [SELECT]
To turn off:
[▼]/[▲]: “OFF” → [SELECT]

Note:

- Once you set this mode, you can use the following buttons to make cellular calls:
 - for the handset, press [📞] or [📞] instead of [CELL] (page 25).

Link to Cell



- for the base unit, press [] instead of the line button ([**CELL 1**] or [**CELL 2**]) set for the cellular line selection (page 23, 31).
- Once you set this mode, the following features cannot be used:
 - Landline features (page 42, 46)
 - Answering system (page 60). Messages cannot be received. However, you can only record voice memo messages (page 63).
 - Voice mail features (page 67).
- After this mode is turned on or off, the base unit reboots.
 - Bluetooth connections from cellular phones or headset are disconnected. If the auto connection is turned on (page 22), the cellular phones are reconnected.
 -  will be displayed on the handset momentarily. The handset can be used once  is displayed.

When you use the landline again

Before connecting the telephone line to the base unit, select “off” in step 2, “Cellular line only mode (If you do not use the landline)”, page 22.

Cellular line selection





This feature determines which cellular line is selected to make cellular calls when:

- you press [**CELL**] on the handset.
- you press [] or [] on the handset while the cellular line only mode is turned on.
- you press [] on the base unit while the cellular line only mode is turned on.

The following settings are available:

- “**Manual**” (handset only: default): You can select the desired cellular line when making a call.

- “Cellular phone 1” (base unit default): CELL 1 is selected.
- “Cellular phone 2”: CELL 2 is selected.

- 1 [**MENU**]
- 2 For handset: [] [**6**] [**3**] [**4**]
For base unit: [] [] [**6**] [**3**] [**4**]
- 3 []/[]: Select the desired setting.
- 4 [**SAVE**] → [**OFF**]

Storing your area code (for dialing only a 7-digit phone number to make a local call)

You need to add your area code when making cellular calls to a phone number in your area. Once you store your area code, it is automatically added to the beginning of the 7-digit phone number when making cellular calls.

- 1 [**MENU**] → [] [**6**] [**3**] [**3**]
- 2 Enter the 3-digit area code.
 - To correct a digit, press [**CLEAR**].
- 3 [**SAVE**] → [**OFF**]

Changing the Bluetooth PIN (Personal Identification Number)

The PIN is used to register cellular phones to the base unit. The default PIN is “0000”. To prevent unauthorized access to this product, we recommend that you change the PIN, and keep it confidential.

Important:

- Please make note of your new PIN. The unit does not reveal the PIN to you. If you forget your PIN, see page 82.

- 1 [**MENU**] → [] [**6**] [**1**] [**9**]
- 2 Enter the new 4-digit PIN. → [**OK**]
- 3 Enter the new 4-digit PIN again. → [**SAVE**]

Link to Cell

4 [OFF]

Changing the PIN for the second time

Follow step1, "Changing the Bluetooth PIN (Personal Identification Number)", page 23. Enter the current 4-digit PIN, then continue from step2.

Deregistering Bluetooth devices

A handset can cancel a registration of another Bluetooth devices (cellular phone or headset) that is stored to the base unit.

- 1 **[MENU]** → **[#] [1] [3] [4]**
- 2 **[▼]/[▲]**: Select the desired device.
→ **[SELECT]**
 - indicates a cellular phone, and indicates a headset.
- 3 **[▼]/[▲]**: "yes" → **[SELECT]**
 - When the cellular phone is deregistered, the CELL 1 or CELL 2 indicator is turned off.
 - When the headset is deregistered, the HEADSET indicator is turned off.
- 4 **[OFF]**

Making cellular calls

Important:

- Only 1 cellular line can be used at a time.
- Before making calls, confirm that the CELL 1 or CELL 2 indicator lights green (page 17).

- 1 Lift the handset and dial the phone number.
 - To correct a digit, press **[CLEAR]**.
- 2 **[CELL]**
 - The unit starts dialing when:
 - only 1 cellular phone is registered.
 - a specific line is set to make cellular calls (page 23).Go to step 4.
- 3 **[▼]/[▲]**: Select the desired cellular phone. → **[SELECT]**
- 4 When you finish talking, press **[OFF]** or place the handset on the base unit or charger.

Note:

- To switch to the speaker, press **[🔊]**. To switch back to the receiver, press **[🔊]/[📶]**.

Adjusting the receiver or speaker volume

Press **[▲]** or **[▼]** repeatedly while talking.

Making a cellular call using the redial list

The last 5 phone numbers dialed are stored in the redial list (each 48 digits max.).

- 1 **[▶]** REDIAL
- 2 **[▼]/[▲]**: Select the desired phone number.
- 3 **[CELL]**
 - The unit starts dialing when:

- only 1 cellular phone is registered.
- a specific line is set to make cellular calls (page 23).

- 4 **[▼]/[▲]**: Select the desired cellular phone. → **[SELECT]**

Erasing a number in the redial list

- 1 **[▶]** REDIAL
- 2 **[▼]/[▲]**: Select the desired phone number. → **[ERASE]**
- 3 **[▼]/[▲]**: “Yes” → **[SELECT]**
- 4 **[OFF]**

Making landline calls

- 1 Lift the handset and dial the phone number.
 - To correct a digit, press **[CLEAR]**.
- 2 **[📶]**
- 3 When you finish talking, press **[OFF]** or place the handset on the base unit or charger.

Using the speakerphone

- 1 Dial the phone number and press **[🔊]**.
 - Speak alternately with the other party.
- 2 When you finish talking, press **[OFF]**.

Note:

- For best performance, use the speakerphone in a quiet environment.
- To switch back to the receiver, press **[🔊]/[📶]**.

Making a call using the redial list

- 1 Follow steps 1 and 2, “Making a cellular call using the redial list”, 1 and 2, “Making a cellular call using the redial list”, page 25.

Making/Answering Calls Using the Handset

2 []

Pause (for PBX/long distance service users)

A pause is sometimes required when making calls using a PBX or long distance service. When storing a calling card access number and/or PIN in the phonebook, a pause is also needed (page 37).

Example: If you need to dial the line access number “9” when making outside calls with a PBX:



- 1 [9] → [PAUSE]
- 2 Dial the phone number. → []

Note:

- A 3.5 second pause is inserted each time [PAUSE] is pressed. Repeat as needed to create longer pauses.

Answering calls

When a call is being received, the ringer indicator flashes rapidly.

- 1 Lift the handset and press [] or [] when the unit rings.
 - To answer a cellular call, you can also press [CELL].
 - You can also answer the call by pressing any dial key from [0] to [9], [*], or [#]. (Any key answer feature)
- 2 When you finish talking, press [OFF] or place the handset on the base unit or charger.

Auto talk

You can answer calls simply by lifting the handset off the base unit or charger. You do not need to press []. To turn this feature on, see page 44.

Adjusting the handset ringer volume

■ While the handset is ringing for an incoming call:

Press [▲] or [▼] repeatedly to select the desired volume.

■ Programming the volume beforehand:

- 1 To change the cellular line ringer volume:
[MENU] [#] [1] [6] [0]
To change the landline ringer volume:
[MENU] [6] [2] [8] [1]
- 2 [▼]/[▲]: Select the desired volume.
- 3 [SAVE] → [OFF]

Temporary handset ringer off

While the handset is ringing for a call, you can turn the ringer off temporarily by pressing [].

Useful features during a call

Hold

This feature allows you to put an outside call on hold.

- 1 Press [MENU] during an outside call.
- 2 [▼]/[▲]: “Hold” → [SELECT]
- 3 To release hold on the cellular line:
Press [CELL].
 - Another handset user can take the call: [CELL] *1 → [SELECT]

*1 The call is taken when:

 - only 1 cellular phone is registered.
 - the line is set to make cellular calls (page 23).

Making/Answering Calls Using the Handset

- The base unit user can take the call by pressing **[CELL 1]** or **[CELL 2]**.

To release hold on the landline:

Press [].

- Another handset user can take the call by pressing [].
- The base unit user can take the call by pressing **[SP-PHONE]** (KX-TG7641 series: page 4).

Note:

- If a call is kept on hold for more than 9 minutes, an alarm tone starts to sound and the ringer indicator flashes rapidly. After 1 additional minute on hold, the call is disconnected.

Mute

While mute is turned on, you can hear the other party, but the other party cannot hear you.

- 1 Press **[MUTE]** during conversation.
 - **[MUTE]** flashes.
- 2 To return to the conversation, press **[MUTE]** again.

Note:

- **[MUTE]** is a soft key visible on the handset display during a call.

Flash for landline calls

[FLASH] allows you to use the special features of your host PBX such as transferring an extension call, or accessing optional telephone services.

Note:

- To change the flash time, see page 47.

For call waiting or Call Waiting Caller ID service users

To use call waiting, you must first subscribe to call waiting from your service provider/telephone company. This feature allows you to receive calls while you are already talking on the phone. If you receive a call while on the phone, you will hear a call waiting tone. **If you subscribe to both Caller ID and Call Waiting with Caller ID services**, the 2nd caller's information is displayed after you hear the call waiting tone on the handset.

- 1 Press **[CALL WAIT]** to answer the 2nd call.
- 2 To switch between calls, press **[CALL WAIT]**.

Note:

- Please contact your service provider/telephone company for details and availability of this service in your area.

Temporary tone dialing for landline calls (for rotary/pulse service users)

You can temporarily switch the dialing mode to tone when you need to access touch-tone services (for example, answering services, telephone banking services, etc.).

Press **[*]** (TONE) before entering access numbers which require tone dialing.

Handset clarity booster

This feature can improve sound clarity when the handset is used in an area where there may be interference. During an outside call, this feature is turned on automatically when necessary.

Making/Answering Calls Using the Handset

- When this feature is turned on, **BOOST** is displayed. However, during a cellular call, **BOOST** is not displayed even though the feature is activated.

Handset equalizer

This feature clarifies the voice of the person you are talking to, producing a more natural-sounding voice that is easier to hear and understand.

- 1 Press **[MENU]** while talking.
- 2 **[▼]/[▲]**: "Equalizer" → **[SELECT]**
- 3 **[▼]/[▲]**: Select the desired setting. → **[SAVE]**

Note:

- When this feature is activated, **(^e)** is displayed while talking.
- Depending on the condition and quality of your telephone line, this feature may emphasise existing line noise. If it becomes difficult to hear, turn this feature off.
- This feature is not available while using the speakerphone.

Call share

This feature allows you to join an existing outside call.

■ While another unit is on a cellular call:

- 1 To join the conversation, press **[CELL]**.
 - You can only join the conversation when
 - only 1 cellular phone is registered.
 - the line is set to make cellular calls (page 23).
- 2 **[▼]/[▲]**: Select the desired cellular phone. → **[SELECT]**

■ While another unit is on a landline call:

- To join the conversation, press **[↶]**.

Note:

- A maximum of 3 parties (including 1 outside party) can join a conversation using 2 extensions. (**3-way conference**)
- To prevent other users from joining your conversations with outside callers, turn this feature off (page xx).

Transferring a cellular call between the handset and a cellular phone

Transferring a cellular call from the handset to a cellular phone

- 1 Press **[MENU]** during a cellular call.
- 2 **[▼]/[▲]**: "Transfer to cell" → **[SELECT]**
 - The cellular call is transferred to the cellular phone.

Note:

- Depending on your cellular phone type, you may need to set the cellular phone ready to talk before transferring. For example, if your cellular phone has a top cover, open it beforehand.

Transferring a cellular call from a cellular phone to the handset

During a conversation using a cellular phone, the call cannot be transferred to the handset by the cellular phone.

Perform the following with the handset.

- 1 During a conversation using a cellular phone, press **[CELL]**.
 - The call is transferred to the handset when:
 - only 1 cellular phone is registered.
 - the line is set to make cellular calls (page 23).

Making/Answering Calls Using the Handset

- 2** [▼]/[▲]: Select the desired cellular phone. → [SELECT]

- The call is transferred to the handset.

Using the other line during a conversation

You can handle a cellular call and a landline call at the same time. When another call is being received during a conversation, the interrupt tone sounds (page 43), and the 2nd caller's information is displayed if you subscribe to Caller ID (page 53). You can answer the 2nd call while holding the 1st call.

Making/answering a cellular call during a conversation on the landline

- 1** Press [MENU] during a landline call.
- 2** [▼]/[▲]: "Hold" → [SELECT]
- 3** **To make a 2nd call:**
Dial the phone number. → [CELL] *1 → [▼]/[▲]: Select the desired cellular phone. → [SELECT]

- *1 The unit starts dialing when:
- only 1 cellular phone is registered.
 - a specific line is set to make cellular calls (page 23).

To answer a 2nd call: [CELL]

- To hold the 2nd call: [MENU] → [▼]/[▲]: "Hold" → [SELECT]
- 4** To hang up the 2nd call and return to the 1st call (landline call), press [OFF], then press [↶].

Making/answering a landline call during a conversation on a cellular line

- 1** Press [MENU] during a cellular call.
- 2** [▼]/[▲]: "Hold" → [SELECT]

- 3** **To make a 2nd call:**
Dial the phone number. → [↶]

To answer a 2nd call:

[↶]

- To hold the 2nd call: [MENU] → [▼]/[▲]: "Hold" → [SELECT]

- 4** To hang up the 2nd call and return to the 1st call (cellular call), press [OFF], then press [CELL].

During a power failure

Available for:

KX-TG7641 series (page 4)

When a power failure occurs, the unit goes into power supply mode and the charged handset temporarily supplies power to the base unit. This allows you to make and receive landline calls during a power failure. The base unit will not perform any other functions. You can program "Power failure" and the default setting is "off" (page xx).

Important:

- Power supply mode will not work if the battery level of the power supplying handset is lower than .
- If a handset is not placed on the base unit when a power failure occurs, "Base no power Press OFF" is displayed. After pressing [OFF] on the handset, place it on the base unit to start power supply mode.
- Do not lift the power supplying handset from the base unit during power supply mode.
- Do not touch the handset's charge contacts since they will be hot during power supply mode.
- In case handset battery power runs out, we recommend connecting a corded-type telephone (without AC adaptor) to the same telephone line or

Making/Answering Calls Using the Handset

to the same telephone line jack using a Panasonic T-adaptor (page 6).

Making calls

■ When 1 handset is registered:

- 1 During a power failure, lift the handset and dial the phone number.
- 2 Within 1 minute, place the handset on the base unit.
 - Speakerphone is turned on automatically and the call is made.
- 3 When the other party answers the call, keep the handset on the base unit and talk using the speakerphone.
- 4 When you finish talking, press **[OFF]**.

Note:

- In step 1, if you do not place the handset on the base unit within 1 minute, the power supply mode turns off. In this case, press **[OFF]** on the handset and place it on the base unit. Then try again from step 1.

■ When 2 or more handsets are registered:

You can use one handset for supplying the power by placing it on the base unit and another handset for making calls. For the operation, please see "Making landline calls", page 25.

Note:

- The redial list and phonebook is available during a power failure. When only 1 handset is registered, lift the handset and display the desired phone number, then place the handset on the base unit. The call is then made automatically.

- The range of the base unit is limited during a power failure. Please use the handset close to the base unit.

Answering calls

■ When 1 handset is registered:

- 1 When the unit rings, press **[]** or **[]**.
 - Speakerphone is turned on.
 - Do not lift the handset from the base unit.
- 2 When you finish talking, press **[OFF]**.

■ When 2 or more handsets are registered:

When the unit rings, use a handset which is not supplying power to the base unit. Do not use or lift the handset which is placed on the base unit during power supply mode. For the operation, please see "Answering calls", page 26.

Note:

- The range of the base unit is limited during a power failure. Use the handset close to the base unit.

Making cellular calls

Available for:

KX-TG7641 series (page 4)

- 1 Press **[CELL 1]** or **[CELL 2]**.
- 2 Dial the phone number.*1 → Press **[CELL 1]** or **[CELL 2]** again or wait for 5 seconds.
 - *1 Dial the next digit within 5 seconds, otherwise the unit starts dialing.
- 3 When the other party answers, speak into the microphone.
 - Speak alternately with the other party.
- 4 When you finish talking, press **[📞]**.

Note:

- For best performance, use the speakerphone in a quiet environment.
- While on a call, you can switch from the base unit to the handset:
With the call sharing feature on (page 33), press **[CELL]** on the handset. → **[▼]/[▲]**: Select the desired cellular phone. → **[SELECT]** → Press **[📞]** on the base unit.
 - When only 1 cellular phone is registered or the line is set to make cellular calls (page 23), press **[CELL]** on the handset, then press **[📞]** on the base unit.

If the handset is on the base unit, simply lift it.

Adjusting the speaker volume

- **KX-TG7621 series: page 4**
Press **[+]** or **[-]** repeatedly while talking.
- **KX-TG7641 series: page 4**
Press **[▲]** or **[▼]** repeatedly while talking.

Redialing the last number dialed

- 1 **To make a cellular call:**
Press **[CELL 1]** or **[CELL 2]**.
- 2 **[REDIAL]**

Making landline calls

- 1 **[📞]** → Dial the phone number.
- 2 When the other party answers, speak into the microphone.
- 3 When you finish talking, press **[📞]**.

Note:

- While on a call, you can switch from the base unit to the handset:
Press **[📞]** on the handset, then press **[📞]** on the base unit with the call sharing feature on (page 33).

Making a call using the redial list

Available for:

KX-TG7641 series (page 4)

The last 10 phone numbers dialed are stored in the redial list (each 48 digits max.).

- 1 **[▶▶]** REDIAL
- 2 **[▼]/[▲]**: Select the desired phone number.
- 3 **[📞]**

Erasing a number in the redial list



- 1 **[▶▶]** REDIAL
- 2 **[▼]/[▲]**: Select the desired phone number. → **[ERASE]**
- 3 **[▼]/[▲]**: "Yes" → **[▶]** (PLAY)
- 4 **[■]** (EDIT)

Making/Answering Calls Using the Base Unit

Answering calls

Answering calls

When a call is being received, the SP-PHONE indicator flashes rapidly. When a cellular call is being received, the CELL 1 or CELL 2 indicator flashes rapidly.

- 1 Press [] when the unit rings.
 - You can also answer the cellular call by pressing [CELL 1] or [CELL 2].
- 2 Speak into the microphone.
- 3 When you finish talking, press [].

Adjusting the base unit ringer volume

■ KX-TG7621 series: page 4

Press [+] or [-] repeatedly to select the desired volume.

- To turn the ringer off, press and hold [-] until the unit beeps.

■ KX-TG7641 series: page 4

Press [▲] or [▼] repeatedly to select the desired volume.

- To turn the ringer off, press and hold [▼] until the unit beeps.

Note:

- You can also program the base unit ringer volume beforehand (cellular lines: page 45, landline: page 46).

Useful features during a call

Hold

This feature allows you to put an outside call on hold.

- 1 Press [HOLD] during an outside call.

2 To release hold on the cellular line:

Press [CELL 1] or [CELL 2].

- A handset user can take the call: [CELL] *1 → [SELECT]

*1 The call is taken when:

- only 1 cellular phone is registered.
- the line is set to make cellular calls (page 23).

To release hold on the landline:

Press [].

- A handset user can take the landline call by pressing [].

Note:

- While a cellular line is on hold, the CELL 1 or CELL 2 indicator flashes red. While a landline call is on hold, the SP-PHONE indicator flashes.
- If a call is kept on hold for more than 9 minutes, an alarm tone starts to sound. After 1 additional minute on hold, the call is disconnected.

Mute

While mute is turned on, you can hear the other party, but the other party cannot hear you.

- 1 Press [MUTE] during conversation.
 - The SP-PHONE indicator on the base unit flashes.
- 2 To return to the conversation, press [MUTE] again.

Flash for landline calls

[FLASH] allows you to use the special features of your host PBX such as transferring an extension call, or accessing optional telephone services.

Note:

- To change the flash time, see page 47.

Making/Answering Calls Using the Base Unit

For call waiting or Call Waiting Caller ID service users

To use call waiting, you must first subscribe to call waiting from your service provider/telephone company. This feature allows you to receive calls while you are already talking on the phone. If you receive a call while on the phone, you will hear a call waiting tone. **If you subscribe to both Caller ID and Call Waiting with Caller ID services**, the 2nd caller's information is displayed after you hear the call waiting tone on the base unit.

- 1 Press **[CALL WAIT]** to answer the 2nd call.
- 2 To switch between calls, press **[CALL WAIT]**.

Note:

- Please contact your service provider/telephone company for details and availability of this service in your area.

Temporary tone dialing for landline calls (for rotary/pulse service users)

You can temporarily switch the dialing mode to tone when you need to access touch-tone services (for example, answering services, telephone banking services, etc.).

Press **[*]** (TONE) before entering access numbers which require tone dialing.

Call share

This feature allows you to join an existing outside call.

To select the line that is being used for the call:

- for a cellular line press **[CELL 1]** or **[CELL 2]**.
- for the landline press **[☎]**.

Note:

- A maximum of 3 parties (including 1 outside party) can join a conversation using 2 extensions. **(3-way conference)**
- To prevent other users from joining your conversations with outside callers, turn this feature off (page xx).

Transferring a cellular call between the base unit and a cellular phone

Transferring a cellular call from the base unit to a cellular phone

During a cellular call, press and hold **[CELL 1]** or **[CELL 2]** until the SP-PHONE indicator goes out.

- The cellular call is transferred to the cellular phone.

Transferring a cellular call from a cellular phone to the base unit

During a conversation using a cellular phone, press **[CELL 1]** or **[CELL 2]**.

- The cellular call is transferred to the base unit.

Using the other line during a conversation

You can handle a cellular call and a landline call at the same time. When another call is being received during a conversation, the interrupt tone sounds (page 43). You can answer the 2nd call while holding the 1st call.

Making/answering a cellular call during a conversation on the landline

- 1 Press **[HOLD]** during a landline call.
- 2 **To make a 2nd call:**
Press **[CELL 1]** or **[CELL 2]**. →
Dial the phone number.*1 → Press

Making/Answering Calls Using the Base Unit

[CELL 1] or **[CELL 2]** again or wait for 5 seconds.

*1 Dial the next digit within 5 seconds, otherwise the unit starts dialing.

To answer a 2nd call:

Press **[CELL 1]** or **[CELL 2]**.

- To hold the 2nd call, press **[HOLD]**.

3 To hang up the 2nd call and return to the 1st call (landline call), press **[⏪]** 2 times.

Making/answering a landline call during a conversation on a cellular line

1 Press **[HOLD]** during a cellular call.

2 To make a 2nd call:

[⏪] → Dial the phone number.

To answer a 2nd call:

[⏪]

- To hold the 2nd call, press **[HOLD]**.

3 To hang up the 2nd call and return to the 1st call (cellular call), press **[⏪]**, then press **[CELL 1]** or **[CELL 2]**.

Shared phonebook

The shared phonebook allows you to make calls without having to dial manually. Any handset registered to the base unit can use the shared phonebook. You can add 650 names and phone numbers to the shared phonebook, and assign each phonebook entry to the desired group (“Home”, “Cell 1”, “Cell 2”).

Important:

- Only 1 person can access the shared phonebook at a time.
- Caller ID subscribers can use group ringer tone features (page 54).
- You can copy phonebook entries from a Bluetooth cellular phone to the unit's shared phonebook (page 57).

Adding entries

- 1 [] → [ADD]
- 2 Enter the party's name (16 characters max.). → [OK]
- 3 Enter the party's phone number (24 digits max.). → [OK]
- 4 []/[]: Select the desired group. → [SELECT] 2 times
 - To add other entries, repeat from step 2.
- 5 [OFF]

Character table for entering names

While entering characters, you can switch between uppercase and lowercase by pressing [] (A→a).

Key	Character
[1]	& ' () * , - . / 1
[2]	A B C 2 a b c 2

Key	Character
[3]	D E F 3 d e f 3
[4]	G H I 4 g h i 4
[5]	J K L 5 j k l 5
[6]	M N O 6 m n o 6
[7]	P Q R S 7 p q r s 7
[8]	T U V 8 t u v 8
[9]	W X Y Z 9 w x y z 9
[0]	_ 0
[#]	#

- To enter another character that is located on the same dial key, first press [] to move the cursor to the next space.
- If you do not press any dial key within 5 seconds after entering a character, the character is fixed and the cursor moves to the next space.

Erasing the character or number

Press [] or []. → [CLEAR]

- Press and hold [CLEAR] to erase all characters or numbers.

Groups

Groups can help you find entries in the phonebook quickly and easily. When adding an entry to the phonebook, you can assign it to one of 3 groups. You can search for phonebook entries by group. The ringer ID feature is available for Caller ID subscribers (page 54).

Shared Phonebook





Finding and calling a phonebook entry

Scrolling through all entries





 **Handset** /  **Base unit***1

*1 KX-TG7641 series:page 4

■ Using a cellular line

- 1 ]
- 2 ]/]: Select the desired entry.
- 3 **[CELL]**
 - The unit starts dialing when:
 - only 1 cellular phone is registered.
 - a specific line is set to make cellular calls (page 23).
- 4 ]/]: Select the desired cellular phone. → **[SELECT]**



■ Using the landline

- 1 ]
- 2 ]/]: Select the desired entry.
- 3 Proceed with the operation for your unit.
Handset: 
Base unit: 

Searching by first character

 **Handset** /  **Base unit***1

*1 KX-TG7641 series:page 4

- 1 ]
- 2 Press the dial key (**[0]** – **[9]** or **[#]**) which contains the character you are searching for (page 35).
 - Press the same dial key repeatedly to display the first entry corresponding to each character located on that dial key.
 - If there is no entry corresponding to the character you selected, the next entry is displayed.
- 3 ]/]: Scroll through the phonebook if necessary.



- 4 To make a cellular/landline call, continue from step 3, "Scrolling through all entries", page 36.

Searching by query

You can narrow down the search to enter the first characters of a name.





 **Handset** /  **Base unit***1

*1 KX-TG7641 series:page 4

- 1 ] → **[*]**
- 2 To search for the name, enter the first characters (up to 4) in uppercase (page 35). → **[OK]**
 - Characters cannot be entered in lowercase.
 - If there is no entry corresponding to the characters you selected, the next entry is displayed.
- 3 ]/]: Scroll through the phonebook if necessary.
- 4 To make a cellular/landline call, continue from step 3, "Scrolling through all entries", page 36.

Searching by group

 **Handset**

- 1 ] → **[GROUP]**
- 2 ]/]: Select the group you want to search. → **[SELECT]**
 - If you select "A11", the unit ends the group search.
- 3 ]/]: Select the desired entry.
- 4 To make a cellular/landline call, continue from step 3, "Scrolling through all entries", page 36.

 **Base unit**

Available for:
KX-TG7641 series (page 4)

- 1 ] → **[▶▶]**

- 2 [▼]/[▲]: Select the group you want to search. → [▶]
 - If you select "All groups", the unit ends the group search.
- 3 [▼]/[▲]: Select the desired entry.
- 4 To make a cellular/landline call, continue from step 3, "Scrolling through all entries", page 36.

Editing entries

- 1 Find the desired entry (page 36). → [MENU]
- 2 [▼]/[▲]: "Edit" → [SELECT]
- 3 Edit the name if necessary (16 characters max.; page 35). → [OK]
- 4 Edit the phone number if necessary (24 digits max.). → [OK]
- 5 [▼]/[▲]: Select the desired group (page 35). → [SELECT] 2 times
- 6 [OFF]

Erasing entries

Erasing an entry

 Handset /  Base unit*1

*1 KX-TG7641 series: page 4

- 1 Find the desired entry (page 36).
- 2 [ERASE]
- 3 Proceed with the operation for your unit.
Handset: [SELECT] → [OFF]
Base unit: [▶] → [■] (EXIT)

Erasing all entries in a group

 Handset

- 1 [📖] → [MENU]
- 2 [▼]/[▲]: "Erase all" → [SELECT]
- 3 [▼]/[▲]: Select the desired group. → [SELECT]

- 4 [▼]/[▲]: "Yes" → [SELECT]
- 5 [▼]/[▲]: "Yes" → [SELECT]
- 6 [OFF]

Base unit

Available for:
KX-TG7641 series (page 4)

- 1 [📖] → [ERASE]
- 2 [▼]/[▲]: "Yes" → [▶]
- 3 [▼]/[▲]: "Yes" → [▶]
- 4 [■] (EXIT)

Chain dial

This feature allows you to dial phone numbers in the phonebook while you are on a call. This feature can be used, for example, to dial a calling card access number or bank account PIN that you have stored in the phonebook, without having to dial manually.

- 1 Proceed with the operation for your unit.
 During an outside call:
Handset: [MENU] → [▼]/[▲]: "Phonebook" → [SELECT]
Base unit: [📖]
- 2 [▼]/[▲]: Select the desired entry.
- 3 Proceed with the operation for your unit.
Handset: Press [CALL] to dial the number.
Base unit: Press [▶] to dial the number.

Note:

- When storing a calling card access number and your PIN in the phonebook as one phonebook entry, press [PAUSE] to add pauses after the number and PIN as necessary (page 26).



Shared Phonebook

- If you have rotary/pulse service, you need to press **[*]** (TONE) before pressing **[MENU]** on the handset or **[]** on the base unit in step 1 to change the dialing mode temporarily to tone. When adding entries to the phonebook, we recommend adding **[*]** (TONE) to the beginning of phone numbers you wish to chain dial (page 35).

Programmable settings

You can customize the unit by programming the following features using the handset. To access the features, there are 2 methods:



- scrolling through the display menus (page 39)
- using the direct commands (page 43)
- Direct command is the main method used in these operating instructions.

Programming by scrolling through the display menus



- 1 **[MENU]**
- 2 Press **[▼]** or **[▲]** to select the desired main menu. → **[SELECT]**
- 3 Press **[▼]** or **[▲]** to select the desired item in sub-menu 1. → **[SELECT]**
 - In some cases, you may need to select from sub-menu 2. → **[SELECT]**
- 4 Press **[▼]** or **[▲]** to select the desired setting. → **[SAVE]**
 - This step may vary depending on the feature being programmed.
 - To exit the operation, press **[OFF]**.

Note:



- See page 43 for the default settings.

Main menu	Sub-menu 1	Sub-menu 2	Page	
Caller list 	–	–	54	
Answering device 	Play new msg.	–	62	
	Play all msg.	–	62	
	Erase all msg. *1	–	63	
	Greeting	Record greeting *1		61
		Check greeting		61
		Pre-recorded *1		61
	Settings	Ring count *1		65
		Recording time *1		65
		Remote code *1		64
		Screen call		60
Answer on *1	–		60	
Answer off *1	–		60	

Programming

Main menu	Sub-menu 1	Sub-menu 2	Page
V.M. access *3 	–	–	68
Intercom 	–	–	69

Programming

Main menu	Sub-menu 1	Sub-menu 2	Page
Bluetooth 	Link to cell	1:00 Add new device *2 (for CELL 1)	20
		- Connect *1/Disconnect *1	22
		- Ringer volume (Handset/Base unit*1)	-
		- Ringer tone (Handset)	-
		- Select unit to ring *1	21
		- Ring as cell (limited) *1	21
		- Registration	20
		2:00 Add new device *2 (for CELL 2)	20
		- Connect *1/Disconnect *1	22
		- Ringer volume (Handset/Base unit*1)	-
	- Ringer tone (Handset)	-	
	- Select unit to ring *1	21	
	- Ring as cell (limited) *1	21	
	- Registration	20	
	Phonebook transfer	-	57
	Headset	Add new device	58
		Connect *1/Disconnect *1	58
Registration		58	
Settings	Auto connect *1	22	
	Cell area code *1	23	
	Cell line only mode *1	22	
	Cell line select - Handset - Base unit *1	23	
	Set PIN *1	23	
Set date & time 	Date and time *1	-	18
	Alarm	-	50
	Time adjustment *1	-	-

Programming

Main menu	Sub-menu 1	Sub-menu 2	Page
Initial setting 	Ringer setting	Ringer volume ^{*3} – Handset – Base unit ^{*1}	–
		Ringer tone ^{*3}	–
		Interrupt tone – Handset – Base unit ^{*1}	–
		Silent mode – On/Off – Start/End	50
	Set date & time	Date and time ^{*1}	18
		Alarm	50
		Time adjustment ^{*1}	–
	Talking Caller ID	Handset	53
		Base unit ^{*1}	
	Handset name	–	51
	Call block ^{*1}	–	51
	Voice mail ^{*3}	Store VM access# ^{*1}	67
		VM tone detect ^{*1}	67
	Message alert	–	66
	Display setting	LCD Contrast	–
	Key tone	–	–
	Caller ID edit	–	55
	Auto talk	–	26
	Set tel line ^{*3}	Set dial mode ^{*1}	19
		Set flash time ^{*1}	27
		Set line mode ^{*1}	–
	Privacy mode ^{*1}	–	33
	Registration	Register handset	52
	Change language	Display	18
		Voice prompt ^{*1, *3}	18

Programming

Main menu	Sub-menu 1	Sub-menu 2	Page
Customer support 	–	–	–

- *1 If you program these settings using one of the handsets, you do not need to program the same item using another handset.
- *2 After the Bluetooth device is registered, “Add new device” changes to the device name.
- *3 When the cellular line only mode is turned on, these menus are not displayed (page 22).

Programming using the direct commands

- 1 [MENU] → [#]**
- 2** Enter the desired code.
- 3** Select the desired setting. → **[SAVE]**
 - This step may vary depending on the feature being programmed.
 - To exit the operation, press **[OFF]**.

Note:

- In the following table, < > indicates the default settings.

Feature	Code	Setting	System* 1	Page
Caller list	[2] [1] [3]	–	–	54
Intercom	[2] [7] [4]	–	–	69
Date and time	[1] [0] [1]	–	●	18
Alarm	[7] [2] [0]	[1]: Once [2]: Daily [0]: <Off>	–	50
Interrupt tone*2	Handset: [2] [0] [1]	[1]: <On> [0]: Off	–	33
	Base unit: [*] [2] [0] [1]	[1]: <On> [0]: Off	●	33
Silent mode (On/Off)	[2] [3] [8]	[1]: On [0]: <Off>	–	50
Silent mode (Start/End)	[2] [3] [7]	<11:00 PM/06:00 AM>	–	50

Programming

Feature	Code	Setting	System* 1	Page
Talking Caller ID (Handset)	[1] [6] [2]	[1]: <On> [0]: Off	–	53
Talking Caller ID (Base unit)	[*] [1] [6] [2]	[1]: On [0]: <Off>	●	53
Handset name	[1] [0] [4]	–	–	51
Call block	[2] [1] [7]	–	●	51
Block w/o num (Block calls without phone number)	[2] [4] [0]	[1]: On [0]: <Off>	●	52
LCD Contrast (Display contrast)	[1] [4] [5]	[1]–[6]:Level 1–6 <3>	–	–
Key tone *3	[1] [6] [5]	[1]: <On> [0]: Off	–	–
Caller ID edit (Caller ID number auto edit)	[2] [1] [4]	[1]: <On> [0]: Off	–	55
Auto talk *4	[2] [0] [0]	[1]: On [0]: <Off>	–	26
Privacy mode	[1] [9] [4]	[1]: On [0]: <Off>	●	33
Register handset	[1] [3] [0]	–	–	52
Deregistration	[1] [3] [1]	–	–	52
Display (Change language)	[1] [1] [0]	[1]: <English> [2]: Español	–	18
Customer support *5	[6] [8] [0]	–	–	–

For Bluetooth: Link to cell

Feature	Code	Setting	System* 1	Page
Connect/ Disconnect (CELL 1)	[6] [2] [5] [1]	–	●	22
Connect/ Disconnect (CELL 2)	[6] [2] [5] [2]			

Programming

Feature	Code	Setting	System* 1	Page
Ringer volume (CELL 1)	Handset* ⁶ : [6] [2] [8] [1]	[1]–[6]: Level 1-6 <Handset: 6, Base unit: 1> [0]: Off	–	–
	Base unit* ⁷ : [*] [6] [2] [8] [1]		●	–
Ringer volume (CELL 2)	Handset* ⁶ : [6] [2] [8] [2]		–	–
	Base unit* ⁷ : [*] [6] [2] [8] [2]	●	–	
Ringer tone * ^{8, 9} (CELL 1)	Handset: [6] [2] [9] [1]	[1]–[5]: Tone –5 CELL 1: <Tone 2>CELL 2: <Tone 4> [6]–[0]: Melody 1–5	–	–
Ringer tone * ^{8, 9} (CELL 2)	Handset: [6] [2] [9] [2]		–	–
Select unit to ring (CELL 1)	[6] [2] [7] [1]	[1]–[6]: Handset 1–6 [*]: <All>	●	21
Select unit to ring (CELL 2)	[6] [2] [7] [2]			21
Ring as cell (limited) (CELL 1)	[6] [1] [4] [1]	[1]: <On (with Talking CID)> [2]: On (without Talking CID) [0]: Off	●	21
Ring as cell (limited) (CELL 2)	[6] [1] [4] [2]			21
Registration (CELL 1)	[6] [2] [4] [1]	–	–	20
Registration (CELL 2)	[6] [2] [4] [2]			
Auto connect	[6] [3] [2]	[1]: <1 min> [2]: 3 min [3]: 5 min [4]: 10 min [0]: Off	●	22
Cell area code	[6] [3] [3]	–	●	23
Cell line only mode	[1] [5] [7]	[1]: On [0]: <Off>	●	22

Programming

Feature	Code	Setting	System* 1	Page
Cell line select	Handset: [6] [3] [4]	[1]: Cellphone 1 *10 [2]: Cellphone 2 *10 [0]:<Manual>	–	23
	Base unit: [*] [6] [3] [4]	[1]: Cellphone 1 *10 [2]: Cellphone 2 *10	●	
Set PIN	[6] [1] [9]	<0000>	●	23
Deregistration	[1] [3] [4]	–	–	24

For landline

Feature	Code	Setting	System* 1	Page
V.M. access (v.m.: Voice mail)	[3] [3] [0]	–	–	68
Time adjustment *11	[2] [2] [6]	[1]: <Caller ID auto> [0]: Manual	●	–
Ringer volume *6 (Handset)	[1] [6] [0]	[1]–[6]: Level 1–6 <6> [0]: Off	–	–
Ringer volume *7 (Base unit)	[*] [1] [6] [0]	[1]–[6]: Level 1–6 <1> [0]: Off	●	–
Ringer tone (Handset)*8, *9, *12	[1] [6] [1]	[1]–[5]: Tone 1–5 <Tone 1> [6]–[0]: Melody 1–5	–	–
Store VM access# (VM: Voice mail)	[3] [3] [1]	–	●	67
VM tone detect	[3] [3] [2]	[1]: <On> [0]: Off	●	68
Set dial mode	[1] [2] [0]	[1]: Pulse [2]: <Tone>	●	19

Programming

Feature	Code	Setting	System* ¹	Page
Set flash time * ¹³	[1] [2] [1]	[0]: 900 ms [1]: <700 ms> [2]: 600 ms [3]: 400 ms [4]: 300 ms [5]: 250 ms [*]: 200 ms [#]: 160 ms [6]: 110 ms [7]: 100 ms [8]: 90 ms [9]: 80 ms	●	27
Set line mode * ¹⁴	[1] [2] [2]	[1]: A [2]: 	●	–

For Bluetooth: Using Bluetooth devices

Feature	Code	Setting	System* ¹	Page
Phonebook transfer	[6] [1] [8]	–	–	57
Registration (Headset)	[6] [2] [1]	–	–	58
Connect/Disconnect	[6] [2] [2]	–	●	58

For the answering system

Feature	Code	Setting	System* ¹	Page
Play new msg. (msg.: message)	[3] [2] [3]	–	–	62
Play all msg.	[3] [2] [4]	–	–	62
Erase all msg.	[3] [2] [5]	–	●	63
Record greeting	[3] [0] [2]	–	●	61
Check greeting	[3] [0] [3]	–	–	61
Pre-recorded (Reset to pre-recorded greeting)	[3] [0] [4]	–	●	61
Ring count	[2] [1] [1]	2–7 rings <4 rings> Toll saver	●	65
Recording time	[3] [0] [5]	1 min <3 min> Greeting only	●	65
Remote code	[3] [0] [6]	<111>	●	64
Screen call	[3] [1] [0]	<On> Off	–	60

Programming

Feature	Code	Setting	System*1	Page
Answer on	[3] [2] [7]	–	●	60
Answer off	[3] [2] [8]	–	●	60
Voice prompt (Change language)	[1] [1] [2]	[1]: <English> [2]: Español	●	18
Message alert	[3] [4] [0]	[1]: <On> [0]: Off	–	66

- *1 If "System" column is checked, you do not need to program the same item using another handset.
- *2 This tone lets you know when you receive an outside call while you are on another line or an intercom call. If you select "On", the tone sounds 2 times.
- *3 Turn this feature off if you prefer not to hear key tones while you are dialing or pressing any keys, including confirmation tones and error tones.
- *4 If you subscribe to a Caller ID service and want to view the caller's information after lifting up the handset to answer a call, turn off this feature.
- *5 The handset can display the Internet address where you can download the operating instructions or get further information for this product, using your computer.
- *6 When the ringer volume is turned off on the handset, μ is displayed followed by the line indication (1, 2: cellular line, L: landline). If all line ringer volumes are turned off, " μ " is displayed without the line indications. The handset does not ring for outside calls. However even when the ringer volume is set to off, the handset still rings for alarm (page 50), intercom calls, and paging (page 69).
- *7 Even when the ringer volume is set to off, the base unit still rings for intercom calls.
- *8 If you select one of the melody ringer tones, the ringer tone continues to play for several seconds even if the caller has already hung up. You may either hear a dial tone or no one on the line when you answer the call.
- *9 The preset melodies in this product are used with permission of © 2009 Copyrights Vision Inc.
- *10 After the Bluetooth device is registered, the device name is displayed.
- *11 This feature allows the unit to automatically adjust the date and time each time caller information including date and time is received.
To turn this feature on, select "Caller ID auto". To turn this feature off, select "Manual". (Caller ID subscribers only)
To use this feature, set the date and time first (page 18).
- *12 If you subscribe to a distinctive ring service (such as IDENTA-RING), select a tone (tone 1 to 5). If you select a melody, you cannot distinguish lines by their ringers.
- *13 The flash time depends on your telephone exchange or host PBX. Contact your PBX supplier if necessary. The setting should stay at "700 ms" unless pressing **[FLASH]** fails to pick up the waiting call.
- *14 Generally, the line mode setting should not be changed. This setting automatically maintains receiver volume at the proper level depending on the

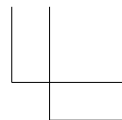
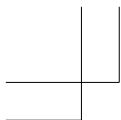

Programming

current telephone line condition. Set the line mode to “A” if telephone line condition is not good.

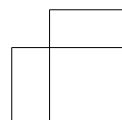
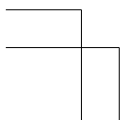

Programming

Special programming

Alarm

An alarm sounds at the set time for 3 minutes once or daily. Alarm can be set for each handset.

Important:

- Set the date and time beforehand (page 18).
- 1 **[MENU]** → **[#] [7] [2] [0]**
 - 2 **[▼]/[▲]**: Select the desired alarm option. → **[SELECT]**

Off	Turns alarm off. Go to step 7.
Once	An alarm sounds once at the set time.
Daily	An alarm sounds daily at the set time. Go to step 4.

- 3 Enter the desired month and date.
→ **[OK]**
- 4 Set the desired time.
- 5 **[AM/PM]**: Select “AM” or “PM”. → **[OK]**
- 6 **[▼]/[▲]**: Select the desired alarm tone. → **[SELECT]**
 - We recommend selecting a different ringer tone from the one used for outside calls.
- 7 **[SELECT]** → **[OFF]**
 - When the alarm is set, ☎ is displayed.

Note:

- To stop the alarm, press any dial key or place the handset on the base unit or charger.
- When the handset is in use, the alarm will not sound until the handset is in standby mode.

Silent mode

Silent mode allows you to select a period of time during which the handset will not ring for outside calls. This feature is useful for time periods when you do not want to be disturbed, for example, while sleeping. Silent mode can be set for each handset.

Important:

- Set the date and time beforehand (page 18).
- We recommend turning the base unit ringer off (page 45, 46) in addition to turning the silent mode on.
- If you have set the alarm, the alarm sounds even if the silent mode is turned on.

Turning silent mode on/off

- 1 **[MENU]** → **[#] [2] [3] [8]**
- 2 **[▼]/[▲]**: Select “on” or “off”. → **[SAVE]**
 - If you select “off”, press **[OFF]** to exit.
- 3 Enter the desired hour and minute you wish to start this feature.
- 4 **[AM/PM]**: Select “AM” or “PM”. → **[OK]**
- 5 Enter the desired hour and minute you wish to end this feature.
- 6 **[AM/PM]**: Select “AM” or “PM”.
- 7 **[SAVE]** → **[OFF]**
 - When the silent mode is set, **ZzZ** is displayed.

Note:

- To correct a digit, press **[◀]** or **[▶]** to move the cursor to the digit, then make the correction.

Changing the start and end time

- 1 **[MENU]** → **[#] [2] [3] [7]**

- Continue from step 3, "Turning silent mode on/off", page 50.

Changing the handset name

Each handset can be given a customized name ("Bob", "Kitchen", etc.). This is useful when you make intercom calls between handsets. You can also select whether or not the handset name is displayed in standby mode. The default setting is "OFF". If you select "On" without entering any handset name, "Handset 1" to "Handset 6" is displayed.

- [MENU]** → **[#] [1] [0] [4]**
- Enter the desired name (max. 10 characters; see the character table, page 35).
 - If not required, go to step 3.
- [SAVE]**
- [▼]/[▲]**: Select the desired setting. → **[SELECT]**
- [SELECT]** → **[OFF]**

Call block (Caller ID subscribers only)

This feature allows the unit to reject calls when:

- the unit receives a call from a phone number stored in the call block list as unwanted ("Storing unwanted callers", page 51).
- the unit receives a call without phone number ("Block calls without phone number", page 52).

When a call is received, the unit rings for a short time while the caller is being identified. If the phone number matches an entry in the call block list:

- cellular calls are rejected.
- landline calls are disconnected after the unit first sends out a busy tone to the caller.

Important:

- When the unit receives a call from a number that is stored in the call block list or a call without a recognized phone number, the call is logged in the caller list (page 54) with **[▼]** after the call is disconnected.

Storing unwanted callers

You can store up to 30 phone numbers in the call block list by using the caller list or by entering the numbers directly.

Important:

- We recommend storing 10 digits (including an area code). If only 7 digits are stored, all numbers that have the same last 7 digits will be blocked.

■ From the caller list:

- [←]CID**
- [▼]/[▲]**: Select the entry to be blocked.
 - To edit the number, press **[SELECT]**, then press **[EDIT]** repeatedly until the phone number is shown in the 10-digit format.
- [SAVE]**

- [▼]/[▲]**: "Call block" → **[SELECT]**
- [▼]/[▲]**: "Yes" → **[SELECT]**
- Edit the phone number if necessary (24 digits max.).
- [SAVE]** → **[OFF]**

■ By entering phone numbers:

- [MENU]** → **[#] [2] [1] [7]** → **[ADD]**
- Enter the phone number (24 digits max.).
 - To erase a digit, press **[CLEAR]**.
- [SAVE]** → **[OFF]**

Programming

Block calls without phone number

You can reject a call without phone number including "Out of area", "Private caller", or "Long distance".

- 1 **[MENU]** → **[#] [2] [4] [0]**
- 2 **[▼]/[▲]**: Select the desired setting.
→ **[SAVE]** → **[OFF]**

Viewing/editing/erasing call block numbers

- 1 **[MENU]** → **[#] [2] [1] [7]**
- 2 **[▼]/[▲]**: Select the desired entry.
 - To exit, press **[OFF]**.
- 3 **To edit a number:**
[EDIT] → Edit the phone number.
→ **[SAVE]** → **[OFF]**
To erase a number:
[ERASE] → **[▼]/[▲]**: "Yes" →
[SELECT] → **[OFF]**

Note:

- When editing, press the desired dial key to add, **[CLEAR]** to erase.
- When viewing, "Block w/o num" is displayed if the block calls without phone number feature is turned on.
To turn the feature off: **[ERASE]** → **[▼]** → **[SAVE]** → **[OFF]**

Registering a unit

Operating additional units

Additional handsets

Up to 6 handsets can be registered to the base unit.

Important:

- See page 6 for information on the available model.

Registering a handset to the base unit

The supplied handset and base unit are pre-registered. If for some reason the handset is not registered to the base unit, re-register the handset.

- 1 **Handset:**
[MENU] → **[#] [1] [3] [0]**
- 2 **Base unit:**
Press and hold **[LOCATOR]** for about 5 seconds until the registration tone sounds.
 - If all registered handsets start ringing, press the same button to stop. Then repeat this step.
 - The next step must be completed within 90 seconds.
- 3 **Handset:**
Press **[OK]**, then wait until a long beep sounds.

Note:

- While registering, "Base in registering" is displayed on all registered handsets.
- When you purchase an additional handset, refer to the additional handset's installation manual for registration.

Deregistering a handset

A handset can cancel its own registration (or the registration of another handset) that is stored to the base unit. This allows the handset to end its wireless connection with the system.

- 1 **[MENU]** → **[#] [1] [3] [1]**
 - All handsets registered to the base unit are displayed.
- 2 **[▼]/[▲]**: Select the handset you want to cancel. → **[SELECT]**
- 3 **[▼]/[▲]**: "Yes" → **[SELECT]**
- 4 **[OFF]**

Using Caller ID service

Important:

- This unit is Caller ID compatible. To use Caller ID features, you must subscribe to a Caller ID service. Contact your service provider/ telephone company for details.

Caller ID features

When an outside call is being received, the caller's name and phone number are displayed.

Caller information for the last 50 callers is logged in the caller list from the most recent call to the oldest.

- If the unit cannot receive caller information, the following is displayed:
 - “**Out of area**”: The caller dials from an area which does not provide a Caller ID service.
 - “**Private caller**”: The caller requests not to send caller information.
 - “**Long distance**”: The caller makes a long distance call.
- If the unit is connected to a PBX system, caller information may not be properly received. Contact your PBX supplier.

Missed calls

 **Handset** /  **Base unit***1

*1 KX-TG7641 series:page 4

If a call is not answered, the unit treats it as a missed call. The display shows “**Missed call**”. This lets you know if you should view the caller list to see who called while you were away.

Note:

- Even when there are unviewed missed calls, “**Missed call**” disappears from the standby display if

the following operation is performed by one of the registered units:

- A handset is replaced on the base unit or charger.
- Pressing [**OFF**] on a handset.
- Pressing [**■**] (EXIT) on the base unit.

Phonebook name display

When caller information is received and it matches a phone number stored in the phonebook, the stored name in the phonebook is displayed and logged in the caller list.

Talking Caller ID

This feature lets you know who is calling without looking at the display.

To use this feature, you must:

- subscribe to a Caller ID service of your service provider/telephone company.
- turn this feature on (page 44).

When caller information is received, the handsets and base unit announce the caller's name or phone number received from your service provider/telephone company following every ring.

The unit announces in English only.

- Name pronunciation may vary. This feature may not pronounce all names correctly.
- Caller ID service has a limit of how many characters can be displayed. If the caller's name is too long, the handset may not be able to display or announce the entire name.
- The announcement is heard at the same level as the ringer volume (page 45, 46).
- If you turn on the answering system and set the number of rings “**2 rings**” (page 65), the unit does not announce the caller information from the landline. If “**Toll saver**” is selected and there is a new message,

Caller ID Service

the unit does not announce the caller information from the landline.

- When you receive a call while on the phone, the 2nd caller's name is not announced even if you subscribe to both Caller ID and Call Waiting with Caller ID services.







Phonebook name announcement

When caller information is received and it matches a phone number stored in the phonebook, the stored name in the phonebook is announced.

Ringer ID

You can select the desired ringer tone to a group that each phonebook entry is assigned (page 35). When a call is received from a caller assigned to a group, the ringer tone you selected for that group rings instead of the called line's ringer tone (page 21, 45, 46) after caller information is displayed.

If you select "Current ringer" (default), the unit uses the called line's ringer tone when calls from this group are received.

- 1 [] → [MENU]
- 2 []/[]: "Group" → [SELECT]
- 3 []/[]: Select the desired group. → [SELECT]
- 4 []/[]: Select the desired ringer tone. → [SAVE]
- 5 [OFF]

Caller list

Important:







- Only 1 person can access the caller list at a time.
- Make sure the unit's date and time setting is correct (page 18).

Viewing the caller list and calling back





 Handset /  Base unit*1

*1 KX-TG7641 series:page 4

■ Using a cellular line



- 1 Proceed with the operation for your unit.
Handset: [] CID
Base unit: [] CID
- 2 Press [] to search from the most recent call, or [] to search from the oldest call.
- 3 To call back, press [SELECT].
To exit, press [OFF].
- 4 [CELL]
 - The unit starts dialing when:
 - only 1 cellular phone is registered.
 - a specific line is set to make cellular calls (page 23).
- 5 []/[]: Select the desired cellular phone. → [SELECT]

■ Using the landline

- 1 Proceed with the operation for your unit.
Handset: [] CID
Base unit: [] CID
- 2 Press [] to search from the most recent call, or [] to search from the oldest call.
- 3 Proceed with the operation for your unit.
Handset:
 - To call back, press [].

- To exit, press **[OFF]**.
- Base unit:**
- To call back, press **[𐀀]**.
- To exit, press **[■]** (EXIT).

Note:

- If the entry has already been viewed or answered, “✓” is displayed, even if it was viewed or answered using another handset.
- In step 2, if ▶ is displayed, not all of the information is shown. To see the remaining information:
Handset:
 Press **[▶]**. To return to the previous screen, press **[◀]**.
Base unit:
 Press **[▶▶]**. To return to the previous screen, press **[◀◀]**.
-  or  indicates the caller information was received from the cellular line.

Editing a caller's phone number before calling back

You can edit a phone number in the caller list by removing its area code and/or the long distance code “1”.

 Handset /  Base unit*1

*1 KX-TG7641 series:page 4

- 1 Proceed with the operation for your unit.
Handset: **[◀]** CID
Base unit: **[◀◀]** CID
- 2 **[▼]/[▲]**: Select the desired entry.
- 3 Press **[SELECT]**, then press **[EDIT]** repeatedly until the phone

number is shown in the desired format.

- ① Local phone number
Example: 321-5555
- ② Area code – Local phone number
Example: 555-321-5555
- ③ 1 – Area code – Local phone number
Example: 1-555-321-5555

4 Using a cellular line:

To make a cellular call, continue from step 4, “Viewing the caller list and calling back”, page 54.

Using the landline:

Proceed with the operation for your unit.

Handset: **[𐀀]**

Base unit: **[𐀀]**

Caller ID number auto edit feature

 Handset /  Base unit*1

*1 KX-TG7641 series:page 4

Once you call back an edited number, the unit which was used to call back remembers the area code and format of the edited number. The next time someone calls from the same area code, caller information is customized by the unit as follows:

- When the call is being received, the Caller ID number is displayed in the same format as the edited number.
- After the call has ended, the caller's phone number is displayed in the same format as the edited number, when reviewed from the caller list.

For example, you can use this feature to set the unit to ignore the area code of callers in your area, so that you can call these local numbers using caller information without dialing the area code.

Caller ID Service

To activate this feature, you must edit an entry in the caller list, then call that number. After that, phone numbers from that caller's area code are edited automatically.

This feature can be set for each unit (page 44). The default setting is "On".

Note:

- Phone numbers from the 4 most recently edited area codes are automatically edited.
- If you move to another area, you can turn this feature off to erase previously edited area codes. To use this feature again, turn it on and reprogram the area codes you want to edit once again.

Erasing selected caller information

Handset / Base unit*1

*1 KX-TG7641 series:page 4

- 1 Proceed with the operation for your unit.

Handset: [◀] CID

Base unit: [⏪] CID

- 2 [▼]/[▲]: Select the desired entry.
- 3 [ERASE] → [▼]/[▲]: "Yes"
- 4 Proceed with the operation for your unit.
Handset: [SELECT] → [OFF]
Base unit: [▶] → [■] (EXIT)

Erasing all caller information

Handset

- 1 [◀] CID
- 2 [ERASE] → [▼]/[▲]: "Yes" → [SELECT] → [OFF]

Storing caller information to the phonebook

Handset

- 1 [◀] CID
- 2 [▼]/[▲]: Select the desired entry.
 - To edit the number, press [SELECT], then press [EDIT] repeatedly until the phone number is shown in the desired format.
- 3 [SAVE]
- 4 [▼]/[▲]: "Phonebook" → [SELECT]
- 5 Continue from step 3, "Editing entries", page 37.

Base unit

Available for:

KX-TG7641 series (page 4)

- 1 [⏪] CID
- 2 [▼]/[▲]: Select the desired entry.
 - To edit the number, press [EDIT] repeatedly until the phone number is shown in the desired format (page 55).
- 3 [📖] → [▼]/[▲]: "Yes" → [▶]
- 4 [■] (EXIT)

Note:

- If you stored caller information to the phonebook using the base unit, the entry is automatically assigned to group 1.

Copying phonebook from a cellular phone (phonebook transfer)

You can copy phonebook entries from the registered cellular phones or other cellular phones (not registered) to the unit's shared phonebook. A cellular phone must be Bluetooth wireless technology compatible.

Important:

- If a copied entry has 2 or more phone numbers, each phone number (6 max.) is stored as a separate entry with the same name.
- If a phonebook entry includes additional data such as a picture, that entry may fail to copy to the base unit.

1 Handset:

[MENU] → [#] [6] [1] [8]

- 2 [▼]/[▲]: Select the desired group to copy phonebook entries. → [SELECT]

3 For registered cellular phones:

[▼]/[▲]: Select the cellular phone. → [SELECT]

For other cellular phones (not registered):

[▼]/[▲]: "Other cell" → [SELECT]

4 When "Transfer phonebook from cell." is displayed:

Go to step 5.

When "Select mode" menu is displayed:

[▼]/[▲]: Select "Auto" or "Manual". → [SELECT]

"Auto": Download all entries from the cellular phone automatically. Go to step 6.

"Manual": Copy entries you selected.

- "Select mode" menu is displayed only when the cellular phone supports PBAP (Phone Book Access Profile) for Bluetooth connection.

5 Cellular phone:

Follow the instructions of your cellular phone to copy phonebook entries.

- For other cellular phones (not registered), you need to search for and select the base unit. The base unit's PIN (default: "0000") may be required.
- The entries being copied are displayed on the handset.

6 Handset:

Wait until "Completed" is displayed.

- You can continue copying other entries if necessary.

7 Handset: [OFF]

Note:

- Some copied entries may have characters which do not exist in the character table (page 35). These characters can be displayed but cannot be entered when editing an entry.
- The unit does not support some characters. If a copied entry includes those characters, they are replaced with other available characters or "*".

Using Bluetooth Devices

Using a Bluetooth wireless headset (optional) for landline calls

By registering a Bluetooth headset to the base unit, you can have a hands-free conversation wirelessly for landline calls.

Important:

- 1 headset can be registered to the base unit. However, only one Bluetooth device (cellular phone or headset) can be connected to the base unit at a time.
- For best performance, we recommend using a Bluetooth headset within 1 m (3.3 feet) of the base unit. A headset can communicate with the base unit within a range of approximately 10 m (33 feet).

Registering a headset

Important:

- Make sure that the Bluetooth headset is not connected to any other Bluetooth device.

- 1 Your headset:**
Set your headset to registration mode.
 - Refer to the headset operating instructions.
- 2 Handset:**
[MENU] → [#] [6] [2] [1]
- 3 Enter your headset PIN.**
 - Typically, default PIN is "0000".
Refer to the headset operating instructions.
- 4 Press [OK], then wait until a long beep sounds.**

5 [OFF]

- When the HEADSET indicator on the base unit lights green, you are ready to use the headset.

Connecting/disconnecting a headset

If you cannot connect the headset and base unit using the headset, you can connect using the unit.

To use your headset with another Bluetooth device such as a cellular phone, you may need to disconnect it from the base unit.

Important:

- Make sure that the headset is turned on.

Base unit

To connect: [HEADSET]

To disconnect:

Press and hold [HEADSET] until a long beep sounds.

Handset

- 1 To connect/disconnect:**
[MENU] → [#] [6] [2] [2]
 - A long beep sounds.

2 [OFF]

Deregistering a headset

You can cancel a registration of the headset that is stored to the base unit. See "Deregistering Bluetooth devices", page 24.

Operating a Bluetooth wireless headset using the landline

Important:

- For headset operations, refer to your headset operating instructions.

Making landline calls

- 1 [] → Dial the phone number.
- 2 Press [HEADSET] or operate the call with the headset referring to your headset operating instructions.

Answering landline calls

To answer a landline call, refer to your headset operating instructions.

Switching between the headset and base unit speakerphone

You can switch between the base unit speakerphone and headset:

- during a landline call or an intercom call.
- while listening to messages recorded on the base unit answering system.

To switch to the headset, press

[HEADSET].

To switch to the base unit speakerphone, press [].

Adjusting the headset receiver volume on the base unit

Press [▲] or [▼] repeatedly while using the headset.

Answering system for landline

The answering system can answer and record calls for you when you are unavailable to answer the phone. You can also set the unit to play a greeting message but not to record caller messages by selecting “Greeting only” as the recording time setting (page 65).

Important:

- Only 1 person can access the answering system (listen to messages, record a greeting message, etc.) at a time.
- When callers leave messages, the unit records the day and time of each message. Make sure the date and time have been set correctly (page 18).
- When the cellular line only mode is set (page 22), the answering system cannot be used and any messages are not received. You can record voice memo messages (page 63).

Memory capacity (including your greeting message)

The total recording capacity is about 18 minutes. A maximum of 64 messages can be recorded.

Note:

- When message memory becomes full:
 - “Messages full” is shown on the handset and base unit*1 display.
 - The ANSWER ON/OFF indicator on the base unit flashes rapidly if the answering system is turned on.
 - the message counter on the baseunit flashes.
(KX-TG7621series: page 4)

- If you use the pre-recorded greeting message, the unit automatically switches to another pre-recorded greeting message asking callers to call again later.
- If you recorded your own greeting message, the same message is still announced to callers even though their messages are not recorded.

*1 KX-TG7641 series: page 4

Turning the answering system on/off

Base unit

Press[ANSWER ON/OFF]to turn on/off the answering system.

Handset

- 1 To turn on:
[MENU] → [#] [3] [2] [7]
To turn off:
[MENU] → [#] [3] [2] [8]
- 2 [OFF]

Note for base unit and handset:

- When the answering system is turned on:
 - The ANSWER ON/OFF indicator on the base unit lights up.
 - The message counter on the base unit displays the total number of messages (old and new).
(KX-TG7621 series: page 4)

Call screening

While a caller is leaving a message, you can listen to the call through the unit speaker.

Handset

To adjust the speaker volume, press[▲]or[▼]repeatedly. You can answer the call by pressing[]. Call

Answering System for Landline

screening can be set for each handset. The default setting is “on”.

- 1 **[MENU]** → **[#] [3] [1] [0]**
- 2 **[▼] [▲]**: Select the desired setting.
→ **[SAVE]** → **[OFF]**

Base unit

To adjust the speaker volume, press **[▲]** or **[▼]** repeatedly. You can answer the call by pressing **[📞]**.

To turn off while screening a call, press **[▼]** repeatedly until the sounds goes off.

Note:

- If you adjust the speaker volume while listening to messages or talking on the intercom, the speaker volume for call screening is turned on again.

Greeting message

When the unit answers a call, a greeting message is played to callers.

You can use either:

- your own greeting message
- a pre-recorded greeting message

Recording your greeting message

- 1 **[MENU]** → **[#] [3] [0] [2]**
- 2 **[▼] [▲]**: “Yes” → **[SELECT]**
- 3 After a beep sounds, hold the handset about 20 cm (8 inches) away and speak clearly into the microphone (2 minutes max.).
- 4 Press **[STOP]** to stop recording.
- 5 **[OFF]**

Using a pre-recorded greeting message

The unit provides 2 pre-recorded greeting messages:

- If you erase or do not record your own greeting message, the unit plays a pre-recorded greeting asking callers to leave a message.
- If the message recording time (page 65) is set to “**Greeting only**”, callers’ messages are not recorded and the unit plays a different pre-recorded greeting message asking callers to call again.

Resetting to a pre-recorded greeting message

If you want to use a pre-recorded greeting message once you record your own greeting message, you need to erase your own greeting message.

- 1 **[MENU]** → **[#] [3] [0] [4]**
- 2 **[YES]** → **[OFF]**

Playing back the greeting message

- 1 **[MENU]** → **[#] [3] [0] [3]**
- 2 **[OFF]**

Listening to messages using the base unit

When new messages have been recorded:

- the message indicator on the base unit flashes.
- “**New message**” is displayed.*1

*1 KX-TG7641 series:page 4

Press **[▶]**.

- If new messages have been recorded, the base unit plays back new messages.
- If there are no new messages, the base unit plays back all messages.

Answering System for Landline

Operating the answering system during playback

Key	Operation
[+] or [-]*1	Adjust the speaker volume
[▲] or [▼]*2	Adjust the speaker volume
[◀◀]	Repeat message*3
[▶▶]	Skip message
[■] (STOP)	Stop playback
[ERASE]	Erase currently playing message

*1 KX-TG7621 series: page 4

*2 KX-TG7641 series:page 4

*3 If pressed within the first 5 seconds of a message, the previous message is played.

Calling back (Caller ID subscribers only)

Available for:
KX-TG7641 series (page 4)

If caller information was received for the call, you can call the caller back while listening to a message.

Press [☎] during playback.

- To edit the number before calling back, press [EDIT] repeatedly until the phone number is shown in the desired format (page 55).

Erasing all messages

Press [ERASE] 2 times while the unit is not in use.

Listening to messages using the handset

When new messages have been recorded:

- “New message” is displayed.
- The message indicator on the handset flashes slowly if the message alert feature is turned on (page 66).

1 To listen to new messages: [PLAY]

or

[MENU] → [#] [3] [2] [3]

To listen to all messages:

[MENU] → [#] [3] [2] [4]

2 When finished, press [OFF].

Note:

- To switch to the receiver, press [↶].

Operating the answering system

[MENU] → [▼]/[▲]: “Answering device” → [SELECT]

Key	Operation
[▲] or [▼]	Adjust the receiver/speaker volume (during playback)
[1] or [◀]	Repeat message (during playback)*1
[2] or [▶]	Skip message (during playback)
[3]	Enter the “Settings” menu
[4]	Play new messages
[5]	Play all messages
[6]	Play greeting message
[7] [6]	Record greeting message

Answering System for Landline

Key	Operation
[8]	Turn answering system on
[PAUSE]	Pause message*2
[9] or [STOP]	Stop recording Stop playback
[0]	Turn answering system off
[*] [4] *3	Erase currently playing message
[*] [5]	Erase all messages
[*] [6]	Reset to a pre-recorded greeting message

*1 If pressed within the first 5 seconds of a message, the previous message is played.

*2 To resume playback:
[▼]/[▲]: "Playback" →
[SELECT]

*3 You can also erase as follows:
[ERASE] → [▼]/[▲]: "Yes" →
[SELECT]

Calling back (Caller ID subscribers only)

If caller information is received for the call, you can call the caller back while listening to a message.

- 1 Press [PAUSE] during playback.
- 2 [▼]/[▲]: "Call back" →
[SELECT]

Editing the number before calling back

- 1 Press [PAUSE] during playback.
- 2 [▼]/[▲]: "Edit & Call" →
[SELECT]

- 3 Press [EDIT] repeatedly until the phone number is shown in the desired format (page 55). → [↶]
 - To call back using a cellular line, continue from step 2, "Making cellular calls", page 25.

Erasing all messages

- 1 [MENU] → [#] [3] [2] [5]
- 2 [▼]/[▲]: "Yes" → [SELECT] → [OFF]

Voice memo

Available for:
KX-TG7641 series (page 4)

Recording a voice memo

You can use the base unit to leave a voice memo (voice message) for yourself or someone else (3 minutes max.). Voice memos can be played back later with the same operation used to play back answering system messages.

- 1 [MEMO]
- 2 After the unit beeps, speak clearly about 20 cm (8 inches) away from the microphone.
- 3 To stop recording, press [■] (STOP).

Remote operation

Using a touch-tone phone, you can call your phone number from outside and access the unit to listen to messages or change answering system settings. The unit's voice guidance prompts you to press certain dial keys to perform different operations.

Answering System for Landline

Remote access code

A 3-digit remote access code must be entered when operating the answering system remotely. This code prevents unauthorized parties from listening to your messages remotely. The default setting is "111".

Important:

- To prevent unauthorized access to this product, we recommend that you regularly change the remote code.

- 1 **[MENU]** → **[#]** **[3]** **[0]** **[6]**
- 2 Enter the desired 3-digit remote access code.
- 3 **[SAVE]** → **[OFF]**

Deactivating remote operation

Press **[*]** in step 2 on "Remote access code", page 64.

- The entered remote access code is deleted.

Using the answering system remotely

- 1 Dial your landline phone number from a touch-tone phone.
- 2 After the greeting message starts, enter your remote access code.
- 3 Follow the voice guidance prompts as necessary or control the unit using remote commands (page 64).
- 4 When finished, hang up.

Voice guidance

■ When the English voice guidance is selected

During remote operation, the unit's voice guidance starts and prompts you to press **[1]** to perform a specific operation, or press **[2]** to listen to more available operations.

■ When the Spanish voice guidance is selected

To start the voice guidance, press **[9]**. The voice guidance announces the available remote commands (page 64).

Note:

- If you do not press any dial keys within 10 seconds after a voice guidance prompt, the unit disconnects your call.

Remote commands

You can press dial keys to access certain answering system functions without waiting for the voice guidance to prompt you.

Key	Operation
[1]	Repeat message (during playback)*1
[2]	Skip message (during playback)
[4]	Play new messages
[5]	Play all messages
[9]	Stop playback*2 Start voice guidance*3
[0]	Turn answering system off
[*] [4]	Erase currently playing message
[*] [5]	Erase all messages
[*] [#]	End remote operation (or hang up)

*1 If pressed within the first 5 seconds of a message, the previous message is played.

*2 For English voice guidance only

*3 For Spanish voice guidance only

Turning on the answering system remotely

If the answering system is off, you can turn it on remotely.

- 1 Dial your phone number from a touch-tone phone.
- 2 Let the phone ring 15 times.
 - A long beep is heard.
- 3 Enter your remote access code within 10 seconds after the long beep.
 - The greeting message is played back.
 - You can either hang up, or enter your remote access code again and begin remote operation (page 63).

Answering system settings

Number of rings before the unit answers a call

You can change the number of times the phone rings “**Ring count**” before the unit answers calls. You can select 2 to 7 rings, or “**Toll saver**”.

The default setting is “**4 rings**”.

“**Toll saver**”: The unit’s answering system answers at the end of the 2nd ring when new messages have been recorded, or at the end of the 5th ring when there are no new messages. If you call your phone from outside to listen to new messages (page 63), you know that there are no new messages when the phone rings for the 3rd time. You can then hang up without being charged for the call.

- 1 **[MENU]** → **[#]** **[2]** **[1]** **[1]**
- 2 **[▼]**/**[▲]**: Select the desired setting.
→ **[SAVE]** → **[OFF]**

For voice mail service subscribers

If you subscribe to a flat-rate service package that includes Caller ID, call waiting, voice mail, and unlimited local/regional/long distance calls, please note the following:

- To use the voice mail service provided by your service provider/telephone company rather than the unit’s answering system, turn off the answering system (page 60).
- To use this unit’s answering system rather than the voice mail service provided by your service provider/telephone company, please contact your service provider/telephone company to deactivate your voice mail service.

If your service provider/telephone company cannot do this:

- Set this unit’s “**Ring count**” setting so that this unit’s answering system answers calls before the voice mail service of your service provider/telephone company does. It is necessary to check the number of rings required to activate the voice mail service provided by your service provider/telephone company before changing this setting.
- Change the number of rings of the voice mail service so that the answering system can answer the call first. To do so, contact your service provider/telephone company.

Caller’s recording time

You can change the maximum message recording time allowed for each caller.

The default setting is “**3 min**”.

- 1 **[MENU]** → **[#]** **[3]** **[0]** **[5]**
- 2 **[▼]**/**[▲]**: Select the desired setting.
→ **[SAVE]** → **[OFF]**

Answering System for Landline

Selecting “Greeting only”

You can select “Greeting only” which sets the unit to announce a greeting message to callers but not record messages.

Select “Greeting only” in step 2 on “Caller’s recording time”, page 65.

Note:

- When you select “Greeting only”:
 - If you do not record your own message, the unit will play the pre-recorded greeting-only message asking callers to call again later.
 - If you use your own message, record the greeting-only message asking callers to call again later (page 61).

Message alert

You can select whether or not the message indicator on the handset flashes slowly when new messages are recorded. The default setting is “On”.

Important:

- If you stored the voice mail access number (page 67), the message indicator also flashes for newly recorded voice mail messages from the landline (page 68).

- 1 [MENU] → [#] [3] [4] [0]
- 2 [▼]/[▲]: Select the desired setting.
→ [SAVE] → [OFF]

Note:

- While message alert is on, battery operating time is shortened (page 13).

Voice Mail Service for Landline

Voice mail service for landline

Voice mail is an automatic answering service offered by your service provider/telephone company. After you subscribe to this service, your service provider/telephone company's voice mail system answers calls for you when you are unavailable to answer the phone or when your line is busy. Messages are recorded by your service provider/telephone company, not your telephone. Please contact your service provider/telephone company for details of this service.

Important:

- To use the voice mail service provided by your service provider/telephone company rather than the unit's answering system, turn off the answering system (page 60). For details, see page 65.
- You need to store the voice mail access number to activate the message alert feature (page 66) for voice mail service.

Storing the voice mail (VM) access number

In order to listen to your voice mail messages, you must dial your service provider/telephone company's voice mail access number. Once you have stored your voice mail access number, you can dial it automatically (page 68).

- 1** [MENU] → [#] [3] [3] [1]
- 2** Enter your access number (24 digits max.). → [SAVE] → [OFF]

Note:

- When storing your voice mail access number and your mailbox password, press [PAUSE] to add pauses

(page 26) between the access number and the password as necessary. Contact your service provider/telephone company for the required pause time.

Example:

1-222-333-4444	PPPP	8888
VM access number	Pauses	Password

To erase the voice mail access number

- 1** [MENU] → [#] [3] [3] [1]
- 2** Press and hold [CLEAR] until all digits are erased. → [SAVE] → [OFF]

Voice mail (VM) tone detection

Your service provider/telephone company sends special signals (sometimes called "voice mail tones" or "stutter tones") to the unit to let you know you have new voice mail messages. If you hear a series of dial tones followed by a continuous dial tone after you press [], you have new voice mail messages. Soon after you hang up a call or after the phone stops ringing, your unit checks the phone line to see if new voice mail messages have been recorded.

Turn this feature off when:

- You do not subscribe to voice mail service.
 - Your service provider/telephone company does not send voice mail tones.
 - Your phone is connected to a PBX.
- If you are not sure which setting is required, contact your service provider/telephone company.

Voice Mail Service for Landline

Turning VM tone detection on/off

The default setting is "on".

- 1 **[MENU]** → **[#] [3] [3] [2]**
- 2 **[▼]/[▲]**: Select the desired setting.
→ **[SAVE]** → **[OFF]**

Listening to voice mail messages

The unit lets you know that you have new voice mail messages in the following ways:

- "New Voice Mail" is displayed on the handset and base unit*1 if message indication service is available.
- The message indicator on the handset flashes slowly if the message alert feature is turned on (page 66).

*1 KX-TG7641 series: page 4

- 1 **[MENU]** → **[#] [3] [3] [0]**
 - The speakerphone turns on.
- 2 Follow the pre-recorded instructions.
- 3 When finished, press **[OFF]**.

Note:

- If the handset and base unit*1 still indicates there are new messages even after you have listened to all new messages, turn it off by pressing and holding **[#]** until the handset or base unit*1 beeps.
- If your voice mail service uses voice mail tones and a message is over 3 minutes long, the handset may not indicate new messages.
- If your voice mail service uses voice mail tones, the tones are heard from any phone connected to the same line. If you want to use another phone to listen to voice mail messages, you have to dial your access number manually.



*1 KX-TG7641 series: page 4

Intercom

Intercom calls can be made:

- between handsets
- between the handset and base unit (KX-TG7641 series: page 4)

Note:

- If you receive an outside call while talking on the intercom, you hear 2 tones.
 - To answer the call with the handset, press **[OFF]**, then press [].
 - To answer the call with the base unit, press [] 2 times.
- When paging unit(s), the paged unit(s) beeps for 1 minute.

Making an intercom call

Handset

- 1 **[MENU]** → **[INT]**
- 2 **[▼]/[▲]**: Select the desired unit. → **[SELECT]**
 - To stop paging, press **[OFF]**.
- 3 When you finish talking, press **[OFF]**.

Base unit

Available for:
KX-TG7641 series (page 4)

- 1 Press **[INTERCOM]**.
When 2 or more handsets are registered:
 - To page a specific handset, enter the handset number.
 - To page all handsets, press **[0]** or wait for a few seconds.
 - To stop paging, press **[INTERCOM]**.
- 2 When you finish talking, press **[INTERCOM]**.

Answering an intercom call

Handset

- 1 Press [] to answer the page.
- 2 When you finish talking, press **[OFF]**.

Base unit

Available for:
KX-TG7641 series (page 4)

- 1 Press **[INTERCOM]** to answer the page.
- 2 When you finish talking, press **[INTERCOM]**.

Handset locator

You can locate a misplaced handset by paging it.

- 1 **Base unit: [LOCATOR]**
 - All registered handsets beep for 1 minute.
- 2 To stop paging:
Base unit: [LOCATOR]
Handset:
 - (KX-TG7621 series page 4)
Press **[OFF]**
 - (KX-TG7641 series page 4)
Press [], then press **[OFF]**.

Transferring calls, Conference calls

Outside calls can be transferred or a conference call with an outside party can be made:

- between 2 handsets
- between the handset and base unit (KX-TG7641 series: page 4)

Intercom/Locator

Handset

- 1 During an outside call, press[**INT**]to put the call on hold.
- 2 [**▼**]/[**▲**]: Select the desired unit.
→ [**SELECT**]
- 3 Wait for the paged party to answer.
 - If the paged party does not answer, press[**↶**]to return to the outside call.
- 4 **To complete the transfer:**
Press[**OFF**].
 - The outside call is being routed to the destination unit.**To establish a conference call:**
Press[**CONF**].
 - To leave the conference, press[**OFF**]. The other 2 parties can continue the conversation.
 - To put the outside call on hold, press[**HOLD**]. To resume the conference, press[**CONF**].

Base unit

Available for:
KX-TG7641 series (page 4)

- 1 During an outside call, press[**INTERCOM**].
When 2 or more handsets are registered:
 - To page a specific handset, enter the handset number.
 - To page all handsets, press[**0**]or wait for a few seconds.
- 2 Wait for the paged party to answer.
 - If paged party does not answer, press[**INTERCOM**]to return to the outside call.
- 3 **To complete the transfer:**
Press[**⇨**].
 - The outside call is being routed to the handset.**To establish a conference call:**
Press[**CONF**].

- To leave the conference, press[**⇨**]. The other 2 parties can continue the conversation.
- To put the outside call on hold, press[**HOLD**]. To resume the conference, press[**CONF**].

Answering a transferred call

Handset

Press[**↶**]to answer the page.

Base unit

Available for:
KX-TG7641 series (page 4)

Press[**⇨**]to answer the page.

Wall mounting

Note:

- Make sure that the wall and the fixing method are strong enough to support the weight of the unit.

Base unit (KX-TG7621 series: page 4)

- 1 Lead the AC adaptor cord and telephone line cord through the hole in the wall mounting adaptor in the direction of the arrow.

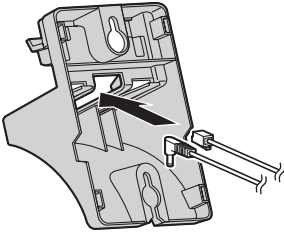

- 2 Tuck the telephone line cord inside the wall mounting adaptor (1). Connect the AC adaptor cord and telephone line cord (2).

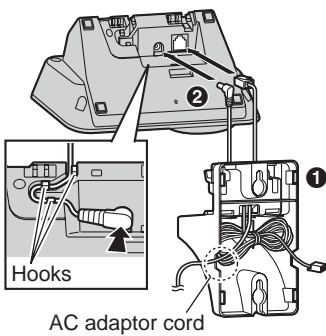

- 3 Insert the hooks on the wall mounting adaptor into holes 1 and 2 on the base unit.

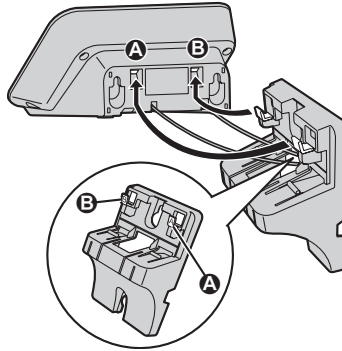

- 4 Adjust the adaptor to hold the base unit, then push it in the direction of the arrow until it clicks into place.

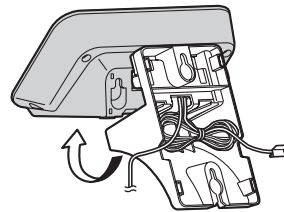
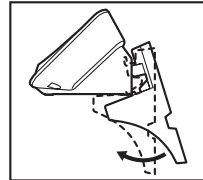

Useful Information

- 5 Mount the unit on a wall then slide down to secure in place.

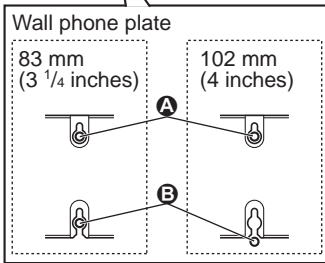
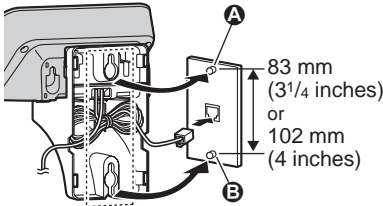
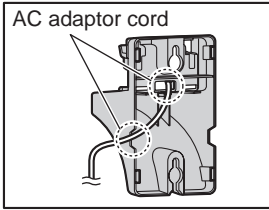

To remove the wall mounting adaptor

While pushing down the release levers (1), remove the adaptor (2).

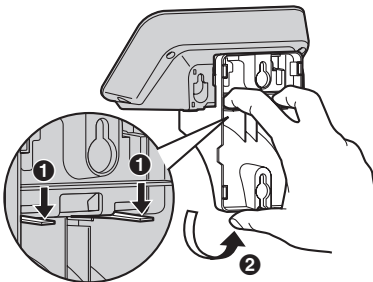

Base unit (KX-TG7641 series: page 4)

The base unit can be mounted on a wall by revolving the bracket to "WALL" position (default: "DESK" stand position).

- 1 Turn the bracket 180 degrees counterclockwise in the "WALL" direction until a click is heard.

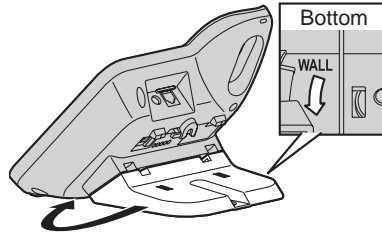

- The bracket cannot be removed. Do not turn the bracket more than 180 degrees.
- 2 Tuck in the telephone line cord (1). Connect the AC adaptor cord and telephone line cord (2).

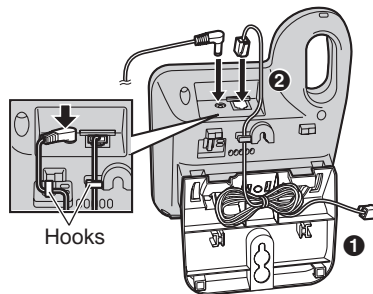

- 3** Mount the unit on a wall then slide down to secure in place.

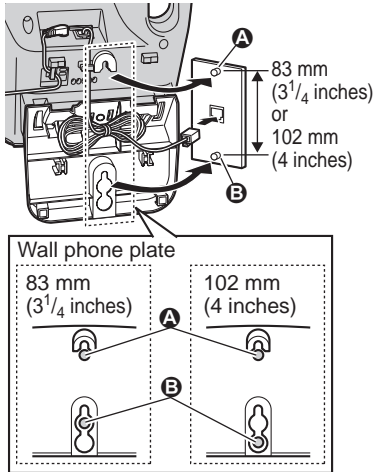

To stand on a desk

Turn the bracket 180 degrees clockwise from the "WALL" position to the "DESK" direction until a click is heard.

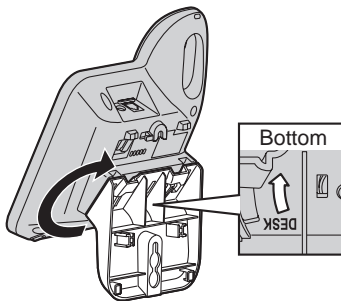

Charger

Drive the screws (not supplied) into the wall.

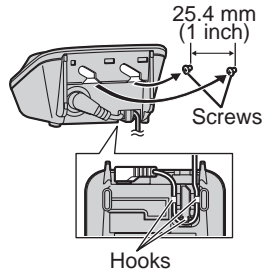

Error messages

Display message	Cause/solution
Base no power or No link. Re-connect base AC adaptor.	<ul style="list-style-type: none">● The handset has lost communication with the base unit. Move closer to the base unit and try again.● Unplug the base unit's AC adaptor to reset the unit. Reconnect the adaptor and try again.● The handset's registration may have been canceled. Re-register the handset (page 52).
Busy	<ul style="list-style-type: none">● No cellular phone is registered to the base unit. Register a cellular phone (page 20).● The called unit is in use.● Other units are in use and the system is busy. Try again later.● The handset you are using is too far from the base unit. Move closer and try again.
Call phone company for your access #	<ul style="list-style-type: none">● You have not stored the voice mail access number. Store the number (page 67).
Check tel line	<ul style="list-style-type: none">● The supplied telephone line cord has not been connected yet or not connected properly. Check the connections (page 11).● If you do not connect the telephone line cord and use only cellular lines, set the cellular line only mode (page 22).
Error!!	<ul style="list-style-type: none">● Recording was too short. Try again.● Someone is using a cellular line or headset. Try again later.● The phonebook copy is incomplete (page 57). The cellular phone is disconnected from the base unit. Make sure that other Bluetooth devices are not connected to the cellular phone, and try again.
Failed	<ul style="list-style-type: none">● Although the unit tried to connect to the cellular phone or headset, the connection has been failed.<ul style="list-style-type: none">– Someone is using a cellular line or headset. Try again later.– Make sure that the cellular phone or headset is not connected to other Bluetooth devices.

Useful Information

Display message	Cause/solution
Invalid	<ul style="list-style-type: none">• There is no handset registered to the base unit matching the handset number you entered.• The handset is not registered to the base unit. Register the handset (page 52).
Requires subscription to Caller ID.	<ul style="list-style-type: none">• You must subscribe to a Caller ID service. Once you receive caller information after subscribing to a Caller ID service, this message will not be displayed.
Use rechargeable battery.	<ul style="list-style-type: none">• A wrong type of battery such as Alkaline or Manganese was inserted. Use only the rechargeable Ni-MH batteries noted on page 6, 8.

Troubleshooting

If you still have difficulties after following the instructions in this section, disconnect the base unit's AC adaptor, then reconnect the base unit's AC adaptor. Remove the batteries from the handset, and then insert the batteries into the handset again.

General use

Problem	Cause/solution
The handset does not turn on even after installing charged batteries.	<ul style="list-style-type: none">• Place the handset on the base unit or charger to turn on the handset.
The unit does not work.	<ul style="list-style-type: none">• Make sure the batteries are installed correctly (page 11).• Fully charge the batteries (page 12).• Check the connections (page 11).• Unplug the base unit's AC adaptor to reset the unit. Reconnect the adaptor and try again.• The handset has not been registered to the base unit. Register the handset (page 52).

Useful Information



Problem	Cause/solution
I cannot register a cellular phone to the base unit.	<ul style="list-style-type: none">● Depending on the compatibility of the cellular phone, you may not be able to register it to the base unit. Confirm that your cellular phone supports the hands-free profile (HFP) specification.● Confirm that the Bluetooth feature of your cellular phone is turned on. You may need to turn this feature on depending on your cellular phone.● The Bluetooth technology on your cellular phone may not be functioning normally. Turn off and on your cellular phone.● If your cellular phone is already connected to another Bluetooth device such as a Bluetooth headset, turn it off or disconnect it from your cellular phone.● Some cellular phones may require you to enter the base unit PIN to register. Confirm that you entered the correct PIN.
I cannot connect a cellular phone to the base unit.	<ul style="list-style-type: none">● Confirm that your cellular phone is turned on.● Confirm that your cellular phone is within base unit range (page 16).● Depending on the state of the wireless environment, such as the presence of any electrical interference, there may be a delay even if the auto connection feature is turned on. You can connect to the base unit manually (page 22).● The cellular phone has not been registered to the base unit. Register the cellular phone (page 20).
I cannot hear a dial tone.	<ul style="list-style-type: none">● Make sure the base unit's AC adaptor is connected properly (page 11).● Make sure that the CELL 1 or CELL 2 indicator lights green (page 17).● Make sure the telephone line cord is connected properly (page 11).● Disconnect the base unit from the telephone line and connect the line to a known working telephone. If the working telephone operates properly, contact our service personnel to have the unit repaired. If the working telephone does not operate properly, contact your service provider/ telephone company.
The indicator on the handset flashes slowly.	<ul style="list-style-type: none">● New messages have been recorded. Listen to the new messages (page 62).● New voice mail messages have been recorded. Listen to the new voice mail messages (page 68).

Useful Information

Programmable settings

Problem	Cause/solution
The display is in a language I cannot read.	<ul style="list-style-type: none">● Change the display language (page 18).
I cannot register a handset to a base unit.	<ul style="list-style-type: none">● The maximum number of handsets (6) is already registered to the base unit. Cancel unused handset registrations from the base unit (page 52).

Battery recharge

Problem	Cause/solution
The handset beeps and/or  flashes.	<ul style="list-style-type: none">● Battery charge is low. Fully charge the batteries (page 12).
I fully charged the batteries, but <ul style="list-style-type: none">–  still flashes,–  is displayed, or– the operating time seems to be shorter.	<ul style="list-style-type: none">● Clean the battery ends (\oplus, \ominus) and the charge contacts with a dry cloth and charge again.● It is time to replace the batteries (page 11).

Making/answering calls, intercom

Problem	Cause/solution
 is displayed.	<ul style="list-style-type: none">● The handset is too far from the base unit. Move closer.● The base unit's AC adaptor is not properly connected. Reconnect AC adaptor to the base unit.● The handset is not registered to the base unit. Register it (page 52).
Noise is heard, sound cuts in and out.	<ul style="list-style-type: none">● You are using the handset or base unit in an area with high electrical interference. Re-position the base unit and use the handset away from sources of interference.● Move closer to the base unit.● If you use a DSL/ADSL service, we recommend connecting a DSL/ADSL filter between the base unit and the telephone line jack. Contact your DSL/ADSL provider for details.

Useful Information

Problem	Cause/solution
The handset or base unit does not ring.	<ul style="list-style-type: none">• The ringer volume is turned off. Adjust the ringer volume (page 45, 46).• When one handset is selected to ring for cellular calls, other units do not ring. To change the selection, see page 21.• Silent mode is turned on for the handset. Turn it off (page 50).
I cannot make local calls with the handset or base unit using a cellular line.	<ul style="list-style-type: none">• You need to add your area code when making cellular calls. Store your area code in order to automatically add it to the beginning of the 7-digit phone number when making cellular calls (page 23).
I cannot make or answer cellular calls with the handset or base unit.	<ul style="list-style-type: none">• Depending on the cellular phone's compatibility, you may not be able to make or answer cellular calls even if the cellular phone is connected to the base unit.• Make sure that the CELL 1 or CELL 2 indicator lights green and the cellular phone is connected to the base unit (page 22).• If someone is talking on a cellular call or using the headset, you cannot use the cellular feature. There can be only one active Bluetooth connection at a time.• The cellular phone is being used separately from your system.
I can make and answer cellular calls but cannot hear a sound.	<ul style="list-style-type: none">• The Bluetooth technology on your cellular phone may not be functioning normally. Turn off and on your cellular phone.• Disconnect and reconnect the base unit AC adaptor and try again.
I cannot switch cellular calls from the unit to the cellular phone.	<ul style="list-style-type: none">• Your cellular phone may not support this feature. Refer to the operating instructions of your cellular phone.
I cannot make a call using the landline.	<ul style="list-style-type: none">• The dialing mode may be set incorrectly. Change the setting (page 19).• The handset is too far from the base unit. Move closer and try again.• The cellular line only mode is turned on. Turn it off (page 22).
I cannot make long distance calls.	<ul style="list-style-type: none">• Make sure that you have long distance service.

Caller ID/Talking Caller ID

Problem	Cause/solution
<p>Caller information is not displayed.</p>	<ul style="list-style-type: none"> ● You must subscribe to Caller ID service. Contact your service provider/telephone company for details. ● If your unit is connected to any additional telephone equipment such as a Caller ID box or cordless telephone line jack, plug the unit directly into the wall jack. ● If you use a DSL/ADSL service, we recommend connecting a DSL/ADSL filter between the base unit and the telephone line jack. Contact your DSL/ADSL provider for details. ● The name display service for landline calls may not be available in some areas. Contact your service provider/telephone company for details. ● Other telephone equipment may be interfering with this unit. Disconnect the other equipment and try again.
<p>Caller information is not announced.</p>	<ul style="list-style-type: none"> ● The handset or base unit's ringer volume is turned off. Adjust it (page 45, 46). ● When one handset is selected to ring for cellular calls, other units do not announce caller information. To change the selection, see page 21. ● The Talking Caller ID feature is turned off. Turn it on (page 44). ● The ring as cell mode is set to "On (without Talking CID)". To change the mode, see page 21. ● The number of rings for the answering system is set to "2 rings" or "Toll saver". Select a different setting (page 65). ● Your unit does not announce caller information if <ul style="list-style-type: none"> – the base unit or 2 or more handsets are on a call. – a headset is in use.
<p>Caller information is displayed or announced late.</p>	<ul style="list-style-type: none"> ● Depending on your service provider/telephone company, the unit may display or announce the caller's information at the 2nd ring or later. ● Move closer to the base unit.
<p>The caller list/incoming phone numbers are not edited automatically.</p>	<ul style="list-style-type: none"> ● The Caller ID number auto edit feature is turned off. Turn it on and try again (page 44). ● You need to call back the edited number to activate Caller ID number auto edit.

Useful Information

Problem	Cause/solution
I cannot dial the phone number edited in the caller list.	<ul style="list-style-type: none">● The phone number you dialed might have been edited incorrectly (for example, the long distance "1" or the area code is missing). Edit the phone number with another pattern (page 55).
Time on the unit has shifted.	<ul style="list-style-type: none">● Incorrect time information from incoming Caller ID changes the time. Set the time adjustment to "Manual" (off) (page 46).
The 2nd caller's information is not displayed during an outside call.	<ul style="list-style-type: none">● In order to use Caller ID, call waiting, or Call Waiting Caller ID (CWID), you must first contact your service provider/telephone company and subscribe to the desired service. After subscribing, you may need to contact your service provider/telephone company again to activate this specific service, even if you already subscribed to both Caller ID and Call Waiting with Caller ID services (CWID).

Using Bluetooth devices

Problem	Cause/solution
I cannot copy phonebook entries from a cellular phone.	<ul style="list-style-type: none">● Confirm that the cellular phone supports Bluetooth wireless technology.● Confirm that the cellular phone supports the Phone Book Access Profile (PBAP) or Object Push Profile (OPP) specification.● If the cellular phone is already connected to another Bluetooth device such as a Bluetooth headset, turn it off or disconnect it from the cellular phone.● Someone is using a cellular line or headset. Try again later.● Turn the cellular phone off, then turn it on and try again.● If an entry is already stored in the unit's shared phonebook, the entry cannot be copied even by selecting another group.
I cannot have a conversation using the headset.	<ul style="list-style-type: none">● Your Bluetooth headset is not registered. Register it (page 58).● Turn your headset off, then turn it on and try again.
Noise is heard during a call on the headset.	<ul style="list-style-type: none">● A Bluetooth headset can communicate with the base unit within a range of approximately 10 m (33 feet). The connection may be subject to interference from obstructions such as walls or electronic devices. Move closer to the base unit.

Useful Information

Problem	Cause/solution
I cannot connect my headset to the base unit.	<ul style="list-style-type: none"> ● Confirm that your headset is turned on. ● If your headset is already connected to another Bluetooth device such as your cellular phone, disconnect the headset from your cellular phone, then perform the connecting procedure from the base unit. ● If someone is using a cellular line, you cannot connect the headset. There can be only one active Bluetooth connection at a time. ● The headset has not been registered to the base unit. Register the headset (page 58).
Some headset enhanced features are not available.	<ul style="list-style-type: none"> ● The base unit does not support enhanced features such as Last number redial or Call reject.
An error tone is heard when I try to program the Bluetooth feature.	<ul style="list-style-type: none"> ● The bluetooth feature cannot be accessed immediately after connecting the AC adaptor to the base unit. Wait a few seconds and try again. ● The headset has not connected to the base unit yet, even though you performed the connecting procedure setting. Wait a few seconds and try again.

Answering system

Problem	Cause/solution
The unit does not record new messages.	<ul style="list-style-type: none"> ● The answering system is turned off. Turn it on (page 60). ● The answering system does not answer or record calls from cellular lines. ● The message memory is full. Erase unnecessary messages (page 62). ● The recording time is set to "Greeting only". Change the setting (page 65). ● If you subscribe to a voice mail service, messages are recorded by your service provider/telephone company, not your telephone. Change the unit's number of rings setting or contact your service provider/telephone company (page 65). ● The answering system will not answer incoming calls while: <ul style="list-style-type: none"> – the base unit or 2 or more handsets are on a cellular call or an intercom call. – a headset is in use. <p>Caller information is recorded in the caller list.</p>

Useful Information

Problem	Cause/solution
I cannot operate the answering system.	<ul style="list-style-type: none">• Someone is using the unit. Wait for the other user to finish.• A caller is leaving a message. Wait for the caller to finish.• The handset is too far from the base unit. Move closer.
I cannot operate the answering system remotely.	<ul style="list-style-type: none">• The remote access code is not set. Set the remote access code (page 64).• You are entering the wrong remote access code. If you have forgotten your remote access code, enter the remote access code setting to check your current code (page 64).• Press each key firmly.• The answering system is turned off. Turn it on (page 65).• You cannot operate the answering system when calling a cellular phone registered to the base unit.

Bluetooth PIN

Problem	Cause/solution
I cannot remember the PIN.	<ul style="list-style-type: none">• Change the PIN using the following method.<ol style="list-style-type: none">1 [MENU] → [#] [6] [1] [9]2 [*] [7] [0] [0] [0]3 Enter the new 4-digit PIN. → [OK]4 Enter the new 4-digit PIN again. → [SAVE] → [OFF]

Liquid damage

Problem	Cause/solution
Liquid or other form of moisture has entered the handset/base unit.	<ul style="list-style-type: none">• Disconnect the AC adaptor and telephone line cord from the base unit. Remove the batteries from the handset and leave to dry for at least 3 days. After the handset/base unit are completely dry, reconnect the AC adaptor and telephone line cord. Insert the batteries and charge fully before use. If the unit does not work properly, contact an authorized service center.

Caution:

- To avoid permanent damage, do not use a microwave oven to speed up the drying process.

FCC and other information

This equipment complies with Part 68 of the FCC rules and the requirements adopted by the ACTA. On the bottom of this equipment is a label that contains, among other information, a product identifier in the format US:ACJ-----.

If requested, this number must be provided to the telephone company.

- Registration No.....(found on the bottom of the unit)
- Ringer Equivalence No. (REN).....0.1B

A plug and jack used to connect this equipment to the premises wiring and telephone network must comply with the applicable FCC Part 68 rules and requirements adopted by the ACTA. A compliant telephone cord and modular plug is provided with the product. It is designed to be connected to a compatible modular jack that is also compliant.

The REN is used to determine the number of devices that may be connected to a telephone line. Excessive RENs on a telephone line may result in the devices not ringing in response to an incoming call. In most but not all areas, the sum of RENs should not exceed five (5.0). To be certain of the number of devices that may be connected to a line, as determined by the total RENs, contact the local telephone company. For products approved after July 23, 2001, the REN for the product is part of the product identifier that has the format US:AAAEQ##TXXXX. The digits represented by ## are the REN without a decimal point (e.g., 03 is a REN of 0.3).

If this equipment causes harm to the telephone network, the telephone company will notify you in advance that temporary discontinuance of service may be required. But if advance notice isn't practical, the telephone company will notify the customer as soon as possible. Also, you will be advised of your right to file a complaint with the FCC if you believe it is necessary.

The telephone company may make changes in its facilities, equipment, operations or procedures that could affect the operation of the equipment. If this happens the telephone company will provide advance notice in order for you to make necessary modifications to maintain uninterrupted service.

If trouble is experienced with this equipment, for repair or warranty information, please contact a Factory Service Center or other Authorized Servicer. If the equipment is causing harm to the telephone network, the telephone company may request that you disconnect the equipment until the problem is resolved.

Connection to party line service is subject to state tariffs. Contact the state public utility commission, public service commission or corporation commission for information.

If your home has specially wired alarm equipment connected to the telephone line, ensure the installation of this equipment does not disable your alarm equipment. If you have questions about what will disable alarm equipment, consult your telephone company or a qualified installer.

This equipment is hearing aid compatible as defined by the FCC in 47 CFR Section 68.316.

When you hold the phone to your ear, noise might be heard in your Hearing Aid. Some Hearing Aids are not adequately shielded from external RF (radio frequency) energy. If noise occurs, use an optional headset accessory or the speakerphone option (if applicable) when using this phone. Consult with your audiologist or Hearing Aid manufacturer about the availability of Hearing Aids which provide adequate shielding to RF energy commonly emitted by digital devices.

Useful Information

WHEN PROGRAMMING EMERGENCY NUMBERS AND/OR MAKING TEST CALLS TO EMERGENCY NUMBERS:

- 1) Remain on the line and briefly explain to the dispatcher the reason for the call.
- 2) Perform such activities in the off-peak hours, such as early morning or late evenings.

This device complies with Part 15 of the FCC Rules. Operation is subject to the following two conditions:

(1) This device may not cause harmful interference, and (2) this device must accept any interference received, including interference that may cause undesired operation.

Privacy of communications may not be ensured when using this phone.

CAUTION:

Any changes or modifications not expressly approved by the party responsible for compliance could void the user's authority to operate this device.

NOTE:

This equipment has been tested and found to comply with the limits for a Class B digital device, pursuant to Part 15 of the FCC Rules. These limits are designed to provide reasonable protection against harmful interference in a residential installation. This equipment generates, uses, and can radiate radio frequency energy and, if not installed and used in accordance with the instructions, may cause harmful interference to radio communications. However, there is no guarantee that interference will not occur in a particular installation. If this equipment does cause harmful interference to radio or television reception, which can be determined by turning the equipment off and on, the user is encouraged to try to correct the interference by one or more of the following measures:

- Reorient or relocate the receiving antenna.
- Increase the separation between the equipment and receiver.
- Connect the equipment into an outlet on a circuit different from that to which the receiver is connected.

- Consult the dealer or an experienced radio/TV technician for help.

Some cordless telephones operate at frequencies that may cause interference to nearby TVs and VCRs. To minimize or prevent such interference, the base of the cordless telephone should not be placed near or on top of a TV or VCR. If interference is experienced, move the cordless telephone further away from the TV or VCR. This will often reduce, or eliminate, interference.

FCC RF Exposure Warning:

- This product complies with FCC radiation exposure limits set forth for an uncontrolled environment.
- To comply with FCC RF exposure requirements, the base unit must be installed and operated 20 cm (8 inches) or more between the product and all person's body (excluding extremities of hands, wrist and feet).
- This product may not be collocated or operated in conjunction with any other antenna or transmitter.
- The handset may be carried and operated with only the specific provided belt-clip. Other non-tested belt-clips or similar body-worn accessories may not comply and must be avoided.

Notice

- FCC ID can be found inside the battery compartment or on the bottom of the units.

Compliance with TIA-1083 standard:

Telephone handsets identified with this logo have reduced noise and interference when used with T-Coil equipped hearing aids and cochlear implants.

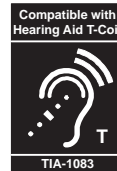

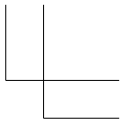
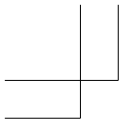

Guía Rápida Española

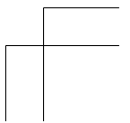
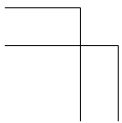
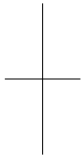

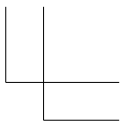
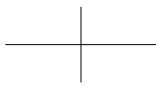
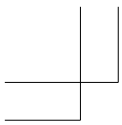

Guía Rápida Española

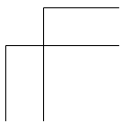
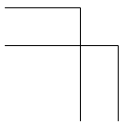
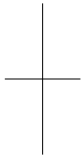

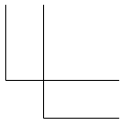
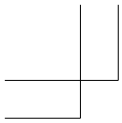

Guía Rápida Española

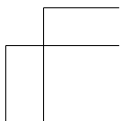
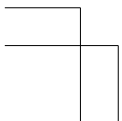
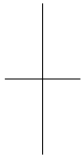

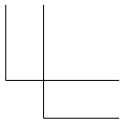
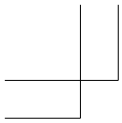

Guía Rápida Española

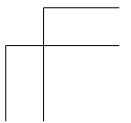
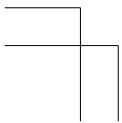
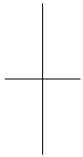

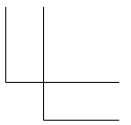
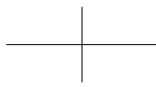
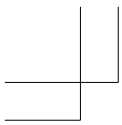

Guía Rápida Española

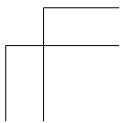
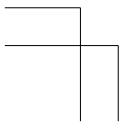
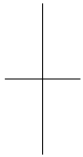

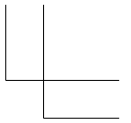
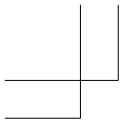

Guía Rápida Española

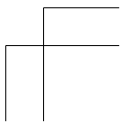
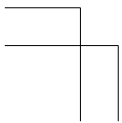
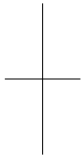

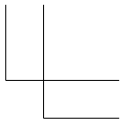
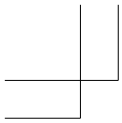

Guía Rápida Española

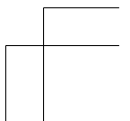
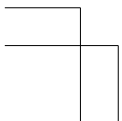
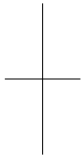

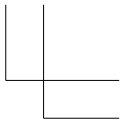
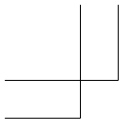

Guía Rápida Española

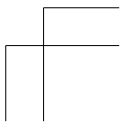
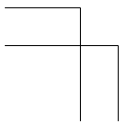
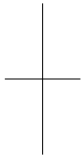

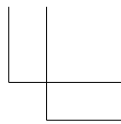
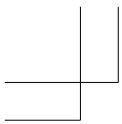

Guía Rápida Española

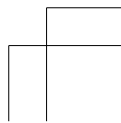
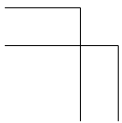
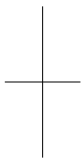

Customer services

Customer Services Directory (United States and Puerto Rico)

Obtain Product Information and Operating Assistance; locate your nearest Dealer or Service Center; purchase Parts and Accessories; or make Customer Service and Literature requests by visiting our Web Site at:

<http://www.panasonic.com/help>

or, contact us via the web at:

<http://www.panasonic.com/contactinfo>

You may also contact us directly at: 1-800-211-PANA (1-800-211-7262),
Monday - Friday 9 am to 9 pm; Saturday - Sunday 10 am to 7 pm, EST.

TTY users (hearing or speech impaired users) can call 1-877-833-8855.

Accessory Purchases (United States and Puerto Rico)

Purchase Parts, Accessories and Instruction Books online for all Panasonic Products by visiting our Web Site at:

<http://www.pstc.panasonic.com>

or, send your request by E-mail to:

npcparts@us.panasonic.com

You may also contact us directly at:

1-800-332-5368 (Phone) 1-800-237-9080 (Fax Only)

(Monday - Friday 9 am to 9 pm, EST.)

Panasonic Service and Technology Company

20421 84th Avenue South, Kent, WA 98032

(We Accept Visa, MasterCard, Discover Card, American Express, and Personal Checks.)

TTY users (hearing or speech impaired users) can call 1-866-605-1277.

Warranty (For United States and Puerto Rico)

PANASONIC CORPORATION OF NORTH AMERICA
One Panasonic Way, Secaucus, New Jersey 07094

Panasonic Telephone Products Limited Warranty

Limited Warranty Coverage

If your product does not work properly because of a defect in materials or workmanship, Panasonic Corporation of North America (referred to as "the warrantor") will, for the length of the period indicated on the chart below, which starts with the date of original purchase ("Limited Warranty period"), at its option either (a) repair your product with new or refurbished parts, or (b) replace it with a new or a refurbished product. The decision to repair or replace will be made by the warrantor.

Parts	Labor
One (1) Year	One (1) Year

During the "Labor" Limited Warranty period there will be no charge for labor. During the "Parts" Limited Warranty period, there will be no charge for parts. You must mail-in your product prepaid during the Limited Warranty period. This Limited Warranty excludes both parts and labor for batteries, antennas, and cosmetic parts (cabinet). This Limited Warranty only applies to products purchased and serviced in the United States or Puerto Rico. This Limited Warranty is extended only to the original purchaser and only covers products purchased as new.

Ship-In Service

For assistance in the continental United States and Puerto Rico in obtaining repairs please ship the product prepaid to:

PSTC (Panasonic) Exchange Center,
4900 George McVay Drive, Suite B Door #12, McAllen, TX 78503
panacare@us.panasonic.com

When shipping the unit carefully pack in a padded shipping carton, include all accessories, and send it prepaid. Include a letter detailing the complaint, a return address and provide a day time phone number where you can be reached. P.O. Boxes are not acceptable. Keep the tracking number for your records. A copy of valid registered receipt is required under the 1 year parts and labor Limited Warranty.

For Limited Warranty service for headsets if a headset is included with this product please follow instructions above.

IF REPAIR IS NEEDED DURING THE LIMITED WARRANTY PERIOD THE PURCHASER WILL BE REQUIRED TO FURNISH A SALES RECEIPT/PROOF OF PURCHASE INDICATING DATE OF PURCHASE, AMOUNT PAID AND PLACE OF PURCHASE. CUSTOMER WILL BE CHARGED FOR THE REPAIR OF ANY UNIT RECEIVED WITHOUT SUCH PROOF OF PURCHASE.

Appendix

Limited Warranty Limits And Exclusions

This Limited Warranty ONLY COVERS failures due to defects in materials or workmanship, and DOES NOT COVER normal wear and tear or cosmetic damage. The Limited Warranty ALSO DOES NOT COVER damages which occurred in shipment, or failures which are caused by products not supplied by the warrantor, or failures which result from accidents, misuse, abuse, neglect, bug infestation, mishandling, misapplication, alteration, faulty installation, set-up adjustments, misadjustment of consumer controls, improper maintenance, power line surge, lightning damage, modification, introduction of sand, humidity or liquids, commercial use such as hotel, office, restaurant, or other business or rental use of the product, or service by anyone other than a Factory Service Center or other Authorized Servicer, or damage that is attributable to acts of God.

THERE ARE NO EXPRESS WARRANTIES EXCEPT AS LISTED UNDER "LIMITED WARRANTY COVERAGE". THE WARRANTOR IS NOT LIABLE FOR INCIDENTAL OR CONSEQUENTIAL DAMAGES RESULTING FROM THE USE OF THIS PRODUCT, OR ARISING OUT OF ANY BREACH OF THIS LIMITED WARRANTY. (As examples, this excludes damages for lost time, lost calls or messages, cost of having someone remove or re-install an installed unit if applicable, travel to and from the servicer. The items listed are not exclusive, but are for illustration only.) **ALL EXPRESS AND IMPLIED WARRANTIES, INCLUDING THE WARRANTY OF MERCHANTABILITY, ARE LIMITED TO THE PERIOD OF THE LIMITED WARRANTY.**

Some states do not allow the exclusion or limitation of incidental or consequential damages, or limitations on how long an implied warranty lasts, so the exclusions may not apply to you.

This Limited Warranty gives you specific legal rights and you may also have other rights which vary from state to state. If a problem with this product develops during or after the Limited Warranty period, you may contact your dealer or Service Center. If the problem is not handled to your satisfaction, then write to the warrantor's Consumer Affairs Department at the addresses listed for the warrantor.

PARTS AND SERVICE, WHICH ARE NOT COVERED BY THIS LIMITED WARRANTY, ARE YOUR RESPONSIBILITY.

When you ship the product

- Carefully pack your unit, preferably in the original carton.
- Attach a letter, detailing the symptom.
- Send the unit to PSTC (Panasonic) Exchange Center, prepaid and adequately insured.
- Do not send your unit to Panasonic Corporation of North America listed on the back cover or to executive or regional sales offices. These locations do not repair consumer products.

Index

#

3-way conference: 28

A

Additional handset: 52
Alarm: 50
Answering calls: 26
Answering system
 Call screening: 60
 Erasing messages: 62, 63, 64
 Greeting message: 61
 Greeting only: 65
 Listening to messages: 61, 62, 64
 MEMO: 63
 Number of rings: 65
 Recording time: 65
 Remote access code: 64
 Remote operation: 63
 Ring count: 65
 Toll saver: 65
 Turning on/off: 60, 64, 65
Auto talk: 26

B

Battery: 11, 12
Belt clip: 15
Bluetooth wireless technology
 Cellular phone (Link to cell): 20
 Headset: 58
 Phonebook transfer: 57
Booster (Clarity booster): 27

C

Call block: 51
Call share: 28
Call waiting: 27
Call Waiting Caller ID: 27
Caller ID number auto edit: 55
Caller ID service: 53
Caller list: 54
Caller list edit: 55

Cellular calls: 25, 31
Cellular phone
 Deregistration: 24
 Registration: 20
Chain dial: 37
CID (Caller ID): 54
Conference calls: 69
Control type: 14, 15
Customer support: 44

D

Date and time: 18
Dialing mode: 19
Direct commands: 43
Display
 Contrast: 44
 Language: 18

E

Eco mode: 13
Equalizer: 28
Error messages: 74

F

Flash: 27, 47

G

Groups: 35, 54

H

Handset
 Deregistration: 52
 Locator: 69
 Name: 51
 Registration: 52
Hold: 26, 32

I

Intercom: 69

K

Key tone: 44

Index

L

Landline calls: 25, 31
Line mode: 47
Link to cell
 Area code: 23
 Auto connection: 22
 Cellular line only mode: 22
 Cellular line selection: 23
 Connection: 22
 Ring as cell mode: 21
 Select unit to ring: 21

M

Making calls: 25
Missed calls: 53
Mute: 27

P

Pause: 26
Phonebook: 35
PIN: 23
Power failure: 29

R

Redialing: 25
Ringer tone: 45, 46, 54
Rotary/pulse service: 27

S

Silent mode: 50
SP-PHONE (Speakerphone): 25

T

Talking caller ID: 53
Temporary tone dialing: 27
Time adjustment: 46
Transferring calls: 69
Troubleshooting: 75
TTY: 94

V

VM (Voice mail): 67
Voice guidance language: 18
Voice mail: 65, 67
Volume
 Receiver: 25
 Ringer (Base unit): 45, 46
 Ringer (Handset): 26, 45, 46
 Speaker: 25

W

Wall mounting: 71

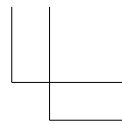
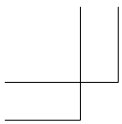

Notes

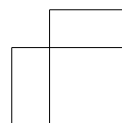
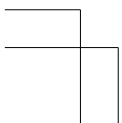
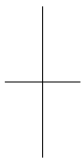

IMPORTANT!

If your product is not working properly. . .

- ① **Reconnect AC adaptor to the base unit.**
- ② **Check if telephone line cord is connected.**
- ③ **Use rechargeable Ni-MH batteries.**
(Alkaline/Manganese/Ni-Cd batteries CANNOT be used.)
- ④ **Read troubleshooting page in the Operating Instructions.**



Visit our Web site: <http://www.panasonic.com/help>

- **FAQ and troubleshooting hints are available.**

For your future reference

We recommend keeping a record of the following information to assist with any repair under warranty.

Serial No.	Date of purchase
(found on the bottom of the base unit)	
Name and address of dealer	

Attach your purchase receipt here.

Panasonic Corporation of North America
One Panasonic Way, Secaucus, New Jersey 07094

© Panasonic System Networks Co., Ltd. 2010

Printed in Malaysia



TG7622

PNQX3168ZA DM1110DM0