

# Panasonic®

## Operating Instructions

### Cordless Telephone with Digital Answering Machine

Model No. **KX-TGE632**  
**KX-TGE633**  
**KX-TG3834**  
**KX-TGE645**  
**KX-TG3845**

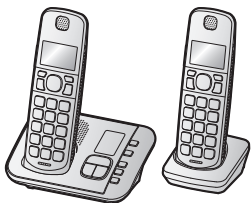

Model shown is KX-TGE632.

***Before initial use, see “Getting Started”  
on page 10.***

**Thank you for purchasing a Panasonic product.**

Please read these operating instructions before using the unit and save them for future reference.

**Consulte “Guía Rápida Española”, página 63.**

For assistance, visit our Web site: <http://shop.panasonic.com/support> for customers in the U.S.A.

**Please register your product: <http://shop.panasonic.com/support>**

## Table of Contents

---

|   |    |  |    |
|---|----|--|----|
| <b>Introduction</b>   |    | <b>Programming</b>                           |    |
| Model composition .....   | 3  | Menu list .....                              | 30 |
| Accessory information .....   | 3  | Alarm .....                                  | 37 |
| Graphical symbols for use on equipment and their descriptions ..... | 5  | Silent mode .....                            | 37 |
|   |    | Baby monitor .....                           | 38 |
|   |    | Other programming .....                      | 40 |
|   |    | Registering a unit .....                     | 40 |
| <b>Important Information</b>  |    | <b>Caller ID Service</b>                     |    |
| For your safety .....   | 6  | Using Caller ID service .....                | 42 |
| Important safety instructions .....                                 | 7  | Caller list .....                            | 42 |
| For best performance .....  | 7  |  |    |
| Other information .....   | 8  | <b>Answering System</b>                      |    |
| Specifications .....  | 9  | Answering system .....                       | 44 |
|   |    | Turning the answering system on/off .....    | 44 |
| <b>Getting Started</b>  |    | Greeting message .....                       | 44 |
| Setting up .....  | 10 | Listening to messages .....                  | 45 |
| Controls .....  | 12 | Advanced new message alerting features ..... | 46 |
| Display icons .....   | 14 | Remote operation .....                       | 47 |
| Language settings .....   | 14 | Answering system settings .....              | 49 |
| Date and time .....   | 14 |  |    |
| Recording your greeting message .....                               | 15 | <b>Useful Information</b>                    |    |
| Other settings .....  | 15 | Voicemail service .....                      | 50 |
|   |    | Wall mounting .....                          | 51 |
| <b>Making/Answering Calls</b>                                       |    | Error messages .....                         | 54 |
| Making calls .....  | 16 | Troubleshooting .....                        | 55 |
| Answering calls .....   | 17 | FCC and other information .....              | 60 |
| Useful features during a call .....                                 | 17 |  |    |
| Handset locator .....   | 20 | <b>Guía Rápida Española</b>                  |    |
| Cell locator .....  | 20 | Guía Rápida Española .....                   | 63 |
| Intercom .....  | 20 |  |    |
| Power backup operation .....  | 21 | <b>Appendix</b>                              |    |
|   |    | Customer services .....                      | 68 |
| <b>Call Block</b>   |    | Limited Warranty (ONLY FOR U.S.A.) .....     | 69 |
| Call block .....  | 23 |  |    |
| Storing unwanted callers .....                                      | 23 | <b>Index</b>                                 |    |
|   |    | Index.....                                   | 71 |
| <b>Automated callers</b>  |    |  |    |
| Automated callers block .....                                       | 25 |  |    |
| Storing allow name list .....                                       | 25 |  |    |
| Displaying and clearing blocked call counts .....                   | 26 |  |    |
| Changing the access code .....                                      | 26 |  |    |
| Automated callers block greeting message .....                      | 26 |  |    |
|   |    |  |    |
| <b>Phonebook</b>  |    |  |    |
| Phonebook .....   | 27 |  |    |
| Speed dial .....  | 29 |  |    |

## Model composition

### ■ KX-TGE630 series



### ■ KX-TGE640 series



● Model shown is KX-TGE632.

● Model shown is KX-TGE645.

| Series           | Model No. | Base unit | Handset   | Quantity |
|------------------|-----------|-----------|-----------|----------|
|                  |           | Part No.  | Part No.  |          |
| KX-TGE630 series | KX-TGE632 | KX-TGE630 | KX-TGEA60 | 2        |
|                  | KX-TGE633 | KX-TGE630 | KX-TGEA60 | 3        |
|                  | KX-TG3834 | KX-TGE630 | KX-TGEA60 | 4        |
| KX-TGE640 series | KX-TGE645 | KX-TGE640 | KX-TGEA60 | 5        |
|                  | KX-TG3845 | KX-TGE640 | KX-TGEA60 | 5        |

## Accessory information

### Supplied accessories

| No. | Supplied handset qty.                         | 2 units* <sup>1</sup> | 3 units* <sup>2</sup> | 4 units* <sup>3</sup> | 5 units* <sup>4</sup> |
|-----|---|-----------------------|-----------------------|-----------------------|-----------------------|
|     | Accessory item/Part number                    | Accessory quantity    |                       |                       |                       |
| ①   | AC adaptor/PNLV226-0X                         | 1                     | 1                     | 1                     | 1                     |
| ②   | Telephone line cord/<br>PNJA1186Z             | 1                     | 1                     | 1                     | 1                     |
| ③   | Wall mounting adaptor/<br>PNKL1001X1          | 1                     | 1                     | 1                     | 1                     |
| ④   | Rechargeable batteries* <sup>5</sup>          | 4                     | 6                     | 8                     | 10                    |
| ⑤   | Handset cover* <sup>6</sup> /<br>PNYNTGEA60BR | 2                     | 3                     | 4                     | 5                     |
| ⑥   | Belt clip/PNKE2125Z1                          | 2                     | 3                     | 4                     | 5                     |
| ⑦   | Charger/PNLCL1079ZB                           | 1                     | 2                     | 3                     | 4                     |

\*1 KX-TGE632

For assistance, please visit <http://shop.panasonic.com/support>

## Introduction

- \*2 KX-TGE633
- \*3 KX-TG3834
- \*4 KX-TGE645/KX-TG3845
- \*5 See page 4 for replacement battery information.
- \*6 The handset cover comes attached to the handset.

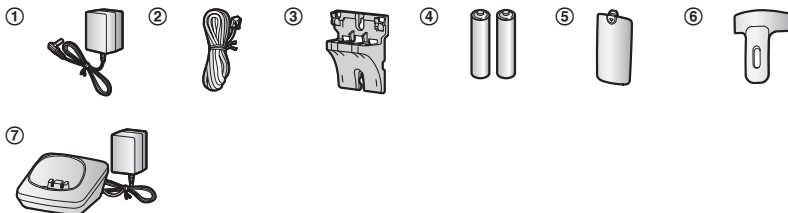

## Additional/replacement accessories

Please contact your nearest Panasonic dealer for sales information (page 68).

| Accessory item         | Model number/Specifications  |
|------------------------|--|
| Rechargeable batteries | HHR-4DPA*1   |
|                        | ● To order, please visit <a href="http://shop.panasonic.com/support">http://shop.panasonic.com/support</a><br>Battery type:<br>– Nickel metal hydride (Ni-MH)<br>– 2 x AAA (R03) size for each handset |
| Headset                | KX-TCA93, KX-TCA430  |
| Range extender         | KX-TGA407*2  |
| Key detector           | KX-TGA20*3   |

- \*1 Replacement batteries may have a different capacity from that of the supplied batteries.
- \*2 By installing this unit, you can extend the range of your phone system to include areas where reception was previously not available. This product can be purchased online. Please visit our Web site: <http://shop.panasonic.com/support>
- \*3 By registering the key detector (4 max.) to a Panasonic Digital Cordless Phone and attaching it to an easy-to-lose item in advance, you can locate and find the mislaid item to which the key detector is attached. Please visit our Web site: <http://www.panasonic.com/tga20>

## Other information

- Design and specifications are subject to change without notice.
- The illustrations in these instructions may vary slightly from the actual product.

## Expanding your phone system

### Handset (optional): KX-TGEA60

You can expand your phone system by registering optional handsets (6 max.) to a single base unit.

- Optional handsets may be a different color from that of the supplied handsets.



## Graphical symbols for use on equipment and their descriptions

| Symbol | Explanation                | Symbol | Explanation  |
|--------|----------------------------|--------|--|
|        | Alternating current (A.C.) |        | Class II equipment (equipment in which protection against electric shock relies on Double Insulation or Reinforced Insulation) |
|        | Direct current (D.C.)      |        | "ON" (power)   |
|        | Protective earth           |        | "OFF" (power)  |
|        | Protective bonding earth   |        | Stand-by (power)   |
|        | Functional earth           |        | "ON"/"OFF" (power; push-push)  |
|        | For indoor use only        |        | Caution, risk of electric shock  |

## Important Information

### For your safety

To prevent severe injury and loss of life/property, read this section carefully before using the product to ensure proper and safe operation of your product.

#### WARNING

##### Power connection

- Use only the power source marked on the product.
- Do not overload power outlets and extension cords. This can result in the risk of fire or electric shock.
- Completely insert the AC adaptor/power plug into the power outlet. Failure to do so may cause electric shock and/or excessive heat resulting in a fire.
- Regularly remove any dust, etc. from the AC adaptor/power plug by pulling it from the power outlet, then wiping with a dry cloth. Accumulated dust may cause an insulation defect from moisture, etc. resulting in a fire.
- Unplug the product from power outlets if it emits smoke, an abnormal smell, or makes an unusual noise. These conditions can cause fire or electric shock. Confirm that smoke has stopped emitting and contact us at <http://shop.panasonic.com/support>
- Unplug from power outlets and never touch the inside of the product if its casing has been broken open.
- Never touch the plug with wet hands. Danger of electric shock exists.

##### Installation

- To prevent the risk of fire or electrical shock, do not expose the product to rain or any type of moisture.
- Do not place or use this product near automatically controlled devices such as automatic doors and fire alarms. Radio waves emitted from this product may cause such devices to malfunction resulting in an accident.

- Do not allow the AC adaptor or telephone line cord to be excessively pulled, bent or placed under heavy objects.

##### Operating safeguards

- Unplug the product from power outlets before cleaning. Do not use liquid or aerosol cleaners.
- Do not disassemble the product.
- Do not spill liquids (detergents, cleansers, etc.) onto the telephone line cord plug, or allow it to become wet at all. This may cause a fire. If the telephone line cord plug becomes wet, immediately pull it from the telephone wall jack, and do not use.

##### Medical

- Consult the manufacturer of any personal medical devices, such as pacemakers or hearing aids, to determine if they are adequately shielded from external RF (radio frequency) energy. (The product operates in the frequency range of 1.92 GHz to 1.93 GHz, and the RF transmission power is 115 mW (max.).)
- Do not use the product in health care facilities if any regulations posted in the area instruct you not to do so. Hospitals or health care facilities may be using equipment that could be sensitive to external RF energy.

#### CAUTION

##### Installation and location

- Never install telephone wiring during an electrical storm.
- Never install telephone line jacks in wet locations unless the jack is specifically designed for wet locations.
- Never touch uninsulated telephone wires or terminals unless the telephone line has been disconnected at the network interface.
- Use caution when installing or modifying telephone lines.
- The AC adaptor is used as the main disconnect device. Ensure that the AC outlet is installed near the product and is easily accessible.

## Important Information

- This product is unable to make calls when:
  - the handset batteries need recharging or have failed.
  - there is a power failure.

### Battery

- We recommend using the batteries noted on page 4. **USE ONLY rechargeable Ni-MH batteries AAA (R03) size.**
- Do not mix old and new batteries.
- Do not open or mutilate the batteries. Released electrolyte from the batteries is corrosive and may cause burns or injury to the eyes or skin. The electrolyte is toxic and may be harmful if swallowed.
- Exercise care when handling the batteries. Do not allow conductive materials such as rings, bracelets, or keys to touch the batteries, otherwise a short circuit may cause the batteries and/or the conductive material to overheat and cause burns.
- Charge the batteries provided with or identified for use with this product only, in accordance with the instructions and limitations specified in this manual.
- Only use a compatible base unit (or charger) to charge the batteries. Do not tamper with the base unit (or charger). Failure to follow these instructions may cause the batteries to swell or explode.

#### Attention:



A nickel metal hydride battery that is recyclable powers the product you have purchased. Please call 1-800-8-BATTERY (1-800-822-8837) for information on how to recycle this battery.

## Important safety instructions

When using your product, basic safety precautions should always be followed to reduce the risk of fire, electric shock, and injury to persons, including the following:

1. Do not use this product near water for example, near a bathtub, washbowl, kitchen sink, or laundry tub, in a wet basement or near a swimming pool.
2. Avoid using a telephone (other than a cordless type) during an electrical storm. There may be a remote risk of electric shock from lightning.
3. Do not use the telephone to report a gas leak in the vicinity of the leak.
4. Use only the power cord and batteries indicated in this manual. Do not dispose of batteries in a fire. They may explode. Check with local codes for possible special disposal instructions.

#### SAVE THESE INSTRUCTIONS

## For best performance

### Base unit location/avoiding noise

The base unit and other compatible Panasonic units use radio waves to communicate with each other.

- For maximum coverage and noise-free communications, place your base unit:
  - at a convenient, high, and central location with no obstructions between the handset and base unit in an indoor environment.
  - away from electronic appliances such as TVs, radios, personal computers, wireless devices, or other phones.
  - facing away from radio frequency transmitters, such as external antennas of mobile phone cell stations. (Avoid putting the base unit on a bay window or near a window.)
- Coverage and voice quality depends on the local environmental conditions.

## Important Information

- If the reception for a base unit location is not satisfactory, move the base unit to another location for better reception.

### Environment

- Keep the product away from electrical noise generating devices, such as fluorescent lamps and motors.
- The product should be kept free from excessive smoke, dust, high temperature, and vibration.
- The product should not be exposed to direct sunlight.
- Do not place heavy objects on top of the product.
- When you leave the product unused for a long period of time, unplug the product from the power outlet.
- The product should be kept away from heat sources such as heating devices, cooking appliances, etc. It should not be placed in rooms where the temperature is less than 0 °C (32 °F) or greater than 40 °C (104 °F). Damp basements should also be avoided.
- The maximum calling distance may be shortened when the product is used in the following places: Near obstacles such as hills, tunnels, underground, near metal objects such as wire fences, etc.
- Operating the product near electrical appliances may cause interference. Move away from the electrical appliances.

### Routine care

- **Wipe the outer surface of the product with a soft moist cloth.**
- Do not use benzine, thinner, or any abrasive powder.

### Other information

**CAUTION:** Risk of explosion if battery is replaced by an incorrect type. Dispose of used batteries according to the instructions.

### Notice for product disposal, transfer, or return

- This product can store your private/confidential information. To protect your privacy/confidentiality, we recommend that you erase information such as phonebook or caller list entries from the memory before you dispose of, transfer, or return the product.

### Notice

- This product is designed for use in the United States of America. Sale or use of this product in other countries may violate local laws.
- Cet appareil est conçu pour être utilisé aux États-Unis d'Amérique. La vente ou l'emploi de cet appareil dans certains autres pays peut constituer une infraction à la législation locale.
- Este producto está diseñado para usarse en los Estados Unidos de América. La venta o el empleo de este producto en ciertos países puede constituir violación de la legislación local.
- 本產品專為美國使用而設。若在其他國家銷售或使用，可能會違反當地法例。
- この製品は、日本国外での使用を目的として設計されており、日本国内での使用は法律違反となります。従って、当社では日本国内においては原則として修理などのサービスは致しかねます。



## Specifications

- **Standard:**  
DECT 6.0 (Digital Enhanced Cordless  
Telecommunications 6.0)
- **Frequency range:**  
1.92 GHz to 1.93 GHz
- **RF transmission power:**  
115 mW (max.)
- **Power source:**  
120 V AC, 60 Hz
- **Power consumption:**  
**Base unit:**  
Standby: Approx. 1.0 W  
Maximum: Approx. 4.3 W  
**Charger:**  
Standby: Approx. 0.1 W  
Maximum: Approx. 1.8 W
- **Operating conditions:**  
0 °C – 40 °C (32 °F – 104 °F), 20 % – 80 %  
relative air humidity (dry)

## Getting Started

### Setting up

#### Connections

##### ■ Base unit

- ① Connect the AC adaptor to the unit by pressing the plug firmly.
- ② Fasten the cord by hooking it.
- ③ Connect the AC adaptor to the power outlet.
- ④ Connect the telephone line cord to the unit, then to the single-line telephone jack (RJ11C) until you hear a click.
- ⑤ A DSL/ADSL filter (not supplied) is required if you have a DSL/ADSL service.

##### Note:

- Use only the supplied Panasonic AC adaptor PNLV226.

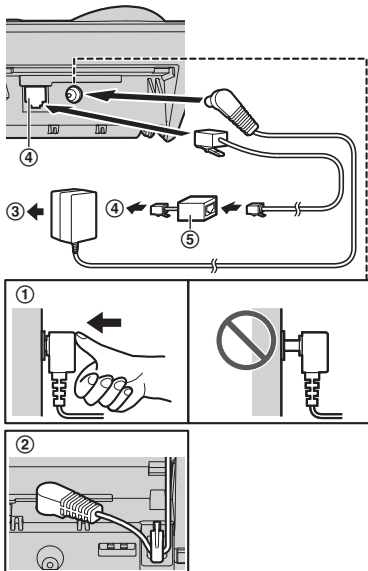

##### ■ Charger

- ① Connect the AC adaptor to the power outlet.

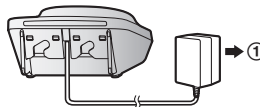

#### Battery installation

- USE ONLY rechargeable Ni-MH batteries AAA (R03) size (A).
- Do NOT use alkaline/manganese/Ni-Cd batteries.
- Confirm correct polarities (+, -).

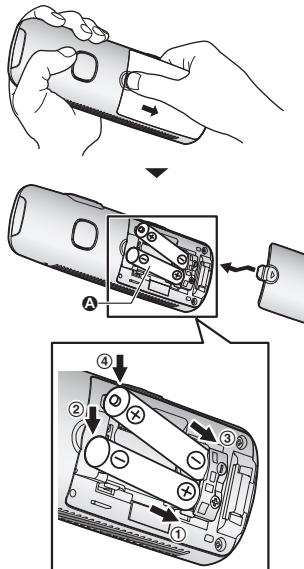

- Follow the directions on the display to set up the unit.

### Removing the battery

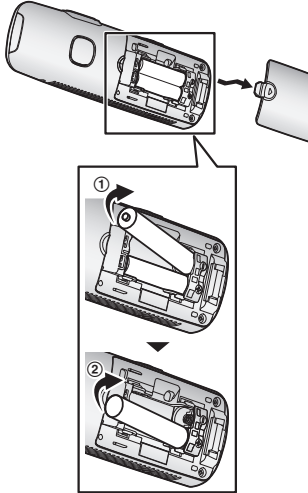

### Battery charging

Charge for about 7 hours.

- Confirm “Charging” is displayed (A).
- When the batteries are fully charged, “Fully charged” is displayed.

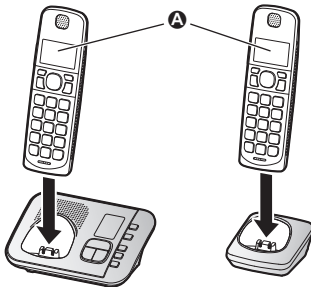

### Note when setting up

#### Note for connections

- The AC adaptor must remain connected at all times. (It is normal for the adaptor to feel warm during use.)
- The AC adaptor should be connected to a vertically oriented or floor-mounted AC outlet. Do not connect the AC adaptor to a horizontally oriented AC outlet that faces the floor, such as an AC outlet installed on a ceiling or under a table, as the weight of the adaptor may cause it to become disconnected.

#### Note for battery installation

- Use the supplied rechargeable batteries. For replacement, we recommend using the Panasonic rechargeable batteries noted on page 4, 7.

#### Note for battery charging

- It is normal for the handset to feel warm during charging.
- Clean the charge contacts of the handset, base unit, and charger with a soft and dry cloth once a month. Before cleaning the unit, disconnect from power outlets and any telephone line cords. Clean more often if the unit is exposed to grease, dust, or high humidity.

### Battery level

| Icon | Battery level   |
|------|-----------------|
|      | High            |
|      | Medium          |
|      | Low             |
|      | Needs charging. |
|      | Empty           |

#### Note:

- At the end of each call, the unit displays a large icon for a few moments to indicate the battery level.

## Getting Started

- You can set the unit to play a voice announcement when the battery is low or needs charging (page 15).

### Ni-MH battery performance (supplied batteries)

| Operation            | Operating time  |
|----------------------|-----------------|
| In continuous use    | 12 hours max.*1 |
| Not in use (standby) | 6 days max.*1   |

\*1 If eco mode is on.

#### Note:

- Actual battery performance depends on usage and ambient environment.

### Intelligent eco mode

This feature automatically reduces handset power consumption by suppressing handset transmission power when the handset is close to the base unit.

- When this feature is activated, **ECO** is displayed.

## Controls

### Handset

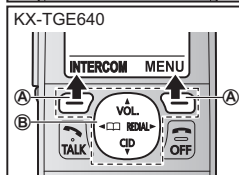
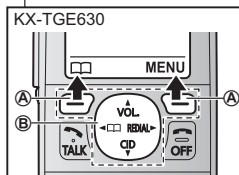
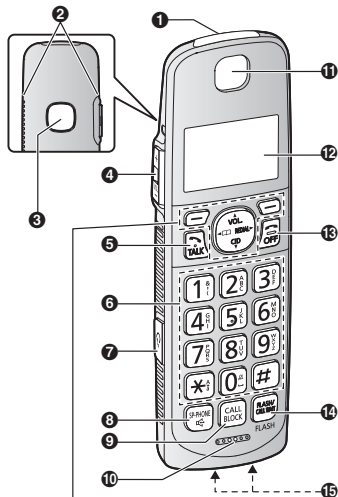

- 1 Ringer indicator
- Message indicator
- 2 Belt clip holes
- 3 Speaker
- 4 **[+]/[-]** (VOL.: Volume up/down)
- 5 **[↶]** (TALK)
- 6 Dial keypad
- 7 Headset jack
- 8 **[☎]** (SP-PHONE: Speakerphone)
- 9 **[CALL BLOCK]**
- 10 Microphone
- 11 Receiver
- 12 Display
- 13 **[OFF]** (MUTE)
- 14 **[FLASH][CALL WAIT]**
- 15 Charge contacts

### ■ Control type

#### A Soft keys

By pressing a soft key, you can select the feature shown directly above it on the display.

#### B Navigator key

- **[▲]**, **[▼]**, **[◀]**, or **[▶]**: Scroll through various lists and items.
- VOL. (Volume: **[▲]** or **[▼]**): Adjust the receiver or speaker volume while talking.
- **[◀]** **[☎]**: View the phonebook entry.
- **[▶]** **[RECALL]**: View the redial list.
- **[▼]** **[CID]** (Caller ID): View the caller list.

### Base unit

#### ■ KX-TGE630 series: page 3

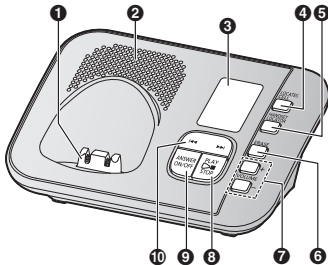

- 1 Charge contacts
- 2 Speaker
- 3 Message counter
- 4 **[LOCATES CELL]**
- 5 **[HANDSET LOCATOR]**
- 6 **[ERASE]**
- 7 **[+]/[-]** (VOL.: Volume up/down)
- 8 **[▶/■]** (PLAY/STOP)
- Message indicator
- 9 **[ANSWER ON/OFF]**
- 10 **[◀◀]** (Repeat)
- [▶▶]** (Skip)

#### ■ KX-TGE640 series: page 3

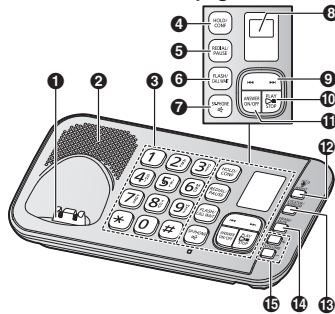

- 1 Charge contacts
- 2 Speaker
- 3 **[HOLD]** **[CONF]**
- 4 **[RECALL]** **[PAUSE]**
- 5 **[FLASH]** **[CALL WAIT]**
- 6 **[☎]** (SP-PHONE: Speakerphone)
- SP-PHONE indicator
- 7 Message counter
- 8 **[▶/■]** (PLAY/STOP)
- Message indicator
- 9 **[ANSWER ON/OFF]**
- 10 **[LOCATES CELL]**
- 11 **[LOCATOR]** **[INTERCOM]**
- 12 **[+]/[-]** (VOL.: Volume up/down)
- 13 **[ERASE]** **[MUTE]**
- 14 **[▶▶]** (Skip)
- 15 **[◀◀]** (Repeat)
- 16 Microphone
- 17 Dial keypad (TONE)

## Getting Started

### Display icons

#### Handset display items

| Item         | Meaning   |
|--------------|---|
|              | Within base unit range  |
|              | Out of base unit range  |
|              | The line is in use. <ul style="list-style-type: none"> <li>When flashing: The call is put on hold.</li> <li>When flashing rapidly: An incoming call is now being received.</li> </ul> |
| <b>ECO</b>   | Eco mode is on. (page 12)   |
| <b>NR</b>    | Noise reduction is set. (page 18)   |
| <b>EQ</b>    | Equalizer is set. (page 18)   |
|              | Speakerphone is on. (page 16)   |
|              | Ringer volume is off. (page 17, 32)   |
| <b>Zzz</b>   | Silent mode is on. (page 37)  |
| <b>PRIV.</b> | Call sharing mode is off. (page 34)   |
|              | Alarm is on. (page 37)  |
| <b>1</b>     | Handset number  |
|              | Battery level   |
|              | Blocked call (page 23)  |
|              | Automated callers block is set to "Block". (page 25)  |
|              | Baby monitor is activated. The name/number displayed next to the icon indicates the monitoring unit. (page 38)  |
| In use       | Answering system is being used by another unit.   |
| Line in use  | Someone is using the line.  |

#### Base unit display item

| Item | Meaning  |
|------|--|
|      | "Greeting only" is selected. Caller messages are not recorded. (page 49) |

### Language settings

#### Display language

- [MENU]#1110**
- [↑]**: Select the desired setting. → **[SAVE]** → **[OFF]**

#### Note:

- The language selected will also be used for the low battery alert announcement (page 15).

#### Voice announcement language

You can select the language used for the following features.

- Answering system guidance
- Talking Caller ID

- [MENU]#1112**
- [↑]**: Select the desired setting. → **[SAVE]** → **[OFF]**

#### Date and time

- [MENU]#101**
- Enter the current month, date, and year by selecting 2 digits for each.  
**Example:** July 12, 2018  
**07 12 18**
- [OK]**
- Enter the current hour and minute (12-hour clock format) by selecting 2 digits for each.  
**Example:** 9:30  
**09 30**
- [X]**: Select "AM" or "PM".

### 6 [SAVE] → [OFF]

**Note:**

- When English is selected as the display language, 12-hour clock format is used. When Spanish is selected, 24-hour clock format is used.

## Recording your greeting message

You can record your own greeting message instead of using a pre-recorded greeting message. See page 44 for details.

- 1 [MENU]#302
- 2 [↕]: “Yes” → [SELECT]
- 3 Record a greeting message. → [STOP] → [OFF]

## Other settings

### Dialing mode

If you cannot make calls, change this setting according to your telephone line service. The default setting is “Tone”.

“Tone”: For tone dial service.

“Pulse”: For rotary/pulse dial service.

- 1 [MENU]#120
- 2 [↕]: Select the desired setting. → [SAVE] → [OFF]

### Low battery alert

This feature plays a voice announcement when the battery is low or needs charging. When this feature is turned on, the unit notifies you as follows.

- **When you end a call:**
  - The unit plays a voice announcement when the battery is low or needs charging.

- **When the handset is in standby mode:**

- If the battery is low or needs charging, the unit plays a voice announcement at the selected interval up to 3 times.

**Note for handset:**

- At the end of each call, the unit displays a large icon for a few moments to indicate the battery level.

### Setting low battery alert

To turn this feature on, select the desired announcement interval, or select “OFF” to turn this feature off. The default setting is “Every hour”.

**Handset**

- 1 [MENU]#176
- 2 [↕]: Select the desired setting. → [SAVE] → [OFF]

## Making/Answering Calls

### Making calls

#### Using the handset

- 1 Lift the handset and then dial the phone number.
  - To correct a digit, press **[CLEAR]**.
- 2 Press **[📞]** to make the call.
  - To make the call using the speakerphone, press **[📞]**.
- 3 When you finish talking, press **[OFF]** or place the handset on the base unit or charger.

#### Note:

- To switch to the speaker, press **[📞]**.  
To switch back to the receiver, press **[📞]/[📞]**.
- In step 1, you can store the dialed phone number to the phonebook by pressing **[SAVE]**.

#### Making a call using the redial list

The last 5 phone numbers dialed are stored in the redial list (48 digits max. each).

- 1 **[▶]** REDIAL
- 2 **[↕]**: Select the desired entry.
- 3 **[📞]**

#### Erasing a number in the redial list

- 1 **[▶]** REDIAL
- 2 **[↕]**: Select the desired entry. → **[ERASE]**
- 3 **[↕]**: "Yes" → **[SELECT]** → **[OFF]**

#### Using the base unit

Available for:  
KX-TGE640 series (page 3)

- 1 **[📞]**
- 2 Dial the phone number.
- 3 When the other party answers, speak into the microphone.

- 4 When you finish talking, press **[📞]**.

#### Note:

- While on a call, you can switch from the base unit to the handset:
  - Press **[📞]** on the handset, then press **[📞]** on the base unit with the call sharing mode on (page 34).
  - If the handset is on the base unit, simply lift it.

#### Redialing the last number dialed

**[📞]** → **[REDIAL]**

#### Adjusting the receiver or speaker volume

##### Handset / Base unit\*1

\*1 KX-TGE640 series: page 3

Press **[+]** or **[-]** repeatedly while talking.

#### Pause (for PBX/long distance service users)

A pause is sometimes required when making calls using a PBX or long distance service. When storing a calling card access number and/or PIN in the phonebook, a pause is also needed (page 28).

**Example:** If you need to dial the line access number "9" when making outside calls with a PBX:

##### Handset

- 1 **[📞]** → **[▲]** (Pause)
- 2 Dial the phone number. → **[📞]**

##### Base unit\*1

\*1 KX-TGE640 series: page 3

- 1 **[📞]**
- 2 **[📞]** → **[PAUSE]**
- 3 Dial the phone number.

#### Note for handset and base unit:



- A 3.5 second pause is inserted each time you press **[▲]** (Pause) on the handset or **[PAUSE]** on the base unit.



### Answering calls

#### Using the handset

When a call is being received, the ringer indicator flashes rapidly.

- 1 Lift the handset and then press [  ] or [  ] when the unit rings.
- 2 When you finish talking, press [OFF] or place the handset on the base unit or charger.

**Any key answer:** You can answer the call by pressing any dial key.



**Auto talk:** You can answer calls simply by lifting the handset (page 34).

**Temporary handset ringer off:** You can turn the ringer off temporarily by pressing [  ].

#### Using the base unit



**Available for:**  
KX-TGE640 series (page 3)

When a call is being received, the SP-PHONE indicator flashes rapidly.

- 1 Press [  ] when the unit rings.
- 2 Speak into the microphone.
- 3 When you finish talking, press [  ].



#### Adjusting the ringer volume

##### Handset

Press [  ] or [  ] repeatedly to select the desired volume.

- To turn the ringer off, press [  ] repeatedly.

##### Base unit

Press [  ] or [  ] repeatedly to select the desired volume.

- To turn the ringer off, press and hold [  ] until the unit beeps.

#### One-touch ringer off for the handset





Press and hold [  ] until the unit beeps to turn the ringer off. While the ringer is turned off, the handset will not ring for calls.

- You can turn the ringer on again by pressing and holding [  ] until the unit beeps.

### Useful features during a call



#### Hold

##### Handset

- 1 Press [MENU] during an outside call.
- 2 [  ]: "Hold" → [SELECT]
- 3 To release hold, press [  ].
  - Another handset user can take the call by pressing [  ].
  - The base unit user can take the call by pressing [  ]. (KX-TGE640 series: page 3)

##### Base unit\*1

\*1 KX-TGE640 series: page 3

- 1 Press [HOLD] during an outside call.
- 2 To release hold, press [  ].
  - A handset user can take the call by pressing [  ].

#### Note for handset and base unit:

- While an outside call is on hold, the SP-PHONE indicator on the base unit flashes.
- After holding for 10 minutes, the call is disconnected.

#### Mute

##### Handset

- 1 Press [MUTE] during a call.
- 2 To return to the call, press [MUTE].

## Making/Answering Calls

### Note:

- **[MUTE]** is a soft key visible on the display during a call.

### Base unit\*1

\*1 KX-TGE640 series: page 3

- 1 Press **[MUTE]** during a call.
  - The SP-PHONE indicator flashes.
- 2 To return to the call, press **[MUTE]**.

## Flash

### Handset / Base unit\*1

\*1 KX-TGE640 series: page 3

**[FLASH]** allows you to use the special features of your host PBX such as transferring an extension call, or accessing optional telephone services.

### Note:

- To change the flash time, see page 34.

## For call waiting or Call Waiting Caller ID service users

To use call waiting or Call Waiting Caller ID, you must first subscribe with your phone service provider.

This feature allows you to receive calls while you are already talking on the phone. If you receive a call while on the phone, you will hear a call waiting tone.

If you subscribe to both Caller ID and Call Waiting with Caller ID services, the 2nd caller's information is displayed on the unit that is in use after you hear the call waiting tone.

### Handset / Base unit\*1

\*1 KX-TGE640 series: page 3

- 1 Press **[CALL WAIT]** to answer the 2nd call.
- 2 To switch between calls, press **[CALL WAIT]**.

### Note:

- Please contact your phone service provider for details and availability of this service in your area.

## Temporary tone dialing (for rotary/pulse service users)

### Handset / Base unit\*1

\*1 KX-TGE640 series: page 3

Press **[X]** before entering access numbers which require tone dialing.

## Handset noise reduction

This feature allows you to hear the voice of the person you are talking to more clearly, by reducing the surrounding noise coming from the other party's telephone.

- 1 Press **[MENU]** while talking.
- 2 **[↕]**: "Noise reduction on" or "Noise reduction off" → **[SELECT]**

### Note:

- Depending on the environment where this handset is being used, this feature may not be effective.
- This feature is not available while using the speakerphone.

## Handset equalizer

This feature clarifies the voice of the person you are talking to, producing a more natural-sounding voice that is easier to hear and understand.

- 1 Press **[MENU]** while talking.
- 2 **[↕]**: "Equalizer" → **[SELECT]**
- 3 **[↕]**: Select the desired setting.
- 4 Press **[OK]** to exit.

### Note:

- Depending on the condition and quality of your telephone line, this feature may emphasize existing line noise. If it becomes difficult to hear, turn this feature off.

## Making/Answering Calls

- This feature is not available while using the speakerphone.
- When both the “Equalizer” setting and noise reduction are activated, **NR** is shown on the display.

### Call share

You can join an existing outside call.

#### Handset

To join the conversation, press [📞] when the other unit is on an outside call.

#### Base unit\*1

\*1 KX-TGE640 series: page 3

To join the conversation, press [📞] when the handset is on an outside call.

#### Note for handset and base unit:

- A maximum of 3 parties (including 1 outside party) can join a conversation using 2 extensions. **(3-way conference)**
- To prevent other users from joining your conversations with outside callers, turn call sharing mode off (page 34).

### Transferring calls, conference calls

Outside calls can be transferred or a conference call with an outside party can be made:

- between handsets
- between a handset and the base unit\*1

\*1 KX-TGE640 series: page 3

#### Handset

- 1 During an outside call, press [MENU].
- 2 [📞]: “Intercom” → [SELECT]
- 3 [📞]: Select the desired unit. → [SELECT]
  - If you select “Voice paging”, the call will be switched from the ear-receiver mode to the speakerphone mode.
- 4 Wait for the paged party to answer.
  - If the paged party does not answer, press [BACK] to return to the outside call.

### 5 To complete the transfer:

Press [OFF].

**To establish a conference call:**

[MENU] → [📞]: “Conference” →

[SELECT]

- To leave the conference, press [OFF]. The other 2 parties can continue the conversation.
- To put the outside call on hold: [MENU] → [📞]: “Hold” → [SELECT]  
To resume the conference: [MENU] → [📞]: “Conference” → [SELECT]
- To cancel the conference: [MENU] → [📞]: “Stop conference” → [SELECT]

You can continue the conversation with the outside caller.

#### Note:

- In step 3, you can also use [📞] or [📞] after selecting the unit.

#### Base unit\*1

\*1 KX-TGE640 series: page 3

- 1 During an outside call, press [INTERCOM].  
**When 2 or more handsets are registered:**
  - To page a specific handset, enter the handset number.
  - To page all handsets, press [0] or wait for a few seconds.
- 2 Wait for the paged party to answer.
  - If paged party does not answer, press [INTERCOM] to return to the outside call.
- 3 **To complete the transfer:**  
Press [📞].
  - The outside call is being routed to the handset.**To establish a conference call:**  
Press [CONF].
  - To leave the conference, press [📞]. The other 2 parties can continue the conversation.
  - To put the outside call on hold, press [HOLD]. To resume the conference, press [CONF].

## Making/Answering Calls

### Handset locator

You can locate a misplaced handset by paging it.

- 1 Base unit:** Press **[LOCATOR]** or **[HANDSET LOCATOR]**.
  - All registered handsets beep for 1 minute.
- 2 To stop paging:**  
**Base unit:**  
Press **[LOCATOR]** or **[HANDSET LOCATOR]**.  
**Handset:**
  - **KX-TGE630 series: page 3**  
Press **[OFF]**.
  - **KX-TGE640 series: page 3**  
Press **[↶]**, then press **[OFF]**.

### Cell locator

This feature allows you to locate a misplaced cellular phone by pressing the **[LOCATES CELL]** button on the base unit and calling your cellular phone. You must assign your cellular phone's phone number to the button beforehand. Only 1 cellular phone number (24 digits max.) can be assigned.

### Adding a phone number

- 1 [MENU]# [2] [4] [8]**
  - If you have already stored a cellular phone number, the current number is displayed.
- 2 Enter your cellular phone number. → [SAVE] → [OFF]**

### Erasing the number

- 1 [MENU]# [2] [4] [8]**
- 2 Press and hold [CLEAR] until all digits are erased. → [SAVE] → [OFF]**

### Calling the misplaced cellular phone

#### Base unit: [LOCATES CELL]

- To stop calling:
  - KX-TGE630 series: press **[LOCATES CELL]** again.
  - KX-TGE640 series: press **[↶]**.

#### Important:

- While the base unit is calling the cellular phone, the outside line is used.
  - KX-TGE630 series: Even if the cellular phone answers, you cannot talk with the cellular phone and the base unit beeps for 1 minute. To end the call, press **[LOCATES CELL]** on the base unit.
  - KX-TGE640 series: When the cellular phone answers, you can talk with the cellular phone. To end the call, press **[↶]** on the base unit.

Charges may be incurred if the cellular phone answers the call.

### Intercom

Intercom calls can be made:

- between handsets
  - between a handset and the base unit\*1
- \*1 KX-TGE640 series: page 3

#### Note:

- When paging unit(s), the paged unit(s) beeps for 1 minute.
- If you receive an outside call while talking on the intercom, the interrupt tone sounds.
  - **Handset:** To finish intercom, press **[OFF]**. To answer the call, press **[↶]**.
  - **Base unit:** To finish intercom, press **[↶]**. To answer the call, press **[↶]** again.
- To change the handset ringer volume and ringer tone for intercom, see page 32.

### Making an intercom call

#### Handset

- 1 [MENU] → [↕]: "Intercom" → [SELECT]**

- 2** [**↕**]: Select the desired unit or “Voice paging”. → [**SELECT**]
- If you select “Voice paging”, speak into the microphone after the beep. Your voice will be heard using the speakers of the base unit\*1 and all handsets, until a paged party answers your page or until you press [**OFF**]. After the other party answers, the speakerphone mode is turned on.
- 3** When you finish talking, press [**OFF**].
- \*1 KX-TGE640 series: page 3

### Note:

- You can also use the [**INTERCOM**] soft key, if displayed, to make intercom calls.
- You cannot use voice paging if other units are in use.
- Voice paging is not available when a range extender (KX-TGA407) is registered to the base unit.

### Base unit\*1

\*1 KX-TGE640 series: page 3

- 1** Press [**INTERCOM**].  
**When 2 or more handsets are registered:**
- To page a specific handset, enter the handset number.
  - To page all handsets, press [0] or wait for a few seconds.
- 2** When you finish talking, press [**↕**].

## Answering an intercom call

### Handset

- 1** Press [**↶**] to answer the page.
- 2** When you finish talking, press [**OFF**].

### Base unit\*1

\*1 KX-TGE640 series: page 3

- 1** Press [**↶**] to answer the page.
- 2** When you finish talking, press [**↕**].

## Turning auto intercom on/off

This feature allows the handset or base unit to answer intercom calls automatically when it is called. You do not need to press [**↶**] or [**↕**]. When this feature is set to “On”, the monitoring handset or base unit for the baby monitor feature (page 40) will also answer baby monitor calls automatically. The default setting is “Off”.

- 1** For handset setting: [**MENU**]# [2] [7] [3]  
For base unit setting (using a handset)\*1: [**MENU**]# [X] [2] [7] [3]

- 2** [**↕**]: Select the desired setting. → [**SAVE**] → [**OFF**]

\*1 KX-TGE640 series: page 3



### Note:

- This feature is not available for all handsets paging and voice paging even if it is turned on.

## Power backup operation

When a power failure occurs, the charged handset temporarily supplies power to the base unit (power backup mode). This allows you to make and receive calls using a handset during a power failure. The base unit will not perform any other functions. However, some functions such as Caller ID and phonebook are available only when using a handset other than the handset supplying power to the base unit. You can program “Power failure” and the default setting is “Auto” (page 35).

### Important:

- If a handset is not placed on the base unit when a power failure occurs, “Power outage Press OFF” is displayed. After pressing [**OFF**] on the handset, place it on the base unit to start power backup mode.
- Power backup mode will not work if the battery level of the power supplying handset is  or .
- Do not lift the power supplying handset from the base unit during power backup mode.

## Making/Answering Calls

### Ni-MH battery performance (supplied batteries) during power backup mode

When the batteries are fully charged, operating time of the handset in power backup mode varies depending on usage.

- Continuous use of the handset in power backup mode: 1.5 hours max.
- Continuous use of the handset other than a handset in power backup mode: 2 hours max.
- Not in use in power backup mode: 2 hours max.

### Making calls during a power failure

#### ■ When only 1 handset is registered:

- 1 Lift the handset and dial the phone number.
- 2 Within 1 minute, place the handset on the base unit.
  - Wait until speakerphone is turned on automatically and the call is made.
- 3 When the other party answers the call, keep the handset on the base unit and talk using the speakerphone.
- 4 When you finish talking, press **[OFF]**.

#### ■ When 2 or more handsets are registered:

You should leave one handset on the base unit for supplying the power, and use another handset for making calls.

#### Note:

- The range of the base unit is limited during a power failure. Please use the handset close to the base unit.

### Making a call using the redial list

#### ■ When only 1 handset is registered:

- 1 Lift the handset.
- 2 **[>]** REDIAL
- 3 **[↓]**: Select the desired entry.

- 4 Within 1 minute, place the handset on the base unit.

- Wait until speakerphone is turned on automatically and the call is made.

#### ■ When 2 or more handsets are registered:

You should leave one handset on the base unit for supplying the power, and use another handset for making calls.

### Making a call using the phonebook

**There must be at least 2 handsets registered to the base unit in order for the phonebook feature to be used during a power failure.**

You should leave one handset on the base unit for supplying the power, and use another handset for making calls.

### Answering calls during a power failure

#### ■ When only 1 handset is registered:

- 1 When the unit rings, keep the handset on the base unit and press **[📞]** or **[📞]**.
  - Speakerphone is turned on.
- 2 When you finish talking, press **[OFF]**.

#### ■ When 2 or more handsets are registered:

When the unit rings, use a handset which is not supplying power to the base unit.

- Do not use or lift the handset which is placed on the base unit during power backup mode.

#### Note:

- The range of the base unit is limited during a power failure. Please use the handset close to the base unit.

## Call block

You can press the **[CALL BLOCK]** button in the following situations to disconnect the current call and add a phone number to the call block list:

- when an incoming call is being received
- when an incoming call is being recorded by the answering system
- when talking on an outside call

Once a phone number has been added to the call block list, the unit will block calls from that phone number in the future.

- 1 Press **[CALL BLOCK]** under the situations shown above.
- 2 Confirm the call block number and press **[YES]**.
  - The call block number is stored in the call block list, "Caller blocked" is displayed, and then the call is disconnected.

### Note:

- If the call has no phone number, the call is blocked but it is not stored in the call block list.
- The call block feature is not available for intercom calls or calls received by call waiting.
- Blocked calls are logged in the caller list.

## Storing unwanted callers

The unit can block calls by storing the desired items in the call block list beforehand (Caller ID subscribers only).

- "Block a single number": The unit blocks calls from specific phone numbers stored in the call block list.
- "Block range of numbers": The unit blocks calls that begin with a number stored in the call block list, such as a toll-free phone number prefix or certain area codes.
- "Block unknown CID": The unit blocks calls that have no phone number.

Single phone numbers and ranges of numbers can be stored in the call block list up to 1000 items in total.

### Blocking unwanted callers:

When a call is received, the unit rings once<sup>\*1</sup> while caller information is being received.

If the caller's phone number matches an entry in the call block list, the unit emits no sound to the caller, and disconnects the call.

- \*1 If you do not want this one ring to sound, select "No" in "Turning the first ring on/off" (page 24).

## Storing a single phone number

### Important:

- We recommend storing 10 digits (including the area code). If only 7 digits are stored, all numbers that have the same last 7 digits will be blocked.

## Adding call blocked numbers from the caller list

- 1 **[▼]** CID
- 2 **[↕]**: Select the desired entry to be blocked.
  - To edit the number: **[MENU]** → **[↕]**: "Edit" → **[SELECT]**  
Press **[EDIT]** repeatedly until the phone number is shown in the 10-digit format. → **[SAVE]** → **[↕]**: "Call block" → **[SELECT]** → Go to step 4.
- 3 **[CALL BLOCK]**
- 4 **[↕]**: "Yes" → **[SELECT]**
- 5 Edit the phone number if necessary (24 digits max.). → **[SAVE]** → **[OFF]**

## Adding call blocked numbers manually

- 1 **[CALL BLOCK]**
- 2 **[↕]**: "Block a single number" → **[SELECT]**
- 3 **[MENU]** → **[↕]**: "Add" → **[SELECT]**
- 4 Enter the phone number (24 digits max.). → **[SAVE]** → **[OFF]**

## Call Block

### Storing a range of number

- 1 [CALL BLOCK]
- 2 [↕]: "Block range of numbers" → [SELECT]
- 3 [MENU] → [↕]: "Add" → [SELECT]
- 4 Enter the desired number (2-8 digits). → [SAVE] → [OFF]

### Blocking incoming calls that have no phone number

You can block calls when no phone number is provided, such as private callers or out of area calls.

- 1 [CALL BLOCK]
- 2 [↕]: "Block unknown CID" → [SELECT]
- 3 [↕]: Select the desired setting. → [SAVE] → [OFF]

### Turning the first ring on/off

You can choose whether the first ring sounds when a call is received.

"Yes" (default): The first ring for all calls will be heard, including calls from blocked phone numbers.

"No": The first ring is muted for all calls. If this setting is selected, the unit will never ring for calls from blocked phone numbers.

- 1 [CALL BLOCK]
- 2 [↕]: "One ring for blocked call" → [SELECT]
- 3 [↕]: Select the desired setting. → [SAVE] → [OFF]

### Viewing/editing/erasing call block numbers

- 1 [CALL BLOCK]
- 2 [↕]: "Block a single number" or "Block range of numbers" → [SELECT]

- 3 [↕]: Select the desired entry.
  - After viewing, press [OFF] to exit.
- 4 To edit a number:  
[EDIT] → Edit the number. → [SAVE] → [OFF]  
To erase a number:  
[ERASE] → [↕]: "Yes" → [SELECT] → [OFF]

#### Note:

- When editing, press the desired dial key to add digits and press [CLEAR] to erase digits.

### Erasing all call block numbers

- 1 [CALL BLOCK]
- 2 [↕]: "Block a single number" or "Block range of numbers" → [SELECT]
- 3 [MENU] → [↕]: "Erase all" → [SELECT]
- 4 [↕]: "Yes" → [SELECT]
- 5 [↕]: "Yes" → [SELECT] → [OFF]

### Displaying and clearing blocked call counts

- 1 [MENU]#177
  - To exit, press [OFF].
- 2 [CLEAR]
- 3 [↕]: "Yes" → [SELECT] → [OFF]



### Automated callers block

In automated callers block function, the unit will screen the incoming calls before ringing for allowed calls or end the calls without ringing when the call is identified as robocalls, telemarketing calls or other undesirable calls. The unit will play the automated callers block greeting message and prompt the caller to enter an access code in order for the unit to identify whether the call is automated callers or not. You can set the unit to block or unblock mode. The default setting is “Unblock”.

#### Note:

- The unit connects the call without prompting having to enter access code in the following situation:
  - the caller's phone number matches an entry in the phonebook (page 27).
  - the caller's name matches an entry in the allow name list (page 25).
  - the caller's phone number is memorized as the white list (page 25).
- If the number is stored in the call block list (page 23), the unit disconnect the call without playing automated callers block greeting message.
- The automated callers block feature is not available during power backup operation (page 21).
- When the answering system answers a call from a caller which is not registered in the phonebook, allow name list or white list, the following operation will be delayed:
  - answering a call
  - remote turn on
  - toll saver
- When the unit receives a call from a caller which is not registered in the phonebook, allow name list or white list in the following situation, the unit shifts to standby mode:
  - when searching the phonebook, caller list, redial list, call block list, or allow name list
  - when programming
  - when using the answering system
  - when paging all handsets or base unit
- Blocked calls are logged in the caller list. We recommend you to check the caller list periodically. If necessary, register the

entry to the phonebook or allow name list to connect the call next time.

### White list

Once the caller enters the access code, the caller's phone number is memorized in the white list as unblocked number. White list callers are allowed to connect without access code during their next call. 100 items can be stored to the white list (22 digits max. each).

#### Note:

- When the white list memory is full, the latest call received will replace the old number stored in the list.
- White list will be erased when you change the access code (page 26).
- White lists will not be displayed to you.

### Setting the automated callers block

- 1 **[MENU]** **[#]** **[7]** **[8]** **[7]**
- 2 **[↕]**: Select the desired setting. → **[SAVE]** → **[OFF]**

### Storing allow name list

You can allow certain caller to pass through by storing the caller's name to the allow name list even if you only know the caller names but not their numbers. You can store up to 100 names (16 characters max). If the name stored in the allow name list matches the incoming Caller ID, the unit rings. Callers listed in the allow name list is not required to enter the access code.

### Adding allow name list from the caller list

- 1 **[▼]** CID
- 2 **[↕]**: Select the desired entry. → **[MENU]**
- 3 **[↕]**: “Save allow name” → **[SELECT]**

## Automated callers

### Viewing/erasing allow name list

- 1 [MENU]#794
- 2 [↕]: Select the desired entry.
  - After viewing, press [OFF] to exit.
- 3 [ERASE] → [↕]: "Yes" → [SELECT] → [OFF]

### Erasing all allow name list

- 1 [MENU]#794
- 2 [ERASE] → [↕]: "Yes" → [SELECT]
- 3 [↕]: "Yes" → [SELECT] → [OFF]

### Displaying and clearing blocked call counts

Total number of blocked calls (up to 65,000) will be displayed.

- 1 [MENU]#790
  - To exit, press [OFF].
- 2 [CLEAR]
- 3 [↕]: "Yes" → [SELECT] → [OFF]

### Changing the access code

If the unit answers the undesirable calls such robocall even though the automated callers block function is on, change the access code (3 digits max.). The default setting is "1".

- 1 [MENU]#789
- 2 [CLEAR]
- 3 Enter the new access code. → [SAVE] → [OFF]

### Automated callers block greeting message

When the unit answers a call, a greeting message is played to callers. You can use either:

- your own automated callers block greeting message
- an automated callers block pre-recorded greeting message

### Recording automated callers block greeting message

#### Important:

- Make sure that you recorded the access code in the greeting message.

- 1 [MENU]#791
- 2 [OK] → Check your access code.
- 3 After a beep sounds, hold the handset about 20 cm (8 inches) away and speak clearly into the microphone (2 minutes max.).
- 4 Press [STOP] to stop recording.
- 5 The unit will play the recorded automated callers block greeting message. → [YES] → [OFF]

### Resetting to automated callers block pre-recorded greeting message

This procedure will erase your automated callers block greeting message and use the pre-recorded one.

- 1 [MENU]#793
- 2 [YES] → [OFF]

### Playing back the automated callers block greeting message

- 1 [MENU]#792
- 2 To exit, press [OFF].

## Phonebook

You can add 100 names (16 characters max.) and phone numbers (24 digits max.) to the phonebook, and assign each phonebook entry to the desired group (page 27).

### Important:

- All entries can be shared by any registered handset.

## Adding phonebook entries

- 1 **[◀] □ → [MENU]**
- 2 **[↕]: "Add new entry" → [SELECT]**
- 3 Enter the party's name. → **[OK]**
- 4 Enter the party's phone number. → **[OK]**
- 5 **[↕]:** Select the desired group. → **[SELECT]** 2 times → **[OFF]**

### Note:

- In step 3, you can switch the language for entering characters.  
**[#] → [↕]:** Select the desired language. → **[OK]**

## Entering characters

Press the dial key that corresponds to the desired character. Press repeatedly to scroll through the available characters. The following operations are also available.

| Key            | Operation  |
|----------------|--|
| <b>[x]</b>     | Switch between the uppercase and lowercase (A ↔ a)   |
| <b>[◀] [▶]</b> | Move the cursor  |
| <b>[CLEAR]</b> | Erase the character or number <ul style="list-style-type: none"> <li>• To erase all, press and hold it.</li> </ul> |

- To enter another character that is located on the same dial key, first press **[▶]** to move the cursor to the next space.
- If you do not press any dial key within 2 seconds after entering a character, the

character is fixed and the cursor moves to the next space.

## Storing a redial list number to the phonebook

Phone numbers of up to 24 digits can be stored in the phonebook.

- 1 **[▶] REDIAL**
- 2 **[↕]:** Select the desired entry. → **[SAVE]**
- 3 To store the name, continue from step 3, "Editing entries", page 28.

### Note:

- The name stored in the phonebook will be reflected in the redial list after you make a call using that phonebook entry.

## Storing caller information to the phonebook

- 1 **[▼] CID**
- 2 **[↕]:** Select the desired entry. → **[MENU]**
  - To edit the number: **[↕]: "Edit" → [SELECT]**  
 Press **[EDIT]** repeatedly until the phone number is shown in the desired format. → **[SAVE] → [↕]:**  
 "Phonebook" → **[SELECT] → Go** to step 4.
- 3 **[↕]: "Save phonebook" → [SELECT]**
- 4 Continue from step 3, "Editing entries", page 28.

## Groups

Groups can help you find entries in the phonebook quickly and easily. You can change the names of groups assigned for phonebook entries ("Friends", "Family", etc.). By assigning different ringer tones for different groups of callers, you can identify who is calling (ringer ID), if you have subscribed to Caller ID service.

## Phonebook

### Changing group names/setting ringer ID

The default group name is "Group 1" to "Group 9".

- 1 [◀] □□ → [MENU]
- 2 [↕]: "Group" → [SELECT]
- 3 [↕]: Select the desired group. → [SELECT]
- 4 To change group names  
[↕]: "Group name" → [SELECT] → Edit the name (10 characters max.). → [SAVE]  
To set group ringer tone  
[↕]: Select the current setting of the group ringer tone. → [SELECT] → [↕]: Select the desired ringer tone. → [SAVE]
- 5 [OFF]

### Finding and calling from a phonebook entry

- 1 [◀] □□
- 2 To scroll through all entries  
[↕]: Select the desired entry.  
To search by first character
  - ① Press the dial key ([0] to [9], or [#]) which contains the character you are searching for.
  - ② [↕]: Scroll through the phonebook if necessary.To search by group
  - ① [GROUP]
  - ② [↕]: Select the desired group. → [SELECT]
  - ③ [↕]: Scroll through the phonebook if necessary.
- 3 [↶]

### Editing entries

- 1 Find the desired entry (page 28).
- 2 [MENU] → [↕]: "Edit" → [SELECT]
- 3 Edit the name if necessary. → [OK]
- 4 Edit the phone number if necessary. → [OK]

- 5 [↕]: Select the desired group (page 27). → [SELECT] 2 times → [OFF]

### Erasing entries

#### Erasing an entry

- 1 Find the desired entry (page 28).
- 2 [MENU] → [↕]: "Erase" → [SELECT]
- 3 [↕]: "Yes" → [SELECT] → [OFF]

#### Erasing all entries

- 1 [◀] □□ → [MENU]
- 2 [↕]: "Erase all" → [SELECT]
- 3 [↕]: "Yes" → [SELECT]
- 4 [↕]: "Yes" → [SELECT] → [OFF]

### Chain dial

This feature allows you to dial phone numbers in the phonebook while you are on a call. This feature can be used, for example, to dial a calling card access number or bank account PIN that you have stored in the phonebook, without having to dial manually.

- 1 During an outside call, press [◀] □□.
- 2 [↕]: Select the desired entry.
- 3 Press [↶] or [CALL] to dial the number.
  - To make the call using the speakerphone, press [☎].

#### Note:

- When storing a calling card access number and your PIN in the phonebook as one phonebook entry, press [▲] (Pause) to add pauses after the number and PIN as necessary (page 16).
- If you have rotary/pulse service, you need to press [☒] before pressing [◀] □□ in step 1 to change the dialing mode temporarily to tone. When adding entries to the phonebook, we recommend adding [☒] to the beginning of phone numbers you wish to chain dial (page 27).

## Speed dial

You can assign 1 phone number to each of the dial keys ([1] to [9]) on the handset.

### Adding phone numbers to speed dial keys

#### ■ By entering phone numbers:

- 1 Press and hold the desired speed dial key ([1] to [9]). → **[ADD]**
- 2 [↕]: “Manual” → **[SELECT]**
- 3 Enter the party’s name (16 characters max.). → **[OK]**
- 4 Enter the party’s phone number (24 digits max.). → **[OK]** → **[SELECT]** → **[OFF]**

#### ■ From the phonebook:

- 1 Press and hold the desired speed dial key ([1] to [9]). → **[ADD]**
- 2 [↕]: “Phonebook” → **[SELECT]**
- 3 [↕]: Select the desired entry. → **[SAVE]** → **[OFF]**

#### Note:

- If you edit a phonebook entry which is assigned to a speed dial key, the edited entry does not transfer to the speed dial key.

### Editing an entry

- 1 Press and hold the desired speed dial key ([1] to [9]). → **[MENU]**
- 2 [↕]: “Edit” → **[SELECT]**
- 3 Edit the name if necessary. → **[OK]**
- 4 Edit the phone number if necessary. → **[OK]** → **[SELECT]** → **[OFF]**

### Erasing an entry

- 1 Press and hold the desired speed dial key ([1] to [9]). → **[MENU]**
- 2 [↕]: “Erase” → **[SELECT]**
- 3 [↕]: “Yes” → **[SELECT]** → **[OFF]**

### Viewing an entry/Making a call

- 1 Press and hold the desired speed dial key ([1] to [9]).
- 2 To make a call, press [📞].

## Programming

### Menu list

To access the features, there are 2 methods.

#### ■ Scrolling through the display menus

- 1 **[MENU]**
- 2 Press **[▼]** or **[▲]** to select the desired main menu. → **[SELECT]**
- 3 Press **[▼]** or **[▲]** to select the desired item from the next sub-menus. → **[SELECT]**
- 4 Press **[▼]** or **[▲]** to select the desired setting. → **[SAVE]**

#### ■ Using the direct command code

- 1 **[MENU]** → Enter the desired code.  
Example: Press **[MENU][#][1][0][1]**.
- 2 Select the desired setting. → **[SAVE]**

#### Note:

- To exit the operation, press **[OFF]**.
- In the following table, < > indicates the default settings.
- In the following table,  indicates the reference page number.
- Display menu order and sub-menu may vary depending on your model.

### Display menu tree and direct command code table

Main menu:  "Phonebook"

| Operation                    | Code |  |
|------------------------------|------|---|
| Viewing the phonebook entry. | #280 | 28  |

Main menu:  "Caller list"

| Operation                | Code |  |
|--------------------------|------|---|
| Viewing the caller list. | #213 | 42  |

Main menu:  "Answering device"

| Sub-menu 1          | Sub-menu 2   | Settings | Code |  |
|---------------------|--|----------|------|---|
| Play new message    | –  | –        | #323 | 45  |
| Play all message    | –  | –        | #324 | 45  |
| Erase all message*1 | –  | –        | #325 | 46  |
| Greeting            | Record greeting*1                                  | –        | #302 | 44  |
|                     | Check greeting                                     | –        | #303 | 45  |
|                     | Pre-recorded*1<br>(Reset to pre-recorded greeting) | –        | #304 | 45  |

## Programming

| Sub-menu 1          | Sub-menu 2                         | Settings                             | Code  |  |
|---------------------|------------------------------------|--------------------------------------|-------|---|
| New message alert*1 | Outgoing call<br>– On/Off          | On<br><Off>                          | #338  | 46  |
|                     | Outgoing call<br>– Notification to | –                                    |       |   |
|                     | Outgoing call<br>– Remote code     | Activate<br><Inactivate>             |       |   |
|                     | Base unit beep                     | On<br><Off>                          | #339  | 46  |
| Settings            | Ring count*1                       | Toll saver<br>2-7 rings<br><4 rings> | #211  | 49  |
|                     | Recording time*1                   | <3 min><br>1 min<br>Greeting only*2  | #305  | 49  |
|                     | Remote code*1                      | <111>                                | #306  | 48  |
|                     | Screen call<br>– Handset           | <On><br>Off                          | #310  | 49  |
|                     | Screen call<br>– Base unit*1, *3   | <On><br>Off                          | #*310 | 49  |
| Answer on*1         | –                                  | –                                    | #327  | 44  |
| Answer off*1        | –                                  | –                                    | #328  | 44  |

Main menu:  "Voicemail access"

| Operation                        | Code |  |
|----------------------------------|------|---|
| Listening to voicemail messages. | #330 | 51  |

Main menu:  "Intercom"

| Operation                | Code |  |
|--------------------------|------|--|
| Paging the desired unit. | #274 | 20   |

Main menu:  "Set date & time"

| Sub-menu 1            | Sub-menu 2 | Settings                         | Code |  |
|-----------------------|------------|----------------------------------|------|---|
| Date and time*1       | –          | –                                | #101 | 14  |
| Memo alarm            | Alarm1-3   | <Off><br>Once<br>Daily<br>Weekly | #720 | 37  |
| Time adjustment*1, *4 | –          | <Caller ID<br>auto><br>Manual    | #226 | –   |

## Programming

Main menu:  "Speed dial"

| Operation                     | Code |  |
|-------------------------------|------|---|
| Viewing the speed dial entry. | #261 | 29  |

Main menu:  "Settings"

| Sub-menu 1       | Sub-menu 2   | Settings                               | Code  |  |
|------------------|--|--|-------|---|
| Ring adjustments | Ringer volume (Incoming) (Handset)                 | Off-6 <6>                              | #160  | -   |
|                  | Intercom ringer volume (Handset)                   | 1-6 <6>                                | #175  | -   |
|                  | Ringer tone (Incoming) <sup>*5, *6</sup> (Handset) | <Tone 1>                               | #161  | -   |
|                  | Intercom ringer tone <sup>*5, *6</sup> (Handset)   | <Tone 3>                               | #163  | -   |
|                  | Silent mode - Handset                              | On/Off<br>- On<br>- <Off>              | #238  | 37  |
|                  |  | Start/End<br>- <11:00 PM/<br>06:00 AM> | #237  | 38  |
|                  |  | Select group<br>Group 1-9              | #241  | 38  |
|                  | Silent mode - Base unit <sup>*1, *3</sup>          | On/Off<br>- On<br>- <Off>              | #*238 | 37  |
|                  |  | Start/End<br>- <11:00 PM/<br>06:00 AM> | #*237 | 38  |
|                  |  | Select group<br>Group 1-9              | #*241 | 38  |
| Set date & time  | Date and time <sup>*1</sup>                        | -                                      | #101  | 14  |
|                  | Memo alarm - Alarm1-3                              | <Off><br>Once<br>Daily<br>Weekly       | #720  | 37  |
|                  | Time adjustment <sup>*1, *4</sup>                  | <Caller ID<br>auto><br>Manual          | #226  | -   |



## Programming

| Sub-menu 1  | Sub-menu 2                         | Settings  | Code   |  |      |    |
|---|------------------------------------|---|--|---|------|----|
| Talking caller ID   | Handset                            | <On><br>Off   | #162   | 42  |      |    |
|   | Base unit* <sup>1</sup>            | On<br><Off>   | #*162  |   |      |    |
| Low battery alert   | –                                  | Off<br>Every hour<br>Every 3 hours<br>Every 6 hours | #176   | 15  |      |    |
| Key detector setting* <sup>7</sup><br>– 1: Add new device (for Detector1) <sup>8</sup><br>– 2: Add new device (for Detector2)<br>– 3: Add new device (for Detector3)<br>– 4: Add new device (for Detector4) | Change name* <sup>1</sup>          | Detector1   | #6561  | –   |      |    |
|   |                                    | Detector2* <sup>9</sup>                             | #6562* <sup>9</sup>  |   |      |    |
|   |                                    | Detector3* <sup>9</sup>                             | #6563* <sup>9</sup>  |   |      |    |
|   |                                    | Detector4* <sup>9</sup>                             | #6564* <sup>9</sup>  |   |      |    |
|   | Registration                       | –   | #6571<br>#6572* <sup>9</sup><br>#6573* <sup>9</sup><br>#6574* <sup>9</sup> | –   |      |    |
|   |                                    | Deregistration                                      | –  | #6581<br>#6582* <sup>9</sup><br>#6583* <sup>9</sup><br>#6584* <sup>9</sup>        | –    |    |
|   |                                    |   | Block/Unblock  | –   | #787 | 25 |
|   |                                    |   | Allow name list  | –   | #794 | 25 |
|   | Access code                        |   | –  | #789  | 26   |    |
|   | Automated callers block greeting   | Record greeting                                     |  | #791  | 26   |    |
|   |                                    | Check greeting                                      |  | #792  | 26   |    |
|   |                                    | Pre-recorded  |  | #793  | 26   |    |
| Blocked calls count   |                                    | –   | #790   | 26  |      |    |
| Call block* <sup>1</sup>  | Block a single number              | –   | #217   | 23  |      |    |
|   | Block range of numbers             | –   |  | 24  |      |    |
|   | Block unknown CID (CID: Caller ID) | Block<br><Unblock>                                  | #240   | 24  |      |    |
|   | One ring for blocked call          | <Yes><br>No   | #173   | 24  |      |    |
|   | Blocked calls count                | –   | #177   | 24  |      |    |

## Programming

| Sub-menu 1                                     | Sub-menu 2                                       | Settings   | Code               |  |
|--|--|--|--------------------|---|
| Speed dial                                     | –  | –  | #261               | 29  |
| Cell locator                                   | –  | –  | #248               | 20  |
| Record greeting <sup>*1</sup>                  | –  | –  | #302               | 44  |
| Voicemail                                      | Save VM access# <sup>*1</sup><br>(VM: Voicemail) | –  | #331               | 50  |
|  | VM tone detect <sup>*1</sup>                     | <On><br>Off  | #332               | 50  |
| Message indicator                              | –  | <On><br>Off  | #340               | 49  |
| LCD contrast<br>(Display contrast)             | –  | Level 1–4 <2>  | #145               | –   |
| Handset name                                   | –  | –  | #104               | 40  |
| Display name                                   | –  | On<br><Off>  | #105               | 40  |
| Auto intercom                                  | Handset  | On<br><Off>  | #273               | 21  |
|  | Base unit <sup>*1, *3</sup>                      | On<br><Off>  | # <del>2</del> 273 |   |
| Key tone                                       | –  | <On><br>Off  | #165               | –   |
| Caller ID edit<br>(Caller ID number auto edit) | –  | <On><br>Off  | #214               | 43  |
| Auto talk <sup>*10</sup>                       | –  | On<br><Off>  | #200               | 17  |
| Set tel line                                   | Set dial mode <sup>*1</sup>                      | <Tone><br>Pulse  | #120               | 15  |
|  | Set flash time <sup>*1, *11</sup>                | 80 ms<br>90 ms<br>100 ms<br>110 ms<br>160 ms<br>200 ms<br>250 ms<br>300 ms<br>400 ms<br>600 ms<br><700 ms><br>900 ms | #121               | 18  |
|  | Set line mode <sup>*1, *12</sup>                 | A <B>  | #122               | –   |
| Call sharing <sup>*1</sup>                     | –  | <On><br>Off  | #194               | 19  |

## Programming

| Sub-menu 1      | Sub-menu 2                   | Settings             | Code |  |
|-----------------|------------------------------|----------------------|------|---|
| Registration    | Register handset             | –                    | #130 | 40  |
|                 | Deregistration <sup>*2</sup> | –                    | #131 | 41  |
| Power failure   | –                            | <Auto><br>Off        | #152 | 21  |
| Change language | Display                      | <English><br>Español | #110 | 14  |
|                 | Announcement <sup>*1</sup>   | <English><br>Español | #112 | 14  |

Main menu:  “Customer support”

| Operation                                | Code |  |
|--|------|---|
| Displaying customer support Web address. | #680 | –   |

Main menu:  “Baby monitor”

| Sub-menu 1        | Sub-menu 2 | Settings                | Code |  |
|-------------------|------------|-------------------------|------|---|
| On/Off            | –          | On<br><Off>             | #268 | 38  |
| Sensitivity level | –          | Low<br><Middle><br>High | #269 | 39  |

Main menu:  “Key detector”<sup>\*7</sup>

| Sub-menu 1    | Sub-menu 2 | Settings | Code |  |
|---------------|------------|----------|------|---|
| Search        | –          | –        | #655 | –   |
| Battery check | –          | –        |      |   |

\*1 If you program these settings using one of the units, you do not need to program the same item using another unit.

\*2 This menu is not displayed when scrolling through the display menus. It is only available in direct command code.

\*3 KX-TGE640 series: page 3

\*4 This feature allows the unit to automatically adjust the date and time each time caller information including date and time is received.

To turn this feature on, select “Caller ID auto”. To turn this feature off, select “Manual”. (Caller ID subscribers only)

To use this feature, set the date and time first (page 14).

\*5 If you subscribe to a distinctive ring service (such as IDENTA-RING), select a tone (tone 1 to 2). If you select a melody, you cannot distinguish lines by their ringers.

\*6 The preset melodies in this product (“Tone 3” - “Melody 10”) are used with permission of © 2009 Copyrights Vision Inc.

\*7 This setting is available when you have the key detector (KX-TGA20). Read the installation manual for more information on the key detector.

\*8 For models with supplied key detectors, the display shows “1: Detector1”.



## **Programming**

---

- \*9 If you register 2 or more key detectors.
- \*10 If you subscribe to a Caller ID service and want to view the caller's information after lifting up the handset to answer a call, turn off this feature.
- \*11 The flash time depends on your telephone exchange or host PBX. Contact your PBX supplier if necessary. The setting should stay at "700 ms" unless pressing **[FLASH]** fails to pick up the waiting call.
- \*12 Generally, the line mode setting should not be changed. This setting automatically maintains receiver volume at the proper level depending on the current telephone line condition. Set the line mode to "A" if telephone line condition is not good.

## Alarm

An alarm sounds at the set time for 1 minute and is repeated 5 times at 5 minute intervals (snooze function). A text memo can also be displayed for the alarm. A total of 3 separate alarm times can be programmed for each handset. You can set one of 3 different alarm options (once, daily, or weekly) for each alarm time.

### Important:

- Make sure the unit's date and time setting is correct (page 14).

1 **[MENU]** **#** **7** **2** **0**

2 **[↕]**: Select the desired alarm. → **[SELECT]**

3 **[↕]**: Select the desired alarm option. → **[SELECT]**

|  |
|--|
| <p><b>"Off"</b><br/>Turns alarm off. Go to step 10.</p>                            |
| <p><b>"Once"</b><br/>An alarm sounds once at the set time.</p>                     |
| <p><b>"Daily"</b><br/>An alarm sounds daily at the set time.<br/>Go to step 5.</p> |
| <p><b>"Weekly"</b><br/>Alarm sounds weekly at the set time(s).</p>                 |

4 Proceed with the operation according to your selection in step 3.

■ **Once:**  
Enter the desired month and date. → **[OK]**

■ **Weekly:**  
**[↕]**: Select the desired day of the week and press **[SELECT]**. → **[OK]**

5 Set the desired time.

6 **[⊗]**: Select **"AM"** or **"PM"**. → **[OK]**

7 Enter a text memo (10 characters max.). → **[OK]**

8 **[↕]**: Select the desired alarm tone. → **[SELECT]**

- We recommend selecting a different ringer tone from the one used for outside calls.

9 **[↕]**: Select the desired snooze setting. → **[SAVE]**

10 **[SELECT]** → **[OFF]**

### Note:

- Press **[STOP]** to stop the alarm completely.
- When the handset is in use, the alarm will not sound until the handset is in standby mode.
- Press any dial key or **[SNOOZE]** to stop the sound but keep the snooze function activated.
- If you want to make an outside call when the snooze function is activated, please stop the snooze function before making the call.

## Silent mode

Silent mode allows you to select a period of time during which the handset and/or base unit will not ring for outside calls. This feature is useful for time periods when you do not want to be disturbed, for example, while sleeping. Silent mode can be set for each unit. Using the phonebook's group feature (page 27), you can also select groups of callers whose calls override silent mode and ring the unit (Caller ID subscribers only).

### Important:

- Make sure the unit's date and time setting is correct (page 14).
- We recommend turning the base unit ringer off (page 17) in addition to turning the silent mode on.
- If you have set the alarm, the alarm sounds even if the silent mode is turned on.

### Turning silent mode on/off

1 **For handset setting:** **[MENU]** **#** **2** **3** **8**  
**For base unit setting (using a handset)\*1:** **[MENU]** **#** **⊗** **2** **3** **8**

## Programming

- 2 **[↕]**: Select the desired setting. → **[SAVE]**
    - If you select “OFF”, press **[OFF]** to exit.
  - 3 Enter the desired hour and minute you wish to start this feature.
  - 4 **[X]**: Select “AM” or “PM”. → **[OK]**
  - 5 Enter the desired hour and minute you wish to end this feature.
  - 6 **[X]**: Select “AM” or “PM”.
  - 7 **[SAVE]** → **[OFF]**
- \*1 KX-TGE640 series: page 3

### Changing the start and end time

- 1 For handset setting: **[MENU]****[#]****[2]****[3]****[7]**  
For base unit setting (using a handset)\*1: **[MENU]****[#]****[X]****[2]****[3]****[7]**
  - 2 Continue from step 3, “Turning silent mode on/off”, page 37.
- \*1 KX-TGE640 series: page 3

### Selecting groups to bypass silent mode

- 1 For handset setting: **[MENU]****[#]****[2]****[4]****[1]**  
For base unit setting (using a handset)\*1: **[MENU]****[#]****[X]****[2]****[4]****[1]**
  - 2 **[↕]**: Select the desired groups. → **[SELECT]**
    - “✓” is displayed next to the selected group numbers.
    - To cancel the selected group: **[↕]**: Select the group. → Press **[SELECT]** again. “✓” disappears.
  - 3 **[SAVE]** → **[OFF]**
- \*1 KX-TGE640 series: page 3

## Baby monitor

This feature allows you to listen in on a room where another handset is located, allowing you to easily monitor from different areas of the house or even while away from home. The monitored handset (placed in a baby's room, for example) will automatically call the

monitoring handset, base unit, or the phone number stored when it detects sound.

### Important:

- Before using this feature, we recommend that you test this feature and adjust the baby monitor sensitivity as needed, especially if you plan to monitor from outside.
- This feature should not be used as a substitute for a medical or caregiver's supervision. It is the caregiver's responsibility to stay close enough to handle any eventuality.

### Note:

- If the unit is connected to a PBX system, you cannot set the baby monitor.
- During the monitoring mode, battery consumption is faster than usual. We recommend leaving the monitored handset on the base unit or charger.
- The monitored handset never rings while it is being monitored. If the base unit is placed near the monitored handset, we recommend turning off the base unit ringer volume (page 17).

## Setting the baby monitor

Perform the setting operation with the handset to be monitored (for example, the handset placed in a baby's room).

### To monitor with a unit

The internal baby monitor feature is available:

- between handsets
- between a handset and the base unit\*1

\*1 KX-TGE640 series: page 3

- 1 **[MENU]****[#]****[2]****[6]****[8]**
- 2 **[↕]**: “on” → **[SELECT]**
- 3 **[↕]**: Select the desired unit's number to monitor with. → **[SAVE]**
  - “Baby monitor” will be displayed.
  - The registered unit's name/number is displayed.

### Note:

- When this feature is on, another handset or the base unit can hear the monitored handset by making an intercom call.

### To monitor from outside

If you enable this feature, the unit will call a pre-programmed phone number when the handset detects sound. After you answer the call, you can listen in on the room where the handset is located.

#### ■ From the phonebook:

- 1 [MENU] [#] [2] [6] [8]
- 2 [↕]: "On" → [SELECT]
- 3 [↕]: Select "Outgoing call" to monitor from outside. → [ADD]
- 4 [↕]: "Phonebook" → [SELECT]
- 5 [↕]: Select the phonebook entry. → [SAVE]
  - "Baby monitor" will be displayed.

### Note:

- If you edit a phonebook entry which is assigned for monitoring, the edited entry does not transfer to the monitor.

#### ■ By entering phone numbers:

- 1 [MENU] [#] [2] [6] [8]
- 2 [↕]: "On" → [SELECT]
- 3 [↕]: Select "Outgoing call" to monitor from outside. → [ADD]
- 4 [↕]: "Manual" → [SELECT]
- 5 Enter the desired name. → [OK]
- 6 Enter the desired number. → [OK] → [SELECT]
  - "Baby monitor" will be displayed.

### Note:

- The registered name/number is displayed.

### Turning off the baby monitor

The monitored handset cannot be used while baby monitor is set to "On".

- 1 Press [MENU] on the handset being monitored.
- 2 [↕]: "On/Off" → [SELECT]

- 3 [↕]: "Off" → [SELECT] → [OFF]

### Editing an outside monitoring number

- 1 Press [MENU] on the handset being monitored.
- 2 [↕]: "On/Off" → [SELECT]
- 3 [↕]: "On" → [SELECT]
- 4 [↕]: Select the outside line.
- 5 [MENU] → [↕]: "Edit" → [SELECT]
- 6 Edit the name if necessary. → [OK]
- 7 Edit the phone number if necessary. → [OK] → [SELECT]

### Erasing an outside monitoring number

- 1 Press [MENU] on the handset being monitored.
- 2 [↕]: "On/Off" → [SELECT]
- 3 [↕]: "On" → [SELECT]
- 4 [↕]: Select the outside line.
- 5 [MENU] → [↕]: "Erase" → [SELECT]
- 6 [↕]: "Yes" → [SELECT] → [OFF]

### Baby monitor sensitivity

You can adjust the sensitivity of the baby monitor. Increase or decrease the sensitivity to adjust the sound level needed to trigger the baby monitor feature.

- This feature cannot be set during a monitoring call.

- 1 Press [MENU] on the handset being monitored.
- 2 [↕]: "Sensitivity level" → [SELECT]
- 3 [↕]: Select the desired setting. → [SAVE] → [OFF]

## Programming

### Answering the baby monitor

#### ■ When monitoring with a unit:

**Handset:** Press [  ] to answer a call.



**Base unit:** Press [  ] to answer a call\*1.

\*1 KX-TGE640 series: page 3

If you want to respond from the monitoring unit, press [MUTE].

- The monitoring unit will answer calls automatically when the auto intercom feature is set to “On” (page 21).

#### Note:

- If you receive an outside call when communicating with the monitored handset, the interrupt tone sounds.
  - To answer the call with the handset, press [OFF], then press [  ].
  - To answer the call with the base unit, press [  ] 3 times.\*1

\*1 If [MUTE] is pressed, press [  ] 2 times.

#### ■ When monitoring from outside:

Answer the call.

If you want to respond from your monitoring phone, press [  ] using tone dialing.

You can turn off the baby monitor feature by pressing [  ]0.

#### Note:

- The unit disconnects the call automatically after 2 minutes.

## Other programming

### Changing the handset name

The default handset name is “Handset 1” to “Handset 6”. You can customize the name of each handset (“Bob”, “Kitchen”, etc.). This is useful when you make intercom calls between handsets. To display the handset name in standby mode, turn on the handset name display feature (page 40).

1 [MENU][][1][0][4]

2 Enter the desired name (10 characters max.). → [SAVE] → [OFF]

### Displaying the handset name

You can select whether or not the handset name is displayed in standby mode. The default setting is “OFF”.

1 [MENU][][1][0][5]

2 [  ]: Select the desired setting. → [SAVE] → [OFF]

## Registering a unit

### Operating additional units

#### Additional handsets

Up to 6 handsets can be registered to the base unit.

#### Important:

- See page 5 for information on the available model.

### Registering a handset to the base unit

The supplied handset and base unit are pre-registered. If for some reason the handset is not registered to the base unit, re-register the handset.

1 **Handset:**  
[MENU][][1][3][0]

2 **Base unit:**  
Press and hold [LOCATOR] or [HANDSET LOCATOR] for about 5 seconds.

- If all registered handsets start ringing, press [LOCATOR] or [HANDSET LOCATOR] again to stop, then repeat this step.

3 **Handset:**  
Press [OK], then wait until a long beep sounds.



### Deregistering a handset

A handset can cancel its own registration to the base unit, or other handsets registered to the same base unit. This allows the handset to end its wireless connection with the system.

- 1 **[MENU]** **[#]** **[1]** **[3]** **[1]**
  - All handsets registered to the base unit are displayed.
- 2 **[↕]**: Select the handset you want to cancel. → **[SELECT]**
- 3 **[↕]**: “Yes” → **[SELECT]** → **[OFF]**

## Caller ID Service

### Using Caller ID service

#### Important:

- This unit is Caller ID compatible. To use Caller ID features, you must subscribe to a Caller ID service. Contact your phone service provider for details.

### Caller ID features

When an outside call is being received, the caller information is displayed.

Caller information for the last 50 callers is logged in the caller list from the most recent call to the oldest.

- If the unit cannot receive caller information, the following is displayed:
  - “**Out of area**”: The caller dials from an area which does not provide a Caller ID service.
  - “**Private caller**”: The caller requests not to send caller information.
  - “**Long distance**”: The caller makes a long distance call.
- If the unit is connected to a PBX system, caller information may not be properly received. Contact your PBX supplier.

### Missed calls

If a call is not answered, the unit treats it as a missed call. The display shows “**Missed call**”.

#### Note:

- Even when there are unviewed missed calls, “**Missed call**” disappears from the standby display if the following operation is performed by one of the units:
  - A handset is replaced on the base unit or charger.
  - Pressing [**OFF**] on a handset.

### Phonebook name display

When caller information is received and it matches a phone number stored in the phonebook, the stored name in the phonebook is displayed and logged in the caller list.

### Talking Caller ID

#### Handset / Base unit

This feature lets you know who is calling without looking at the display.

To use this feature, you must:

- subscribe to a Caller ID service of your phone service provider.
- turn this feature on (page 33).

When caller information is received, the handsets and/or base unit announce the caller’s name or phone number received from your phone service provider following every ring.

- Name pronunciation may vary. This feature may not pronounce all names correctly.
- Caller ID service has a limit of how many characters can be displayed. If the caller’s name is too long, the unit may not be able to display or announce the entire name.

### Phonebook name announcement

When caller information is received and it matches a phone number stored in the phonebook, the stored name in the phonebook is announced.

### Caller list

#### Important:

- Make sure the unit’s date and time setting is correct (page 14).

### Viewing the caller list and calling back

- 1 [**▼**] CID
- 2 Press [**▼**] to search from the most recent call, or [**▲**] to search from the oldest call.
- 3 To call back, press [**↶**].  
To exit, press [**OFF**].

#### Note:

- If the entry has already been viewed or answered, “**✓**” is displayed.

### Editing a caller's phone number

You can edit a phone number in the caller list by removing its area code and/or the long distance code "1".

- 1 [▼] CID
- 2 [↕]: Select the desired entry. → [MENU]
- 3 [↕]: "Edit" → [SELECT]
- 4 Press [EDIT] repeatedly until the phone number is shown in the desired format.
- 5 [↶]

### Caller ID number auto edit feature

Once you call back an edited number, the unit which was used to call back remembers the area code and format of the edited number. The next time someone calls from the same area code, caller information is customized by the unit as follows:

- When the call is being received, the Caller ID number is displayed in the same format as the edited number.
- After the call has ended, the caller's phone number is displayed in the same format as the edited number, when reviewed from the caller list.

For example, you can use this feature to let the unit ignore the area code of callers in your area, so that you can call these local numbers using caller information without dialing the area code.

To activate this feature, you must edit an entry in the caller list, then call that number. After that, phone numbers from that caller's area code are edited automatically.

This feature can be set for each unit (page 34). The default setting is "on".

#### Note:

- Phone numbers from the 4 most recently edited area codes are automatically edited.

### Erasing selected caller information

- 1 [▼] CID
- 2 [↕]: Select the desired entry.

- 3 [ERASE] → [↕]: "Yes" → [SELECT] → [OFF]

### Erasing all caller information

- 1 [▼] CID
- 2 [ERASE] → [↕]: "Yes" → [SELECT] → [OFF]

## Answering System

### Answering system

The answering system can answer and record calls for you when you are unavailable to answer the phone.

You can also set the unit to play a greeting message but not to record caller messages by selecting “**Greeting only**” as the recording time setting (page 49).

#### Important:

- Make sure the unit’s date and time setting is correct (page 14).

### Memory capacity (including your greeting message)

The total recording capacity is about 17 minutes. A maximum of 64 messages can be recorded.

#### Note:

- When message memory becomes full:
  - “**Messages full**” is shown on the handset display.
  - The message counter on the base unit flashes if the answering system is turned on.
  - If you use the pre-recorded greeting message, the unit automatically switches to another pre-recorded greeting message asking callers to call again later.
  - If you recorded your own greeting message, the same message is still announced to callers even though their messages are not recorded.

### Turning the answering system on/off

#### Base unit

Press **[ANSWER ON/OFF]** to turn on/off the answering system.

#### Handset

- 1 To turn on:  
**[MENU]#3|2|7**

#### To turn off:

**[MENU]#3|2|8**

- 2 **[OFF]**

#### Note for base unit and handset:

- When the answering system is turned on, the message counter on the base unit displays the total number of messages (old and new).

### Greeting message

When the unit answers a call, a greeting message is played to callers.

You can use either:

- your own greeting message
- a pre-recorded greeting message

### Recording your greeting message

- 1 **[MENU]#3|0|2**

- 2 **[↕]: “Yes” → [SELECT]**

- 3 After a beep sounds, hold the handset about 20 cm (8 inches) away and speak clearly into the microphone (2 minutes max.).

- 4 Press **[STOP]** to stop recording. → **[OFF]**

### Using a pre-recorded greeting message

The unit provides 2 pre-recorded greeting messages:

- If you reset to pre-recorded greeting or do not record your own greeting message, the unit plays a pre-recorded greeting asking callers to leave a message.
- If the message recording time (page 49) is set to “**Greeting only**”, callers’ messages are not recorded and the unit plays a different pre-recorded greeting message asking callers to call again.

## Answering System

### Resetting to a pre-recorded greeting message

Use this procedure to erase your greeting message and use a pre-recorded one.

- 1 [MENU] [#] [3] [0] [4]
- 2 [YES] → [OFF]

### Playing back the greeting message

- 1 [MENU] [#] [3] [0] [3]
- 2 To exit, press [OFF].

### Listening to messages

#### Important:

- When using the base unit or handset to listen to messages, the noise reduction feature (page 18) is activated automatically in spite of the setting ([NR] is not displayed).

### Using the base unit

When new messages have been recorded, [▶■] on the base unit flashes. Press [▶■] (PLAY).

- During playback, [▶■] on the base unit lights.
- If new messages have been recorded, the base unit plays back new messages.
- If there are no new messages, the base unit plays back all messages.

### Operating the answering system during playback

| Key         | Operation                 |
|-------------|---------------------------|
| [+] or [-]  | Adjust the speaker volume |
| [◀◀]        | Repeat message*1          |
| [▶▶]        | Skip message              |
| [▶■] (STOP) | Stop playback             |

| Key     | Operation                       |
|---------|---------------------------------|
| [ERASE] | Erase currently playing message |

- \*1 If pressed within the first 5 seconds of a message, the previous message is played.

### Erasing all messages

Press [ERASE] 2 times while the unit is not in use.

### Using the handset

When new messages have been recorded:

- “New message” is displayed.
- The message indicator on the handset flashes slowly if the message indicator is turned on (page 49).

#### 1 To listen to new messages:

[MENU] [#] [3] [2] [3]

To listen to all messages:

[MENU] [#] [3] [2] [4]

#### 2 When finished, press [OFF].

#### Note:

- To switch to the receiver, press [↶].
- You can also use the [PLAY] soft key, if displayed, to play new messages.

### Operating the answering system

[MENU] → [⬆]: “Answering device” → [SELECT]

| Key        | Operation  |
|------------|--|
| [+] or [-] | Adjust the receiver/speaker volume (during playback) |
| [1] or [◀] | Repeat message (during playback)*1                   |
| [2] or [▶] | Skip message (during playback)                       |
| [3]        | Enter the “Settings” menu                            |
| [4]        | Play new messages                                    |
| [5]        | Play all messages                                    |
| [6]        | Play greeting message                                |

## Answering System

| Key           | Operation                                |
|---------------|--|
| [7][6]        | Record greeting message                  |
| [8]           | Turn answering system on                 |
| [PAUSE]       | Pause message*2                          |
| [9] or [STOP] | Stop recording<br>Stop playback          |
| [0]           | Turn answering system off                |
| [*][4]*3      | Erase currently playing message          |
| [*][5]        | Erase all messages                       |
| [*][6]        | Reset to a pre-recorded greeting message |

- \*1 If pressed within the first 5 seconds of a message, the previous message is played.
- \*2 To resume playback:  
[↕]: "Playback" → [SELECT]
- \*3 You can also erase as follows:  
[PAUSE] → [↕]: "Erase" → [SELECT] → [↕]: "Yes" → [SELECT]

### Calling back (Caller ID subscribers only)

- 1 Press [PAUSE] during playback.
- 2 [↕]: "Call back" → [SELECT]

### Editing the number before calling back

- 1 Press [PAUSE] during playback.
- 2 [↕]: "Edit & Call" → [SELECT]
- 3 Press [EDIT] repeatedly until the phone number is shown in the desired format (page 43). → [↵]

### Erasing all messages

- 1 [MENU][#][3][2][5]
- 2 [↕]: "Yes" → [SELECT] → [OFF]

## Advanced new message alerting features

### Audible message alert

This feature allows the base unit to beep to inform you of a new message arrival when new messages are recorded. The base unit beeps 2 times every minute until you listen to the messages, if the "Base unit beep" setting is turned on. The default setting is "Off".

- 1 [MENU][#][3][3][9]
- 2 [↕]: Select the desired setting. → [SAVE] → [OFF]

### New message alert by a call

This feature allows you to receive a notification by phone when new messages are recorded. The base unit calls a phone number you specify. You can then operate the answering system remotely to listen to the new message.

To use this feature, you must:

- store a phone number to which the unit makes the call to.
  - turn on the new message alert setting.
- After you answer the new message alert call, you can listen to messages from that call (page 47).

#### Important:

- A new message alert is stopped 1 minute after the unit starts to call. The unit will not retry the call even if the call is not answered.

### Storing a phone number to which the unit makes an alert call

#### ■ From the phonebook:

- 1 [MENU][#][3][3][8]
- 2 [↕]: "Notification to" → [SELECT] → [ADD]
- 3 [↕]: "Phonebook" → [SELECT]
- 4 [↕]: Select the desired phonebook entry. → [SAVE] → [OFF]

### ■ By entering a phone number:

- 1 [MENU]#338
- 2 [↕]: "Notification to" → [SELECT] → [ADD]
- 3 [↕]: "Manual" → [SELECT]
- 4 Enter the desired name (16 characters max.). → [OK]
- 5 Enter the desired number (24 digits max.). → [OK] → [SELECT] → [OFF]

### Turning on/off the new message alert setting

- 1 [MENU]#338
- 2 [↕]: "On/Off" → [SELECT]
- 3 [↕]: Select the desired setting. → [SAVE] → [OFF]

### Editing the set phone number

- 1 [MENU]#338
- 2 [↕]: "Notification to" → [SELECT]
- 3 [MENU] → [↕]: "Edit" → [SELECT]
- 4 Edit the name if necessary (16 characters max.). → [OK]
- 5 Edit the phone number if necessary (24 digits max.). → [OK] → [SELECT] → [OFF]

### Erasing the set phone number

- 1 [MENU]#338
- 2 [↕]: "Notification to" → [SELECT]
- 3 [MENU] → [↕]: "Erase" → [SELECT]
- 4 [↕]: "Yes" → [SELECT] → [OFF]
  - The new message alert setting is turned off.

### Activating/inactivating the remote access code to play messages

If you activate this feature, you must enter the remote access code (page 48) to play the new message from the new message alert call. This is so that unauthorized parties

cannot listen to your messages. The default setting is "Inactivate".

- "Inactivate": You can listen to the message by pressing [4] to play new messages (without entering the remote access code).
- "Activate": You must enter your remote access code and then press [4] to play new message.

- 1 [MENU]#338
- 2 [↕]: "Remote code" → [SELECT]
- 3 [↕]: Select the desired setting. → [SAVE] → [OFF]

### Listening to messages

After you answer the new message alert, you can listen to the messages as follows.

#### ■ When the remote access code is set to "Inactivate":

Press [4] to play the new message during the announcement.

#### ■ When the remote access code is set to "Activate":

- 1 Enter the remote access code (page 48) during the announcement.
- 2 Press [4] to play the new message.

#### Note:

- Within 10 seconds after listening to new messages, you can press [#]9 during the call to turn off the new message alert by a call feature.
- Even if the unit makes a new message alert call, the handset redial list does not show the record.

## Remote operation

Using a touch-tone phone, you can call your phone number from outside and access the unit to listen to messages or change answering system settings. The unit's voice guidance prompts you to press certain dial keys to perform different operations.

## Answering System

### Remote access code

A 3-digit remote access code must be entered when operating the answering system remotely. This code prevents unauthorized parties from listening to your messages remotely. The default setting is "111".

#### Important:

- To prevent unauthorized access to this product, we recommend that you regularly change the remote code.

- [MENU]** **#** **3** **0** **6**
- Enter the desired 3-digit remote access code. → **[SAVE]** → **[OFF]**

### Deactivating remote operation

Press **[X]** in step 2 on "Remote access code", page 48.

- The entered remote access code is deleted.

### Using the answering system remotely

- Dial your phone number from a touch-tone phone.
- After the greeting message starts, enter your remote access code.
- Follow the voice guidance prompts as necessary or control the unit using remote commands (page 48).
- When finished, hang up.

### Voice guidance

#### ■ When the English voice guidance is selected

During remote operation, the unit's voice guidance starts and prompts you to press **[1]** to perform a specific operation, or press **[2]** to listen to more available operations.

#### ■ When the Spanish voice guidance is selected

To start the voice guidance, press **[9]**. The voice guidance announces the available remote commands (page 48).

#### Note:

- If you do not press any dial keys within 10 seconds after a voice guidance prompt, the unit disconnects your call.

### Remote commands

You can press dial keys to access certain answering system functions without waiting for the voice guidance to prompt you.

| Key            | Operation                                 |
|----------------|---|
| <b>[1]</b>     | Repeat message (during playback)*1        |
| <b>[2]</b>     | Skip message (during playback)            |
| <b>[4]</b>     | Play new messages                         |
| <b>[5]</b>     | Play all messages                         |
| <b>[9]</b>     | Stop playback*2<br>Start voice guidance*3 |
| <b>[0]</b>     | Turn answering system off                 |
| <b>[X] [4]</b> | Erase currently playing message           |
| <b>[X] [5]</b> | Erase all messages                        |
| <b>[X] [#]</b> | End remote operation<br>(or hang up)      |

\*1 If pressed within the first 5 seconds of a message, the previous message is played.

\*2 For English voice guidance only

\*3 For Spanish voice guidance only

### Turning on the answering system remotely

- Dial your phone number from a touch-tone phone.
- Let the phone ring 15 times.
  - A long beep is heard.
- Enter your remote access code within 10 seconds after the long beep.
  - The greeting message is played back.
  - You can either hang up, or enter your remote access code again and begin remote operation (page 47).



### Answering system settings

#### Call screening

##### Handset / Base unit

While a caller is leaving a message, you can listen to the call through the unit's speaker. To adjust the speaker volume, press **[+]** or **[-]** repeatedly.

You can answer the call by pressing **[↶]** on the handset or **[↶]** on the base unit\*1.

Call screening can be set for each unit. The default setting is "On".

- 1 For handset setting:** **[MENU]#310**  
**For base unit setting (using a handset)\*1:** **[MENU]#\*310**

- 2 [↕]:** Select the desired setting. → **[SAVE] → [OFF]**

\*1 KX-TGE640 series: page 3

#### Number of rings before the unit answers a call

You can change the number of times the phone rings "Ring count" before the unit answers calls. You can select 2 to 7 rings, or "Toll saver".

The default setting is "4 rings".

"Toll saver": The unit's answering system answers at the end of the 2nd ring when new messages have been recorded, or at the end of the 5th ring when there are no new messages. If you call your phone from outside to listen to new messages (page 48), you know that there are no new messages when the phone rings for the 3rd time. You can then hang up without being charged for the call.

- 1 [MENU]#211**
- 2 [↕]:** Select the desired setting. → **[SAVE] → [OFF]**

#### Caller's recording time

You can change the maximum message recording time allowed for each caller. The default setting is "3 min".

- 1 [MENU]#305**
- 2 [↕]:** Select the desired setting. → **[SAVE] → [OFF]**

#### Selecting "Greeting only"

You can select "Greeting only" which sets the unit to announce a greeting message to callers but not record messages.

Select "Greeting only" in step 2 on "Caller's recording time", page 49.

##### Note:

- When you select "Greeting only":
  - If you do not record your own message, the unit will play the pre-recorded greeting-only message asking callers to call again later.
  - If you use your own message, record the greeting-only message asking callers to call again later (page 44).

#### Handset message indicator

You can select whether or not the message indicator on the handset flashes slowly when new messages are recorded. The default setting is "on".

##### Important:

- If you stored the voicemail access number (page 50), the message indicator also flashes for newly recorded voicemail messages (page 51).

- 1 [MENU]#340**
- 2 [↕]:** Select the desired setting. → **[SAVE] → [OFF]**

##### Note:

- While message indicator is on, battery operating time is shortened (page 12).

## Useful Information

### Voice mail service

In addition to your unit's answering system you may also have voicemail service from your phone service provider. Voicemail is an answering service that may be offered by your phone service provider. This service can also record calls when you are unavailable to answer the phone or when your line is busy. Messages are recorded on the phone company system and not on the unit's answering system.

- To use the voicemail service rather than the unit's answering system, turn off the answering system (page 44).

If you have unit's answering system set to on and also the voicemail enabled, the system with least amount of rings will record the message first.

#### Example:

If the unit's answering system is set to 4 rings (page 49) and the voicemail answering system provided by your phone company is set to 6 rings (call your service provider), the unit's answering system will record the incoming call first.

#### Important:

- You need to store the voicemail access number to activate the message indicator (page 49) for voicemail service.

### Storing the voicemail (VM) access number

In order to listen to your voicemail messages, you must dial your phone service provider's voicemail access number. Once you have stored your voicemail access number, you can dial it automatically (page 51).

- 1 **[MENU]#331**
- 2 Enter your access number (24 digits max.). → **[SAVE]** → **[OFF]**

#### Note:

- When storing your voicemail access number and your mailbox password, press **[▲]** (Pause) to add pauses (page 16) between the access number and the password as necessary. Contact your

phone service provider for the required pause time.

#### Example:

|                  |        |          |
|------------------|--------|----------|
| 1-222-333-4444   | PPPP   | 8888     |
| VM access number | Pauses | Password |

### To erase the voicemail access number

- 1 **[MENU]#331**
- 2 Press and hold **[CLEAR]** until all digits are erased. → **[SAVE]** → **[OFF]**

### Voice mail (VM) tone detection

#### Handset / Base unit\*1

\*1 KX-TGE640 series: page 3

Your phone service provider sends special signals (sometimes called "voicemail tones" or "stutter tones") to the unit to let you know you have new voicemail messages. If you hear a series of dial tones followed by a continuous dial tone after you press **[📞]** on the handset or press **[📞]** on the base unit, you have new voicemail messages. Soon after you hang up a call or after the phone stops ringing, your unit checks the phone line to see if new voicemail messages have been recorded.

Turn this feature off when:

- You do not subscribe to voicemail service.
- Your phone service provider does not send voicemail tones.
- Your phone is connected to a PBX.

If you are not sure which setting is required, contact your phone service provider.

### Turning VM tone detection on/off

The default setting is "on".

- 1 **[MENU]#332**
- 2 **[↕]**: Select the desired setting. → **[SAVE]** → **[OFF]**

## Listening to voicemail messages

- When new messages have been recorded:
- "Voicemail msg. via phone co." is displayed if message indication service is available.
  - The message indicator on the handset flashes slowly if the message indicator is turned on (page 49).

### Handset

- 1 **[MENU]#330**
  - The speakerphone turns on.
- 2 Follow the pre-recorded instructions.
- 3 When finished, hang up.

### Note:

- You can also use the **[ACCESS]** soft key, if displayed, to play new voicemail messages.
- If the handset still indicates there are new messages even after you have listened to all new messages, turn it off by pressing and holding **#** until the handset beeps.

### Base unit\*1

\*1 KX-TGE640 series: page 3

To listen to voicemail messages, you have to dial your voicemail access number manually.

## Wall mounting

### Note:

- Make sure that the wall and the fixing method are strong enough to support the weight of the unit.

### Base unit

- 1 Lead the AC adaptor cord and telephone line cord through the hole in the wall mounting adaptor in the direction of the arrow.

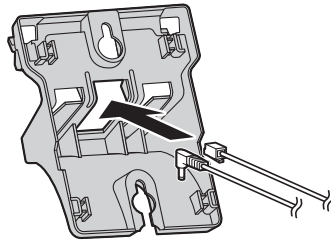

- 2 Tuck the telephone line cord inside the wall mounting adaptor (1). Connect the AC adaptor cord and telephone line cord (2).
  - Ⓐ AC adaptor cord

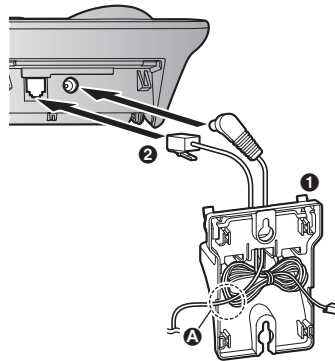

## Useful Information

- 3** Insert the hooks on the wall mounting adaptor into holes **(A)** and **(B)** on the base unit.

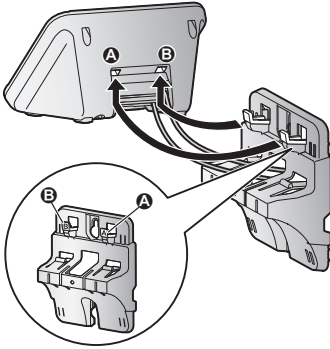

- 4** Adjust the adaptor to hold the base unit, then push it in the direction of the arrow until it clicks into place.

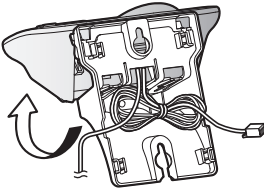
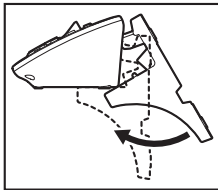

- 5** Mount the unit on a wall then slide down to secure in place.  
**(A)** AC adaptor cord

- This product is compliant with the following wall phone plate sizes (2 types).  
**(B)** 83 mm (3 1/4 inches)  
**(C)** 102 mm (4 inches)  
Fit the slots of the unit onto the corresponding wall phone plate tabs for **(D)** and **(E)** respectively.

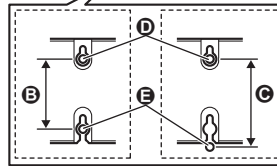
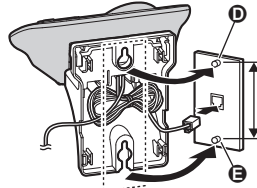
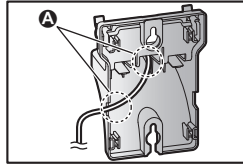

## Useful Information

### To remove the wall mounting adaptor

While pushing down the release levers (1), remove the adaptor (2).

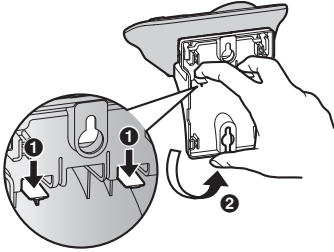

### Charger

Drive the screws (A) (not supplied) into the wall.

B 27.2 mm (1 1/16 inches)

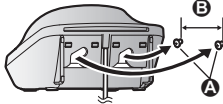

## Useful Information

### Error messages

| Display message  | Cause/solution   |
|--|--|
| Ask phone company for VM access #                                      | <ul style="list-style-type: none"><li>● You have not stored the voicemail access number. Store the number (page 50).</li></ul>   |
| Main unit no power or No link. Re-connect base AC adaptor. or No link. | <ul style="list-style-type: none"><li>● Confirm the base unit's AC adaptor is connected to the unit and the power outlet correctly.</li><li>● The handset has lost communication with the base unit. Move closer to the base unit and try again.</li><li>● Unplug the base unit's AC adaptor to reset the unit. Reconnect the adaptor and try again.</li><li>● The handset's registration may have been canceled. Re-register the handset (page 40).</li><li>● When "No link." is displayed during a power failure, place a handset on the base unit to supply power to the base unit.</li></ul> |
| Busy   | <ul style="list-style-type: none"><li>● The called unit is in use.</li><li>● Other units are in use and the system is busy. Try again later.</li><li>● The handset you are using is too far from the base unit. Move closer and try again.</li><li>● The automated callers block function is in operation. Try again later.</li></ul>  |
| Check tel line   | <ul style="list-style-type: none"><li>● The supplied telephone line cord has not been connected yet or not connected properly. Check the connections (page 10).</li></ul>  |
| Error!!  | <ul style="list-style-type: none"><li>● Recording was too short. Try again.</li></ul>  |
| Invalid  | <ul style="list-style-type: none"><li>● There is no handset registered to the base unit matching the handset number you entered.</li><li>● The handset is not registered to the base unit. Register the handset (page 40).</li></ul>   |
| Checking   | <ul style="list-style-type: none"><li>● The automated callers block function is in operation. Try again later.</li></ul>   |
| Requires subscription to Caller ID.                                    | <ul style="list-style-type: none"><li>● You must subscribe to a Caller ID service. Once you receive caller information after subscribing to a Caller ID service, this message will not be displayed.</li></ul>   |
| Use rechargeable battery.  | <ul style="list-style-type: none"><li>● A wrong type of battery such as alkaline or manganese was inserted. Use only the rechargeable Ni-MH batteries noted on page 4, 7.</li></ul>  |

## Troubleshooting

If you still have difficulties after following the instructions in this section, disconnect the base unit's AC adaptor, then reconnect the base unit's AC adaptor. Remove the batteries from the handset, and then insert them into the handset again.

### General use



| Problem   | Cause/solution  |
|---|---|
| The handset does not turn on even after installing charged batteries. | <ul style="list-style-type: none"> <li>Place the handset on the base unit or charger to turn on the handset.</li> </ul>   |
| The unit does not work.   | <ul style="list-style-type: none"> <li>Make sure the batteries are installed correctly (page 10).</li> <li>Fully charge the batteries (page 11).</li> <li>Check the connections (page 10).</li> <li>Unplug the base unit's AC adaptor to reset the unit. Reconnect the adaptor and try again.</li> <li>The handset has not been registered to the base unit. Register the handset (page 40).</li> </ul>   |
| I cannot hear a dial tone.  | <ul style="list-style-type: none"> <li>The base unit's AC adaptor or telephone line cord is not connected. Check the connections.</li> <li>Disconnect the base unit from the telephone line and connect the line to a known working telephone. If the working telephone operates properly, contact our service personnel to have the unit repaired. If the working telephone does not operate properly, contact your phone service provider.</li> </ul> |
| The indicator on the handset flashes slowly.                          | <ul style="list-style-type: none"> <li>New messages have been recorded. Listen to the new messages (page 45).</li> <li>New voicemail messages have been recorded. Listen to the new voicemail messages (page 51).</li> </ul>  |
| The base unit beeps.  | <ul style="list-style-type: none"> <li>New messages have been recorded. Listen to the new messages (page 45).</li> </ul>  |

### Menu list







| Problem                                     | Cause/solution   |
|---|--|
| The display is in a language I cannot read. | <ul style="list-style-type: none"> <li>Change the display language (page 14).</li> </ul>   |
| I cannot register a handset to a base unit. | <ul style="list-style-type: none"> <li>The maximum number of handsets (6) is already registered to the base unit. Cancel unused handset registrations from the base unit (page 41).</li> </ul> |

## Useful Information

### Battery recharge

| Problem  | Cause/solution   |
|--|--|
| The handset beeps and/or  flashes.  | <ul style="list-style-type: none"> <li>Battery charge is low. Fully charge the batteries (page 11).</li> </ul>   |
| I fully charged the batteries, but <ul style="list-style-type: none"> <li> still flashes,</li> <li> is displayed, or</li> <li>the operating time seems to be shorter.</li> </ul> | <ul style="list-style-type: none"> <li>Clean the battery ends (+, -) and the charge contacts with a dry cloth and charge again.</li> <li>It is time to replace the batteries (page 10).</li> </ul> |

### Making/answering calls, intercom

| Problem   | Cause/solution   |
|---|--|
|  is displayed. | <ul style="list-style-type: none"> <li>The handset is too far from the base unit. Move closer.</li> <li>The base unit's AC adaptor is not properly connected. Reconnect AC adaptor to the base unit.</li> <li>The handset is not registered to the base unit. Register it (page 40).</li> </ul>  |
| Noise is heard, sound cuts in and out.  | <ul style="list-style-type: none"> <li>You are using the handset or base unit in an area with high electrical interference. Re-position the base unit and use the handset away from sources of interference.</li> <li>Move closer to the base unit.</li> <li>If you use a DSL/ADSL service, we recommend connecting a DSL/ADSL filter between the base unit and the telephone line jack. Contact your DSL/ADSL provider for details.</li> </ul>  |
| The handset does not ring.  | <ul style="list-style-type: none"> <li>The ringer volume is turned off. Adjust the ringer volume (page 17, 32).</li> <li>Silent mode is turned on. Turn it off (page 37).</li> <li>The ringer volume is turned off by pressing and holding  (). Press and hold  () again to turn it on (page 17).</li> </ul> |
| The base unit does not ring.  | <ul style="list-style-type: none"> <li>The ringer volume is turned off. Adjust the ringer volume (page 17).</li> <li>Silent mode is turned on. Turn it off (page 37).</li> </ul>   |
| I cannot make a call.   | <ul style="list-style-type: none"> <li>The dialing mode may be set incorrectly. Change the setting (page 15).</li> </ul>   |
| I cannot make or answer a call.   | <ul style="list-style-type: none"> <li>An outside line is being used after a cell locator feature is used.           <ul style="list-style-type: none"> <li>KX-TGE630 series: To end the call, press <b>[LOCATES CELL]</b> on the base unit.</li> <li>KX-TGE640 series: To end the call if someone answers using the cellular phone, press  on the base unit.</li> </ul> </li> </ul>  |
| I cannot make long distance calls.  | <ul style="list-style-type: none"> <li>Make sure that you have long distance service.</li> </ul>   |



## Useful Information

| Problem                    | Cause/solution  |
|----------------------------|---|
| I cannot use voice paging. | <ul style="list-style-type: none"> <li>You cannot use voice paging if other units are in use.</li> <li>Voice paging is not available when a range extender (KX-TGA407) is registered to the base unit.</li> </ul> |

### Caller ID/Talking Caller ID

| Problem  | Cause/solution   |
|--|--|
| Caller information is not displayed.                                 | <ul style="list-style-type: none"> <li>You must subscribe to Caller ID service. Contact your phone service provider for details.</li> <li>If your unit is connected to any additional telephone equipment such as a Caller ID box or cordless telephone line jack, plug the unit directly into the wall jack.</li> <li>If you use a DSL/ADSL service, we recommend connecting a DSL/ADSL filter between the base unit and the telephone line jack. Contact your DSL/ADSL provider for details.</li> <li>The name display service may not be available in some areas. Contact your phone service provider for details.</li> <li>Other telephone equipment may be interfering with this unit. Disconnect the other equipment and try again.</li> </ul> |
| Caller information is displayed or announced late.                   | <ul style="list-style-type: none"> <li>Depending on your phone service provider, the unit may display or announce the caller's information at the 2nd ring or later.</li> <li>Move closer to the base unit.</li> </ul>   |
| Caller information is not announced.                                 | <ul style="list-style-type: none"> <li>The handset or base unit's ringer volume is turned off. Adjust it (page 17, 32).</li> <li>The Talking Caller ID feature is turned off. Turn it on (page 33).</li> <li>The number of rings for the answering system is set to "2 rings" or "To11 saver". Select a different setting (page 49).</li> <li>If the base unit and another handset are having an intercom call, your handset does not announce caller information.</li> </ul>  |
| The caller list/incoming phone numbers are not edited automatically. | <ul style="list-style-type: none"> <li>The Caller ID number auto edit feature is turned off. Turn it on and try again (page 34).</li> <li>You need to call back the edited number to activate Caller ID number auto edit.</li> </ul>   |
| I cannot dial the phone number edited in the caller list.            | <ul style="list-style-type: none"> <li>The phone number you dialed might have been edited incorrectly (for example, the long distance "1" or the area code is missing). Edit the phone number with another pattern (page 43).</li> </ul>   |
| Time on the unit has shifted.  | <ul style="list-style-type: none"> <li>Incorrect time information from incoming Caller ID changes the time. Set the time adjustment to "Manual" (off) (page 32).</li> </ul>  |

## Useful Information

| Problem   | Cause/solution  |
|---|---|
| The 2nd caller's information is not displayed during an outside call. | <ul style="list-style-type: none"><li>● In order to use Caller ID, call waiting, or Call Waiting Caller ID (CWID), you must first contact your phone service provider and subscribe to the desired service. After subscribing, you may need to contact your phone service provider again to activate this specific service, even if you already subscribed to both Caller ID and Call Waiting with Caller ID services (CWID).</li></ul> |

## Answering system

| Problem   | Cause/solution  |
|---|---|
| The unit does not record new messages.                | <ul style="list-style-type: none"><li>● The answering system is turned off. Turn it on (page 44).</li><li>● The message memory is full. Erase unnecessary messages (page 45, 46).</li><li>● The recording time is set to "Greeting only". Change the setting (page 49).</li><li>● Your phone service provider's voicemail service may be answering your calls before the unit's answering system can answer your calls. Change the unit's number of rings setting (page 49) to a lower value, or contact your phone service provider.</li><li>● The answering system will not answer incoming calls while the other devices such as handsets are engaged in a call.</li></ul> |
| I cannot operate the answering system remotely.       | <ul style="list-style-type: none"><li>● The remote access code is not set. Set the remote access code (page 48).</li><li>● You are entering the wrong remote access code. If you have forgotten your remote access code, enter the remote access code setting to check your current code (page 48).</li><li>● The answering system is turned off. Turn it on (page 48).</li></ul>   |
| The unit does not emit the specified number of rings. | <ul style="list-style-type: none"><li>● If the first ring is turned off ("No") (page 24), the number of rings decreases by 1 from the specified number of rings.</li></ul>  |

## Useful Information

### Vicemail

| Problem   | Cause/solution   |
|---|--|
| <p>"Voicemail msg. via phone co." is shown on the handset display.<br/>How do I remove this message from the display?</p> | <ul style="list-style-type: none"><li>• This notification is displayed when your phone service provider's voicemail service (not the unit's answering system) has recorded a message for you. Typically you can remove this notification from the display by listening to the message. To listen to the message, dial the voicemail number provided by your phone service provider (for most cases, this will be your own phone number), and follow the voice instructions. Depending on your phone service provider, you may need to remove all messages from your voice mailbox to remove the notification. You can also remove this notification by pressing and holding <b>[#]</b> until the unit beeps.</li></ul> |

### Liquid damage

| Problem  | Cause/solution  |
|--|---|
| <p>Liquid or other form of moisture has entered the handset/base unit.</p> | <ul style="list-style-type: none"><li>• Disconnect the AC adaptor and telephone line cord from the base unit. Remove the batteries from the handset and leave to dry for at least 3 days. After the handset/base unit are completely dry, reconnect the AC adaptor and telephone line cord. Insert the batteries and charge fully before use. If the unit does not work properly, contact an authorized service center.</li></ul> |

#### Caution:

- To avoid permanent damage, do not use a microwave oven to speed up the drying process.

## Useful Information

---

### FCC and other information

This equipment complies with Part 68 of the FCC rules and the requirements adopted by the ACTA. On the bottom of this equipment is a label that contains, among other information, a product identifier in the format US:ACJ-----.

If requested, this number must be provided to the telephone company.

- Registration No.....(found on the bottom of the unit)
- Ringer Equivalence No. (REN).....0.1B

A plug and jack used to connect this equipment to the premises wiring and telephone network must comply with the applicable FCC Part 68 rules and requirements adopted by the ACTA. A compliant telephone cord and modular plug is provided with the product. It is designed to be connected to a compatible modular jack that is also compliant.

The REN is used to determine the number of devices that may be connected to a telephone line. Excessive RENs on a telephone line may result in the devices not ringing in response to an incoming call. In most but not all areas, the sum of RENs should not exceed five (5.0). To be certain of the number of devices that may be connected to a line, as determined by the total RENs, contact the local telephone company. For products approved after July 23, 2001, the REN for the product is part of the product identifier that has the format US:AAAEQ##TXXXX. The digits represented by ## are the REN without a decimal point (e.g., 03 is a REN of 0.3).

If this equipment causes harm to the telephone network, the telephone company will notify you in advance that temporary discontinuance of service may be required. But if advance notice isn't practical, the telephone company will notify the customer as soon as possible. Also, you will be

advised of your right to file a complaint with the FCC if you believe it is necessary.

The telephone company may make changes in its facilities, equipment, operations or procedures that could affect the operation of the equipment. If this happens the telephone company will provide advance notice in order for you to make necessary modifications to maintain uninterrupted service.

If trouble is experienced with this equipment, for repair or warranty information, please contact a Factory Service Center or other Authorized Servicer. If the equipment is causing harm to the telephone network, the telephone company may request that you disconnect the equipment until the problem is resolved.

Connection to party line service is subject to state tariffs. Contact the state public utility commission, public service commission or corporation commission for information.

If your home has specially wired alarm equipment connected to the telephone line, ensure the installation of this equipment does not disable your alarm equipment. If you have questions about what will disable alarm equipment, consult your telephone company or a qualified installer.

This equipment is hearing aid compatible as defined by the FCC in 47 CFR Section 68.316.

When you hold the phone to your ear, noise might be heard in your Hearing Aid. Some Hearing Aids are not adequately shielded from external RF (radio frequency) energy. If noise occurs, use an optional headset accessory or the speakerphone option (if applicable) when using this phone. Consult with your audiologist or Hearing Aid

## Useful Information

manufacturer about the availability of Hearing Aids which provide adequate shielding to RF energy commonly emitted by digital devices.

### WHEN PROGRAMMING EMERGENCY NUMBERS AND/OR MAKING TEST CALLS TO EMERGENCY NUMBERS:

- 1) Remain on the line and briefly explain to the dispatcher the reason for the call.
- 2) Perform such activities in the off-peak hours, such as early morning or late evenings.

This device complies with Part 15 of the FCC Rules. Operation is subject to the following two conditions:

(1) This device may not cause harmful interference, and (2) this device must accept any interference received, including interference that may cause undesired operation.

Privacy of communications may not be ensured when using this phone.

### CAUTION:

Any changes or modifications not expressly approved by the party responsible for compliance could void the user's authority to operate this device.

### NOTE:

This equipment has been tested and found to comply with the limits for a Class B digital device, pursuant to Part 15 of the FCC Rules. These limits are designed to provide reasonable protection against harmful interference in a residential installation. This equipment generates, uses, and can radiate radio frequency energy and, if not installed and used in accordance with the instructions, may cause harmful interference to radio communications. However, there is no guarantee that interference will not occur in a particular installation. If this equipment does cause harmful interference to radio or television reception, which can be determined by turning the equipment off and on, the user is

encouraged to try to correct the interference by one or more of the following measures:

- Reorient or relocate the receiving antenna.
- Increase the separation between the equipment and receiver.
- Connect the equipment into an outlet on a circuit different from that to which the receiver is connected.
- Consult the dealer or an experienced radio/TV technician for help.

Some cordless telephones operate at frequencies that may cause interference to nearby TVs and VCRs. To minimize or prevent such interference, the base of the cordless telephone should not be placed near or on top of a TV or VCR. If interference is experienced, move the cordless telephone further away from the TV or VCR. This will often reduce or eliminate interference.

### FCC RF Exposure Warning:

- This product complies with FCC radiation exposure limits set forth for an uncontrolled environment.
- To comply with FCC RF exposure requirements, the base unit must be installed and operated 20 cm (8 inches) or more between the product and all person's body.
- This product may not be collocated or operated in conjunction with any other antenna or transmitter.
- The handset may be carried and operated with only the specific provided belt-clip. Other non-tested belt-clips or similar body-worn accessories may not comply and must be avoided.

### Notice:

- FCC ID can be found inside the battery compartment or on the bottom of the units.

## ***Useful Information***

---

**Compliance with TIA-1083 standard:**  
Telephone handsets identified with this logo have reduced noise and interference when used with T-Coil equipped hearing aids and cochlear implants.



**Guía Rápida Española**

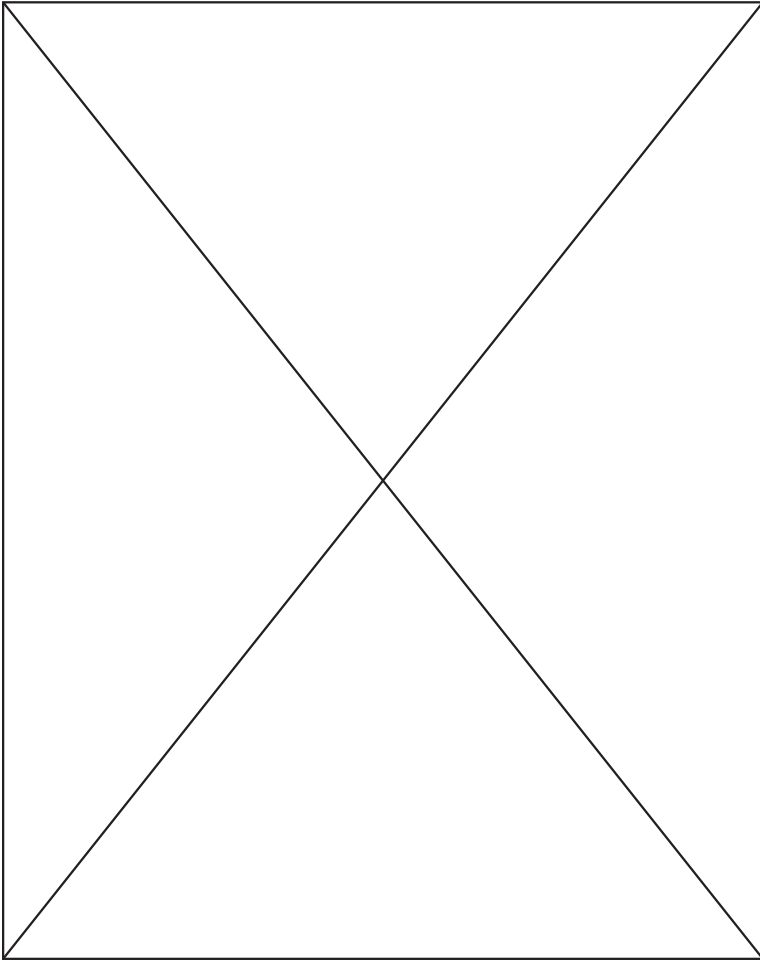

**Guía Rápida Española**

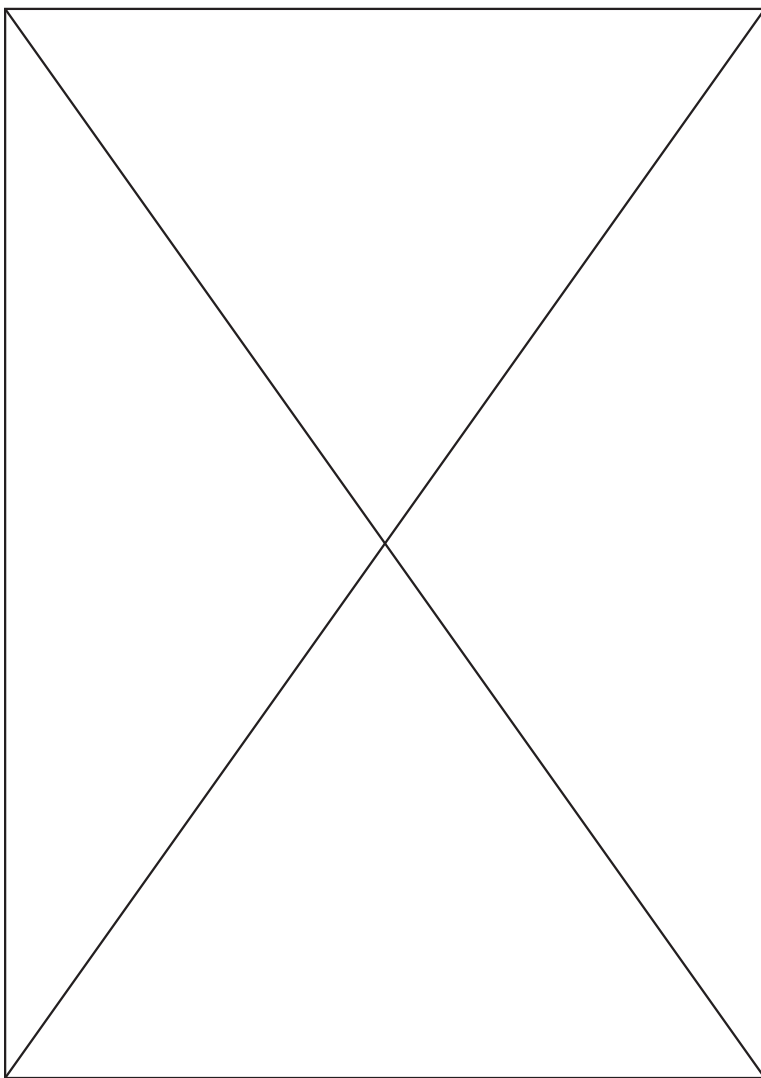



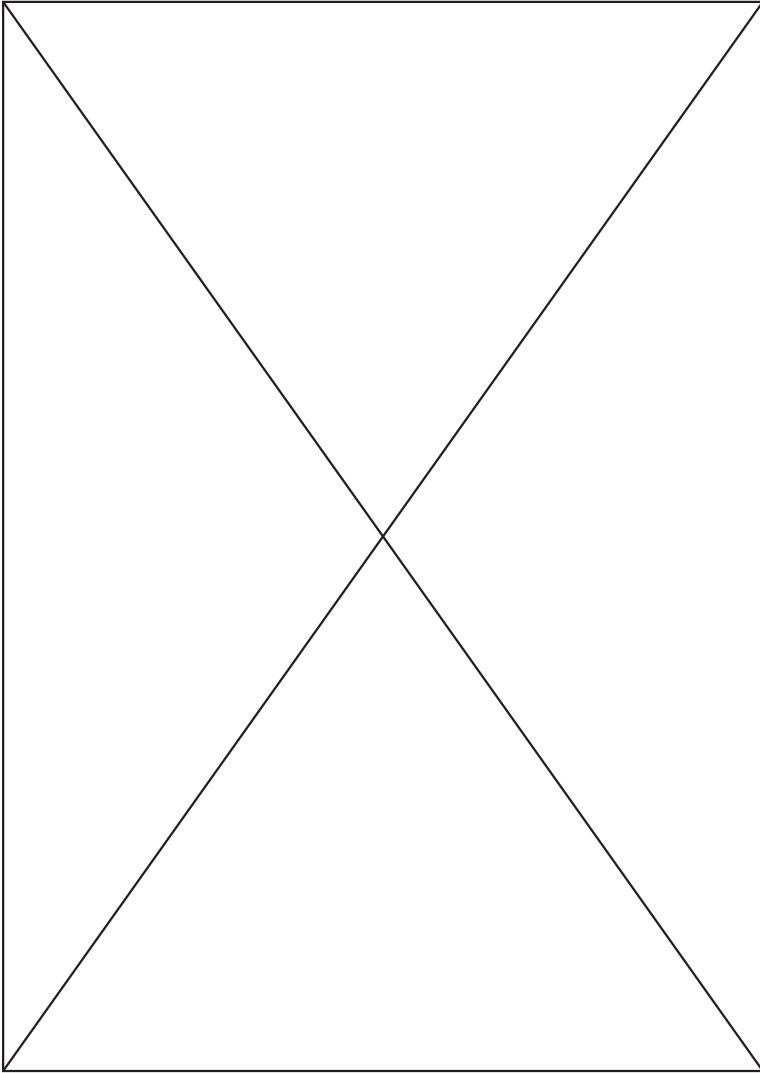

**Guía Rápida Española**

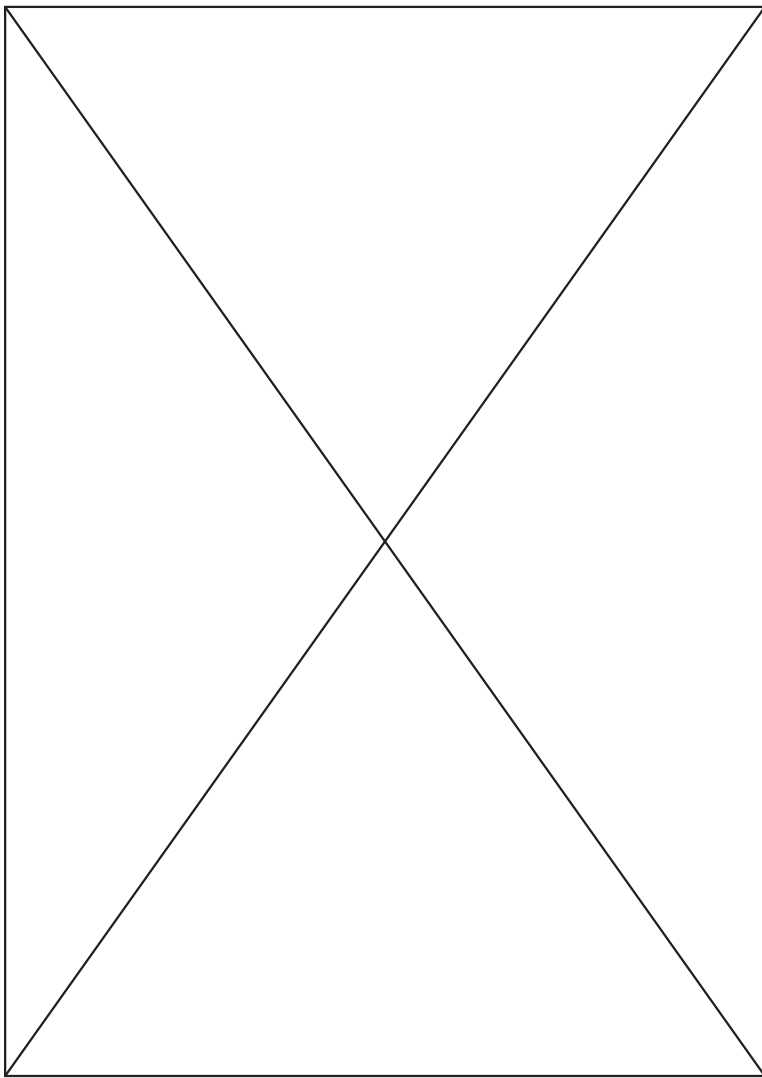

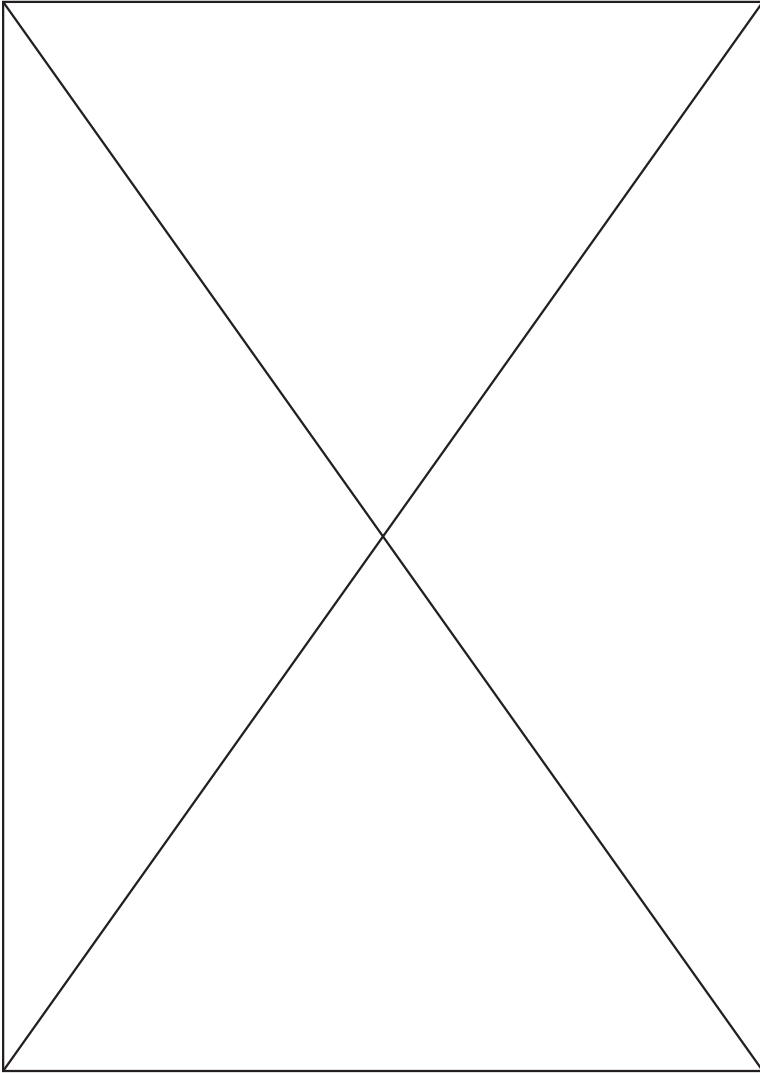

Customer services

**Shop**  
**Accessories!**

for all your Panasonic gear

Go to

<http://shop.panasonic.com/support>

Get everything you need to get the most out of  
your Panasonic products

Accessories & Parts for your Camera, Phone, A/V  
products, TV, Computers & Networking, Personal  
Care, Home Appliances, Headphones, Batteries,  
Backup Chargers & more...

**Customer Services Directory**

For Product Information, Operating Assistance,  
Parts, Owner's Manuals, Dealer and Service info  
go to <http://shop.panasonic.com/support>

For the hearing or speech impaired TTY: 1- 877-833-8855

As of June 2015

## Limited Warranty (ONLY FOR U.S.A.)

# Panasonic Products Limited Warranty

### Limited Warranty Coverage (For USA Only)

If your product does not work properly because of a defect in materials or workmanship, Panasonic Corporation of North America (referred to as "the warrantor") will, for the length of the period indicated on the chart below, which starts with the date of original purchase ("warranty period"), at its option either (a) repair your product with new or refurbished parts, (b) replace it with a new or a refurbished equivalent value product, or (c) refund your purchase price. The decision to repair, replace or refund will be made by the warrantor.

| Product or Part Name | Parts        | Labor        |
|----------------------|--------------|--------------|
| Telephone            | One (1) Year | One (1) Year |

During the "Labor" warranty period there will be no charge for labor. During the "Parts" warranty period, there will be no charge for parts. This Limited Warranty excludes both parts and labor for non-rechargeable batteries, antennas, and cosmetic parts (cabinet). This warranty only applies to products purchased and serviced in the United States. This warranty is extended only to the original purchaser of a new product which was not sold "as is".

**Mail-In Service**--Online Repair Request

### Online Repair Request

To submit a new repair request and for quick repair status visit our Web Site at <http://shop.panasonic.com/support>

When shipping the unit, carefully pack, include all supplied accessories listed in the Owner's Manual, and send it prepaid, adequately insured and packed well in a carton box. When shipping Lithium Ion batteries please visit our Web Site at <http://shop.panasonic.com/support> as Panasonic is committed to providing the most up to date information. Include a letter detailing the complaint, a return address and provide a daytime phone number where you can be reached. A valid registered receipt is required under the Limited Warranty.

**IF REPAIR IS NEEDED DURING THE WARRANTY PERIOD, THE PURCHASER WILL BE REQUIRED TO FURNISH A SALES RECEIPT/PROOF OF PURCHASE INDICATING DATE OF PURCHASE, AMOUNT PAID AND PLACE OF PURCHASE. CUSTOMER WILL BE CHARGED FOR THE REPAIR OF ANY UNIT RECEIVED WITHOUT SUCH PROOF OF PURCHASE.**

## Appendix

---

### **Limited Warranty Limits and Exclusions**

This warranty ONLY COVERS failures due to defects in materials or workmanship, and DOES NOT COVER normal wear and tear or cosmetic damage. The warranty ALSO DOES NOT COVER damages which occurred in shipment, or failures which are caused by products not supplied by the warrantor, or failures which result from accidents, misuse, abuse, neglect, mishandling, misapplication, alteration, faulty installation, set-up adjustments, misadjustment of consumer controls, improper maintenance, power line surge, lightning damage, modification, introduction of sand, humidity or liquids, commercial use such as hotel, office, restaurant, or other business or rental use of the product, or service by anyone other than a Factory Service Center or other Authorized Servicer, or damage that is attributable to acts of God.

**THERE ARE NO EXPRESS WARRANTIES EXCEPT AS LISTED UNDER "LIMITED WARRANTY COVERAGE".**

**THE WARRANTOR IS NOT LIABLE FOR INCIDENTAL OR CONSEQUENTIAL DAMAGES RESULTING FROM THE USE OF THIS PRODUCT, OR ARISING OUT OF ANY BREACH OF THIS WARRANTY.**

(As examples, this excludes damages for lost time, travel to and from the servicer, loss of or damage to media or images, data or other memory or recorded content. The items listed are not exclusive, but for illustration only.)

**ALL EXPRESS AND IMPLIED WARRANTIES, INCLUDING THE WARRANTY OF MERCHANTABILITY, ARE LIMITED TO THE PERIOD OF THE LIMITED WARRANTY.**

Some states do not allow the exclusion or limitation of incidental or consequential damages, or limitations on how long an implied warranty lasts, so the exclusions may not apply to you. This warranty gives you specific legal rights and you may also have other rights which vary from state to state. If a problem with this product develops during or after the warranty period, you may contact your dealer or Service Center. If the problem is not handled to your satisfaction, then write to:

Consumer Affairs Department  
Panasonic Corporation of North America  
661 Independence Pkwy  
Chesapeake, VA 23320

**PARTS AND SERVICE, WHICH ARE NOT COVERED BY THIS LIMITED WARRANTY, ARE YOUR RESPONSIBILITY.**

As of June 2015

**Index**

- # 3-way conference: 19
- A** Additional handset: 40
  - Alarm: 37
  - Answering calls: 17
  - Answering system
    - Call screening: 49
    - Erasing messages: 45, 46, 48
    - Greeting message: 44
    - Greeting only: 49
    - Listening to messages: 45, 48
    - New message alerting: 46
    - Number of rings: 49
    - Recording time: 49
    - Remote access code: 48
    - Remote operation: 47
    - Ring count: 49
    - Toll saver: 49
    - Turning on/off: 44
  - Auto intercom: 21
  - Auto talk: 17, 34
  - Automated callers block: 25
- B** Baby monitor: 38
  - Battery: 10, 11
- C** Call block: 23
  - One ring for blocked call: 24
  - Call share: 19, 34
  - Call waiting: 18
  - Call Waiting Caller ID: 18
  - Caller ID number auto edit: 34, 43
  - Caller ID service: 42
  - Caller list: 42
  - Caller list edit: 43
  - Cell locator: 20
  - Chain dial: 28
  - CID (Caller ID): 42
  - Conference calls: 19
  - Control type: 13
  - Customer support: 35
- D** Date and time: 14
  - Dialing mode: 15
  - Direct command code: 30
  - Display
    - Contrast: 34
    - Language: 14
- E** Eco mode: 12
  - Equalizer: 18
  - Error messages: 54
- F** Flash: 18, 34
- G** Groups: 27
- H** Handset
  - Deregistration: 41
  - Locator: 20
  - Name: 40
  - Registration: 40
  - Hold: 17
- I** Intercom: 20
- K** Key detector: 33, 35
  - Key tone: 34
- L** Line mode: 34
  - Low battery alert: 15
- M** Making calls: 16
  - Missed calls: 42
  - Mute: 17
- N** Noise reduction: 18
- P** Pause: 16
  - Phonebook: 27
  - Power failure (power backup operation): 21
- R** Redialing: 16
  - Ringer ID: 28
  - Ringer tone: 32
  - Rotary/pulse service: 18
- S** Silent mode: 37
  - Speed dial: 29
  - SP-PHONE (Speakerphone): 16
- T** Talking Caller ID: 42
  - Temporary tone dialing: 18
  - Time adjustment: 32
  - Transferring calls: 19
  - Troubleshooting: 55
  - TTY: 68
- V** VM (Voicemail): 50
  - Voice announcement language: 14
  - Voice paging: 20
  - Voicemail: 50
  - Volume
    - Receiver: 16
    - Ringer (Base unit): 17
    - Ringer (Handset): 17, 32
    - Ringer for intercom call (Handset): 32
    - Speaker: 16
- W** Wall mounting: 51

# IMPORTANT!

If your product is not working properly. . .

- ① **Reconnect AC adaptor to the base unit.**
- ② **Check if telephone line cord is connected.**
- ③ **Use rechargeable Ni-MH batteries.**  
(Alkaline/Manganese/Ni-Cd batteries CANNOT be used.)
- ④ **Read troubleshooting page in the Operating Instructions.**



Visit our Web site: <http://shop.panasonic.com/support>

- **FAQ and troubleshooting hints are available.**

#### For your future reference

We recommend keeping a record of the following information to assist with any repair under warranty.

|  |                  |
|--|------------------|
| Serial No.<br>(found on the bottom of the base unit) | Date of purchase |
| Name and address of dealer                           |                  |
| Attach your purchase receipt here.                   |                  |

Panasonic Corporation of North America

Two Riverfront Plaza, Newark, NJ 07102-5490

© Panasonic Corporation 2018

Printed in Malaysia



\*PNQX8639ZA\*

**PNQX8639ZA** PP1117HD0