

## Operating Instructions

---

SIP Cordless Phone

Model No. **KX-TGP600**

SIP Cordless Handset

Model No. **KX-TPA60**

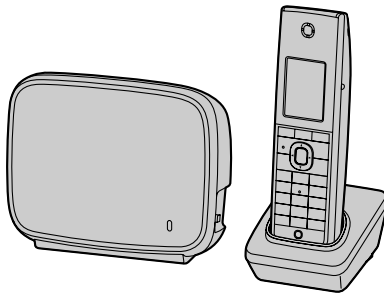

**KX-TGP600**

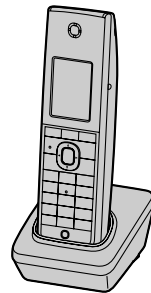

**KX-TPA60**

Thank you for purchasing this Panasonic product.

Please read this manual carefully before using this product and save this manual for future use.

Please use only the batteries provided and charge the batteries for about 6 hours before using the handset for the first time. For details, see "Charging the Batteries" in this manual.

### Note

- In this manual, the suffix of each model number is omitted unless necessary.

# Introduction

---

## Outline

This manual describes information about the installation and operation of KX-TGP600/KX-TPA60.

## Related Documentation

- **Quick Start Guide**

Describes basic information about the installation and safety precautions to prevent personal injury and/or damage to property.

- **Administrator Guide**

Describes detailed information on the configuration and management of this unit.

Manuals and supporting information are provided on the Panasonic Web site at:

<http://panasonic.net/pcc/support/sipphone>

## Note

- The contents and design of the software are subject to change without notice.

## For Future Reference

Record the information in the space below for future reference.

## Note

- The serial number of this product may be found on the labels affixed to the following places:

- base unit: the back of the unit.
- handset: the inside of the battery compartment on the back of the handset.
- charger: the bottom of the charger.

You should note the serial numbers of these units in the space provided and retain this manual as a permanent record of your purchase to aid in identification in the event of theft.

MODEL NO.	_____
SERIAL NO.	_____
DATE OF PURCHASE	_____
NAME OF DEALER	_____
DEALER'S ADDRESS	_____ _____ _____
DEALER'S TEL. NO.	_____

**Important Information**

Data Security .....4  
Additional Information .....5  
For Best Performance .....9  
Battery Information .....10

**Before Operating the Telephone**

Accessory Information .....12  
Location of Controls .....14  
Handset Functions .....16  
Soft Keys .....17  
Other Icons .....17

**Feature Operations**

Making Calls .....18  
Receiving Calls .....18  
During a Conversation .....18  
Useful Features .....18

**Customizing the Telephone**

Using the Handset Phonebook .....19  
Entering Characters .....19  
Changing Handset Settings .....19

**Installation and Setup**

Installation and Setup .....20

**Appendix**

Appendix .....23  
Troubleshooting .....23  
Error Messages .....23

**Index**

Index.....24

### **Data Security**

- This telephone communicates using digital signals that are difficult to intercept. However, it is possible that the signals could be intercepted by a third party.
- To avoid unauthorized access to this product:
  - Keep the password (e.g., PIN for registration) secret.
  - Change the default password.
  - Set a password that is random and cannot be easily guessed.
  - Change the password regularly.
- This product can store your private/confidential information. To protect your privacy/confidentiality, we recommend that you erase the information such as the phonebook or call log from the memory before you dispose of, transfer or return the product, or have the product repaired.
- Set the password when you register the handset to the base unit.
- It is recommended that you lock the phonebook to prevent stored information from being leaked when you carry the handset or if the handset is lost.

## Additional Information

### Information for Users on Collection and Disposal of Old Equipment and used Batteries



These symbols on the products, packaging, and/or accompanying documents mean that used electrical and electronic products and batteries should not be mixed with general household waste.

For proper treatment, recovery and recycling of old products and used batteries, please take them to applicable collection points, in accordance with your national legislation and the Directives 2002/96/EC and 2006/66/EC.

By disposing of these products and batteries correctly, you will help to save valuable resources and prevent any potential negative effects on human health and the environment which could otherwise arise from inappropriate waste handling. For more information about collection and recycling of old products and batteries, please contact your local municipality, your waste disposal service or the point of sale where you purchased the items.

Penalties may be applicable for incorrect disposal of this waste, in accordance with national legislation.

#### **For business users in the European Union**

If you wish to discard electrical and electronic equipment, please contact your dealer or supplier for further information.



#### **Information on Disposal in other Countries outside the European Union**

These symbols are only valid in the European Union. If you wish to discard these items, please contact your local authorities or dealer and ask for the correct method of disposal.



#### **Note for the battery symbol (bottom two symbol examples):**

This symbol might be used in combination with a chemical symbol. In this case it complies with the requirement set by the Directive for the chemical involved.

The following declaration is applicable to KX-TGP600/KX-TPA60 only

# CE0470

This device is a DECT Portable station operating in the frequency band of 1880 MHz to 1900 MHz. The usage of this device is generally allowed in all EU countries.

Panasonic System Networks Co., Ltd. declares that this equipment is in compliance with the essential requirements and other relevant provisions of Radio & Telecommunications Terminal Equipment (R&TTE) Directive 1999/5/EC.

Declarations of Conformity for the relevant Panasonic products described in this manual are available for download by visiting:

<http://www.ptc.panasonic.eu>

Contact to Authorized Representative:  
Panasonic Testing Center  
Panasonic Marketing Europe GmbH  
Winsbergring 15, 22525 Hamburg, Germany

## Important Information

---

### For Users in New Zealand

- This equipment shall not be set to make automatic calls to the Telecom '111' Emergency Service.

### PTC General Warning

- The grant of a Telepermit for any item of terminal equipment indicates only that Telecom has accepted that the item complies with minimum conditions for connection to its network. It indicates no endorsement of the product by Telecom, nor does it provide any sort of warranty. Above all, it provides no assurance that any item will work correctly in all respects with another item of Telepermitted equipment of a different make or model, nor does it imply that any product is compatible with all of Telecom's network services.

### The Use of IP Networks through the PSTN

- Internet Protocol (IP) by its nature introduces delay into speech signals as each data packet is formulated and addressed. Telecom Access Standards recommends that suppliers, designers and installers using this technology for calls to or from the PSTN refer to ITU E Model requirements in the design of their networks. The overall aim is to minimize delay, distortion and other transmission impairments, particularly for those calls involving cellular and international networks, which already suffer extensive delay.

### Echo cancellation

- Echo cancelers are not normally required in the Telecom PSTN because geographic delays are acceptable where CPE return loss is maintained within Telepermit limits. However, those private networks making use of Voice over IP technology are required to provide echo cancellation for all voice calls. The combined effect of audio / VoIP conversion delay and IP routing delay can cause the echo cancellation time of  $\geq 64$  ms to be required.

### PTC200 6.11.1 (3) All Customer Equipment (fail safe requirements)

- Under power failure conditions this appliance may not operate. Please ensure that a separate telephone, not dependent on local power, is available for emergency use.

---

### For Users in Australia and the United Kingdom

- This unit is capable of being used in conjunction with hearing aids fitted with inductive coil pick-ups. The handset should be held as for normal conversation. For operation, the hearing aid should be set to its "T" position or as directed in the operating instructions for the hearing aid.
- This unit is designed to aid the visually handicapped to locate dial keys and buttons.



---

### For Users in the United Kingdom

- This unit is designed to be installed under controlled conditions of ambient temperature and a relative humidity.
- Avoid installing the unit in damp or humid environments, such as bathrooms or swimming pools.
- 999 and 112 can be dialed on the product after accessing the outside line for the purpose of making outgoing calls to the BT emergency (999) and (112) services.

---

### For Users in the United States Only

#### FCC and Other Information

Privacy of communications may not be ensured when using this phone.

#### FCC RF Exposure Warning:

- This product complies with FCC radiation exposure limits set forth for an uncontrolled environment.
- To comply with FCC RF exposure requirements, the base unit must be installed and operated 20 cm (8 inches) or more between the product and all person's body.
- This product may not be collocated or operated in conjunction with any other antenna or transmitter.
- The handset may be carried and operated with only the specific provided belt-clip. Other non-tested belt-clips or similar body-worn accessories may not comply and must be avoided.

FCC ID can be found inside the battery compartment or on the bottom of the units.

### Note

- This equipment has been tested and found to comply with the limits for a Class B digital device, pursuant to Part 15 of the FCC Rules. These limits are designed to provide reasonable protection against harmful interference in a residential installation. This equipment generates, uses, and can radiate radio frequency energy and, if not installed and used in accordance with the instructions, may cause harmful interference to radio communications. However, there is no guarantee that interference will not occur in a particular installation. If this equipment does cause harmful interference to radio or television reception, which can be determined by turning the equipment off and on, the user is encouraged to try to correct the interference by one or more of the following measures:
  - Reorient or relocate the receiving antenna.
  - Increase the separation between the equipment and receiver.
  - Connect the equipment to an outlet on a circuit different from that to which the receiver is connected.
  - Consult the dealer or an experienced radio/TV technician for help.

This device complies with Part 15 of the FCC Rules. Operation is subject to the following two conditions:

(1) this device may not cause harmful interference, and (2) this device must accept any interference received, including interference that may cause undesired operation.

WHEN PROGRAMMING EMERGENCY NUMBERS AND/OR MAKING TEST CALLS TO EMERGENCY NUMBERS:

1. Remain on the line and briefly explain to the dispatcher the reason for the call before hanging up.
2. Perform such activities during off-peak hours, such as early morning or late evening.

### CAUTION

Any changes or modifications not expressly approved by the party responsible for compliance could void the user's authority to operate this product.

### Hearing Aid Compatibility

This telephone provides magnetic coupling for hearing aids as defined by the FCC in 47 CFR Section 68.316. Use only handsets or other acoustic devices with this equipment that are compliant with the hearing aid compatibility requirements of FCC Part 68.

When you hold the phone to your ear, noise might be heard in your Hearing Aid. Some Hearing Aids are not adequately shielded from external RF (radio frequency) energy. If noise occurs, use an optional headset accessory or the speakerphone option (if applicable) when using this phone. Consult your audiologist or Hearing Aid manufacturer about the availability of Hearing Aids which provide adequate shielding to RF energy commonly emitted by digital devices.

### Compliance with TIA-1083 standard:



Telephone handsets identified with this logo have reduced noise and interference when used with T-Coil equipped hearing aids and cochlear implants.

## Important Information

---

### For Product Service

- Call 1-800-211-PANA (7262) for the location of your nearest authorized service center.
- Panasonic's e-mail address for customer inquiries:  
consumerproducts@panasonic.com  
For customers in the USA and Puerto Rico ONLY.

- This cordless telephone is designed for use in the United States of America. Sale or use of this product in other countries may violate local laws.
- Ce téléphone sans fil est conçu pour être utilisé aux États-Unis d'Amérique. La vente ou l'emploi de cet appareil dans certains autres pays peut constituer une infraction à la législation locale.
- Este teléfono sin cordón fue elaborado para su uso en los Estados Unidos de América. La venta o el empleo de este producto en ciertos países puede constituir una violación de la legislación local.
- このコードレス電話機は、日本国外での使用を目的として設計されており、日本国内での使用は法律違反となります。従って、当社では日本国内においては原則として修理などのサービスは致しかねます。

---

### For Users in Canada Only

#### Industry Canada Notices and Other Information

This product meets the applicable Industry Canada technical specifications.

#### Note

- This device complies with Industry Canada licence-exempt RSS standard(s). Operation is subject to the following two conditions: (1) this device may not cause interference, and (2) this device must accept any interference, including interference that may cause undesired operation of the device.
- Privacy of communications may not be ensured when using this phone.
- Some wireless telephones operate at frequencies that may cause interference to nearby TVs and VCRs. To minimize or prevent such interference, the wireless telephone should not be placed near, or on top of, a TV or VCR. If interference is experienced, move the wireless telephone farther away from the TV or VCR. This will often reduce, or eliminate, interference.
- This transmitter must not be co-located or operated in conjunction with any other antenna or transmitter.
- This Class B digital apparatus complies with Canadian ICES-003.

#### CAUTION

Any changes or modifications not expressly approved by the party responsible for compliance could void the user's authority to operate this product.

#### RF Exposure Warning:

- This product complies with IC radiation exposure limits set forth for an uncontrolled environment.
- To comply with IC RF exposure requirements, the base unit must be installed and operated 20 cm (8 inches) or more between the product and all person's body.
- This product may not be collocated or operated in conjunction with any other antenna or transmitter.
- The handset may be carried and operated with only the specific provided belt-clip. Other non-tested belt-clips or similar body-worn accessories may not comply and must be avoided.



## **For Best Performance**

### **Operating Range**

- The range of operation depends on the topography of your office, weather, or usage conditions, because signals are transmitted between the base unit and the handset by radio waves.
- Normally, you get greater range outdoors than indoors. If there are obstacles such as walls, noise may interfere with your telephone calls. In particular, high metal shelves or reinforced concrete walls will restrict your operating range.
- A handset may not work when it is too far from the base unit depending on the structure of the building.
- We strongly suggest you hold the bottom half of the handset to ensure better call quality. Because, the antenna is located in the upper half of the handset.

### **Noise**

Occasional noise or interference may occur due to electromagnetic radiation from objects such as refrigerators, microwave ovens, faxes, TVs, radios, or personal computers. If noise disturbs your telephone calls, keep the handset away from these electrical appliances.

### **Environment**

- Keep the product away from heating appliances and devices that generate electrical noise, such as fluorescent lamps and motors. These noise sources can interfere with performance of the product.
- Do not place the product in rooms where the temperature is less than 0 °C (32 °F) or greater than 40 °C (104 °F).
- Allow 10 cm (3-15/16 in) clearance around the product for proper ventilation.
- Avoid environments with excessive smoke, dust, moisture, mechanical vibration, shock, or direct sunlight.
- The apparatus is designed to be installed and operated under controlled conditions of ambient temperature and a relative humidity.

### **Routine Care**

- Unplug the AC adaptor from the AC outlet and disconnect the LAN cable before cleaning.
- Wipe the product with a soft cloth.
- Do not clean the product with abrasive powder or with chemical agents such as benzine or thinner.
- Do not use liquid cleaners or aerosol cleaners.
- Clean the terminal of the charger periodically.

### **Placement**

- Do not place heavy objects on top of the product.
- Care should be taken so that objects do not fall onto, and liquids are not spilled into, the product.
- Place the charger on a flat surface.

# Battery Information

After batteries are fully charged (at 25 °C [77 °F]):

Operation	Operating Time
While Talking (Backlight off)	Up to about 10 H
While not in use (Standby)	Up to about 168 H

- Operating time may be shorter than listed above depending on usage conditions and ambient temperature.
- Batteries will drain slowly even while the handset is turned off.
- The handset can receive calls while charging.
- Battery consumption increases when the handset is out of range (if "Y" flashes, turn the handset off).
- **Clean the handset and the charger contacts with a soft, dry cloth once a month. Clean more often if the unit is subject to grease, dust or high humidity.** Otherwise batteries may not charge properly.

## Low Battery Warning

Batteries needs to be charged in the following situations:

- The battery level indicator displays as empty ("■") and the alarm sounds\*1.
- "Charge Battery" is displayed. In this situation, the handset cannot be operated.

\*1 If the low battery warning occurs during a conversation, the handset will turn off in one minute.

## Replacing the Batteries

If the battery level indicator displays as empty ("■") after using the phone for a short time, even when the batteries have been fully charged, the batteries should be replaced.

Before replacing the batteries, make sure the low battery warning is displayed, then turn off the power to prevent memory loss. Replace the batteries and charge the new batteries for about 6 hours.

If you replace the batteries before the low battery warning appears, the battery strength icon may display an incorrect reading. In this case, use the handset as normal with the new batteries installed.

When the low battery warning is displayed, charge the batteries for about 6 hours. The battery strength icon will then display the correct reading.

- Please use AAA Ni-MH 1.2 V, 630 mAh batteries only. (Contact your phone system dealer/service provider.)
- There is a danger of explosion if the batteries are incorrectly replaced.



Nickel metal hydride batteries that are recyclable power the product you have purchased. Please call 1-800-8-BATTERY for information on how to recycle these batteries.

## Important Notice Concerning the Correct Use and Charging of Ni-MH Batteries

Batteries, due to their construction, undergo some wear and tear. The lifetime of batteries also depends on correct maintenance. Charging and discharging are the most important factors. You should take notice of the following to maintain the life of the batteries as long as possible.

Ni-MH batteries have a kind of memory, the "memory effect". If fully charged batteries are used several times only for 15 minutes in the handset and then recharged, the capacity of the batteries will be reduced







to 15 minutes due to the memory effect. Therefore you should discharge the batteries completely, i.e. use them in the handset until the battery level indicator displays as empty ("  "). Then recharge them as described in the manual. After the memory effect has occurred, it is possible to achieve almost complete capacity of the Ni-MH batteries by charging and discharging several times one after another. Ni-MH batteries can also self-discharge. This self-discharge depends on the ambient temperature. At temperatures under 0 °C (32 °F), the self-discharge will be the lowest. High humidity and high temperatures support the self-discharge. Also long-term storage will lead to self-discharge.

### **CAUTION**

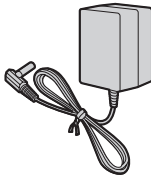
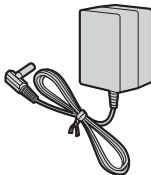
RISK OF EXPLOSION IF BATTERY IS REPLACED BY AN INCORRECT TYPE. DISPOSE OF USED BATTERIES ACCORDING TO THE INSTRUCTIONS.

## Accessory Information

### Included Accessories

AC adaptor for Base unit: 1		
	Model No.	Part No.
	KX-TGP600B	PQLV219
	KX-TGP600UKB	PQLV219E
	KX-TGP600CEB	PQLV219CE
	KX-TGP600RUB	PQLV219CE
	KX-TGP600ALB	PQLV219AL
	KX-TGP600LCB	PQLV219BX
	KX-TGP600LAB	PQLV219
AC adaptor for Charger: 1		
	Model No.	Part No.
	KX-TPA60B	PNLV226
	KX-TPA60UKB	PNLV226E
	KX-TPA60CEB	PNLV226CE
	KX-TPA60RUB	PNLV226CE
	KX-TPA60ALB	PNLV226AL
	KX-TPA60LCB	PNLV226BX
	KX-TPA60LAB	PNLV226
Charger: 1	Batteries*1: 2	Battery Cover*2: 1
		
Belt Clip: 1	Ethernet Cable: 1	
		

\*1 Rechargeable AAA Ni-MH 1.2 V, 630 mAh batteries

\*2 The battery cover comes attached to the handset.

**Optional Accessories**

**Note**

- The actual product may differ slightly from the images below.

Item	Model No.		
Additional Handset*1	KX-TPA60 (Basic)	KX-UDT121 (Slim Bluetooth)	KX-UDT131 (Tough Bluetooth)
DECT Repeater	KX-A406		
Headset	KX-TCA400	KX-TCA430	
			

\*1 You can expand your phone system by registering optional handsets (8 max.) to a single base unit.

## Location of Controls

### Handset

The headset is an optional accessory.

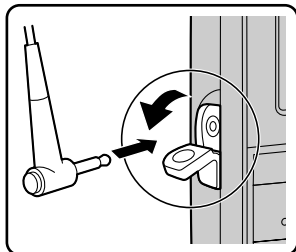

Open the cover.

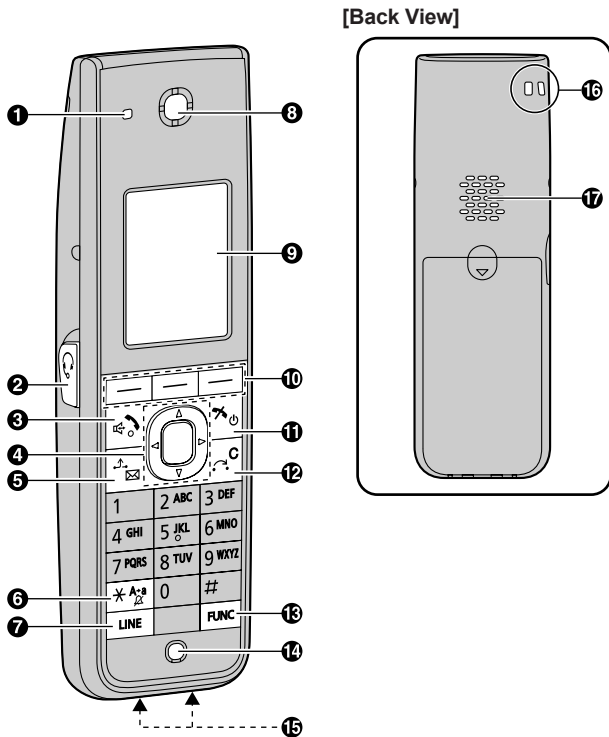
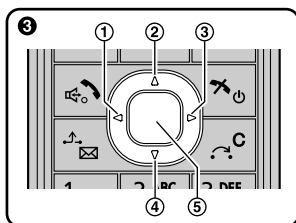

- ❶ Ringer/Charge Indicator
- ❷ Headset Jack
- ❸ TALK/SP-PHONE (Speakerphone) Key
- ❹ Navigator Key

The Navigator Key includes four arrow keys and a center key. The arrow keys are used to adjust the ringer/receiver volume or move the cursor to select an item. The center key is used to confirm a selection. If in standby mode, pressing the keys perform the following functions:

- ❶ LEFT → Used to display the Incoming call log.
- ❷ UP → Used to adjust the ringer volume.
- ❸ RIGHT → Used to open the phonebook.
- ❹ DOWN → Used to display the Outgoing call log.
- ❺ CENTER → Used to display the Menu.

- ❽ HOLD/Voice Message Key
- ❾ Silent Mode Key

- 7** Line Key  
Used to confirm the line status of VoIP server.
  - 8** Receiver
  - 9** Display
  - 10** Soft Keys
  - 11** POWER/CANCEL Key
  - 12** TRANSFER/CLEAR Key
  - 13** Function Key
  - 14** Microphone
  - 15** Charge Contacts
  - 16** Strap Holes
  - 17** Speaker
- 

**Base unit**

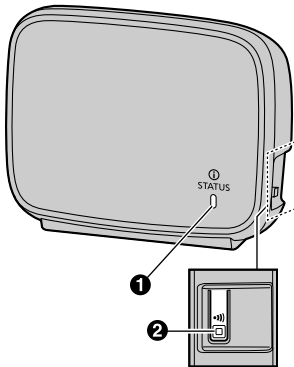

- 1** Status Indicator
- 2** Handset locator button

## Handset Functions

### Display



#### 1 Pictograph

<p>Signal Strength Indicator</p> <p>Strong</p> <p>Medium</p> <p>Weak</p> <p>Very weak</p> <p>Out of range</p>	<p>Battery Indicator</p> <p>Full</p> <p>Medium</p> <p>Low</p> <p>Needs to be charged.</p>
<p> Off-hook Status</p> <p> Intercom Indicator</p> <p> Voice Message</p> <p> Navigation Key Guidance</p>	<p> Incoming Call Log</p> <p> Outgoing Call Log</p>

#### 2 Handset Status Information

	Ringer Off	<b>Fwd</b>	Call Forwarding (For the United States Only)
	Silent Mode		Call Forwarding (For all Countries except the United States)
	Auto Answer	<b>DND</b>	Do Not Disturb (For the United States Only)
	Registration number of handset		Do Not Disturb (For all Countries except the United States)



- ③ Time Display
- ④ Date or Missed Call Display
- ⑤ Handset number and Name
- ⑥ Soft Keys

---

## **Soft Keys**

---

## **Other Icons**

## **Making Calls**

---

---

## **Receiving Calls**

---

---

## **During a Conversation**

---

---

## **Useful Features**

---

---

## **Using the Handset Phonebook**

---

---

## **Entering Characters**

---

---

## **Changing Handset Settings**

---

---

# Installation and Setup

## Connections

### WARNING

- To reduce the risk of fire or electric shock, do not overload AC outlets and extension cords.
- Do not bundle the AC adaptor cord with the power cords of machines located nearby.
- Completely insert the AC adaptor/power plug into the AC outlet. Failure to do so may cause electric shock and/or excessive heat resulting in a fire.
- Regularly remove any dust, etc. from the AC adaptor/power plug by pulling it from the power outlet, then wiping with a dry cloth. Accumulated dust may cause an insulation defect from moisture, etc. resulting in a fire.

### Base unit

Connect the AC adaptor and the Ethernet cable to the base unit.

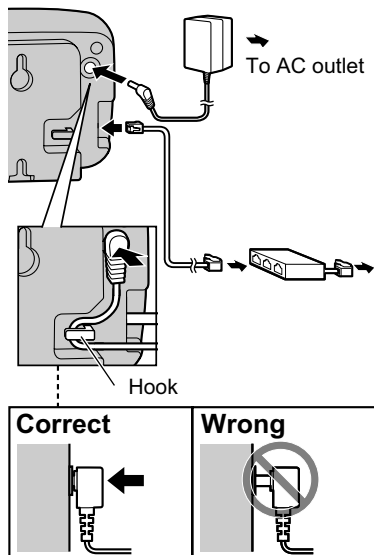

### Charger

Connect the AC adaptor to the charger.

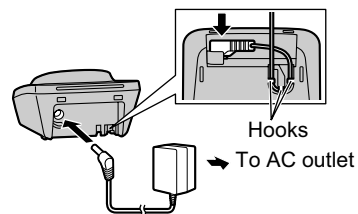

- The AC adaptor should be connected to a vertically oriented or floor-mounted AC outlet. Do not connect the AC adaptor to a ceiling-mounted AC outlet, as the weight of the adaptor may cause it to become disconnected.
- Fasten the AC adaptor cord to the cord holder.
- Use only the included Panasonic AC adaptor.

---

### Battery Installation

Open the battery cover, insert the batteries, and close the cover as indicated below.

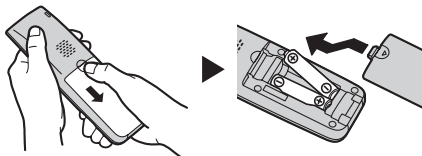

---

### Charging the Batteries

At the time of shipment, the batteries are not charged. Please charge the batteries for about 6 hours before using the handset for the first time.

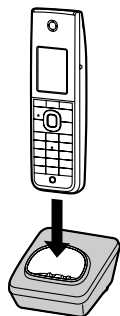

- The charge indicator will turn off when the batteries are fully charged. For more information about charging batteries, see “Battery Information”, Page 10.
- It is normal for the handset and charger to feel warm while the batteries are charging.
- Keep devices sensitive to magnetic fields away from the charger.
- Use only the included charger.

## Wall Mounting

### Note

- Make sure that the wall and the fixing method are strong enough to support the weight of the unit.

### Base unit

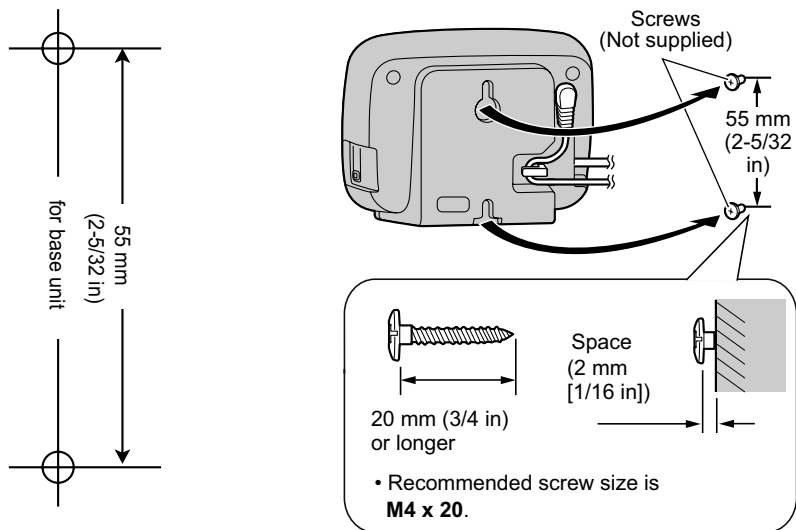

- Please copy this page and use as a reference for wall mounting. Make sure to set the print size to correspond with the size of this page. If the dimension of the paper output still deviates slightly from the measurement indicated here, use the measurement indicated here.
- When inserting screws, avoid pipes and electrical cables, etc. that may be present/buried.
- The screw heads should not be flush to the wall.
- Certain types of wall may require plugs to be anchored in the wall before the screws are inserted.

## Appendix

### Specifications

Item	Specifications
Standard	DECT 6.0 DECT
Frequency Band	DECT 6.0: 1920 MHz to 1930 MHz DECT (Latin America): 1910 MHz to 1920 MHz DECT (Other countries/areas): 1880 MHz to 1900 MHz
RF Transmission Power	DECT 6.0: Peak 115 mW DECT: Peak 250 mW
Power Supply	AC adaptor / PoE (IEEE 802.3af)
Maximum Power Consumption	Base unit: 3.0 W Charger: 2.0 W
Operating Environment	0 °C (32 °F) to 40 °C (104 °F)
Ethernet Port (LAN)	1 (RJ45)
Ethernet Interface	10Base-T/100Base-TX (Auto / 100MB-FULL / 100MB-HALF / 10MB-FULL / 10MB-HALF)
CAT-1q	2.0
Wideband Codec	G.722 / G.722.2 (WB-AMR)
Narrowband Codec	G.711a-law / G.711-law / G.729a / G.729b
Multiple Line	8
Multiple Handset	8
Simultaneous Voice Calls (Narrowband Mode)	Talk 8 + Conference 2
Simultaneous Voice Calls (Wideband Mode)	Talk 4 + Conference 2 (WB-AMR : Talk 2)

## Troubleshooting

## Error Messages

# **Index**

- A** AC adaptor: 12  
Accessories: 12
- B** Base unit: 15
  - Connection: 20
  - Wall mounting: 22Batteries: 12
  - Charging: 21
  - Installation: 21Battery cover: 12  
Battery information: 10  
Belt clip: 12
- C** Characters
  - Entering: 19Charger: 12
  - Connection: 20Controls
  - Locations of: 14
- D** Display: 16
- E** Error messages: 23  
Ethernet cable: 12
- H** Handset: 14
- O** Optional accessories: 13
- S** Soft Keys: 17  
Specifications: 23
- T** Text
  - Entering: 19Troubleshooting: 23









## **Panasonic System Networks Co., Ltd.**

1-62, 4-chome, Minoshima, Hakata-ku, Fukuoka 812-8531, Japan

**<http://panasonic.net/pcc/support/sipphone>**

## **Panasonic Corporation of North America**

Two Riverfront Plaza, Newark, NJ 07102-5490

**<http://www.panasonic.com/sip>**

## **Panasonic Canada Inc.**

5770 Ambler Drive, Mississauga, Ontario, L4W 2T3

**<http://www.panasonic.ca>**

### Copyright:

This material is copyrighted by Panasonic System Networks Co., Ltd., and may be reproduced for internal use only. All other reproduction, in whole or in part, is prohibited without the written consent of Panasonic System Networks Co., Ltd.