

Panasonic[®]

Quick Guide
SIP Cordless Phone

Model No. **KX-TGP500** **B04**

Model No. **KX-TGP550** **T04**

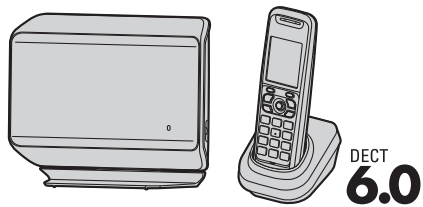

Model shown is KX-TGP500.



Model shown is KX-TGP550.

Thank you for purchasing a Panasonic product.

Charge the batteries for about 6 hours before initial use.

Please read these operating instructions before using the unit and save them for future reference.

Table of Contents

Introduction

About this guide 3
Accessory information..... 3

Important Information

For your safety 4
Important safety instructions..... 5
For best performance 5
Other information 5

Controls

Handset..... 7
Base unit..... 7

Basic Operations

Making calls using the handset..... 9
Making calls using the base unit (KX-TGP550
only) 9
Answering calls using the handset 10
Answering calls using the base unit (KX-TGP550
only) 10

Setting Up

Setting up the base unit 11
Setting up the handset 12
Note when setting up 12

Useful Information

FCC and other information 13

Index

Index 15

Introduction

About this guide

This guide explains how to use the basic features of KX-TGP500/KX-TGP550. For further information on operations and customising your phone, please read the User Guide on the website at: www.xxxxxxxxxx.xx
 For more information, contact your system administrator or network administrator.

Accessory information

No.	Accessory item/Part number	Quantity	
		KX-TGP500	KX-TGP550
①	AC adaptor for base unit/PQLV219	1	1
②	Ethernet cable	1	1
③	Corded handset	–	1
④	Corded handset cord	–	1
⑤	Rechargeable batteries	2	2
⑥	Handset cover*1	1	1
⑦	Belt clip	1	1
⑧	Charger	1	1
⑨	AC adaptor for charger/PQLV224	1	1

*1 The handset cover comes attached to the handset.

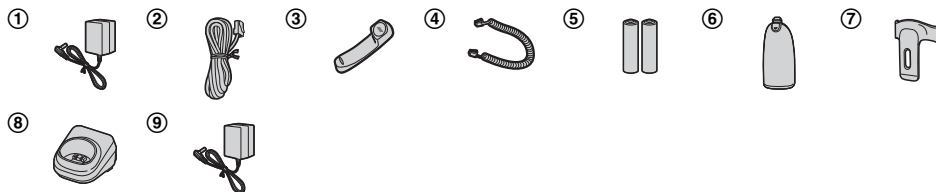

Important Information

For your safety

To prevent severe injury and loss of life/property, read this section carefully before using the product to ensure proper and safe operation of your product.

WARNING

Power connection

- Use only the power source marked on the product.
- Do not overload power outlets and extension cords. This can result in the risk of fire or electric shock.
- Completely insert the AC adaptor/power plug into the power outlet. Failure to do so may cause electric shock and/or excessive heat resulting in a fire.
- Regularly remove any dust, etc. from the AC adaptor/power plug by pulling it from the power outlet, then wiping with a dry cloth. Accumulated dust may cause an insulation defect from moisture, etc. resulting in a fire.
- Unplug the product from power outlets if it emits smoke, an abnormal smell, or makes an unusual noise. These conditions can cause fire or electric shock. Confirm that smoke has stopped emitting and contact the Panasonic Call Center at 1-800-211-PANA (1-800-211-7262).
- Unplug from power outlets and never touch the inside of the product if its casing has been broken open.
- Never touch the plug with wet hands. Danger of electric shock exists.

Installation

- To prevent the risk of fire or electrical shock, do not expose the product to rain or any type of moisture.
- Do not place or use this product near automatically controlled devices such as automatic doors and fire alarms. Radio waves emitted from this product may cause such devices to malfunction resulting in an accident.
- Do not allow the AC adaptor or LAN (Local Area Network) cord to be excessively pulled, bent or placed under heavy objects.

Operating safeguards

- Unplug the product from power outlets before cleaning. Do not use liquid or aerosol cleaners.
- Do not disassemble the product.
- Do not spill liquids (detergents, cleansers, etc.) onto the LAN (Local Area Network) cord plug, or allow it to become wet at all. This may cause a fire. If the LAN (Local Area Network) cord plug becomes wet, immediately pull it from the LAN (Local Area Network) wall jack, and do not use.
- KX-TGP550 only: Do not excessively pull the corded handset cord from the base unit. This may cause the base unit to fall, resulting in injury.

Medical

- Consult the manufacturer of any personal medical devices, such as pacemakers or hearing aids, to determine if they are adequately shielded from external RF (radio frequency) energy. (The product operates in the frequency range of 1.92 GHz to 1.93 GHz, and the RF transmission power is 115 mW (max.).)
- Do not use the product in health care facilities if any regulations posted in the area instruct you not to do so. Hospitals or health care facilities may be using equipment that could be sensitive to external RF energy.

CAUTION

Installation and relocation

- Never install LAN (Local Area Network) during an electrical storm.
- Never install LAN (Local Area Network) cord jacks in wet locations unless the jack is specifically designed for wet locations.
- Never touch uninsulated LAN (Local Area Network) or terminals unless the LAN (Local Area Network) has been disconnected at the network interface.
- Use caution when installing or modifying LAN (Local Area Network).
- The AC adaptor is used as the main disconnect device. Ensure that the AC outlet is installed near the product and is easily accessible.
- This product is unable to make calls when there is a power failure.

Battery

- We recommend using the batteries noted on page 3. **USE ONLY rechargeable Ni-MH batteries AAA (R03) size.**
- Do not mix old and new batteries.
- Do not open or mutilate the batteries. Released electrolyte from the batteries is corrosive and may cause burns or injury to the eyes or skin. The electrolyte is toxic and may be harmful if swallowed.
- Exercise care when handling the batteries. Do not allow conductive materials such as rings, bracelets, or keys to touch the batteries, otherwise a short circuit may cause the batteries and/or the conductive material to overheat and cause burns.
- Charge the batteries provided with or identified for use with this product only, in accordance with the instructions and limitations specified in this manual.
- Only use a compatible charger to charge the batteries. Do not tamper with the charger. Failure to follow these instructions may cause the batteries to swell or explode.

Important Information

Attention:



A nickel metal hydride battery that is recyclable powers the product you have purchased. Please call 1-800-8-BATTERY (1-800-822-8837) for information on how to recycle this battery.

Important safety instructions

When using your product, basic safety precautions should always be followed to reduce the risk of fire, electric shock, and injury to persons, including the following:

1. Do not use this product near water for example, near a bathtub, washbowl, kitchen sink, or laundry tub, in a wet basement or near a swimming pool.
2. Avoid using a telephone (other than a cordless type) during an electrical storm. There may be a remote risk of electric shock from lightning.
3. Do not use the telephone to report a gas leak in the vicinity of the leak.
4. Use only the power cord and batteries indicated in this manual. Do not dispose of batteries in a fire. They may explode. Check with local codes for possible special disposal instructions.

SAVE THESE INSTRUCTIONS

For best performance

Base unit location/avoiding noise

The base unit and other compatible Panasonic units use radio waves to communicate with each other.

- For maximum coverage and noise-free communications, place your base unit:
 - at a convenient, high, and central location with no obstructions between the cordless handset and base unit in an indoor environment.
 - away from electronic appliances such as TVs, radios, personal computers, wireless devices, or other phones.
 - facing away from radio frequency transmitters, such as external antennas of mobile phone cell stations. (Avoid putting the base unit on a bay window or near a window.)
- Coverage and voice quality depends on the local environmental conditions.
- If the reception for a base unit location is not satisfactory, move the base unit to another location for better reception.

Environment

- Keep the product away from electrical noise generating devices, such as fluorescent lamps and motors.
- The product should be kept free from excessive smoke, dust, high temperature, and vibration.
- The product should not be exposed to direct sunlight.
- Do not place heavy objects on top of the product.
- When you leave the product unused for a long period of time, unplug the product from the power outlet.
- The product should be kept away from heat sources such as heaters, kitchen stoves, etc. It should not be placed in rooms where the temperature is less than 0 °C (32 °F) or greater than 40 °C (104 °F). Damp basements should also be avoided.
- The maximum calling distance may be shortened when the product is used in the following places: Near obstacles such as hills, tunnels, underground, near metal objects such as wire fences, etc.
- Operating the product near electrical appliances may cause interference. Move away from the electrical appliances.

Routine care

- **Wipe the outer surface of the product with a soft moist cloth.**
- Do not use benzine, thinner, or any abrasive powder.

Other information

CAUTION: Risk of explosion if battery is replaced by an incorrect type. Dispose of used batteries according to the instructions.

Notice for product disposal, transfer, or return

- This product can store your private/confidential information. To protect your privacy/confidentiality, we recommend that you erase information such as phonebook or caller list entries from the memory before you dispose of, transfer, or return the product.

Important Information

Notice

- This product is designed for use in the United States of America. Sale or use of this product in other countries may violate local laws.
- Cet appareil est conçu pour être utilisé aux États-Unis d'Amérique. La vente ou l'emploi de cet appareil dans certains autres pays peut constituer une infraction à la législation locale.
- Este producto está diseñado para usarse en los Estados Unidos de América. La venta o el empleo de este producto en ciertos países puede constituir violación de la legislación local.
- 本產品專為美國使用而設。若在其他國家銷售或使用，可能會違反當地法例。
- この製品は、日本国外での使用を目的として設計されており、日本国内での使用は法律違反となります。従って、当社では日本国内においては原則として修理などのサービスは致しかねます。

Controls

Handset

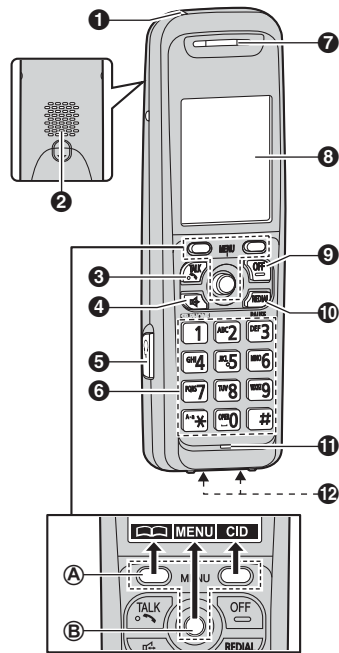

- 1** Charge indicator
Ringer indicator
Message indicator
- 2** Speaker
- 3** [TALK] (TALK)
 - For making calls
- 4** [SP-PHONE] (SP-PHONE: Speakerphone)
 - For hands-free talk
- 5** Headset jack
- 6** Dial keypad
- 7** Receiver
- 8** Display
- 9** [OFF]
 - For stop the operation
- 10** [REDIAL] [PAUSE]
- 11** Microphone
- 12** Charge contacts

Control type

A Soft keys

The handset features 2 soft keys and a joystick. By pressing a soft key, or by pressing the center of the joystick, you can select the feature shown directly above it on the display.

B Joystick

By pushing the joystick ([▲], [▼], [◀], or [▶]) repeatedly, you can:

- scroll through (up, down, left, or right) various lists or items
- adjust the receiver or speaker volume (up or down) while talking
- As all multiple items cannot be displayed on screen at the same time, you can quickly search the desired item to move screens by pushing the joystick right or left, instead of scrolling down or up line by line (page xx).

Base unit

KX-TGP500

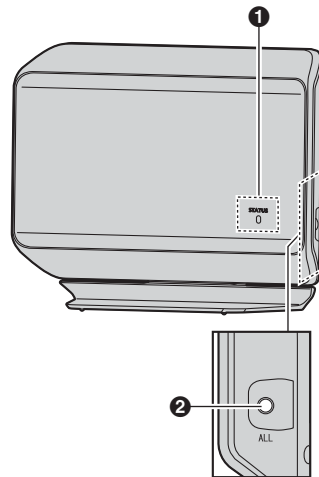

- 1** STATUS indicator
 - Indicates the status of the unit and network.
- 2** [ALL] (Locator)
 - Allows you to page all handsets.

Controls

KX-TGP550

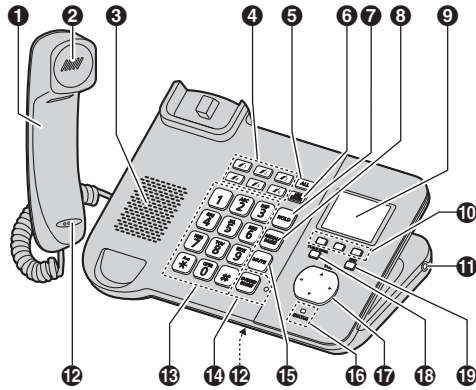

- 1 Corded handset**
- 2 Receiver**
- 3 Speaker**
- 4 Handset buttons (1-6)**
Handset status indicators
 - Allows you to page each handset. Also they show the status of each handset.
- 5 [ALL] (All handsets)**
 - Allows you to page all handsets.
- 6 [LINE STATUS]**
 - Tells you the status of each line.
- 7 [HOLD]**
- 8 [REDIAL] [PAUSE]**
- 9 Display**
- 10 Soft keys**
- 11 Headset jack**
- 12 Microphone**
- 13 Dial keypad**
- 14 [SP-PHONE] [HEADSET]**
SP-PHONE indicator
- 15 [MUTE]**
- 16 STATUS indicator**
 - Indicates the status of the unit and network.
- 17 Navigator key ([▲]/[▼]/[◀]/[▶])**
 ▲: Volume ([▲]/[▼])
- 18 [VOICE MAIL]**
VOICE MAIL indicator
- 19 [EXIT]**
 - For stop the operation

Navigator key/volume key

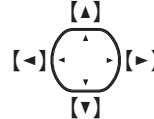

■ Scrolling through lists or items

By pressing this key ([▲] or [▼]) repeatedly, you can scroll through (up or down) various lists or items.

■ Adjusting the volume

By pressing this key ([▲] or [▼]) repeatedly, you can adjust the receiver or speaker volume (up or down) while talking.

■ Moving the cursor

By pressing this key ([▲], [▼], [◀] or [▶]) repeatedly, you can move the cursor to edit a number or name.

Soft keys

The base unit features 3 soft keys. By pressing a soft key, you can select the feature shown directly above it on the display.

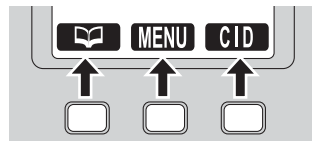

Making calls using the handset

- 1 Lift the handset and dial the phone number.
 - To correct a digit, press **[CLEAR]**.
- 2 **[↶]**
 - The unit selects the default line set by your administrator.
 - You can also select the line manually as follows:
Press **[LINE]**. → **[▼]/[▲]**: Select the desired line. → **[CALL]**
- 3 When you finish talking, press **[OFF]** or place the handset on the charger.

Using the speakerphone

- 1 Dial the phone number and press **[☎]**.
 - The unit selects the default line set by your administrator.
 - You can also select the line manually as follows:
Press **[LINE]**. → **[▼]/[▲]**: Select the desired line. → **[CALL]**
 - Speak alternately with the other party.
- 2 When you finish talking, press **[OFF]**.

Note:

- For best performance, use the speakerphone in a quiet environment.
- To switch back to the receiver, press **[↶]**.

Adjusting the receiver or speaker volume

Push the joystick up or down repeatedly while talking.

Making calls using the base unit (KX-TGP550 only)

- 1 Dial the phone number.
 - To correct a digit, press **[CLEAR]**.
- 2 Lift the corded handset.
 - The unit selects the default line set by your administrator.
 - You can also select the line manually as follows:
Press **[LINE]**. → **[▼]/[▲]**: Select the desired line. → Lift the corded handset.
- 3 When you finish talking, place the corded handset on the cradle.

Note:

- You can also dial the phone number after lifting the corded handset.

Using the speakerphone

- 1 Dial the phone number and press **[SP-PHONE]**.
 - The unit selects the default line set by your administrator.
 - You can also select the line manually as follows:
Press **[LINE]**. → **[▼]/[▲]**: Select the desired line. → Press **[CALL]** or **[SP-PHONE]**.
- 2 When the other party answers, speak into the base unit microphone.
 - Speak alternately with the other party.
- 3 When you finish talking, press **[SP-PHONE]**.

Note:

- For best performance, use the speakerphone in a quiet environment.
- To switch to the receiver, lift the corded handset.



Adjusting the receiver or speaker volume

Press **[▲]** or **[▼]** repeatedly while talking.

Basic Operations

Answering calls using the handset

When a call is being received, the ringer indicator on the handset flashes rapidly.

- 1 Lift the handset and press [] or [] when the unit rings.
 - You can also answer the call by pressing any dial key from [0] to [9], [*], or [#].
(Any key answer feature)
- 2 When you finish talking, press [OFF] or place the handset on the charger.

Answering calls using the base unit (KX-TGP550 only)

When a call is being received, the speakerphone indicator flashes rapidly.

- 1 Lift the corded handset or press [SP-PHONE] when the unit rings.
- 2 When you finish talking, place the corded handset on the cradle. When the speakerphone is used, press [SP-PHONE].

Setting up the base unit

Connecting the base unit

Important:

- Use only the supplied Panasonic AC adaptor PQLV219.
- Do not connect the Ethernet cable connected to the PoE hub to the computer port of the unit. Doing so may cause severe damage to the unit.

KX-TGP500

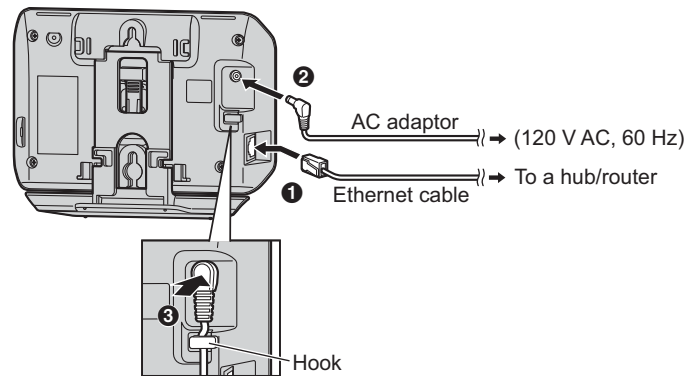

KX-TGP550

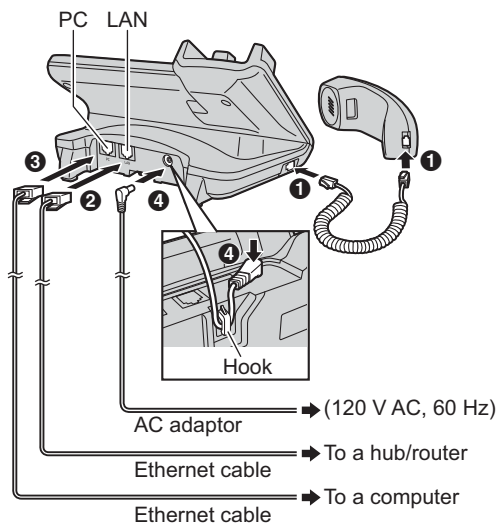

Setting Up

Setting up the handset

Connecting the charger

- Use only the supplied Panasonic AC adaptor PQLV224.

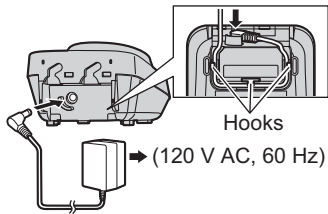

Battery installation

- USE ONLY Ni-MH batteries AAA (R03) size.
- Do NOT use Alkaline/Manganese/Ni-Cd batteries.
- Confirm correct polarities (\oplus , \ominus).

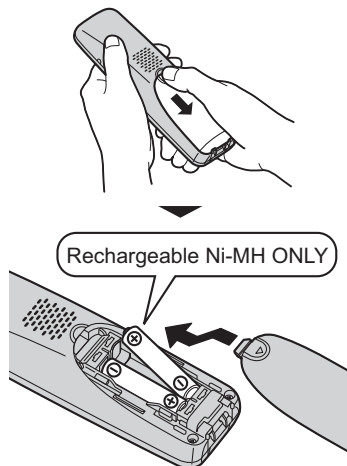

Battery charge

Charge for about 6 hours.

- When the batteries are fully charged, the charge indicator goes off.

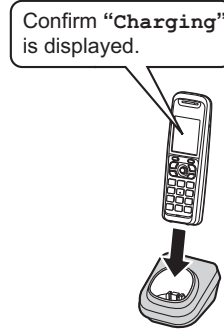

Note when setting up

Note for connections

- The AC adaptor must remain connected at all times. (It is normal for the adaptor to feel warm during use.)
- The AC adaptor should be connected to a vertically oriented or floor-mounted AC outlet. Do not connect the AC adaptor to a ceiling-mounted AC outlet, as the weight of the adaptor may cause it to become disconnected.
- The unit will not work during a power failure.

Note for battery installation

- Use the supplied rechargeable batteries. For replacement, we recommend using the Panasonic rechargeable batteries noted on page 4.
- Wipe the battery ends (\oplus , \ominus) with a dry cloth.
- Avoid touching the battery ends (\oplus , \ominus) or the unit contacts.

Note for battery charge

- It is normal for the handset to feel warm during charging.
- Clean the charge contacts of the handset and charger with a soft and dry cloth once a month. Clean more often if the unit is exposed to grease, dust, or high humidity.

FCC and other information

This equipment complies with Part 68 of the FCC rules and the requirements adopted by the ACTA. On the bottom of this equipment is a label that contains, among other information, a product identifier in the format US:ACJ-----.

If requested, this number must be provided to the telephone company.

If the equipment is causing harm to the telephone network, the telephone company may request that you disconnect the equipment until the problem is resolved.

WHEN PROGRAMMING EMERGENCY NUMBERS AND/OR MAKING TEST CALLS TO EMERGENCY NUMBERS:

- 1) Remain on the line and briefly explain to the dispatcher the reason for the call.
- 2) Perform such activities in the off-peak hours, such as early morning or late evenings.

This device complies with Part 15 of the FCC Rules. Operation is subject to the following two conditions:
(1) This device may not cause harmful interference, and (2) this device must accept any interference received, including interference that may cause undesired operation.

Privacy of communications may not be ensured when using this phone.

CAUTION:

To assure continued compliance with FCC rules, do not make any unauthorized changes or modifications to this equipment would void the user's authority to operate this device.

NOTE:

This equipment has been tested and found to comply with the limits for a Class B digital device, pursuant to Part 15 of the FCC Rules. These limits are designed to provide reasonable protection against harmful interference in a residential installation. This equipment generates, uses, and can radiate radio frequency energy and, if not installed and used in accordance with the instructions, may cause harmful interference to radio communications. However, there is no guarantee that interference will not occur in a particular installation. If this equipment does cause harmful interference to radio or television reception, which can be determined by turning the equipment off and on, the user is encouraged to try to correct the interference by one or more of the following measures:

- Reorient or relocate the receiving antenna.
- Increase the separation between the equipment and receiver.
- Connect the equipment into an outlet on a circuit different from that to which the receiver is connected.
- Consult the dealer or an experienced radio/TV technician for help.

FCC RF Exposure Warning:

- This product complies with FCC radiation exposure limits set forth for an uncontrolled environment.
- To comply with FCC RF exposure requirements, the base unit must be installed and operated 20 cm (8 inches) or more between the product and all person's body (excluding extremities of hands, wrist and feet).
- This product may not be collocated or operated in conjunction with any other antenna or transmitter.
- For body-worn operation, the handset must be used only with a non-metallic accessory. Use of other accessories may not ensure compliance with FCC RF exposure requirements.

Notice

- FCC ID can be found inside the battery compartment or on the back/bottom of the units.

FCC Declaration of Conformity

Trade Name: Panasonic
Model Number: KX-TGP500/KX-TGP550
Responsible Party: Panasonic Corporation of North America
One Panasonic Way
Secaucus, NJ 07094 U.S.A.
Telephone No.: 1-800-211-PANA (7262)

This telephone provides magnetic coupling for hearing aids.

For your future reference

We recommend keeping a record of the following information to assist with any repair under warranty.

Serial No.	Date of purchase
(found on the bottom of the base unit)	
Name and address of dealer	

Attach your purchase receipt here.

**Panasonic Consumer Electronics Company,
Division of Panasonic Corporation of North America**
One Panasonic Way, Secaucus, New Jersey 07094

Copyright:

This material is copyrighted by Panasonic Communications Co., Ltd., and may be reproduced for internal use only. All other reproduction, in whole or in part, is prohibited without the written consent of Panasonic Communications Co., Ltd.

© Panasonic Communications Co., Ltd. 2009



TGP500

PNQxxxxxZA CM0609SY0