

Panasonic[®]



<KX-UT136>

Operating Instructions

SIP Phone

Model No. **KX-UT113/KX-UT123**
KX-UT133/KX-UT136/KX-UT248

Thank you for purchasing this Panasonic product.
Please read this manual carefully before using this product and save this manual for future use.

KX-UT113/KX-UT123/KX-UT133/KX-UT136/KX-UT248: Software File Version 01.000 or later

In this manual, the suffix of each model number is omitted unless necessary.

Document Version: 2011-10

Introduction

Feature Highlights

Easy Operation

You can easily access features using the Navigator key, fixed buttons, and soft buttons. Also, the Message/Ringer lamp will inform you when you have an incoming call or a message waiting.

High-quality Voice Communication

This unit implements the standard SIP protocol, enabling high-quality voice communication.

ECO Mode

Enabling ECO mode allows you to use this unit while reducing the amount of electricity consumed.

Compatible with Electric Hook Switch (EHS) Headsets (KX-UT133/KX-UT136/KX-UT248 only)

The KX-UT133/KX-UT136/KX-UT248 supports EHS headsets.

Compatible with Bluetooth® Wireless Headsets (KX-UT248 only)

The KX-UT248 supports Bluetooth wireless headsets.

Other Information

Outline

This manual describes information about the installation and operation of the unit.

Related Documentation

Getting Started

Briefly describes basic information about the installation of the unit.

Administrator Guide

Describes information about the programming and maintenance of the unit.

Manuals and supporting information are provided on the Panasonic Web site at:

<http://www.panasonic.com/sip> (for users in the United States)

<http://panasonic.net/pcc/support/sipphone> (for users in Canada)

Note

- The contents and design of the software are subject to change without notice.

Trademarks

- The Bluetooth® word mark and logos are owned by the Bluetooth SIG, Inc. and any use of such marks by Panasonic Corporation is under license.
- Plantronics, Savi, and Voyager are trademarks or registered trademarks of Plantronics, Inc.
- All other trademarks identified herein are the property of their respective owners.

When you ship the product (For users in the United States only)

Carefully pack and send it prepaid, adequately insured and preferably in the original carton. Attach a postage-paid letter, detailing the symptom to the outside of the carton.
DO NOT send the product to the Executive or Regional Sales offices. They are NOT equipped to make repairs.

Product Service (For users in the United States only)

Panasonic factory service centers for this product are listed in the service center directory.
Consult your authorized Panasonic dealer for detailed instructions.

For Future Reference

Record the information in the space below for future reference.

Note

- The serial number and MAC address of this product may be found on the label affixed to the bottom of the unit. You should note the serial number and MAC address of this unit in the space provided and retain this manual as a permanent record of your purchase to aid in identification in the event of theft.

MODEL NO.	_____
SERIAL NO.	_____
MAC ADDRESS	_____
DATE OF PURCHASE	_____
NAME OF DEALER	_____
DEALER'S ADDRESS	_____ _____ _____
DEALER'S TEL. NO.	_____

For Your Safety

To reduce the risk of injury, loss of life, electric shock, fire, malfunction, and damage to equipment or property, always observe the following safety precautions.

Explanation of symbols

The following symbols are used to classify and describe the level of hazard and injury caused when the denotation is disregarded and improper use is performed.



WARNING

Denotes a potential hazard that could result in serious injury or death.



CAUTION

Denotes a hazard that could result in minor injury or damage to the unit or other equipment.

The following symbols are used to classify and describe the type of instructions to be observed.



This symbol is used to alert users to a specific operating procedure that must not be performed.











This symbol is used to alert users to a specific operating procedure that must be followed in order to operate the unit safely.



WARNING

General Safety

-  Do not disassemble this unit. Dangerous electrical shock could result. The unit must only be disassembled and repaired by qualified service technicians.
-  Never attempt to insert wires, pins, etc. into the vents or other holes of this unit.
-  To prevent possible fire or electric shock, do not expose this unit to rain or moisture.
-  Do not splash water on the AC adaptor or the power cord, nor get them wet. Doing so can result in fire, electric shock, or injury. If they do get wet, immediately disconnect the AC adaptor and power cord, and contact an authorized service center.
-  Do not touch the AC adaptor for extended periods of time. Doing so can lead to low-degree burns.
-  Unplug this unit from the AC outlet and have the unit serviced by qualified service personnel in the following cases:
 - A.** When the power supply cord or plug is damaged or frayed.
 - B.** If liquid has been spilled on the unit.
 - C.** If the unit has been exposed to rain or water.
 - D.** If the unit does not work normally by following the manual. Adjust only controls covered by the manual. Improper adjustment may require repair by an authorized service center.
 - E.** If the unit has been dropped, or damaged.
 - F.** If the unit's performance deteriorates.
-  If damage to the unit exposes any internal parts, immediately disconnect the cable or cord. If the power is supplied from the network to the SIP Phone [Power-over-Ethernet], disconnect the Ethernet cables. Otherwise, disconnect the AC adaptor cord. Then return this unit to a service center.
-  This handset earpiece is magnetized and may retain small ferrous objects.
-  The use of excessive sound volume through earphones, headphones, or headsets may cause hearing loss.

- ⚠ Disconnect this unit from power outlet/the Ethernet cables if it emits smoke, an abnormal smell, or makes unusual noise. These conditions can cause fire or electric shock. Confirm that smoke has stopped and contact an authorized service center.

Installation

- ⊘ Do not make power connections that exceed the ratings for the AC outlet or power equipment. If the power rating of a surge protector, etc. is exceeded, it can cause a fire due to heat buildup.
- ⊘ Do not bundle up the AC adaptor cord. The cord may become damaged, which can lead to a fire, electric shock, or electric short.
- ⚠ The unit should only be connected to a power supply of the type shown on the label on the unit.
- ⚠ Completely insert the AC adaptor into the AC outlet. Failure to do so may cause electric shock and/or excessive heat resulting in a fire.

Placement

- ⊘ Care should be taken so that objects do not fall onto, and liquids are not spilled into, the unit. Do not subject this unit to excessive smoke, dust, moisture, mechanical vibration, shock, or direct sunlight.
- ⊘ Do not place heavy objects on top of this unit.
- ⚠ Place this unit on a flat surface.
- ⚠ Allow 10 cm (3 ¹⁵/₁₆ in) clearance around the unit for proper ventilation.

Wall Mounting

- ⊘ Do not mount the unit in a manner other than that described in this manual.
- ⚠ Make sure that the wall that the unit will be attached to is strong enough to support the unit. If not, it is necessary for the wall to be reinforced. For information about the weight of the unit, see "Specifications (Page 72)".
- ⚠ Only use the optional wall mount kit with the unit. The wall mount kit includes the necessary screws, washers, and wall mounting adaptor.

- ⚠ When driving the screws into the wall, be careful to avoid touching any metal laths, wire laths or metal plates in the wall.

- ⚠ When this unit is no longer in use, make sure to detach it from the wall.



CAUTION

- ⊘ Keep the unit away from heating appliances and devices that generate electrical noise, such as fluorescent lamps, motors and televisions. These noise sources can interfere with the performance of the unit. It also should not be placed in rooms where the temperature is less than 0 °C (32 °F) or greater than 40 °C (104 °F).

- ⚠ Wipe the unit with a soft cloth. Do not clean the unit with abrasive powders or with chemical agents such as benzene or thinner.

- ⚠ The handset hook poses a choking hazard. Keep the handset hook out of reach of children.

- ⚠ When left unused for a long period of time, disconnect the unit from the AC outlet. When the unit receives power from a PoE power supply, disconnect the Ethernet cables.

- ⚠ When the unit is mounted on a wall, make sure the cables are securely fastened to the wall.

Notice

- If the unit does not operate properly, disconnect the AC adaptor cord and Ethernet cables and then connect again.
- If you are having problems making calls, disconnect the Ethernet cables and connect a known working SIP Phone. If the known working SIP Phone operates properly, have the defective SIP Phone repaired by an authorized Panasonic factory service center. If the known working SIP Phone does not operate properly, check the SIP server and the Ethernet cables.
- Under power failure conditions, the SIP Phone may not operate. Please ensure that a separate telephone, not dependent on local power, is available for use in remote sites in case of emergency.

- For information regarding network setup of the SIP Phone such as IP addresses, please see "Network Settings (Page 43)".
- If an error message is shown on your display, consult your dealer or the network administrator.
- Use only the correct Panasonic handset.

Data Security

We recommend observing the security precautions described in this section, in order to prevent the following:

- loss, disclosure, falsification, or theft of user information
- unauthorized use of the unit
- interference or suspension of use caused by an unauthorized party

We cannot be responsible for damages resulting from the misuse of this product.

User information is defined as the following:

- Phonebook names, phone numbers, and IP addresses
- Forwarding destination numbers
- Numbers stored in One-touch Dialing buttons
- Passwords used to log in to the Web user interface
- Call logs

Preventing Data Loss

- Keep a copy of all important data (such as the phonebook list) in case the machine malfunctions and data cannot be recovered.
- There is a risk that data stored or saved on the unit may be changed or deleted when, for instance, the unit is being repaired. To protect important data from unexpected damage, see Data Security (Page 7).

Preventing Data Disclosure

- Store backups in a secure location.
- Do not store sensitive personal information in the unit.
- Personal information (such as the phonebook list and call log) can be registered and/or saved on this unit. To prevent data leakage or unexpected damages, make a record of necessary user information, etc., and initialize the unit to return it to its factory settings in the following cases.
 - When passing on or disposing of the unit
 - When lending the unit
 - When having the unit repaired
- Make sure the unit is serviced by only a certified technician.
- When user information is sent from the unit to a PC or other external device, the confidentiality of that information becomes the responsibility of the customer. Before disposing of the PC or other

external device, ensure that data cannot be retrieved from it by formatting the hard disk and/or rendering it physically unusable.

Preventing Data Disclosure Over the Network

- To ensure the security of private conversations, only connect the unit to a secure network.
- To prevent unauthorized access, only connect the unit to a network that is properly managed.
- Make sure all personal computers that are connected to the unit employ up-to-date security measures.

Security Information

- Security settings, such as passwords, cannot be undone at Panasonic service centers. Take measures to prevent passwords from being lost or forgotten.
- If a password is forgotten, initialize the unit and configure the settings again (Page 71).
- For best security, set passwords that cannot be guessed easily, and change passwords periodically.
- If using SSL authentication, an NTP server must also be specified. Furthermore, if SSL authentication is performed without specifying an NTP server, authentication will be unconditionally validated without confirming the validity of the SSL certificate.

For Bluetooth Headset Users (KX-UT248 only)

Medical:

Consult the manufacturer of any personal medical devices, such as pacemakers or hearing aids, to determine if they are adequately shielded from external RF (radio frequency) energy (the product operates in the frequency range of 2.402 GHz to 2.480 GHz and the power output is 2.5 mW [max.]). Do not use the product in health care facilities if any regulations posted in the area instruct you not to do so. Hospitals or health care facilities may be using equipment that could be sensitive to external RF energy.

Additional Information

Important Safety Instructions

When using this unit, basic safety precautions should always be followed to reduce the risk of fire, electric shock and injury to persons, including the following:

1. Do not use the unit near water, for example, near a bathtub, washbowl, kitchen sink, or laundry tub, in a wet basement, or near a swimming pool.
2. Avoid using a telephone (other than a cordless type) during an electrical storm. There may be a remote risk of electric shock from lightning.
3. Do not use the telephone to report a gas leak in the vicinity of the leak.

SAVE THESE INSTRUCTIONS

FCC and Other Information

This equipment has been tested and found to comply with the limits for a Class B digital device, pursuant to Part 15 of the FCC Rules. These limits are designed to provide reasonable protection against harmful interference in a residential installation. This equipment generates, uses, and can radiate radio frequency energy and, if not installed and used in accordance with the instructions, may cause harmful interference to radio communications. However, there is no guarantee that interference will not occur in a particular installation. If this equipment does cause harmful interference to radio or television reception, which can be determined by turning the equipment off and on, the user is encouraged to try to correct the interference by one or more of the following measures:

- Reorient or relocate the receiving antenna.
- Increase the separation between the equipment and receiver.
- Connect the equipment into an outlet on a circuit different from that to which the receiver is connected.
- Consult the dealer or an experienced radio/TV technician for help.

CAUTION

Any changes or modifications not expressly approved by the party responsible for compliance could void the user's authority to operate this device.

FCC Declaration of Conformity

Trade Name: Panasonic

Model Number: KX-UT123/KX-UT133/KX-UT136/
KX-UT248

Responsible Party:

Panasonic Corporation of North America
One Panasonic Way

Secaucus, NJ 07094 U.S.A.

Telephone No.: 1-800-211-PANA (7262)

This equipment complies with Part 68 of the FCC rules and the requirements adopted by the ACTA. On the bottom of the cabinet of this equipment is a label that contains, among other information, a product identifier in the format

US:ACJ.....

If requested, this number must be provided to the telephone company.

If trouble is experienced with this equipment, for repair or warranty information, please contact:

Panasonic Service and Technology Company-BTS
Center

415 Horizon Drive Bldg. 300 Ste. 350-B
Suwanee, GA 30024-3186

Connection to party line service is subject to state tariffs. Contact the state public utility commission, public service commission or corporation commission for information.

If your home has specially wired alarm equipment connected to the telephone line, ensure the installation of this equipment does not disable your alarm equipment. If you have questions about what will disable alarm equipment, consult your telephone company or a qualified installer.

WHEN PROGRAMMING EMERGENCY NUMBERS AND (OR) MAKING TEST CALLS TO EMERGENCY NUMBERS:

- a. Remain on the line and briefly explain to the dispatcher the reason for the call.
- b. Perform such activities in the off-peak hours, such as early morning or late evenings.

This equipment is hearing aid compatible.

When you hold the phone to your ear, noise might be heard in your Hearing Aid. Some Hearing Aids are not adequately shielded from external RF (radio frequency) energy. If noise occurs, use the speakerphone option (if applicable) when using this phone. Consult with your audiologist or Hearing Aid manufacturer about the availability of Hearing Aids which provide adequate

Additional Information

shielding to RF energy commonly emitted by digital devices.

For users in Canada only

- This Class B digital apparatus complies with Canadian ICES-003.
- This product meets the applicable Industry Canada technical specifications.

For KX-UT248 only

This unit features a built-in Bluetooth module that can be used to wirelessly connect a Bluetooth headset to the unit.

Radio Frequency Exposure Requirements

This product complies with FCC/IC radiation exposure limits set forth for an uncontrolled environment. To comply with FCC/IC RF exposure requirements, it must be installed and operated in accordance with provided instructions. The unit requires minimum 20 cm (8 in) spacing must be provided between antennas and all person's body (excluding extremities of hands, wrists and feet) during wireless modes of operation. This transmitter must not be co-located or operated in conjunction with any other antenna or transmitter.

Compliance with TIA-1083 standard



Telephone handsets identified with this logo have reduced noise and interference when used with T-Coil equipped hearing aids and cochlear implants.

Table of Contents

Before Operating the Telephone	13
Accessory Information	13
Location of Controls	14
Screens	20
Status Icons	20
Soft Buttons and Soft Button Icons	21
Basic Operations	23
Confirming Your Extension Number	23
Going off- and on-hook	23
Adjusting the Volume	23
Feature Operations	25
Making Calls	25
Making a Call	25
Making a Call from the Phonebook List	25
Dialing by Using Call Logs	25
Redialing the Last Number You Dialed (Redial, Last Number)	26
One-touch Dialing (KX-UT133/KX-UT136 only)	26
Receiving Calls	27
Receiving a Call	27
Rejecting Calls	27
Holding a Call	28
Receiving a Second Call (Answering Call Waiting)	29
Talking to Two Parties Alternately (Call Splitting)	29
Transferring a Call (Call Transfer)	30
To Transfer with One Touch (One-touch Transfer) (KX-UT133/KX-UT136 only)	30
Mute	30
Conference Call (Local Three-way Conference)	31
Making a Conference Call	31
Removing a Party from the Conference	31
Ending a Conference Call	31
Checking Messages	32
Checking New Messages	32
Checking Missed Calls	32
Call Forwarding/Do Not Disturb	33
Logging in to or Logging out of a Group (KX-UT133/KX-UT136 only)	33
Logging in to or Logging out of an ACD (Automatic Call Distribution) Group	33
Flexible Buttons (KX-UT133/KX-UT136 only)	34
Customizing the Telephone	35
Phonebook List	35
Adding a New Phonebook Entry	35
Adding a Phonebook Entry from the Incoming Call Log	35
Editing a Phonebook Entry	35
Searching for a Phonebook Entry	36
Deleting a Phonebook Entry	36
Export/Import Phonebook Entries	36
User Settings	37
Accessing the Settings	37
Available Settings	38
Settings Details	40
Entering Characters	48

Web User Interface Programming	56
Installation and Setup	57
Attaching/Removing the Stand	57
Connections	60
Wall Mounting	63
Hooking the Handset	68
Using a Headset	70
Setting Up the Unit	70
Maintaining the Unit	71
Initializing the Unit	71
Restarting the Unit	71
Cleaning the Unit	71
Appendix	72
Specifications	72
Troubleshooting	74
Common Issues and Solutions	74
Error Messages	76
Open Source Software	78
Index.....	82

Before Operating the Telephone

Accessory Information

Included Accessories^{*1}

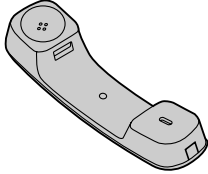
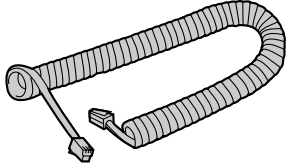
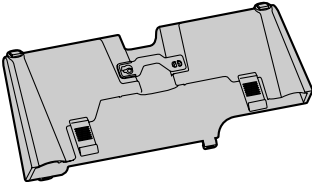
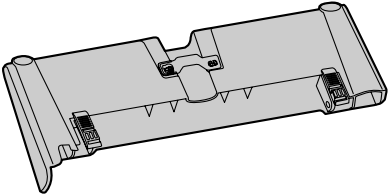
Handset (1)  [Part No.] Black model: PNLXQ1001Z White model: PNLXQ1002Z	Handset Cord (1)  [Part No.] Black model: PNJA1066Z White model: PNJA1067Z
Stand (1)	
For KX-UT113/KX-UT123:  [Part No.] Black model: PNYLUT113BM White model: PNYLUT113M	For KX-UT133/KX-UT136/KX-UT248:  [Part No.] Black model: PNYLUT133BM White model: PNYLUT133M

^{*1} For extra orders for the accessories, call toll-free: 1-800-332-5368. (For users in the United States only)

Note

- The illustrations may differ from the appearance of the actual product.

Optional Accessories

Optional AC Adaptor ^{*1}	<ul style="list-style-type: none"> For users in the United States: KX-A239 (PQLV206) For users in Canada: KX-A239X (PQLV206)
Wall Mount Kit	<ul style="list-style-type: none"> For KX-UT113/KX-UT123: KX-A432 For KX-UT133/KX-UT136/KX-UT248: KX-A433

^{*1} To order an optional AC adaptor, please order using the "KX-A239" model number.

Location of Controls

Front View

For KX-UT248:

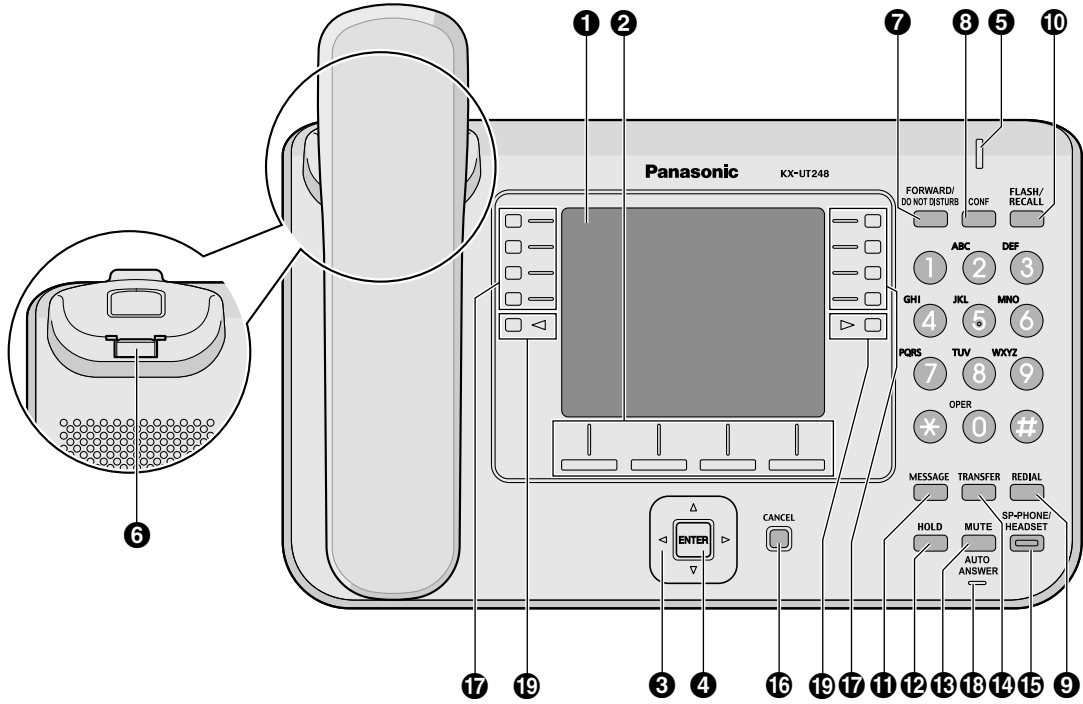

For KX-UT136:

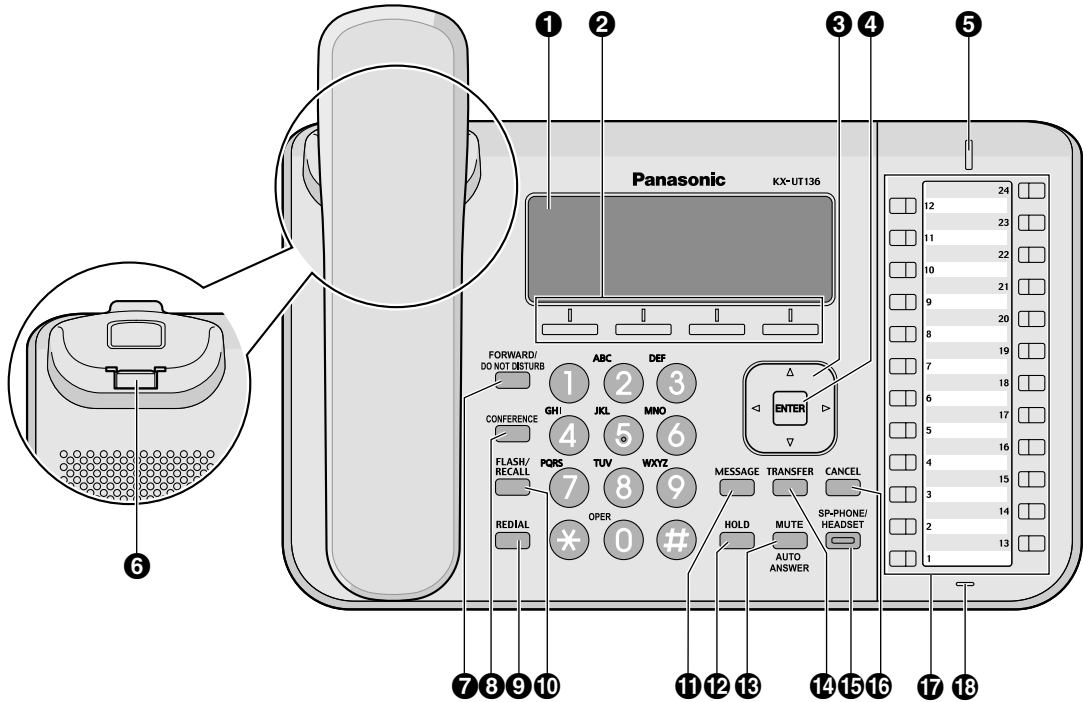

For KX-UT133:

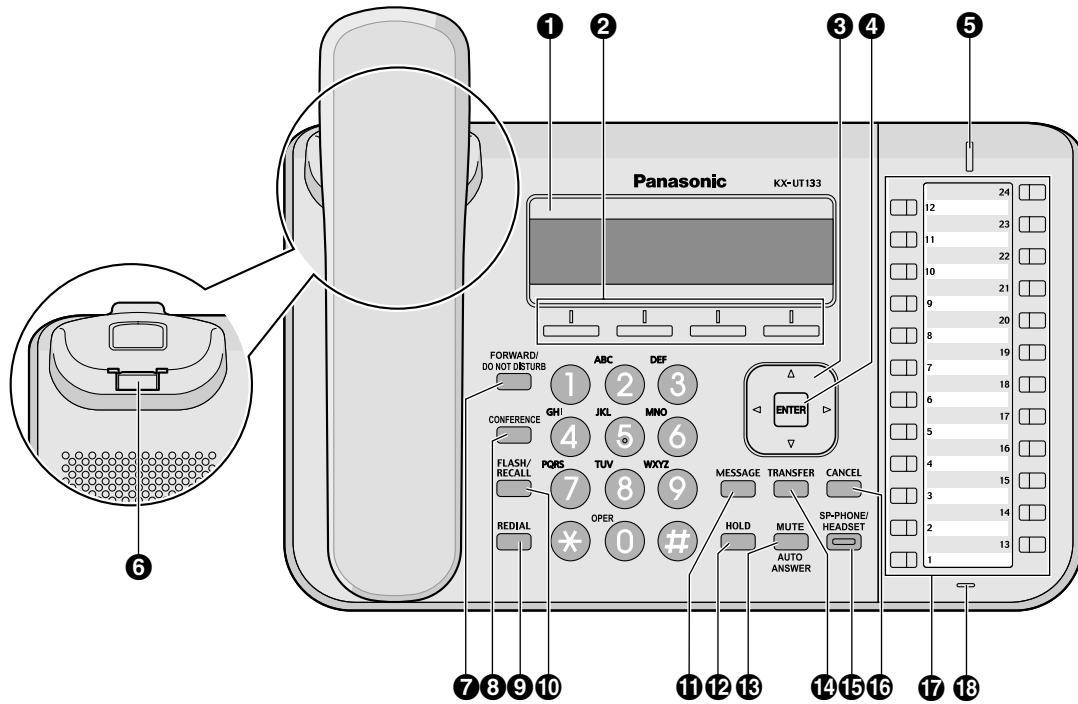

For KX-UT113/KX-UT123:

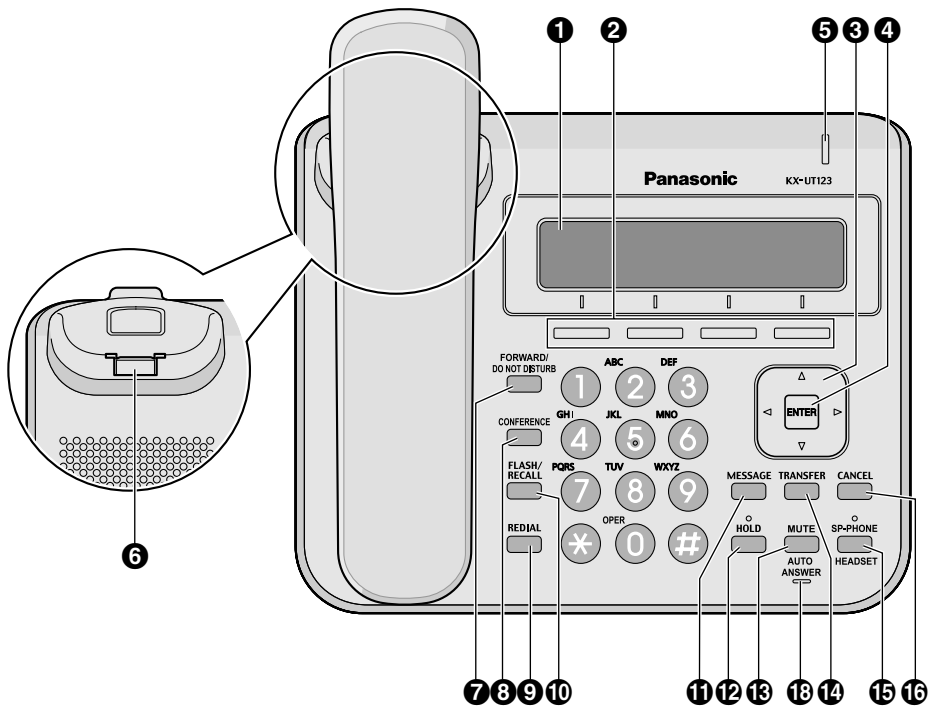

1 LCD (Liquid Crystal Display)

KX-UT248 is equipped with a 4.4-inch LCD and LCD backlight.
 KX-UT136 is equipped with a 6-Line LCD and LCD backlight.
 KX-UT133 is equipped with a 3-Line LCD and LCD backlight.
 KX-UT123 is equipped with a 3-Line LCD and LCD backlight.

KX-UT113 is equipped with a 3-Line LCD.

2 Soft Buttons (S1 to S4)

S1 to S4 (located below the display) are used to select the item displayed on the bottom line of the display.

3 Navigator Key

Used to adjust the volume or select desired items.

4 ENTER

Used to assign the selected item.

5 Message/Ringer Lamp

When you receive a call or Hold Recall, the lamp flashes green.

When someone has left you a message, the lamp stays on red.

6 Handset Hook

Keeps the handset stable when the unit is mounted on a wall. For details, see "To Lock the Handset Hook when the Unit is Wall Mounted (Page 68)".

7 FORWARD/DO NOT DISTURB

Used to set Call Forwarding or Do Not Disturb on your extension.

8 CONF (Conference)/CONFERENCE

Used to establish a local three-way conference.

9 REDIAL

Used to redial the last dialed number.

10 FLASH/RECALL

Used to disconnect the current call and make another call without hanging up.

11 MESSAGE

Used to access your voice mailbox.

12 HOLD

Used to put a call on hold.

When a call is on hold, the Hold lamp (KX-UT113/KX-UT123 only) flashes red.

13 MUTE/AUTO ANSWER

Used to receive an incoming call in hands-free mode or mute the microphone/handset during a conversation.

14 TRANSFER

Used to transfer a call to another party.

15 SP-PHONE (Speakerphone)/HEADSET

Used for performing hands-free operations. When the SP-PHONE is used, the lamp on the SP-PHONE (KX-UT133/KX-UT136/KX-UT248 only) or the lamp above the SP-PHONE (KX-UT113/KX-UT123 only) turns red. When muted, the lamp flashes red.

16 CANCEL

Used to cancel the selected item.

17 Flexible Buttons/Flexible Button Lamps (KX-UT133/KX-UT136/KX-UT248 only)

Used to make or receive calls, or perform the feature that has been assigned to the button. The flexible button lamp shows the status of each flexible button.

18 MIC

Used for hands-free conversation.

19 Page Keys (KX-UT248 only)

Used to switch the page of flexible buttons displayed. There are three pages of eight flexible buttons.

Left Side View

For KX-UT133/KX-UT136/KX-UT248:

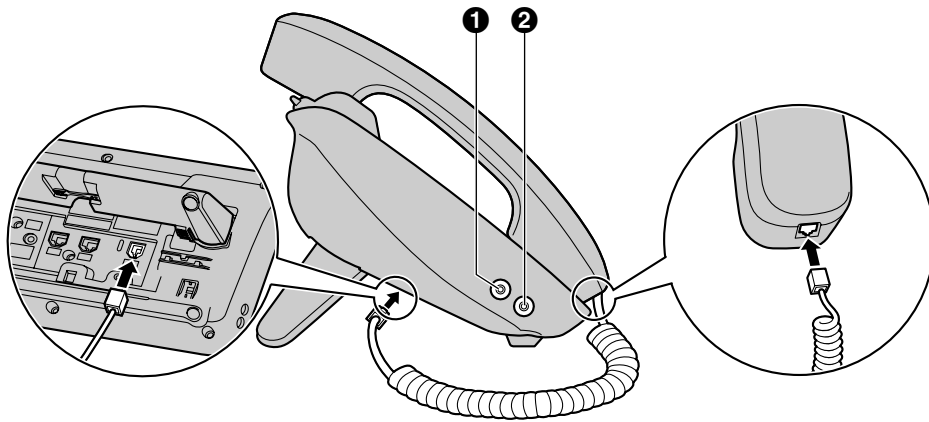

For KX-UT113/KX-UT123:

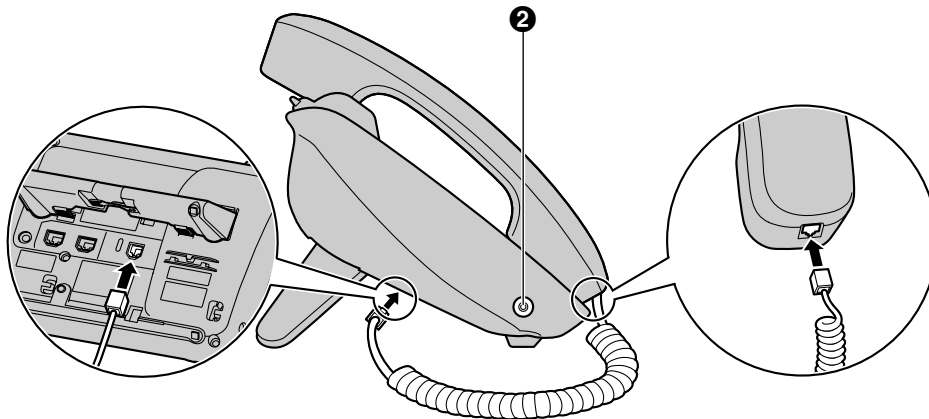

- ❶ EHS Jack (KX-UT133/KX-UT136/KX-UT248 only)
- ❷ Headset Jack

Bottom View

For KX-UT133/KX-UT136/KX-UT248:

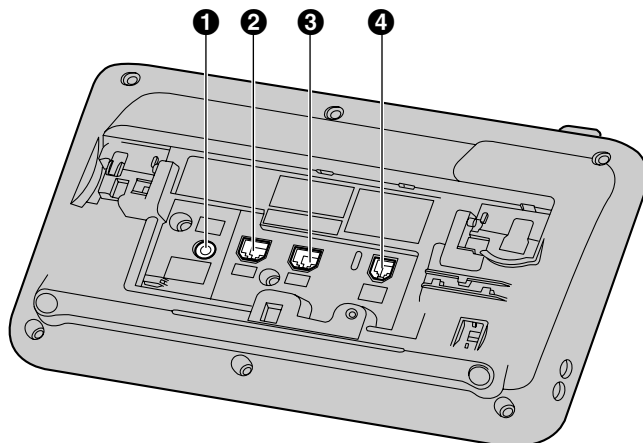

For KX-UT123:

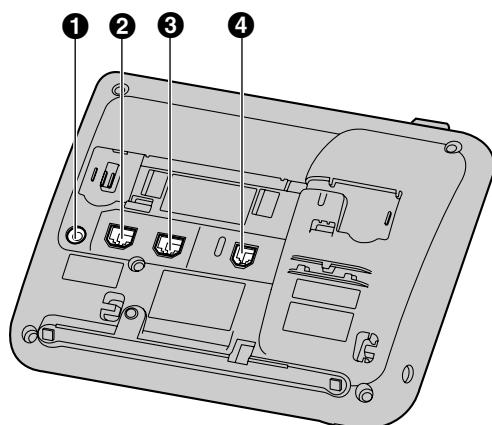

For KX-UT113:

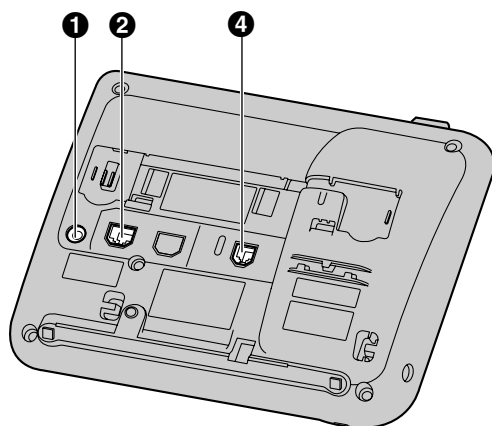

1 DC Jack

- ② LAN Port
- ③ PC Port (KX-UT123/KX-UT133/KX-UT136/KX-UT248 only)
- ④ Handset Jack

Screens

This section explains the buttons and icons that appear on the display.

For KX-UT136:

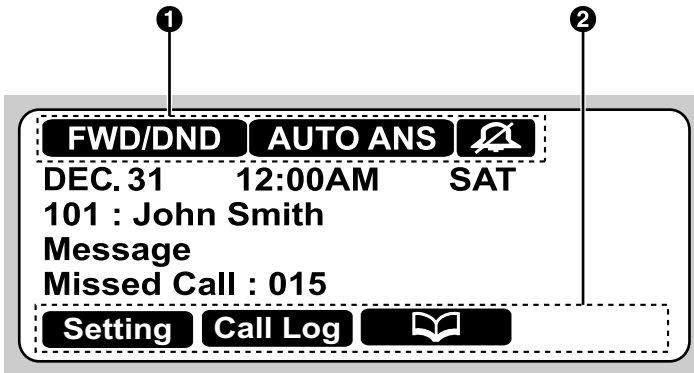

For KX-UT113/KX-UT123/KX-UT133:

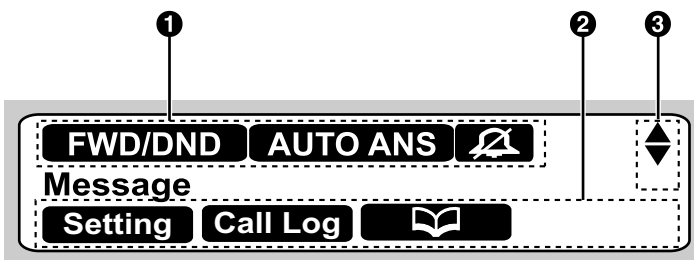

1 Status Icons

Indicates the status of various features (Page 20).

2 Soft Button Icons

Indicate the functions that will be accessed when the corresponding buttons are pressed. The icons displayed vary according to the state of the unit. (For example, the icons displayed while on a call are different from the icons displayed while storing an entry in the phonebook).

3 Scroll Indicator



Indicates that [▲], [▼], [◀], or [▶] can be pressed to display the previous or next item.

Note

- Although the scroll indicator is not shown in the screen sample of the KX-UT136 above, it does appear on some screens.

Status Icons

Icon	Description
	Displayed when Call Forwarding or Do Not Disturb is enabled (Page 33).
	Displayed when Auto Answer is enabled (Page 27).
	Displayed when the ringer is turned off (Page 23).



Icon	Description
	Displayed when Eco mode is enabled (Page 40).
	Displayed when registration to the SIP server has been lost. If this icon is displayed, consult your administrator or dealer.



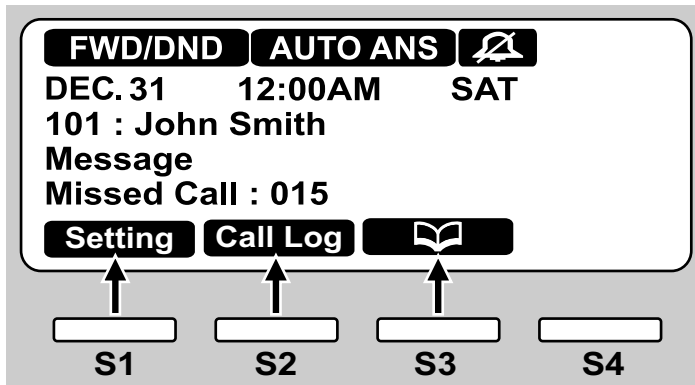







Soft Buttons and Soft Button Icons

By pressing a soft button (S1 to S4), you can access the function displayed directly above it.



In this manual, soft buttons are referred to by their corresponding icons.

In the example here, "Press ", "Press ", or "Press " would indicate pressing S1, S2, or S3, respectively.

Icon	Description
	Access the user setting menus (Page 37).
	Access the call log (Page 25).
	Access the phonebook (Page 35).
	Access the setup menus (Page 70).
	Erase the number or character above the cursor (Page 25).
	Search for a phonebook entry (Page 25).
	Edit a call log or phonebook entry (Page 26, Page 35).
	Confirm a transfer operation (Page 30).
	Begin installation of a firmware update (Page 46).
	Save or confirm the information shown on the display. Note <ul style="list-style-type: none"> You can also use the physical ENTER button to perform the same operation as this soft button.
	Answer an incoming call (Page 23).

Icon	Description
Close	Close the incoming call screen and continue pre-dialing (Page 25).
Reject	Reject an incoming call (Page 27).
Blind	Perform a blind transfer (Page 30).
Erase	Erase the information shown on the display (Page 28, Page 36).
Save	Save the information shown on the display (Page 27, Page 35).
Call	Make a call (Page 25).
Edit	Edit the information shown on the display (Page 26, Page 27, Page 35).
Prefer	Assign the preferred number to dial among multiple registered phone numbers in the same phonebook entry, when making a call using the phonebook (Page 35).
Number	Display the telephone number when searching an entry in the phonebook (Page 25).
Update	Update the firmware (Page 46).

Basic Operations

This section explains the basics of using the unit.

Confirming Your Extension Number

In stand-by mode (i.e., when you do not have any active calls), you can view the extension number and name registered to the unit.

Going off- and on-hook

There are several ways to go off-hook and on-hook:

- Using the handset
- Using the **[SP-PHONE]** button
- Using the soft buttons
- For KX-UT133/KX-UT136, using a DN button (flexible button)

Going off-hook

In this manual, when you see the phrase "go off-hook", you can do any of the following:

- Lift the handset off of its cradle.
- Press **[SP-PHONE]** while the handset is on its cradle. This enables hands-free mode.
- For KX-UT133/KX-UT136, press a DN button (flexible button).

Note

- Certain soft buttons, such as **Answer**, function like the **[SP-PHONE]** button.
- For details about DN buttons, see "Flexible Buttons (KX-UT133/KX-UT136 only) (Page 34)".

Going on-hook

In this manual, when you see the phrase "go on-hook", you can do any of the following:

- Replace the handset on its cradle.
- Press **[SP-PHONE]**, if you are in hands-free mode.

Hands-free Mode

In hands-free mode, you can talk and hear the other party in a conversation without using the handset. This

mode is useful for performing other tasks during a conversation, such as writing.

Enabling hands-free mode

You can enable hands-free mode in one of the following ways:

- In stand-by mode, press **[SP-PHONE]**.
- During a conversation while using the handset, press **[SP-PHONE]**. You can then return the handset to its cradle.
- When receiving an incoming call, press **Answer**.
- For KX-UT133/KX-UT136, in stand-by mode, press an idle DN button (flexible button).
- For KX-UT133/KX-UT136, when receiving a call or when a call is on hold, press the flashing green DN button (flexible button) that corresponds to the call.

Canceling hands-free mode

You can cancel hands-free operation simply by lifting the handset off its cradle.

Note

- For details about DN buttons, see "Flexible Buttons (KX-UT133/KX-UT136 only) (Page 34)".

Off-hook monitor

During a two-party conversation with the corded handset, you can allow other people to listen to the conversation through the speaker while you continue the conversation using the handset.

- Press **[SP-PHONE]**, but do not return the handset to its cradle.
- Press **[SP-PHONE]** again to cancel off-hook monitor.

Note

- When off-hook monitor is active, replacing the handset to its cradle enables hands-free mode.
- During a conference call, pressing **[SP-PHONE]** simply enables hands-free mode. The handset will be disabled.

Adjusting the Volume

You can adjust the ringer, handset, headset, and speaker volume using **[▲]** and **[▼]** on the Navigator key.

Adjusting the ringer volume

When receiving a call, press **[▲]** or **[▼]**.

Before Operating the Telephone

You can also adjust the ringer volume in the settings. For details, see "Ringer (Page 40)".

Note

- When the ringer volume is turned all the way down, "Off" is displayed. Also,  is displayed when the unit is in stand-by mode.

Adjusting the handset/headset/ speaker volume

Press **[▲]** or **[▼]** during a conversation when using the handset, headset, or when you are in hands-free mode.

Feature Operations

Making Calls

This section explains the basic methods for making a call.

Making a Call

1. In stand-by mode, go off-hook.
2. Enter the number you want to call.
3. Press **[ENTER]**, or wait a few seconds for the number to be dialed.
4. To end the call, go on-hook.

Pre-dialing

In stand-by mode, you can start dialing (max. 32 digits) while still on-hook.

- To delete a number you entered, press **Clear**.
- To clear the entire number, press and hold **Clear**.
- To connect the call, go off-hook or press **[ENTER]**.

Note

- For KX-UT133/KX-UT136, you can also press an idle DN button (flexible button) to connect the call. For details about DN buttons, see "Flexible Buttons (KX-UT133/KX-UT136 only) (Page 34)".
- For KX-UT113/KX-UT123, when pre-dialing you can press **Call** instead of going off-hook. If more than one line is available at your unit, select the line to use, and then press **[ENTER]**.
- If you receive an incoming call during pre-dialing, the display changes to the incoming call screen. For KX-UT133/KX-UT136, you can close the incoming call screen by pressing **Close**, and continue pre-dialing.

Making a Call from the Phonebook List

Scrolling through all entries

1. Press **Phonebook**.
2. Press **[▲]** or **[▼]** to select an entry.
3. Go off-hook.
4. To end the call, go on-hook.

Note

- For KX-UT133/KX-UT136, you can also press an idle DN button (flexible button) in step 3 to connect the call. For details about DN buttons, see "Flexible Buttons (KX-UT133/KX-UT136 only) (Page 34)".
- For KX-UT113/KX-UT123, you can press **Call** instead of going off-hook. If more than one line is available at your unit, select the line to use, and then press **[ENTER]**.
- In step 2, if multiple phone numbers are stored for the entry, you can press **Number** and then select the phone number to call.

Searching by name

1. Press **Phonebook**.
2. Press **Search**.
3. Enter the name (max. 12 characters) you want to search for.
4. Press **[ENTER]**.
The entry that matches your search appears.
5. Go off-hook.
6. To end the call, go on-hook.

Note

- For KX-UT113/KX-UT123, you can press **Call** instead of going off-hook. If more than one line is available at your unit, select the line to use, and then press **[ENTER]**.
- For details about entering characters, see "Entering Characters (Page 48)".
- In step 4, if multiple phone numbers are stored for the entry, you can press **Number** and then select the phone number to call.
- If you do not press any buttons for 1 minute, the unit will return to stand-by mode.

Dialing by Using Call Logs

The last 30 incoming calls and outgoing calls are stored in their respective logs, in order of newest to oldest call. You can make calls to the numbers listed in the call logs.

1. Press **Call Log**.
2. Press **[▲]** or **[▼]** to select the call log type, and then press **[ENTER]**.
3. Press **[▲]** or **[▼]** to select the desired entry.
4. Go off-hook.
5. To end the call, go on-hook.

Note

- For KX-UT133/KX-UT136, you can also press an idle DN button (flexible button) in step 4 to connect the call. For details about flexible buttons, see "Flexible Buttons (KX-UT133/KX-UT136 only) (Page 34)".
- For KX-UT113/KX-UT123, you can press **Call** instead of going off-hook. If more than one line is available at your unit, select the line to use, and then press **[ENTER]**.
- You can add a call log entry to the phonebook. See "Adding a Phonebook Entry from the Incoming Call Log (Page 35)".

Editing a phone number before dialing from the incoming call log

You can edit a phone number in the incoming call log before using it to dial.

1. Press **Call Log**.
2. Press **[▲]** or **[▼]** to select "Incoming Call Log", and then press **[ENTER]**.
3. Press **[▲]** or **[▼]** to select the desired entry.
4. Do one of the following, depending on your unit:
For KX-UT113/KX-UT123 users
 - Press **Menu**, select "Edit", and then press **[ENTER]**.**For KX-UT133/KX-UT136 users**
 - Press **Edit**.
5. Edit the number, and then go off-hook or press **Call**.
6. To end the call, go on-hook.

Redialing the Last Number You Dialed (Redial, Last Number)

You can redial the last phone number that you dialed.

1. Press **[REDIAL]**.
2. To end the call, go on-hook.

Note

- For KX-UT133/KX-UT136, to select a line to use to redial, press the appropriate DN button (flexible button) before you press **[REDIAL]**. For details about DN buttons, see "Flexible Buttons (KX-UT133/KX-UT136 only) (Page 34)".
- The unit may be configured to display the outgoing call log instead of immediately

redialing. You can select an entry from the call log to make a call (Page 25). For details, consult your administrator or dealer.

One-touch Dialing (KX-UT133/KX-UT136 only)

You can make a call with a One-touch operation if a One-touch dialing button has been created for the desired party. One-touch dialing buttons can also be configured to access features of your phone system, if available.

1. Go off-hook, and then press the One-touch dialing button (flexible button).
2. To end the call, go on-hook.

Note

- A BLF (Busy Lamp Field) button (flexible button) can also be used to call an extension simply by pressing the button. For details, consult your administrator or dealer.
- For details about flexible buttons such as One-touch dialing buttons and BLF buttons, see "Flexible Buttons (KX-UT133/KX-UT136 only) (Page 34)".

Receiving Calls

This section explains the basic methods for receiving a call.

Receiving a Call

1. Go off-hook.
2. To end the call, go on-hook.

Auto answer

You can have the unit automatically answer an incoming call. The call is connected after a programmed number of rings.

- To enable Auto Answer:
In stand-by mode, press **[AUTO ANSWER]** until "Auto Answer On" appears.
- To disable Auto Answer:
In stand-by mode, press **[AUTO ANSWER]** until "Auto Answer Off" appears.

Note

- When Auto Answer is enabled, **AUTO ANS** appears on the display in stand-by mode.

Rejecting Calls

You can reject an incoming call at your unit or set the unit to reject certain calls.

Rejecting a call while receiving

1. When receiving an incoming call, press **Reject**.

Rejecting anonymous calls

You can set the unit to reject calls when the unit receives a call without phone number.

To reject anonymous calls, the Block Anonymous Call setting must be enabled through Web user interface programming (Page 56). For details, consult your administrator or dealer.

Note

- Rejected phone numbers will not be stored in the incoming call log.
- Depending on the line an incoming call is arriving on, the call may not be rejected.

Rejecting specific calls

You can set the unit to reject specific phone numbers.

Note

- Rejected phone numbers will not be stored in the incoming call log.

Adding a phone number

You can store a maximum of 30 phone numbers you want to reject in the rejection list of the unit.

1. In stand-by mode, press **Setting**.
2. Press **[▲]** or **[▼]** to select "Call Block", and then press **[ENTER]**.
3. Press **Add**.
4. Enter the telephone number (max. 32 digits), and then press **[ENTER]**.

Note

- To register additional telephone numbers, repeat the procedure from step 3.

Adding a phone number from the incoming call log

You can add a phone number by referring to the incoming call log.

1. In stand-by mode, press **Call Log**.
2. Press **[▲]** or **[▼]** to select "Incoming Call Log", and then press **[ENTER]**.
3. Press **[▲]** or **[▼]** to select the entry with the phone number you want to reject.
4. Press **Save**.
5. Press **[▲]** or **[▼]** to select "Call Block", and then press **[ENTER]**.
6. Press **[▲]** or **[▼]** to select "Yes", and then press **[ENTER]**.

Note

- If you do not press any buttons for 1 minute, the unit will return to stand-by mode.

Editing a stored phone number

1. In stand-by mode, press **Setting**.
2. Press **[▲]** or **[▼]** to select "Call Block", and then press **[ENTER]**.
3. Press **[▲]** or **[▼]** to select the phone number you want to edit, and then press **Edit**.
4. Edit the phone number as necessary, and then press **[ENTER]**.

Note

- If you do not press any buttons for 1 minute, the unit will return to stand-by mode.

Deleting a stored phone number

1. In stand-by mode, press **Setting**.
2. Press **[▲]** or **[▼]** to select "Call Block", and then press **[ENTER]**.
3. Press **[▲]** or **[▼]** to select the phone number you want to delete, and then press **Erase**.
4. Press **[▲]** or **[▼]** to select "Yes", and then press **[ENTER]**.

Note

- If you do not press any buttons for 1 minute, the unit will return to stand-by mode.

Holding a Call

You can put a call on hold by holding the call at your extension.

To hold the current call

1. Press **[HOLD]**, and then go on-hook.

Note

- For KX-UT133/KX-UT136, if Automatic Call Hold is enabled on your unit, the call will also be put on hold if you press a DN button (flexible button) other than the one for the current call. For details, consult your administrator or dealer.

To retrieve a call on hold at your extension

1. Go off-hook.
2. Do one of the following, depending on your unit:
For KX-UT113/KX-UT123 users
 - Press **[HOLD]**.**For KX-UT133/KX-UT136 users**
 - Press the green flashing DN button (flexible button).

Note

- If a call is not retrieved within a specified time, you will hear an alarm as a reminder (Hold Recall).
- For details about DN buttons, see "Flexible Buttons (KX-UT133/KX-UT136 only) (Page 34)".

Receiving a Second Call (Answering Call Waiting)

During a conversation, if a second call arrives, you will hear a call waiting tone.

You can answer the second call by disconnecting or holding the current call.

To disconnect the current call and then talk to the new party

1. Go on-hook while hearing the call waiting tone.
2. Go off-hook.

To hold the current call and then talk to the new party

For KX-UT113/KX-UT123 users

1. Press **[HOLD]** while hearing the call waiting tone.

For KX-UT133/KX-UT136 users

1. Press **[HOLD]** while hearing the call waiting tone.
2. Press the green flashing DN button (flexible button).

Note

- For KX-UT133/KX-UT136, if Automatic Call Hold is enabled on your unit, you do not need to press **[HOLD]** in step 1. The call is automatically put on hold when you press the DN button. For details, consult your administrator or dealer.
- For details about DN buttons, see "Flexible Buttons (KX-UT133/KX-UT136 only) (Page 34)".

Talking to Two Parties Alternately (Call Splitting)

When you are talking to one party and have another party on hold, you can switch the call on hold and the current call.

1. Press **[HOLD]** during a conversation.
2. Call the second party.
3. Do one of the following, depending on your unit:
 - For KX-UT113/KX-UT123 users**
 - Press **[HOLD]**.
 - For KX-UT133/KX-UT136 users**
 - Press **[HOLD]**, and then press the green flashing DN button (flexible button) that corresponds to the other party on hold.

Note

- For KX-UT133/KX-UT136, if Automatic Call Hold is enabled on your unit, you do not need to press **[HOLD]** in step 3. The call is automatically put on hold when you press the DN button. For details, consult your administrator or dealer.
- For details about DN buttons, see "Flexible Buttons (KX-UT133/KX-UT136 only) (Page 34)".

Transferring a Call (Call Transfer)

You can transfer a call to another destination (extension or outside party).

To transfer

1. Press **[TRANSFER]** during a conversation.
2. Call the party you want to transfer the call to.
3. Wait until the other party answers to announce the transfer. (This step can be omitted.)
4. Press **OK**.

Note

- If On-hook Transfer is enabled on your unit, you can simply go on-hook in step 4 instead of pressing **OK**. For details, consult your administrator or dealer.

To do a blind transfer

1. Press **Blind** during a conversation.
2. Call the party you want to transfer the call to.
3. Go on-hook.

To Transfer with One Touch (One-touch Transfer) (KX-UT133/KX-UT136 only)

1. Press the BLF button (flexible button) during a conversation.
2. Wait until the other party answers to announce the transfer. (This step can be omitted.)
3. Press **OK**.

Note

- If On-hook Transfer is enabled on your unit, you can simply go on-hook in step 3 instead of pressing **OK**. For details, consult your administrator or dealer.
- For details about flexible buttons, see "Flexible Buttons (KX-UT133/KX-UT136 only) (Page 34)".

Mute

You can mute your voice during a conversation. While the mute feature is turned on, you will be able to hear the other party, but the other party will not be able to hear you.

The built-in microphone, handset, and headset are all muted when the mute feature is turned on.

To mute/unmute

1. Press **[MUTE]**.

Conference Call (Local Three-way Conference)

During a conversation, you can add an additional party to your call and establish a conference call.

Notice

- Your phone system may support advanced conference features, such as conference calls with four or more parties. In this case, the procedures for handling a conference call may be different from those explained in this section. For details about your phone system, consult your administrator or dealer.

Making a Conference Call

- Press [**CONFERENCE**] to put the current call on hold.
- Call the party you want to add to the conversation.
- After the called party answers, press [**CONFERENCE**] to begin the conference call.

Removing a Party from the Conference

During a conference, you can remove other parties from the conference. However, this operation is available only during conference calls you initiate.

For KX-UT113/KX-UT123 users

- During a conference call, press [**HOLD**].
 - The second party is put on hold, but you can continue talking to the first party.
- Go on-hook.
 - The first party is disconnected.
- Press [**HOLD**].
 - You can continue the conversation with the second party.

Note

- To disconnect the second party instead of the first party, press [**HOLD**] 2 times in step 1.
- Once you have pressed [**HOLD**], the conference cannot be reestablished.

For KX-UT133/KX-UT136 users

- During a conference call, press [**HOLD**].
 - The other parties are put on hold.

- Press the DN button (flexible button) that corresponds to the party you want to disconnect.
 - A conversation is established with the party you want to disconnect.
- Go on-hook.
 - The party is disconnected.
- Press the DN button (flexible button) that corresponds to the remaining party.
 - You can continue the conversation with the remaining party.

Note

- Once you have pressed [**HOLD**], the conference cannot be reestablished.
- For details about DN buttons, see "Flexible Buttons (KX-UT133/KX-UT136 only) (Page 34)".

Ending a Conference Call

- Go on-hook during a conference.

Checking Messages

Checking New Messages

When you receive a voice message, "Message" appears on the display, and the Message/Ringer lamp turns red.

You can check your new messages by accessing your mailbox.

1. Press **[MESSAGE]**.
2. If the unit has multiple lines, press **[▲]** or **[▼]** to select the line on which  is displayed, and then go off-hook.

Checking Missed Calls

When there are new missed calls, "Missed Call: xxx" appears on the display. ("xxx" indicates the number of missed calls.)

1. Press **Call Log**.
2. Press **[▲]** or **[▼]** to select "Incoming Call Log", and then press **[ENTER]**.
3. Press **[▲]** or **[▼]** to select the missed call.

Note

- In the incoming call log, "Not Answered" is displayed on missed calls. For KX-UT113/KX-UT123/KX-UT133, you must press **[▶]** to see this.
- For details about making calls from the call log, see "Dialing by Using Call Logs (Page 25)".
- A check mark is displayed next to answered calls and missed calls that you have already checked.

Call Forwarding/Do Not Disturb

You can have incoming calls automatically forwarded to another destination. You can also have incoming calls rejected (Do Not Disturb).

Note

- When Call Forwarding or Do Not Disturb is enabled, **FWD/DND** appears on the display in stand-by mode.

To access the FWD/DND settings

- In stand-by mode, press **Setting** or **[FORWARD/DO NOT DISTURB]**.
 - If you press **[FORWARD/DO NOT DISTURB]**, continue to step 3.
- Press **[▲]** or **[▼]** to select "FWD/DND Setting", and then press **[ENTER]**.
- If line selection is available, press **[▲]** or **[▼]** to select the desired line, and then press **[ENTER]**.
- Press **[▲]** or **[▼]** to select the type of FWD or DND setting to apply, and then press **[ENTER]**.
- Configure the settings as necessary (Page 41).

Logging in to or Logging out of a Group (KX-UT133/KX-UT136 only)

Logging in to or Logging out of an ACD (Automatic Call Distribution) Group

If the SIP server supports ACD and you are assigned to an ACD group, you can log in to or log out of the group.

- In stand-by mode, press the flexible button assigned as the ACD Log-in/Log-out button.

Note

- The flexible button's light indicates the status as follows:
Off: logged in to the ACD group
Red On: logged out of the ACD group

Flexible Buttons (KX-UT133/KX-UT136 only)

The flexible buttons on the unit can be customized to be used to make or receive calls or as feature buttons. These buttons are configured by your administrator or dealer.

The following types of flexible buttons are available:

DN (Directory Number)

Seizes the line assigned to the DN button. When a call arrives at the DN button, pressing the button answers the call.

Lamp Indication

- **Off:** Idle
- **Green on:** You are on a call using the DN button.
- **Flashing green rapidly:** A call is being received.
- **Flashing green slowly:** A call is on hold.
- **Red on:** A shared line is in use or on hold (private) at another unit.
- **Flashing red slowly:** A shared line is on hold (normal) at another unit.

Note

- A ring tone can be assigned to each DN button through Web user interface programming. When a call arrives at a DN button, the ring tone assigned to that button plays. For details, consult your administrator or dealer.
- A shared line is a line that can be used by multiple units. This is an optional feature and may not be supported on your phone system.

One-Touch

Calls the party or accesses a feature assigned to the button. See "One-touch Dialing (KX-UT133/KX-UT136 only) (Page 26)".

Headset

Enables or disables talking using the headset.

Lamp Indication

- **Off:** Headset off
- **Red on:** Headset on

BLF (Busy Lamp Field)

Calls the extension assigned to the button. During a conversation, a BLF button can be used to transfer calls to the assigned extension (Page 30).

A BLF button's lamp also shows the current status of the assigned extension.

Lamp Indication

- **Off:** The assigned extension is idle.
- **Red on:** The assigned extension is using the line.
- **Flashing red rapidly:** The assigned extension is receiving an incoming call. If enabled through Web user interface programming, pressing the button answers the call (Directed Call Pickup).

Note

- BLF (Busy Lamp Field) is an optional feature and may not be supported on your phone system.

ACD

Logs in to or logs out of a group when ACD (Automatic Call Distribution) is enabled (Page 33).

Lamp Indication

- **Off:** Logged in
- **Red on:** Logged out

Note

- ACD is an optional feature and may not be supported on your phone system.

Customizing the Telephone

Phonebook List

Adding a New Phonebook Entry

You can add a maximum of 500 (for KX-UT123/KX-UT133/KX-UT136) or 100 (for KX-UT113) phonebook entries to the unit.

To make a call from the phonebook, see "Making a Call from the Phonebook List (Page 25)".

1. Press **☰**.
2. Press **Add**.
3. Enter a name (max. 24 characters), and then press **[ENTER]**.
4. Press **[▲]** or **[▼]** to select the phone number type (**①** to **⑤**) or "Ringtone X", and then press **[ENTER]**.
5. Do one of the following, depending on your selection in the previous step:
 - If you selected a phone number type**
 - Enter the phone number (max. 32 digits), and then press **[ENTER]**.
 - If you selected "Ringtone X"**
 - Select a ringtone to play when you receive a call from this party, and then press **[ENTER]**.
6. To add another phone number to the entry, repeat the procedure from step 4.
7. Press **Save**.

Note

- If you store multiple phone numbers in the entry, you can assign the preferred number to use when you call this party. In step 4, select the desired number, and then press **Prefer**.
- If you do not press any buttons for 1 minute, the unit will return to stand-by mode.

Adding a Phonebook Entry from the Incoming Call Log

You can add new phonebook entries from the incoming call log.

1. Press **Call Log**.
2. Press **[▲]** or **[▼]** to select "Incoming Call Log", and then press **[ENTER]**.

3. Press **[▲]** or **[▼]** to select the desired call log entry, and then press **Save**.
4. Select "Phonebook", and then press **[ENTER]**.
5. Enter a name (max. 24 characters), and then press **[ENTER]**.
6. Press **[▲]** or **[▼]** to select the phone number type (**①** to **⑤**) or "Ringtone X", and then press **[ENTER]**.
7. Do one of the following, depending on your selection in the previous step:
 - If you selected a phone number type**
 - Enter the phone number (max. 32 digits), and then press **[ENTER]**.
 - If you selected "Ringtone X"**
 - Select a ringtone to play when you receive a call from this party, and then press **[ENTER]**.
8. To add another phone number to the entry, repeat the procedure from step 6.
9. Press **Save**.

Note

- If a name is stored in the call log, it is automatically entered in step 5.
- If you store multiple phone numbers in the entry, you can assign the preferred number to use when you call this party. In step 6, select the desired number, and then press **Prefer**.
- If you do not press any buttons for 1 minute, the unit will return to stand-by mode.

Editing a Phonebook Entry

You can edit the information stored in phonebook entries.

1. Press **☰**.
2. Press **[▲]** or **[▼]** to display the desired entry, or press **Search** and search for the desired entry (Page 36).
3. Do one of the following, depending on your unit:
 - For KX-UT113/KX-UT123 users**
 - Press **Menu**, select "Edit", and then press **[ENTER]**.
 - For KX-UT133/KX-UT136 users**
 - Press **Edit**.
4. Press **[▲]** or **[▼]** to select the item you want to edit, and then press **[ENTER]**.

5. Edit the item as necessary, and then press **[ENTER]**.
6. Press **Save**.

Note

- If you store multiple phone numbers in the entry, you can assign the preferred number to use when you call this party. In step 4, select the desired number, and then press **Prefer**.
- If you do not press any buttons for 1 minute, the unit will return to stand-by mode.

Searching for a Phonebook Entry

You can search the phonebook for the desired entry.

1. Press **Book**.
2. Press **Search**.
3. Enter the name you want to search for, and then press **[ENTER]**.

Deleting a Phonebook Entry

You can delete phonebook entries.

1. Press **Book**.
2. Press **[▲]** or **[▼]** to display the desired entry, or press **Search** and search for the desired entry (Page 36).
3. Do one of the following, depending on your unit:
For KX-UT113/KX-UT123 users
 - Press **Menu**, select "Erase", and then press **[ENTER]**.**For KX-UT133/KX-UT136 users**
 - Press **Erase**.
4. Press **[▲]** or **[▼]** to select "Yes", and then press **[ENTER]**.

Export/Import Phonebook Entries

You can export the phonebook entries through the Web user interface to your computer as a tab separated value file. This makes it possible to add and edit phonebook entries using a spreadsheet application or text editor on your computer. After editing, the file should be imported into the unit.

Also, phonebook entries exported from one unit can be imported into another, which makes it easy to share phonebook entries.

To export/import entries, consult your administrator or dealer.

Notice

- Entries deleted on your computer are not deleted from the unit's phonebook when importing. Erase unnecessary entries with your unit, not through the Web user interface.
- Phone calls cannot be made or received while phonebook entries are being imported or exported.

User Settings

You can configure various settings to customize the behavior of the unit. This section explains how to configure the settings using the unit.

Accessing the Settings

1. In stand-by mode, press **Setting**.
2. Press **[▲]** or **[▼]** to select the desired setting category, and then press **[ENTER]**.
3. Configure the settings as necessary.

Available Settings

└ Ringer	└ Ringer Volume	Page 40
	└ Ringtone	Page 40
└ ECO Mode		Page 40
└ LCD Contrast		Page 40
└ Back Light		Page 41
└ Display Lock		Page 41
└ FWD/DND Setting	└ Do Not Disturb	Page 41
	└ FWD All	Page 41
	└ FWD Busy	Page 41
	└ FWD No Ans	Page 42
└ Language		Page 42
└ Date and Time		Page 43
└ Information Display		Page 43
└ Network Settings	└ Network	Page 44
		└ DHCP
		└ DNS
		└ DNS1 ¹
		└ DNS2 ¹
		└ STATIC
		└ IP Address
		└ Subnet mask
		└ Default Gateway
		└ DNS1
		└ DNS2
	└ VLAN	└ Enable VLAN
		└ IP Phone
		└ PC ²
	└ Speed/Duplex	└ LAN port
		└ PC port ²
	└ Embedded web	Page 45
└ Network Test		Page 45
└ Default Setting	└ Factory Setting	Page 46
	└ IP Reset	Page 46
└ Restart		Page 46
└ Firmware version		Page 46

↳ Call Block

Page 47

- *1 This setting is available only if "DNS" is set to "Manual".
- *2 This setting is available only on KX-UT123/KX-UT133/KX-UT136.

Settings Details

Ringer

Setting	Description	Value Range	Default
Ringer Volume	Adjust the ringer volume.	Level 0 to 6	Level 3
Ringtone (current setting confirmation)	For KX-UT133/KX-UT136, you can listen to the ring tones. Ring tones can be assigned to DN buttons (flexible buttons, Page 34) through Web user interface programming (Page 56), but they cannot be assigned directly from the unit. For details about which ring tones are assigned or if you want to change an assigned ring tone, consult your administrator or dealer. For KX-UT113/KX-UT123, select a ring tone to use for incoming calls. If multiple lines are available at your unit, you must first select which line to use the ring tone for.	Ringtone 1– Ringtone 32	Ringtone 1

Note

- The preset melodies in this product are used with permission of © 2009 Copyrights Vision Inc.
- Ringtone 20 to Ringtone 24 are the same as Ringtone 1.
- Ring tones can also be assigned to individual entries in the phonebook list (Page 35).

ECO Mode

Setting	Description	Value Range	Default
ECO Mode	Enabling this mode reduces the amount of electricity consumed by the unit.	On, Off	Off

Note

- When ECO mode is enabled, the Speed/Duplex setting (Page 45) changes as follows:
 - Speed/Duplex: "10M-Full"
 - PC port cannot be used.
- When the Eco mode setting is changed, the unit will restart.
- When Eco mode is enabled, **ECO** is displayed while the unit is in stand-by mode.

LCD Contrast

Setting	Description	Value Range	Default
LCD Contrast	Change the contrast of the display.	Level 1 to 6	Level 3

Back Light (KX-UT123/KX-UT133/KX-UT136 only)

Setting	Description	Value Range	Default
Back Light	Change the settings for the backlight.	Always On Automatic Always Off	Automatic
	If you select "Always On" or "Automatic", press [▲] or [▼] to adjust the brightness.	Level 1 to 3	Level 3

Note

- When "Automatic" is selected, the backlight turns off when the phone returns to an idle state.

Display Lock

Setting	Description	Value Range	Default
Display Lock	Lock access to your call log and phonebook list by entering your extension PIN (Personal Identification Number).	On, Off	Off

Note

- The extension PIN can be configured through Web user interface programming. For details, consult your administrator or dealer.

FWD/DND Setting

If multiple lines are available at your unit, press [▲] or [▼] to select the line to apply the settings to when you select "FWD/DND Setting".

Setting	Description	Value Range	Default	
Do Not Disturb	Enable DND (Do Not Disturb) to reject all incoming calls.	On, Off	Off	
FWD All	Forward all incoming calls to a specified destination.	—	—	
	On/Off	Enable or disable the "FWD All" setting.	On, Off	Off
	Phone Number	Specify the number to forward calls to when "FWD All" is enabled.	1–32 digits	—
FWD Busy	Forward incoming calls to a specified destination when you are on a call.	—	—	
	On/Off	Enable or disable the "FWD Busy" setting.	On, Off	Off

Setting	Description	Value Range	Default
Phone Number	Specify the number to forward calls to when "FWD Busy" is enabled.	1–32 digits	—
FWD No Ans	Forward incoming calls to a specified destination if you do not answer after a specified number of rings.	—	—
On/Off	Enable or disable the "FWD No Ans" setting.	On, Off	Off
Phone Number	Specify the number to forward calls to when "FWD No Ans" is enabled.	1–32 digits	—
Ring count	After you specify the phone number to forward calls to, enter the number of times the unit will ring before forwarding the call.	0, 2–20	3

Language

Setting	Description	Value Range	Default
Language	Select the language to use for the display.	Čeština Dansk Deutsch (DE) English (UK) English (US) Español Français Français (Canada) Hrvatski Italiano Magyar Nederlands Polski Português Slovenčina Svenska Ελληνικά Русский Українська	(Depends on your country/area)

Date and Time

Setting	Description	Value Range	Default
Date and Time	Set the date and time.	Date ¹ : dd/mm/yyyy or mm/dd/yyyy Time ² : 00:00–23:59 or 12:00–11:59 AM/ PM	—

¹ Pressing [#] switches the date format.

² If the time format is not assigned in the configuration data, you can change the time format (12-hour or 24-hour) by pressing [*]. If the time format is set to 12-hour time in the configuration data, you can change the AM/PM setting by pressing [*].

Note

- Daylight-saving time can be set through Web user interface programming. For details, consult your administrator or dealer.

Information Display

Setting	Description	Value Range	Default
Information Display	View a variety of information about the unit. Press [▲] and [▼] to display the various settings. The following settings can be viewed: <ul style="list-style-type: none"> Registration status to the SIP server IP address Subnet mask address Default gateway address IP address of the DNS server 1 IP address of the DNS server 2 ACS status Display lock status Firmware version MAC address 	—	—

Network Settings

IMPORTANT

We recommend configuring these settings with your administrator or dealer. Network settings can also be configured through Web user interface programming (Page 56). Contact your administrator or dealer for further information.

Setting	Description	Value Range	Default
Network	Configure the basic network settings. If you select " DHCP ", you must then select whether the DNS setting is configured automatically or manually. If you select " STATIC ", you must manually specify the IP address, subnet mask, default gateway, and DNS servers.	DHCP, STATIC	—
When DHCP is selected			
DNS	Select whether the DNS server information should be obtained automatically (i.e., provided by the DHCP server) or if you will specify it manually. If you select " Manual ", see " DNS1 " and " DNS2 " below.	Manual, Automatic	Automatic
DNS1 ^{*1} (Manual DNS only)	Enter the IP address of the primary DNS server.	xxx.xxx.xxx.xxx	—
DNS2 ^{*1} (Manual DNS only)	Enter the IP address of the secondary DNS server. If a secondary DNS server is not required, leave this item blank.	xxx.xxx.xxx.xxx	—
When STATIC is selected			
IP Address ^{*1}	Enter the IP address to assign to the unit.	xxx.xxx.xxx.xxx	—
Subnet mask ^{*1}	Enter the subnet mask for your network.	xxx.xxx.xxx.xxx	—
Default Gateway ^{*1}	Enter the IP address of the default gateway for your network.	xxx.xxx.xxx.xxx	—
DNS1 ^{*1}	Enter the IP address of the primary DNS server.	xxx.xxx.xxx.xxx	—
DNS2 ^{*1}	Enter the IP address of the secondary DNS server. If a secondary DNS server is not required, leave this item blank.	xxx.xxx.xxx.xxx	—
VLAN	Configure the VLAN (Virtual LAN) settings.	—	—
Enable VLAN	Select whether to enable the VLAN functionality.	Yes, No	No
IP Phone	Specify the necessary settings for using the phone features over a VLAN.	—	—

Setting	Description	Value Range	Default
VLAN ID	Specify the VLAN ID.	1–4094	2
Priority	Specify the priority of packets sent from this unit.	0–7	7
PC (KX-UT123/ KX-UT133/KX-UT136 only)	Specify the necessary settings for using a PC over a VLAN.	—	—
VLAN ID	Specify the VLAN ID.	1–4094	1
Priority	Specify the priority of packets sent from this unit.	0–7	0
Speed/Duplex	Select the connection mode (combination of link speed and duplex mode) of the LAN port and PC port.	—	—
LAN port	Select the connection mode of the LAN port.	Auto, 10M-Full, 10M-Half, 100M-Full, 100M-Half	Auto
PC port (KX-UT123/ KX-UT133/KX-UT136 only)	Select the connection mode of the PC port.	Auto, 10M-Full, 10M-Half, 100M-Full, 100M-Half	Auto
Embedded web	Enable or disable Web User Interface Programming.	On, Off	Off

¹¹ Press **[▲]** and **[▼]** to switch between these items.

Network Test

Setting	Description	Value Range	Default
Network Test	Confirm whether other network devices (e.g., SIP server, routers, switching hubs) respond to network requests. When you select this item, enter the IP address of the device to which you want to test the connection. If a device does not respond, first check the unit's network settings, and then check the device's network settings and connection.	xxx.xxx.xxx.xxx	—

Default Setting

IMPORTANT

We recommend configuring these settings with your administrator or dealer. Contact your administrator or dealer for further information.

Setting	Description	Value Range	Default
Factory Setting	Reset all settings to their factory-shipment state.	—	—
IP Reset	Reset the following settings to their default values: <ul style="list-style-type: none"> • Network Settings (Page 43) For details about the Web settings that are reset, consult your administrator or dealer.	—	—

Restart

Setting	Description	Value Range	Default
Restart	Restart the unit (Page 71).	—	—

Firmware version

Setting	Description	Value Range	Default
Firmware version	View the version of the currently installed firmware. If a newer version is available, its version is also displayed. In this case, press Update to update the firmware.	—	—

Note

- Your phone system dealer may offer new features or an improved version of the unit's software from time to time. If you set the unit software update setting to manual mode through the Web user interface, you need to download the update when "Update version. Press OK." is displayed. Contact your administrator or dealer for further information.

Call Block

Setting	Description	Value Range	Default
Call Block	<p>Register telephone numbers so that calls received from those numbers are blocked. You can also delete registered numbers.</p> <p>To register</p> <ol style="list-style-type: none"> 1. Press Add. 2. Enter the telephone number to block, and then press [ENTER]. <p>To edit</p> <ol style="list-style-type: none"> 1. Press [▲] or [▼] to select the blocked telephone number to edit. 2. Press Edit. 3. Edit the number as necessary, and then press [ENTER]. <p>To delete</p> <ol style="list-style-type: none"> 1. Press [▲] or [▼] to select the blocked telephone number to delete. 2. Press Erase. 3. Select "Yes", and then press [ENTER]. 	—	—

Entering Characters

The dial keys are used to enter characters and numbers. Each dial key has multiple characters assigned to it. (For example, A, B and C are assigned to the 1 key.)

To enter a character, press the corresponding dial key until the character you want appears. To enter another character that is assigned to the same key, first press [▶] to move the cursor to the right.

Example

To enter "DESK", press the keys as follows:

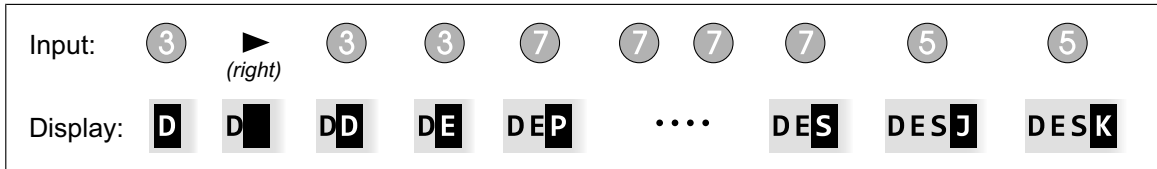

For details about the characters assigned to each key, see "Character Tables (Page 50)".

Deleting characters

Press **Clear** to delete the last character entered.



Note

- Press and hold **Clear** to delete all entered text.

Switching between uppercase and lowercase

Press **A/a** to switch between uppercase entry and lowercase entry.

Modifying entered text

Use [◀] and [▶] to move the cursor to where you want to modify the text. Then, modify the text as follows:

- Press **Clear** to delete the character under the cursor.



- Press a dial key to insert a character at the cursor's location.

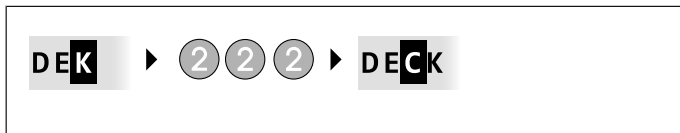

- Press **A/a** to change the case of the character under the cursor.



Note

- If the maximum number of characters has been entered, entering another character will overwrite the character under the cursor.
- If the entered texts spans two or more lines, you can also move the cursor using **[▲]** and **[▼]**.

Character entry modes

The six character entry modes let you enter a variety of characters.

The following character modes are available:

- Latin (ABC)
- Numeric (0–9)
- Greek (ΑΒΓ)
- Extended 1 (ĂĂĂ)
- Extended 2 (ŠŠŠ)
- Cyrillic (АБВ)

For details about which characters are available in each mode, see "Character Tables (Page 50)".

To select a character mode

1. When entering characters, press **1/A/?**.
2. Press **[▲]** or **[▼]** to select the desired character entry mode.
3. Press **[ENTER]**.

Note

- Depending on the type of information you are entering, you cannot change character modes. For example, when you are entering a phone number, only numeric mode is available.

Character Tables

ABC (Latin)

Button	Characters
①	! ? " 1
	! ? " 1
②	A B C 2
	a b c 2
③	D E F 3
	d e f 3
④	G H I 4
	g h i 4
⑤	J K L 5
	j k l 5
⑥	M N O 6
	m n o 6
⑦	P Q R S 7
	p q r s 7
⑧	T U V 8
	t u v 8
⑨	W X Y Z 9
	w x y z 9
⑩	<Space> . , ' : ; 0
	<Space> . , ' : ; 0
✳	/ + - = < > *
	/ + - = < > *
#	\$ % & @ () € £ #
	\$ % & @ () € £ #

Note

- For each button, the upper row shows the characters entered in uppercase mode, and the lower row shows the characters entered in lowercase mode.

0–9 (Numeric)

Button	Characters
①	1
②	2
③	3
④	4
⑤	5
⑥	6
⑦	7
⑧	8
⑨	9
⑩	0
*	*
#	#

ABΓ (Greek)

Button	Characters
①	! ? " 1 ! ? " 1
②	A B Γ 2 α β γ 2
③	Δ E Z 3 δ ε ζ 3
④	H Θ I 4 η θ ι 4
⑤	K Λ M 5 κ λ μ 5
⑥	N Ξ Ο 6 ν ξ ο 6
⑦	Π Ρ Σ 7 π ρ σ 7
⑧	T Υ Φ 8 τ υ φ 8
⑨	X Ψ Ω Υ 9 χ ψ ω υ 9
⑩	<Space> . , ' : ; 0 <Space> . , ' : ; 0
*	/ + - = < > * / + - = < > *
#	\$ % & @ () € £ # \$ % & @ () € £ #

Note

- For each button, the upper row shows the characters entered in uppercase mode, and the lower row shows the characters entered in lowercase mode.

AÄÅ (Latin Extended 1)

Button	Characters
①	! ? " 1 ----- ! ? " 1
②	A À Á Â Ã Ä Å Æ B C Ç 2 ----- a à á â ã ä å æ b c ç 2
③	D Đ E È É Ê Ë Ì Í Î Ï 3 ----- d ð e è é ê ë ì í î ï 3
④	G Ğ H I Ì Í Î Ï Ĭ Ĳ 4 ----- g ğ h i ì í î ï ĳ Ĳ 4
⑤	J K L 5 ----- j k l 5
⑥	M N Ñ O Ò Ó Ô Õ Ö Ø Œ 6 ----- m n ñ o ò ó ô õ ö ø œ 6
⑦	P Q R S Ş ß 7 ----- p q r s ş ß 7
⑧	T U Û Ú Û Ü Õ V 8 ----- t u ù ú û ü õ v 8
⑨	W Ŵ X Y Ŷ Z 9 ----- w ŵ x y ŷ z 9
⑩	<Space> . , ' : ; 0 ----- <Space> . , ' : ; 0
* (star)	/ + - = < > * ----- / + - = < > *
# (hash)	\$ % & @ () € £ # ----- \$ % & @ () € £ #

Note

- For each button, the upper row shows the characters entered in uppercase mode, and the lower row shows the characters entered in lowercase mode.

SŠŠ (Latin Extended 2)

Button	Characters
①	! ? " 1 ! ? " 1
②	A Á Ā Ą Ą B C Č Ć 2 a á ä ä a b c ć ć 2
③	D Ď E É Ę Ě F 3 d ď e é ę ę f 3
④	G H I Í 4 g h i í 4
⑤	J K L Ł Ł Í Ĺ 5 j k l ł ł í ĺ 5
⑥	M N Ń Ņ O Ó Ö Ő 6 m n ń ņ o ó ö ő 6
⑦	P Q R Ř Ř S Ś Š 7 p q r ř ř s ś š 7
⑧	T Ŧ Ţ Ť U Ú Ü Ů Ű V 8 t ŧ ť ŧ u ú ü ů ű v 8
⑨	W X Y Ÿ Ý Z Ž Ž Ž 9 w x y ÿ ý z ž ž ž 9
⑩	<Space> . , ' : ; 0 <Space> . , ' : ; 0
*	/ + - = < > * / + - = < > *
#	\$ % & @ () € £ # \$ % & @ () € £ #

Note

- For each button, the upper row shows the characters entered in uppercase mode, and the lower row shows the characters entered in lowercase mode.

АБВ (Cyrillic)

Button	Characters
①	А Б В ! ? " 1 ----- а б в ! ? " 1
②	Г Д Е Ё 2 ----- г д е ё 2
③	Ж З И Й 3 ----- ж з и й 3
④	К Л М 4 ----- к л м 4
⑤	Н О П 5 ----- н о п 5
⑥	Р С Т 6 ----- р с т 6
⑦	У Ф Х 7 ----- у ф х 7
⑧	Ц Ч Ш 8 ----- ц ч ш 8
⑨	Щ Ъ Ы Ь 9 ----- щ ъ ы ь 9
⑩	Э Ю Я <Space> . , ' : ; 0 ----- э ю я <Space> . , ' : ; 0
* ⑩	/ + - = < > Г € I ï * ----- / + - = < > г е і і *
# ⑩	\$ % & @ () € I ŷ # ----- \$ % & @ () € і ь #

Note

- For each button, the upper row shows the characters entered in uppercase mode, and the lower row shows the characters entered in lowercase mode.

Web User Interface Programming

The unit provides a Web-based interface for configuring various settings and features, including some that are not programmable directly from the unit. The following list contains some useful features that are programmable through the Web user interface.

For details, consult your administrator or dealer.

- Basic network settings^{*1} (Page 43)
- User password (for access to Web user interface)
- HTTP authentication settings
- Date and time settings^{*1} (Page 43)
- Default outgoing line
- Call rejection phone numbers^{*1} (Page 47)
- Block caller ID
- Block anonymous calls
- Do Not Disturb^{*1} (Page 41)
- Call forward^{*1} (Page 41)
- Flexible button settings (Page 34) (DN, One-Touch, Headset, etc. KX-UT133/KX-UT136 only)
- Key click tone
- Extension PIN
- Phonebook import and export (Page 36)

^{*1} These settings can also be configured directly through the unit.

Notice

- Each time you want to access the Web user interface, you must enable Web programming (Page 45).

Installation and Setup

Notice

- Panasonic assumes no responsibility for injuries or property damage resulting from failures arising out of improper installation or operation inconsistent with this documentation.

Attaching/Removing the Stand

Attaching the Stand

For KX-UT133/KX-UT136/KX-UT248:

1. Insert the catches (A) of the stand into hooks located in the unit.
2. Gently push the stand in the direction indicated until it locks into place.
The stand will be mounted in the high position.

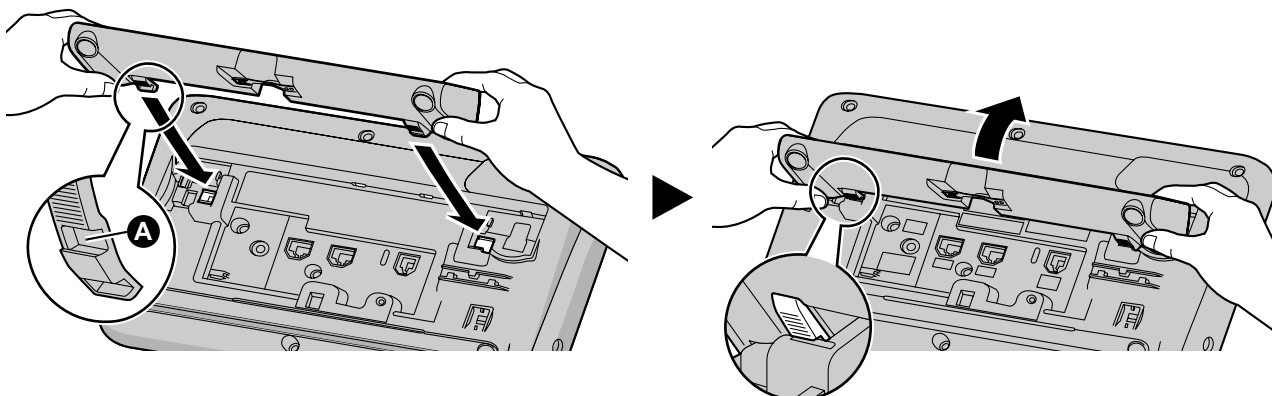

For KX-UT113/KX-UT123:

1. Insert the catches of the stand into hooks located in the unit.
2. Gently push the stand in the direction indicated until it locks into place.
The stand will be mounted.

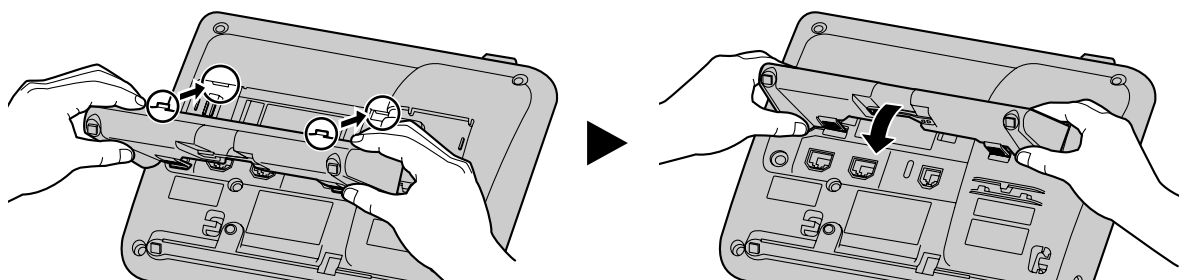

Removing the Stand

For KX-UT133/KX-UT136/KX-UT248:

1. Hold the stand with both hands.

2. Gently rotate the stand in the direction indicated until it is released.

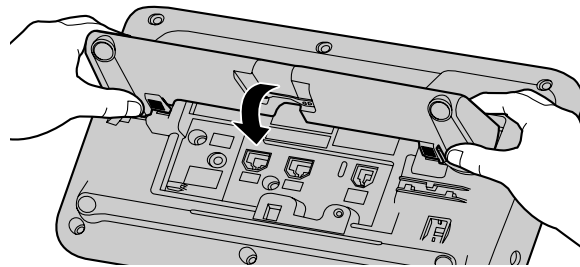

For KX-UT113/KX-UT123:

1. Remove the stand in the direction indicated while pushing the catches of the stand with both hands as shown.

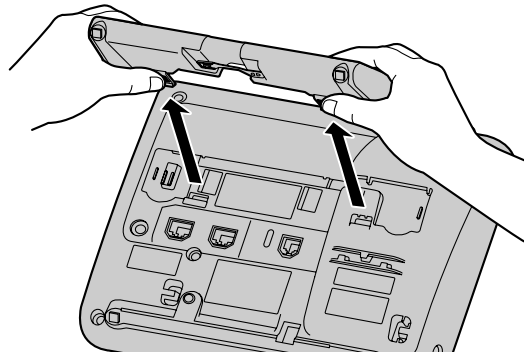

Adjusting from High to Low Position (KX-UT133/KX-UT136/KX-UT248 only)

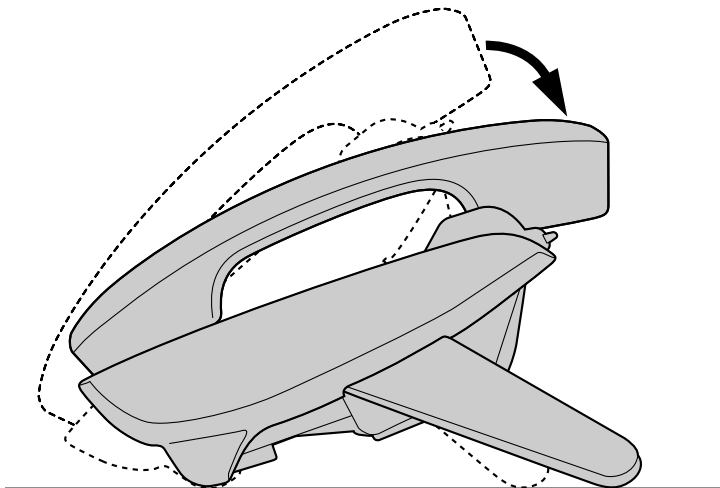

1. Tilt the stand in the direction indicated while pushing the PUSH mark with both hands as shown until it locks into the low position (B).

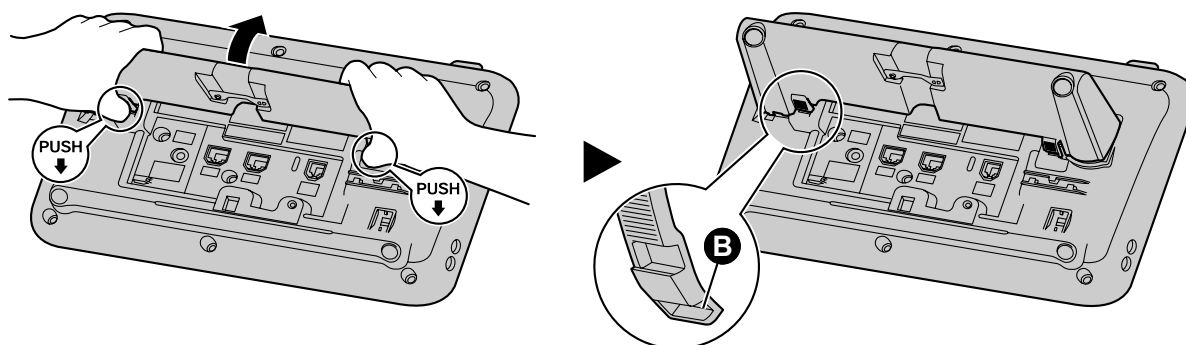

Adjusting from Low to High Position (KX-UT133/KX-UT136/KX-UT248 only)

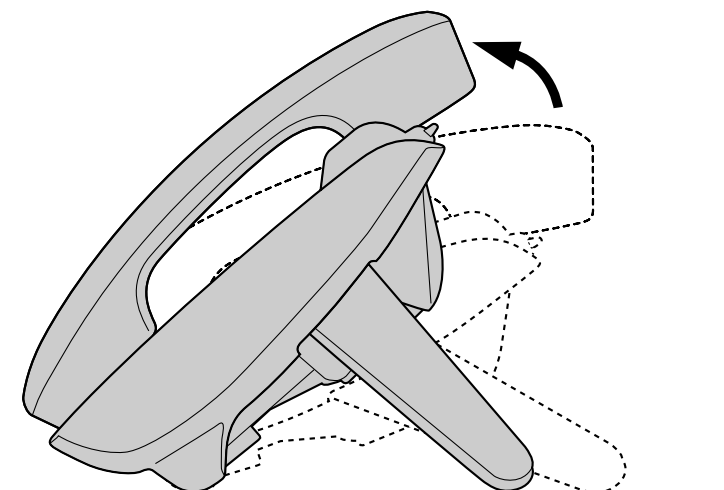

1. Tilt the stand in the direction indicated while pushing the PUSH mark with both hands as shown until it locks into the high position (A).

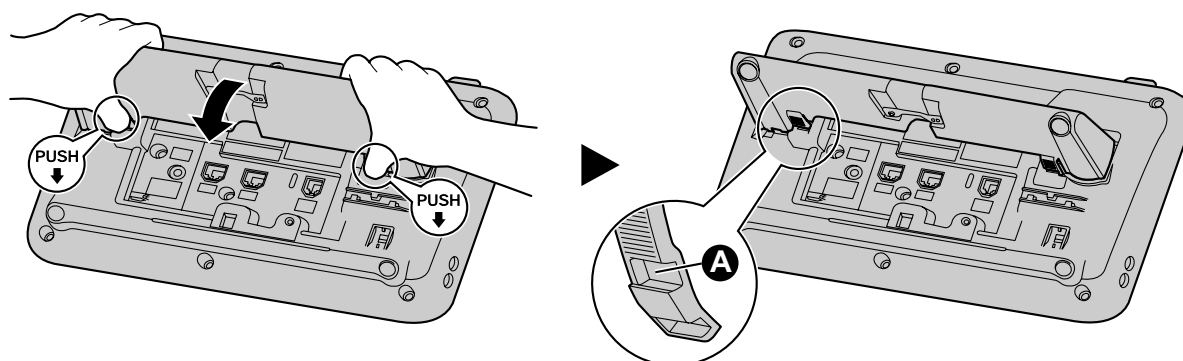

Connections

This section explains the ports and connectors on the unit.

Connections for AC Adaptor/LAN/PC

For KX-UT133/KX-UT136/KX-UT248:

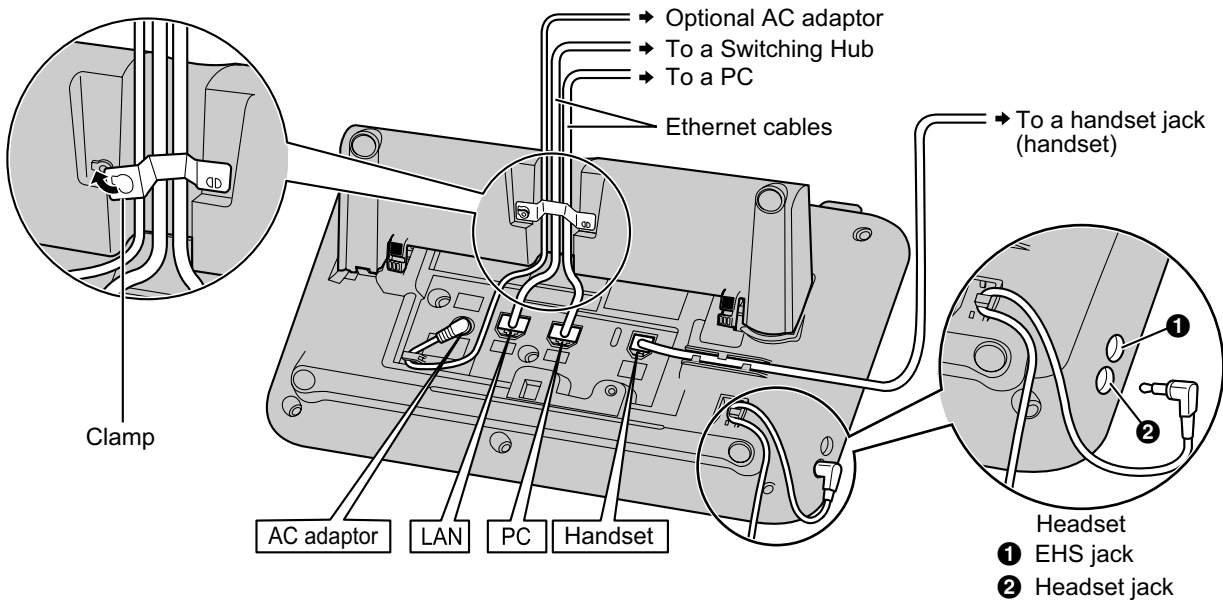

For KX-UT113/KX-UT123:

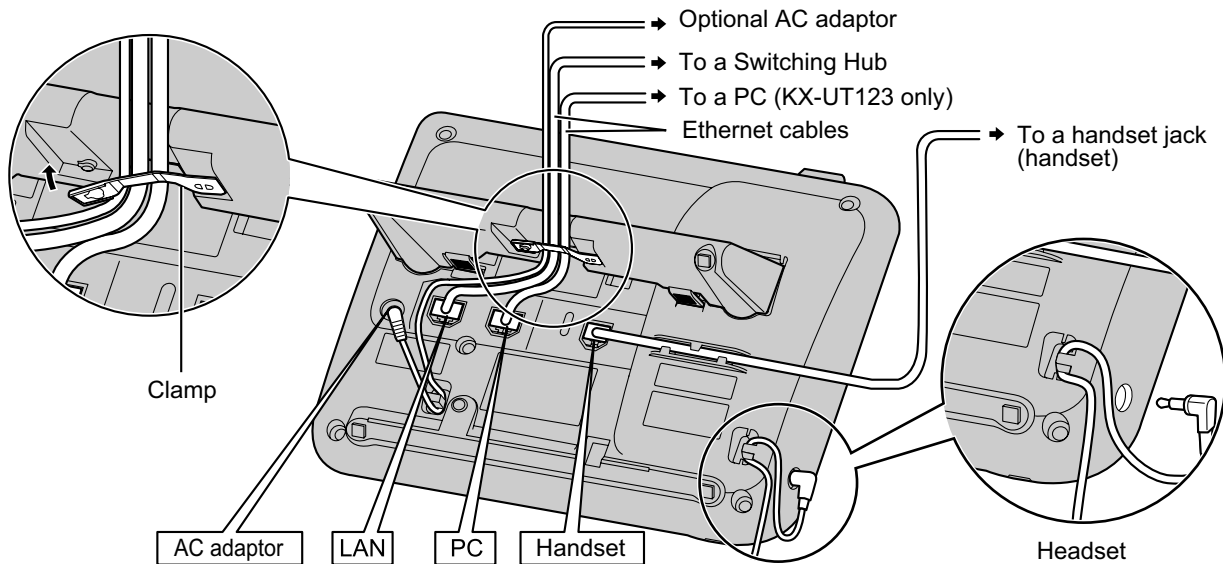

CAUTION

Optional AC Adaptor

- Use the following Panasonic AC adaptor:
 - For users in the United States: KX-A239 (PQLV206)
 - For users in Canada: KX-A239X (PQLV206)

- The AC adaptor is used as the main disconnect device. Ensure that the AC outlet is installed near the unit and is easily accessible.

When connecting a headset

- Ensure that the headset cord has slack and is not pulled tight during use to prevent damage to the connectors.

Notice

- It is recommended that you use one of the following headsets:
 - Wired headsets
Panasonic KX-TCA400 or KX-TCA430
 - EHS headsets (KX-UT133/KX-UT136/KX-UT248 only)
Plantronics® Savi® Talk, Voyager™, or CS series

When selecting Ethernet cables (not included)

- Use flexible, high-quality, snagless (without strain relief) cables. Do not use cables with coating that may tear or crack when bent.
To prevent damage to the cables, use cables that do not protrude from the bottom of the base. Connect the cables as shown in the following illustration.

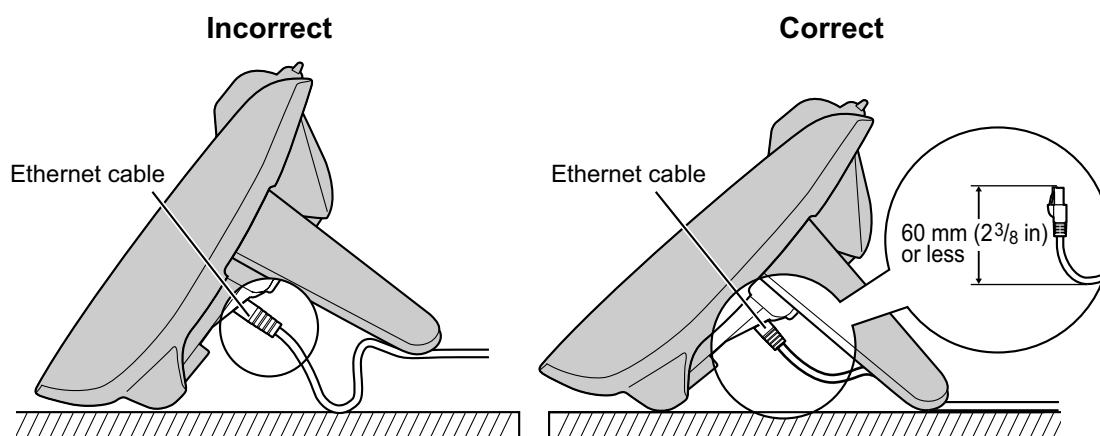

- Use a straight CAT 5 (or higher) Ethernet cable (not included) that is 6.5 mm (1/4 in) in diameter or less.

When connecting to a switching hub

- If PoE is available, an AC adaptor is not needed.
- For KX-UT113/KX-UT123/KX-UT133/KX-UT136: This unit complies with the PoE Class 2 standard.
- For KX-UT248: This unit complies with the PoE Class 0 standard.

When connecting a PC

- Only a PC can be connected to the PC port. Other SIP phones, or network devices such as routers or switching hubs, cannot be connected.
- The PC port does not support PoE for connected devices.

When connecting cables and the AC adaptor

- Ensure that the Ethernet cables and the AC adaptor cord are clamped to prevent damage to the connectors.

Connections for Handset

For KX-UT133/KX-UT136/KX-UT248:

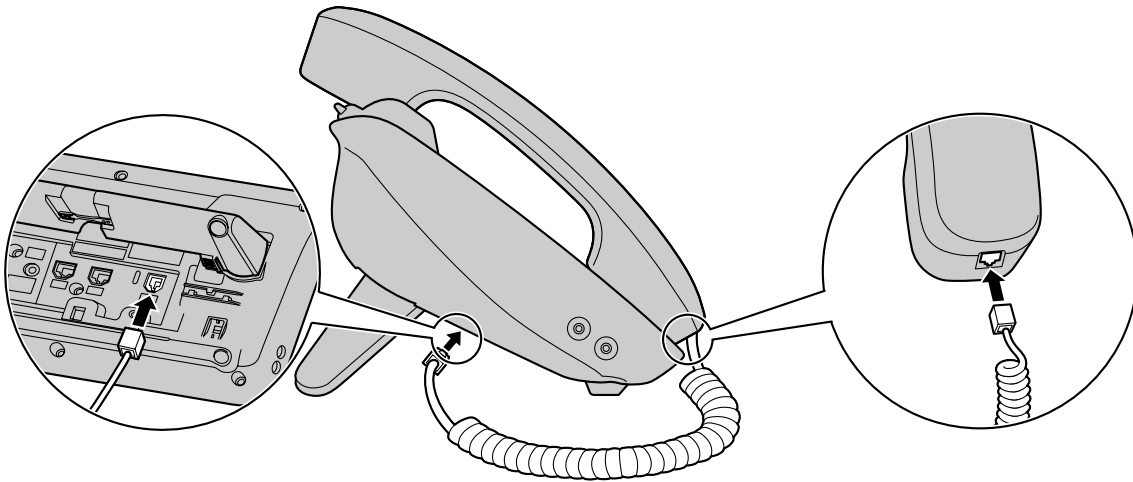

For KX-UT113/KX-UT123:

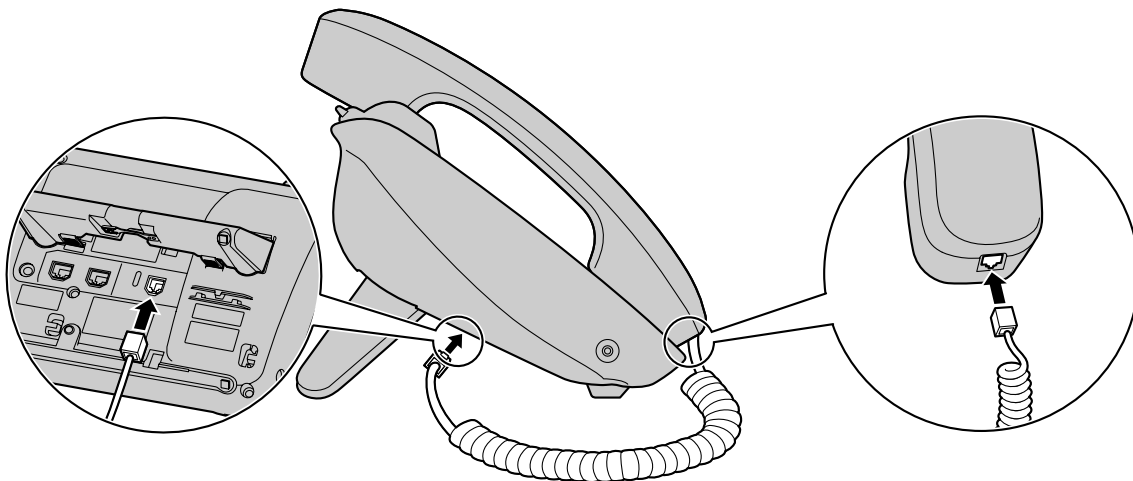

Wall Mounting

Before Mounting on a Wall

To mount the unit, it is necessary to remove the stand. For details, see "Removing the Stand (Page 57)".

Mounting the Unit

WARNING

- Do not mount the unit in a manner other than that described in this section.
- Make sure that the wall that the unit will be attached to is strong enough to support the unit. If not, it is necessary for the wall to be reinforced. For information about the weight of the unit, see "Specifications (Page 72)".
- Only use the optional wall mount kit with the unit. The wall mount kit includes the necessary screws, washers, and wall mounting adaptor.
- When driving the screws into the wall, be careful to avoid touching any metal laths, wire laths or metal plates in the wall.
- When this unit is no longer in use, make sure to detach it from the wall.

CAUTION

- Make sure the cables are securely fastened to the wall.
1. Insert the 5 tabs (for KX-UT133/KX-UT136/KX-UT248) or 3 tabs (for KX-UT113/KX-UT123) of the wall mounting adaptor into the designated openings in the base, and then slide the wall mounting adaptor in the direction of the arrow until it clicks.

For KX-UT133/KX-UT136/KX-UT248:

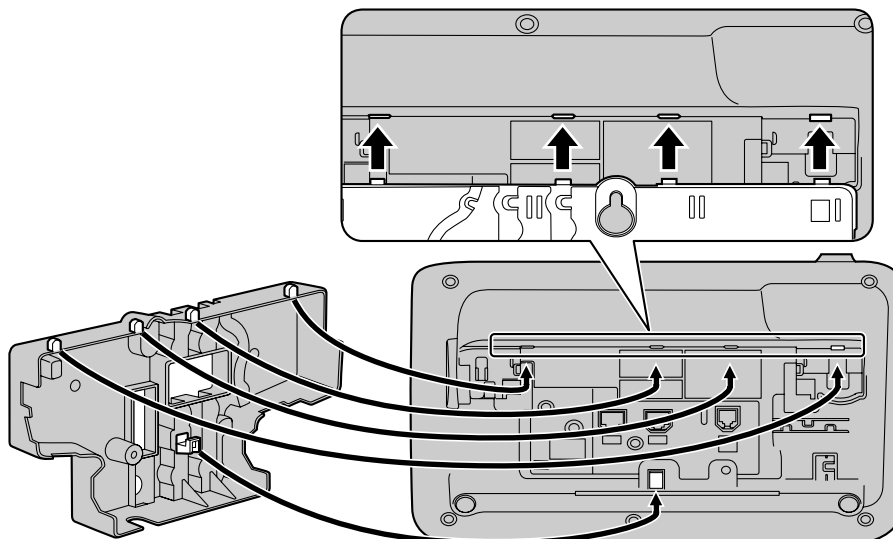

For KX-UT113/KX-UT123:

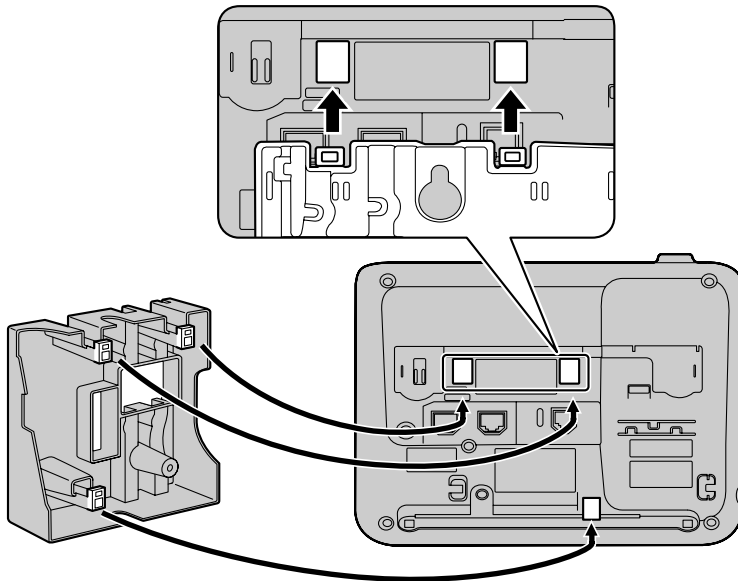

2. Fasten the wall mounting adaptor to the base with 1 screw. (Recommended torque: 0.4 N·m [4.08 kgf·cm/ 3.54 lbf·in] to 0.6 N·m [6.12 kgf·cm/5.31 lbf·in])

For KX-UT133/KX-UT136/KX-UT248:

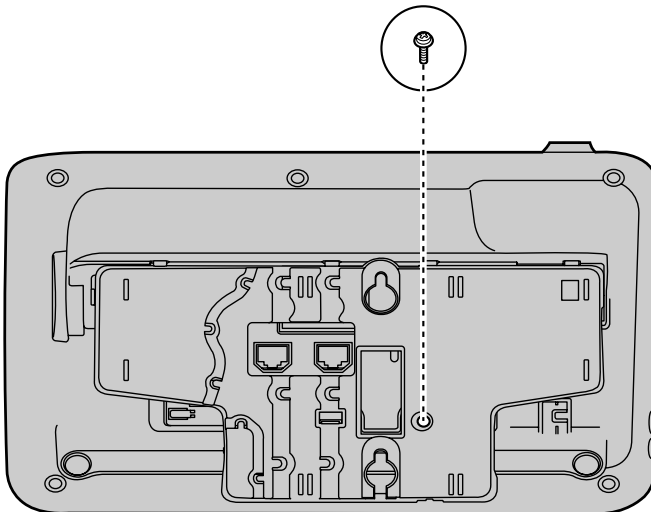

For KX-UT113/KX-UT123:

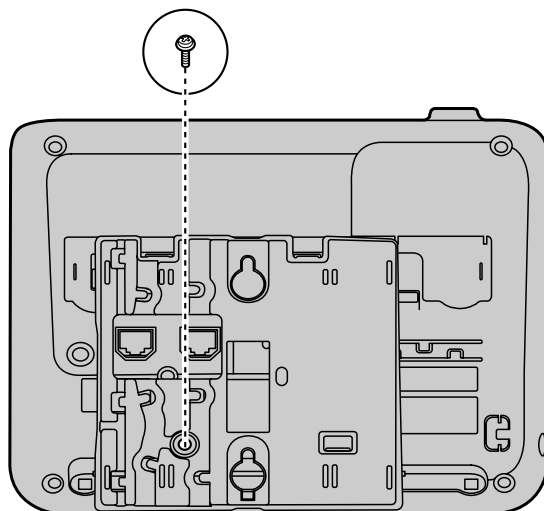

3. Connect the cables to the unit, and run the cables through the wall mounting adaptor, as shown in the illustration below.
For details about connecting the cables, see "Connections (Page 60)".

Note

- The cables can also be run from the bottom of the unit.

For KX-UT133/KX-UT136/KX-UT248:

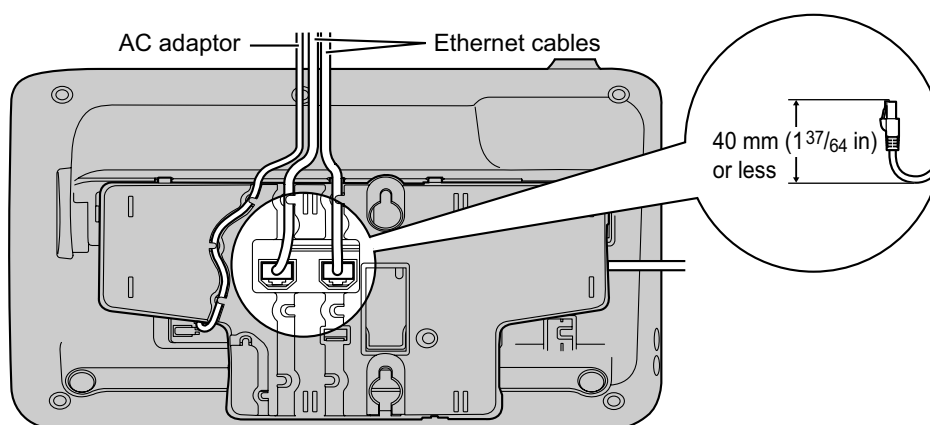

For KX-UT113/KX-UT123:

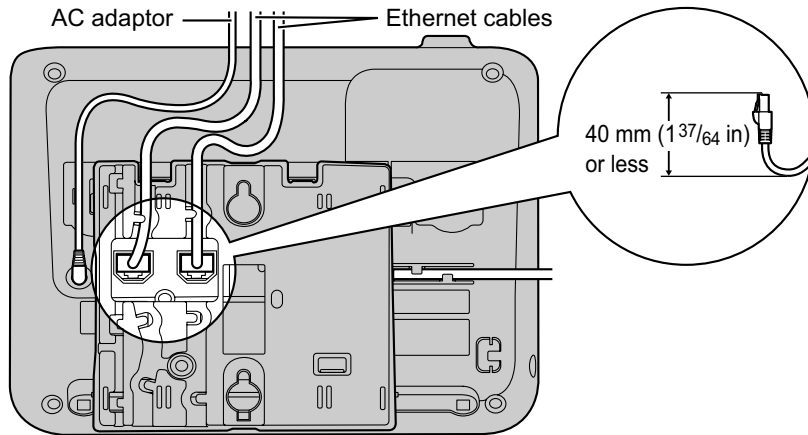

4. Drive 2 screws into the wall as shown in the illustration below, and mount the unit on the wall.

For KX-UT133/KX-UT136/KX-UT248:

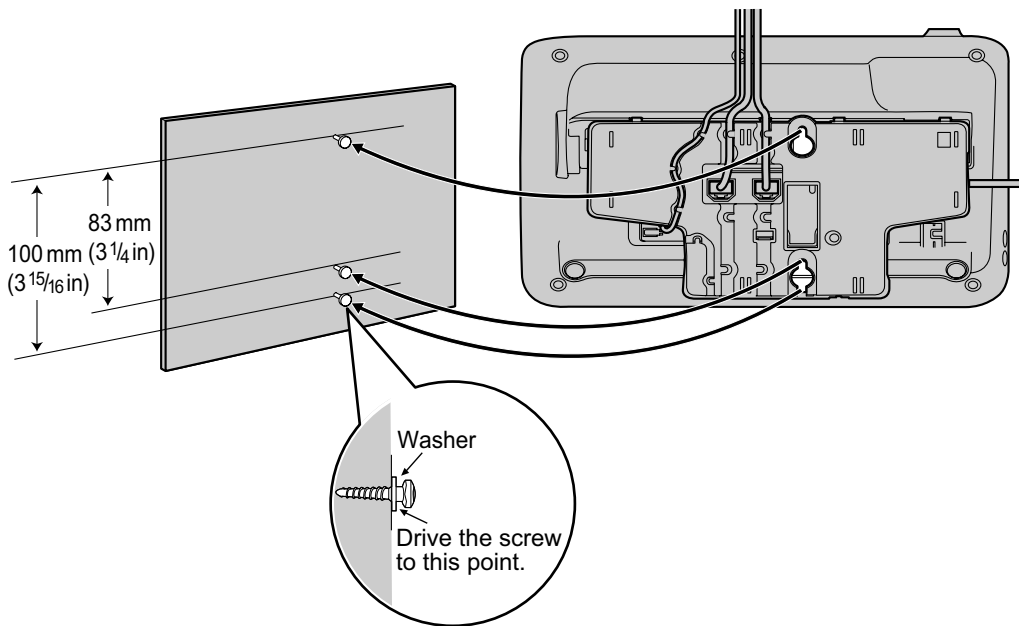

For KX-UT113/KX-UT123:

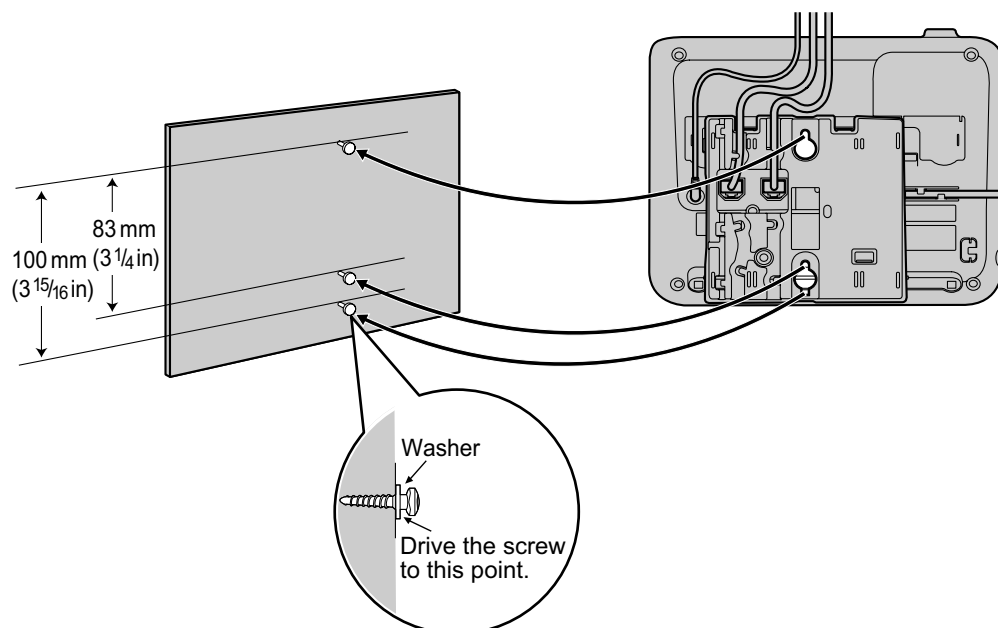

Note

- You can find a wall mounting template at the end of this manual.
- For information about locking the handset, see "Hooking the Handset (Page 68)".

Hooking the Handset

You can hook the handset with following operations.

To Hook the Handset During a Conversation

1. Hook the handset over the top edge of the unit.

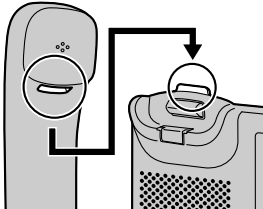

To Lock the Handset Hook when the Unit is Wall Mounted

1. Remove the handset hook from the slot.

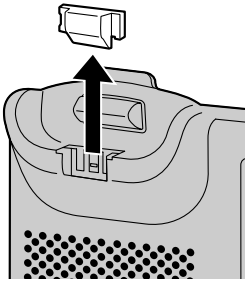

2. Turn it up-side-down.

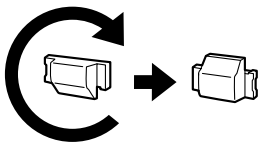

3. Slide the handset hook back into the slot until it locks.

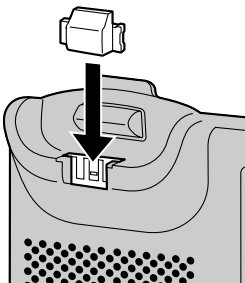

4. Handset is safely hooked when it is in the cradle.

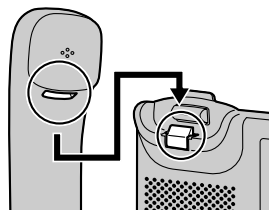

Using a Headset

For KX-UT133/KX-UT136, if a headset is connected, you must enable Headset mode using the Headset button (flexible button).

To enable Headset mode, press the Headset button (flexible button). When in Headset mode, **[SP-PHONE]** is used for going on- and off-hook.

Making a Call Using a Headset

1. Press **[SP-PHONE]**.
2. Enter the number you want to call.
3. Press **[ENTER]**, or wait a few seconds for the number to be dialed.
4. To end the call, press **[SP-PHONE]**.

Receiving a Call Using a Headset

1. Press **[SP-PHONE]**.
2. To end the call, press **[SP-PHONE]**.

Note

- For details about connecting a headset, see "Connections (Page 60)".
- For KX-UT113/KX-UT123, the Headset mode is automatically enabled when connecting a headset.
- The Headset button light shows the current status as follows:
Off: Headset mode off
Red on: Headset mode on
- For details about setting a flexible button as the Headset button, consult your administrator or dealer.

Setting Up the Unit

This section explains the settings that you can configure when you start the unit.

Accessing the start-up settings

1. Connect the unit to an Ethernet cable capable of delivering power (PoE compliant), or use an optional AC adaptor to supply power.
2. Connect the unit to the network.
3. On the start-up screen, press **Setup**.
4. Select the item for the settings you want to configure.

Start-up menu

You can configure the following start-up settings:

1. **Information Display** (Page 43)
View a variety of information about the unit.
2. **Network Settings** (Page 43)
Assign an IP address in order to connect to the network and use the unit.
3. **Network Test** (Page 45)
Confirm the connection of network devices (e.g., the SIP server, routers, switching hubs).
4. **ECO Mode** (Page 40)
Enable ECO mode.
5. **Language** (Page 42)
If you prefer to use a language other than English, change your language settings.
6. **Default Setting** (Page 46)
Initialize the unit to reset the settings to their default values.
7. **Restart** (Page 46)
Restart the unit for new settings to take effect.
8. **Firmware version** (Page 46)
Check the firmware version of the unit.

Maintaining the Unit

Initializing the Unit

Doing an initialization resets some or all settings to their default values. There are two types of initialization:

- **Factory Setting**
Resets all settings in the unit to their default values. This type of initialization also deletes all other data on the unit, such as the call logs and the phonebook. Do a Factory Setting initialization before transferring the unit to a third party, such as for maintenance. Doing so reduces the risk of an unauthorized third party obtaining personal data.
- **IP Reset**
Resets only the network settings to their default values. Do an IP Reset initialization when changing the unit's network environment.

For details about doing an initialization, see "Default Setting (Page 46)".

Restarting the Unit

When some of the settings on the unit have been changed via Web user interface programming or configuration file programming, the unit must be restarted.

1. In stand-by mode, press **Setting**.
2. Press **[▲]** or **[▼]** to select "Restart", and then press **[ENTER]**.
3. Press **[▲]** or **[▼]** to select "Yes", and then press **[ENTER]**.
 - To cancel, select "No".

Cleaning the Unit

Clean the unit by periodically by wiping it with a soft and dry cloth.



When cleaning the unit, observe the following precautions.

When cleaning the display

- Wipe the display with only the following types of materials:
 - A soft and dry cloth.
 - A soft cloth with very small quantity of neutral detergent or ethyl alcohol.
- Do not press or rub the display with too much force.

When cleaning the body

- To avoid damaging the unit, disconnect the Ethernet cable and all other cables from the unit before cleaning. If the unit is powered with an AC adaptor, disconnect the AC adaptor from the unit and power outlet before cleaning.
- If the unit becomes particularly dirty, apply a light kitchen cleanser to a soft cloth, wring the cloth thoroughly, and then wipe the unit. When finished, dry the unit with a soft and dry cloth.
- To avoid damage or discoloration, do not clean the unit with the any of following materials or with cleaners that contain any of the following materials:
 - Petroleum
 - Scouring powder
 - Alcohol
 - Paint thinner
 - Benzene
 - Wax
 - Hot water
 - Powdered soap
- When using chemical cleansers, follow the instructions on the label carefully.

Appendix

Specifications

For KX-UT113/KX-UT123/KX-UT133/KX-UT136

Item	Specifications			
	KX-UT113	KX-UT123	KX-UT133	KX-UT136
Display	3 line (No backlight)	3 line with backlight		6 line with backlight
Flexible Buttons	—		24	
VoIP Connection Method	SIP			
VoIP Audio Codec	G.722, G.711, G.729A, G.726			
Ethernet Interface	10Base-T/100Base-TX			
IP Address Mode	Automatic (DHCP), Manual (static)			
Speaker	1			
Microphone	1			
Ethernet Port (LAN)	1 (RJ45)	2 (RJ45)		
Headset Jack	1 (ø 2.5 mm [3/32 in])			
EHS Jack	—		1 (ø 3.5 mm [1/8 in], for EHS only)	
Dimensions (Width × Depth × Height; handset on cradle, stand attached)	205 mm × 160 mm × 170 mm (8.07 in × 6.30 in × 6.69 in)		"High" position: 267 mm × 170 mm × 180 mm (10.5 in × 6.69 in × 7.09 in) "Low" position: 267 mm × 187 mm × 155 mm (10.5 in × 7.36 in × 6.10 in)	
Weight (with handset, handset cord and stand)	860 g (1.90 lb)	870 g (1.92 lb)	1120 g (2.47 lb)	
PoE	IEEE 802.3af compliant			
Power Consumption	PoE Stand-by: approx. 1.8 W (ECO mode off), approx. 1.3 W (ECO mode on) Talking: approx. 2 W (ECO mode off), approx. 1.5 W (ECO mode on) AC Adaptor Stand-by: approx. 1.6 W (ECO mode off), approx. 1 W (ECO mode on) Talking: approx. 2 W (ECO mode off), approx. 1.5 W (ECO mode on)			
Maximum Power Consumption	6 W			
Operating Environment	0 °C to 40 °C (32 °F to 104 °F)			

For KX-UT248

Item	Specifications
Display	4.4 inch with backlight
Flexible Buttons	24
VoIP Connection Method	SIP
VoIP Audio Codec	G.722, G.711, G.729A, G.726
Ethernet Interface	10Base-T/100Base-TX/1000Base-T
IP Address Mode	Automatic (DHCP), Manual (static)
Speaker	1
Microphone	1
Ethernet Port (LAN)	2 (RJ45)
Headset Jack	1 (ø 2.5 mm [3/32 in])
EHS Jack	1 (ø 3.5 mm [1/8 in], for EHS only)
Bluetooth	Bluetooth wireless technology 2.0
Dimensions (Width × Depth × Height; handset on cradle, stand attached)	"High" position: 267 mm × 170 mm × 180 mm (10.5 in × 6.69 in × 7.09 in) "Low" position: 267 mm × 187 mm × 155 mm (10.5 in × 7.36 in × 6.10 in)
Weight (with handset, handset cord and stand)	1130 g (2.49 lb)
PoE	IEEE 802.3af compliant
Power Consumption	PoE Stand-by: approx. 3.0 W (ECO mode off), approx. 1.3 W (ECO mode on) Talking: approx. 4.6 W (ECO mode off), approx. 1.5 W (ECO mode on) AC Adaptor Stand-by: approx. 1.6 W (ECO mode off), approx. 1 W (ECO mode on) Talking: approx. 2 W (ECO mode off), approx. 1.5 W (ECO mode on)
Maximum Power Consumption	6.5 W
Operating Environment	0 °C to 40 °C (32 °F to 104 °F)

Troubleshooting

Common Issues and Solutions

General Use

Issue	Possible Cause & Solution	Reference
The display is blank.	<ul style="list-style-type: none"> The unit is not receiving power. <ul style="list-style-type: none"> → The unit is not designed to function when there is a power failure. Make sure that the device supplying PoE is receiving power and that the Ethernet cable is properly connected. If an AC adaptor is connected, confirm that the AC adaptor is connected and receiving power. 	Page 60
The display is not shown well.	<ul style="list-style-type: none"> The display's contrast is too low. <ul style="list-style-type: none"> → Adjust the display's contrast. 	Page 40
The unit is not performing properly.	<ul style="list-style-type: none"> Cables or cords are not connected properly. <ul style="list-style-type: none"> → Check all connections. 	Page 60
	<ul style="list-style-type: none"> Your connection settings are incorrect. <ul style="list-style-type: none"> → Consult your administrator to confirm that your settings are correct. → If the problem persists, consult your dealer. 	Page 37
	<ul style="list-style-type: none"> An error has occurred. <ul style="list-style-type: none"> → Restart the unit. 	Page 71
 is displayed on the screen.	<ul style="list-style-type: none"> Registration to the SIP server has been lost. <ul style="list-style-type: none"> → Consult your administrator or dealer. 	—
I cannot hear a dial tone.	<ul style="list-style-type: none"> Confirm that the LAN cable is properly connected. 	Page 60
I cannot cancel the display lock.	<ul style="list-style-type: none"> The PIN number you entered was incorrect. <ul style="list-style-type: none"> → Consult your administrator or dealer. 	—
I forgot my PIN number.	<ul style="list-style-type: none"> Consult your administrator or dealer. 	—
The date and time are not correct.	<ul style="list-style-type: none"> Adjust the date and time of the unit. 	Page 43
The Message/Ringer lamp is lit.	<ul style="list-style-type: none"> You received a voice message while you were on the phone or away from your desk. <ul style="list-style-type: none"> → Check the voice message. 	Page 32

Making and Receiving Calls

Issue	Possible Cause & Solution	Reference
I cannot make calls.	<ul style="list-style-type: none"> Your phone system/service has disabled service for your unit. → On the Information Display screen (Page 43), if "Not registered" is displayed in "Status", consult your administrator or dealer. 	—
	<ul style="list-style-type: none"> The phone number was entered incorrectly. → Confirm that you have entered the phone number of the other party correctly. → Consult your administrator or dealer. 	Page 25
	<ul style="list-style-type: none"> The unit is downloading a firmware update. → You cannot make calls while the unit is downloading updates. Wait for the update to finish, and then try making a call. 	—
	<ul style="list-style-type: none"> The phonebook list is being imported or exported. → Wait a few minutes for the operation to complete. → Confirm with your administrator or dealer. 	—
I cannot make long distance calls.	<ul style="list-style-type: none"> Your telephone service does not allow you to make long distance calls. → Make sure that you have subscribed to your telephone company's long distance service. 	—
The unit does not ring when a call is received.	<ul style="list-style-type: none"> The ringer is turned off. → Press [▲] while a call is being received, or change the ringer volume setting. 	Page 40
While talking to an outside party, the line is disconnected.	<ul style="list-style-type: none"> Your phone system/service may impose a time limit on outside calls. → Consult your dealer to extend the time limit, if necessary. 	—

Sound Quality

Issue	Possible Cause & Solution	Reference
The other party cannot hear my voice.	<ul style="list-style-type: none"> The unit is muted. → Press [MUTE] to turn off the mute feature. 	Page 30
	<ul style="list-style-type: none"> If you are using the speakerphone, objects may be obstructing the microphone. → Do not obstruct the unit's microphone during calls. Keep your hands, as well as common objects such as folders, cups, and coffee pots away from the unit during calls. 	—

Issue	Possible Cause & Solution	Reference
Sound cuts out; I can hear myself through the speaker.	<ul style="list-style-type: none"> You are too far away from the microphone. → Try speaking closer to the microphone. 	—
	<ul style="list-style-type: none"> The environment is not suited to speakerphone calls. → Do not use the unit within 2 m of projectors, air conditioning devices, fans, or other audible or electrical noise emitting devices. → If using the unit in a room with windows, close the curtains or blinds to prevent echoes. → Use the unit in a quiet environment. 	—
	<ul style="list-style-type: none"> The unit was moved during a call. → Do not move the unit while on a call. 	—
	<ul style="list-style-type: none"> Objects are obstructing the microphone. → Do not obstruct the unit during calls. Keep your hands, as well as common objects such as folders, cups, and coffee pots away from the unit during calls. 	—
	<ul style="list-style-type: none"> The other party is using a half-duplex speakerphone. → If the other party is using a half-duplex speakerphone, sound may cut out occasionally during calls. For best performance, the other party should use a full-duplex speakerphone. 	—

Phonebook List

Issue	Possible Cause & Solution	Reference
I cannot add or edit entries to the phonebook list.	<ul style="list-style-type: none"> The phonebook list is full. → Delete any unnecessary entries. The maximum number of entries in the phonebook list is 500 for the KX-UT123/ KX-UT133/KX-UT136 and 100 for the KX-UT113. 	Page 35

Error Messages

During operation, error messages might appear on the unit. The following table lists these messages and possible causes and solutions.

Message	Possible Causes & Solutions	Reference
IP address collision	<ul style="list-style-type: none"> The unit's network settings are incorrect. → Consult your system administrator or dealer. 	—
Illegal IP address		
Invalid IP address		
Check LAN cable.	<ul style="list-style-type: none"> The LAN cable is not connected. → Check all connections. 	Page 60

Message	Possible Causes & Solutions	Reference
Memory Full	<ul style="list-style-type: none">A new entry for the phonebook or call block list cannot be stored because the phonebook or call block list is full. → Erase unneeded entries.	Page 36
No Entries	<ul style="list-style-type: none">The phonebook or call block list contains no entries. → Store entries in the phonebook or call block list.	Page 35 Page 27
Please wait...	<ul style="list-style-type: none">The unit is still starting up. → If you have a lot of entries in the phonebook list, the unit may take a while to start up. This is normal.	—

Open Source Software

Parts of this product use Open Source Software. Relevant conditions apply to this software. Panasonic cannot accept inquiries regarding the content of the following copyright and license information.

<<NetBSD kernel>>

This product uses a part of NetBSD kernel.

The use of a part of NetBSD kernel is based on the typical BSD style license below.

Copyright (c)

The Regents of the University of California. All rights reserved.

Redistribution and use in source and binary forms, with or without modification, are permitted provided that the following conditions are met:

1. Redistributions of source code must retain the above copyright notice, this list of conditions and the following disclaimer.
2. Redistributions in binary form must reproduce the above copyright notice, this list of conditions and the following disclaimer in the documentation and/or other materials provided with the distribution.
3. All advertising materials mentioning features or use of this software must display the following acknowledgement:
This product includes software developed by the University of California, Berkeley and its contributors.
4. Neither the name of the University nor the names of its contributors may be used to endorse or promote products derived from this software without specific prior written permission.

THIS SOFTWARE IS PROVIDED BY THE REGENTS AND CONTRIBUTORS "AS IS" AND ANY EXPRESS OR IMPLIED WARRANTIES, INCLUDING, BUT NOT LIMITED TO, THE IMPLIED WARRANTIES OF MERCHANTABILITY AND FITNESS FOR A PARTICULAR PURPOSE ARE DISCLAIMED. IN NO EVENT SHALL THE REGENTS OR CONTRIBUTORS BE LIABLE FOR ANY DIRECT, INDIRECT, INCIDENTAL, SPECIAL, EXEMPLARY, OR CONSEQUENTIAL DAMAGES (INCLUDING, BUT NOT LIMITED TO, PROCUREMENT OF SUBSTITUTE GOODS OR SERVICES; LOSS OF USE, DATA, OR PROFITS; OR BUSINESS INTERRUPTION) HOWEVER CAUSED AND ON ANY THEORY OF LIABILITY, WHETHER IN CONTRACT, STRICT LIABILITY, OR TORT (INCLUDING NEGLIGENCE OR OTHERWISE) ARISING IN ANY WAY OUT OF THE USE OF THIS SOFTWARE, EVEN IF ADVISED OF THE POSSIBILITY OF SUCH DAMAGE.

However, parts of the NetBSD Kernel are provided with the following copyright notices.

- Copyright (c) 1980, 1983, 1988, 1993 The Regents of the University of California. All rights reserved.
- Copyright (c) 1980, 1986, 1989, 1993 The Regents of the University of California. All rights reserved.
- Copyright (c) 1980, 1986, 1991, 1993 The Regents of the University of California. All rights reserved.
- Copyright (c) 1980, 1986, 1993 The Regents of the University of California. All rights reserved.
- Copyright (c) 1982, 1985, 1986, 1988, 1993, 1994 The Regents of the University of California. All rights reserved.
- Copyright (c) 1982, 1986, 1988, 1990, 1993 The Regents of the University of California. All rights reserved.
- Copyright (c) 1982, 1986, 1988, 1990, 1993, 1994, 1995 The Regents of the University of California. All rights reserved.
- Copyright (c) 1982, 1986, 1988, 1990, 1993, 1995 The Regents of the University of California. All rights reserved.
- Copyright (c) 1982, 1986, 1988, 1991, 1993 The Regents of the University of California. All rights reserved.
- Copyright (c) 1982, 1986, 1988, 1993 The Regents of the University of California. All rights reserved.
- Copyright (c) 1982, 1986, 1988, 1993, 1995 The Regents of the University of California. All rights reserved.
- Copyright (c) 1982, 1986, 1989, 1991, 1993 The Regents of the University of California. All rights reserved.
- Copyright (c) 1982, 1986, 1989, 1993 The Regents of the University of California. All rights reserved.
- Copyright (c) 1982, 1986, 1990, 1991, 1993 The Regents of the University of California. All rights reserved.
- Copyright (c) 1982, 1986, 1990, 1993 The Regents of the University of California. All rights reserved.
- Copyright (c) 1982, 1986, 1990, 1993, 1994 The Regents of the University of California. All rights reserved.
- Copyright (c) 1982, 1986, 1991, 1993 The Regents of the University of California. All rights reserved.
- Copyright (c) 1982, 1986, 1991, 1993, 1994 The Regents of the University of California. All rights reserved.
- Copyright (c) 1982, 1986, 1991, 1993, 1995 The Regents of the University of California. All rights reserved.
- Copyright (c) 1982, 1986, 1993 The Regents of the University of California. All rights reserved.
- Copyright (c) 1982, 1986, 1993, 1994 The Regents of the University of California. All rights reserved.
- Copyright (c) 1982, 1986, 1993, 1994, 1995 The Regents of the University of California. All rights reserved.

Copyright (c) 1982, 1986, 1993, 1995 The Regents of the University of California. All rights reserved.
Copyright (c) 1982, 1988, 1991, 1993 The Regents of the University of California. All rights reserved.
Copyright (c) 1983, 1990, 1993 The Regents of the University of California. All rights reserved.
Copyright (c) 1983, 1993 The Regents of the University of California. All rights reserved.
Copyright (c) 1985, 1986, 1993 The Regents of the University of California. All rights reserved.
Copyright (c) 1985, 1986, 1993 The Regents of the University of California. All rights reserved.
Copyright (c) 1986, 1989, 1991, 1993 The Regents of the University of California. All rights reserved.
Copyright (c) 1986, 1993 The Regents of the University of California. All rights reserved.
Copyright (c) 1987, 1991, 1993 The Regents of the University of California. All rights reserved.
Copyright (c) 1987, 1993 The Regents of the University of California. All rights reserved.
Copyright (c) 1987, 1993 The Regents of the University of California. All rights reserved.
Copyright (c) 1988 Regents of the University of California. All rights reserved
Copyright (c) 1988 Stephen Deering.
Copyright (c) 1988 University of Utah.
Copyright (c) 1988, 1989, 1993 The Regents of the University of California. All rights reserved.
Copyright (c) 1988, 1991, 1993 The Regents of the University of California. All rights reserved.
Copyright (c) 1988, 1992, 1993 The Regents of the University of California. All rights reserved.
Copyright (c) 1988, 1993 The Regents of the University of California. All rights reserved.
Copyright (c) 1989 The Regents of the University of California. All rights reserved.
Copyright (c) 1989, 1991, 1993 The Regents of the University of California. All rights reserved.
Copyright (c) 1989, 1993 The Regents of the University of California. All rights reserved.
Copyright (c) 1989, 1993, 1994 The Regents of the University of California. All rights reserved.
Copyright (c) 1990, 1991, 1993 The Regents of the University of California. All rights reserved.
Copyright (c) 1990, 1993 The Regents of the University of California. All rights reserved.
Copyright (c) 1991, 1993 The Regents of the University of California. All rights reserved.
Copyright (c) 1991, 1993, 1994 The Regents of the University of California. All rights reserved.
Copyright (c) 1992 Regents of the University of California. All rights reserved.
Copyright (c) 1992, 1993 The Regents of the University of California. All rights reserved.
Copyright (c) 1993 The Regents of the University of California. All rights reserved.
Copyright (c) 1993 Adam Glass
Copyright (C) 1993 by Sun Microsystems, Inc. All rights reserved.
Copyright (c) 1994 Gordon W. Ross
Copyright (c) 1994 Winning Strategies, Inc. All rights reserved.
Copyright (c) 1995 The Regents of the University of California. All rights reserved.
Copyright (C) 1995, 1996, 1997, and 1998 WIDE Project. All rights reserved.
Copyright (c) 1996 The Regents of the University of California. All rights reserved.
Copyright (c) 1996 John S. Dyson All rights reserved.
Copyright (c) 1996 Matt Thomas. All rights reserved.
Copyright (c) 1996 Matthew R. Green. All rights reserved.
Copyright (c) 1996 Paul Kranenburg
Copyright (c) 1996, 1997, 1999, 2001 The NetBSD Foundation, Inc. All rights reserved.
Copyright (c) 1996, 2000 Christopher G. Demetriou. All rights reserved.
Copyright (c) 1996,1999 by Internet Software Consortium.
Copyright (c) 1996-1999 by Internet Software Consortium.
Copyright (c) 1997 Jonathan Stone and Jason R. Thorpe. All rights reserved.
Copyright (c) 1997 Christos Zoulas. All rights reserved.
Copyright (c) 1997 Manuel Bouyer. All rights reserved.
Copyright (c) 1997, 1998 The NetBSD Foundation, Inc. All rights reserved.
Copyright (c) 1997, 1998, 1999, 2000 The NetBSD Foundation, Inc. All rights reserved.
Copyright (c) 1997, 1998, 1999, 2001 The NetBSD Foundation, Inc. All rights reserved.
Copyright (c) 1997, 1998, 1999, 2002 The NetBSD Foundation, Inc. All rights reserved.
Copyright (c) 1997, 1998, 2000, 2001 The NetBSD Foundation, Inc. All rights reserved.
Copyright (c) 1997, 1998, 2001 The NetBSD Foundation, Inc. All rights reserved.
Copyright (c) 1997,98 The NetBSD Foundation, Inc. All rights reserved.
Copyright (C) 1997-2000 Sony Computer Science Laboratories Inc. All rights reserved.
Copyright (c) 1997-2002 The NetBSD Foundation, Inc. All rights reserved.
Copyright (c) 1998 The NetBSD Foundation, Inc. All rights reserved.
Copyright (c) 1998 Todd C. Miller <Todd.Miller@courtesan.com> All rights reserved.
Copyright (c) 1998, 1999 The NetBSD Foundation, Inc. All rights reserved.
Copyright (c) 1998, 1999, 2000 The NetBSD Foundation, Inc. All rights reserved.
Copyright (c) 1998, 1999, 2000, 2001 The NetBSD Foundation, Inc. All rights reserved.
Copyright (c) 1998, 2000 The NetBSD Foundation, Inc. All rights reserved.
Copyright (c) 1998, 2000, 2001 The NetBSD Foundation, Inc. All rights reserved.
Copyright (c) 1999 The NetBSD Foundation, Inc. All rights reserved.
Copyright (C) 1999 WIDE Project. All rights reserved.

Open Source Software

Copyright (c) 1999, 2000 Jason L. Wright (jason@thought.net) All rights reserved.
Copyright (c) 1999, 2000 The NetBSD Foundation, Inc. All rights reserved.
Copyright (c) 1999, 2000, 2001 The NetBSD Foundation, Inc. All rights reserved.
Copyright (c) 1999, 2001 The NetBSD Foundation, Inc. All rights reserved.
Copyright (c) 2000 The NetBSD Foundation, Inc. All rights reserved.
Copyright (c) 2000, 2001 The NetBSD Foundation, Inc. All rights reserved.
Copyright (c) 2000, 2001, 2002 The NetBSD Foundation, Inc. All rights reserved.
Copyright (c) 2001 The NetBSD Foundation, Inc. All rights reserved.
Copyright (c) 2002 The NetBSD Foundation, Inc. All rights reserved.
Copyright 1998 Massachusetts Institute of Technology. All rights reserved.
Copyright 2001 Wasabi Systems, Inc. All rights reserved.
Portions Copyright (c) 1993 by Digital Equipment Corporation.
Portions Copyright (c) 1995 by International Business Machines, Inc.
Copyright (c) 1983, 1989 The Regents of the University of California. All rights reserved.
Copyright (c) 1996 by Internet Software Consortium. All rights reserved.
Copyright (c) 1980, 1986, 1989 Regents of the University of California. All rights reserved.
Copyright (c) 1988 The Regents of the University of California. All rights reserved.
Copyright (c) 1992, 1993 The Regents of the University of California. All rights reserved.
Copyright (c) 1994 Christopher G. Demetriou. All rights reserved.
Copyright (c) 1997 The NetBSD Foundation, Inc. All rights reserved.
Copyright (c) 1999 The NetBSD Foundation, Inc. All rights reserved.
Copyright (c) 2001 The NetBSD Foundation, Inc. All rights reserved.
Copyright (c) 1996 Gardner Buchanan <gbuchanan@shl.com> All rights reserved.

Parts of the NetBSD Kernel are provided with the licenses that are slightly different from the above Berkeley-formed license. Please refer the source code of the NetBSD Kernel about the details. The source code of the NetBSD Kernel is provided by the NetBSD CVS Repositories (<http://cvsweb.netbsd.org/bsdweb.cgi/>), and this product includes parts of the source code in the following directories.

<http://cvsweb.netbsd.org/bsdweb.cgi/src/sys/kern/>
<http://cvsweb.netbsd.org/bsdweb.cgi/src/sys/net/>
<http://cvsweb.netbsd.org/bsdweb.cgi/src/sys/netinet/>

<<MD5>>

This software uses the Source Code of RSA Data Security, Inc. described in the RFC1321 (MD5 Message-Digest Algorithm).

Copyright (C) 1991-2, RSA Data Security, Inc. Created 1991. All rights reserved.

License to copy and use this software is granted provided that it is identified as the "RSA Data Security, Inc. MD5 Message-Digest Algorithm" in all material mentioning or referencing this software or this function.

License is also granted to make and use derivative works provided that such works are identified as "derived from the RSA Data Security, Inc. MD5 Message-Digest Algorithm" in all material mentioning or referencing the derived work.

RSA Data Security, Inc. makes no representations concerning either the merchantability of this software or the suitability of this software for any particular purpose. It is provided "as is" without express or implied warranty of any kind.

These notices must be retained in any copies of any part of this documentation and/or software.

<<MT19937>>

The MT19937 software that Takuji Nishimura and Makoto Matsumoto developed is contained, and this product shall be used subject to the following license conditions.

Copyright (C) 1997 - 2002, Makoto Matsumoto and Takuji Nishimura, All rights reserved.

Redistribution and use in source and binary forms, with or without modification, are permitted provided that the following conditions are met:

1. Redistributions of source code must retain the above copyright notice, this list of conditions and the following disclaimer.
2. Redistributions in binary form must reproduce the above copyright notice, this list of conditions and the following disclaimer in the documentation and/or other materials provided with the distribution.
3. The names of its contributors may not be used to endorse or promote products derived from this software without specific prior written permission.

THIS SOFTWARE IS PROVIDED BY THE COPYRIGHT HOLDERS AND CONTRIBUTORS "AS IS" AND ANY EXPRESS OR IMPLIED WARRANTIES, INCLUDING, BUT NOT LIMITED TO, THE IMPLIED WARRANTIES OF MERCHANTABILITY AND FITNESS FOR A PARTICULAR PURPOSE ARE DISCLAIMED. IN NO EVENT SHALL THE COPYRIGHT OWNER OR CONTRIBUTORS BE LIABLE FOR ANY DIRECT, INDIRECT, INCIDENTAL, SPECIAL, EXEMPLARY, OR CONSEQUENTIAL DAMAGES (INCLUDING, BUT NOT LIMITED TO, PROCUREMENT OF SUBSTITUTE GOODS OR SERVICES; LOSS OF USE, DATA, OR PROFITS; OR BUSINESS INTERRUPTION) HOWEVER CAUSED AND ON ANY THEORY OF LIABILITY, WHETHER IN CONTRACT, STRICT LIABILITY, OR TORT (INCLUDING NEGLIGENCE OR OTHERWISE) ARISING IN ANY WAY OUT OF THE USE OF THIS SOFTWARE, EVEN IF ADVISED OF THE POSSIBILITY OF SUCH DAMAGE.

<<thttpd>>

The thttpd software that ACME Labs developed is contained, and this product shall be used subject to the following license conditions.

Copyright 1995,1998,1999,2000 by Jef Poskanzer <jef@acme.com>. All rights reserved.

Redistribution and use in source and binary forms, with or without modification, are permitted provided that the following conditions are met:

1. Redistributions of source code must retain the above copyright notice, this list of conditions and the following disclaimer.
2. Redistributions in binary form must reproduce the above copyright notice, this list of conditions and the following disclaimer in the documentation and/or other materials provided with the distribution.

THIS SOFTWARE IS PROVIDED BY THE AUTHOR AND CONTRIBUTORS "AS IS" AND ANY EXPRESS OR IMPLIED WARRANTIES, INCLUDING, BUT NOT LIMITED TO, THE IMPLIED WARRANTIES OF MERCHANTABILITY AND FITNESS FOR A PARTICULAR PURPOSE ARE DISCLAIMED. IN NO EVENT SHALL THE AUTHOR OR CONTRIBUTORS BE LIABLE FOR ANY DIRECT, INDIRECT, INCIDENTAL, SPECIAL, EXEMPLARY, OR CONSEQUENTIAL DAMAGES (INCLUDING, BUT NOT LIMITED TO, PROCUREMENT OF SUBSTITUTE GOODS OR SERVICES; LOSS OF USE, DATA, OR PROFITS; OR BUSINESS INTERRUPTION) HOWEVER CAUSED AND ON ANY THEORY OF LIABILITY, WHETHER IN CONTRACT, STRICT LIABILITY, OR TORT (INCLUDING NEGLIGENCE OR OTHERWISE) ARISING IN ANY WAY OUT OF THE USE OF THIS SOFTWARE, EVEN IF ADVISED OF THE POSSIBILITY OF SUCH DAMAGE.

Index

A

AC adaptor 13
 Connection 60
 Accessories 13
 ACD flexible button 34
 ACD Group 33
 Auto answer 27
 AUTO ANSWER/MUTE button 16
 Automatic Call Distribution → ACD 33

B

Back Light (setting) 41
 BLF flexible button 34
 Busy Lamp Field → BLF 34

C

Call Block (setting) 47
 Call Forwarding 33
 Call Splitting 29
 Call Transfer 30
 Call Waiting 29
 Calls
 From call logs 25
 From phonebook list 25
 Holding 28
 Making 25
 Missed 32
 Receiving 27
 Redialing 26
 Rejecting 27
 CANCEL button 16
 Character entry 48
 Cleaning 71
 CONF (Conference) button 16
 CONFERENCE button 16
 Conference call 31
 Connections 60
 Controls 14
 Bottom view 18
 Front View 14
 Left view 17

D

Date and Time (setting) 43
 DC jack 18
 Default Gateway (setting) 44
 Dialing 25
 Directory Number → DN 34
 Display 15
 Contrast 40
 Display Lock (setting) 41
 DN flexible button 34
 DNS (setting) 44
 DNS1 (setting) 44
 DNS2 (setting) 44
 Do Not Disturb 33

Do Not Disturb (setting) 41

E

ECO Mode (setting) 40
 EHS headsets 61
 EHS jack 17
 Electronic Hook Switch → EHS 61
 Embedded web (setting) 45
 Enable VLAN (setting) 44
 ENTER key 16
 Error messages 76
 Extension number 23

F

Factory Setting (setting) 46
 Firmware version (setting) 46
 FLASH/RECALL button 16
 Flexible buttons 16, 34
 FORWARD/DO NOT DISTURB button 16
 Forwarding 33
 FWD All (setting) 41
 FWD Busy (setting) 41
 FWD No Ans (setting) 42

G

Group, Login/Logout 33

H

Handset 13
 Connections 62
 Hooking 68
 Volume 24
 Handset cord 13
 Handset hook 16
 Handset jack 19
 Hands-free mode 23
 Headset 61
 Flexible button 34
 Using 70
 Volume 24
 HEADSET button 16
 Headset jack 17
 Hold 28
 HOLD button 16

I

Information Display (setting) 43
 Initialize 71
 Installation 57
 IP Address (setting) 44
 IP Phone (setting) 44
 IP Reset (setting) 46

L

LAN connection 60
 LAN port 19
 LAN port (setting) 45
 Language (setting) 42

Last Number Redial 26
 LCD (Liquid Crystal Display) 15
 LCD Contrast (setting) 40
 Local Three-way Conference 31
 Login (to a Group) 33
 Logout (from a Group) 33

M

Maintenance 71
 Making calls 25
 Calling 25
 MESSAGE button 16
 Message/Ringer Lamp 16
 Messages, checking 32
 MIC 16
 Missed calls 32
 MUTE/AUTO ANSWER button 16

N

Navigator key 16
 Network (setting) 44
 Network Test (setting) 45

O

Off-hook monitor 23
 One-touch dialing 26
 One-Touch flexible button 34
 One-touch Transfer 30

P

Page keys 16
 PC (setting) 45
 PC connection 60
 PC port 19
 PC port (setting) 45
 Phonebook list
 Adding 35
 Deleting 36
 Editing 35
 Export 36
 Import 36
 Searching 25, 36
 Priority (setting) 45
 Programming, web user interface 56

R

Receiving calls 27
 Redial 26
 REDIAL button 16
 Rejecting calls 27
 Restart 71
 Restart (setting) 46
 Ring count (setting) 42
 Ringer
 Volume setting 23
 Ringer (setting) 40
 Ringer Volume (setting) 40
 Ringer/Message Lamp 16
 Ringtone (setting) 40

S

Scroll indicator 20
 Search, phonebook list 25
 Settings 37
 Accessing 37
 Setup 57
 Initial settings 70
 Soft buttons 16, 21
 icons 20
 Icons 21
 Speaker
 Volume 24
 Speakerphone (SP-PHONE) button 16
 Specifications 72
 Speed/Duplex (setting) 45
 SP-PHONE (Speakerphone) button 16
 Stand 13
 Adjusting 58
 Attaching 57
 Removing 57
 Start-up menu 70
 Status icons 20
 Subnet mask (setting) 44

T

Three-way conference 31
 Transfer 30
 TRANSFER button 16
 Troubleshooting 74

U

User settings 37

V

VLAN (setting) 44
 VLAN ID (setting) 45
 Volume 23

W

Wall mount kit 13
 Wall mounting 63
 Web user interface programming 56

WALL MOUNTING TEMPLATE

1. Drive the screws into the wall as indicated.
2. Hook the unit onto the screw heads.

Note:

Make sure to set the print size to correspond with the size of this page. If the dimensions of the paper output still deviate slightly from the measurements indicated here, use the measurements indicated here.

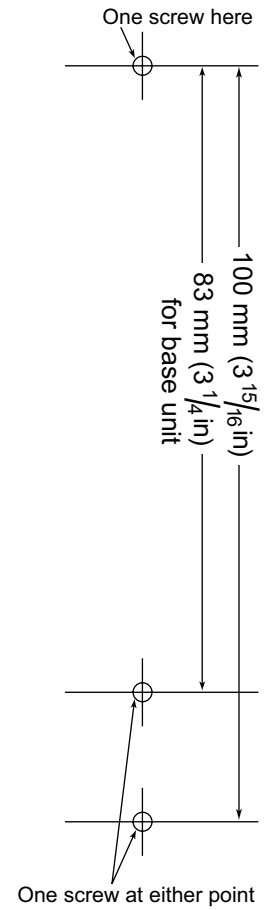

Panasonic Corporation of North America

One Panasonic Way, Secaucus, New Jersey 07094

<http://www.panasonic.com/sip>

Panasonic Canada Inc.

5770 Ambler Drive, Mississauga, Ontario, L4W 2T3

<http://www.panasonic.ca>

Copyright:

This material is copyrighted by Panasonic System Networks Co., Ltd., and may be reproduced for internal use only. All other reproduction, in whole or in part, is prohibited without the written consent of Panasonic System Networks Co., Ltd.

© Panasonic System Networks Co., Ltd. 2011

PNQX3571XA DD0611MK2121 (v0.002)