



Panasonic®

Personal Computer

OPERATING INSTRUCTIONS

Model No. **CF-18 Series**

TOUGHBOOK

2000 XP

Contents

Getting Started

Read Me First	3
First-time Operation	9

Reference Manual

- Read Me First
- Key Combinations
- LED Indicators

Operation

Starting Up/Shutting Down	15
Touch Pad (Basic Operation)	19
Touchscreen (Basic Operation)	20
Operating in Tablet Mode	21
Reference Manual	23

Reference Manual

- Tablet Buttons
- Touch Pad (Advanced)
- Touchscreen (Advanced)
- Software keyboard
- Panasonic Hand Writing
- Display Rotation
- Standby/Hibernation Functions
- Security Measures
- Computing on the Road
- Battery Power
- PC Cards
- RAM Module
- Port Replicator
- External Display
- USB Devices
- Modem
- LAN
- Wireless LAN
- Hard Disk Drive
- Setup Utility

Troubleshooting

List of Error Codes	24
Dealing with Problems (Summary)	25
Reinstalling Software	30

Reference Manual

- Technical Information
- DMI Viewer
- List of Error Codes
- Dealing with Problems (Advanced)

Appendix

LIMITED USE LICENSE AGREEMENT	32
Hard Disk Data Erase Utility	34
Names and Functions of Parts	35
Specifications	39
LIMITED WARRANTY	41

[Additional Manual]

Reference Manual

This manual can be accessed on your computer. Refer to page 23 on how to access the Reference Manual.

Getting Started

Operation

Troubleshooting

Appendix

Customer's Record

Model No.* _____	Dealer's Name _____
Serial No. _____	_____
or	
Code No. _____	Dealer's Address _____
Date of Purchase _____	_____

* For the Model No., insert the 12 digit number (for example, CF-18BHAZXDM) located on the bottom of the computer.

Introduction

Thank you for purchasing the Panasonic computer. Read the operating instructions thoroughly for proper operation of your new computer.

Illustrations and Terminology in this Manual

NOTE:

NOTE provides a useful fact or helpful information.

CAUTION:

CAUTION indicates a condition that may result in minor or moderate injury.

WARNING:

WARNING indicates a hazard that may result in moderate or serious injury.

Windows 2000 :

Information for Microsoft® Windows® 2000 Professional users. “Windows” or “Windows 2000” in this manual.

Windows XP :

Information for Microsoft® Windows® XP Professional users. “Windows” or “Windows XP” in this manual.

Enter :

This illustration means to press the [Enter] key.

Fn + **F5** :

This illustration means to press and hold the [Fn] key, then press the [F5] key.

[Start]-[Run]:

This illustration means to click [Start], then to click [Run].

(For some applications, you may need to double-click.)

 :

Where to go for referred information.

 Reference Manual :

This illustration means to refer to the Reference Manual, which is available on your computer. Refer to page 23 on how to access this manual.

- Windows 2000 screens are used in this manual when no specific OS (operating system) notes are required.
- Some of the illustrations in this manual may differ slightly in shape from the actual items in order to make the explanation easier to understand.
- In this manual, descriptions are given using illustrations not featuring the hand strap for convenience of explanation.
- If the user has logged on without administrator authority, some functions may not be executable, and some screens may be not displayed as shown in this manual. If this happens, log on with Administrator authority to enable these functions.
- Confirm the latest information on optional products in catalogs, etc.

Copyright

This manual is copyrighted by Matsushita Electric Industrial Co., Ltd. with all rights reserved. No part of this manual may be reproduced in any form without the prior written permission of Matsushita Electric Industrial Co., Ltd.

No patent liability is assumed with respect to the use of the information contained herein.

©2003 Matsushita Electric Industrial Co., Ltd. All Rights Reserved.

Disclaimer

Computer specifications and manuals are subject to change without notice. Matsushita Electric Industrial Co., Ltd. assumes no liability for damage incurred directly or indirectly from errors, omissions or discrepancies between the computer and the manuals.

Trademarks

Microsoft® and Windows® are registered trademarks of Microsoft Corporation of the United States and/or other countries.

Intel, Pentium, PROSet and SpeedStep™ are either registered trademarks or trademarks of Intel Corporation.

Adobe® and Acrobat® are either registered trademarks or trademarks of Adobe Systems Incorporated in the United States and/or other countries.

Panasonic is a registered trademark of Matsushita Electric Industrial Co., Ltd.

Names of products, brands, etc., appearing in this manual are trademarks or registered trademarks of their respective owner companies.

Read Me First

For U.S.A.

Federal Communications Commission Radio Frequency Interference Statement

Note: This equipment has been tested and found to comply with the limits for a Class B digital device, pursuant to Part 15 of the FCC Rules. These limits are designed to provide reasonable protection against harmful interference in a residential installation. This equipment generates, uses and can radiate radio frequency energy and, if not installed and used in accordance with the instructions, may cause harmful interference to radio communications. However, there is no guarantee that interference will not occur in a particular installation. If this equipment does cause harmful interference to radio or television reception, which can be determined by turning the equipment off and on, the user is encouraged to try to correct the interference by one or more of the following measures:

- Reorient or relocate the receiving antenna.
- Increase the separation between the equipment and receiver.
- Connect the equipment into an outlet on a circuit different from that to which the receiver is connected.
- Consult the Panasonic Service Center or an experienced radio/TV technician for help.

Warning

To assure continued compliance, use only shielded interface cables when connecting to a computer or peripheral. Also, any changes or modifications not expressly approved by the party responsible for compliance could void the user's authority to operate this equipment.

FCC RF Exposure Warning:

This computer is provided with PC Card slots that could be used with wireless transmitter(s), which will be specifically recommended, when they become available. Other third-party wireless transmitter(s) have not been RF exposure evaluated for use with this computer and may not comply with FCC RF exposure requirements.

This equipment complies with FCC radiation exposure limits set forth for an uncontrolled environment.

This equipment must be installed and operated in accordance with provided instructions and minimum 2.5 cm spacing must be provided between antenna and all person's body (excluding extremities of hands, wrist and feet) during wireless modes of operation.

This transmitter must not be co-located or operated in conjunction with any other antenna or transmitter.

This device complies with Part 15 of the FCC Rules. Operation is subject to the following two conditions:

- (1) This device may not cause harmful interference, and
- (2) This device must accept any interference received, including interference that may cause undesired operation.

Responsible Party: Matsushita Electric Corporation of America
One Panasonic Way
Secaucus, NJ 07094
Tel No:1-800-LAPTOP-5 (1-800-527-8675)

FCC Regulation Notice for modem

This equipment contains a FCC approved modem.

Manufacturer of modem: AMBIT Microsystems Corporation
Model No. T60M283.** (** = numbers or alphabet letters)

Tested To Comply With FCC Standards FOR HOME OR OFFICE USE

1. This equipment complies with CFR47 Part 68 rules. On the computer is a label that contains, among other information, the FCC registration number and ringer equivalence number (REN) for this equipment. If required, this information must be provided to the telephone company.
2. An FCC compliant telephone cord and modular plug is provided with this equipment. This equipment is designed to be connected to the telephone network or premises wiring using a compatible modular jack which is Part 68 compliant. See Installation Instructions for details.
3. The REN is used to determine the quantity of devices which may be connected to the telephone line. Excessive RENs on the telephone line may result in the devices not ringing in response to an incoming call. In most, but not all area, the sum of RENs should not exceed five (5.0). To be certain of the number of devices that may be connected to a line, as determined by the total RENs, contact the local telephone company.
4. If your telephone equipment cause harm to the telephone network, the telephone company will notify you in advance that temporary discontinuance of service may be required. But if advance notice isn't practical, the telephone company will notify the customer as soon as possible. Also, you will be advised of your right to file a complaint with the FCC if you believe it is necessary.
5. The telephone company may take changes in its facilities, equipment, operations or procedures that could affect the operation of the equipment. If this happens the telephone company will provide advance notice in order for you to make necessary modifications to maintain uninterrupted service.
6. If trouble is experienced with this equipment, for repair or warranty information, please contact Matsushita Electric Corporation of America at DIAL TOLL FREE 1-800-LAPTOP5 (1-800-527-8675). If the equipment is causing harm to the telephone network, the telephone company may request that you disconnect the equipment until the problem is resolved.
7. There are no user serviceable parts contained in this equipment.
8. This equipment may not be used on coin service provided by the telephone company. Connection to party lines is subject to state tariffs.
9. The Telephone Consumer Protection Act of 1991 makes it unlawful for any person to use a computer or other electronic device to send any message via a telephone fax machine unless such message clearly contains in a margin at the top or bottom of each transmitted page or on the first page of the transmission, the date and time it is sent and an identification of the business or other entry, or other individual sending the message and the telephone number of the sending machine or such business, other entity, or individual. In order to program this information into your fax software, you should refer to the manual of the Fax software being used.

Read Me First

10. According to the FCC's electrical safety advisory, we recommend that you may install an AC surge arrester in the AC outlet to which this equipment is connected. Telephone companies report that electrical surges, typically lightning transients, are very destructive to customer terminal equipment connected to AC power sources and that this is a major nationwide problem.

“Caution: To reduce the risk of fire, use only No.26 AWG or larger telecommunication line cord.”

“ATTENTION: Pour réduire le risque d'incendie, utiliser uniquement des conducteurs de télécommunications 26 AWG ou de section supérieure.”

Notice for the products using LCD

This product uses one or more fluorescent lamps containing a small amount of mercury. It also contains lead in some components. Disposal of these materials may be regulated in your community due to environmental considerations. For disposal or recycling information please contact your local authorities, or the Electronics Industries Alliance: <<http://www.eiae.org/>>

For Canada

Industry Canada (IC) Notice for modem

This equipment contains an Industry Canada approved modem unit. The Industry Canada label is affixed on the modem unit.

EQUIPMENT ATTACHMENT LIMITATIONS

“NOTICE: The Industry Canada label identifies certified equipment. This certification means that the equipment meets telecommunications network protective, operational and safety requirements as prescribed in the appropriate Terminal Equipment Technical Requirements document(s). The Department does not guarantee the equipment will operate to the user's satisfaction.

Before installing this equipment, users should ensure that it is permissible to be connected to the facilities of the local telecommunications company. The equipment must also be installed using an acceptable method of connection. The customer should be aware that compliance with the above conditions may not prevent degradation of service in some situations.

Repairs to certified equipment should be coordinated by a representative designated by the supplier. Any repairs or alterations made by the user to this equipment, or equipment malfunctions, may give the telecommunications company cause to request the user to disconnect the equipment.

Users should ensure for their own protection that the electrical ground connections of the power utility, telephone lines and internal metallic water pipe system, if present, are connected together. This precaution may be particularly important in rural areas. Caution: Users should not attempt to make such connections themselves, but should contact the appropriate electric inspection authority, or electrician, as appropriate.”

“NOTICE: The Ringer Equivalence Number (REN) assigned to each terminal device provides an indication of the maximum number of terminals allowed to be connected to a telephone interface. The termination on an interface may consist of any combination of devices subject only to the requirement that the sum of the Ringer Equivalence Numbers of all the devices does not exceed 5.”

REN: See bottom of the computer

Industry Canada

This product complies with RSS210 Industry Canada.

Operation is subject to the following two conditions;

- (1) this device may not cause interference, and
- (2) this device must accept any interference, including interference that may cause undesired operation of the device.

RESTRICTIONS CONCERNANT LE RACCORDEMENT DE MATÉRIEL

“AVIS: L'étiquette d'Industrie Canada identifie le matériel homologué. Cette étiquette certifie que le matériel est conforme aux normes de protection, d'exploitation et de sécurité des réseaux de télécommunications, comme le prescrivent les documents concernant les exigences techniques relatives au matériel terminal. Le Ministère n'assure toutefois pas que le matériel fonctionnera à la satisfaction de l'utilisateur.

Avant d'installer ce matériel, l'utilisateur doit s'assurer qu'il est permis de le raccorder aux installations de l'entreprise locale de télécommunication. Le matériel doit également être installé en suivant une méthode acceptée de raccordement. L'abonné ne doit pas oublier qu'il est possible que la conformité aux conditions énoncées ci-dessus n'empêche pas la dégradation du service dans certaines situations.

Les réparations de matériel homologué doivent être coordonnées par un représentant désigné par le fournisseur. L'entreprise de télécommunications peut demander à l'utilisateur de débrancher un appareil à la suite de réparations ou de modifications effectuées par l'utilisateur ou à cause de mauvais fonctionnement.

Pour sa propre protection, l'utilisateur doit s'assurer que tous les fils de mise à la terre de la source d'énergie électrique, des lignes téléphoniques et des canalisations d'eau métalliques, s'il y en a, sont raccordés ensemble. Cette précaution est particulièrement importante dans les régions rurales. Avertissement: L'utilisateur ne doit pas tenter de faire ces raccordements lui-même; il doit avoir recours à un service d'inspection des installations électriques, ou à un électricien, selon le cas.”

“AVIS: L'indice d'équivalence de la sonnerie (IES) assigné à chaque dispositif terminal indique le nombre maximal de terminaux qui peuvent être raccordés à une interface. La terminaison d'une interface téléphonique peut consister en une combinaison de quelques dispositifs, à la seule condition que la somme d'indices d'équivalence de la sonnerie de tous les dispositifs n'excède pas 5.”

IES: Voir sous le fond de l'ordinateur

Important Safety Instructions / Importantes Mesures De Sécurité

When using your telephone equipment, basic safety precautions should always be followed to reduce the risk of fire, electric shock and injury to persons, including the following:

1. Do not use this product near water, for example, near a bath tub, wash bowl, kitchen sink or laundry tub, in a wet basement or near a swimming pool.
2. Avoid using a telephone (other than a cordless type) during an electrical storm. There may be a remote risk of electric shock from lightning.
3. Do not use the telephone to report a gas leak in the vicinity of the leak.
4. Use only the power cord and batteries indicated in this manual. Do not dispose of batteries in a fire. They may explode. Check with local codes for possible special disposal instructions.

SAVE THESE INSTRUCTIONS

Precautions

The CF-18 was developed based on thorough research into the real-world portable computing environments. Exhaustive pursuit of usability and reliability under harsh conditions led to innovations such as the magnesium alloy exterior, vibration damped hard disk drive and floppy disk drive, flexible internal connections. The CF-18's outstanding engineering has been tested using the stiff MIL-STD- 810F (for vibration and shock) and IP (for dust and water) based procedures.

As with any portable computer device precautions should be taken to avoid any damage. The following usage and handling procedures are recommended.

Before putting the computer away, be sure to wipe off any moisture.

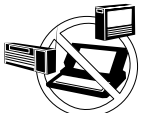

Avoid Radio Frequency Interference

Do not place the computer near a television or radio receiver.



Avoid Magnetic Fields

Keep the computer away from magnets. Data stored on the hard disk may be lost.



Keep Small Objects Away

Do not insert paper clips or other small objects into the computer.



Do Not Disassemble the Computer

Do not attempt to disassemble your computer.



Avoid Excessive Force on the Display

Do not apply excessive downward force on the display when it is completely opened, especially when plugs and/or cables are connected to the rear of the computer.



Avoid low-temperature burns

Avoid more than casual contact with any heat producing area of the notebook computer, power adaptor, and any option or accessory you use with it. Even low heat, if warmer than body temperature, can cause a burn, if the skin is exposed to the heat source for a long enough period of time.

Certaines mesures de sécurité doivent être prises pendant l'utilisation de matériel téléphonique afin de réduire les risques d'incendie, de choc électrique et de blessures. En voici quelquesunes:

1. Ne pas utiliser l'appareil près de l'eau, p.ex., près d'une baignoire, d'un lavabo, d'un évier de cuisine, d'un bac à laver, dans un sous-sol humide ou près d'une piscine.
2. Éviter d'utiliser le téléphone (sauf s'il s'agit d'un appareil sans fil) pendant un orage électrique. Ceci peut présenter un risque de choc électrique causé par la foudre.
3. Ne pas utiliser l'appareil téléphonique pour signaler une fuite de gaz s'il est situé près de la fuite.
4. Utiliser seulement le cordon d'alimentation et le type de piles indiqués dans ce manuel. Ne pas jeter les piles dans le feu: elles peuvent exploser. Se conformer aux règlements pertinents quant à l'élimination des piles.

CONSERVER CES INSTRUCTIONS

Information to the User

This product and your Health

This product, like other radio devices, emits radio frequency electromagnetic energy. The level of energy emitted by this product however is far much less than the electromagnetic energy emitted by wireless devices like for example mobile phones. Because this product operates within the guidelines found in radio frequency safety standards and recommendations, we believe this product is safe for use by consumers. These standards and recommendations reflect the consensus of the scientific community and result from deliberations of panels and committees of scientists who continually review and interpret the extensive research literature.

In some situations or environments, the use of this product may be restricted by the proprietor of the building or responsible representatives of the organization. These situations may for example include:

- Using this product on board of airplanes, or
- In any other environment where the risk of interference to other devices or services is perceived or identified as harmful.

If you are uncertain of the policy that applies on the use of wireless devices in a specific organization or environment (e.g. airports), you are encouraged to ask for authorization to use this product prior to turning on the product.

Regulatory Information

We are not responsible for any radio or television interference caused by unauthorized modification of this product. The correction of interference caused by such unauthorized modification will be the responsibility of the user. We and its authorized resellers or distributors are not liable for damage or violation of government regulations that may arise from failing to comply with these guidelines.

Read Me First

Lithium Battery

Lithium Battery!

This computer contains a lithium battery to enable the date, time, and other data to be stored. The battery should only be exchanged by authorized service personnel.









Warning! A risk of explosion from incorrect installation or misapplication may possibly occur.

Pile au lithium!



Le micro-ordinateur renferme une pile au lithium qui permet de sauvegarder certaines données comme la date et l'heure notamment. Elle ne devra être remplacée que par un technicien qualifié.

Avertissement! Risque d'explosion en cas de non respect de cette mise en garde!

Precautions (Battery Pack)

- Care should be exercised with regard to the following in order to avoid the possibility of overheating, fire or damage.
 - **Avoid Heat**
Do not throw the battery pack into a fire or expose it to excessive heat.
 - **Keep Articles Away**
Do not place the battery pack together with articles such as necklaces or hairpins when carrying or storing.
 - **Do Not Disassemble**
Do not insert sharp objects into the battery pack, expose it to bumps or shocks, deform, disassemble, or modify it.
 - **Do Not Short**
Do not short the positive (+) and negative (-) contacts.
 - **Avoid Extreme Heat, Cold and Direct Sunlight**
Do not charge, use or leave the battery pack for extended periods where it will be exposed to direct sunlight, in a hot place (in car on a sunny day, for example), or in a cold place.
 - **Do Not Use With Any Other Computer**
The battery pack is rechargeable and was intended for the specified computer or charger. Do not use it with a computer other than the one for which it was designed.
 - **Do Not Put into a Microwave**
Do not put the battery pack into a microwave oven or a pressurized chamber.
 - **Stop Using**
Should the battery emit an abnormal odor, become hot to the touch, become discolored, change shape, or become in any way different from normal, remove it from the computer or charger and stop using it.
- Do not touch the terminals on the battery pack. The battery pack may no longer function properly if the contacts are dirty or damaged.
- Do not expose the battery pack to water, or allow it to become wet.
- If the battery pack will not be used for a long period of time (a month or more), charge or discharge (use) the battery pack until the remaining battery level becomes 30% to 40% and store it in a cool, dry place.
- This computer prevents overcharging of the battery by recharging only when the remaining power is less than approx. 95% of capacity.
- The battery pack is not charged when the computer is first purchased. Be sure to charge it before using it for the first time. When the AC adaptor is connected to the computer, charging begins automatically.
- Should the battery leak and the fluid get into your eyes, do not rub your eyes. Immediately flush your eyes with clear water and see a doctor for medical treatment as soon as possible.

NOTE

- The battery pack may become warm during recharging or normal use. This is completely normal.
- Recharging will not commence if internal temperature of the battery pack is outside of the allowable temperature range (0 °C to 50 °C {32°F to 122 °F})  Reference Manual "Battery Power". Once the allowable range requirement is satisfied, charging begins automatically. Note that the recharging time varies based on the usage conditions. (Recharging takes longer than usual when the temperature is 10 °C {50 °F} or less.)
- If the temperature is low, the operating time is shortened. Only use the computer within the allowable temperature range.
- This computer has a high temperature mode function that prevents the degradation of the battery in high temperature environments.  Reference Manual "Battery Power") If the high temperature mode is enabled in the Setup Utility  Reference Manual "Setup Utility", a level of 100% in the [High Temperature] mode is about a level of 80% in the [Normal Temperature] mode.
- The battery pack is a consumable item. If the amount of time the computer can be run off a particular battery pack becomes dramatically shorter and repeated rechargings do not restore its performance, the battery pack should be replaced with a new one.
- When transporting a spare battery inside a package, briefcase, etc., it is recommended that it be placed in a plastic bag so that its contacts are protected.
- Always power off the computer when it is not in use. Leaving the computer on when the AC adaptor is not connected will exhaust the remaining battery capacity.

When Using Peripheral Devices

Pay strict attention to the following points to avoid damage to the computer, peripheral devices, cables, etc. Also, in addition to following this manual and the Reference Manual, carefully read the operating instructions for the peripheral devices being used.

- Use only peripheral devices that conform to the computer's specifications.
- Connect the devices properly, paying close attention to the condition and position of the connectors.
- If a connection cannot be made easily, do not apply undue force; check once more to confirm the condition and position of the connector (alignment of pins, etc.) .
- If the connector has holding screws, fasten the screws firmly.
- Do not carry the computer with cables attached, and do not pull on the cables forcefully.

Saving Data on the Hard Disk

- **Do not expose your computer to shock.**
Use care when handling your computer, shock may damage your hard disk or make your software applications and data unusable.
- **Do not power down your computer while software applications are running or hard disk drive indicator (LED) is on.**
Properly shut Windows down to avoid problems.
- **Save all valuable data to disks.**
Backing up data to disks will limit damage should trouble occur to your computer or should you inadvertently change or erase data.
- **Use the security function for all important data.** (Reference Manual "Security Measures")

Hard Disk Lock

When the Hard Disk Lock is set to [Enable], it is impossible to read/write data from/to the hard disk when the hard disk is installed in a different computer, since a password is also set for the hard disk. When the hard disk is returned to the original computer, you can read/write data as before. In this case, however, make the settings in the Setup Utility exactly the same as they were before the hard disk was removed. (Note that this Hard Disk Lock does not guarantee the complete protection of data.) (Reference Manual "Security Measures")

Computer Viruses

Users are advised to purchase the latest versions of virus protection software and use them regularly.

We recommend you run the software:

- When booting your computer.
- After receiving data.

We recommend that you check data received on disks or from external sources, such as data downloaded from the Internet, e-mail, etc. (For compressed files, uncompress them before running a check).

When Disposing of or Transferring Ownership of This Device

When disposing of or transferring ownership of this device, completely erase all data on the hard disk in order to prevent the theft of hard disk data. Even if you delete data or initialize the hard disk through normal Windows commands, data can still be read using special software. In order to erase all data, either have the data erased by a specialist (at a charge) or use the hard disk data erase utility (included) (page 34). (Note that this hard disk data erase utility does not guarantee that data will be completely erased.)

Also note that transferring ownership of this device without deleting software from the hard disk may violate software user's licenses.

Usage Environment

● Environment

- In use: Temperature: 5 °C to 35 °C {41 °F to 95 °F}
Humidity: 30% to 80% RH (No condensation)
- Not in use: Temperature: -20 °C to 60 °C {-4 °F to 140 °F}
Humidity: 30% to 90% RH (No condensation)

(To next page)

NOTE

Only use the computer within the allowable temperature range. When the computer is left powered on in a low temperature environment, set [Turn off hard disks] to [Never] in the following menu to avoid damage to the hard disk drive.

Windows 2000

[Start] - [Settings] - [Control Panel] - [Power Options] - [Power Schemes]

Windows XP

[Start] - [Control Panel] - [Performance and Maintenance] - [Power Options] - [Power Schemes]

● Places not to use your computer

- Such areas may result in damage to the computer.

Areas with electronic equipment

These areas may interfere with your display or cause your computer to produce strange sounds.

Areas with extremely high/low temperatures

- Do not leave things near the computer that are sensitive to heat. During operation, the computer may become warm.

Handling

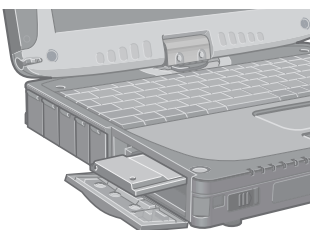

- This computer has been designed so as to minimize shock to the LCD and hard disk drive, etc., but no warranty is provided against such trouble. Therefore, as a precision instrument, be extremely careful in the handling.
- Do not drop or hit your computer against solid objects.
- Do not carry your computer when it is on.
- Remove all external devices and cables, and PC Cards sticking out of the computer (see the figure on the left) before transporting the computer.
- We recommend preparing a fully charged battery. When transporting spare batteries inside a package, briefcase, etc., it is recommended that it be placed in a plastic bag so that its contacts are protected.
- Do not place the computer upright or allow it to tip over. When the computer receives extremely strong shock after falling, the hard disk or floppy disk drive, etc., may become inoperable.
- Do not carry the computer while the display is open, or carry it by gripping the display.
- Do not put anything (e.g., a piece of paper) between the display and keyboard.
- Always carry your computer with you. Never check it in with luggage. For use of the computer inside an aircraft, we recommend asking the airlines regarding their policy on this issue.
- It is a good idea to make backup copies on disks and carry them with you.

Maintenance

Touch Pad
☞ page 19

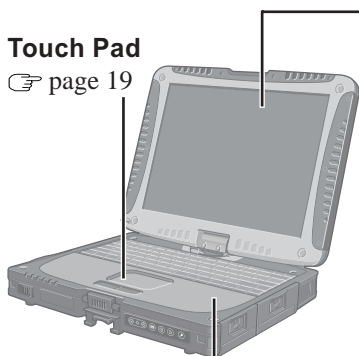

Display

Use the Soft Cloth included with the computer. (For more information, refer to “Suggestions About Cleaning the LCD Surface” that comes with the Soft Cloth.)

If the Protective Film becomes dirty or damaged, it may be time to replace your Protective Film. The Protective Film is a disposable item. To find out the model number of your Protective Film, contact Panasonic Technical Support. (For more information, refer to the “Operating Instructions” that come with the Protective Film.)

CAUTION

Do not touch the screen before you re-attach a Protective Film, as you may leave a mark or a scratch on the screen.

Areas excluding the display

Wipe these areas with a soft cloth, after applying water or detergent diluted with water to the soft cloth and firmly wringing out excess water.

CAUTION





- Do not use benzene, thinner, or rubbing alcohol. Doing so may adversely affect the surface, e.g., discoloration. In addition, do not use commercially-available household cleaners and cosmetics, as they may contain components harmful to the surface.
- Do not directly add or spray water or detergent. If liquid enters the inside of the computer, it may cause it to work improperly or be damaged.

First-time Operation

Read the steps below to help you learn what parts are included, and to gain an understanding of some basic computer-related operations.

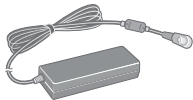
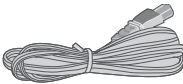
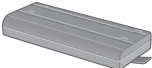
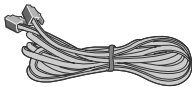
1 Confirm the inclusion of all parts.

Make sure the parts shown in the figure have been supplied. If any of these items are missing or are not working properly, contact Panasonic Technical Support.

AC adaptor 1  Model No : CF-AA1623A	AC Cord 1 	Battery Pack 1  Model No : CF-VZSU30
Modem Telephone Cable 1 	Soft Cloth 1 	Stylus 1  <small>(☞ Reference "Touchscreen(Advanced)")</small>
Tether 1  <small>(☞ page 38)</small>	Shoulder Strap 1  <small>(☞ page 36)</small>	Operating Instructions (This book) 1 Windows® Book 1 Product Recovery CD-ROM Windows 2000 2 Windows XP 3

2 Read the LIMITED USE LICENSE AGREEMENT. (☞ page 32)

Before removing the seal covering the power switch, read the LIMITED USE LICENSE AGREEMENT.

3 Insert the battery pack.

- ① Unlock the cover by sliding the latch to the right.
- ② Slide the latch down, and then without releasing it, open the cover as illustrated.
- ③ Slide the battery pack inward until it is firmly in place.

CAUTION

- Do not touch the terminals on the battery pack and the computer. The battery pack may no longer function properly if the contacts are dirty or damaged. Also, the computer may not operate properly.
- Be sure to insert the battery pack as illustrated.

- ④ Close the cover, then lock it by sliding the latch to the left.

CAUTION

- Confirm that the latch lock is correctly in place. If you carry your computer without the latch lock in place, the battery pack may fall out.
- Before using the battery pack, carefully read "Precautions (Battery Pack)" (☞ page 6).

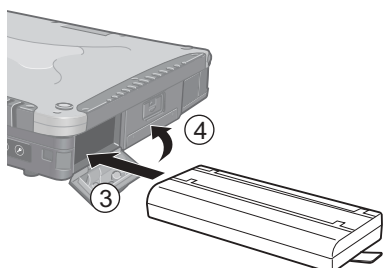
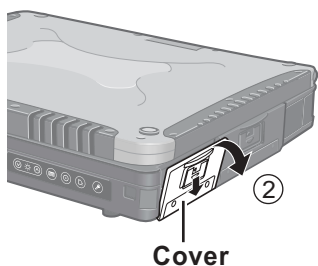
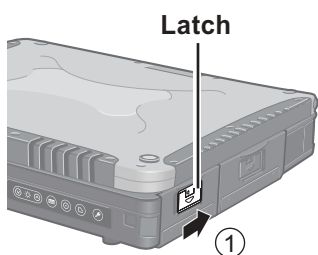

First-time Operation

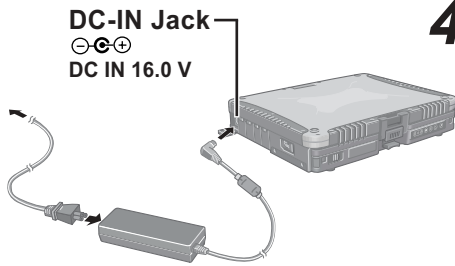

4 Connect your computer to a power outlet.

CAUTION

- Be sure the AC adaptor is connected until completing the first-time use operation.
- When using the computer for the first time, do not connect any peripheral device except the battery pack and AC adaptor to the computer.

Handling the AC adaptor

- Do not twist or pull the AC power cord forcefully. Doing so may damage the connections.
- Use only the specified AC adaptor with your computer. Using an AC adaptor other than the one supplied might damage the battery and/or the computer.
- When the DC plug is not connected to the computer, disconnect the AC cord from your AC wall outlet.
- Problems such as sudden voltage drops may arise during periods of thunder and lightning. Since this could adversely affect your computer, an uninterruptible power source (UPS) is highly recommended unless running from the battery pack alone.

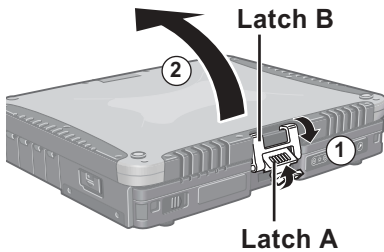

5 Open the display.

- ① Pull up on the latch A and release the latch B.
- ② Lift open the display.

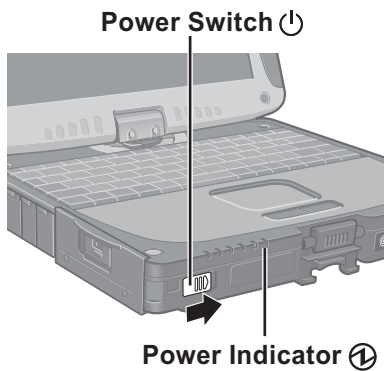

6 Turn your computer on.

Slide the power switch and hold it for approximately one second until the power indicator turns on before releasing it.

CAUTION

- Do not slide the power switch and hold it for more than four seconds; this will cause the power to be turned off forcibly.
- Do not slide the power switch repeatedly.
- Once the computer is powered off, you must wait at least ten seconds before powering it on again.

7 Setup Windows.

Moving the cursor (⏶) or clicking buttons can be performed with the touch pad (☞ page 19).

Windows 2000

CAUTION

- Do not press any keys or touch the touch pad until [Windows 2000 Professional Setup] is displayed.
- Do not use the touchscreen during the Windows setup.

- ① At [Welcome to the Windows 2000 Setup Wizard], select [Next].
- ② After reading the agreement, select [I accept this agreement] or [I don't accept this agreement], then select [Next].

NOTE

If [I don't accept this agreement] is selected, the Windows setup will be aborted.

- ③ Select settings for your region, then select [Next].
- ④ Enter your name and organization and then select [Next].
- ⑤ Enter your computer name and administrator password and then select [Next].

CAUTION

Remember this password! If the password is forgotten, Windows cannot be operated.

- ⑥ Enter the correct date, time and time zone, then select [Next].
- ⑦ At [Networking Settings], select [Typical settings], then select [Next].
- ⑧ At [Workgroup or Computer Domain], select [No, this computer is not on a network, or is on a network without a domain], then select [Next].
The computer will restart.
- ⑨ At [Welcome to the Network Identification Wizard], select [Next].
- ⑩ At [Users of This Computer], select [Users must enter a user name and password to use this computer], then select [Next].
- ⑪ Select [Finish].
- ⑫ Enter your administrator password and select [OK].

Windows XP**CAUTION**

- Do not press any keys or touch the touch pad until [Windows XP Professional Setup] is displayed.
- Do not use the touchscreen during the Windows setup.

- ① At [Welcome to the Windows XP Setup Wizard], select [Next].
- ② After reading the agreement, select [I accept this agreement] or [I don't accept this agreement], then select [Next].

NOTE

If [I don't accept this agreement] is selected, the Windows setup will be aborted.

- ③ Select settings for your region, then select [Next].
- ④ Enter your name and organization and then select [Next].
- ⑤ Enter your computer name and administrator password and then select [Next].

CAUTION

Remember this password! If the password is forgotten, Windows cannot be operated.

- ⑥ Enter the correct date, time and time zone, then select [Next].

NOTE

It may take two to three minutes until the next screen is displayed. Wait, and do not press any keys, or touch the touch pad, etc.

- ⑦ At [Networking Settings], select [Typical settings], then select [Next].
- ⑧ At [Workgroup or Computer Domain], select [No, this computer is not on a network, or is on a network without a domain], then select [Next].
The computer will restart.

NOTE

If “Yes, make this computer a member of the following domain” is selected, the following message may be displayed: [An invalid domain was specified. Would you like to proceed for now and try joining a domain later?]. In this case, select [Yes]. After selecting [Yes], the computer will restart automatically, but sometimes the [Starting Windows] message will remain on the screen, and windows will not start up. If this happens, hold **Tab** down while pressing **Alt** until [Network Identification Wizard] is displayed on top, and follow the instructions on the screen.

- 9 Enter your administrator password and select .

NOTE

If [Windows XP is currently configured to manage the Intel(R) PRO/Wireless LAN adaptor.] is displayed, select [Yes].

8 Calibrate the touchscreen.

Windows 2000

- 1 Select [Start] - [Settings] - [Control Panel] - [Mouse] - [TouchScreen] - [Calibration].
- 2 Touch the “+” mark on the calibration screen with the stylus (included) for about one second.
- 3 After the calibration procedure is executed (e.g., after the nine “+” marks are touched), the procedure ends when **Enter** is pressed.
- 4 Select [OK].

Windows XP

- 1 Select [Start] - [Control Panel] - [Printers and Other Hardware] - [Mouse] - [TouchScreen] - [Calibration].
- 2 Touch the “+” mark on the calibration screen with the stylus (included) for about one second.
- 3 After the calibration procedure is executed (e.g., after the nine “+” marks are touched), the procedure ends when **Enter** is pressed.
- 4 Select [OK].

9

Windows XP

Create a new account.

- 1 Select [Start] - [Control Panel] - [User Accounts] - [Create a new account].
- 2 Enter a name for the new account, then select [Next].
- 3 Select [Computer administrator], then select [Create Account].
- 4 <When you want to create a password for the new account>
Select the new account you have created and select [Create a password].
Follow the instructions on the screen to create a password.
- 5 Select [Start] - [Turn Off Computer] - [Restart] to restart the computer.

CAUTION

Remember this password! If the password is forgotten, Windows cannot be operated. You can create a password reset disk beforehand ( page 14).

NOTE● **When creating a new user account:**

- If you make mail settings, create password reset disks (☞ page 14), or conduct other related operations before creating the user account, you will be unable to use any previous mail history or settings.
- When you create the first new account, you can only select [Computer administrator].

Once a “Computer Administrator” account has been created, you can create additional limited user accounts.

Note also that only the added user account will be displayed in the Welcome screen. The account for the administrator created during Windows setup will not be displayed.

- If you use the wireless LAN, be sure to refer to the Reference Manual’s “Wireless LAN”.

Create BACKUP Disks for Reinstallation

To create backup disks, the USB floppy disk drive (optional: CF-VFDU03) and formatted 2HD floppy disks are needed.

- ① Connect the USB floppy disk drive to your computer.

NOTE

The floppy disk drive must be the A drive.

- ② Prepare 2HD floppy disks and make sure they are not in the write-protected state, and then set it.

③ **Windows 2000**

Select [Start] - [Programs] - [Panasonic] - [Create Backup Disk] and follow the on-screen instructions.

Windows XP

Select [Start] - [All Programs] - [Panasonic] - [Create Backup Disk] and follow the on-screen instructions.

- ④ Place a label identifying the contents on each disk.

● **Name of created backup disk**

FIRSTAID FD (When the display for creating the UPDATE FD is shown, create the disk by following the on-screen instructions.)

CAUTION

- Store the floppy disks in a safe place. They will enable you to return your computer to the condition at the time of purchase should any problems occur.
- When creating backup disks, do not run any other application program.
- When creating backup disks and the message [Insufficient files to copy] is displayed, select [OK] and then contact Panasonic Technical Support.
- While the floppy disk drive indicator is on, do not remove the floppy disk, power off the computer or use the standby or hibernation function (☞ Reference Manual “Standby/Hibernation Functions”).
- Be sure to create the backup disk.
If a backup disk is not created, it will be impossible to return the computer to its original state. In this case, contact Panasonic Technical Support.

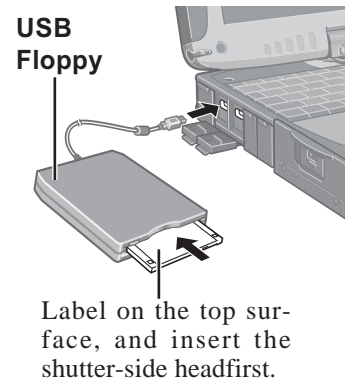

This concludes the first-time use operation guidelines.

Information for Windows XP

- Depending on the Windows settings, installed applications, and drivers, menus and other displays may differ, or some functions (such as use of the password reset disk) may be inoperable.
- You can select Classic view for the Control Panel or select the Classic Start menu. You can also change the way a user logs on or off. The procedure in this manual uses the method of the Windows XP default setting (not Classic Start menu etc.).
- **Resetting the password**
Windows XP has a function to reset a forgotten password. To use this function, you need to create a password reset disk beforehand following the steps below.
 - 1** Connect the USB floppy disk drive (optional: CF-VFDU03) to your computer.
 - 2** Select [Start] - [Control Panel] - [User Accounts] and select the account you used to logon.
 - 3** Select [Prevent a forgotten password] from the [Related Tasks] menu of the account you have logged on to and create a password reset disk following the on-screen instructions.
Store the password reset disk in a safe place.
 - Only the logon password for each account can be reset.
The password set in the Setup Utility cannot be reset.

Starting Up/Shutting Down

Starting Up

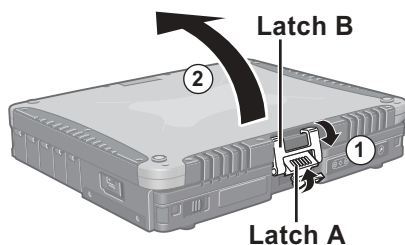

1 Open the display.

- ① Pull up on the latch A and release the latch B.
- ② Lift open the display.

2 Turn your computer on.

Slide the power switch and hold it for approximately one second until the power indicator turns on before releasing it.

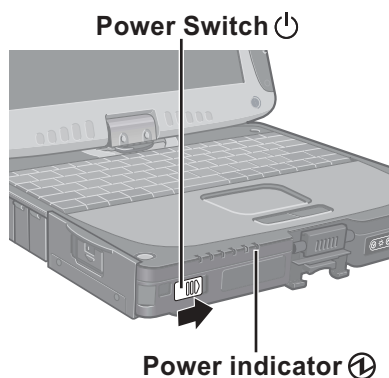

CAUTION

- While booting, avoid the following until the hard disk drive indicator () has turned off.
 - Connecting or disconnecting the AC adaptor.
 - Touching the power switch or the tablet buttons.
 - Performing any keyboard, touch pad, touchscreen (or external mouse) operations.
 - Closing the display.
- Once the computer is powered off, you must wait at least ten seconds before powering it on again.
- When using this computer with the battery pack only, it may take some time for the power to turn on after sliding the power switch. In this case, slide the power switch and hold it for more than one second. This phenomenon occurs because the standby power is minimized while the power is turned off; it is not a malfunction.
- When the CPU temperature rises, the computer may not power on to prevent the CPU from overheating. Should this happen, allow the computer to cool down then switch the power on again.

If the computer still does not power on, contact Panasonic Technical Support.

NOTE

When the power is turned on, sometimes the message “Warming up the system” is displayed or the battery indicator alternately blinks green and orange, and start-up takes longer than usual (a few minutes or more). This function is designed to prevent hard disk drive malfunctions that may occur at low temperatures. Wait for the computer to start up.

Starting Up/Shutting Down

● If [Enter Password] is displayed,

Enter your password*1 and press **Enter**. (Reference Manual “Security Measures”)

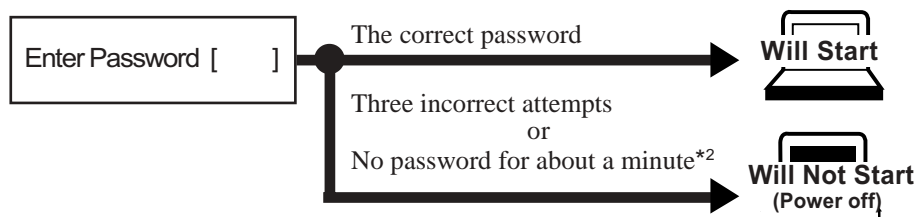

*1 Supervisor Password or User Password set in the Setup Utility (not the Windows password).

*2 Even if no password is entered for about a minute when starting up the Setup Utility, the power will not be turned off.

● When an application or file that was previously displayed appears on your screen,

the standby or hibernation mode has been set. (Reference Manual “Standby/Hibernation Functions”)

3 Log on to Windows.

Windows 2000

After confirming that the hard disk drive indicator (Ⓜ) has turned off, input the user name and password, then select [OK]. Until the correct user name and password are entered, the computer will not operate.

Windows XP

After confirming that the hard disk drive indicator (Ⓜ) has turned off, select the user and input the password, then select . Until the correct password entered the computer will not operate.

4 Select your application.

You are able to start working on your computer.

NOTE

- The power saving function is factory set, so if there is no input from a key, the touch pad, the tablet button, the touchscreen or an external mouse (when one is connected) for a certain interval of time, the power to the LCD and hard disk may be turned off. The LCD will resume operation when the touch pad, the touchscreen or an external mouse (when one is connected) is used or a key or the tablet button is pressed. The power to the LCD may be turned off even when an application software is being installed. In this case, because it is conceivable that a selection dialog box will be shown, do not press **Space** or **Enter** to attempt to resume from this condition as doing so may trigger a selection, but instead, press a key unrelated to the direct triggering of a selection, like **Ctrl**.
In addition, when the computer is left alone, it automatically enters the standby or hibernation mode (Reference Manual “Standby/Hibernation Functions”). The computer will resume by sliding the power switch.
- **Windows XP**
When switching to a different user with the Fast User Switching function, it may not be possible to set the settings of the display. In this case, log on with the administrator authority again, not using the Fast User Switching function, and try the operation once more.

Shutting Down (power off your computer)

This procedure is for shutting down the computer without using the standby or hibernation function (☞ Reference Manual “Standby/Hibernation Functions”).

1 Save important data and close each application.

2 Windows 2000

Select [Start] - [Shut Down].

Windows XP

Select [Start] - [Turn Off Computer].

3 Windows 2000

Select [Shut down], then select [OK].

Windows XP

Select [Turn Off].

Your computer will power off automatically.

● **Restarting your computer (without shutting down)**

Windows 2000

Select [Restart], then select [OK].

Windows XP

Select [Restart].

CAUTION

Do not do the following during the shutdown/restart procedure.

- Connecting or disconnecting the AC adaptor.
- Touching the power switch or the tablet buttons.
- Performing any keyboard, touch pad, touchscreen (or external mouse) operations.
- Closing the display.

NOTE

● **To shut down using the keyboard,**

Windows 2000

Press , (U), and select [Shut down] with    , then press **Enter**.

Windows XP

Press , (U), and select [Turn Off] with    , then press **Enter**.

● **To quickly resume computer operation after shutting down,**

The standby or hibernation function is available. (☞ Reference Manual “Standby/Hibernation Functions”)

(To next page)

Starting Up/Shutting Down

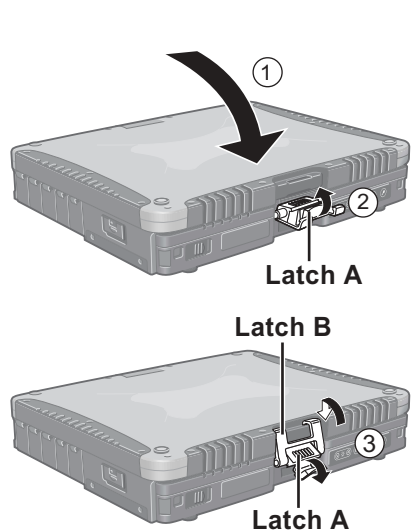

4 Close the display.

- ① Close the display.
- ② Pull up on the latch A.
- ③ Position the latch B on the display side, then bring the latch A down to fix the display in place.

Touch Pad (Basic Operation)

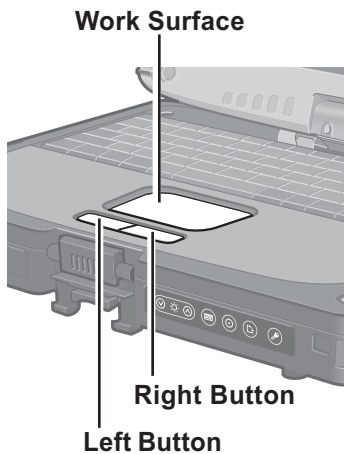

Use the touch pad to move the cursor on the display and perform normal computer operations. For instructions on how to operate,  Reference Manual “Touch Pad (Advanced)”.

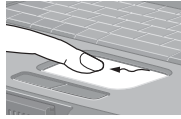
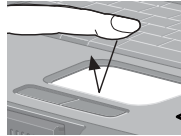
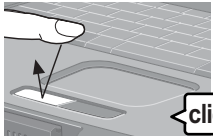
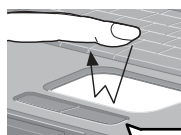
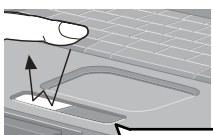
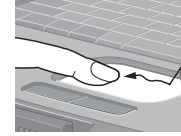
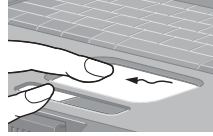
Function	Operation
Moving the Cursor	 Move the tip of your finger lightly over the surface.
Tapping/Clicking	 or  tapping clicking
Double-Tapping/ Double-Clicking	 or  double-tapping double-clicking
Dragging	 or  Two quick taps, but on the second tap leaving your finger down (applying pressure) and moving it on the work surface. While holding down the button, moving your finger on the work surface.

Handling the Touch Pad

- If a key combination such as **(Fn) + (F5)** is used while the pad is being touched, the function of the key combination may not work. In addition, it is possible that control of the cursor will be lost and the cursor will not show proper movements. In such cases, the computer has to be restarted by using the keyboard (e.g., ).
- The touch pad is designed to be used with a fingertip only. Therefore, avoid the following actions, which may cause damage to the work surface.
 - Placing any object on the work surface
 - Pressing down forcefully with sharp-pointed objects (e.g., nails) or hard objects that can leave marks (e.g., pencils and ball point pens)
- Try to avoid having any harmful substances such as oil, come in contact with the touch pad. The cursor may not work properly in such cases.
- **When the touch pad becomes dirty:**
Wipe to remove dirt by using a dry soft cloth such as gauze or a soft cloth first applied with detergent diluted with water and then thoroughly wrung.
Do not use benzene, thinner, or rubbing alcohol. Doing so may adversely affect the surface, e.g., discoloration. In addition, do not use commercially-available household cleaners and cosmetics, as they may contain components harmful to the surface.

Touchscreen (Basic Operation)

Your computer is equipped with a touchscreen function allowing you to perform the same operations as the touch pad or mouse by touching the surface of the display with the stylus (included). (The following explanation gives one example (for the default settings).)

The operation settings can be changed. For detailed information,  Reference Manual “Touchscreen (Advanced)”.

● Moving the cursor

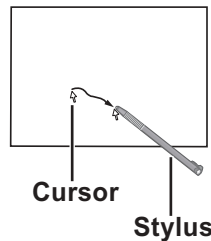

● Clicking

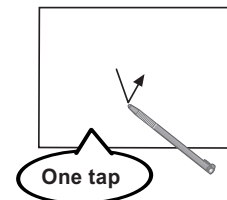

● Double-clicking

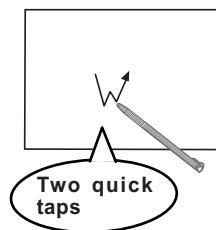

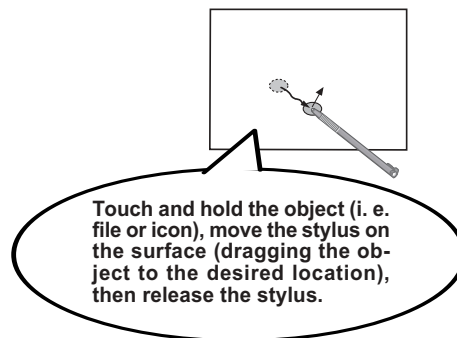

● Dragging



NOTE

To right-click:

- 1 Select  on the taskbar.
 changes to .
- 2 Select the object you want to right-click.

Handling the Touchscreen

- Use the stylus included with the computer. Do not use an implement other than the stylus that comes with the computer.
- Do not place any object on the surface or press down forcefully with sharp-pointed objects (e.g., nails), or hard objects that can leave marks (e.g., pencils and ball point pens).
- Do not operate the computer when such things as dust are on the screen. Do not allow contact with substances that could dirty the touchscreen, such as oil.
- **When the touchscreen becomes dirty:**
Wipe to remove dirt by using a dry soft cloth included with the computer.
Do not use benzene or thinner, or rubbing alcohol.
For more information, refer to “Suggestions About Cleaning the LCD Surface” that comes with the soft cloth.

Handling the Stylus

- Clean the stylus tip and screen prior to operation. Foreign particles can scratch the screen and impede the operation of the stylus.
- Use the stylus only for the computer screen. Using it for any other purpose may damage the stylus and scratch the screen.
- Do not use pencils, implements with sharp tips or hard objects for screen operations. The screen may be damaged as a result.

Operating in Tablet Mode

In addition to being used as a regular notebook computer (Laptop mode), this computer can also be operated in Tablet mode. Simply turn the display around 180°, and close the computer with the display facing up. In Tablet mode, the computer can be operated using the touchscreen (☞ page 20), the software keyboard and the tablet buttons (☞ Reference Manual “Tablet Buttons”), instead of the internal keyboard and the touch pad.

Set the computer in Tablet mode using the following procedure.

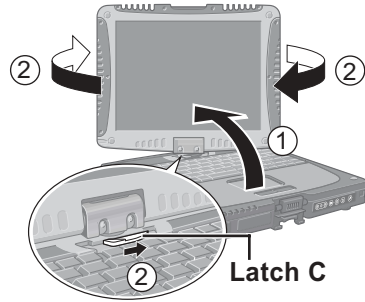

- ① Open the display so that it is perpendicular with the body of the computer.
- ② Slide the latch C to the right, and then without releasing it, turn the display clockwise by 180°.

CAUTION

Do not rotate the display more than 180°, or attempt to rotate the display counter-clockwise.

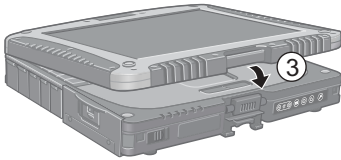

- ③ Close the computer with the display facing up.

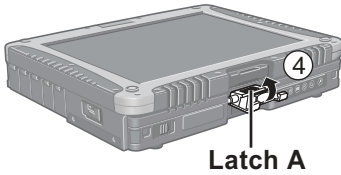

- ④ Pull up on the latch A.

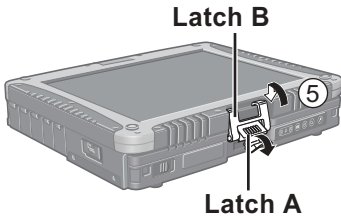

- ⑤ Position the latch B on the display side, then bring the latch A down to fix the display in place.

NOTE

To return to Laptop mode:
Perform the steps for changing the computer into Tablet mode, only in reverse order.

- 1 Pull up on latch A and release the latch B.
- 2 Open the display.
- 3 Slide the latch C to the right, and then without releasing it, turn the display counter-clockwise by 180°.

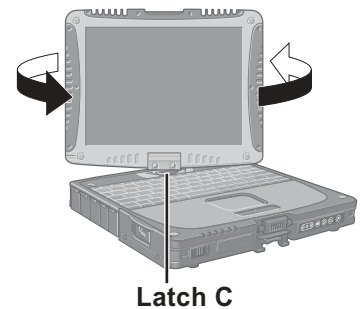

Usage Example

In Tablet Mode, the computer can be operated while holding the body as shown in the figure.

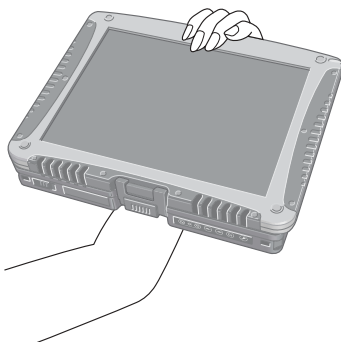

Operating in Tablet Mode

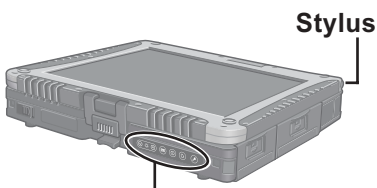

Tablet Buttons

- LCD brightness control
- Input Panel
- Enter
- Rotation
- Security

Changing the Display Settings

● To rotate the display

Press the rotation button until the display is set at the angle that is most comfortable for you.

For detailed information, Reference Manual “Display Rotation”

NOTE

You can set the computer so that the display automatically rotates to your preferred angle when changing from Laptop Mode to Tablet Mode or vice versa. Reference Manual “Display Rotation”

● To adjust the brightness of LCD

Press the LCD brightness control buttons .

Inputting Characters

Press the input panel button .

The software keyboard shown below will appear, and characters can be input with the stylus (included). For detailed information, Reference Manual “Software Keyboard”.



NOTE

- You can also start up the software keyboard using the following procedure.

Windows 2000

Select [Start] - [Programs] - [Panasonic] - [Software Keyboard].

Windows XP

Select [Start] - [All Programs] - [Panasonic] - [Software Keyboard].

- When using the touchscreen function, use only the stylus included with the computer.

Reference Manual

The Reference Manual and the Important Tips can be accessed on your computer. When a printer is connected, these manuals can also be printed.

- The Reference Manual explains functions for you to make greater use of the computer, such as how to add peripheral devices, how the Setup Utility works, and other useful information. (Refer to the cover of this manual for a list of the main contents included.)
- Important Tips provides information on how to maximize use of the battery pack, which is necessary for computing away from your home or office.
It also offers helpful explanations on how to use the touchscreen more effectively.

Opening the Reference Manual or Important Tips

● Reference Manual

Windows 2000

Select [Reference Manual] in [Start] - [Programs] - [Panasonic] - [On-Line Manuals].

Windows XP

Select [Reference Manual] in [Start].

● Important Tips

Select  on the desktop.

Important Tips can also be accessed from the following menu.

Windows 2000

Select [Important Tips] in [Start] - [Programs] - [Panasonic] - [On-Line Manuals]

Windows XP

Select [Important Tips] in [Start] - [All Programs] - [Panasonic] - [On-Line Manuals]

When the Reference Manual or Important Tips is started up for the first time, the License Agreement of the Acrobat Reader may be displayed. If it is displayed, after reading the agreement, select [Accept] to access the Reference Manual or Important Tips. Refer to Acrobat Reader Help to use the Acrobat Reader.

NOTE

- Illustrations may be difficult to view depending on the magnification. If this is the case, we recommend that the display be magnified.
- The characters in PDF files (such as the Reference Manual) may be difficult to read depending on the Acrobat Reader settings and the Windows Desktop settings. In such cases, change the Acrobat Reader settings with the following procedure.
 - 1 Start up Acrobat Reader.
 - 2 Select [Edit] - [Preferences] - [Accessibility], and then set [Color Scheme] to [Use colors specified in document].
- When the taskbar is hidden at the bottom portion of Acrobat Reader, set the maximum display window size.
- If a printer is connected, we recommend printing pages. The illustrations and display samples may not print with a high quality.

List of Error Codes

The following is a list of the messages that BIOS can display. Most of them occur during POST. Some of them display information about a hardware device, e.g., the amount of memory installed. Others may indicate a problem with a device, such as the way it has been configured. Following the list are explanations of the messages and remedies for reported problems.

If your system displays any of the below error messages other than the ones marked with an asterisk (*), write down the message and contact Panasonic Technical Support. If your system fails after you make changes in the Setup menus, reset the computer, enter Setup and install Setup defaults or correct the error.

0200 Failure Fixed Disk

Fixed disk is not working or not configured properly. Check to see if fixed disk is attached properly. Run Setup. Find out if the fixed-disk type is correctly identified.

0211 Keyboard error

Keyboard not working.

0212 Keyboard Controller Failed

Keyboard controller failed test. May require replacing keyboard controller.

0213 Keyboard locked - Unlock key switch

Unlock the system to proceed.

0230 System RAM Failed at offset : *nnnn*

System RAM failed at offset *nnnn* of in the 64k block at which the error was detected.

0231 Shadow RAM Failed at offset : *nnnn*

Shadow RAM failed at offset *nnnn* of the 64k block at which the error was detected.

0232 Extended RAM Failed at offset : *nnnn*

Extended RAM Failed at address line : *nnnn*

Extended memory not working or not configured properly at offset or address line *nnnn*.

0250 System battery is dead - Replace and run SETUP

The CMOS clock battery indicator shows the battery is dead. Replace the battery and run Setup to reconfigure the system.

***0251 System CMOS checksum bad - Default configuration used**

System CMOS has been corrupted or modified incorrectly, perhaps by an application program that changes data stored in CMOS. The BIOS installed Default SETUP Values. If you do not want these values, enter Setup and enter your own values. If the error persists, check the system battery or contact Panasonic Technical Support.

0260 System timer error

The timer test failed. Requires repair of system board.

0270 Real time clock error

Real-time clock fails BIOS test. May require board repair.

0271 Check date and time settings

Real-time clock is illegal. Run Setup and set the date and clock.

***0280 Previous boot incomplete - Default configuration used**

Previous POST did not complete successfully. POST loads default values and offers to run Setup. If the failure was caused by incorrect values and they are not corrected, the next boot will likely fail. On systems with control of **wait states**, improper Setup settings can also terminate POST and cause this error on the next boot. Run Setup and verify that the wait-state configuration is correct. This error is cleared the next time the system is booted.

02D0 System cache error - Cache disabled

Contact your Panasonic Technical Support.

Failing Bits : *nnnn*

The hex number *nnnn* is a map of the bits at the RAM address which failed the memory test. Each 1 (one) in the map indicates a failed bit. See error 230,231 or 232 for offset address of the failure in System, Extended or Shadow memory.

Operating System not found

Operating system cannot be located on either drive A: or drive C:. Enter Setup and see if fixed disk and drive A: are properly identified.

Press <F1> to resume, <F2> to Setup

Displayed after any recoverable error message. Press <F1> to start the boot process or <F2> to enter a Setup and change the settings. Write down and follow the information shown on the screen.

0614 Serial Port A config. error - device disabled

0616 Serial Port B config. error - device disabled

Serial Device I/O Address or IRQ are in conflict. Change the I/O Address or IRQ in the Setup Utility.

Dealing with Problems (Summary)

When a problem occurs, refer to this page. The “Reference Manual” also contains detailed information. If a problem appears to be related to a software application, read the software related manual. If you still cannot troubleshoot the problem, contact Panasonic Technical Support.

● Starting Up

<p>The power indicator or battery indicator is not lit</p>	<ul style="list-style-type: none"> ● Check the cable connection for the AC adaptor. ● Check to see if a fully charged battery is properly installed. ● Remove the battery pack and disconnect the AC adaptor, then connect them again.
<p>The computer does not operate when a USB device is connected</p>	<p>The computer may not operate when certain USB devices are connected. Disconnect the USB device, or set [Legacy USB support] to [Disable] in [Advanced] menu of the Setup Utility.</p>
<p>[Enter Password] is displayed</p>	<p>Input your password. If you have forgotten it, contact Panasonic Technical Support.</p>
<p>POST Startup Error(s) is displayed</p>	<p>☞ page 24</p>
<p>Windows startup, or an operation is extremely slow</p>	<p>Press (F9) in the Setup Utility (☞ <small>Reference Manual</small> “Setup Utility”). This will restore the Setup Utility’s settings to their default values (except the password settings). Then, the Setup Utility must be run once again for you to input the appropriate operating environment settings. (The processing speed depends on the application software used, so this operation may not cause the processing speed to increase.)</p>
<p>The date and time are incorrect</p>	<ul style="list-style-type: none"> ● You can set the date and time using the following menu. <small>Windows 2000</small> [Control Panel] - [Date/Time] <small>Windows XP</small> [Control Panel] - [Date, Time, Language, and Regional Options] - [Date and Time] ● When the computer is connected to a LAN, confirm the date and time of the server. ● If you continue to experience problems, the internal battery maintaining the clock may need to be replaced. Contact Panasonic Technical Support. ● When the computer is connected to a LAN, confirm the date and time of the server. ● This computer will not correctly recognize the date and time starting from the year 2100 A.D.
<p>When resuming from the standby or hibernation mode, [Enter Password] does not appear even if a password has been set in the Setup Utility</p>	<p>Even when a password has been set in the Setup Utility, [Enter Password] does not appear when the computer resumes from the standby or hibernation mode. If you want to use the security function when using the standby or hibernation mode, use the Windows password as follows: <small>Windows 2000</small> Set the password in [Control Panel] - [Users and Passwords], then add the check mark for [Prompt for password when computer goes off standby] in [Control Panel] - [Power Options] - [Advanced]. <small>Windows XP</small> Select the account to change in [Control Panel] - [User Accounts] and set the password, then add the check mark for [Prompt for password when computer resumes from standby] in [Control Panel] - [Performance and Maintenance] - [Power Options] - [Advanced].</p>
<p>When “Invalid system disk. Replace the disk, and then press any key.” (or a similar message) is displayed</p>	<ul style="list-style-type: none"> ● This means a floppy disk that does not contain system startup information has been left in the floppy disk drive. Remove the floppy disk, and press any key. ● This message may appear when certain USB devices are connected. Remove the USB device, or set [Legacy USB support] in [Advanced] menu of the Setup Utility to [Disable]. ● If the message still appears even after trying the above two measures, this may be an indication that some type of hard disk failure has occurred. Contact Panasonic Technical Support.
<p>When the administrator password is forgotten</p>	<p><small>Windows 2000</small> After reinstalling, setup Windows and then set the password again. <small>Windows XP</small> If you have created a password reset disk (☞ page 14), a message is displayed when you fail to correctly enter the password. Follow the message’s instructions and set the password again by using the password reset disk. If you have not created a password reset disk, after reinstalling, setup Windows and then set the password again.</p>

Dealing with Problems (Summary)

Starting Up (continued)

When the previous item is not the cause	<ul style="list-style-type: none"> ● Press (F9) in the Setup Utility (☞ <small>Reference Manual</small> “Setup Utility”). This will restore the Setup Utility’s settings to their default values (except the password settings). ● Try removing all peripheral devices. ● Check a disk error using the following procedure. <ul style="list-style-type: none"> Windows 2000 1 Select [Local Disk(C:)] with the right button in [My Computer], and select [Properties]. 2 Select [Tools] - [Check Now]. 3 Select [Start] after selecting required items in [Check disk options]. Windows XP 1 Select [Local Disk(C:)] with the right button in [Start] - [My Computer], and select [Properties]. 2 Select [Tools] - [Check Now]. 3 Select [Start] after selecting required items in [Check disk options]. ● At startup, hold down (F8) when the [Panasonic] screen disappears, and release your finger when the Windows Advanced Options Menu is displayed. Start the computer in Safe Mode, and confirm the details of the error.
---	--

Display

No display after powering on	<ul style="list-style-type: none"> ● When there is no display to an external display, <ul style="list-style-type: none"> • Check your cable connection to the external display. • Confirm your display is powered on. • Check the settings for your external display. ● Try changing the display by pressing (Fn) + (F3). ● When displaying only through an external display, if the computer is shut down by using the standby or hibernation function, there may be no display on the LCD unless the external display is connected when operations are resumed. In this case, connect the external display or press (Fn) + (F3).
The power has not been turned off, but after a certain period of time, there is no display	<ul style="list-style-type: none"> ● Has the computer been set to the power-saving mode? To resume operation of your computer from the condition the power of the display is off (for energy conservation purposes), press any key unrelated to the direct triggering of a selection, like (Ctrl). ● To save power, your computer may have automatically entered the standby mode (power indicator blinks green) or hibernation mode (power indicator turns off). In such cases, slide the power switch. ● If you want to switch the display destination repeatedly by pressing (Fn) + (F3), make sure that the display destination has switched completely each time before pressing (Fn) + (F3) again.
When the battery pack is used, the screen is darker than when the AC adaptor is connected	<p>Press (Fn) + (F2) and adjust the brightness. Note, however, that when the brightness is increased, the battery running time will become shorter.</p> <p>Brightness can be set to separate levels for when the AC adaptor is connected and when it is disconnected.</p>
An afterimage appears (e.g., green, red, and blue dots remain on the display) or there are dots not displaying the correct colors	<ul style="list-style-type: none"> ● If an image is displayed for a prolonged period of time, an afterimage may appear. This is not a malfunction. The afterimage will disappear when a different screen is displayed. ● High-precision and advanced technologies are necessary in the production of color liquid crystal displays (color LCDs). Therefore, if 0.002% or less of the picture elements either fail to light or remain constantly lit (that is, more than 99.998% of elements are functioning properly), no defect is considered to exist.
The cursor cannot be controlled properly	<ul style="list-style-type: none"> ● Restart the computer by using the keyboard (Press (Win), (U), and select [Restart] with (→), (←), (↑), (↓), then press (Enter)). ● If the computer does not respond to keyboard commands, read “Computer hangs” (☞ page 29). ● Be sure to use the Display Rotation Tool to rotate the display.

● Display (continued)

The cursor does not move in scrolling area of the touch pad	When the Microsoft® IntelliMouse™ Wheel mode or the original mode is set for the touch pad, only scroll operations are possible for the right part or bottom part of the touch pad. In this case, cursor operations are possible by using the work surface excluding the right part or bottom part. When no mode is set, the entire surface of the touch pad can be used for cursor operations.
The external display no longer displays properly	When an external display is used that is incompatible with the power saving modes of the computer, the display may not function correctly when the computer enters the power saving mode. In such cases, turn off the power to the external display.
During simultaneous display, the screen of the external display becomes disordered	<ul style="list-style-type: none"> ● Try changing the display by pressing (Fn) + (F3). ● If you continue to experience problems, try changing the display in the following menu. Windows 2000 [Start] - [Settings] - [Control Panel] - [Intel(R) Extreme Graphics]. Windows XP [Start] - [Control Panel] - [Other Control Panel Options] - [Intel(R) Extreme Graphics]

● Battery Indicator

The red indicator lights	The battery level is very low (the charge is less than approx. 9% capacity). Connect the AC adaptor. You can use the computer when the battery indicator light is orange. If you do not have an AC adaptor, save your data and power off your computer. After replacing the battery pack with a fully charged one, turn your computer on.
The red indicator blinks	Quickly save your data and power off your computer. Remove the battery pack and disconnect the AC adaptor, then connect them again. If the problem persists, contact Panasonic Technical Support. The battery pack or recharging function may be defective.
The orange indicator blinks	Battery cannot be recharged temporarily because the internal temperature of the battery pack is outside of the acceptable temperature range for recharging. Once the allowable range requirement is satisfied, charging begins automatically. Your computer can be used normally in this state.
The green indicator blinks	In high temperature mode, the battery pack is discharging to a level of 80%* in normal temperature mode. (☞ <small>Reference Manual</small> "Battery Power") Do not remove the battery pack while the battery indicator is blinking green. * A level of 80% in normal temperature mode is displayed as [100%] in high temperature mode.
The battery indicator blinks green and orange alternately	Warming up the system to prevent hard disk drive malfunctions at low temperature. Leave your computer as is. Once the allowable temperature range requirement is satisfied, your computer will start automatically.

● Reference Manual

The Reference Manual is not displayed	Is Acrobat Reader installed? If Acrobat Reader is not installed, run [c:\util\reader\acroreader51_enu_full.exe] in [Start] - [Run] to reinstall the program. When installing the program, do not change the installation destination folder. If the destination folder is changed, the Reference Manual cannot be opened from the [Start] menu.
--	--

Dealing with Problems (Summary)

● Shutting down

Windows cannot be shut down or restarted	If a USB device is connected, try removing it.
“This program is not responding” is displayed when shutting down or logging off	This message appears periodically; for example, when using a Wireless LAN. If the message appears, select [End Now]. Delete the check mark for [Show the tray icon] in the following menu. Windows 2000 : [Start] - [Programs] - [Intel Network Adapters] - [Intel(R) PROSet] Windows XP : [Start] - [All Programs] - [Intel Network Adapters] - [Intel(R) PROSet]

● Display Rotation

The display cannot be rotated	<ul style="list-style-type: none"> ● Remove the checkmark from [Hide modes that this monitor cannot display]*. * Windows 2000 In [Start] - [Settings] - [Control Panel] - [Display] - [Settings] - [Advanced] - [Monitor]. Windows XP In [Start] - [Control Panel] - [Appearance and Themes] - [Display] - [Settings] - [Advanced] - [Monitor]. ● Close any applications that are currently open. ● Windows 2000 Add the checkmark for [Enable Rotation] in [Start] - [Settings] - [Control Panel] - [Intel(R) Extreme Graphics]
The display cannot be changed and the operation of the touch pad and the touchscreen do not match the display angle	<ul style="list-style-type: none"> ● When some applications are running (Outlook Express etc.), the display may not be changed and the operation of the touch pad and the touchscreen may not match the display angle. Press the rotation button (⌘) 1 - 3 times (until the operation of the touch pad and the touchscreen matches the display angle). After exiting the application, rotate the display, then start up the application again. ● If the problem persists, restart the computer.
The display is not rotated automatically by switching from Laptop mode to Tablet mode, or vice versa	<ul style="list-style-type: none"> ● Confirm that the default angle of each mode is correctly set. (☞ <small>Reference “Display Rotation” Manual</small>) ● Windows XP Do not switch from Laptop mode to Tablet mode, or vice versa, while Windows is in the process of switching users with the Fast User Switching function.
When the display is rotated, an application error occurs in explorer.exe	Windows 2000 Select [Center] for [Picture Display] in [Start] - [Settings] - [Control Panel] - [Display] - [Background]. Windows XP Select [Center] for [Position] in [Start] - [Control Panel] - [Appearance and Themes] - [Display] - [Desktop].
When the screensaver starts while the display is rotated, nothing is displayed on the screen	Some screensaver types do not display anything on the screen for the first minute or so. Try changing the screensaver type.
Windows 2000 The operation of the touch pad and the touchscreen do not match the display angle	This problem may occur if the screen settings are changed while the display is rotated. Press the rotation button (⌘) 1 - 3 times (until the operation of the touch pad and the touchscreen matches the display angle).

● Fast User Switching Function Windows XP

Some applications do not work properly	<p>When switching to a different user with the Fast User Switching function, the following problems may occur.</p> <ul style="list-style-type: none">• Some applications may not work properly (for example, PDF files may not be printed properly).• Key combinations with (Fn) may not work.• It may not be possible to set the settings of the display.• A serial mouse may not work.• Wireless LAN may not work. <p>If any of the above occurs, log on with the administrator authority again, not using the Fast User Switching function, and try the operation once more.</p>
---	--

● Others

Computer hangs	<ul style="list-style-type: none">● Press (Ctrl) + (Shift) + (Esc) to open Task Manager and close the software application which is not responding.● After shutting down by sliding the power switch for more than four seconds, slide the power switch to power on and open the application again. If the program no longer works normally, delete the program using the following procedure. Then reinstall the program. Windows 2000 : [Start] - [Settings] - [Control Panel] - [Add/Remove Programs] Windows XP : [Start] - [Control Panel] - [Add or Remove Programs]
-----------------------	--

Reinstalling Software

When reinstall procedure is performed, the contents of the hard disk will be erased. Be sure to back up any critical data that is on your hard disk before running the reinstall procedure.

The reinstall procedure will return the computer to its original condition.

- If you have created partitions for data, the data may be erased or become corrupt as a result of the reinstall procedure.

Before Reinstallation

● Preparing

- BACKUP DISK(s) created in advance (☞ page 13)
- Product Recovery CD-ROM (included)
- Panasonic USB floppy disk drive (optional: CF-VFDU03)
- Panasonic CD drive (optional: KXL-RW10AN <PC Card-compatible> or CF-VDRRT1 <USB>)
When using a PC Card-compatible CD drive other than the Panasonic KXL-RW10AN CD drive: ☞ page 31

NOTE

If you have not created the FIRTAID FD, you can create by using the following procedure:

Windows 2000

[Create Backup Disk] in [Start] - [Programs] - [Panasonic].

Windows XP

[Create Backup Disk] in [Start] - [All Programs] - [Panasonic].

If you can not create this disk, contact Panasonic Technical Support.

● Important

- Before the reinstallation procedure, remove all peripherals (except for the CD and floppy disk drive).
- Be sure the AC adaptor is connected until the reinstallation procedure is completed.
- When using the Panasonic KXL-RW10AN CD drive, set the switch of the PC Card to 16-bit.

Reinstalling

- 1 Turn off the computer.
- 2 Connect the CD drive to the computer.
<Only when using the Panasonic CD drive KXL-RW10AN>
Connect the floppy disk drive to the USB port of the computer, then set the FIRTAID FD in the floppy disk drive.
- 3 Turn the computer on, and press **(F2)** while [Panasonic] screen is displayed.
The Setup Utility will start up.
If the password has been set, enter the Supervisor Password.
- 4 Write down all of the contents of the Setup Utility and then press **(F9)**.
At the confirmation message, select [Yes] and press **(Enter)**.
<Only when using the Panasonic CD drive CF-VDRRT1>
Select [Boot] menu, then select [CD Drive] and press **(F6)** until [CD Drive] is at the top of the [Boot] menu.
- 5 Place the disc number one of the recovery CDs into the CD drive.
- 6 Press **(F10)**.
At the confirmation message, select [Yes] and press **(Enter)**.
The computer will restart, and this screen should appear:

```
-----  
Select a number  
-----  
1. Start restoring the operating system.  
2. Erase the whole data on HDD for security.  
3. End  
-----
```
- 7 Select [1. Start restoring the operating system.].
The License Agreement screen should appear.

- 8 Select [1. Yes, I agree to the provisions above and wish to continue!].

This screen should appear.

Windows 2000

```
-----
Select a number
-----
1. Restore Windows(R) 2000 Professional to the whole HDD.
2. Make two partitions, for the operating system and data. And restore
   Windows(R) 2000 Professional to the operating system partition.
   (All existing partitions on HDD will be lost.)
3. Restore Windows(R) 2000 Professional to the first partition.
4. End
-----
```

Windows XP

```
-----
Select a number
-----
1. Restore Windows(R) XP Professional to the whole HDD.
2. Make two partitions, for the operating system and data. And restore
   Windows(R) XP Professional to the operating system partition.
   (All existing partitions on HDD will be lost.)
3. Restore Windows(R) XP Professional to the first partition.
4. End
-----
```

- 9 Make a selection from the menu.
- When selecting [2], enter the basic partition size for the operating system installation and press **Enter**.
(The data partition size is the remainder after subtracting the basic partition size.)
 - To select [3], the initial partition size must be 6 GB or more of the hard disk size. Reinstallation cannot be performed with a small partition size.
- 10 At the confirmation message, press **Y**.

The operation of reinstallation for the hard disk starts automatically. (The operations take about 20 minutes <PC Card-compatible> or 50 minutes <USB>.)

CAUTION

- Do not cancel the reinstall procedure before it is completed.
- When a message appears instructing you to insert the next CD, insert the recovery CD showing the next number in the sequence, and then select [OK]. If the message "The media does not contain the correct file" appears, select [OK]. A message will appear instructing you to insert the next CD. Confirm that the proper recovery CD has been inserted by opening the tray of the CD drive and then close the tray, then select [OK].

- 11 After the reinstallation procedure completes, press any key. The computer will be shut down.
<Only when using the Panasonic CD drive KXL-RW10AN>
Remove the FIRSTAID FD and the floppy disk drive.
- 12 Remove the recovery CD and the CD drive.
- 13 Turn the computer on, and press **F2** while [Panasonic] screen is displayed.
The Setup Utility will start up.
If the password has been set, enter the Supervisor Password.

- 14 Press **F9**.

At the confirmation message, select [Yes] and press **Enter**. (The Setup Utility settings will return to their default values. Even the security settings with the exception of the password(s) will return to their default values.)

- 15 Press **F10**.

At the confirmation message, select [Yes] and press **Enter**.

- 16 Perform the setup procedure for Windows by following the instructions on the screen. (☞ page 10 - 12)

NOTE

When an UPDATE FD is to be created, follow the steps in the readme.txt on the disk. (☞ page 13)

- 17 Run the Setup Utility and change the settings where necessary.

<When using a PC Card-compatible CD drive other than the Panasonic KXL-RW10AN>

Copy the necessary drivers, from the floppy disk included with your CD drive, to the FIRSTAID FD with the method below. It will be necessary to edit the CONFIG.SYS file and AUTOEXEC.BAT file on the FIRSTAID FD. When editing the AUTOEXEC.BAT file, some CD drives require card managers (card and socket service). See the manual included with your CD drive for further details.

- ① Start Windows and insert the FIRSTAID FD.
- ② **Windows 2000**
Select [Start]-[Programs]-[Accessories]-[Notepad]-[File]-[Open], input [a:\config.sys], then select [Open].
Windows XP
Select [Start]-[All Programs]-[Accessories]-[Notepad]-[File]-[Open], input [a:\config.sys], then select [Open].
- ③ Rewrite the following line and save.

Delete the following four lines.
;KXL-RW10AN DRIVER
DEVICE=A:\TOOLS\KMASMGRA.SYS
DEVICE=A:\TOOLS\KMASASPA.SYS
DEVICE=A:\TOOLS\KMASCSA.SYS /D:MSCD000

Add the driver of your CD drive.

Device=A:\DRIVER1.SYS /D:MSCD000

└ Rewrite this driver for the driver of your CD drive. The driver for the PC Card will also be necessary. Refer to the operation manual that accompanies the CD drive.

- ④ Save the file and close [Notepad].
- ④ Copy the CD driver file (i.e., the driver file rewritten in step ③) of the CD drive below [a:\] of the FIRSTAID FD.
- ⑤ Set the floppy disk to the write-protect state.

After this, follow the reinstalling procedure of <Only when using the Panasonic CD drive KXL-RW10AN>. (☞ page 30)

LIMITED USE LICENSE AGREEMENT

THE SOFTWARE PROGRAM(S) ("PROGRAMS") FURNISHED WITH THIS PANASONIC® PRODUCT ("PRODUCT") ARE LICENSED ONLY TO THE END-USER ("YOU"), AND MAY BE USED BY YOU ONLY IN ACCORDANCE WITH THE LICENSE TERMS DESCRIBED BELOW. YOUR USE OF THE PROGRAMS SHALL BE CONCLUSIVELY DEEMED TO CONSTITUTE YOUR ACCEPTANCE OF THE TERMS OF THIS LICENSE.

Matsushita Electric Industrial Co., Ltd. ("MEI") has developed or otherwise obtained the Programs and hereby licenses their use to you. You assume sole responsibility for the selection of the Product (including the associated Programs) to achieve your intended results, and for the installation, use and results obtained therefrom.

LICENSE

- A. MEI hereby grants you a personal, non-transferable and non-exclusive right and license to use the Programs in accordance with the terms and conditions stated in this Agreement. You acknowledge that you are receiving only a LIMITED LICENSE TO USE the Programs and related documentation and that you shall obtain no title, ownership nor any other rights in or to the Programs and related documentation nor in or to the algorithms, concepts, designs and ideas represented by or incorporated in the Programs and related documentation, all of which title, ownership and rights shall remain with MEI or its suppliers.
- B. You may use the Programs only on the single Product which was accompanied by the Programs.
- C. You and your employees and agents are required to protect the confidentiality of the Programs. You may not distribute or otherwise make the Programs or related documentation available to any third party, by time-sharing or otherwise, without the prior written consent of MEI.
- D. You may not copy or reproduce, or permit to be copied or reproduced, the Programs or related documentation for any purpose, except that you may make one (1) copy of the Programs for backup purposes only in support of your use of the Programs on the single Product which was accompanied by the Programs. You shall not modify, or attempt to modify, the Programs.
- E. You may transfer the Programs and license them to another party only in connection with your transfer of the single Product which was accompanied by the Programs to such other party. At the time of such a transfer, you must also transfer all copies, whether in printed or machine readable form, of every Program, and the related documentation, to the same party or destroy any such copies not so transferred.
- F. You may not remove any copyright, trademark or other notice or product identification from the Programs and you must reproduce and include any such notice or product identification on any copy of any Program.

YOU MAY NOT REVERSE ASSEMBLE, REVERSE COMPILE, OR MECHANICALLY OR ELECTRONICALLY TRACE THE PROGRAMS, OR ANY COPY THEREOF, IN WHOLE OR IN PART.

YOU MAY NOT USE, COPY, MODIFY, ALTER, OR TRANSFER THE PROGRAMS OR ANY COPY THEREOF, IN WHOLE OR IN PART, EXCEPT AS EXPRESSLY PROVIDED IN THE LICENSE.

IF YOU TRANSFER POSSESSION OF ANY COPY OF ANY PROGRAM TO ANOTHER PARTY, EXCEPT AS PERMITTED IN PARAGRAPH E ABOVE, YOUR LICENSE IS AUTOMATICALLY TERMINATED.

TERM

This license is effective only for so long as you own or lease the Product, unless earlier terminated. You may terminate this license at any time by destroying, at your expense, the Programs and related documentation together with all copies thereof in any form. This license will also terminate effective immediately upon occurrence of the conditions therefor set forth elsewhere in this Agreement, or if you fail to comply with any term or condition contained herein. Upon any such termination, you agree to destroy, at your expense, the Programs and related documentation together with all copies thereof in any form.

YOU ACKNOWLEDGE THAT YOU HAVE READ THIS AGREEMENT, UNDERSTAND IT AND AGREE TO BE BOUND BY ITS TERMS AND CONDITIONS. YOU FURTHER AGREE THAT IT IS THE COMPLETE AND EXCLUSIVE STATEMENT OF THE AGREEMENT BETWEEN US, WHICH SUPERSEDES ANY PROPOSAL OR PRIOR AGREEMENT, ORAL OR WRITTEN, AND ANY OTHER COMMUNICATIONS BETWEEN US, RELATING TO THE SUBJECT MATTER OF THIS AGREEMENT.

About Intel® software products

The enclosed software products and documentation were developed at private expense, and are provided with "RESTRICTED RIGHTS." Use, duplication or disclosure by the government is subject to restrictions as set forth in FAR 52.227-14 and DFARS 252.227-7013 et. seq. or its successor. The use of this product by the government constitutes acknowledgment of Intel's proprietary rights in the product.

Contrat de licence d'usage limité

Le(s) logiciel(s) (les "Logiciels") fournis avec ce produit Panasonic® (le "Produit") sont exclusivement concédés en licence à l'utilisateur ultime ("vous"), et ils ne peuvent être utilisés que conformément aux clauses contractuelles ci-dessous. En utilisant les logiciels, vous vous engagez de manière définitive à respecter les termes, clauses et conditions des présentes.

Matsushita Electric Industrial Co., Ltd. ("MEI") a mis au point ou obtenu les Logiciels et vous en concède l'utilisation par les présentes. Vous assumez l'entière responsabilité du choix de ce Produit (y compris des Logiciels associés) pour obtenir les résultats escomptés, ainsi que de l'installation, de l'utilisation et des résultats obtenus.

Licence

- A. MEI vous octroie par les présentes le droit et la licence personnels, non cessibles et non exclusifs d'utiliser les Logiciels conformément aux termes, clauses et conditions de ce Contrat. Vous reconnaissez ne recevoir qu'un droit limité d'utiliser les Logiciels et la documentation les accompagnant et vous vous engagez à n'obtenir aucun droit de titre, propriété ni aucun autre droit vis-à-vis des Logiciels et de la documentation les accompagnant ni vis-à-vis des algorithmes, concepts, dessins, configurations et idées représentés par ou incorporés dans les Logiciels et la documentation les accompagnant, dont les titres, propriété et droits resteront tous à MEI ou à leurs propriétaires.
- B. Vous ne pouvez utiliser les Logiciels que sur le Produit unique qui est accompagné par les Logiciels.
- C. Vous et vos employés ou agents êtes requis de protéger la confidentialité des Logiciels. Vous ne pouvez ni distribuer ni mettre les Logiciels et la documentation les accompagnant à la disposition d'un tiers, par partage de temps ou de quelque autre manière que ce soit, sans l'autorisation écrite préalable de MEI.
- D. Vous ne pouvez ni copier ni reproduire ni permettre la copie ni la reproduction des Logiciels ni de la documentation les accompagnant pour quelque fin que ce soit, à l'exception d'une (1) copie des Logiciels à des fins de sauvegarde uniquement pour soutenir votre utilisation des Logiciels sur le Produit unique qui est accompagné par les Logiciels. Vous ne pouvez ni modifier ni tenter de modifier les Logiciels.
- E. Vous ne pouvez céder les Logiciels et en octroyer la licence à une autre partie qu'en rapport avec votre cession du Produit unique qui est accompagné par les Logiciels à cette autre partie. Au moment de cette cession, vous devez céder également toutes les copies, que ce soit sous forme imprimée ou lisible par la machine, de tous les Logiciels ainsi que de la documentation les accompagnant, à la même partie ou détruire les copies non cédées.
- F. Vous ne pouvez retirer aucune marque de droits d'auteur, marque ou autre ni aucune identification de produit des Logiciels et vous devez reproduire et inclure toutes ces notices ou identifications de produit sur toutes les copies des Logiciels.

Vous ne pouvez assembler en sens inverse, compiler en sens inverse ni retracer les Logiciels ni aucune de leurs copies, de façon électronique ou mécanique, en tout ou en partie.

Vous ne pouvez utiliser, copier, modifier, altérer ni céder les Logiciels ni aucune de leurs copies, en tout ou en partie, à l'exception de ce qui est expressément stipulé dans ce contrat.

Si vous cédez la possession de toute copie ou de tout Logiciel à une autre partie, à l'exception de ce qui est autorisé au paragraphe E ci-dessus, votre licence est automatiquement résiliée.

Termes, clauses et conditions

Cette licence n'est effective que pour la durée de possession ou de crédit-bail du Produit, à moins d'une résiliation antérieure. Vous pouvez résilier cette licence à tout moment en détruisant, à vos frais, les Logiciels et la documentation les accompagnant avec toutes leurs copies, sous quelque forme que ce soit. Cette licence sera également résiliée, avec application immédiate, si les conditions de résiliation définies ailleurs dans ce contrat se sont réalisées ou si vous ne respectez pas les termes, clauses et conditions qui y sont contenues. Au moment de la résiliation, vous acceptez de détruire, à vos frais, les Logiciels et la documentation les accompagnant avec toutes leurs copies, sous quelque forme que ce soit.

Vous reconnaissez avoir lu ce contrat, en avoir compris toute la substance et avoir accepté de respecter ses termes, clauses et conditions. Vous reconnaissez en outre qu'ils sont la description complète et exclusive du contrat conclu entre nous, contrat qui remplace et annule toute proposition ou contrat précédent, écrit ou oral, et toute autre communication entre nous, relativement à l'objet du présent contrat.

Hard Disk Data Erase Utility

This computer is equipped with a utility for erasing hard disk data.

When disposing of or transferring ownership of this device, erase all data on the hard disk in order to prevent the theft of hard disk data following the steps below.

The hard disk data erase utility erases data using an “overwriting” method, but there is a possibility that due to malfunctions or other operational errors, data may not be completely erased. There are also specialized devices that may be able to read data that has been erased using this method. If you need to erase highly confidential data, we recommend that you contact a company that specializes in this process. Matsushita Electric Industrial Co., Ltd. will bear no responsibility for losses or damages suffered as a result of the use of this utility.

Preparing

- Product Recovery CD-ROM
 - Panasonic CD drive (optional: KXL-RW10AN <PC Card-compatible> or CF-VDRRT1 <USB>)
- <Only when using the CD-ROM drive Panasonic KXL-RW10AN>
- Panasonic USB floppy disk drive (optional CF-VFDU03)
 - FIRSTAID FD created in advance (☞ page 13)

NOTE

- Be sure the AC adaptor is connected until the procedure is completed.
- This utility can only be used for internal hard disk. It cannot be used to erase data from external hard disks.
- This utility cannot erase data from damaged disk.
- This utility cannot erase data for specific partitions.
- After executing this utility, the computer cannot be booted from the hard disk.
- If you have not created the FIRSTAID FD, you can create by using the following procedure:
 - Windows 2000 : [Create Backup Disk] in [Start] - [Programs] - [Panasonic].
 - Windows XP : [Create Backup Disk] in [Start] - [All Programs] - [Panasonic].
- If you can not create this disk, contact your Panasonic Technical Support.
- When using the Panasonic KXL-RW10AN CD drive, set the switch of the PC Card to 16-bit.

Procedure

- 1 Turn off the computer.
- 2 Connect the CD drive to the computer.
<Only when using the Panasonic CD drive KXL-RW10AN>
Connect the floppy disk drive to the USB port of the computer, then set the FIRSTAID FD in the floppy disk drive.
- 3 Turn the computer on, and press **(F2)** while [Panasonic] screen is displayed.
The Setup Utility will start up.
If the password has been set, enter the Supervisor Password.
- 4 Press **(F9)**.
At the confirmation message, select [Yes] and then press **(Enter)**.
<Only when using the Panasonic CD drive CF-VDRRT1>
Select [Boot] menu, then select [CD Drive] and press **(F6)** until [CD Drive] is at the top of the [Boot] menu.
- 5 Place disc number one of the recovery CDs into the CD drive.
- 6 Press **(F10)**.
At the confirmation message, select [Yes] and press **(Enter)**.
The computer will restart, and this screen should appear.
- 7 Select [2. Erase the whole data on HDD for security.].
- 8 At the confirmation message, press **(Y)**.
- 9 At [<<<< Start menu >>>>], press **(Enter)**.
- 10 The approximate time required for erasing data will be displayed.
Press **(Space)**.
- 11 At the confirmation message, press **(Enter)**.
The operation of erasing the hard disk starts.
(If necessary, the “hard disk data erase” operation can be cancelled after it has begun by pressing **(Ctrl)** + **(C)**.
If the operation is cancelled before being completed, a part of the data will not be erased.)
- 12 After the operation is complete:
Under normal conditions, the message [Hard disk data has been deleted.] will be displayed.
Press any key. The computer will be shut down.
If a problem occurred during the operation, an error message will be displayed.
<Only when using the Panasonic CD drive KXL-RW10AN>
Remove the FIRSTAID FD and the floppy disk drive.
- 13 Remove the recovery CD and the CD drive.

Select a number

1. Start restoring the operating system.
2. Erase the whole data on HDD for security.
3. End

Names and Functions of Parts

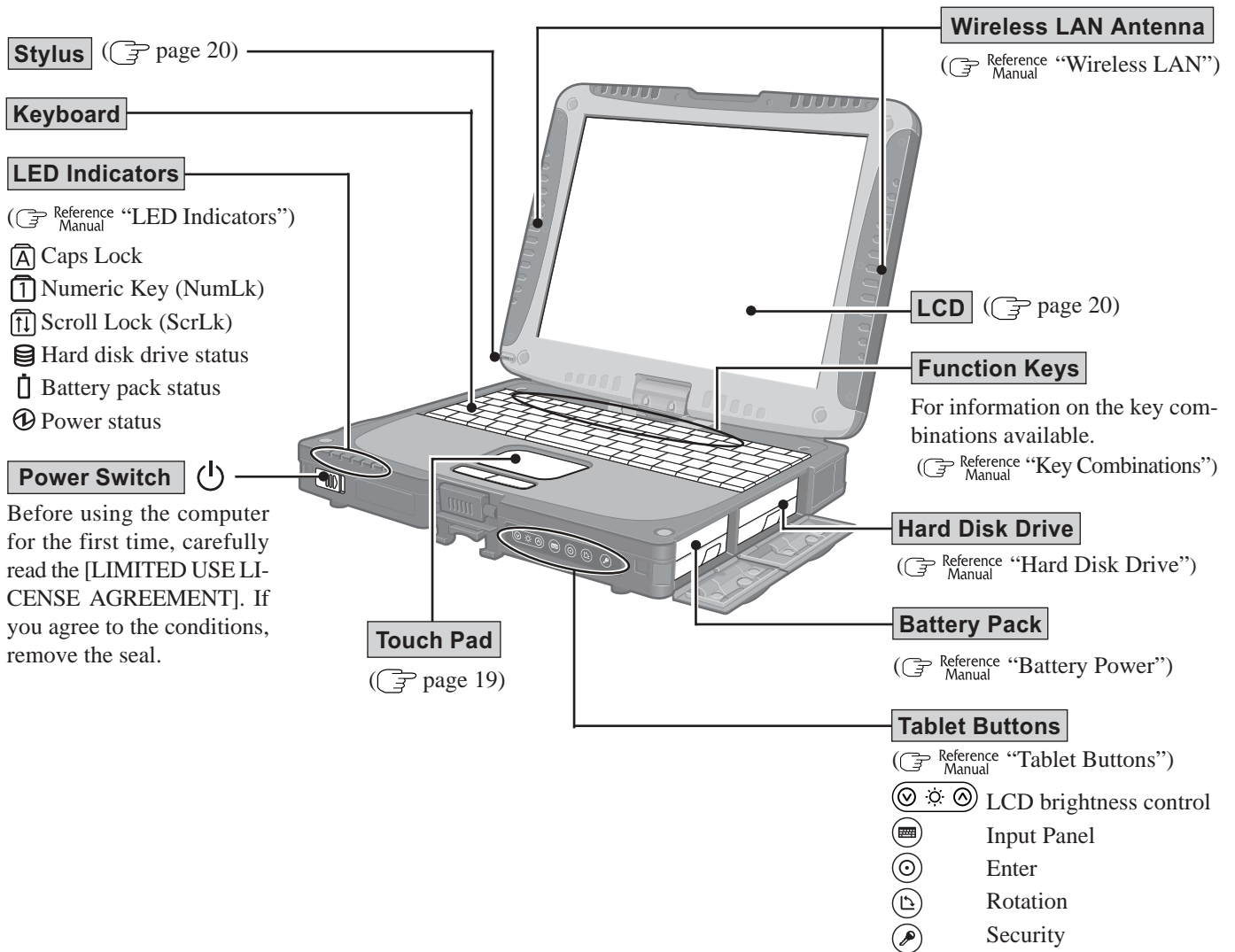

A lithium ion battery that is recyclable powers the product you have purchased. Please call 1-800-8-BATTERY for information on how to recycle this battery.

L'appareil que vous vous êtes procuré est alimenté par une batterie au lithium-ion. Pour des renseignements sur le recyclage de la batterie, veuillez composer le 1-800-8-BATTERY.

Names and Functions of Parts

Security Lock

A cable can be connected to prevent theft of your computer. For more information, read the manual provided with the cable.

Microphone Jack

Use only a monaural condenser microphone (miniature jack). Using an input source other than a monaural condenser microphone may not allow audio to be input or may damage the equipment.

Headphone Jack

Use this jack to connect headphones or amplifier-equipped speakers. Audio output from the internal speaker is disabled when headphones or external speakers are connected.

External Display Port

 Reference Manual “External Display”

Serial Port

Use this port to a serial mouse or serial communication devices.

Modem

 Reference Manual “Modem”

LAN

 Reference Manual “LAN”

PC Card Slots

 Reference Manual “PC Cards”

USB Ports

 Reference Manual “USB Devices”

DC-IN Jack DC IN 16.0 V

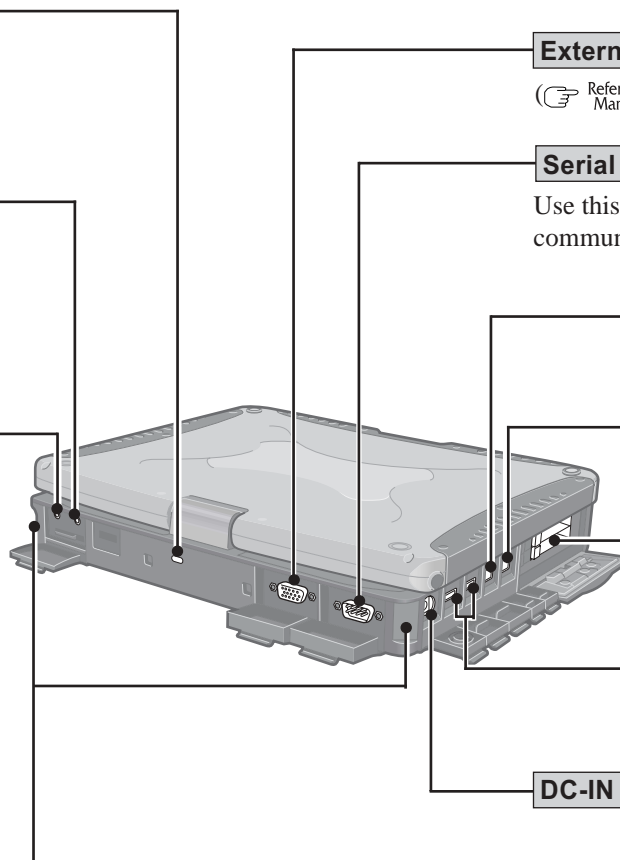

Hand Strap

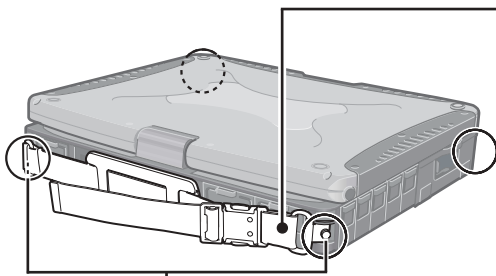

A

(The above illustration shows the position where the hand strap is attached at the factory.)

The hand strap can be attached to any two of the four corners using screws (A) which were used to attach the hand strap. Adjust the length of the belt so that the computer does not fall by mistake, and firmly hold the computer when using it.

CAUTION

- The strap has been designed to carry only the weight of the computer. Therefore, be sure that the strap does not carry a weight that exceeds the weight of the computer. The strap may accidentally come loose from the computer.
- Do not use a strap that is damaged or about to tear.

Shoulder Strap

The shoulder strap can be connected to the hand strap to make it longer.

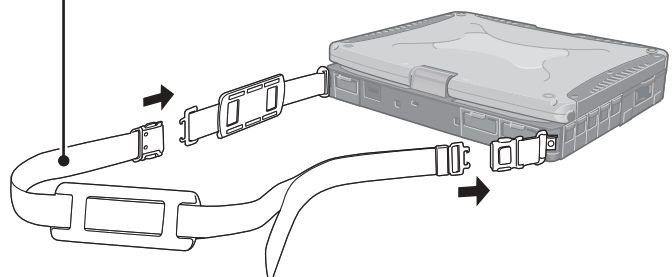

External Antenna Connectors

The external antenna connector is for use as an extension in the future.

CAUTION

FCC RF Exposure Warning:

This transmitter must not be co-located or operated in conjunction with any other antenna or transmitter.

Optional Port Replicator contains TNC connector for external mounted antenna. Employed antenna cannot exceed 7 dBi antenna gain and must be professionally installed. Also, must maintain minimum 20 cm spacing between external antenna and all person's body during wireless mode of operation.

Expansion Bus Connector

(Reference Manual "Port Replicator")

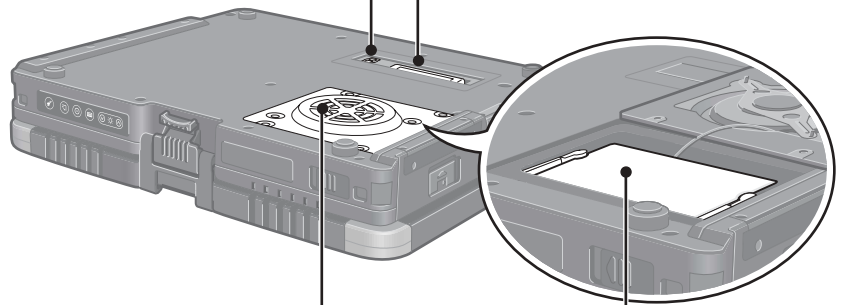

RAM Module Slot

(Reference Manual "RAM Module")

Speaker

- To adjust the volume:

Fn + **F5** / **Fn** + **F6**

- Speaker on/off : **Fn** + **F4**

CAUTION

Do not allow metallic objects or magnetic media to come in close proximity to the speaker on the bottom surface of the computer.

- Because the speaker contains a magnet, metal objects may become attached to the bottom surface of the computer. This may cause the computer to be unstable, or may mark the surface of the desk on which it is sitting.
- If floppy disks, magnetic memory cards, or other magnetic media approach the speaker, there is a risk that data will be destroyed.

Names and Functions of Parts

Using the Tether

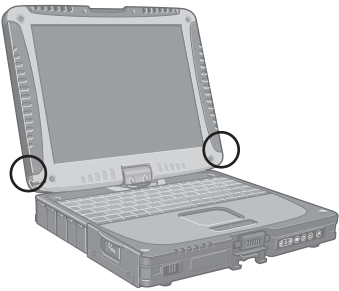

The tether can be attached to the bottom right or bottom left corner of the display. It prevents the stylus (included) from falling accidentally.

Attaching the Tether

1

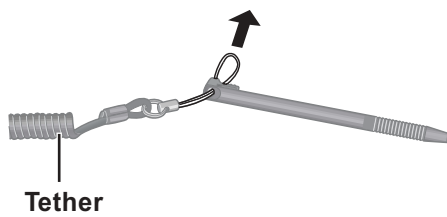

3

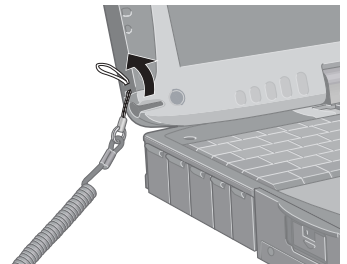

2

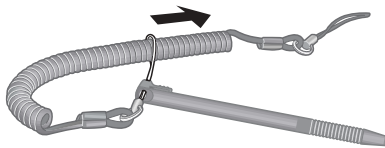

4

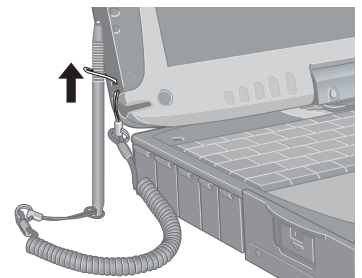

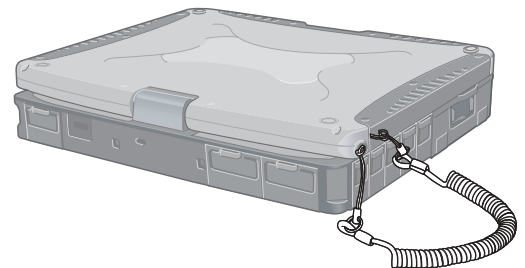
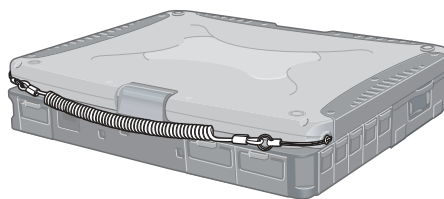

CAUTION

When closing the display, be careful not to catch the tether between the display and main part of the computer. (See the figure below.)



Specifications

● Main Specifications

Model No.		CF-18BHAZXDM/CF-18BHAZXKM	
CPU		Intel® Pentium M processor 900 MHz ULV	
L2 (Second) Cache Memory		1 MB	
Memory		256 MB (768 MB Max.)	
Video Memory		UMA (64 MB Max.)	
LCD	Type	10.4 type (TFT)	
	Displayed Colors*1	256/65536/16M colors (640 x 480 dots/800 x 600 dots/1024x768 dots)	
External Display		256/65536/16M colors (640 x 480 dots/800 x 600 dots/1024x768 dots/1280x1024 dots)*2	
Hard Disk Drive		40 GB*3	
Keyboard		Windows keyboard (82 keys)	
Pointing Device		Touch Pad Touchscreen (Anti-Reflection, Stylus (included) touch capable)	
PC Card Slot		Two Type I or Type II, or one Type III	
	Allowable current (total for two slots)	3.3 V: 400 mA, 5 V: 400 mA	
RAM Module Slot*4		200-pin, SO-DIMM, 2.5 V, DDR-SDRAM, PC2100 Compliant	
Interface	Serial Port	Dsub 9-pin Male	
	Microphone Jack*5	Miniature jack, 3.5 DIA	
	Headphone Jack	Miniature jack, 3.5 DIA	
	USB Port	4-pin x 2, USB2.0	
	Modem	RJ-11 Data:56 kbps (V.92 & K56flex*6) FAX:14.4 kbps	
	LAN	RJ 45 IEEE 802.3 10Base-T, IEEE 802.3u 100Base-TX	
	Wireless LAN	802.11b	
	Expansion Bus Connector	Dedicated 100-pin female	
	External Antenna Connector	Dedicated 50 Ω coaxial connector x 2	
Speaker		Monaural Speaker	
Sound		AC '97 2.1 Compatible, 18 bits full duplex stereo	
Battery Pack		Li-ion 7.4 V, 6.6 Ah	
	Operating Time*7	 Approx. 4 hours - 7.5 hours*8 (Approx. 5.5 hours*9)  Approx. 4 hours - 8 hours*8 (Approx. 6 hours*9)	
	Charging Time*7	Power On	Approx. 7 h
		Power Off	Approx. 3.5 h
Clock Battery		Coin type lithium battery 3.0 V	
AC Adaptor*10		Input : 100 V - 240 V AC, 50 Hz / 60 Hz Output : 16.0 V DC, 2.5 A	
Power Consumption*11		Approx. 18 W*12 / Approx. 41 W (maximum when recharging in the ON state)	
Environment	In use	Temperature	5 °C to 35 °C {41 °F to 95 °F}
		Humidity	30% to 80% RH (No condensation)
	Not in use	Temperature	-20 °C to 60 °C {-4 °F to 140 °F}
		Humidity	30% to 90% RH (No condensation)
Physical Dimensions*13 (W X H X D)		271 mm X 49 mm X 216 mm {10.7 " X 1.93 " X 8.5 "}	
Weight*13		Approx. 2.0 kg {Approx. 4.5 lb.}	

*1 A 16M color display is achieved by using the dithering function.

 : 256 color depth and the resolution of 640 x 480 are not supported.

*2 Maximum resolution depends on the specifications of the external display.

 : 256 color depth and the resolution of 640 x 480 are not supported.

*3 1GB = 10⁹ bytes

*4 Only a RAM card designed for PC2100 can be added.

*5 Use only a monaural condenser microphone.

*6 The settings for the K56flex modem need to be changed according to the AT command.

*7 Varies depending on the usage conditions.

*8 Measured using BatteryMark™ Version 4.0.1 (LCD brightness: Maximum - Minimum)

*9 Measured using MobileMark™ 2002 (LCD brightness: 60 cd/m²)

*10 <Only for North America>

The AC adaptor is compatible with power sources up to 240 V AC adaptor.

This computer is supplied with a 125 V AC compatible AC cord.

*11 Approx. 0.7 W when the battery pack is fully charged (or not being charged) and the computer is off.

Approx. 1.5 W when the Wake up from LAN function has been enabled.

*12 Rated power consumption.

*13 The dimensions and weight do not include the hand strap.

Specifications

● Software

Model No.	CF-18BHAZXDM	CF-18BHAZXKM
Operating System	Microsoft® Windows® 2000 Professional with Service Pack3 (NTFS File System)	Microsoft® Windows® XP Professional with Service Pack1 (NTFS File System)
Utility Programs	Setup Utility DMI Viewer Adobe® Acrobat® Reader Intel® SpeedStep™ technology Applet Intel® PROSet WLAN Security Client Wireless LAN Switch Panasonic Hand Writing Software Keyboard Display Rotation Tool Hard Disk Data Erase Utility*	Setup Utility DMI Viewer Adobe® Acrobat® Reader Intel® PROSet WLAN Security Client Wireless LAN Switch Panasonic Hand Writing Software Keyboard Display Rotation Tool Hard Disk Data Erase Utility*

* The Product Recovery CD-ROM is required.

LIMITED WARRANTY

For U.S.A.

PANASONIC PERSONAL COMPUTER AND PERIPHERALS LIMITED WARRANTY

Panasonic Computer Solutions Company (referred to as "Panasonic") will repair this product (other than software, which is covered by a separate warranty) with new or rebuilt parts, free of charge in the U.S.A. for three (3) years from the date of original purchase in the event of a defect in materials or workmanship. This warranty includes the AC adaptor but excludes the batteries and all other options and accessories which are covered for a period of one (1) year from the date of purchase.

This warranty is extended solely to the original purchaser. A purchase receipt or other proof of date of original purchase will be required before warranty performance is rendered.

This warranty only covers failures due to defects in materials or workmanship which occur during normal use. It does not cover damage which occurs in shipment or failures which are caused by products not supplied by Panasonic, or failures which result from alteration, accident, misuse, introduction of liquid or other foreign matter into the unit, abuse, neglect, installation, maladjustment of consumer controls, improper maintenance, modification or service by anyone other than a Factory Service Center or authorized Panasonic Service Dealer, or damage that is attributable to acts of God.

Limits and Exclusions:

There are no other express warranties except as listed below.

PANASONIC SHALL NOT BE LIABLE FOR LOSS OF DATA OR OTHER INCIDENTAL OR CONSEQUENTIAL DAMAGES RESULTING FROM THE USE OF THIS PRODUCT, OR ARISING OUT OF ANY BREACH OF THIS WARRANTY. ALL EXPRESS AND IMPLIED WARRANTIES, INCLUDING THE WARRANTIES OF MERCHANTABILITY AND FITNESS FOR A PARTICULAR PURPOSE ARE LIMITED TO THE APPLICABLE WARRANTY PERIOD SET FORTH ABOVE. Some states do not allow the exclusion or limitation of incidental or consequential damages, or limitations on how long an implied warranty lasts, so the above limitations or exclusions may not apply to you.

This limited warranty gives you specific legal rights, and you may also have other rights which vary from state to state. If a problem with your product develops during or after the warranty period, you may contact our representatives at 1-800-LAPTOP5. If the problem is not handled to your satisfaction, then write to the Consumer Affairs Division at the address indicated below.

SOFTWARE LIMITED WARRANTY

Panasonic Computer Solutions Company (referred to as "Panasonic") warrants to you only that the disk(s) or other media on which the Programs are furnished will be free from defects in materials and workmanship under normal use for a period of sixty (60) days from the date of delivery thereof to you, as evidenced by your purchase receipt.

This is the only warranty Panasonic makes to you. Panasonic does not warrant that the functions contained in the Programs will meet your requirements or that the operation of the Programs will be uninterrupted or error free.

Panasonic's entire liability, and your exclusive remedy under this warranty shall be limited to the replacement, in the United States, of any defective disk or other media which is returned to Panasonic's Authorized Service Center, together with a copy of the purchase receipt, within the aforesaid warranty period.

Anything in the foregoing to the contrary notwithstanding, Panasonic shall have no obligation for any defects in the disk(s) or other media on which the Programs are furnished resulting from your storage thereof, or for defects that have been caused by operation of the disk(s) or other media otherwise than on the Product or in environmental conditions other than those specified by Panasonic by alteration, accident, misuse, abuse, neglect, mishandling, misapplication, installation, maladjustment of consumer controls, improper maintenance, modification of damage that is attributable to acts of God. In addition, Panasonic shall have no obligation for any defects in the disk(s) or other media if you have modified, or attempted to modify any Program.

DURATION OF IMPLIED WARRANTIES, IF ANY, IS LIMITED TO SIXTY (60) DAYS.

PANASONIC ASSUMES NO RISK OF AND SHALL NOT IN ANY CASE BE LIABLE FOR ANY DAMAGES, INCLUDING, WITHOUT LIMITATION, ANY SPECIAL, INCIDENTAL, CONSEQUENTIAL, OR PUNITIVE DAMAGES ARISING FROM BREACH OF WARRANTY OR CONTRACT, NEGLIGENCE OR ANY OTHER LEGAL THEORY, INCLUDING, WITHOUT LIMITATION LOSS OF GOODWILL, PROFITS OR REVENUE, LOSS OF USE OF THE PROGRAMS OR PRODUCTS OR ANY ASSOCIATED EQUIPMENT, COST OF CAPITAL, COST OF ANY SUBSTITUTE EQUIPMENT, FACILITIES, SERVICES, DOWNTIME COSTS, OR CLAIMS OF ANY PARTY DEALING WITH YOU FOR SUCH DAMAGES.

Some states do not allow the exclusion or limitation of incidental or consequential damages, or limitations on how long an implied warranty lasts, so the above limitations or exclusions may not apply to you.

This limited warranty gives you specific legal rights, and you may also have other rights which vary from state to state.

This Limited Warranty will be governed by the laws the State of New York, without regard to its conflict-of-laws rules.

* * *

To obtain service or technical assistance within the continental U.S.A. and Alaska.

DIAL TOLL FREE: 1-800-LAPTOP5

Correspondence requesting product information should be sent to:
Panasonic Computer Solutions Company
50 Meadowlands Parkway, Panazip 2F-5, Secaucus, NJ 07094

LIMITED WARRANTY

For Canada

PANASONIC COMPUTER AND PERIPHERALS LIMITED WARRANTY

Coverage – Panasonic Canada Inc. (“PCI”) warrants to you, the first end user customer, this computer product (excluding software media), when purchased from PCI or from a PCI authorized reseller, to be free from defects in materials and workmanship under normal use, subject to the terms set forth below, during the period of warranty coverage specified.

Scope of Coverage	Period of Coverage	Type of Failure Coverage
Whole Product (except Batteries), AC adaptor and CD-ROM (if factory installed)	Three (3) Years from Date of Original End User Customer Purchase	Defective Materials or Workmanship
Batteries, CD-ROM (unless factory installed), Port Replicator, Extra Memory Modules and all other Peripherals, Options and Accessories	One (1) Year from Date of Original End User Customer Purchase	Defective Materials or Workmanship

Remedy – In the event of a warranty claim, contact PCI’s representatives within the applicable warranty period, identifying the nature of the defect claimed, at 1-800-668-8386 between 9:00 A.M. and 5:00 P.M., Eastern Time Zone, Mon. – Fri. (excluding holidays) for instructions on how to obtain service. A purchase receipt or other proof of date of original purchase is required before warranty service is performed. Defective parts covered by this Limited Warranty will be repaired or replaced with new or comparable rebuilt parts on an exchange basis. Warranty replacement or repair is subject to the terms of this Limited Warranty for the balance of the original period of warranty coverage.

No Coverage – This Limited Warranty does not cover products purchased outside Canada. Neither does it cover damage to, failure of, or defects in a product or accessory through mishandling, improper installation, abnormal use, misuse, neglect, accident, introduction of liquid or other foreign matter into the product, alteration or servicing by anyone not authorized by PCI, or act of God.

IF YOU SHIP THE PRODUCT FOR WARRANTY SERVICE

Carefully pack the product, preferably in the original carton. Include details of defect claimed and proof of date of original purchase. No liability is assumed for loss or damage to the product while in transit, if you chose your own transportation carrier.

SOFTWARE MEDIA LIMITED WARRANTY

Coverage – Panasonic Canada Inc. (“PCI”) warrants to you, the first end user customer, that the disk(s) or other media on which software program(s) is/are supplied will be free from defects in materials and workmanship under normal use in Canada for a period of sixty (60) days from date of receipt as evidenced by your purchase receipt for your Panasonic Computer product.

THIS IS THE ONLY WARRANTY THAT PCI MAKES RESPECTING THE SOFTWARE MEDIA. PCI does not warrant the software. Please refer to the software licensor’s written warranty (accompanying the copy of the software) for any software warranty claim.

Claim Procedure – In the event of a defect in material or workmanship in the media during the sixty (60) day warranty period, and you return it, transportation costs prepaid, to Panasonic Canada Inc., Computer Products Marketing, at the above address, within the warranty period, together with a copy of your purchase receipt, and an explanation of the suspected defect, PCI will replace in Canada the defective disk(s) or other media.

Remedy – PCI’s entire liability, and your only remedy for any breach of this software media warranty is limited to replacement of the media only. It does not cover any other damages, including, but not limited to, loss of use or profit loss, or special, indirect or consequential damages, or other claims, whether or not of similar character.

No Coverage – This limited warranty does not apply if the disk(s) or other media has been used in other than a Panasonic product, or in environmental conditions other than those specified by PCI or the manufacturer, or if subjected to misuse, neglect, mishandling, modification or attempted modification of the program, or if damaged by accident or act of God. PCI is not responsible for damage to or loss of any program, data or removable storage media.

GENERAL

NO OTHER WARRANTIES – PCI DISCLAIMS ALL OTHER WARRANTIES, EITHER EXPRESS OR IMPLIED, INCLUDING, BUT NOT LIMITED TO, IMPLIED WARRANTIES OF MERCHANTABILITY AND FITNESS FOR A PARTICULAR PURPOSE, WITH RESPECT TO THE SOFTWARE, SOFTWARE MEDIA, COMPUTER PRODUCT, OPTIONS AND ACCESSORIES.

NO LIABILITY FOR CONSEQUENTIAL DAMAGES – IN NO EVENT SHALL PCI BE LIABLE FOR ANY SPECIAL, INDIRECT OR CONSEQUENTIAL DAMAGES ARISING FROM ANY BREACH OF THE LIMITED WARRANTIES SET OUT IN THIS DOCUMENT, OR FROM THE USE OF THE COMPUTER PRODUCT, INCLUDING, WITHOUT LIMITATION, LOSS OF DATA, BUSINESS, PROFIT OR GOODWILL.

IN ANY EVENT, PCI’S MAXIMUM LIABILITY FOR ANY BREACH SHALL NOT EXCEED THE AMOUNT ACTUALLY PAID BY YOU FOR THE COMPUTER PRODUCT.

NO ACTION, REGARDLESS OF ITS BASIS, MAY BE BEGUN AGAINST PCI MORE THAN TWO (2) YEARS AFTER THE CAUSE OF ACTION AROSE.

Statutory Warranties – Some jurisdictions do not allow these limitations or exclusions, so they may not apply to you.



As an ENERGY STAR® Partner, Matsushita Electric Industrial Co., Ltd. has determined that this product meets the ENERGY STAR® guidelines for energy efficiency.

Outline of the International ENERGY STAR® Office Equipment Program

The international ENERGY STAR® Office Equipment Program is an international program that promotes energy saving through the use of computers and other office equipment. The program backs the development and dissemination of products with functions that effectively reduce energy consumption. It is an open system in which business proprietors can participate voluntarily. The targeted products are office equipment such as computers, displays, printers, facsimiles, and copiers. Their standards and logos are uniform among participating nations.

Panasonic Computer Solutions Company

50 Meadowlands Parkway, Panazip 2F-5,
Secaucus, NJ 07094

Panasonic Canada Inc.

5770 Ambler Drive Mississauga,
Ontario L4W 2T3

