



Panasonic®

OPERATING INSTRUCTIONS

Personal Computer

Model No. **CF-18 Series**

TOUGHBOOK

Tablet PC

Contents

Getting Started

Read Me First	3
Names and Functions of Parts	9
First-time Operation	13

Reference Manual

- Read Me First
- Key Combinations
- LED Indicators

Operation

Starting Up/Shutting Down	17
Touch Pad (Basic Operation)	20
Digitizer (Basic Operation)	21
Operating in Tablet Mode	22
Reference Manual	24
Useful Information	25

Reference Manual

- Tablet Buttons
- Touch Pad
- Digitizer (Advanced)
- Display Rotation
- Standby/Hibernation Functions
- Security Measures
- Computing on the Road
- Battery Power
- PC Cards
- SD Memory Card
- SD Memory Card Security Function
- RAM Module
- Port Replicator
- External Display
- USB Devices
- Modem
- LAN
- Wireless LAN
- Bluetooth
- Wireless Switch Utility
- Hard Disk Drive
- Setup Utility
- Icon Enlarger
- Loupe Utility

Troubleshooting

List of Error Codes	29
Dealing with Problems (Summary)	30
Reinstalling Software	35

Reference Manual

- Technical Information
- DMI Viewer
- List of Error Codes
- Dealing with Problems (Advanced)

Appendix

LIMITED USE LICENSE AGREEMENT	37
Hard Disk Backup Function	39
Hard Disk Data Erase Utility	43
Specifications	44
LIMITED WARRANTY	46

[Additional Manual]

Reference Manual

This manual can be accessed on your computer. Refer to page 24 on how to access the Reference Manual.

Getting Started

Operation

Troubleshooting

Appendix

Customer's Record

Model No.* _____	Dealer's Name _____
Serial No. _____	_____
or	
Code No. _____	Dealer's Address _____
Date of Purchase _____	_____

* For the Model No., insert the 12 digit number (for example, CF-18KDHZXVM) located on the bottom of the computer.

Introduction

Thank you for purchasing the Panasonic computer. Read the operating instructions thoroughly for proper operation of your new computer.

Illustrations and Terminology in this Manual

NOTE:

NOTE provides a useful fact or helpful information.

CAUTION:

CAUTION indicates a condition that may result in minor or moderate injury.

 : This illustration means to press the [Enter] key.

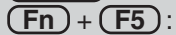
 : This illustration means to press and hold the [Fn] key, then press the [F5] key.

[start] - [Run]: This illustration means to click [start], then to click [Run]. For some applications, you may need to double-click.

 : Where to go for referred information.

 : This illustration means to refer to the Reference Manual, which is available on your computer. Refer to page 24 on how to access this manual.

- Some of the illustrations in this manual may differ slightly in shape from the actual items in order to make the explanation easier to understand.
- The “CD/DVD drive” is a description about drives, such as DVD-ROM, CD-ROM, CD-R/RW, and DVD-ROM & CD-R/RW drives.
- In this manual, descriptions are given using illustrations not featuring the hand strap for convenience of explanation.
- If the user has logged on without administrator authority, some functions may not be executable, and some screens may not be displayed as shown in this manual. If this happens, log on with the administrator authority to enable these functions.
- Confirm the latest information on optional products in catalogs, etc.
- In this manual, “Microsoft® Windows® XP Tablet PC Edition 2005” is indicated as “Windows” or “Windows XP”.

Copyright

This manual is copyrighted by Matsushita Electric Industrial Co., Ltd. with all rights reserved. No part of this manual may be reproduced in any form without the prior written permission of Matsushita Electric Industrial Co., Ltd.

No patent liability is assumed with respect to the use of the information contained herein.

© 2005 Matsushita Electric Industrial Co., Ltd. All Rights Reserved.

Disclaimer

Computer specifications and manuals are subject to change without notice. Matsushita Electric Industrial Co., Ltd. assumes no liability for damage incurred directly or indirectly from errors, omissions or discrepancies between the computer and the manuals.

Trademarks

Microsoft, Windows, the Windows logo and IntelliMouse are registered trademarks of Microsoft Corporation of the United States and/or other countries.

Intel, Pentium and PROSet are either registered trademarks or trademarks of Intel Corporation.

SD Logo is a trademark. 

Adobe, the Adobe logo and Adobe Reader are either registered trademarks or trademarks of Adobe Systems Incorporated in the United States and/or other countries.

Bluetooth is a trademark owned by Bluetooth SIG, Inc., U.S.A. and licensed to Matsushita Electric Industrial Co., Ltd.

Panasonic is a registered trademark of Matsushita Electric Industrial Co., Ltd.

Names of products, brands, etc., appearing in this manual are trademarks or registered trademarks of the respective owner companies.

Read Me First

For U.S.A.

Federal Communications Commission Radio Frequency Interference Statement

Note: This equipment has been tested and found to comply with the limits for a Class B digital device, pursuant to Part 15 of the FCC Rules. These limits are designed to provide reasonable protection against harmful interference in a residential installation. This equipment generates, uses and can radiate radio frequency energy and, if not installed and used in accordance with the instructions, may cause harmful interference to radio communications. However, there is no guarantee that interference will not occur in a particular installation. If this equipment does cause harmful interference to radio or television reception, which can be determined by turning the equipment off and on, the user is encouraged to try to correct the interference by one or more of the following measures:

- Reorient or relocate the receiving antenna.
- Increase the separation between the equipment and receiver.
- Connect the equipment into an outlet on a circuit different from that to which the receiver is connected.
- Consult the Panasonic Service Center or an experienced radio/TV technician for help.

Warning

To assure continued compliance, use only shielded interface cables when connecting to a computer or peripheral. Also, any changes or modifications not expressly approved by the party responsible for compliance could void the user's authority to operate this equipment.

FCC RF Exposure Warning:

- This equipment is provided with PC Card slot that could be used with wireless transmitters, which will be specifically recommended when they become available. Other third-party wireless transmitters have not been RF exposure evaluated for use with this computer and may not comply with FCC RF exposure requirements.

<Only for models with wireless LAN and/or Bluetooth>

- This equipment complies with FCC radiation exposure limits set forth for an uncontrolled environment.
- This equipment has been approved for portable operation, and unless otherwise advised in separate supplemental instructions for individual wireless transmitter(s), requires minimum 1.5 cm spacing be provided between antenna(s) and all person's body (excluding extremities of hands, wrist and feet) during wireless modes of operation.
- This equipment may use multiple installed transmitters, which may be capable of simultaneous transmission.
- This equipment is provided with external antenna connector(s) for connection to optional Car Mounter or Port Replicator for mobile external mounted antenna(s). External antenna(s) must be professionally installed and cannot exceed recommended maximum antenna gain as described in individual provided supplement instructions for wireless transmitters. Also, user must maintain minimum 20 cm spacing between external antenna(s) and all person's body (excluding extremities of hands, wrist and feet) during wireless modes of operation.

<Only for models with wireless LAN>

This product is restricted to indoor use due to its operation in the 5.15 to 5.25 GHz frequency range.

FCC requires this product to be used indoors for the frequency range 5.15 to 5.25 GHz to reduce the potential for harmful interference to co-channel Mobile Satellite systems.

High power radars are allocated as primary users of the 5.25 to 5.35 GHz and 5.65 to 5.85 GHz bands. These radar stations can cause interference with and /or damage this product.

This device complies with Part 15 of the FCC Rules. Operation is subject to the following two conditions:

- (1) This device may not cause harmful interference, and
- (2) This device must accept any interference received, including interference that may cause undesired operation.

Responsible Party: Panasonic Corporation of North America
One Panasonic Way
Secaucus, NJ 07094
Tel No: 1-800-LAPTOP5 (1-800-527-8675)

FCC Regulation Notice for modem This equipment contains a FCC approved modem.

FC Tested To Comply
With FCC Standards
FOR HOME OR OFFICE USE

1. This equipment complies with CFR47 Part 68 rules. On the computer is a label that contains, among other information, the FCC registration number and ringer equivalence number (REN) for this equipment. If required, this information must be provided to the telephone company.
2. An FCC compliant telephone cord and modular plug is provided with this equipment. This equipment is designed to be connected to the telephone network or premises wiring using a compatible modular jack which is Part 68 compliant. See Installation Instructions for details.
3. The REN is used to determine the quantity of devices which may be connected to the telephone line. Excessive RENs on the telephone line may result in the devices not ringing in response to an incoming call. In most, but not all area, the sum of RENs should not exceed five (5.0). To be certain of the number of devices that may be connected to a line, as determined by the total RENs, contact the local telephone company.
4. If your telephone equipment cause harm to the telephone network, the telephone company will notify you in advance that temporary discontinuance of service may be required. But if advance notice isn't practical, the telephone company will notify the customer as soon as possible. Also, you will be advised of your right to file a complaint with the FCC if you believe it is necessary.
5. The telephone company may take changes in its facilities, equipment, operations or procedures that could affect the operation of the equipment. If this happens the telephone company will provide advance notice in order for you to make necessary modifications to maintain uninterrupted service.
6. If trouble is experienced with this equipment, for repair or warranty information, please contact Panasonic Corporation of North America at DIAL TOLL FREE 1-800-LAPTOP5 (1-800-527-8675). If the equipment is causing harm to the telephone network, the telephone company may request that you disconnect the equipment until the problem is resolved.
7. There are no user serviceable parts contained in this equipment.
8. This equipment may not be used on coin service provided by the telephone company. Connection to party lines is subject to state tariffs.

Read Me First

9. The Telephone Consumer Protection Act of 1991 makes it unlawful for any person to use a computer or other electronic device to send any message via a telephone fax machine unless such message clearly contains in a margin at the top or bottom of each transmitted page or on the first page of the transmission, the date and time it is sent and an identification of the business or other entry, or other individual sending the message and the telephone number of the sending machine or such business, other entity, or individual. In order to program this information into your fax software, you should refer to the manual of the Fax software being used.
10. According to the FCC's electrical safety advisory, we recommend that you may install an AC surge arrestor in the AC outlet to which this equipment is connected. Telephone companies report that electrical surges, typically lightning transients, are very destructive to customer terminal equipment connected to AC power sources and that this is a major nationwide problem.

“Caution: To reduce the risk of fire, use only No.26 AWG or larger telecommunication line cord.”

“ATTENTION: Pour réduire le risque d'incendie, utiliser uniquement des conducteurs de télécommunications 26 AWG ou de section supérieure.”

For Canada

Industry Canada (IC) Notice for modem

This equipment contains an Industry Canada approved modem unit. The Industry Canada label is affixed on the modem unit.

EQUIPMENT ATTACHMENT LIMITATIONS

“NOTICE: The Industry Canada label identifies certified equipment. This certification means that the equipment meets telecommunications network protective, operational and safety requirements as prescribed in the appropriate Terminal Equipment Technical Requirements document(s). The Department does not guarantee the equipment will operate to the user's satisfaction.

Before installing this equipment, users should ensure that it is permissible to be connected to the facilities of the local telecommunications company. The equipment must also be installed using an acceptable method of connection. The customer should be aware that compliance with the above conditions may not prevent degradation of service in some situations.

Repairs to certified equipment should be coordinated by a representative designated by the supplier. Any repairs or alterations made by the user to this equipment, or equipment malfunctions, may give the telecommunications company cause to request the user to disconnect the equipment.

Users should ensure for their own protection that the electrical ground connections of the power utility, telephone lines and internal metallic water pipe system, if present, are connected together. This precaution may be particularly important in rural areas. Caution: Users should not attempt to make such connections themselves, but should contact the appropriate electric inspection authority, or electrician, as appropriate.”

“NOTICE: The Ringer Equivalence Number (REN) assigned to each terminal device provides an indication of the maximum number of terminals allowed to be connected to a telephone interface. The termination on an interface may consist of any combination of devices subject only to the requirement that the sum of the Ringer Equivalence Numbers of all the devices does not exceed 5.”

REN: See bottom of the computer

Notice for the products using LCD

This product uses one or more fluorescent lamps containing a small amount of mercury. It also contains lead in some components. Disposal of these materials may be regulated in your community due to environmental considerations. For disposal or recycling information please contact your local authorities, or the Electronics Industries Alliance: <<http://www.eiae.org/>>

UL1604-conforming model. (The model which has description of “UL1604” in the bottom of the computer.)

- THIS EQUIPMENT IS SUITABLE FOR USE IN CLASS I, DIVISION 2, GROUPS A, B, C AND D OR NON-HAZARDOUS LOCATIONS ONLY.
- WARNING – EXPLOSION HAZARD – SUBSTITUTION OF COMPONENTS MAY IMPAIR SUITABILITY FOR CLASS I, DIVISION 2.
- When connecting and using a device manufactured by a third party, enquire to the manufacturer as to whether the device suits CLASS I, DIVISION 2.

RESTRICTIONS CONCERNANT LE RACCORDEMENT DE MATÉRIEL

“AVIS: L'étiquette d'Industrie Canada identifie le matériel homologué. Cette étiquette certifie que le matériel est conforme aux normes de protection, d'exploitation et de sécurité des réseaux de télécommunications, comme le prescrivent les documents concernant les exigences techniques relatives au matériel terminal. Le Ministère n'assure toutefois pas que le matériel fonctionnera à la satisfaction de l'utilisateur.

Avant d'installer ce matériel, l'utilisateur doit s'assurer qu'il est permis de le raccorder aux installations de l'entreprise locale de télécommunication. Le matériel doit également être installé en suivant une méthode acceptée de raccordement. L'abonné ne doit pas oublier qu'il est possible que la conformité aux conditions énoncées ci-dessus n'empêche pas la dégradation du service dans certaines situations.

Les réparations de matériel homologué doivent être coordonnées par un représentant désigné par le fournisseur. L'entreprise de télécommunications peut demander à l'utilisateur de débrancher un appareil à la suite de réparations ou de modifications effectuées par l'utilisateur ou à cause de mauvais fonctionnement.

Pour sa propre protection, l'utilisateur doit s'assurer que tous les fils de mise à la terre de la source d'énergie électrique, des lignes téléphoniques et des canalisations d'eau métalliques, s'il y en a, sont raccordés ensemble. Cette précaution est particulièrement importante dans les régions rurales. Avertissement: L'utilisateur ne doit pas tenter de faire ces raccordements lui-même; il doit avoir recours à un service d'inspection des installations électriques, ou à un électricien, selon le cas.”

“AVIS: L'indice d'équivalence de la sonnerie (IES) assigné à chaque dispositif terminal indique le nombre maximal de terminaux qui peuvent être raccordés à une interface. La terminaison d'une interface téléphonique peut consister en une combinaison de quelques dispositifs, à la seule condition que la somme d'indices d'équivalence de la sonnerie de tous les dispositifs n'excède pas 5.”

IES: Voir sous le fond de l'ordinateur

<Only for models with wireless LAN/GPS>

Industry Canada

This product complies with RSS210 Industry Canada.

Operation is subject to the following two conditions;

- (1) this device may not cause interference, and
- (2) this device must accept any interference, including interference that may cause undesired operation of the device.

<Only for models with wireless LAN>

This product (local network devices) for the band 5150-5250 MHz is only for indoor usage to reduce potential for harmful interference to co-channel Mobile Satellite systems.

High power radars are allocated as primary users (meaning they have priority) of 5250-5350 MHz and 5650-5850 MHz and these radars could cause interference and/or damage to LELAN devices.

CSA C22 2 NO.213-conforming model. (The model which has description of “CSA C22 2 NO.213” in the bottom of the computer.)

- THIS EQUIPMENT IS SUITABLE FOR USE IN CLASS I, DIVISION 2, GROUPS A, B, C AND D OR NON-HAZARDOUS LOCATIONS ONLY.
- WARNING – EXPLOSION HAZARD – SUBSTITUTION OF COMPONENTS MAY IMPAIR SUITABILITY FOR CLASS I, DIVISION 2.
- When connecting and using a device manufactured by a third party, enquire to the manufacturer as to whether the device suits CLASS I, DIVISION 2.

<Only for models with Bluetooth>

This Class B digital apparatus complies with Canadian ICES-003.

Cet appareil numérique de la classe B est conforme à la norme NMB-003 du Canada.

For Europe

(For models with a “CE” mark on the bottom of the computer)



Declaration of Conformity (DoC)

“Hereby, we declare that this Personal Computer is in compliance with the essential requirements and other relevant provisions of the Directive 1999/5/EC.”

Hint:

If you want to get a copy of the original DoC of our products which relates to the R&TTE, please contact our web address: <http://www.doc.panasonic.de>

Contact:

Panasonic Services Europe

A Division of Panasonic Marketing Europe GmbH

Panasonic Testing Centre

Network connection.

The terminal equipment is intended for connection to the following public network;

In all the countries of European Economical Area;

- Public Switched Telephony Networks

Technical Features.

The terminal equipment includes the following features;

- DTMF dialing
- Maximum bitrate receiving mode: 56 kbit/s
- Maximum bitrate sending mode: 33.6 kbit/s

This product is designed to interwork with the Public Switched Telecommunication Networks in UK, Ireland, Netherlands, Sweden, Denmark, Finland, Switzerland, Luxembourg, Belgium, France, Germany, Spain, Portugal, Iceland, Greece, Italy, Norway and Austria.

Compliance Notice - CE Mark

This equipment is in conformance with the requirements of the European Council Directive listed below:

73/23/EEC Low Voltage Directive with amendment 93/68/EEC

89/336/EEC EMC Directive with amendments 92/31/EEC and 93/68/EEC

1999/5/EC R&TTE

Read Me First

For France and Italy

<Only for models with Bluetooth>

Communication using Bluetooth outdoor is against the law.

Do not use Bluetooth outdoors.

Important Safety Instructions / Importantes Mesures De Sécurité

When using your telephone equipment, basic safety precautions should always be followed to reduce the risk of fire, electric shock and injury to persons, including the following:

1. Do not use this product near water, for example, near a bath tub, washbowl, kitchen sink or laundry tub, in a wet basement or near a swimming pool.
2. Avoid using a telephone (other than a cordless type) during an electrical storm. There may be a remote risk of electric shock from lightning.
3. Do not use the telephone to report a gas leak in the vicinity of the leak.
4. Use only the power cord and batteries indicated in this manual. Do not dispose of batteries in a fire. They may explode. Check with local codes for possible special disposal instructions.

SAVE THESE INSTRUCTIONS

Certaines mesures de sécurité doivent être prises pendant l'utilisation de matériel téléphonique afin de réduire les risques d'incendie, de choc électrique et de blessures. En voici quelquesunes:

1. Ne pas utiliser l'appareil près de l'eau, p.ex., près d'une baignoire, d'un lavabo, d'un évier de cuisine, d'un bac à laver, dans un sous-sol humide ou près d'une piscine.
2. Éviter d'utiliser le téléphone (sauf s'il s'agit d'un appareil sans fil) pendant un orage électrique. Ceci peut présenter un risque de choc électrique causé par la foudre.
3. Ne pas utiliser l'appareil téléphonique pour signaler une fuite de gaz s'il est situé près de la fuite.
4. Utiliser seulement le cordon d'alimentation et le type de piles indiqués dans ce manuel. Ne pas jeter les piles dans le feu: elles peuvent exploser. Se conformer aux règlements pertinents quant à l'élimination des piles.

CONSERVER CES INSTRUCTIONS

Information to the User

<Only for models with wireless LAN and/or Bluetooth>

This product and your Health

This product, like other radio devices, emits radio frequency electromagnetic energy. The level of energy emitted by this product however is far much less than the electromagnetic energy emitted by wireless devices like for example mobile phones.

Because this product operates within the guidelines found in radio frequency safety standards and recommendations, we believe this product is safe for use by consumers. These standards and recommendations reflect the consensus of the scientific community and result from deliberations of panels and committees of scientists who continually review and interpret the extensive research literature.

In some situations or environments, the use of this product may be restricted by the proprietor of the building or responsible representatives of the organization. These situations may for example include:

- Using this product on board of airplanes, or
- In any other environment where the risk of interference to other devices or services is perceived or identified as harmful.

If you are uncertain of the policy that applies on the use of wireless devices in a specific organization or environment (e.g. airports), you are encouraged to ask for authorization to use this product prior to turning on the product.

Regulatory Information

We are not responsible for any radio or television interference caused by unauthorized modification of this product. The correction of interference caused by such unauthorized modification will be the responsibility of the user. We and its authorized resellers or distributors are not liable for damage or violation of government regulations that may arise from failing to comply with these guidelines.

Lithium Battery

Lithium Battery!

This computer contains a lithium battery to enable the date, time, and other data to be stored. The battery should only be exchanged by authorized service personnel.

Warning! A risk of explosion from incorrect installation or misapplication may possibly occur.

Pile au lithium!

Le micro-ordinateur renferme une pile au lithium qui permet de sauvegarder certaines données, notamment la date et l'heure. La pile ne doit être remplacée que par un technicien qualifié.

Danger! Risque d'explosion en cas de non respect de cette mise en garde!

Precautions

The CF-18 was developed based on thorough research into the real-world portable computing environments. Exhaustive pursuit of usability and reliability under harsh conditions led to innovations such as the magnesium alloy exterior, vibration damped hard disk drive and floppy disk drive, flexible internal connections. The CF-18's outstanding engineering has been tested using the strict MIL-STD- 810F (for vibration and shock) and IP (for dust and water) based procedures.

As with any portable computer device precautions should be taken to avoid any damage. The following usage and handling procedures are recommended.

Before putting the computer away, be sure to wipe off any moisture.

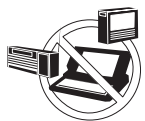

Avoid Radio Frequency Interference

Do not place the computer near a television or radio receiver.



Avoid Magnetic Fields

Keep the computer away from magnets. Data stored on the hard disk may be lost.



Keep Small Objects Away

Do not insert paper clips or other small objects into the computer.



Do Not Disassemble the Computer

Do not attempt to disassemble your computer.



Avoid Excessive Force on the Display

Do not apply excessive downward force on the display when it is completely opened, especially when plugs and/or cables are connected to the rear of the computer.



Avoiding Low-temperature Burns

Avoid more than casual contact with any heat producing area of the notebook computer, AC adaptor, and any option or accessory you use with it. Even low heat (warmer than body temperature), can cause a burn if the skin is exposed to the heat source for a long period of time.



Do not touch the computer and cable when it starts thundering



Do not connect a telephone line, or a network cable other than the one specified, into the LAN port

If the LAN port is connected to a network such as the ones listed below, a fire or electric shock may result.

- Networks other than 100BASE-TX or 10BASE-T
- Phone lines (Telephone lines, internal phone lines (on-premise switches), digital public phones, etc.)



Keep SD Memory Cards away from infants and small children

Accidental swallowing will result in bodily injury. In the event of accidental swallowing, see a doctor immediately.

Precautions (Battery Pack)

- Care should be exercised with regard to the following in order to avoid the possibility of overheating, fire or damage.



Avoid Heat

Do not throw the battery pack into a fire or expose it to excessive heat.



Keep Articles Away

Do not place the battery pack together with articles such as necklaces or hairpins when carrying or storing.



Do Not Disassemble

Do not insert sharp objects into the battery pack, expose it to bumps or shocks, deform, disassemble, or modify it.



Do Not Short

Do not short the positive (+) and negative (-) contacts.



Avoid Extreme Heat, Cold and Direct Sunlight

Do not charge, use or leave the battery pack for extended periods where it will be exposed to direct sunlight, in a hot place (in a car on a sunny day, for example), or in a cold place.



Do Not Put into a Microwave

Do not put the battery pack into a microwave oven or a pressurized chamber.



Stop Using

Should the battery emit an abnormal odor, become hot to the touch, become discolored, change shape, or become in any way different from normal, remove it from the computer or charger and stop using it.



Do Not Use With Any Other Computer

The battery pack is rechargeable and was intended for the specified computer or charger. Do not use it with a computer other than the one for which it was designed.



Do not use this computer with a battery pack other than the one specified (the one included with the computer or the specified battery pack sold separately)

- Do not touch the terminals on the battery pack. The battery pack may no longer function properly if the contacts are dirty or damaged.
- Do not expose the battery pack to water, or allow it to become wet.

Read Me First

Precautions (Battery Pack)

- If the battery pack will not be used for a long period of time (a month or more), charge or discharge (use) the battery pack until the remaining battery level becomes 30% to 40% and store it in a cool, dry place.
- This computer prevents overcharging of the battery by recharging only when the remaining power is less than approx. 95% of capacity.
- The battery pack is not charged when the computer is first purchased. Be sure to charge it before using it for the first time. When the AC adaptor is connected to the computer, charging begins automatically.
- Should the battery leak and the fluid get into your eyes, do not rub your eyes. Immediately flush your eyes with clear water and see a doctor for medical treatment as soon as possible.

NOTE

- The battery pack may become warm during recharging or normal use. This is completely normal.
- Recharging will not commence if internal temperature of the battery pack is outside of the allowable temperature range (0 °C to 50 °C {32°F to 122 °F}) (☞ Reference Manual “Battery Power”). Once the allowable range requirement is satisfied, charging begins automatically. Note that the recharging time varies based on the usage conditions. (Recharging takes longer than usual when the temperature is 10 °C {50 °F} or below.)
- If the temperature is low, the operating time is shortened. Only use the computer within the allowable temperature range.
- This computer has a high temperature mode function that prevents the degradation of the battery in high temperature environments. (☞ Reference Manual “Battery Power”) A level corresponding to a 100% charge for high temperature mode is approximately equivalent to an 80% charge level for normal temperature mode.
- The battery pack is a consumable item. If the amount of time the computer can be run by using a particular battery pack becomes dramatically shorter and repeated recharging does not restore its performance, the battery pack should be replaced with a new one.
- When transporting a spare battery inside a package, briefcase, etc., it is recommended that it be placed in a plastic bag so that its contacts are protected.
- Always power off the computer when it is not in use. Leaving the computer on when the AC adaptor is not connected will exhaust the remaining battery capacity.

For Used in Motor Vehicle / Pour L'utilisation Dans Un Véhicule Motorisé

Warning: Notebook Computer may be installed in a motor vehicle and visible to the driver only if used to support vehicle related functions such as vehicle information, system control, rear or side observation and navigation. If used for entertainment purpose, such as television reception or video play, it must be installed to the rear of the driver's seat where it will not be visible, directly or indirectly, to the operator of the motor vehicle. Check with individual state/provincial laws to determine lawful use of this product while operating within a motor vehicle.

Avertissement: L'ordinateur bloc-notes peut être installé dans un véhicule motorisé et dans le champ de vision du conducteur uniquement en tant que dispositif d'aide aux fonctions du véhicule, comme par exemple pour fournir des informations sur le véhicule, comme dispositif de contrôle de système, pour l'observation à l'arrière ou sur les côtés du véhicule, ainsi que pour fournir de l'information routière. Pour toute utilisation à fin de divertissement, comme par exemple pour regarder la télévision ou jouer à des jeux vidéo, il doit être installé à l'arrière du siège du conducteur, en un emplacement où il ne sera pas visible, ni directement ni indirectement, pour le conducteur du véhicule motorisé. Vérifiez les lois fédérales et nationales qui régissent l'utilisation légale de cet appareil à l'intérieur d'un véhicule motorisé.

Names and Functions of Parts

The illustrations shown may differ from the actual physical appearances.

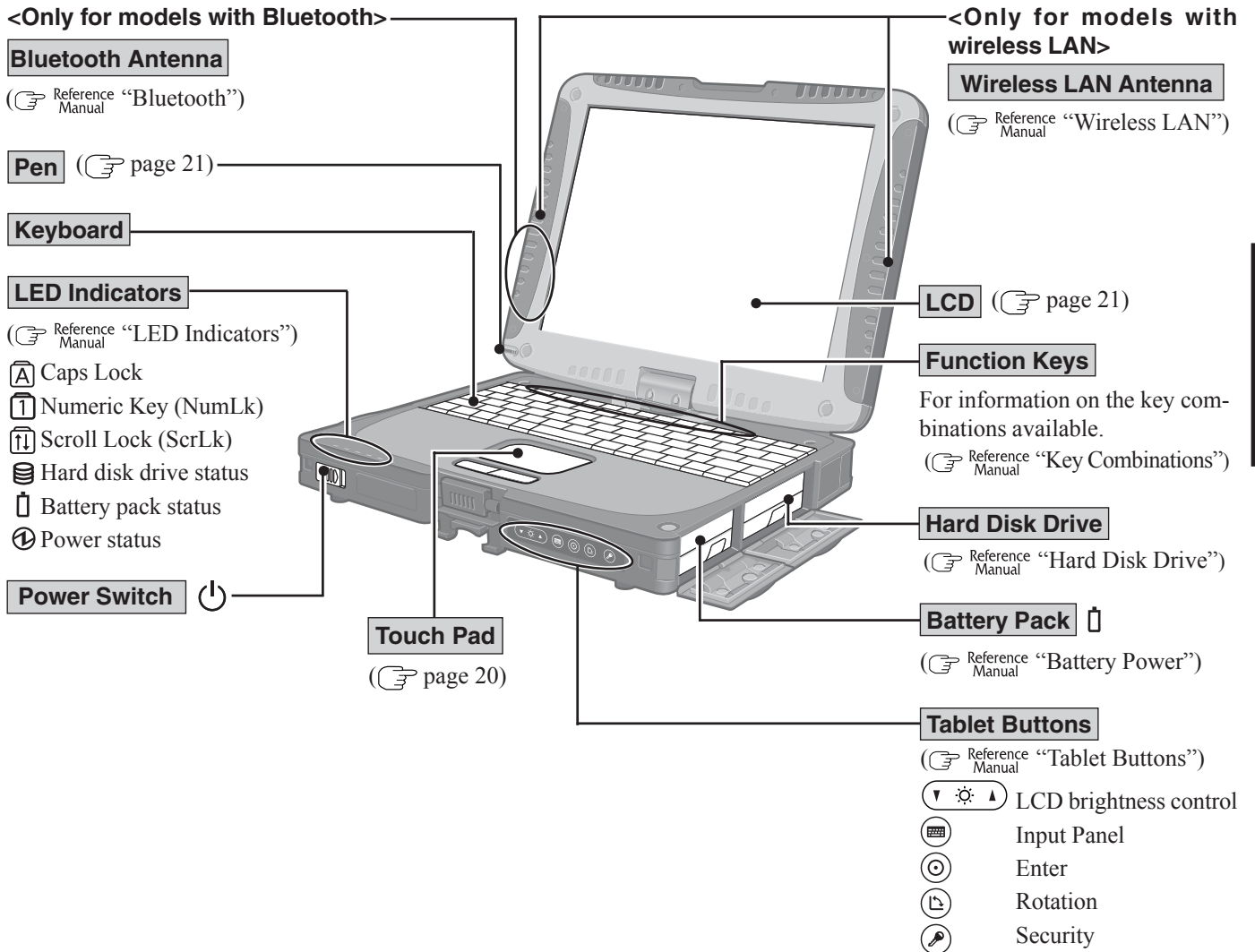

CAUTION

- Do not cover the computer with a thick cloth, such as a blanket.



A lithium ion battery that is recyclable powers the product you have purchased. Please call 1-800-8-BATTERY for information on how to recycle this battery.

L'appareil que vous vous êtes procuré est alimenté par une batterie au lithium-ion. Pour des renseignements sur le recyclage de la batterie, veuillez composer le 1-800-8-BATTERY.

Names and Functions of Parts

Security Lock LOCK

A cable can be connected. For more information, read the manual provided with the cable.

Microphone Jack 

Use only a monaural condenser microphone (miniature jack). Using an input source other than a monaural condenser microphone may not allow audio to be input or may damage the equipment.

Headphone Jack 

Use this jack to connect headphones or amplifier-equipped speakers. Audio output from the internal speaker is disabled when headphones or external speakers are connected.

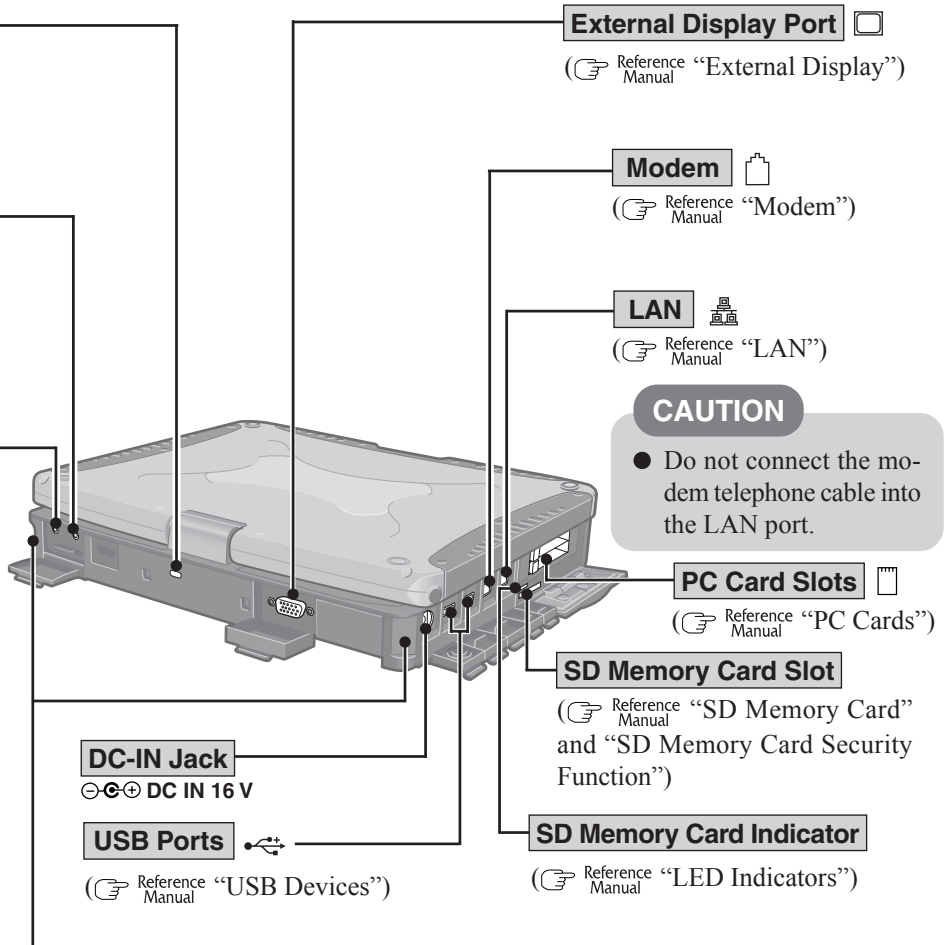

CAUTION

- Do not connect the modem telephone cable into the LAN port.

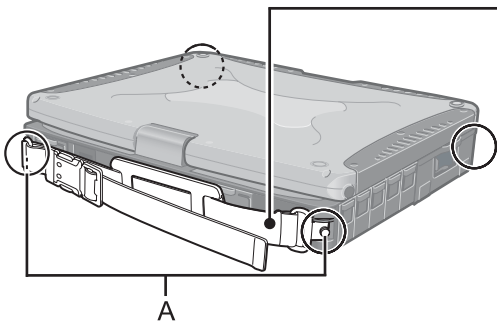

(The above illustration shows the position where the hand strap is attached at the factory.)

Hand Strap

The hand strap can be attached to any two of the four corners using screws (A) which were used to attach the hand strap. Adjust the length of the belt so that the computer does not fall by mistake, and firmly hold the computer when using it.

CAUTION

- The strap has been designed to carry only the weight of the computer. Therefore, be sure that the strap does not carry a weight that exceeds the weight of the computer. The strap may accidentally come loose from the computer.
- Do not use a strap that is damaged or about to tear.

Shoulder Strap

The shoulder strap can be connected to the hand strap to make it longer.

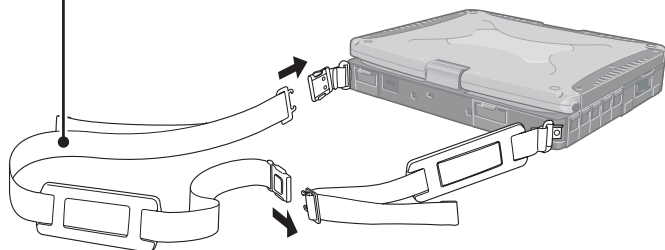

CAUTION

- Do not allow metallic objects or magnetic media to come near these areas.

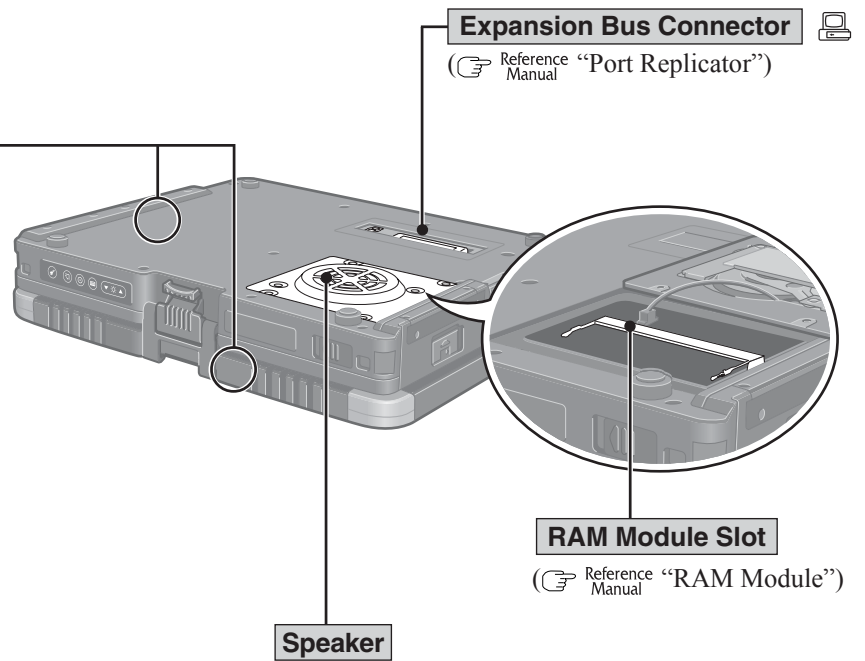

- To adjust the volume:
 $\text{Fn} + \text{F5} / \text{Fn} + \text{F6}$
- Speaker on/off : $\text{Fn} + \text{F4}$

CAUTION

- Do not allow metallic objects or magnetic media to come near the speaker on the bottom surface of the computer.
 - Because the speaker contains a magnet, metal objects may become attached to the bottom surface of the computer. This may cause the computer to be unstable, or may mark the surface of the desk on which it is sitting.
 - If floppy disks, magnetic memory cards, or other magnetic media approach the speaker, there is a risk that data will be destroyed.

Names and Functions of Parts

Using the Tether

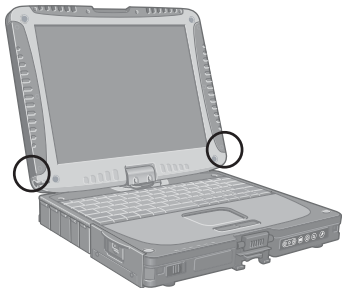

The tether can be attached to the bottom right or bottom left corner of the display. It prevents the pen (included) from falling accidentally.

Attaching the Tether

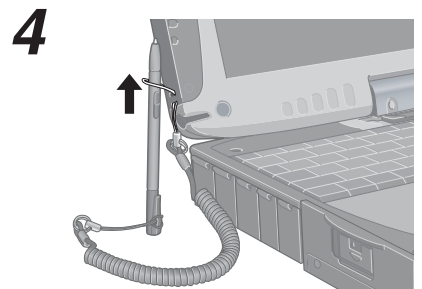
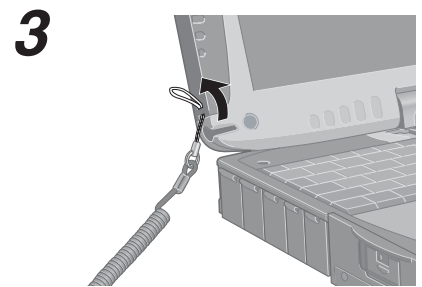
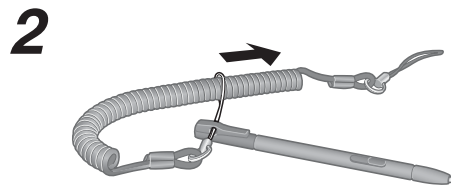
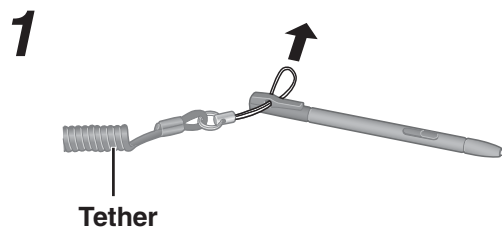

CAUTION

- When closing the display, be careful not to catch the tether between the display and main part of the computer. (See the figure below.)

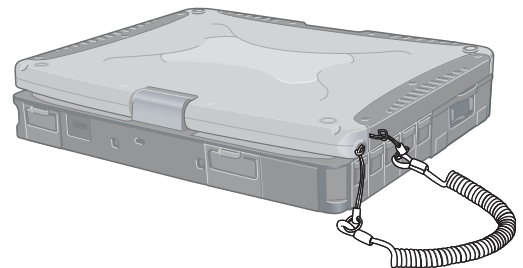
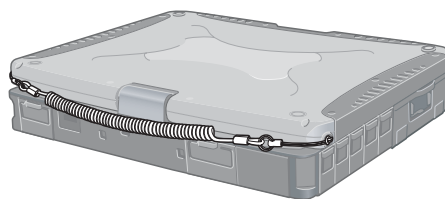





First-time Operation

Read the steps below to help you learn what parts are included, and to gain an understanding of some basic computer-related operations.

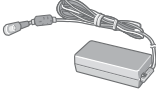
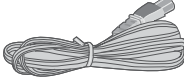
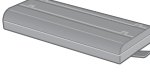
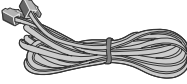
1 Confirm the inclusion of all parts.

Make sure the parts shown in the figure have been supplied. If any of these items are missing or are not working properly, contact Panasonic Technical Support.

AC adaptor 1	AC Cord 1	Battery Pack 1
 Model No : CF-AA1623A		 Model No : CF-VZSU30B
Modem Telephone Cable 1	Soft Cloth 1	Pen 1
		 (☞ Reference "Digitizer (Advanced)" Manual)
Tether 1	Shoulder Strap 1	Operating Instructions (This book)*1 1
 (☞ page 12)	 (☞ page 10)	Windows® Book 1
		Product Recovery CD-ROM 4

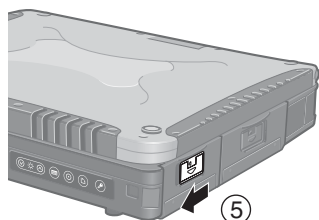
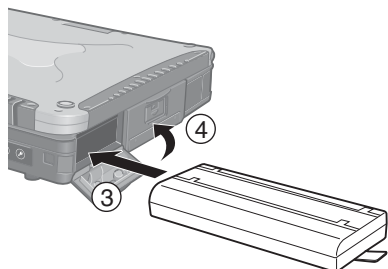
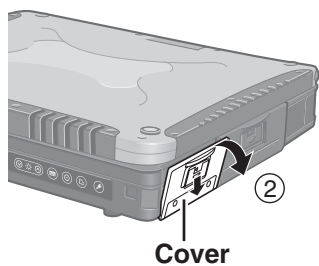
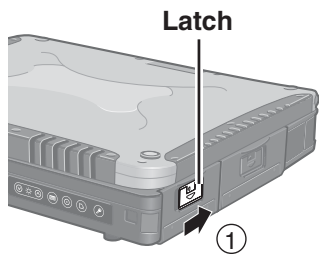

*1 If additional instructions are included with the computer, be sure to read them. It may be necessary to perform additional operations during the following procedures.

2 Read the LIMITED USE LICENSE AGREEMENT. (☞ page 37)

Be sure to read the LIMITED USE LICENSE AGREEMENT before breaking the seal on the computer's packaging.

3 Insert the battery pack.

- ① Unlock the cover by sliding the latch to the right.
- ② Slide the latch down, and then without releasing it, open the cover as illustrated.
- ③ Slide the battery pack inward until it is firmly in place.

CAUTION

- Do not touch the terminals on the battery pack and the computer. The battery pack may no longer function properly if the contacts are dirty or damaged. Also, the computer may not operate properly.
- Be sure to insert the battery pack as illustrated.

④ Close the cover until it clicks into place.

⑤ Lock the cover by sliding the latch to the left.

CAUTION

- Confirm that the latch lock is correctly in place. If you carry your computer without the latch lock in place, the battery pack may fall out.
- Before using the battery pack, carefully read "Precautions (Battery Pack)" (☞ page 7-8).

First-time Operation

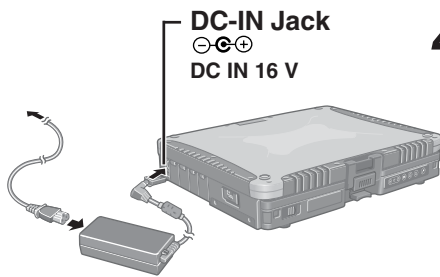

4 Connect your computer to a power outlet.

CAUTION

- Be sure the AC adaptor is connected until completing the first-time use operation.
- When using the computer for the first time, do not connect any peripheral device except the battery pack and AC adaptor to the computer.

Handling the AC adaptor

- Do not twist or pull the AC power cord forcefully. Doing so may damage the connections.
- Use only the specified AC adaptor with your computer. Using an AC adaptor other than the one supplied might damage the battery and/or the computer.
- When the DC plug is not connected to the computer, disconnect the AC cord from your AC wall outlet.
- Problems such as sudden voltage drops may arise during periods of thunder and lightning. Since this could adversely affect your computer, an uninterruptible power source (UPS) is highly recommended unless the battery pack is installed.

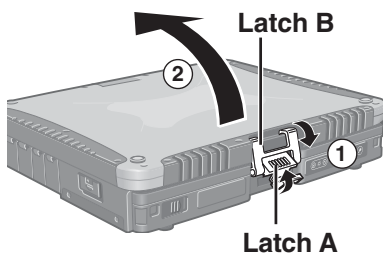

5 Open the display.

- ① Pull up latch A and release latch B.
- ② Lift open the display.

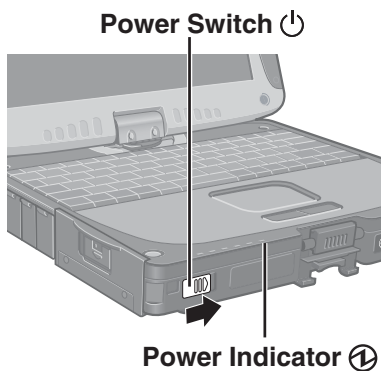



6 Turn your computer on.

Slide the power switch and hold it for approximately one second until the power indicator turns on before releasing it.

CAUTION

- Do not slide the power switch and hold it for more than four seconds; this will cause the power to be turned off forcibly.
- Do not slide the power switch repeatedly.
- Once the computer is powered off, you must wait at least ten seconds before powering it on again.

7 Setup Windows.

Moving the cursor  or clicking buttons can be performed with the touch pad ( page 20).

CAUTION

- Do not press any keys or touch the touch pad until [Windows XP Professional Setup] is displayed.

- ① At [Welcome to the Windows XP Setup Wizard], select [Next].
- ② After reading the agreement, select [I accept this agreement] or [I don't accept this agreement], then select [Next].

NOTE

- If [I don't accept this agreement] is selected, the Windows setup will be aborted.

- ③ Select settings for your region, then select [Next].
- ④ Enter your name and organization and then select [Next].

- ⑤ Enter your computer name and administrator password and then select [Next].

CAUTION

- Remember this password! If the password is forgotten, Windows cannot be operated.

- ⑥ Enter the correct date, time and time zone, then select [Next].

NOTE

- It may take some time before the computer restarts and the screen of step ⑦ is displayed. Wait, and do not press any keys, or touch the touch pad, etc.

The computer will restart.

- ⑦ Enter your administrator password and select .

NOTE

- If the message “Wait several minutes while the optimal configuration is being set. Do not shutdown the computer during this process.” is displayed, wait and do not press any keys, or touch the touchpad, etc.
- When Windows setup is completed, the following message will be displayed at the bottom right of the screen: “Your computer might be at risk.” Continue to the next step.

The message is generated by the [Security Center] function in [Control Panel], and does not indicate an error or malfunction. For more information about “Security Center”,  page 26.

If the cursor can not be pointed correctly with the pen, perform [Calibration] in [start] - [Control Panel] - [Printers and Other Hardware] - [Tablet and Pen Settings].

- When you perform the calibration, hold the pen at the same angle as you would when actually using it.
- Perform the calibration separately for [Landscape] and [Portrait].

8 Create a new account.

- ① Select [start] - [Control Panel] - [User Accounts] - [Create a new account].

NOTE

● When creating a new user account:

- If you make mail settings, create password reset disks ( page 16), or conduct other related operations before creating the user account, you will be unable to use any previous mail history or settings.
- When you create the first new account, you can only select [Computer administrator].

Once a “Computer Administrator” account has been created, you can create additional limited user accounts.

Note also that only the added user account will be displayed in the Welcome screen. The account for the administrator created during Windows setup will not be displayed.

- ② Enter a name for the new account, then select [Next].
 ③ Select [Computer administrator], then select [Create Account].
 ④ <When you want to create a password for the new account>
 Select the new account you have created and select [Create a password].
 Follow the instructions on the screen to create a password.

CAUTION

- Remember this password! If the password is forgotten, Windows cannot be operated. You can create a password reset disk beforehand. ( page 16)

- ⑤ Select [start] - [Turn Off Computer] - [Restart] to restart the computer.

First-time Operation

NOTE

- About the Icon Enlarger:
 - If the characters or icons on the screen are too small and difficult to see, after completing step **8**, select [start] - [All Programs] - [Panasonic] - [Icon Enlarger]. This will allow you to magnify the display of characters and icons on the screen.
 - The [Icon Enlarger] can be set separately for each account.
 - You can also use [Loupe Utility], which enlarges a part of the screen. (☞ Reference Manual “Loupe Utility”)
- <Only for models with wireless LAN>
- If you use the wireless LAN, be sure to refer to Reference Manual “Wireless LAN”.

This concludes the first-time use operation guidelines.

Information for Windows XP

- Depending on the Windows settings, installed applications, and drivers, menus and other displays may differ, or some functions (such as use of the password reset disk) may be inoperable. Check with your system administrator for details.
- You can select Classic view for the Control Panel or select the Classic Start menu. You can also change the way a user logs on or off. The procedure in this manual uses the method or view of the Windows XP default setting (not Classic view or Classic Start menu etc.).
- **Resetting the password**

Windows XP has a function to reset a forgotten password. To use this function, you need to create a password reset disk beforehand following the steps below.

 - 1** Connect the USB floppy disk drive (optional: CF-VF DU03) to your computer.
 - 2** Select [start] - [Control Panel] - [User Accounts].
 - 3** Select the account you used to log on and select [Prevent a forgotten password] from [Related Tasks] menu.

Create a password reset disk following the on-screen instructions. Store the password reset disk in a safe place.

 - Only the logon password for each account can be reset.

The password set in the Setup Utility (☞ Reference Manual “Setup Utility”) cannot be reset.

Starting Up/Shutting Down

Starting Up

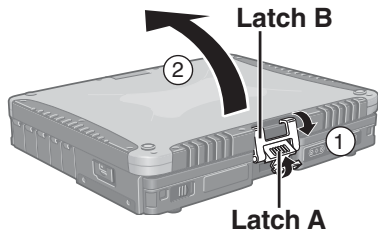

1 Open the display.

- ① Pull up latch A and release latch B.
- ② Lift open the display.

2 Turn your computer on.

Slide the power switch and hold it for approximately one second until the power indicator turns on before releasing it.

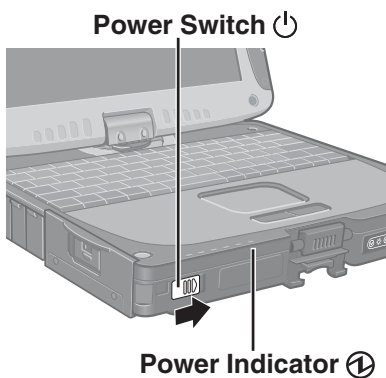

CAUTION



- While booting, avoid the following until the hard disk drive indicator  has turned off.
 - Connecting or disconnecting the AC adaptor.
 - Touching the power switch or the tablet buttons.
 - Performing any keyboard, touch pad, digitizer (or external mouse) operations.
 - Closing the display.
- Once the computer is powered off, you must wait at least ten seconds before powering it on again.
- When using this computer with the battery pack only, it may take some time for the power to turn on after sliding the power switch. In this case, slide the power switch and hold it for more than one second. This phenomenon occurs because the standby power is minimized while the power is turned off; it is not a malfunction.
- When the CPU temperature rises, the computer may not power on to prevent the CPU from overheating. Should this happen, allow the computer to cool down then switch the power on again.
If the computer still does not power on, contact Panasonic Technical Support.

NOTE

- When the power is turned on in a low-temperature environment, sometimes the message “Warming up the system. Please wait...” is displayed (up to 25 minutes) or the battery indicator alternately blinks green and orange. This function is designed to prevent hard disk drive malfunctions that may occur at low temperatures. Wait for the computer to start up.

Starting Up/Shutting Down

3 Log on to Windows.

After confirming that the hard disk drive indicator  has turned off, select the user and input the password, then select . Until the correct password is entered, the computer will not operate.

4 Select your application.

You are able to start working on your computer.

NOTE

- The power saving function is factory set, so if there is no input from a key, the touch pad, the tablet button, the digitizer or an external mouse (when one is connected) for a certain interval of time, the power to the LCD and hard disk may be turned off. The LCD will resume operation when the touch pad, the digitizer or an external mouse (when one is connected) is used or a key or the tablet button is pressed. The power to the LCD may be turned off even when an application software is being installed. In this case, because it is conceivable that a selection dialog box will be shown, do not press **Space** or **Enter** to attempt to resume from this condition as doing so may trigger a selection, but instead, press a key unrelated to the direct triggering of a selection, like **Ctrl**. In addition, when the computer is left alone, it automatically enters the standby or hibernation mode. The computer will resume by sliding the power switch.  Reference Manual “Standby/Hibernation Functions”

● If [Enter Password] is displayed,

Enter your password*¹ and press **Enter**.  Reference Manual “Security Measures”

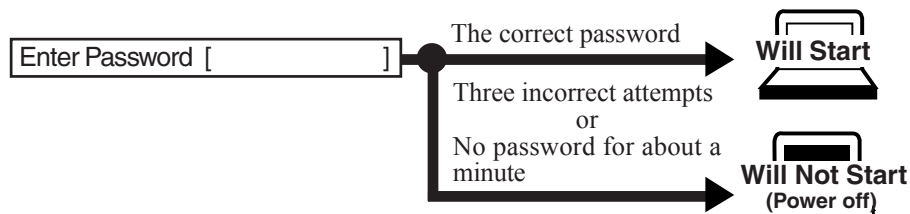

*¹ Supervisor Password or User Password set in the Setup Utility (not the Windows password).

Shutting Down (power off your computer)

1 Save important data and close each application.

2 Select [start] - [Turn Off Computer].

3 Select [Turn Off].

Your computer will power off automatically.

- Restarting your computer (without shutting down)
Select [Restart].



● **To shut down using the keyboard;**

Press , **U**, and select [Turn Off] with **U**.

CAUTION

- Do not do the following during the shutdown/restart procedure.
 - Connecting or disconnecting the AC adaptor.
 - Touching the power switch.
 - Performing any keyboard, touch pad, digitizer, tablet buttons, or external mouse operations.
 - Closing the display.

NOTE

- **To quickly resume computer operation after shutting down,**
The standby or hibernation function is available ( Reference Manual “Standby/Hibernation Functions”).
- **When you leave the computer or interrupt your work...**
If you use the “Standby” or “Hibernation” function, then when you turn on the power next time, the application software and files you were using before will be displayed, and you can restart the same operations immediately ( Reference Manual “Standby/Hibernation Functions”).

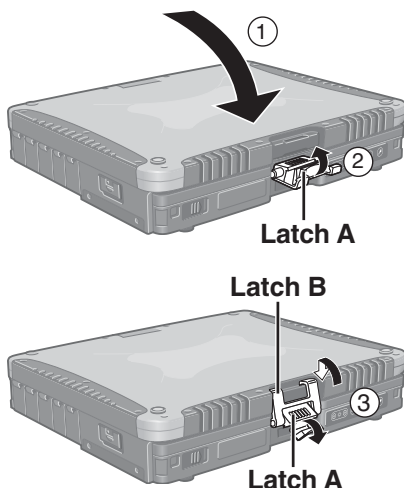

4 Close the display.

① Close the display.

② Pull up latch A.

③ Position latch B on the display side, then bring latch A down to fix the display in place.

Touch Pad (Basic Operation)

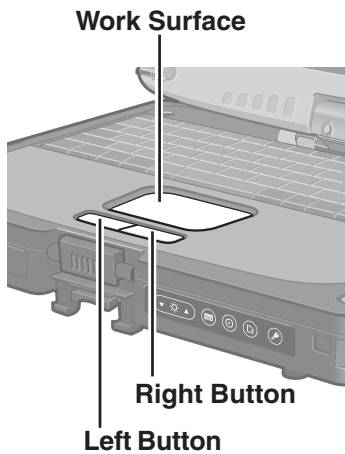

Use the touch pad to move the cursor on the display and perform normal computer operations. For more details, refer to ^{Reference Manual} "Touch Pad".

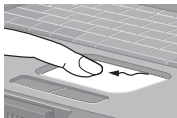
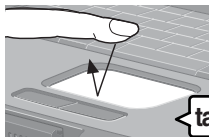
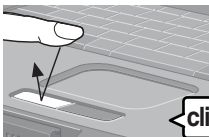
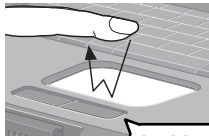
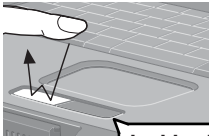
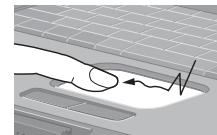
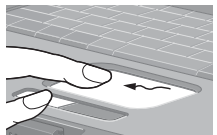
Function	Touch Pad Operation
Moving the Cursor	 <p>Move the tip of your finger lightly over the work surface.</p>
Tapping/Clicking	 <p>or</p>  <p>● To right-click: click with the right button.</p>
Double-Tapping/ Double-Clicking	 <p>or</p> 
Dragging	 <p>or</p>  <p>Two quick taps, but on the second tap leaving your finger down (applying pressure) and moving it on the work surface.</p> <p>While holding down the button, moving your finger on the work surface.</p>

Handling the Touch Pad

- By design the touch pad is to be used with a finger tip only. Do not place any object on the work surface or press down forcefully with sharp-pointed objects (e.g., nails) or hard objects that can leave marks (e.g., pencils and ball point pens).
- Try to avoid having any harmful substances such as oil, come in contact with the touch pad. The cursor may not work properly in such cases.
- **When the touch pad becomes dirty:**
Wipe to remove dirt by using a dry soft cloth such as gauze or a soft cloth first applied with detergent diluted with water and then thoroughly wrung.
Do not use benzene, thinner, or rubbing alcohol. Doing so may adversely affect the surface, e.g., discoloration. In addition, do not use commercially-available household cleaners and cosmetics, as they may contain components harmful to the surface.

Digitizer (Basic Operation)

Your computer is equipped with a digitizer function allowing you to perform the same operations as the touch pad or mouse by touching the surface of the display with the pen (included). (The following explanation gives one example (for the default settings).)

The operation settings can be changed. For detailed information, refer to Reference Manual “Digitizer (Advanced)”.

● Moving the cursor

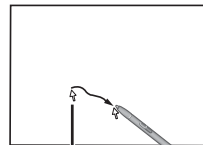

You can move the cursor by bringing the pen close to the screen, without actually touching the screen's surface.

Cursor

Pen

● Clicking

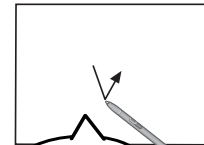

One tap

● Double-clicking

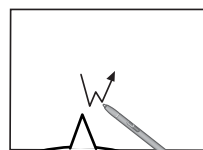

Two quick taps

● Dragging

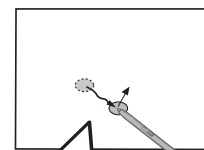

Touch and hold the object (i. e. file or icon), move the pen on the surface (dragging the object to the desired location), then release the pen.

● Right-clicking

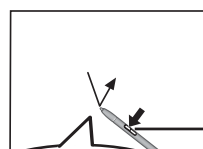

Pen Button

Press and hold down the pen button, then tap the object.

Handling the Digitizer

- Use the pen included with the computer. You cannot use an implement other than the pen that comes with the computer.
- Do not place any object on the surface or press down forcefully with sharp-pointed objects (e.g., nails), or hard objects that can leave marks (e.g., pencils and ball point pens).
- Do not operate the computer when such things as dust are on the screen. Doing so may scratch the screen.
- **When the screen becomes dirty:**
 - Wipe to remove dirt by using a dry soft cloth included with the computer.
 - Do not use benzene or thinner, or rubbing alcohol.
 - For more information, refer to “Suggestions About Cleaning the LCD Surface” that comes with the soft cloth.
- Because the digitizer uses electromagnetic induction, it may malfunction in locations such as the following, where strong electrical fields or magnetic fields occur:
 - Near AM radio base station or relay station antennas
 - Near some CRT displays that generate strong electromagnetic field noiseEven if the digitizer does malfunction, it will return to normal operations when the computer is no longer in close proximity to the locations described above.

Handling the Pen

- The pen has a built-in pressure sensor to detect the touch of the pen tip. Avoid strong shocks (such as dropping the pen), excessive pressure on the pen tip, or allowing the pen to become wet. These may result in malfunctions or damage to the pen.
- Clean the pen tip and screen prior to operation. Foreign particles can scratch the screen and impede the operation of the pen.
- Use the pen only for the computer screen. Using it for any other purpose may damage the pen and scratch the screen.
- Do not move the pen too quickly. If the pen moves too quickly, the cursor may be unable to follow its movement.

Operating in Tablet Mode

In addition to being used as a regular notebook computer (Laptop mode), this computer can also be operated in Tablet mode. Simply turn the display around 180°, and close the computer with the display facing up. In Tablet mode, the computer can be operated using the digitizer (☞ page 21), the Input Panel and the tablet buttons (☞ Reference Manual “Tablet Buttons”), instead of the internal keyboard and the touch pad.

Set the computer in Tablet mode using the following procedure.

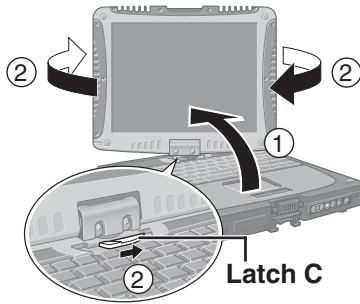

- ① Open the display so that it is perpendicular with the body of the computer.
- ② Slide latch C to the right, and then without releasing it, turn the display clockwise by 180°.

CAUTION

- Do not rotate the display more than 180° or attempt to rotate the display counter-clockwise.

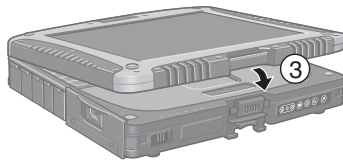

- ③ Close the computer with the display facing up.

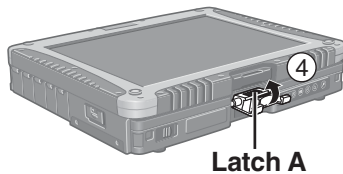

- ④ Pull up latch A.

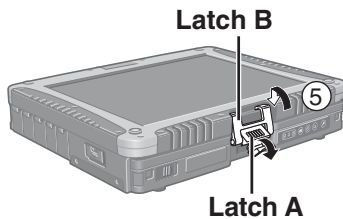

- ⑤ Position latch B on the display side, then bring latch A down to fix the display in place.

NOTE

- To return to Laptop mode:
Perform the steps for changing the computer into Tablet mode, only in reverse order.
1 Pull up latch A and release latch B.
2 Open the display.
3 Slide latch C to the right, and then without releasing it, turn the display counter-clockwise by 180°.

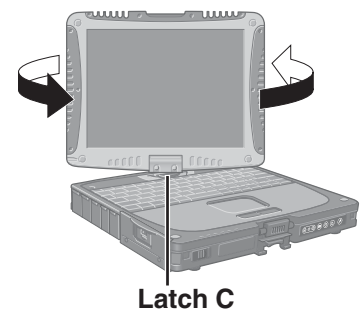

Usage Example

In Tablet Mode, the computer can be operated while holding the body as shown in the figure.

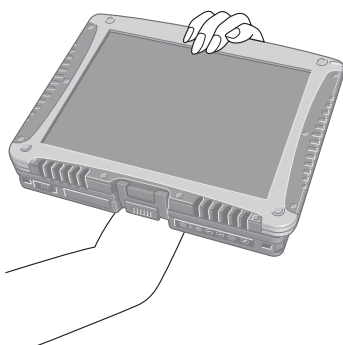

Changing the Display Settings

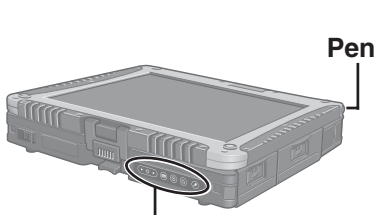

Tablet Buttons

- LCD brightness control
- Input Panel
- Enter
- Rotation
- Security

To rotate the display

Press the rotation button until the display is set at the angle that is most comfortable for you.

For detailed information, refer to ^{Reference}Manual “Display Rotation”.

NOTE

- You can set the computer so that the display automatically rotates to your preferred angle when changing from Laptop mode to Tablet mode or vice versa. (^{Reference}Manual “Display Rotation”)

To adjust the brightness of LCD

Press the LCD brightness control buttons .

Inputting Characters

Press the Input Panel button or select on the taskbar.

[Tablet PC Input Panel] shown below will appear, and characters can be input with the pen (included). For detailed information, refer to Windows help.



NOTE

- When using the digitizer function, use only the pen included with the computer.

Reference Manual

Reference Manual / Important Tips

The Reference Manual and the Important Battery Tips can be accessed on your computer. When a printer is connected, these manuals can also be printed.

● Reference Manual

The Reference Manual explains functions for you to make greater use of the computer, such as how to add peripheral devices, how the Setup Utility works, and other useful information. (Refer to the cover of this manual for a list of the main contents included.)

● How to access the Reference Manual

Select [Reference Manual] in [start].

● Important Battery Tips

Important Battery Tips provides information on how to maximize use of the battery pack, which is necessary for computing away from your home or office.

● How to access the Important Battery Tips

Select  on the desktop.

Important Battery Tips can also be accessed from [start] - [All Programs] - [Panasonic] - [On-Line Manuals] - [Important Battery Tips].

When the Reference Manual or Important Battery Tips is accessed for the first time, the License Agreement of the Adobe Reader may be displayed. If it is displayed, after reading the agreement, select [Accept] to access the Reference Manual or Important Battery Tips. Refer to Adobe Reader Help to use the Adobe Reader.

NOTE

- Illustrations may be difficult to view depending on the magnification. If the illustration is too small, magnify the display.
- If a printer is connected, we recommend printing the pages required. Depending on the printer, the illustrations and display samples may not be printed with a high quality.

Useful Information

Usage Environment

● Environment

- Operation: Temperature: 5 °C to 35 °C {41 °F to 95 °F}
Humidity : 30% to 80% RH (No condensation)
- Storage: Temperature: -20 °C to 60 °C {-4 °F to 140 °F}
Humidity : 30% to 90% RH (No condensation)

Even within the temperature and humidity ranges noted above, using the computer for long periods of time in an environment with exceptionally low or high temperatures or high humidity may result in deterioration of the product, which can lead to a reduction in product life.

NOTE

- Only use the computer within the allowable temperature range.
When the computer is left powered on in a low temperature environment, set [Turn off hard disks] to [Never] in the following menu to avoid damage to the hard disk drive.
[start] - [Control Panel] - [Performance and Maintenance] - [Power Options] - [Power Schemes]

● Places not to use your computer

- Such areas may result in damage to the computer.

Areas with electronic equipment

These areas may interfere with your display or cause your computer to produce strange sounds.

Areas with extremely high/low temperatures

- Do not leave things near the computer that are sensitive to heat. During operation, the computer may become warm.
- Before putting the computer away, be sure to wipe off any moisture.

Handling

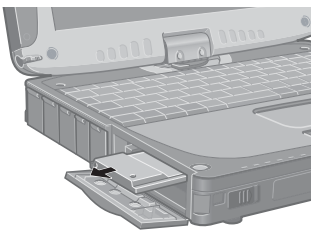

This computer has been designed so as to minimize shock to the LCD and hard disk drive, the leakage of liquid (e.g., water) on to the keyboard, etc., but no warranty is provided against such trouble. Therefore, as a precision instrument, be extremely careful when handling.

When carrying the computer, be sure to keep to the following:

- Turn off the computer.
- Remove all external devices, cables, PC Cards protruding from the computer (see the figure on the left) and SD Memory Cards before transporting the computer.
- Do not drop or hit your computer against solid objects.
- Do not place the computer upright or allow it to tip over. When the computer receives extremely strong shock after falling, the hard disk or floppy disk drive, etc., may become inoperable.
- Do not carry the computer while the display is open, or carry it by gripping the display.
- Do not put anything (e.g., a piece of paper) between the display and keyboard.
- When taking an airplane, always carry your computer with you. Never check it in with luggage. Before using the computer inside an airplane, we recommend asking the airlines regarding their policy on this issue.
- When transporting a spare battery pack inside a package, briefcase, etc., it is recommended that it be placed in a plastic bag in order to protect its contacts.

We recommend the following:

- Preparing a fully charged battery pack.
- Making backup copies on discs and carrying them with you.

Useful Information

Maintenance

Touch Pad
page 20

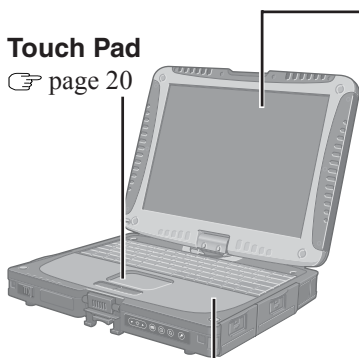

Display

Use the Soft Cloth included with the computer. (For more information, refer to “Suggestions About Cleaning the LCD Surface” that comes with the Soft Cloth.)

If the Protective Film becomes damaged, it may be time to replace your Protective Film. The Protective Film is a disposable item. To find out the model number of your Protective Film, contact Panasonic Technical Support. (For more information, refer to the “Operating Instructions” that come with the Protective Film.)

CAUTION

- Do not touch the screen before you re-attach a Protective Film, as you may leave a mark or a scratch on the screen.

Areas excluding the display

Wipe these areas with a soft cloth, after applying water or detergent diluted with water to the soft cloth and firmly wringing out excess water.

CAUTION

- Do not use benzene, thinner, or rubbing alcohol. Doing so may adversely affect the surface, e.g., discoloration. In addition, do not use commercially-available household cleaners and cosmetics, as they may contain components harmful to the surface.
- Do not directly add or spray water or detergent. If liquid enters the inside of the computer, it may cause it to work improperly or be damaged.

Security Center/Antivirus Protection

Use the Windows Security Center function to protect Windows from damage by computer viruses, etc.

Windows Security Center

● What is Windows Security Center?

The Windows Security Center allows centralized management of Windows security information, and monitors antivirus measures and other Windows security settings to ensure optimum safety.

Use the Windows Security Center function to protect your computer from damage by viruses, etc.

Select [start] - [Control Panel] - [Security Center] to display the current settings for the following security functions.

• Windows Firewall

A security system for protecting the computer from unauthorized access via the Internet or other external networks.

The firewall regulates the data exchanged between the computer and the external network, so that only approved data can pass through.

At the time of purchase, the Windows Firewall is set to be enabled.



• Automatic Updates

If your computer is connected to the Internet, this function regularly checks whether security updates and other important updates have been made available, and automatically installs these updates in their latest conditions.

• Virus Protection

This function regularly checks whether antivirus software has been installed in the computer, and whether the version of that software is the latest version available.

If the message “Your computer might be at risk” is displayed

Read the message, select  (red icon) on the taskbar, and make the appropriate settings. This message, which the Windows Security Center ( page 26) displays to confirm the security-related settings regularly, will be displayed until the settings are made more properly.

NOTE

- This message does not indicate an error. You can use the computer while the message is displayed. However, in order to operate the computer more safely, we recommend making the appropriate measures to reduce damage from virus and other attacks, thus avoiding the appearance of this message.

The Pop-up Blocker

In Windows XP, security functions have been strengthened with regard to Web contents. One of these is the “Pop-up Blocker,” which may prevent some Web pages from being displayed.

Computer Viruses

Users are advised to purchase the latest versions of virus protection software and use them regularly.

We recommend you run the software:

- When booting your computer.
- After receiving data.

We recommend that you check data received on disks or from external sources, such as data downloaded from the Internet, e-mail, etc. (For compressed files, uncompress them before running a check).

For Data Execution Prevention (DEP), you can make one of the settings in the following menu. [start] - [Control panel] - [Performance and Maintenance] - [System] - [Advanced] - [Settings] (in [Performance]) - [Data Execution Prevention]
For more information, refer to Windows help.



Windows Update

You can use the latest patches and service packs for Windows with the following menus.

Do not apply “Driver Updates” even if a message to update a driver appears. If a driver update is required, contact Panasonic Technical Support. ( page 46)

[start] - [All programs] - [Windows Update]

Saving Data on the Hard Disk

- **Do not expose your computer to shock.**
Use care when handling your computer, shock may damage your hard disk or make your software applications and data unusable.
- **Do not power down your computer while software applications are running or hard disk drive indicator  is on.**
Properly shut Windows down to avoid problems.
- **Save all valuable data to disks.**
Backing up data to disks will limit damage should trouble occur to your computer or should you inadvertently change or erase data.
- **Use the security function for all important data.** ( Reference Manual “Security Measures” and “SD Memory Card Security Function”)

Hard Disk Lock

When the Hard Disk Lock is set to [Enable], it is impossible to read/write data from/to the hard disk when the hard disk is installed in a different computer. When the hard disk is returned to the original computer, you can read/write data as before. In this case, however, make the settings in the Setup Utility exactly the same as they were before the hard disk was removed. (Note that this Hard Disk Lock does not guarantee the complete protection of data.) ( Reference Manual “Security Measures”)

Useful Information

When Using Peripheral Devices

Pay strict attention to the following points to avoid damage to the computer, peripheral devices, cables, etc. Also, in addition to following this manual and the Reference Manual, carefully read the instruction manuals for the peripheral devices being used.

- Use only peripheral devices that conform to the computer's specifications.
- Connect the devices properly, paying close attention to the condition and position of the connectors.
- If a connection cannot be made easily, do not apply undue force; check once more to confirm the condition and position of the connector (alignment of pins, etc.).
- If the connector has holding screws, fasten the screws firmly.
- Do not carry the computer with cables attached, and do not pull on the cables forcefully.

When Changing Hard Disk Partitions

When using the hard disk backup function, divide the hard disk into partitions when a backup area is created (☞ page 39). If you divide the hard disk into partitions before creating the backup area, the backup area cannot be created.

When Disposing of or Transferring Ownership of This Device

When disposing of or transferring ownership of this device, erase all data on the hard disk in order to prevent the theft of hard disk data. Even if you delete data or initialize the hard disk through normal Windows commands, data can still be read using special software. In order to erase all data, either have the data erased by a specialist (at a charge) or use the hard disk data erase utility (included) (☞ page 43). (Note that this hard disk data erase utility does not guarantee that data will be completely erased.)

Also, note that if you transfer ownership of this device without deleting commercial software that you have installed to the hard disk, you may be in violation of the licensing agreement for that software.

Wireless LAN (only for models with wireless LAN)

- **To prevent theft of data or unauthorized access to the hard disk via a wireless LAN.**

If you plan to use wireless LAN functions, we recommend that you do so only after making the appropriate security settings, such as for data encryption.

List of Error Codes

When turning on the computer, if one of the following error codes or messages is displayed, follow the instructions shown below. If the problem persists, or if the error code or message displayed is not shown here, contact Panasonic Technical Support (☎ page 46).

Error Code/Message	Action
0211: Keyboard error	<ul style="list-style-type: none"> ● If an external keyboard or mouse is connected, disconnect these devices.
0251: System CMOS checksum bad - Default configuration used	<p>An error has occurred in the memory that stores the Setup Utility settings. This error occurs when the memory content is changed through some inadvertent operation by a program or other function.</p> <ul style="list-style-type: none"> ● Run the Setup Utility and load the default values, then change the settings to the appropriate values as needed. ● If the problem persists, the internal clock battery may need to be replaced. Contact Panasonic Technical Support.
0271: Check date and time settings	<p>The date and time setting are incorrect.</p> <ul style="list-style-type: none"> ● Run the Setup Utility and set the date and time correctly. ● If the problem persists, the internal clock battery may need to be replaced. Contact Panasonic Technical Support.
0280: Previous boot incomplete - Default configuration used	<p>Startup has failed repeatedly, so the Setup Utility settings have been returned to their default values, and the computer has been booted.</p> <ul style="list-style-type: none"> ● Run the Setup Utility and load the default values, then change the settings to the appropriate values as needed.
Press <F2> to Setup	<ul style="list-style-type: none"> ● Write down the error details and press (F2) to run the Setup Utility. Confirm the settings, and change the settings to the appropriate values as needed.
Operating System not found	<p>The OS is not properly installed on the floppy disk or the hard disk that you are trying to boot from.</p> <ul style="list-style-type: none"> ● If the computer cannot be booted from the floppy disk, check the floppy disk drive to ensure that the disk is in fact bootable, and use another bootable disk if not. ● If the computer cannot be booted from the hard disk, confirm whether the hard disk is properly recognized in [Information] menu of the Setup Utility. <ul style="list-style-type: none"> • If the hard disk is recognized, perform the reinstallation procedure. • If not, contact Panasonic Technical Support. ● If a device is connected to the USB port, disconnect the device, or run the Setup Utility and set [Legacy USB Support] in [Advanced] menu to [Disable].
Extended RAM Module Failed	<ul style="list-style-type: none"> ● If the extended RAM module has not been inserted properly, or if an extended RAM module other than one matching the specifications has been inserted, a beep will sound and the message “Extended RAM Module Failed” will be displayed when turning the power on. In this case, turn the power off, confirm that the extended RAM module meets the specifications, and reinsert it.

● To run the Setup Utility

- 1 Restart the computer.
- 2 Press **(F2)** while [Panasonic] boot screen is displayed soon after the computer begins the startup procedure.

Dealing with Problems (Summary)

When a problem occurs, refer to this page. The “Reference Manual” also contains detailed information. If a problem appears to be related to a software application, read the software related manual. If you still cannot troubleshoot the problem, contact Panasonic Technical Support (☎ page 46). You can use the PC Information Viewer to check the computer’s usage status. (☎ Reference Manual “Dealing with Problems (Advanced)”)

● Starting Up

<p>The power indicator is not lit</p>	<ul style="list-style-type: none"> ● Check the cable connection for the AC adaptor. ● Check to see if a charged battery pack is properly installed. ● Remove the battery pack and disconnect the AC adaptor, then connect them again.
<p>The computer does not operate when a USB device is connected</p>	<ul style="list-style-type: none"> ● The computer may not operate when certain USB devices are connected. Disconnect the USB device, or set [Legacy USB Support] to [Disable] in [Advanced] menu of the Setup Utility.
<p>[Enter Password] is displayed</p>	<ul style="list-style-type: none"> ● Input your Supervisor Password or User Password. If you have forgotten it, contact Panasonic Technical Support.
<p>POST Startup Error(s) is displayed</p>	<p>☎ page 29</p>
<p>Windows startup, or an operation is extremely slow</p>	<ul style="list-style-type: none"> ● Press (F9) in the Setup Utility (☎ <small>Reference Manual</small> “Setup Utility”). This will restore the Setup Utility’s settings to their default values (except the password settings). Then, the Setup Utility must be run once again for you to input the appropriate operating environment settings. (The processing speed depends on the application software used, so this operation may not cause the processing speed to increase.) ● If you install resident software after purchasing this computer, disable the resident software. ● When Indexing Service is enabled, Windows operation becomes slower. Disable Indexing Service in the following menu. [start] - [Search] - [Change preferences] - [Without Indexing Service]
<p>The date and time are incorrect</p>	<ul style="list-style-type: none"> ● You can set the date and time using the following menu. [start] - [Control Panel] - [Date, Time, Language, and Regional Options] - [Date and Time] ● When the computer is connected to a LAN, confirm the date and time of the server. ● If you continue to experience problems, the internal battery maintaining the clock may need to be replaced. Contact Panasonic Technical Support. ● This computer will not correctly recognize the date and time starting from the year 2100 A.D.
<p>When resuming from the standby or hibernation mode, [Enter Password] does not appear even if a password has been set in the Setup Utility</p>	<ul style="list-style-type: none"> ● Even when a password has been set in the Setup Utility, [Enter Password] does not appear when the computer resumes from the standby or hibernation mode. If you want to use the security function when using the standby or hibernation mode, use the Windows password as follows: <ol style="list-style-type: none"> 1 Select [start] - [Control Panel] - [User Accounts], and select the account for which the password will be set. 2 Select [Create a password], input the password, and then select [Create Password]. 3 Add the check mark for [Prompt for password when computer resumes from standby] in [Control Panel] - [Performance and Maintenance] - [Power Options] - [Advanced].
<p>When the administrator password is forgotten</p>	<ul style="list-style-type: none"> ● If you have created a password reset disk (☎ page 16), a message is displayed when you fail to correctly enter the password. Follow the message’s instructions and set the password again by using the password reset disk. If you have not created a password reset disk, after reinstalling, setup Windows and then set the password again.
<p>When “Remove disks or other media. Press any key to restart” (or a similar message) is displayed</p>	<ul style="list-style-type: none"> ● This means a floppy disk that does not contain system startup information has been left in the floppy disk drive. Remove the floppy disk, and press any key. ● This message may appear when certain USB devices are connected. Remove the USB device, or set [Legacy USB Support] in [Advanced] menu of the Setup Utility to [Disable]. ● If the message still appears even after trying the above two measures, this may be an indication that some type of hard disk failure has occurred. Contact Panasonic Technical Support.
<p>[Executing Battery Recalibration] screen is displayed</p>	<ul style="list-style-type: none"> ● When Windows is shut down during the Battery Recalibration procedure, if you select [Cancel] in the [End Program] screen, Windows shutdown is aborted. In this case, Battery Recalibration will begin the next time the computer is started. To start up Windows, turn off the computer by sliding the power switch, and then turn it back on again.

Starting Up (continued)

<p>When the previous item is not the cause</p>	<ul style="list-style-type: none"> ● Press F9 in the Setup Utility (☞ <small>Reference Manual</small> “Setup Utility”). This will restore the Setup Utility’s settings to their default values (except the password settings). ● Try removing all peripheral devices. ● Check a disk error using the following procedure. <ol style="list-style-type: none"> 1 Select [start] - [My Computer], right-click [Local Disk(C:)] and then select [Properties]. 2 Select [Tools] - [Check Now]. 3 Select [Start] after selecting required items in [Check disk options]. ● At startup, hold down F8 when the [Panasonic] boot screen disappears*¹, and release your finger when the Windows Advanced Options Menu is displayed. Start the computer in Safe Mode, and confirm the details of the error. <p style="margin-left: 20px;">*¹ When [Password on boot] is set to [Enable], [Enter Password] appears after the [Panasonic] boot screen disappears. Hold down F8 soon after inputting the password and pressing Enter.</p>
--	--

Entering Password

<p>On the [Enter Password] screen, a beep sounds and the password cannot be entered</p>	<ul style="list-style-type: none"> ● The computer may be in ten-key mode. If the NumLk indicator NumLk lights, press NumLk to disable the ten-key mode, and then input.
<p>Even after entering the password, [Type your password] is displayed again</p>	<ul style="list-style-type: none"> ● The computer may be in ten-key mode. If the NumLk indicator NumLk lights, press NumLk to disable the ten-key mode, and then input. ● The computer may be in Caps Lock mode. If the Caps Lock indicator Caps Lock lights, press Caps Lock to disable the Caps Lock mode, and then input.

Display

<p>No display after powering on</p>	<ul style="list-style-type: none"> ● When there is no display to an external display, <ul style="list-style-type: none"> • Check your cable connection to the external display. • Confirm your display is powered on. • Check the settings for your external display. ● The display destination may be set to the external display. Try changing the display destination by pressing Fn + F3. If you want to switch the display destination repeatedly by pressing Fn + F3, make sure that the display destination has switched completely each time before pressing Fn + F3 again. ● Press Fn + F2 and adjust the LCD brightness.
<p>The power has not been turned off, but after a certain period of time, there is no display</p>	<ul style="list-style-type: none"> ● Has the computer been set to the power-saving mode? To resume operation of your computer from the condition the power of the display is off (for energy conservation purposes), press any key unrelated to the direct triggering of a selection, like Ctrl. ● To save power, your computer may have automatically entered the standby mode (power indicator blinks green) or hibernation mode (power indicator turns off). In such cases, slide the power switch.
<p>When the battery pack is used, the screen is darker than when the AC adaptor is connected</p>	<ul style="list-style-type: none"> ● Press Fn + F2 and adjust the LCD brightness. Note, however, that when the LCD brightness is increased, the battery running time will become shorter. The LCD brightness can be set to separate levels for when the AC adaptor is connected and when it is disconnected.
<p>The LCD brightness changes a number of times when the AC adaptor is disconnected</p>	<ul style="list-style-type: none"> ● Intel(R) Display Power Saving Technology (☞ <small>Reference Manual</small> “Computing on the Road”) is active and automatically changes the LCD brightness.
<p>Image colors are not reproduced as expected when displaying photographs or other images</p>	<ul style="list-style-type: none"> ● We recommend removing the check mark from [Intel(R) Display Power Saving Technology]. (☞ <small>Reference Manual</small> “Computing on the Road”)

Dealing with Problems (Summary)

● Display (continued)

<p>An afterimage appears (e.g., green, red, and blue dots remain on the display) or there are dots not displaying the correct colors</p>	<ul style="list-style-type: none"> ● If an image is displayed for a prolonged period of time, an afterimage may appear. This is not a malfunction. The afterimage will disappear when a different screen is displayed. ● High-precision and advanced technologies are necessary in the production of color liquid crystal displays (color LCDs). Therefore, if 0.002% or less of the picture elements either fail to light or remain constantly lit (that is, more than 99.998% of elements are functioning properly), no defect is considered to exist.
<p>The screen becomes disordered</p>	<ul style="list-style-type: none"> ● The screen display may become distorted if the resolution or number of colors is changed, or if an external display is connected or disconnected while the computer is operating. Restart the computer.
<p>The external display no longer displays properly</p>	<ul style="list-style-type: none"> ● When an external display not compatible with the power saving mode is used with the computer, the display may not function correctly when the computer enters the power saving mode. In such cases, turn off the power to the external display.
<p>When you want to display the fonts or icons at a larger size</p>	<ul style="list-style-type: none"> ● Change the size of the icons, etc. using “Icon Enlarger” (☞ <small>Reference Manual</small> “Icon Enlarger”). ● To enlarge a part of the screen, use Loupe Utility (☞ <small>Reference Manual</small> “Loupe Utility”).
<p>During simultaneous display, one of the screens becomes disordered</p>	<ul style="list-style-type: none"> ● Try changing the display by pressing Fn + F3. ● If you continue to experience problems, try changing the display destination in the following menu. [start] - [Control Panel] - [Other Control Panel Options] - [Intel(R) GMA Driver for Mobile] - [Devices] ● When the [Command Prompt] is set to “Full Screen” by pressing Alt + Enter, the picture is displayed on one of the screens only. When the window display is restored by pressing Alt + Enter, the picture is displayed on both screens. ● Simultaneous display cannot be used until Windows startup is complete (during Setup Utility, etc.). When Fn + F3 is pressed, the screen is displayed on the external display or internal LCD.
<p>When a video such as an MPEG file is being played with Windows® Media Player, the display destination cannot be switched using Fn + F3</p>	<ul style="list-style-type: none"> ● The display destination cannot be switched while a video such as an MPEG file is playing. Stop playing the video before switching the display destination.

● Shutting down

<p>Windows cannot be shut down or restarted</p>	<ul style="list-style-type: none"> ● If a USB device is connected, try removing it. ● It may take one or two minutes to shut down.
---	--





● Battery Indicator

<p>The red indicator lights</p>	<ul style="list-style-type: none"> ● The battery level is very low (the charge is approx. 9% or less). Connect the AC adaptor. You can use the computer when the battery indicator light is orange. If you do not have an AC adaptor, save your data and power off your computer. After replacing the battery pack with a fully charged one, turn your computer on.
<p>The red indicator blinks</p>	<ul style="list-style-type: none"> ● Quickly save your data and power off your computer. Remove the battery pack and disconnect the AC adaptor, then connect them again. If the problem persists, contact Panasonic Technical Support. The battery pack or charging circuit may be defective.
<p>The green indicator blinks</p>	<ul style="list-style-type: none"> ● In high temperature mode, the battery is discharging to the level that corresponds to an 80%*1 charge for normal temperature mode (☞ <small>Reference Manual</small> “Battery Power”). Do not remove the battery pack while the battery indicator is blinking green. If you remove it, the power will be turned off forcibly. *1 In high temperature mode, the level that corresponds to an 80% charge for normal temperature mode is displayed as [100%].
<p>The battery indicator blinks green and orange alternately</p>	<ul style="list-style-type: none"> ● Warming up the system to prevent hard disk drive malfunctions at low temperature. Leave your computer as is. Once the allowable temperature range requirement is satisfied, your computer will start automatically.



● Battery Indicator (continued)

<p>The orange indicator blinks</p>	<ul style="list-style-type: none"> ● Battery cannot be recharged temporarily because the internal temperature of the battery pack is outside of the acceptable temperature range for recharging. Once the allowable range requirement is satisfied, charging begins automatically. Your computer can be used normally in this state.
---	---

● Touch Pad / Digitizer

<p>The cursor cannot be controlled properly</p>	<ul style="list-style-type: none"> ● If you are using an external mouse, ensure that the external mouse has been connected correctly. ● Restart the computer by using the keyboard (Press , , and select [Restart] with ). ● If the computer does not respond to keyboard commands, read “No response” ( page 34).
<p>Unable to input using the touch pad</p>	<ul style="list-style-type: none"> ● Has the Setup Utility been used to set [Touch Pad] to [Enable]? ● When external mouse drivers are installed (e.g., IntelliMouse), the touch pad may not be used. ● Has the touch pad driver been properly installed?
<p>Unable to use the digitizer function</p>	<ul style="list-style-type: none"> ● Has the Setup Utility been used to set [Digitizer] to [Enable]? ● You can use only the pen included with the computer to use the digitizer function. ● It is necessary to perform [Calibration] to point correctly with the pen included with the computer.

● Display Rotation

<p>The display is not rotated automatically by switching from Laptop mode to Tablet mode, or vice versa</p>	<ul style="list-style-type: none"> ● Confirm that the default angle of each mode is correctly set. ( <small>Reference Manual</small> “Display Rotation”) ● Do not switch from Laptop mode to Tablet mode, or vice versa, while Windows is in the process of switching users with the Fast User Switching function.
<p>The display fails to rotate even when the rotation button  is pressed</p>	<ul style="list-style-type: none"> ● Close the applications which are open.
<p>When the screensaver starts while the display is rotated, nothing is displayed on the screen</p>	<ul style="list-style-type: none"> ● Some screensaver types do not display anything on the screen for the first minute or so. Try changing the screensaver type.

● Reference Manual

<p>The Reference Manual is not displayed</p>	<ul style="list-style-type: none"> ● Is Adobe Reader installed? If you have uninstalled Adobe Reader, install using the following procedures. <ol style="list-style-type: none"> 1 Select [start] - [Run], input [c:\util\reader\AdbeRdr70_enu_full.exe], then select [OK]. Install Adobe Reader by following the instructions on the screen.
---	--

● SD Memory Card

<p>Cannot log on with the SD Memory Card</p>	<ul style="list-style-type: none"> ● Windows logon user name and password are not set in the SD Memory Card correctly. Enter the Windows user name and password without using the SD Memory Card. After logging on, set the same user name and the password on the SD Memory Card and Windows, using the following operation. <ul style="list-style-type: none"> • Change the setting of the SD Memory Card by [SD Card Setup]. ( <small>Reference Manual</small> “SD Memory Card Security Function”)
---	---

Dealing with Problems (Summary)

● Fast User Switching Function

Some applications may not work properly	<ul style="list-style-type: none">● When switching to a different user with the Fast User Switching function, the following problems may occur.<ul style="list-style-type: none">• Some applications may not work properly.• Key combinations with (Fn) may not work.• It may not be possible to set the settings of the display.• <Only for models with wireless LAN> Wireless LAN may not work. <p>In this case, log off all users without using Fast User Switching function, and try the operation once more. If the problem persists, restart the computer.</p>
--	--

● Others

No response	<ul style="list-style-type: none">● Press (Ctrl) + (Shift) + (Esc) to open Task Manager and close the software application which is not responding.● Is there an input screen hidden behind another window? Use (Alt) + (Tab) to check for other windows being displayed.● After shutting down by sliding the power switch for more than four seconds, slide the power switch to power on and open the application again. If the program no longer works normally, delete the program using the following menu. [start] - [Control Panel] - [Add or Remove Programs]
--------------------	--

Reinstalling Software

When reinstallation procedure is performed, the contents of the hard disk will be erased. Be sure to back up any critical data on your hard disk to another media or to an external hard disk before running the reinstallation procedure.

The reinstallation procedure will return the computer to its original condition.

Even if a hard disk backup area has been created, this backup area will be erased, and all the backed up data will be lost.

(This is not the case when Windows is reinstalled in the first partition.)

- If you have created partitions for data, the data may be erased or become corrupt as a result of the reinstallation procedure.

Before Reinstallation

● Preparing

- Product Recovery CD-ROM (included)
- Panasonic USB CD/DVD drive (optional: CF-VDRRT1M, CF-VDRRT2W or CF-VDRRT3W)

● Important

- Before the reinstallation procedure, remove all peripherals (except for the CD/DVD drive).
- Be sure the AC adaptor is connected until the reinstallation procedure is completed.

Reinstalling

1 Turn off the computer and connect the CD/DVD drive to the USB port.

2 Turn the computer on, and press **(F2)** while [Panasonic] boot screen is displayed.

The Setup Utility will start up.

If the password has been set, enter the Supervisor Password.

3 Write down all of the contents of the Setup Utility and then press **(F9)**.

At the confirmation message, select [Yes] and press

(Enter).

4 Select [Boot] menu, then select [USB CDD] and press **(F6)** until [USB CDD] is at the top of the [Boot] menu.

5 Place disc number one of the recovery CDs into the CD/DVD drive.

6 Press **(F10)**.

At the confirmation message, select [Yes] and press

(Enter).

The computer will restart, and this screen should appear.

```
-----
Select a number
-----
1. [ Recovery ] Reinstall Windows.
2. [ Erase HDD ] Erase the whole data on HDD for security.
3. [ Backup   ] Enable the Backup function.
0. [ Cancel   ] Cancel.
-----
```

<When the hard disk backup function has been enabled>
When the message [The Backup function has been enabled. If [Recovery] or [Erase HDD] is executed, the Backup function will be disabled, and your Backup data will be lost.] appears, press **(Y)**.

7 Press **(1)** to execute [1.[Recovery]].
(You can cancel this operation by pressing **(0)**.)
The License Agreement screen should appear.

8 Press **(1)** to select [1. Yes, I agree to the provisions above and wish to continue!].

This screen should appear.

```
-----
Select a number
-----
Reinstalling : Windows(R) XP Tablet PC Edition

1. Reinstall Windows to the whole HDD to factory default.
2. Make two partitions, for the operating system and data. And reinstall
   Windows to the operating system partition.
   (All existing partitions on HDD will be lost.)
3. Reinstall Windows to the first partition.

0. Cancel
-----
```

9 Make a selection from the menu.

NOTE

- When [2] is selected, the hard disk backup function cannot be enabled because the hard disk has been divided into partitions.

- When selecting [2], enter the basic partition size for the operating system installation and press **(Enter)**.

(The data partition size is the remainder after subtracting the basic partition size.)

- To select [3], the initial partition size must be 8 GB or more of the hard disk size. Reinstallation cannot be performed with a small partition size.

<When the hard disk backup function has been enabled>
If you select [1] or [2], the message [The Backup function has been enabled. If [Recovery] is executed, the Backup function will be disabled, and your Backup data will be lost.] appears. In this case, press **(Y)**.

If the message [Computer must be rebooted in order to execute [Recovery].] appears, press **(R)**.

Reinstalling Software

- 10** At the confirmation message, press **(Y)**.

The operation of reinstallation for the hard disk starts automatically. (The operations take about 30 minutes.)

CAUTION

- Do not interrupt the reinstallation procedure before completion, for example by turning off the computer or pressing **(Ctrl) + (Alt) + (Del)**, as this may prevent Windows from starting up, or may cause data to be lost so that the reinstallation procedure cannot be executed.
- When a message appears instructing you to insert the next CD, insert the recovery CD showing the next number in the sequence, and then select [OK]. If the message [The media does not contain the correct file] appears, select [OK]. A message will appear instructing you to insert the next CD. Confirm that the proper recovery CD has been inserted by opening the cover of the CD/DVD drive and then close the cover, then select [OK].

After the reinstallation procedure completes, this screen should appear.

[Recovery] is complete.
Windows(R) XP Tablet PC Edition install wizard will start after reboot.
Please remove the Product Recovery CD-ROM.
After tuning off the power, disconnect the CD/DVD-ROM drive, and turn the power on again.

- 11** Remove the recovery CD, and then press any key.

The computer will be shut down.

- 12** Remove the CD/DVD drive.

- 13** Turn on the computer, and press **(F2)** while [Panasonic] boot screen is displayed.

The Setup Utility will start up.

If the password has been set, enter the Supervisor Password.

- 14** Press **(F9)**.

At the confirmation message, select [Yes] and press **(Enter)**. (The Setup Utility settings will return to their default values. Even the security settings with the exception of the password(s) will return to their default values.)

- 15** Select [Exit] and then select [Save Current Values], then press **(Enter)**.

At the confirmation message, select [Yes] and press **(Enter)**.

- 16** Turn the computer off by sliding the power switch.

NOTE

- If additional instructions are included with the computer, be sure to read them. It may be necessary to perform additional operations during the following procedures.

- 17** Perform the first-time use operation (☞ page 14 step **6** - page 15 step **8**).

- 18** Run the Setup Utility and change the settings where necessary.

LIMITED USE LICENSE AGREEMENT

THE SOFTWARE PROGRAM(S) ("PROGRAMS") FURNISHED WITH THIS PANASONIC® PRODUCT ("PRODUCT") ARE LICENSED ONLY TO THE END-USER ("YOU"), AND MAY BE USED BY YOU ONLY IN ACCORDANCE WITH THE LICENSE TERMS DESCRIBED BELOW. YOUR USE OF THE PROGRAMS SHALL BE CONCLUSIVELY DEEMED TO CONSTITUTE YOUR ACCEPTANCE OF THE TERMS OF THIS LICENSE.

Matsushita Electric Industrial Co., Ltd. ("MEI") has developed or otherwise obtained the Programs and hereby licenses their use to you. You assume sole responsibility for the selection of the Product (including the associated Programs) to achieve your intended results, and for the installation, use and results obtained therefrom.

LICENSE

- A. MEI hereby grants you a personal, non-transferable and non-exclusive right and license to use the Programs in accordance with the terms and conditions stated in this Agreement. You acknowledge that you are receiving only a LIMITED LICENSE TO USE the Programs and related documentation and that you shall obtain no title, ownership nor any other rights in or to the Programs and related documentation nor in or to the algorithms, concepts, designs and ideas represented by or incorporated in the Programs and related documentation, all of which title, ownership and rights shall remain with MEI or its suppliers.
- B. You may use the Programs only on the single Product which was accompanied by the Programs.
- C. You and your employees and agents are required to protect the confidentiality of the Programs. You may not distribute or otherwise make the Programs or related documentation available to any third party, by time-sharing or otherwise, without the prior written consent of MEI.
- D. You may not copy or reproduce, or permit to be copied or reproduced, the Programs or related documentation for any purpose, except that you may make one (1) copy of the Programs for backup purposes only in support of your use of the Programs on the single Product which was accompanied by the Programs. You shall not modify, or attempt to modify, the Programs.
- E. You may transfer the Programs and license them to another party only in connection with your transfer of the single Product which was accompanied by the Programs to such other party. At the time of such a transfer, you must also transfer all copies, whether in printed or machine readable form, of every Program, and the related documentation, to the same party or destroy any such copies not so transferred.
- F. You may not remove any copyright, trademark or other notice or product identification from the Programs and you must reproduce and include any such notice or product identification on any copy of any Program.

YOU MAY NOT REVERSE ASSEMBLE, REVERSE COMPILE, OR MECHANICALLY OR ELECTRONICALLY TRACE THE PROGRAMS, OR ANY COPY THEREOF, IN WHOLE OR IN PART.

YOU MAY NOT USE, COPY, MODIFY, ALTER, OR TRANSFER THE PROGRAMS OR ANY COPY THEREOF, IN WHOLE OR IN PART, EXCEPT AS EXPRESSLY PROVIDED IN THE LICENSE.

IF YOU TRANSFER POSSESSION OF ANY COPY OF ANY PROGRAM TO ANOTHER PARTY, EXCEPT AS PERMITTED IN PARAGRAPH E ABOVE, YOUR LICENSE IS AUTOMATICALLY TERMINATED.

TERM

This license is effective only for so long as you own or lease the Product, unless earlier terminated. You may terminate this license at any time by destroying, at your expense, the Programs and related documentation together with all copies thereof in any form. This license will also terminate effective immediately upon occurrence of the conditions therefor set forth elsewhere in this Agreement, or if you fail to comply with any term or condition contained herein. Upon any such termination, you agree to destroy, at your expense, the Programs and related documentation together with all copies thereof in any form.

YOU ACKNOWLEDGE THAT YOU HAVE READ THIS AGREEMENT, UNDERSTAND IT AND AGREE TO BE BOUND BY ITS TERMS AND CONDITIONS. YOU FURTHER AGREE THAT IT IS THE COMPLETE AND EXCLUSIVE STATEMENT OF THE AGREEMENT BETWEEN US, WHICH SUPERSEDES ANY PROPOSAL OR PRIOR AGREEMENT, ORAL OR WRITTEN, AND ANY OTHER COMMUNICATIONS BETWEEN US, RELATING TO THE SUBJECT MATTER OF THIS AGREEMENT.

About Intel® software products

The enclosed software products and documentation were developed at private expense, and are provided with "RESTRICTED RIGHTS." Use, duplication or disclosure by the government is subject to restrictions as set forth in FAR 52.227-14 and DFARS 252.227-7013 et. seq. or its successor. The use of this product by the government constitutes acknowledgment of Intel's proprietary rights in the product.

Contrat de licence d'usage limité

Le(s) logiciel(s) (les "Logiciels") fournis avec ce produit Panasonic® (le "Produit") sont exclusivement concédés en licence à l'utilisateur ultime ("vous"), et ils ne peuvent être utilisés que conformément aux clauses contractuelles ci-dessous. En utilisant les logiciels, vous vous engagez de manière définitive à respecter les termes, clauses et conditions des présentes.

Matsushita Electric Industrial Co., Ltd. ("MEI") a mis au point ou obtenu les Logiciels et vous en concède l'utilisation par les présentes. Vous assumez l'entière responsabilité du choix de ce Produit (y compris des Logiciels associés) pour obtenir les résultats escomptés, ainsi que de l'installation, de l'utilisation et des résultats obtenus.

Licence

- A. MEI vous octroie par les présentes le droit et la licence personnels, non cessibles et non exclusifs d'utiliser les Logiciels conformément aux termes, clauses et conditions de ce Contrat. Vous reconnaissez ne recevoir qu'un droit limité d'utiliser les Logiciels et la documentation les accompagnant et vous vous engagez à n'obtenir aucun droit de titre, propriété ni aucun autre droit vis-à-vis des Logiciels et de la documentation les accompagnant ni vis-à-vis des algorithmes, concepts, dessins, configurations et idées représentés par ou incorporés dans les Logiciels et la documentation les accompagnant, dont les titres, propriété et droits resteront tous à MEI ou à leurs propriétaires.
- B. Vous ne pouvez utiliser les Logiciels que sur le Produit unique qui est accompagné par les Logiciels.
- C. Vous et vos employés ou agents êtes requis de protéger la confidentialité des Logiciels. Vous ne pouvez ni distribuer ni mettre les Logiciels et la documentation les accompagnant à la disposition d'un tiers, par partage de temps ou de quelque autre manière que ce soit, sans l'autorisation écrite préalable de MEI.
- D. Vous ne pouvez ni copier ni reproduire ni permettre la copie ni la reproduction des Logiciels ni de la documentation les accompagnant pour quelque fin que ce soit, à l'exception d'une (1) copie des Logiciels à des fins de sauvegarde uniquement pour soutenir votre utilisation des Logiciels sur le Produit unique qui est accompagné par les Logiciels. Vous ne pouvez ni modifier ni tenter de modifier les Logiciels.
- E. Vous ne pouvez céder les Logiciels et en octroyer la licence à une autre partie qu'en rapport avec votre cession du Produit unique qui est accompagné par les Logiciels à cette autre partie. Au moment de cette cession, vous devez céder également toutes les copies, que ce soit sous forme imprimée ou lisible par la machine, de tous les Logiciels ainsi que de la documentation les accompagnant, à la même partie ou détruire les copies non cédées.
- F. Vous ne pouvez retirer aucune marque de droits d'auteur, marque ou autre ni aucune identification de produit des Logiciels et vous devez reproduire et inclure toutes ces notices ou identifications de produit sur toutes les copies des Logiciels.

Vous ne pouvez assembler en sens inverse, compiler en sens inverse ni retracer les Logiciels ni aucune de leurs copies, de façon électronique ou mécanique, en tout ou en partie.

Vous ne pouvez utiliser, copier, modifier, altérer ni céder les Logiciels ni aucune de leurs copies, en tout ou en partie, à l'exception de ce qui est expressément stipulé dans ce contrat.

Si vous cédez la possession de toute copie ou de tout Logiciel à une autre partie, à l'exception de ce qui est autorisé au paragraphe E ci-dessus, votre licence est automatiquement résiliée.

Termes, clauses et conditions

Cette licence n'est effective que pour la durée de possession ou de crédit-bail du Produit, à moins d'une résiliation antérieure. Vous pouvez résilier cette licence à tout moment en détruisant, à vos frais, les Logiciels et la documentation les accompagnant avec toutes leurs copies, sous quelque forme que ce soit. Cette licence sera également résiliée, avec application immédiate, si les conditions de résiliation définies ailleurs dans ce contrat se sont réalisées ou si vous ne respectez pas les termes, clauses et conditions qui y sont contenues. Au moment de la résiliation, vous acceptez de détruire, à vos frais, les Logiciels et la documentation les accompagnant avec toutes leurs copies, sous quelque forme que ce soit.

Vous reconnaissez avoir lu ce contrat, en avoir compris toute la substance et avoir accepté de respecter ses termes, clauses et conditions. Vous reconnaissez en outre qu'ils sont la description complète et exclusive du contrat conclu entre nous, contrat qui remplace et annule toute proposition ou contrat précédent, écrit ou oral, et toute autre communication entre nous, relativement à l'objet du présent contrat.

Hard Disk Backup Function

The hard disk backup function creates a backup area (storage area) on the hard disk. This area is to back up (store) hard disk contents or restore backed up contents to their original locations.

By backing up the data on your hard disk to a backup area, you can protect your data from loss or damage resulting from operational errors or other factors. Also, you can back up or restore hard disk contents using this computer alone, without having to use other media or peripheral devices.

At the time of purchase, the hard disk backup function is disabled. If you follow the procedure below to create a backup area, the hard disk backup function will be enabled, and you will be able to back up your data. Note, that once the backup function has been enabled, you will have to perform the reinstallation procedure to disable it again (☞ page 35).

The hard disk backup function cannot back up or restore data properly if there is a problem with the hard disk when the data is backed up or restored. Note that if an error occurs while data is being restored, whether as a result of an unexpected malfunction, incorrect operation, or other reason, the data in the hard disk (data before restoration) may be lost.

Matsushita Electric Industrial Co., Ltd. will bear no responsibility for any damages suffered by the user (including loss of data) as a result of the use of this function.

Preparing

- Product Recovery CD-ROM (included)
- Panasonic USB CD/DVD drive (optional: CF-VDRRT1M, CF-VDRRT2W or CF-VDRRT3W)

Before Using a Hard Disk Backup Function

- Disconnect or remove all peripheral devices (except for the CD/DVD drive) and SD Memory Cards, as the backup area may not be created properly while these devices are connected.
- Be sure the AC adaptor is connected to the computer.
- A backup area cannot be created if the hard disk is already divided into several partitions. Return the computer to its condition at the time of purchase (one partition only), and create the backup area.
- To divide the partition, make the selection when the backup area is created (☞ page 40 step 8).
- If the partition configuration is changed (partitions created, size changed, etc.) after the backup area has been created, it will no longer be possible to execute the backup function. To change the configuration, it is necessary to return the computer to its condition at the time of purchase, and then create the backup area again.
- The hard disk backup function will only work for the internal hard disk. This function does not work with an external hard disk.
- Backup and restore functions will not operate if the hard disk has been damaged.
- Do not use the NTFS file system compression function, as this may result in insufficient capacity of the backup area.
- If the hard disk malfunctions, it will be impossible to read the data stored on it. We recommend that you also back up important data to a location other than the hard disk (an external hard disk or other media).
- Execute a disk error check using the following procedure.
 - 1 Select [start] - [My Computer], right-click [Local Disk(C:)] and select [Properties].
 - 2 Select [Check Now] from [Tools].
 - 3 In [Check Disk], select [Start] without adding a check mark beside any of the items.
If a message is displayed indicating that there is an error in the disk, display [Check Disk], and add a check mark for [Automatically fix file system errors] and [Scan for and attempt recovery of bad sectors], select [Start], and check for disk errors again.
- The hard disk backup function does not accommodate dynamic disks. Do not convert the hard disk to a dynamic disk.

Hard Disk Backup Function

NOTE

- Regarding backup area
 - Requires availability of at least half of the entire hard disk. Without sufficient space available, the backup area cannot be created.
 - When the backup area is created, the usable hard disk capacity will be reduced to less than half.
 - The backup area cannot be accessed from Windows. For this reason, backed up data cannot be copied to CD-R or other removable disk media.
 - When the hard disk backup function is executed, data in the backup area will be overwritten. If newly created or edited data is backed up later, data stored previously in the backup area will be lost.

Create a Backup Area

- 1 Turn off the computer and connect the CD/DVD drive to the USB port.
- 2 Turn on the computer, and press **(F2)** while [Panasonic] boot screen is displayed. The Setup Utility will start up. If a password has been set, enter the Supervisor Password. You cannot register [Boot] menu with a User Password.
- 3 Select [Boot] menu, then select [USB CDD] and press **(F6)** until [USB CDD] is at the top of the [Boot] menu.
- 4 Place disc number one of the recovery CDs into the CD/DVD drive.
- 5 Press **(F10)**.
At the confirmation message, select [Yes] and press **(Enter)**.
The computer will restart. If [Enter Password] is displayed during the following procedures, input the Supervisor Password or the User Password.
This screen should appear.

```
-----  
Select a number  
-----  
1. [ Recovery ] Reinstall Windows.  
2. [ Erase HDD ] Erase the whole data on HDD for security.  
3. [ Backup   ] Enable the Backup function.  
  
0. [ Cancel   ] Cancel.  
-----
```

- 6 Press **(3)** to execute [3.[Backup]].

CAUTION

- When dividing the hard disk into partitions
Do not execute [1. [Recovery]] to divide the hard disk into partitions. The hard disk backup function cannot be enabled after the hard disk has been partitioned. Use procedure **8** to divide the hard disk.

- 7 At the confirmation message, press **(Y)**.
- 8 Select how to divide the hard disk from the menu.
<To create a backup area and enable the backup function without dividing the hard disk>
Select [1].

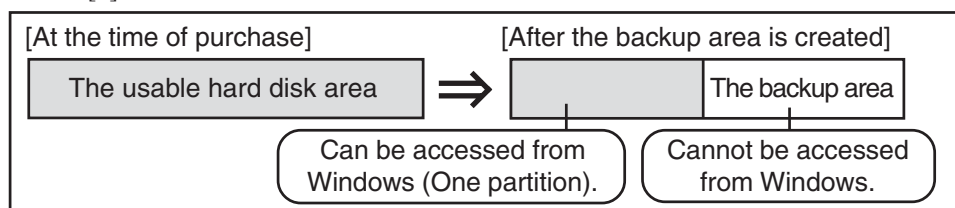

<To create a backup area and divide hard disk into two partitions, for OS and data>
Select [2], enter the partition size (GB), and press **Enter**.

- You can cancel this operation by pressing **0**.
- The data partition size will be the maximum settable size less the number entered above. The maximum settable size will differ depending on models.

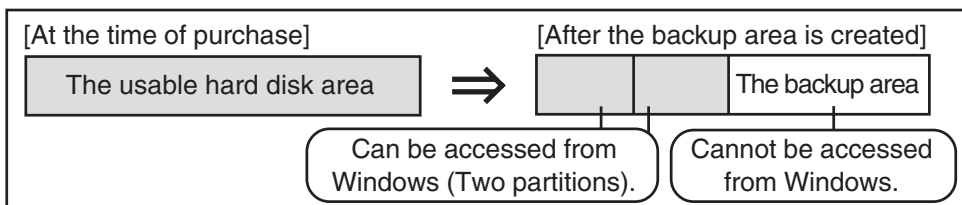

- 9 At the confirmation message, press **Y**.
The backup area is then created.
- 10 When the message [You must reboot in order to enable the Backup function] appears, remove the recovery CD, and press any key to restart the computer. The computer is restarted, then the backup process will begin.
- 11 When the message [[Backup] is complete] appears, press **Ctrl** + **Alt** + **Del** to restart the computer.

CAUTION

- Do not press **Ctrl** + **Alt** + **Del** until the message is displayed.

- 12 After logging on to Windows, a message will appear advising that a new device has been installed and that the computer must be restarted to enable the settings. Select [Yes] to restart the computer.

NOTE

- The [Boot] menu in the Setup Utility is set to start up from the CD/DVD drive. Change this setting if necessary.
- The next time the backup or restore functions are executed, follow the procedure for “Backing Up and Restoring Data” (☞ below).

Backing Up and Restoring Data

CAUTION

- Before executing the backup function, execute a disk error check. (☞ page 39)
- Do not interrupt the backup or restore functions before completion, for example by turning off the power or pressing **Ctrl** + **Alt** + **Del**, as this may prevent Windows from starting up, or may cause data to be lost so that the backup and restore functions cannot be executed.

- 1 Turn the computer on, and press **F2** while [Panasonic] boot screen is displayed. The Setup Utility will start up.
If a password has been set, enter the Supervisor Password or the User Password.
- 2 Select [Exit] menu, then select [Hard Disk Backup / Restore] and press **Enter**.
At the confirmation message, select [Yes] and press **Enter**.

Hard Disk Backup Function

- 3 Select the operation to be executed from the menu.
<To back up hard disk contents to the backup area>
 - ① Press **1** to execute [1. [Backup]].
(When dividing the hard disk into two partitions, select the backup method at next screen.)
 - ② At the confirmation message, press **Y**.
The backup process will begin.<To restore backed up contents to the hard disk>
 - ① Press **2** to execute [2. [Restore]].
(When data is backed up in two partitions, select the restore method at next screen.)
 - ② At the confirmation message, press **Y**.
The restore process will begin.

NOTE

- The time required to complete the backup or restore process differs depending on the data volume.

- 4 When the message [[Backup] is complete] or [[Restore] is complete] is displayed, press **Ctrl** + **Alt** + **Del** to restart the computer.
 - If the backup or restore process was interrupted before completion, for example if the power was turned off, execute the process again.
 - After logging on to Windows, when a new device is installed and a message appears advising that the computer must be restarted to enable the settings, select [Yes] to restart the computer.

CAUTION

- When the hard disk backup function has been enabled, the backed up data will not be erased even if a commercial data erasing utility or similar software is used to erase all data from user-accessible area. To erase all data on the hard disk, including backed up data, use a commercial data erasing utility after disabling the hard disk backup function following the procedure below, or use the hard disk data erase utility included in this computer (☞ page 43).
 - Occasionally, the message [#1805 cannot write image file] will be displayed, and the backup function will be interrupted. If this error occurs, execute the backup function again. After this, if the backup function is completed properly, then there is no problem in the hard disk.
- To disable the hard disk backup function
Perform the reinstallation procedure. All data in the backup area and the hard disk will be erased. Conduct steps **1-8** for “Reinstalling Software” (☞ page 35). Select [1] or [2] to execute the reinstallation at the screen for executing the reinstallation.
 - When [1] is selected, the hard disk backup function will be disabled.
 - When [2] is selected, the hard disk backup function will be disabled, but in this case, because the hard disk has been divided into partitions, the hard disk backup function cannot be re-enabled (☞ page 28).
 - When [3] is selected, the hard disk backup function cannot be disabled.

Hard Disk Data Erase Utility

This computer is equipped with a utility for erasing hard disk data.

When disposing of or transferring ownership of this device, erase all data on the hard disk in order to prevent the theft of hard disk data by following the steps below.

The hard disk data erase utility erases data using an “overwriting” method, but there is a possibility that due to malfunctions or other operational errors, data may not be completely erased. There are also specialized devices that may be able to read data that has been erased using this method. If you need to erase highly confidential data, we recommend that you contact a company that specializes in this process. Matsushita Electric Industrial Co., Ltd. will bear no responsibility for losses or damages suffered as a result of the use of this utility.

Preparing

- Product Recovery CD-ROM (included)
- Panasonic USB CD/DVD drive (optional: USB CD/DVD drive (optional: CF-VDRRT1M, CF-VDRRT2W or CF-VDRRT3W)

NOTE

- Be sure the AC adaptor is connected until the procedure is completed.
- This utility can only be used for internal hard disk. It cannot be used to erase data from external hard disks.
- This utility cannot erase data from damaged disk.
- This utility cannot erase data for specific partitions.
- After executing this utility, the computer cannot be booted from the hard disk.
- The backup area and the data in the backup area will be erased.

Procedure

- 1 Turn off the computer and connect the CD/DVD drive to the USB port.
- 2 Turn the computer on, and press **(F2)** while [Panasonic] boot screen is displayed.
The Setup Utility will start up.
If the password has been set, enter the Supervisor Password.
- 3 Select [Boot] menu, then select [USB CDD] and press **(F6)** until [USB CDD] is at the top of the [Boot] menu.
- 4 Place disc number one of the recovery CDs into the CD/DVD drive.
- 5 Press **(F10)**. At the confirmation message, select [Yes] and press **(Enter)**.
The computer will restart, and this screen should appear.

```
-----  
Select a number  
-----  
1. [ Recovery ] Reinstall Windows.  
2. [ Erase HDD ] Erase the whole data on HDD for security.  
3. [ Backup   ] Enable the Backup function.  
-----  
0. [ Cancel   ] Cancel.  
-----
```

<When the hard disk backup function has been enabled>
When the message [The Backup function has been enabled. If [Recovery] or [Erase HDD] is executed, the Backup function will be disabled, and your Backup data will be lost.] appears, press **(Y)**.
- 6 Press **(2)** to execute [2. [Erase HDD]].
(You can cancel this operation by pressing **(0)**.)
<When the hard disk backup function has been enabled>
When the message [The Backup function has been enabled. If [Erase HDD] is executed, the Backup function will be disabled, and your Backup data will be lost.] appears, press **(Y)**.
When the message [Computer must be rebooted in order to execute [Erase HDD].] appears, press **(R)**.
- 7 At the confirmation message, press **(Y)**.
- 8 When [<<<Start Menu>>>] is displayed, press **(Enter)**.
- 9 The approximate time required for erasing data will be displayed.
Press **(Space)**.
- 10 At the confirmation message, press **(Enter)**.
The operation of erasing the hard disk will start.
(If necessary, the “hard disk data erase” operation can be cancelled after it has begun by pressing **(Ctrl)** + **(C)**.
If the operation is cancelled before being completed, a part of the data will not be erased.)
- 11 After the operation is complete:
Under normal conditions, the message [Hard disk data has been deleted.] will be displayed.
If a problem occurred during the operation, an error message will be displayed.
- 12 Remove the recovery CD, and then press any key to turn off the computer.
- 13 Remove the CD/DVD drive.

Specifications

This page provides the specifications for the basic model CF-18KDHZXVM/CF-18KDHZBVM. The model number will change depending on the configuration of the unit, such as, CPU speed, memory size, HDD size, Operating System, LCD type, and whether a wireless LAN or Bluetooth® is built in or not.

- To check the model number:

Check the bottom of the computer or the box the computer came in at the time of purchase.

- To check CPU speed, memory size and the hard disk drive (HDD) size:

Run the Setup Utility (☞ Reference Manual “Setup Utility”).

Confirm the required information by checking the following items.

- [Information] menu
CPU speed: [CPU Speed] Memory size: [System Memory] Hard disk drive size: [Primary Master]
- [Advanced] menu
Wireless LAN: [Wireless LAN] is displayed only if a wireless LAN is built in.

● Main Specifications

Model No.		CF-18KDHZXVM	CF-18KDHZBVM
CPU		Intel® Pentium® M Processor 753 (1.2 GHz, 2 MB*1 L2 cache, 400 MHz FSB)	
Memory		512 MB*1 (1536 MB*1 Max.)	
Video Memory		UMA (128 MB*1 Max.)*2	
LCD	Type	10.4 type (TFT)	
	Displayed Colors*3	65,536/16,777,216 colors (800 x 600 dots/1024 x 768 dots)	
External Display		65,536/16,777,216 colors (800 x 600 dots/1024 x 768 dots/1280 x 1024 dots)*4	
Hard Disk Drive		60 GB*5	
Keyboard		Windows keyboard (82 keys)	
Pointing Device		Touch Pad Digitizer (Anti-Reflection)	
PC Card Slot		Two Type I or Type II, or one Type III	
Allowable current (total for two slots)		3.3 V: 400 mA, 5 V: 400 mA	
RAM Module Slot*6		200-pin, 1.8 V, SO-DIMM, DDR2-SDRAM, PC2-3200 Compliant	
SD Memory Card Slot*7		SD Memory Card	
Interface	Microphone Jack*8	Miniature jack, 3.5 DIA	
	Headphone Jack	Miniature jack, 3.5 DIA	
	USB Port	4-pin x 2, USB2.0	
	Modem	RJ-11 Data: 56 kbps (V.92 & K56flex*9) FAX: 14.4 kbps	
	LAN	RJ 45 IEEE 802.3 10Base-T, IEEE 802.3u 100Base-TX	
	Wireless LAN	Built-in Intel® PRO/Wireless 2915 ABG (☞ page 45)	
	Bluetooth®		Built-in (☞ page 45)
	Expansion Bus Connector	Dedicated 100-pin female	
	External Display Port	Mini Dsub 15-pin female	
	External Antenna Connector	Dedicated 50 Ω coaxial connector x 2	
Sound		WAVE and MIDI playback, Monaural Speaker (built in)	
Battery Pack		Li-ion 7.4 V, 7.65 Ah	
Charging Time*10	Operating Time*10	Approx. 4.5 hours - 8.5 hours*11 (Approx. 6.5 hours*12)	
	Power On	Approx. 7 hours	
		Power Off	Approx. 4 hours
Clock Battery		Coin type lithium battery 3.0 V	
AC Adaptor*13		Input: 100 V - 240 V AC, 50 Hz / 60 Hz Output: 16.0 V DC, 2.5 A	
Power Consumption*14		Approx. 26 W*15 / Approx. 40 W (maximum when recharging in the ON state)	
Environment	Operation	Temperature	5 °C to 35 °C {41 °F to 95 °F}
		Humidity	30% to 80% RH (No condensation)
	Storage	Temperature	-20 °C to 60 °C {-4 °F to 140 °F}
		Humidity	30% to 90% RH (No condensation)
Physical Dimensions*16 (W X H X D)		271 mm X 49 mm X 216 mm {10.7 " X 1.93 " X 8.5 "}	
Weight*16		Approx. 2.1 kg {Approx. 4.5 lb.}	

- *1 1 MB = 1,048,576 bytes
- *2 A segment of the main memory is allotted automatically depending on the computer's operating status. The size of the Video Memory cannot be set by the user.
- *3 A 16,777,216 color display is achieved by using the dithering function.
- *4 Maximum resolution depends on the specifications of the external display.
- *5 1GB = 1,000,000,000 bytes. Your operating system or some application software will report as fewer GB.
- *6 A PC2-3200-compliant or PC2-4200-compliant RAM module can be added. A PC2-4200-compliant RAM module added to this computer, operates at the same speed as a PC2-3200-compliant RAM module.
- *7 This slot does not support the MultiMedia card.
Operation has been confirmed for Panasonic SD Memory Cards with up to 1 GB capacity.
- *8 Use only a monaural condenser microphone.
- *9 The settings for the K56flex modem need to be changed according to the AT command.
- *10 Varies depending on the usage conditions, CPU speed, etc.
- *11 Measured using BatteryMark™ Version 4.0.1 (LCD brightness: Maximum - Minimum)
- *12 Measured using MobileMark™ 2002 (LCD brightness: 60 cd/m²)
- *13 <Only for North America>
The AC adaptor is compatible with power sources up to 240 V AC adaptor. The computer is supplied with a 125 V AC compatible AC cord.
- *14 Approx. 1.0 W when the battery pack is fully charged (or not being charged) and the computer is off.
Approx. 1.5 W when the Wake up from LAN function has been enabled.
- *15 Rated power consumption.
- *16 The dimensions and weight do not include the hand strap.

● Wireless LAN (only for models with wireless LAN)

Data transfer rates ^{*17}	IEEE802.11a: 54/48/36/24/18/12/9/6 Mbps (automatically switched)
	IEEE802.11b: 11/5.5/2/1 Mbps (automatically switched)
	IEEE802.11g: 54/48/36/24/18/12/9/6 Mbps (automatically switched)
Standards supported	IEEE802.11a/IEEE802.11b/IEEE802.11g
Transmission method	OFDM system, DS-SS system
Wireless channels used	IEEE802.11a: Channels 36/40/44/48/52/56/60/64/149/153/157/161/165 IEEE802.11b/IEEE802.11g: Channels 1 to 11
RF frequency band	IEEE802.11a: 5.18~5.32 GHz, 5.745~5.825 GHz
	IEEE802.11b/IEEE802.11g: 2412~2462 MHz

*17 These are speeds specified in IEEE802.11a+b+g standards. Actual speeds may differ.

● Bluetooth®

Bluetooth Version	1.2
Transmission Method	FHSS system
Wireless Channels Used	Channels 1 to 79
RF Frequency Band	2.402-2.48 GHz

● Software

Operating System	Microsoft® Windows® XP Tablet PC Edition 2005	
Utility Programs	Setup Utility DMI Viewer Microsoft® Windows® Media Player 10 Adobe Reader Intel® PROSet/Wireless Software ^{*18} Display Rotation Tool PC Information Viewer Hard Disk Backup Utility ^{*19} Hard Disk Data Erase Utility ^{*19}	SD Utility Icon Enlarger Loupe Utility Hotkey Settings Battery Recalibration Utility Wireless LAN Switch ^{*18} Wireless Switch Utility ^{*20} Bluetooth Switch ^{*21}

*18 Only for models with wireless LAN.

*19 The Product Recovery CD-ROM is required.

*20 Only for models with wireless LAN and/or Bluetooth.

*21 Only for models with Bluetooth.

LIMITED WARRANTY

For U.S.A.

PANASONIC PERSONAL COMPUTER AND PERIPHERALS LIMITED WARRANTY

Panasonic Computer Solutions Company (referred to as "Panasonic") will repair this product (other than software, which is covered by a separate warranty) with new or rebuilt parts, free of charge in the U.S.A. for three (3) years from the date of original purchase in the event of a defect in materials or workmanship. This warranty includes the AC adaptor but excludes the batteries and all other options and accessories which are covered for a period of one (1) year from the date of purchase.

This warranty is extended solely to the original purchaser. A purchase receipt or other proof of date of original purchase will be required before warranty performance is rendered.

This warranty only covers failures due to defects in materials or workmanship which occur during normal use. It does not cover damage which occurs in shipment or failures which are caused by products not supplied by Panasonic, or failures which result from alteration, accident, misuse, introduction of liquid or other foreign matter into the unit, abuse, neglect, installation, maladjustment of consumer controls, improper maintenance, modification or service by anyone other than a Factory Service Center or authorized Panasonic Service Dealer, or damage that is attributable to acts of God.

Limits and Exclusions:

There are no other express warranties except as listed below.

PANASONIC SHALL NOT BE LIABLE FOR LOSS OF DATA OR OTHER INCIDENTAL OR CONSEQUENTIAL DAMAGES RESULTING FROM THE USE OF THIS PRODUCT, OR ARISING OUT OF ANY BREACH OF THIS WARRANTY. ALL EXPRESS AND IMPLIED WARRANTIES, INCLUDING THE WARRANTIES OF MERCHANTABILITY AND FITNESS FOR A PARTICULAR PURPOSE ARE LIMITED TO THE APPLICABLE WARRANTY PERIOD SET FORTH ABOVE. Some states do not allow the exclusion or limitation of incidental or consequential damages, or limitations on how long an implied warranty lasts, so the above limitations or exclusions may not apply to you.

This limited warranty gives you specific legal rights, and you may also have other rights which vary from state to state. If a problem with your product develops during or after the warranty period, you may contact our representatives at 1-800-LAPTOP5. If the problem is not handled to your satisfaction, then write to the Consumer Affairs Division at the address indicated below.

SOFTWARE LIMITED WARRANTY

Panasonic Computer Solutions Company (referred to as "Panasonic") warrants to you only that the disk(s) or other media on which the Programs are furnished will be free from defects in materials and workmanship under normal use for a period of sixty (60) days from the date of delivery thereof to you, as evidenced by your purchase receipt.

This is the only warranty Panasonic makes to you. Panasonic does not warrant that the functions contained in the Programs will meet your requirements or that the operation of the Programs will be uninterrupted or error free.

Panasonic's entire liability, and your exclusive remedy under this warranty shall be limited to the replacement, in the United States, of any defective disk or other media which is returned to Panasonic's Authorized Service Center, together with a copy of the purchase receipt, within the aforesaid warranty period.

Anything in the foregoing to the contrary notwithstanding, Panasonic shall have no obligation for any defects in the disk(s) or other media on which the Programs are furnished resulting from your storage thereof, or for defects that have been caused by operation of the disk(s) or other media otherwise than on the Product or in environmental conditions other than those specified by Panasonic by alteration, accident, misuse, abuse, neglect, mishandling, misapplication, installation, maladjustment of consumer controls, improper maintenance, modification of damage that is attributable to acts of God. In addition, Panasonic shall have no obligation for any defects in the disk(s) or other media if you have modified, or attempted to modify any Program.

DURATION OF IMPLIED WARRANTIES, IF ANY, IS LIMITED TO SIXTY (60) DAYS.

PANASONIC ASSUMES NO RISK OF AND SHALL NOT IN ANY CASE BE LIABLE FOR ANY DAMAGES, INCLUDING, WITHOUT LIMITATION, ANY SPECIAL, INCIDENTAL, CONSEQUENTIAL, OR PUNITIVE DAMAGES ARISING FROM BREACH OF WARRANTY OR CONTRACT, NEGLIGENCE OR ANY OTHER LEGAL THEORY, INCLUDING, WITHOUT LIMITATION LOSS OF GOODWILL, PROFITS OR REVENUE, LOSS OF USE OF THE PROGRAMS OR PRODUCTS OR ANY ASSOCIATED EQUIPMENT, COST OF CAPITAL, COST OF ANY SUBSTITUTE EQUIPMENT, FACILITIES, SERVICES, DOWNTIME COSTS, OR CLAIMS OF ANY PARTY DEALING WITH YOU FOR SUCH DAMAGES.

Some states do not allow the exclusion or limitation of incidental or consequential damages, or limitations on how long an implied warranty lasts, so the above limitations or exclusions may not apply to you.

This limited warranty gives you specific legal rights, and you may also have other rights which vary from state to state.

This Limited Warranty will be governed by the laws the State of New York, without regard to its conflict-of-laws rules.

* * *

To obtain service or technical assistance within the continental U.S.A. and Alaska.

DIAL TOLL FREE: 1-800-LAPTOP5

Correspondence requesting product information should be sent to:
Panasonic Computer Solutions Company
50 Meadowlands Parkway, Panazip 2F-5, Secaucus, NJ 07094

For Canada

PANASONIC COMPUTER AND PERIPHERALS LIMITED WARRANTY

Coverage – Panasonic Canada Inc. (“PCI”) warrants to you, the first end user customer, this computer product (excluding software media), when purchased from PCI or from a PCI authorized reseller, to be free from defects in materials and workmanship under normal use, subject to the terms set forth below, during the period of warranty coverage specified.

Scope of Coverage	Period of Coverage	Type of Failure Coverage
Whole Product (except Batteries), AC adaptor and CD-ROM (if factory installed)	Three (3) Years from Date of Original End User Customer Purchase	Defective Materials or Workmanship
Batteries, CD-ROM (unless factory installed), Port Replicator, Extra Memory Modules and all other Peripherals, Options and Accessories	One (1) Year from Date of Original End User Customer Purchase	Defective Materials or Workmanship

Remedy – In the event of a warranty claim, contact PCI’s representatives within the applicable warranty period, identifying the nature of the defect claimed, at 1-800-668-8386 between 9:00 A.M. and 5:00 P.M., Eastern Time Zone, Mon. – Fri. (excluding holidays) for instructions on how to obtain service. A purchase receipt or other proof of date of original purchase is required before warranty service is performed. Defective parts covered by this Limited Warranty will be repaired or replaced with new or comparable rebuilt parts on an exchange basis. Warranty replacement or repair is subject to the terms of this Limited Warranty for the balance of the original period of warranty coverage.

No Coverage – This Limited Warranty does not cover products purchased outside Canada. Neither does it cover damage to, failure of, or defects in a product or accessory through mishandling, improper installation, abnormal use, misuse, neglect, accident, introduction of liquid or other foreign matter into the product, alteration or servicing by anyone not authorized by PCI, or act of God.

IF YOU SHIP THE PRODUCT FOR WARRANTY SERVICE

Carefully pack the product, preferably in the original carton. Include details of defect claimed and proof of date of original purchase. No liability is assumed for loss or damage to the product while in transit, if you chose your own transportation carrier.

SOFTWARE MEDIA LIMITED WARRANTY

Coverage – Panasonic Canada Inc. (“PCI”) warrants to you, the first end user customer, that the disk(s) or other media on which software program(s) is/are supplied will be free from defects in materials and workmanship under normal use in Canada for a period of sixty (60) days from date of receipt as evidenced by your purchase receipt for your Panasonic Computer product.

THIS IS THE ONLY WARRANTY THAT PCI MAKES RESPECTING THE SOFTWARE MEDIA. PCI does not warrant the software. Please refer to the software licensor’s written warranty (accompanying the copy of the software) for any software warranty claim.

Claim Procedure – In the event of a defect in material or workmanship in the media during the sixty (60) day warranty period, and you return it, transportation costs prepaid, to Panasonic Canada Inc., Computer Products Marketing, at the above address, within the warranty period, together with a copy of your purchase receipt, and an explanation of the suspected defect, PCI will replace in Canada the defective disk(s) or other media.

Remedy – PCI’s entire liability, and your only remedy for any breach of this software media warranty is limited to replacement of the media only. It does not cover any other damages, including, but not limited to, loss of use or profit loss, or special, indirect or consequential damages, or other claims, whether or not of similar character.

No Coverage – This limited warranty does not apply if the disk(s) or other media has been used in other than a Panasonic product, or in environmental conditions other than those specified by PCI or the manufacturer, or if subjected to misuse, neglect, mishandling, modification or attempted modification of the program, or if damaged by accident or act of God. PCI is not responsible for damage to or loss of any program, data or removable storage media.

GENERAL

NO OTHER WARRANTIES – PCI DISCLAIMS ALL OTHER WARRANTIES, EITHER EXPRESS OR IMPLIED, INCLUDING, BUT NOT LIMITED TO, IMPLIED WARRANTIES OF MERCHANTABILITY AND FITNESS FOR A PARTICULAR PURPOSE, WITH RESPECT TO THE SOFTWARE, SOFTWARE MEDIA, COMPUTER PRODUCT, OPTIONS AND ACCESSORIES.

NO LIABILITY FOR CONSEQUENTIAL DAMAGES – IN NO EVENT SHALL PCI BE LIABLE FOR ANY SPECIAL, INDIRECT OR CONSEQUENTIAL DAMAGES ARISING FROM ANY BREACH OF THE LIMITED WARRANTIES SET OUT IN THIS DOCUMENT, OR FROM THE USE OF THE COMPUTER PRODUCT, INCLUDING, WITHOUT LIMITATION, LOSS OF DATA, BUSINESS, PROFIT OR GOODWILL.

IN ANY EVENT, PCI’S MAXIMUM LIABILITY FOR ANY BREACH SHALL NOT EXCEED THE AMOUNT ACTUALLY PAID BY YOU FOR THE COMPUTER PRODUCT.

NO ACTION, REGARDLESS OF ITS BASIS, MAY BE BEGUN AGAINST PCI MORE THAN TWO (2) YEARS AFTER THE CAUSE OF ACTION AROSE.

Statutory Warranties – Some jurisdictions do not allow these limitations or exclusions, so they may not apply to you.



As an ENERGY STAR® Partner, Matsushita Electric Industrial Co., Ltd. has determined that this product meets the ENERGY STAR® guidelines for energy efficiency.

Outline of the International ENERGY STAR® Office Equipment Program

The international ENERGY STAR® Office Equipment Program is an international program that promotes energy saving through the use of computers and other office equipment. The program backs the development and dissemination of products with functions that effectively reduce energy consumption. It is an open system in which business proprietors can participate voluntarily. The targeted products are office equipment such as computers, displays, printers, facsimiles, and copiers. Their standards and logos are uniform among participating nations.

Panasonic Computer Solutions Company

50 Meadowlands Parkway, Panazip 2F-5,
Secaucus, NJ 07094

Panasonic Canada Inc.

5770 Ambler Drive Mississauga,
Ontario L4W 2T3

