

Panasonic®

OPERATING INSTRUCTIONS

Personal Computer

Model No. **CF-19** series

Contents

Getting Started

Introduction.....	2
Read Me First.....	3
Description of Parts.....	10
First-time Operation.....	13

Getting Started

Useful Information

On-screen Manual.....	16
Handling and Maintenance.....	17
Hard Disk Backup Function (Recover Pro).....	19
Hard Disk Data Erase Utility.....	21
Reinstalling Software.....	22

Useful Information

Troubleshooting

Error Code/Message.....	24
Troubleshooting (Basic).....	25
Hardware Diagnostics.....	29

Troubleshooting

Appendix

LIMITED USE LICENSE AGREEMENT.....	32
Specifications.....	34
LIMITED WARRANTY.....	36

Appendix

For further information about the computer, you can refer to the on-screen manual.

To access the on-screen manual
→ page 16 “On-screen Manual”

Introduction

Thank you for purchasing this Panasonic computer. For optimum performance and safety, please read these instructions carefully.

■ Terms and illustrations in these instructions

CAUTION	:	Conditions that may result in minor or moderate injury.
NOTE	:	Useful and helpful information.
Enter	:	Press [Enter] key.
Fn + F5	:	Press and hold [Fn] key, and then press [F5] key.
[start] - [Run]	:	Click [start], and then click [Run]. You may need to double-click in some cases.
→	:	Page in these Operating Instructions or in the Reference Manual.
	:	Reference to the on-screen manuals.

- Some illustrations are simplified to help your understanding and may look different from the actual unit.
- If you do not log on as an administrator, you cannot use some functions or cannot display some screens.
- Refer for the latest information about optional products to the catalogs, etc.
- In these instructions, the names and terms are referred as follows.
 - “Microsoft® Windows® XP Professional Service Pack 2 with Advanced Security Technologies” as “Windows”, “Windows XP” or “Windows XP Professional”
 - “Microsoft® Windows® XP Tablet PC Edition 2005” as “Windows”, “Windows XP” or “Windows XP Tablet PC Edition”
 - DVD-ROM & CD-R/RW drive, and DVD MULTI drive as “CD/DVD drive”
 - Circular media including DVD-ROM and CD-ROM as “discs”
- The display modes are referred as follows. () indicates the terms in [Intel® Graphics Media Accelerator Driver for Mobile] screen. To display the screen, click [start] - [Control Panel] - [Other Control Panel Options] - [Intel(R) GMA Driver for Mobile].
 - Internal LCD (Notebook): The computer’s display
 - External display (Monitor): External display
 - Simultaneous display (Intel® Dual Display Clone): The same screen is displayed on the internal LCD and the external display.
 - Extended desktop: The extended working area across the internal LCD and the external display.

■ Copyright

This manual is copyrighted by Matsushita Electric Industrial Co., Ltd. with all rights reserved. No part of this manual may be reproduced in any form without the prior written permission of Matsushita Electric Industrial Co., Ltd. No patent liability is assumed with respect to the use of the information contained herein.
© 2006 Matsushita Electric Industrial Co., Ltd. All Rights Reserved.

■ Disclaimer

Computer specifications and manuals are subject to change without notice. Matsushita Electric Industrial Co., Ltd. assumes no liability for damage incurred directly or indirectly from errors, omissions or discrepancies between the computer and the manuals.

■ Trademarks

Microsoft®, Windows®, the Windows logo and IntelliMouse are registered trademarks of Microsoft Corporation of the United States and/or other countries.

Intel, Core, Centrino and PROSet are either registered trademarks or trademarks of Intel Corporation.

SD Logo is a trademark. 

Adobe, the Adobe logo and Adobe Reader are either registered trademarks or trademarks of Adobe Systems Incorporated in the United States and/or other countries.

PhoenixBIOS, Phoenix Always and Recover Pro are trademarks and/or registered trademarks of Phoenix Technologies Ltd.

Bluetooth™ is a trademark owned by Bluetooth SIG, Inc., U.S.A. and licensed to Matsushita Electric Industrial Co., Ltd. Panasonic® is a registered trademark of Matsushita Electric Industrial Co., Ltd.

Names of products, brands, etc., appearing in this manual are trademarks or registered trademarks of their respective own companies.

Read Me First

Models for U.S.A.

Federal Communications Commission Radio Frequency Interference Statement

Note: This equipment has been tested and found to comply with the limits for a Class B digital device, pursuant to Part 15 of the FCC Rules. These limits are designed to provide reasonable protection against harmful interference in a residential installation. This equipment generates, uses and can radiate radio frequency energy and, if not installed and used in accordance with the instructions, may cause harmful interference to radio communications. However, there is no guarantee that interference will not occur in a particular installation. If this equipment does cause harmful interference to radio or television reception, which can be determined by turning the equipment off and on, the user is encouraged to try to correct the interference by one or more of the following measures:

- Reorient or relocate the receiving antenna.
- Increase the separation between the equipment and receiver.
- Connect the equipment into an outlet on a circuit different from that to which the receiver is connected.
- Consult the Panasonic Service Center or an experienced radio/TV technician for help.

Warning

To assure continued compliance, use only shielded interface cables when connecting to a computer or peripheral. Also, any changes or modifications not expressly approved by the party responsible for compliance could void the user's authority to operate this equipment.

FCC RF Exposure Warning:

- This equipment is provided with PC Card slot that could be used with wireless transmitters, which will be specifically recommended when they become available. Other third-party wireless transmitters have not been RF exposure evaluated for use with this computer and may not comply with FCC RF exposure requirements.

<Only for model with wireless LAN/Bluetooth>

- This equipment complies with FCC radiation exposure limits set forth for an uncontrolled environment.
- This equipment may not be co-located or operated with any other antenna or transmitter.
- This equipment has been approved for portable operation, and unless otherwise advised in separate supplemental instructions for individual wireless transmitter(s), requires minimum 1.5 cm spacing be provided between antenna(s) and all person's body (excluding extremities of hands, wrist and feet) during wireless modes of operation.
- This equipment may use multiple installed transmitters, which may be capable of simultaneous transmission.
- This equipment is provided with external antenna connector(s) for connection to optional Car Mounter or Port Replicator for mobile external mounted antenna(s). External antenna(s) must be professionally installed and cannot exceed recommended maximum antenna gain as described in individual provided supplement instructions for wireless transmitters. Also, user must maintain minimum 20 cm spacing between external antenna(s) and all person's body (excluding extremities of hands, wrist and feet) during wireless modes of operation.

<Only for model with wireless LAN>

- WLAN external antenna connector is intended for connection to Radiall/Larsen WLAN Base Whip antenna, type NM05E2400BKTNC with 5 dBi antenna.

<Only for model with wireless WAN>

- WWAN external antenna connector is intended for professional installation and should not exceed maximum antenna gain of 9.85 dBi for 824.7 - 848.31 MHz

operation and 8.34 dBi for 1851.25 - 1908.75 MHz operation.

This device complies with Part 15 of the FCC Rules. Operation is subject to the following two conditions:

- (1) This device may not cause harmful interference, and
- (2) This device must accept any interference received, including interference that may cause undesired operation.

Responsible Party: Panasonic Corporation of North America
One Panasonic Way
Secaucus, NJ 07094
Tel No:1-800-LAPTOP5 (1-800-527-8675)

6-M-1

FCC Regulation Notice for modem

This equipment contains a FCC approved modem.

FC Tested To Comply
With FCC Standards
FOR HOME OR OFFICE USE

1. This equipment complies with CFR47 Part 68 rules. On the computer is a label that contains, among other information, the FCC registration number and ringer equivalence number (REN) for this equipment. If required, this information must be provided to the telephone company.
2. An FCC compliant telephone cord and modular plug is provided with this equipment. This equipment is designed to be connected to the telephone network or premises wiring using a compatible modular jack which is Part 68 compliant. See Installation Instructions for details.
3. The REN is used to determine the quantity of devices which may be connected to the telephone line. Excessive RENs on the telephone line may result in the devices not ringing in response to an incoming call. In most, but not all area, the sum of RENs should not exceed five (5.0). To be certain of the number of devices that may be connected to a line, as determined by the total RENs, contact the local telephone company.
4. If your telephone equipment cause harm to the telephone network, the telephone company will notify you in advance that temporary discontinuance of service may be required. But if advance notice isn't practical, the telephone company will notify the customer as soon as possible. Also, you will be advised of your right to file a complaint with the FCC if you believe it is necessary.
5. The telephone company may take changes in its facilities, equipment, operations or procedures that could affect the operation of the equipment. If this happens the telephone company will provide advance notice in order for you to make necessary modifications to maintain uninterrupted service.
6. If trouble is experienced with this equipment, for repair or warranty information, please contact Panasonic Corporation of North America at DIAL TOLL FREE 1-800-LAPTOP5 (1-800-527-8675). If the equipment is causing harm to the telephone network, the telephone company may request that you disconnect the equipment until the problem is resolved.
7. There are no user serviceable parts contained in this equipment.
8. This equipment may not be used on coin service provided by the telephone company. Connection to party lines is subject to state tariffs.

Read Me First

9. The Telephone Consumer Protection Act of 1991 makes it unlawful for any person to use a computer or other electronic device to send any message via a telephone fax machine unless such message clearly contains in a margin at the top or bottom of each transmitted page or on the first page of the transmission, the date and time it is sent and an identification of the business or other entity, or other individual sending the message and the telephone number of the sending machine or such business, other entity, or individual. In order to program this information into your fax software, you should refer to the manual of the Fax software being used.
10. According to the FCC's electrical safety advisory, we recommend that you may install an AC surge arrestor in the AC outlet to which this equipment is connected. Telephone companies report that electrical surges, typically lightning transients, are very destructive to customer terminal equipment connected to AC power sources and that this is a major nationwide problem. "Caution : To reduce the risk of fire, use only No.26 AWG or larger telecommunication line cord."
"ATTENTION : Pour réduire le risque d'incendie, utiliser uniquement des conducteurs de télécommunications 26 AWG ou de section supérieure."

16-M-1

Notice for the products using LCD

This product uses one or more fluorescent lamps containing a small amount of mercury. It also contains lead in some components. Disposal of these materials may be regulated in your community due to environmental considerations. For disposal or recycling information please contact your local authorities, or the Electronics Industries Alliance: <<http://www.eiae.org/>>

24-M-1

UL1604-conforming model. (The model which has description of "UL1604" in the bottom of the computer.)

- THIS EQUIPMENT IS SUITABLE FOR USE IN CLASS I, DIVISION2, GROUPS A, B, C, AND D OR NON-HAZARDOUS LOCATIONS ONLY.
- WARNING-EXPLOSION HAZARD-SUBSTITUTION OF COMPONENTS MAY IMPAIR SUITABILITY FOR CLASS I, DIVISION2.
- When connecting and using a device manufactured by a third party, enquire to the manufacturer as to whether the device suits CLASS I, DIVISION2.

33-M-1

Models for Canada

Industry Canada (IC) Notice for modem

This equipment contains an Industry Canada approved modem unit.

The Industry Canada label is affixed on the modem unit.

EQUIPMENT ATTACHEMENT LIMITATIONS

"NOTICE: The Industry Canada label identifies certified equipment. This certification means that the equipment meets telecommunications network protective, operational and safety requirements as prescribed in the appropriate Terminal Equipment Technical Requirements document(s). The Department does not guarantee the equipment will operate to the user's satisfaction. Before installing this equipment, users should ensure that it is permissible to be connected to the facilities of the local telecommunications company. The equipment must also be installed using an acceptable method of connection. The customer should be aware that compliance with the above conditions may not prevent degradation of service in some situations.

Repairs to certified equipment should be coordinated by a representative designated by the supplier. Any repairs or alterations made by the user to this equipment, or equipment malfunctions, may give the telecommunications company cause to request the user to disconnect the equipment. Users should ensure for their own protection that the electrical ground connections of the power utility, telephone lines and internal metallic water pipe system, if present, are connected together. This precaution may be particularly important in rural areas. Caution: Users should not attempt to make such connections themselves, but should contact the appropriate electric inspection authority, or electrician, as appropriate."

"NOTICE: The Ringer Equivalence Number (REN) assigned to each terminal device provides an indication of the maximum number of terminals allowed to be connected to a telephone interface. The termination on an interface may consist of any combination of devices subject only to the requirement that the sum of the Ringer Equivalence Numbers of all the devices does not exceed 5."

REN: See bottom of the computer

RESTRICTIONS CONCERNANT LE RACCORDEMENT DE MATÉRIEL

"AVIS: L'étiquette d'Industrie Canada identifie le matériel homologué. Cette étiquette certifie que le matériel est conforme aux normes de protection, d'exploitation et de sécurité des réseaux de télécommunications, comme le prescrivent les documents concernant les exigences techniques relatives au matériel terminal. Le Ministère n'assure toutefois pas que le matériel fonctionnera à la satisfaction de l'utilisateur.

Avant d'installer ce matériel, l'utilisateur doit s'assurer qu'il est permis de le raccorder aux installations de l'entreprise locale de télécommunication. Le matériel doit également être installé en suivant une méthode acceptée de raccordement.

L'abonné ne doit pas oublier qu'il est possible que la conformité aux conditions énoncées ci-dessus n'empêche pas la dégradation du service dans certaines situations.

Les réparations de matériel homologué doivent être coordonnées par un représentant désigné par le fournisseur. L'entreprise de télécommunications peut demander à l'utilisateur de débrancher un appareil à la suite de réparations ou de modifications effectuées par l'utilisateur ou à cause de mauvais fonctionnement.

Pour sa propre protection, l'utilisateur doit s'assurer que tous les fils de mise à la terre de la source d'énergie électrique, des lignes téléphoniques et des canalisations d'eau métalliques, s'il y en a, sont raccordés ensemble. Cette précaution est particulièrement importante dans les régions rurales. Avertissement: L'utilisateur ne doit pas tenter de faire ces raccordements lui-même; il doit avoir recours à un service d'inspection des installations électriques, ou à un électricien, selon le cas."

"AVIS: L'indice d'équivalence de la sonnerie (IES) assigné à chaque dispositif terminal indique le nombre maximal de terminaux qui peuvent être raccordés à une interface. La terminaison d'une interface téléphonique peut consister en une combinaison de quelques dispositifs, à la seule condition que la somme d'indices d'équivalence de la sonnerie de tous les dispositifs n'excède pas 5."

IES: Voir sous le fond de l'ordinateur

17-Ca-1

CSA C22 2 NO.213-conforming model. (The model which has description of “CSA C22 2 NO.213” in the bottom of the computer.)

- THIS EQUIPMENT IS SUITABLE FOR USE IN CLASS I, DIVISION2, GROUPS A, B, C, AND D OR NON-HAZARDOUS LOCATIONS ONLY.
- WARNING-EXPLOSION HAZARD-SUBSTITUTION OF COMPONENTS MAY IMPAIR SUITABILITY FOR CLASS I, DIVISION2.
- When connecting and using a device manufactured by a third party, enquire to the manufacturer as to whether the device suits CLASS I, DIVISION2.

33-Ca-1

<Only for model with wireless LAN/Bluetooth>

Industry Canada

This product complies with RSS210 Industry Canada. Operation is subject to the following two conditions;

- (1) this device may not cause interference, and
- (2) this device must accept any interference, including interference that may cause undesired operation of the device.

30-Ca-1-1

<Only for model with wireless LAN>

This product (local network devices) for the band 5150-5250 MHz is only indoor usage to reduce potential for harmful interference to co-channel Mobile Satellite systems.

High power radars are allocated as primary users (meaning they have priority) of 5250-5350 MHz and 5650-5850 MHz and these radars could cause interference and/or damage to LELAN devices.

30-Ca-2-1

This device has been designed to operate with an antenna having a maximum gain of 2.15 dBi. Antenna having a higher gain is strictly prohibited per regulations of Industry Canada. The Required antenna impedance is 50 ohms. To reduce potential radio interference to other users, the antenna type and its gain should be so chosen that the equivalent isotropically radiated power (EIRP) is not more than that required for successful communication.

25-Ca-1-1

<Only for model with Bluetooth>

This Class B digital apparatus complies with Canadian ICES-003.

Cet appareil numérique de la classe B est conforme à la norme NMB-003 du Canada.

7-M-1

Models for Europe

<Only for model with a “CE” mark on the bottom of the computer>

Declaration of Conformity (DoC)



“Hereby, we declare that this Personal Computer is in compliance with the essential requirements and other relevant provisions of the Directive 1999/5/EC.”

Hint:

If you want to get a copy of the original DoC of our products which relates to the R&TTE, please contact our web address: <http://www.doc.panasonic.de>

Contact:

Panasonic Services Europe
A Division of Panasonic Marketing Europe GmbH
Panasonic Testing Centre

Network connection.

The terminal equipment is intended for connection to the following public network;

In all the countries of European Economical Area;

- Public Switched Telephony Networks

Technical Features.

The terminal equipment includes the following features;

- DTMF dialing
- Maximum bitrate receiving mode: 56 kbit/s
- Maximum bitrate sending mode: 33.6 kbit/s

This product is designed to interwork with the Public Switched Telecommunication Networks in UK, Ireland, Netherlands, Sweden, Denmark, Finland, Switzerland, Luxembourg, Belgium, France, Germany, Spain, Portugal, Iceland, Greece, Italy, Norway and Austria.

18-E-1

Compliance Notice - CE Mark

This equipment is in conformance with the requirements of the European Council Directive listed below:

73/23/EEC Low Voltage Directive with amendment 93/68/EEC

89/336/EEC EMC Directive with amendments 92/31/EEC and 93/68/EEC

1999/5/EC R&TTE

21-E-1

Important Safety Instructions / Importantes Mesures De Sécurité

When using your telephone equipment, basic safety precautions should always be followed to reduce the risk of fire, electric shock and injury to persons, including the following:

1. Do not use this product near water, for example, near a bath tub, wash bowl, kitchen sink or laundry tub, in a wet basement or near a swimming pool.
2. Avoid using a telephone (other than a cordless type) during an electrical storm. There may be a remote risk of electric shock from lightning.
3. Do not use the telephone to report a gas leak in the vicinity of the leak.
4. Use only the power cord and batteries indicated in this manual. Do not dispose of batteries in a fire. They may explode. Check with local codes for possible special disposal instructions.

SAVE THESE INSTRUCTIONS

19-E-1

Certaines mesures de sécurité doivent être prises pendant l'utilisation de matériel téléphonique afin de réduire les risques d'incendie, de choc électrique et de blessures. En voici quelquesunes:

1. Ne pas utiliser l'appareil près de l'eau, p.ex., près d'une baignoire, d'un lavabo, d'un évier de cuisine, d'un bac à laver, dans un sous-sol humide ou près d'une piscine.
2. Éviter d'utiliser le téléphone (sauf s'il s'agit d'un appareil sans fil) pendant un orage électrique. Ceci peut présenter un risque de choc électrique causé par la foudre.
3. Ne pas utiliser l'appareil téléphonique pour signaler une fuite de gaz s'il est situé près de la fuite.
4. Utiliser seulement le cordon d'alimentation et le type de piles indiqués dans ce manual. Ne pas jeter les piles dans le feu: elles peuvent exploser. Se conformer aux règlements pertinents quant à l'élimination des piles.

CONSERVER CES INSTRUCTIONS

19-F-1

Information to the User

<Only for model with wireless LAN/Bluetooth>

This product and your Health

This product, like other radio devices, emits radio frequency electromagnetic energy. The level of energy emitted by this product however is far much less than the electromagnetic energy emitted by wireless devices like for example mobile phones.

Because this product operates within the guidelines found in radio frequency safety standards and recommendations, we believe this product is safe for use by consumers. These standards and recommendations reflect the consensus of the scientific community and result from deliberations of panels and committees of scientists who continually review and interpret the extensive research literature.

In some situations or environments, the use of this product may be restricted by the proprietor of the building or responsible representatives of the organization. These situations may for example include:

- Using this product on board of airplanes, or
- In any other environment where the risk of interference to other devices or services is perceived or identified as harmful.

If you are uncertain of the policy that applies on the use of wireless devices in a specific organization or environment (e.g. airports), you are encouraged to ask for authorization to use this product prior to turning on the product.

Regulatory Information

We are not responsible for any radio or television interference caused by unauthorized modification of this product. The correction of interference caused by such unauthorized modification will be the responsibility of the user. We and its authorized resellers or distributors are not liable for damage or violation of government regulations that may arise from failing to comply with these guidelines.

26-M-1

Lithium Battery / Pile au lithium

Lithium Battery!

This computer contains a lithium battery to enable the date, time, and other data to be stored. The battery should only be exchanged by authorized service personnel.

Warning!

A risk of explosion from incorrect installation or misapplication may possibly occur.

15-E-1

Pile au lithium!

Le micro-ordinateur renferme une pile au lithium qui permet de sauvegarder certaines données, notamment la date et l'heure. La pile ne doit être remplacée que par un technicien qualifié.

Danger ! Risque d'explosion en cas de non respect de cette mise en garde!

15-F-1

Precautions

THIS PRODUCT IS NOT INTENDED FOR USE AS, OR AS PART OF, NUCLEAR EQUIPMENT/SYSTEMS, AIR TRAFFIC CONTROL EQUIPMENT/SYSTEMS, OR AIRCRAFT COCKPIT EQUIPMENT/SYSTEMS¹. PANASONIC WILL NOT BE RESPONSIBLE FOR ANY LIABILITY RESULTING FROM THE USE OF THIS PRODUCT ARISING OUT OF THE FOREGOING USES.

¹ AIRCRAFT COCKPIT EQUIPMENT/SYSTEMS include Class2 Electrical Flight Bag (EFB) Systems and Class1 EFB Systems when used during critical phases of flight (e.g., during take-off and landing) and/or mounted on to the aircraft. Class1 EFB Systems and 2 EFB Systems are defined by FAA: AC (Advisory Circular) 120-76A or JAA: JAA TGL (Temporary Guidance Leaflets) No.36.

Panasonic cannot guarantee any specifications, technologies, reliability, safety (e.g. Flammability/Smoke/Toxicity/Radio Frequency Emission, etc) requirements related to aviation standards that exceed the specifications of our COTS (Commercial-Off-The-Shelf) products.

39-E-1

This computer is not intended for use in medical equipment including life-support systems, air traffic control systems, or other equipment, devices or systems that are involved with ensuring human life or safety. Panasonic cannot be held responsible in any way for any damages or loss resulting from the use of this computer in these types of equipment, devices or systems, etc.

The CF-19 was developed based on thorough research into the real-world portable computing environments. Exhaustive pursuit of usability and reliability under harsh conditions led to innovations such as the magnesium alloy exterior, vibration damped hard disk drive and floppy disk drive, flexible internal connections. The CF-19's outstanding engineering has been tested using the strict MIL-STD- 810F (for vibration and shock) and IP (for dust and water) based procedures. As with any portable computer device precautions should be taken to avoid any damage. The following usage and handling procedures are recommended.

Before putting the computer away, be sure to wipe off any moisture.

If a Malfunction Occurs, Immediately Unplug the AC Cord and the Battery Pack

- Computer is damaged
- Foreign object inside computer
- Smoke emitted
- Unusual smell emitted
- Unusually hot

Continuing to use the computer while any of the above conditions are present may result in fire or electric shock.

- If a malfunction occurs, immediately turn the power off and unplug the AC cord, and then remove the battery pack.

Do Not Touch the Computer and Cable When It Starts Thundering

Electric shock may result.

Do Not Connect the AC Adaptor to a Power Source Other Than a Standard Household AC Outlet

Otherwise, a fire due to overheating may result. Connecting to a DC/AC converter (inverter) may damage the AC adaptor. On an airplane, only connect the AC adaptor/charger to an AC outlet specifically approved for such use.

Do Not Do Anything That May Damage the AC Cord, the DC Plug, or the AC Adaptor

Do not damage or modify the cord, place it near hot tools, bend, twist, or pull it forcefully, place heavy objects on it, or bundle it tightly.

Continuing to use a damaged cord may result in fire, short circuit, or electric shock.

Do Not Pull or Insert the DC Plug If Your Hands Are Wet

Electric shock may result.

Clean the DC Plug of Dust and Other Debris Regularly

If dust or other debris accumulates on the plug, humidity, etc. may cause a defect in the insulation, which may result in a fire.

- Pull the plug, and wipe it with a dry cloth.
Pull the plug if the computer is not being used for a long period of time.

Insert the AC Plug Completely

If the plug is not inserted completely, fire due to overheating or electric shock may result.

- Do not use a damaged plug or loose AC outlet.

Close the Connector Cover Tightly When Using the Computer Where Is a Lot of Water, Moisture, Steam, Dust, Oily Vapors, etc.

The entry of foreign matter may cause a fire or electric shocks.

- If foreign matter has found its way inside, immediately turn the power off and unplug the AC cord, and then remove the battery pack. Then contact your technical support office.

Do Not Disassemble the Computer

There are high-voltage areas inside which may give you an electric shock if you should touch them. Do not touch the pins and circuit boards inside, and do not allow foreign matter to enter inside.

Also, remodeling or disassembly may cause a fire.

Keep SD Memory Cards Away from Infants and Small Children

Accidental swallowing will result in bodily injury.

In the event of accidental swallowing, see a doctor immediately.

Do Not Place the Computer on Unstable Surfaces

If balance is lost, the computer may fall over or drop, resulting in an injury.

Avoid Stacking

If balance is lost, the computer may fall over or drop, resulting in an injury.

Do Not Leave the Computer in High Temperature Environment Such as in a Sun-Heated Car, for a Long Period of Time

Leaving the computer where it will be exposed to extremely high temperatures such as in a sun-heated car or in direct sunlight may deform the cabinet and/or cause trouble in the internal parts. Continued use in such a resulting condition may lead to short-circuiting or insulation defects, etc. which may in turn lead to a fire or electric shocks.

Hold the Plug When Unplugging the AC Cord

Pulling on the cord may damage the cord, resulting in a fire or electric shock.

Do Not Move the Computer While the DC Plug Is Connected

The AC cord may be damaged, resulting in fire or electric shock.

- If the AC cord is damaged, unplug the DC plug immediately.

Use Only the Specified AC Adaptor With Your Computer

Using an AC adaptor other than the one supplied (attached to your computer or supplied by Panasonic) may result in a fire.

Do Not Subject the AC Adaptor to Any Strong Impact

Using the AC adaptor after a strong impact such as being dropped may result in electric shock, short circuit, or fire.

Take a Break of 10-15 Minutes Every Hour

Using the computer for long periods of time may have detrimental health effects on the eyes or hands.

Read Me First

Do Not Turn the Volume Up to Loud When Using Headphones

Listening at high volumes that overstimulate the ear for long periods of time may result in loss of hearing.

Use the Modem with a Regular Telephone Line

Connection to an internal phone line (on-premise switches) of a company or business office, etc. or to a digital public phone or use in a country or area not supported by the computer may result in a fire or electric shocks.

Do Not Connect a Telephone Line, or a Network Cable Other Than the One Specified, into the LAN Port

If the LAN port is connected to a network such as the ones listed below, a fire or electric shock may result.

- Networks other than 1000BASE-TX, 100BASE-TX or 10BASE-T
- Phone lines (Telephone lines, internal phone lines (on-premise switches), digital public phones, etc.)

Do Not Use with Exposing the Skin to the Computer for a Long Period of Time

Using the computer with exposing the skin to the heat source of the computer or AC adaptor for a long period of time can cause a low-temperature burn.

- Do not place the computer near a television or radio receiver.
- Keep the computer away from magnets. Data stored on the hard disk may be lost.

Precautions (Battery Pack)

Do Not Use with Any Other Computer

The battery pack is rechargeable and was intended for the specified computer or charger. If it is used with a computer other than the one for which it was designed, electrolyte leakage, generation of heat, ignition or rupture may result.

Do Not Charge the Battery Using the Methods Other Than Indicated in This Manual

If the battery pack is not charged using one of the methods indicated in this manual, electrolyte leakage, generation of heat, ignition or rupture may result.

Do Not Throw the Battery Pack into a Fire or Expose It to Excessive Heat

Generation of heat, ignition or rupture may result.

Avoid Extreme Heat (Near the Fire, in Direct Sunlight, for Example)

Electrolyte leakage, generation of heat, ignition or rupture may result.

Do Not Insert Sharp Objects into the Battery Pack, Expose It to Bumps or Shocks, Disassemble, or Modify It

Electrolyte leakage, generation of heat, ignition or rupture may result.

Do Not Short the Positive (+) and Negative (-) Contacts

Generation of heat, ignition or rupture may result. Do not place the battery pack together with articles such as necklaces or hairpins when carrying or storing.



Do Not Use This Computer with a Battery Pack Other Than the One Specified

Use only the specified battery pack (CF-VZSU48U) with your CF-19. Use of battery packs other than those manufactured and supplied by Panasonic may present a safety hazard (generation of heat, ignition or rupture).

- Do not touch the terminals on the battery pack. The battery pack may no longer function properly if the contacts are dirty or damaged.
- Do not expose the battery pack to water, or allow it to become wet.
- If the battery pack will not be used for a long period of time (a month or more), charge or discharge (use) the battery pack until the remaining battery level becomes 30% to 40% and store it in a cool, dry place.
- This computer prevents overcharging of the battery by recharging only when the remaining power is less than approx. 95% of capacity.

- The battery pack is not charged when the computer is first purchased. Be sure to charge it before using it for the first time. When the AC adaptor is connected to the computer, charging begins automatically.
- Should the battery leak and the fluid get into your eyes, do not rub your eyes. Immediately flush your eyes with clear water and see a doctor for medical treatment as soon as possible.

NOTE

- The battery pack may become warm during recharging or normal use. This is completely normal.
- Recharging will not commence if internal temperature of the battery pack is outside of the allowable temperature range (0 °C to 50 °C {32°F to 122 °F}). (→  *Reference Manual* "Battery Power") Once the allowable range requirement is satisfied, charging begins automatically. Note that the recharging time varies based on the usage conditions. (Recharging takes longer than usual when the temperature is 10 °C {50 °F} or below.)
- If the temperature is low, the operating time is shortened. Only use the computer within the allowable temperature range.
- This computer has a high temperature mode function that prevents the degradation of the battery in high temperature environments. (→  *Reference Manual* "Battery Power") A level corresponding to a 100% charge for high temperature mode is approximately equivalent to an 80% charge level for normal temperature mode.
- The battery pack is a consumable item. If the amount of time the computer can be run by using a particular battery pack becomes dramatically shorter and repeated recharging does not restore its performance, the battery pack should be replaced with a new one.
- When transporting a spare battery inside a package, briefcase, etc., it is recommended that it be placed in a plastic bag so that its contacts are protected.
- Always power off the computer when it is not in use. Leaving the computer on when the AC adaptor is not connected will exhaust the remaining battery capacity.

For Used in Motor Vehicle /Pour L'utilisation Dans Un Véhicule Motorisé

Warning: Notebook Computer may be installed in a motor vehicle and visible to the driver only if used to support vehicle related functions such as vehicle information, system control, rear or side observation and navigation. If used for entertainment purpose, such as television reception or video play, it must be installed to the rear of the driver's seat where it will not be visible, directly or indirectly, to the operator of the motor vehicle. Check with individual state/provincial laws to determine lawful use of this product while operating within a motor vehicle.

Avertissement : L'ordinateur bloc-notes peut être installé dans un véhicule motorisé et dans le champ de vision du conducteur uniquement en tant que dispositif d'aide aux fonctions du véhicule, comme par exemple pour fournir des informations sur le véhicule, comme dispositif de contrôle de système, pour l'observation à l'arrière ou sur les côtés du véhicule, ainsi que pour fournir de l'information routière. Pour toute utilisation à fin de divertissement, comme par exemple pour regarder la télévision ou jouer à des jeux vidéo, il doit être installé à l'arrière du siège du conducteur, en un emplacement où il ne sera pas visible, ni directement ni indirectement, pour le conducteur du véhicule motorisé. Vérifiez les lois fédérales et nationales qui régissent l'utilisation légale de cet appareil à l'intérieur d'un véhicule motorisé.

35-M-1

Information on Disposal for Users of Waste Electrical & Electronic Equipment (private households)



Information on Disposal in other Countries outside the European Union

This symbol is only valid in the European Union.

If you wish to discard this product, please contact your local authorities or dealer and ask for the correct method of disposal.

36-M-1

Description of Parts

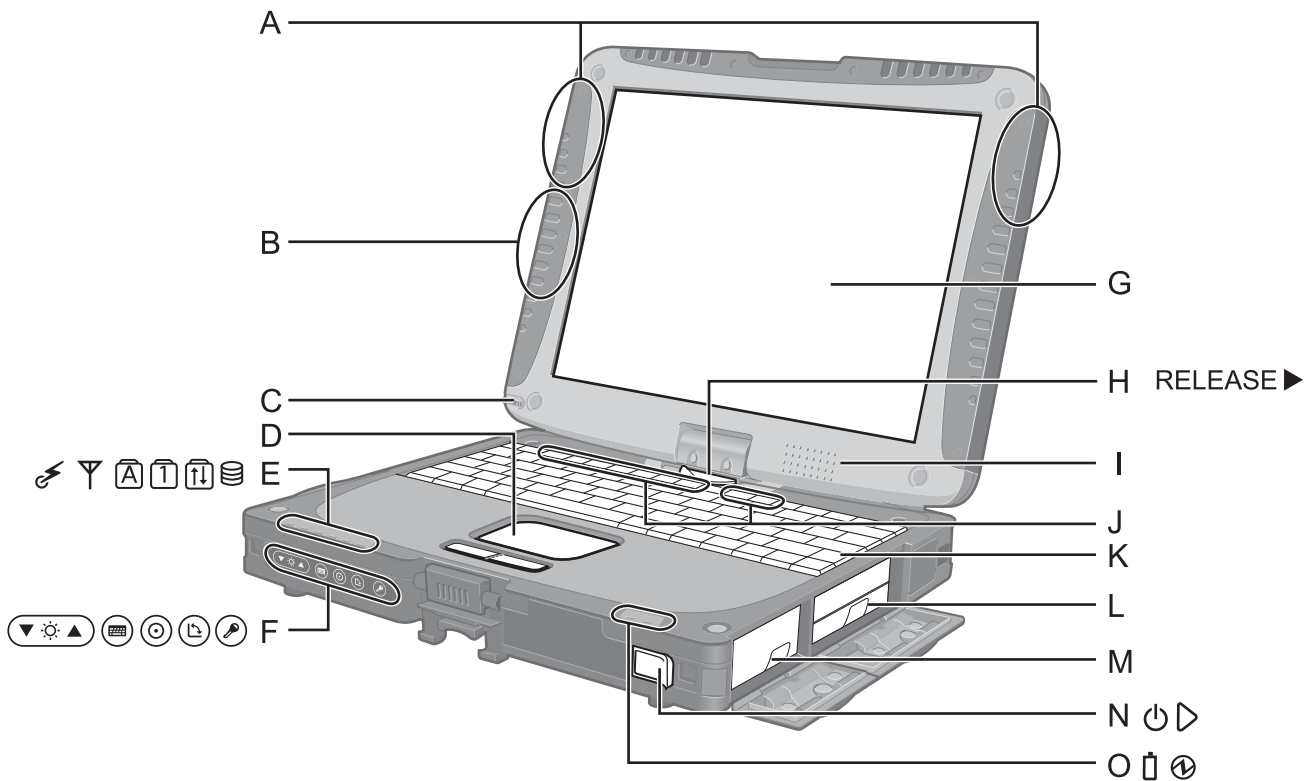

A: Wireless LAN Antenna

<Only for model with wireless LAN>
 → *Reference Manual* "Wireless LAN"

B: Bluetooth Antenna

<Only for model with Bluetooth>
 → *Reference Manual* "Bluetooth"

C: Stylus/Pen Holder

D: Touch Pad

E: LED Indicator

- ⚡ : Wireless ready
 This indicator lights when Wireless LAN, Bluetooth, and/or Wireless WAN are connected and ready. It does not necessarily indicate the On/Off condition of the wireless connection.
 → *Reference Manual* "Wireless Switch Utility"
- 📶 : Wireless WAN status
 <Only for model with wireless WAN>
 → Refer to the instruction manual of the wireless device.
- ⏏ : Caps lock
- 1 : Numeric key (NumLk)
- 🔒 : Scroll lock (ScrLk)
- 💿 : Hard disk drive status

F: Tablet Buttons

→ *Reference Manual* "Tablet Buttons"

G: LCD

<Only for model with touchscreen>
 → *Reference Manual* "Touchscreen"
 <Only for model with digitizer>
 → *Reference Manual* "Digitizer"

H: Display Release Latch

→ page 12 "Switching to the Tablet mode"

I: Speaker

→ *Reference Manual* "Key Combinations"

J: Function Key

→ *Reference Manual* "Key Combinations"

K: Keyboard

L: Hard Disk Drive

→ *Reference Manual* "Hard Disk Drive"

M: Battery Pack

N: Power Switch

O: LED Indicator

- 🔋 : Battery status
 → *Reference Manual* "Battery Power"
- 🔌 : Power status
 (Off: Power off/Hibernation, Green: Power on, Blinking green: Standby)



A lithium ion battery that is recyclable powers the product you have purchased. Please call 1-800-8-BATTERY for information on how to recycle this battery.

L'appareil que vous vous êtes procuré est alimenté par une batterie au lithium-ion. Pour des renseignements sur le recyclage de la batterie, veuillez composer le 1-800-8-BATTERY.

Left side

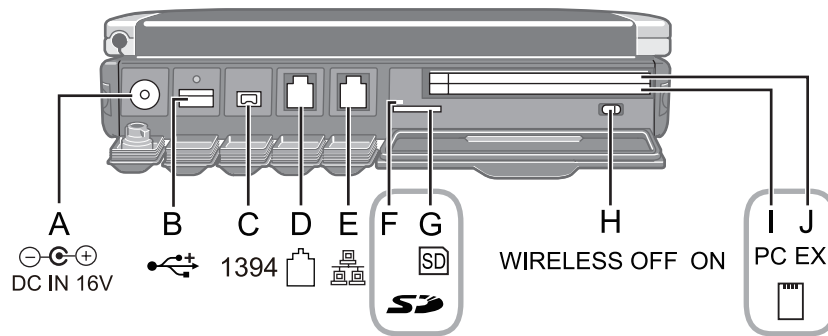

Rear side

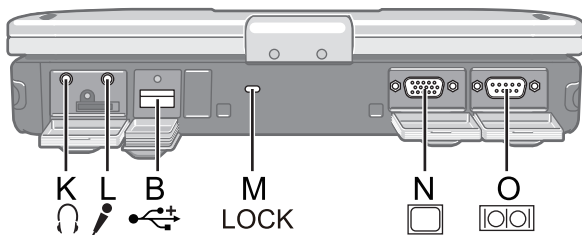

Bottom

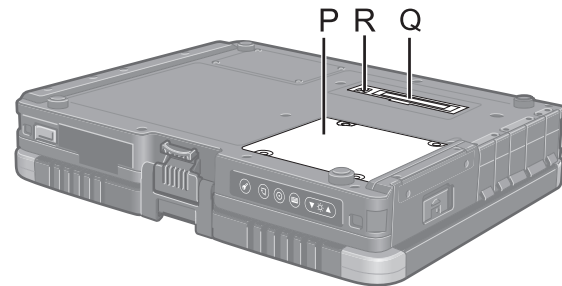

A: DC-IN Jack

B: USB Port

→ *Reference Manual* "USB Devices"

C: IEEE 1394 Interface Connector

→ *Reference Manual* "IEEE 1394 Devices"

D: Modem Port

→ *Reference Manual* "Modem"

E: LAN Port

→ *Reference Manual* "LAN"

F: SD Memory Card Indicator

(Blinking: During access)

→ *Reference Manual* "SD Memory Card"

G: SD Memory Card Slot

→ *Reference Manual* "SD Memory Card"

H: Wireless Switch

→ *Reference Manual* "Wireless Switch Utility"

I: PC Card Slot

→ *Reference Manual* "PC Card / ExpressCard"

J: ExpressCard Slot

→ *Reference Manual* "PC Card / ExpressCard"

K: Headphone Jack

You can connect headphones or amplified speakers. When they are connected, audio from the internal speakers is not heard.

L: Microphone Jack

A condenser microphone can be used. If other types of microphones are used, audio input may not be possible, or malfunctions may occur as a result.

- When recording in stereo using a stereo microphone:

Double-click  in the notification area, click [Options] - [Properties], and add a check mark for [Recording], click [OK] - [Options] - [Advanced Controls] - [Advanced], remove a check mark for [Mono Microphone], and then click [Close].

- When using a monaural microphone with a 2-terminal plug:

With the settings outlined above, only audio on the left track will be recorded.

When monitoring the microphone audio using headphones, sounds on the left track cannot be heard, regardless of the above settings. This is a result of the computer's specifications, and is not a malfunction.

M: Security Lock

A Kensington cable can be connected.

For further information, read the manual that comes with the cable.

N: External Display Port

→ *Reference Manual* "External Display"

O: Serial Port

P: RAM Module Slot

→ *Reference Manual* "RAM Module"

Q: Expansion Bus Connector

→ *Reference Manual* "Port Replicator / Car Mounter"

R: External Antenna Connector

Description of Parts

Switching to the Tablet mode

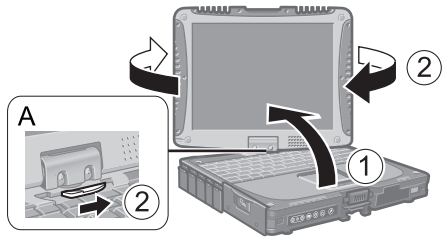

- ① Lift up the display so it stands perpendicular to the body.
- ② Slide and hold the display release latch (A), and rotate the display clockwise until it clicks.

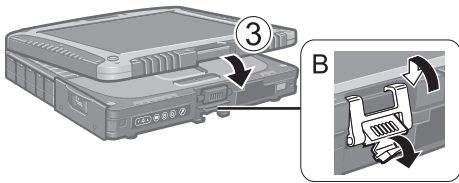

- ③ Close as the display faces up and fix it using the latch (B).

Attaching the stylus to the computer

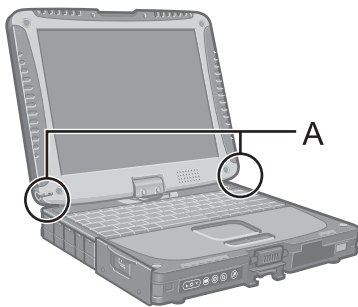

Use the tether to attach the stylus to the computer so you will not lose it. There are holes (A) to attach it.

- For model with digitizer, the tether and pen are already attached to the computer at purchase.

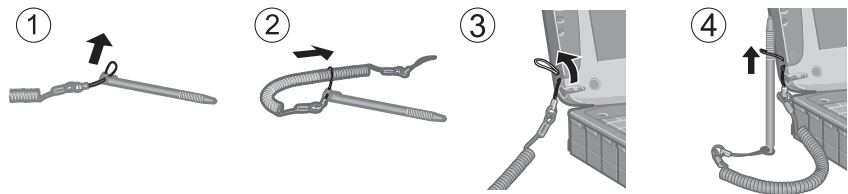

Attaching the hand strap and the shoulder strap

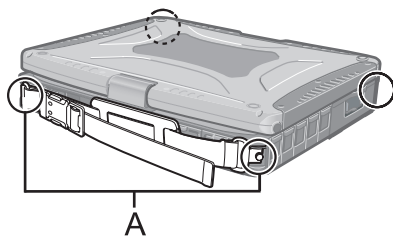

Attach the hand strap to any two of the corners (A) using the screws. You can connect the shoulder strap (B) to the hand strap. (The illustration is an example.)

CAUTION

- Do not use the strap to carry a heavier weight than the computer. Otherwise the strap may become loose by itself.
- Do not use the strap if it becomes worn or damaged.

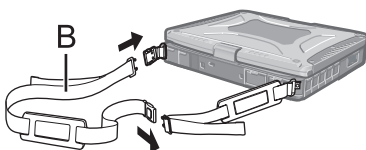

First-time Operation

■ Preparation

① Check and identify the supplied accessories.

If you do not find the described accessories, contact Panasonic Technical Support (→ page 36).

- AC Adaptor 1
- AC Cord 1
- Battery Pack 1
- Modem Telephone Cable 1

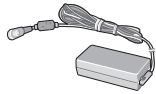

Model No: CF-AA1633A

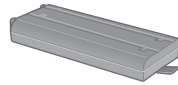

Model No: CF-VZSU48



- Tether 1
- Shoulder strap 1
- Soft Cloth 1

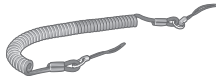

<Only for model with touchscreen>

- Stylus 1



<Only for model with digitizer>

- Pen 1



- Operating Instructions (This book) 1
- Product Recovery DVD-ROM 1
- Windows® Book 1

- For model with digitizer, the tether and pen are already attached to the computer at purchase.

② Read the LIMITED USE LICENSE AGREEMENT before breaking the seal on the computer's packaging (→ page 32).

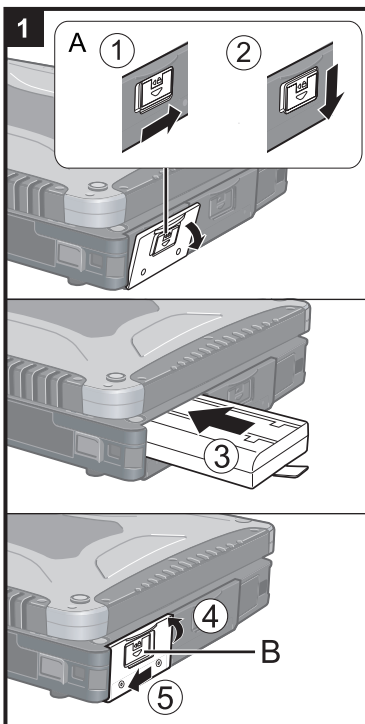

1 Insert the battery pack.

- ① Slide the latch (A) to the right to unlock the cover.
- ② Slide the latch (A) down, and open the cover.
- ③ Insert the battery pack until it securely fits the connector.
- ④ Close the cover until it clicks.
- ⑤ Slide the latch (B) to the left to lock the cover.

CAUTION

- Make sure the latch is securely locked. Otherwise the battery pack may fall when you carry the computer.
- Do not touch the terminals of the battery pack and the computer. Doing so can make the terminals dirty or damaged, and may cause malfunction of the battery pack and the computer.

First-time Operation

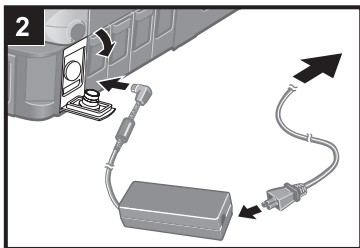

2 Connect your computer to a power outlet.

The battery charging starts automatically.

CAUTION

- Do not disconnect the AC adaptor and do not switch the wireless switch to on until the first-time operation procedure is completed.
- When using the computer for the first time, do not connect any peripheral device except the battery pack and AC adaptor.
- **Handling the AC adaptor**
 - Problems such as sudden voltage drops may arise during periods of thunder and lightning. Since this could adversely affect your computer, an uninterruptible power source (UPS) is highly recommended unless running from the battery pack alone.

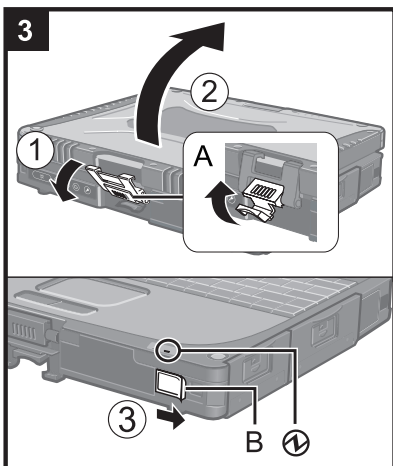

3 Turn on the computer.

- ① Pull up the part (A) and release the latch.
- ② Lift open the display.
- ③ Slide and hold the power switch (B) for approximately one second until the power indicator  lights.

CAUTION

- Do not slide the power switch repeatedly.
- The computer will forcibly be turned off if you slide and hold the power switch for four seconds or longer.
- Once you turn off the computer, wait for ten seconds or more before you turn on the computer again.
- Do not perform the following operation until the hard disk drive indicator  turns off.
 - Connecting or disconnecting the AC adaptor
 - Sliding the power switch
 - Touching the keyboard, touch pad, tablet buttons, touchscreen (only for model with touchscreen), digitizer (only for model with digitizer) or external mouse
 - Closing the display
- When the CPU temperature is high, the computer may not start up to prevent overheating of the CPU. Wait until the computer cools down, and then turn the power on again. If the computer does not power on even after cooling down, contact Panasonic Technical Support (→ page 36).

4 Setup Windows.

- ① Follow the on-screen instructions.

CAUTION

- When you set date/time/time zone and click [Next], the screen may not go to the next step for a few minutes. Do not touch the keyboard or touch pad, and wait until the screen changes.
- If "An unexpected error has occurred..." (or a similar message) is displayed, click [OK]. This is not a malfunction.
- Wait until the hard disk drive indicator  has turned off.
- This computer periodically records the management information including the hard disk information such as number of hours powered-on, number of times powered-on, internal temperature, replacement sector. The maximum data volume for each record is 750 byte. These information are only used for estimating the cause when the hard disk goes down by any possibility. They are never sent to outside via network nor used for any other purpose except for the purpose described the above.

To disable the function, add the check mark for [Disable the automatic save function for management information history] in [Hard Disk Status] of PC Information Viewer, and click [OK].

5 Create a new account.

- ① Click [start] - [Control Panel] - [User Accounts] - [Create a new account].

CAUTION

- Remember your password. If you forget the password, you cannot use the Windows operation system. Creating a password reset disk beforehand is recommended.

6 <Only for model with touchscreen> Perform the touchscreen calibration.

- ① Click [start] - [All Programs] - [Fujitsu Touch Panel (USB)] - [Touch Screen Calibration Utility].
- ② Using the stylus, touch each of the 12 “+” target marks one by one until it blinks, and then click [Calibration].
- ③ Click [Save & Exit].

NOTE

- **Regarding Windows XP**

You can select the Classic view of Control Panel or the Classic Start menu. You can also change the way a user logs on or off. This manual explains using the Windows XP default setting (not Classic view or Classic Start menu etc.).

- **Windows Update**

You can update to the latest patches and service packs for Windows with the following menus.

[start] - [All Programs] - [Windows Update]

Do not apply “Driver Updates” even if a message to update a driver appears. If a driver update is required, contact Panasonic Technical Support (→ page 36).

- **If the message “Your computer might be at risk” is displayed**

Select  on the notification area and make the appropriate settings. The Windows Security Center regularly gives you notice so that you can make the optimum settings. This is not an error message and you can use the computer. However, making appropriate measures is recommended to reduce the risk of virus and other attacks.

- **Note that the computer consumes electricity even when the computer power is off.**

If the battery pack is fully charged, the battery will fully discharge in Approx. 7 weeks.

On-screen Manual

You can access the Reference Manual and the Important Tips on the computer screen.

When you access the Reference Manual and the Important Tips for the first time, the License Agreement of the Adobe Reader may be displayed. Read it carefully and select [Accept] to proceed.

■ Reference Manual

The Reference Manual contains the practical information to help you fully enjoy the computer's performance.

To access the Reference Manual:

- ① Click [start] - [Reference Manual].

Contents

- | | | |
|-------------------------------------|---------------------------------|------------------------------|
| ● Key Combinations | ● SD Memory Card | ● Bluetooth |
| ● Tablet Buttons | ● SD Security | ● Hard Disk Drive |
| ● Touchscreen | ● RAM Module | ● Setup Utility |
| ● Digitizer | ● Port Replicator / Car Mounter | ● Icon Enlarger |
| ● Software Keyboard | ● External Display | ● Loupe Utility |
| ● Panasonic Hand Writing | ● USB Devices | ● DMI Viewer |
| ● Display Rotation | ● IEEE 1394 Devices | ● Recover Pro |
| ● Standby and Hibernation Functions | ● Modem | ● Technical Information |
| ● Security Measures | ● LAN | ● Troubleshooting (Advanced) |
| ● Battery Power | ● Wireless Switch Utility | |
| ● PC Card / ExpressCard | ● Wireless LAN | |

Some contents only apply to some limited models.

■ Important Tips

The Important Tips will provide you with the helpful information about the battery and touchscreen. Read to use the battery pack in the optimum condition to obtain longer operation time.

To access the Important Tips:

- ① Double-click  on the desktop.
Important Tips

- Alternatively click [start] - [All Programs] - [Panasonic] - [On-Line Manuals] - [Important Tips].

Handling and Maintenance

Operation environment

- Place the computer on a flat stable surface. Do not place the computer upright or turn it over. If the computer is exposed to an extremely strong impact, it may become inoperable.
 - Temperature: Operation : 5 °C to 35 °C {41 °F to 95 °F}
Storage : -20°C to 60 °C {- 4 °F to 140 °F}
 - Humidity: Operation : 30% to 80% RH (No condensation)
Storage : 30% to 90% RH (No condensation)
- Even within the above temperature/humidity ranges, using for a long time in an extreme environment will result in the product deterioration and will shorten the product life.
- Do not place the computer in the following areas, otherwise the computer may be damaged.
 - Near electronic equipment. Image distortion or noise may occur.
 - In extremely high or low temperature.
 - As the computer can become hot during operation, keep it away from items that are sensitive to heat.

Handling cautions

This computer is designed to minimize shock to parts such as the LCD and the hard disk drive and equipped with a drip-proof keyboard, but no warranty is provided against any trouble caused by shock. Be extremely careful when handling the computer.

- When carrying the computer:
 - Turn off the computer.
 - Remove all external devices, cables, cards and other protruding things.
 - Do not drop or hit the computer against solid objects.
 - Do not leave the display open.
 - Do not grip the display part.
 - Do not put anything (e.g., a piece of paper) between the display and keyboard.
 - When you board an airplane, take the computer with you and never put it in your checked luggage. When using the computer on airplane, follow the airline's instructions.
 - When carrying a spare battery, put it in a plastic bag to protect its terminals.
 - The touch pad is designed to be used with a finger tip. Do not place any object on its surface and do not press down strongly with sharp-pointed or hard objects that may leave marks (e.g., nails, pencils and ball point pens).
 - Avoid any harmful substances such as oil from getting into the touch pad. The cursor may not work correctly.
 - This computer contains a magnet and magnetic products at the locations circled in the illustration at right. Avoid leaving metallic object or magnetic media in contact with these areas.
 - Use only the included stylus/pen to touch the screen. Do not place any object on its surface and do not press down strongly with sharp-pointed or hard objects that may leave marks (e.g., nails, pencils and ball point pens).
 - Do not use the stylus/pen when dust or dirt (e.g., oil) is on the screen. Otherwise foreign particles on the screen/stylus/pen can scratch the screen surface or obstruct the stylus/pen operation.
 - Use the stylus/pen only for touching the screen. Using it for any other purpose may damage the stylus/pen and result in scratches on the screen.
- <Only for model with digitizer>
- The digitizer uses electromagnetic induction and may not work properly near strong electrical field or magnetic field such as:
 - near AM radio base station or relay station antennas
 - near CRT displays that generate strong electromagnetic field noiseMove the digitizer away from such locations so it will work properly.
 - The cursor cannot follow the pen movement if you move the pen too quickly.

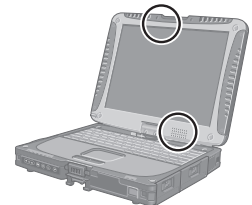

■ When using peripheral devices

Follow these instructions and the Reference Manual to avoid any damage to the devices. Carefully read the instruction manuals of the peripheral devices.

- Use the peripheral devices conforming to the computer's specifications.
- Connect to the connectors in the correct direction.
- If it is hard to insert, do not try forcibly but check the connector's shape, direction, alignment of pins, etc.
- If screws are included, fasten them securely.
- Remove the cables when you carry the computer. Do not pull the cables forcibly.

Handling and Maintenance

■ Preventing your computer from unauthorized use via wireless LAN

<Only for model with wireless LAN>

- Before using wireless LAN, make the appropriate security settings such as data encryption.

■ Computrace® Software

Computrace® software tracks your stolen computer.

Perform the following steps before installing Computrace® software.

- Computrace® software is not included or installed in this computer.

CAUTION

- You will be unable to set [Computrace (R) BIOS Module] to [Disable] once you have set to [Enable]. Do not change the setting when not used.
 - Even if you have set [Computrace (R) BIOS Module] to [Enable], this setting may return to [Disable] after repairs to the motherboard, etc. have been made.

NOTE

- Consult Absolute Software Corp. before disposal.
- Refer to the following URL for Computrace® software for installation and available service regions. Note that this service is only available in certain regions.
<http://www.absolute.com>

- 1 Turn on or restart the computer, and press F2 while [Panasonic] boot screen is displayed.**
The Setup Utility starts up.
 - If the password is requested, enter the Supervisor Password.
- 2 Select the [Security] menu, then select [Computrace (R) Sub-Menu] and press Enter.**
- 3 Select [Computrace (R) BIOS Module], and set to [Enable].**
- 4 At the confirmation message, select [Execute] and press Enter.**
- 5 At the reconfirmation message, select [Execute] and press Enter.**
- 6 Press F10.**
At the confirmation message, select [Yes] and press Enter.
The computer restarts.

Maintenance

To clean the LCD panel

Use the soft cloth included with the computer. (For further information, refer to “Suggestions About Cleaning the LCD Surface” that comes with the soft cloth.)

To clean areas other than the LCD panel

Wipe with a soft dry cloth such as gauze. When using detergent, dip a soft cloth in water-diluted detergent and wring it thoroughly.

CAUTION

- Do not use benzene, thinner, or rubbing alcohol since it may adversely affect the surface causing discoloration, etc. Do not use commercially-available household cleaners and cosmetics, as they may contain components harmful to the surface.
- Do not apply water or detergent directly to the computer, since liquid may enter inside of the computer and cause malfunction or damage.

Hard Disk Backup Function (Recover Pro)

The Recover Pro creates a backup area (storage area) on the hard disk to back up (store) the hard disk data, and restores the backup data to its original location when it is lost or corrupted by operational errors or other factors. You do not need external media or peripheral devices to back up or restore hard disk data on this computer.

At purchase, the Recover Pro is not installed. Install using the instructions below.

The Recover Pro cannot back up or restore data correctly if a hard disk problem occurs during data backup or restoring. If an error occurs due to an unexpected malfunction, incorrect operation, or other reason while data is being restored, the hard disk data (data before restoration) may be lost.
Matsushita Electric Industrial Co., Ltd. will bear no responsibility for any damage suffered (including loss of data) as a result of the use of this function.

The Recover Pro provides 3 types of backup as follows:

- Quick Backup: Scheduled backup of the updated data
- File Backup: File backup at file save and change
- Complete Backup: Backup of the entire data on the internal hard disk

Here, we will explain the procedures for installation, complete backup (backing up hard disk contents in case Windows cannot be booted), and complete restore (recovering the hard disk data to its condition at the time of the complete backup).

For further information, refer to the software's online manual (➔ page 20).

CAUTION

- All operations should be executed with the AC adaptor connected. Do not turn the power off while operations are in progress. If the power is turned off while installation, backup, or restore operations are in progress, these operations may not function properly, and it may be impossible to start Windows. Also, do not press any keys or slide any switches, including hot keys.
- When restarting the computer, the message "Check file system on C:" may appear. Follow the on-screen instructions. Do not skip the check process.
- Make sure you allow enough space on the hard disk when choosing settings during installation. To change these settings you must reinstall Recover Pro.
To execute Complete Backup reliably, we recommend performing [Typical] installation in the following cases.
 - Hard disk with a single partition
 - Immediately after reinstalling software (when more than half of the entire space of the hard disk is available) (➔ page 22)
- Be sure to use the internal hard disk drive to create the backup area. Never use disk or device other than the internal hard disk drive.
- Some software (security software, backup software, encryption software, or hard disc accessible specific software, etc.) may be incompatible with Recover Pro.
For further information, refer to:
<http://www.phoenix.com/en/Customer+Services/White+Papers-Specs/Recover+Pro/default.htm>
- When using Personal Secure Drive (➔  *Installation Manual* of "Trusted Platform Module (TPM)"), do not execute File Backup for Personal Secure Drive.
- The "Create recovery CD-DVD" function in Recover Pro is designed to help you save complete backup data to CD or DVD. When using the "Create recovery CD-DVD", you can view the complete backup data on the hard disk, but take care to avoid accidentally deleting this data.
- After installing the Recover Pro, do not use the IEEE1394 network connection. If any problem occurred, stop the IEEE1394 network connection and restart the computer.

Installation

Preparation

- Connect the AC adaptor.

1 Log on to Windows as an administrator.

2 Close all programs.

3 Disable anti-virus software.

4 Click [start] - [Run], enter [c:\util\rcvpro\setup.exe], and click [OK].

The InstallShield Wizard screen appears.

5 Click [Next].

Follow the on-screen instructions.

Carefully read the License Agreement, and click [I accept the agreement.]

- The computer restarts several times to complete installation.  appears in the notification area.

Hard Disk Backup Function (Recover Pro)

CAUTION

- During the installation, the screen may become black (no display) momentarily. This is not a malfunction.
- If you select [Typical] in installation, approximately 40% (max.) of the hard disk drive space is allocated as the backup area.
- You cannot change the size of backup area after creation.

Complete Backup

Backs up all data on the hard disk.

Preparation

- Connect the AC adaptor.

- 1 Log on to Windows as an administrator.**
- 2 Close all programs.**
- 3 Click [start] - [All Programs] - [Phoenix Applications] - [Phoenix Recover Pro 6].**
"Recover Pro 6" screen appears.
- 4 Click [Complete Backup], and click [Yes].**
 - The computer restarts, and "Recover Pro 6" screen appears.
Follow the on-screen instructions.

NOTE

- You can completely backup only one hard disk's worth of data to the backup area.
- Do not touch the power switch while using the Recover Pro.

Complete Restore

This function uses the data created during complete backup. It restores the hard disk data to the condition when you performed the complete backup. Files created and changes made to settings after the latest complete backup is made will be deleted.

Preparation

- Connect the AC adaptor.

- 1 Click [start] - [All Programs] - [Phoenix Applications] - [Phoenix Always Launcher], and click [Run].**
 - The computer restarts, and "Phoenix Always" screen appears.
Alternatively turn on or restart the computer, and hold down **F4** while [Panasonic] boot screen is displayed until "Phoenix Always" screen appears.
- 2 Click [Protect / Recover], and click [Phoenix Recover Pro 6].**
 - "Recover Pro 6" screen appears.
- 3 Click [Complete Restore].**
Follow the on-screen instructions.

NOTE

- Do not touch the power switch while using the Recover Pro.

■ To access the online manual

- ① Click [start] - [All Programs] - [Phoenix Applications] - [Docs], and double-click [UserGuides].
- ② Double-click the file of Recover Pro user's guide or Phoenix Always user's guide.

Hard Disk Data Erase Utility

When disposing the computer or transferring the ownership, erase all hard disk data in order to avoid data leakage. Even if you erase the data or initialize the hard disk using normal Windows commands, the data can be read with some special software. Use the hard disk data erase utility to erase the data completely. Note that transferring of the ownership without uninstalling the commercial software will be a violation of the software's license agreement.

The hard disk data erase utility erases data using an overwriting method, but there is a possibility that due to malfunctions or other operational errors, data may not be completely erased. There are also specialized devices that may be able to read data that has been erased using this method. If you need to erase highly confidential data, we recommend that you contact a company that specializes in this process. Matsushita Electric Industrial Co., Ltd. will bear no responsibility for losses or damages suffered as a result of the use of this utility.

CAUTION

- When the hard disk contains the Recover Pro backup data, the Recover Pro backup area is lost as well.

NOTE

- This utility cannot erase data for specific partitions.

Preparation

- Prepare the following items:
 - The Product Recovery DVD-ROM (included)
 - Panasonic USB CD/DVD drive (optional) (refer to recent catalogs and other sources for information about the products available)
- Remove all peripherals (except for the CD/DVD drive).
- Connect the AC adaptor and do not remove it until hard disk data erase is complete.

- 1 **Turn off the computer and connect the CD/DVD drive to the USB port (→ page 11).**
- 2 **Turn on the computer, and press F2 several times while [Panasonic] boot screen is displayed.**
The Setup Utility starts up.
 - If the password is requested, enter the Supervisor Password.
- 3 **Select the [Boot] menu, then select [USB CDD] and press F6 until [USB CDD] is at the top of the boot priority order.**
- 4 **Set the Product Recovery DVD-ROM into the CD/DVD drive.**
- 5 **Press F10.**
At the confirmation message, select [Yes] and press Enter.
The computer restarts.
- 6 **Press 2 to execute [2. [Erase HDD]].**
 - To cancel this operation, press 0.
- 7 **At the confirmation message, press Y.**
- 8 **When [<<< Start Menu >>>] is displayed, press Enter.**
The approximate time required for erasing data will be displayed.
- 9 **Press Space.**
At the confirmation message, press Enter.
The hard disk erase process starts. When the operation is completed, the [Hard disk data has been deleted.] message will appear. If a problem has occurred during the operation, an error message will appear.
 - To cancel partway, press Ctrl + C. The data erasure will be up to that point.
- 10 **Remove the Product Recovery DVD-ROM, and then press any key to turn off the computer.**
- 11 **Remove the CD/DVD drive.**

Reinstalling Software

Reinstalling software will return the computer to the default condition. When you reinstall the software, the hard disk data including the backup data of the Recover Pro will be erased.

Back up important data to other media or an external hard disk before reinstallation.

Preparation

- Prepare the following items:
 - The Product Recovery DVD-ROM (included)
 - Panasonic USB CD/DVD drive (optional) (refer to recent catalogs and other sources for information about the products available)
- Remove all peripherals (except for the CD/DVD drive).
- Connect the AC adaptor and do not remove it until reinstallation is complete.

NOTE

If you have installed the Recover Pro (→ page 19),

- Select [1] or [2] in the step 9 below. If you select [3], the Recover Pro will no longer function properly.
- Only when you want to save the data which you stored in the separate partitions other than the first partition and the Recover Pro backup area, select [3] in the step 9 below and perform the following steps.
 - ① After reinstallation, backup the data to external media (e.g., removable disk).
 - ② Perform the reinstallation procedure again, and select [1] or [2] in the step 9.
 - ③ Return the data backed up in external media to the internal hard disk.

- 1 Turn off the computer and connect the CD/DVD drive to the USB port (→ page 11).**
- 2 Turn on the computer, and press F2 several times while [Panasonic] boot screen is displayed.**

The Setup Utility starts up.

 - If the password is requested, enter the Supervisor Password.
- 3 Write down all of the contents of the Setup Utility and press F9.**

At the confirmation message, select [Yes] and press Enter.
- 4 Select the [Boot] menu, then select [USB CDD] and press F6 until [USB CDD] is at the top of the boot priority order.**
- 5 Set the Product Recovery DVD-ROM into the CD/DVD drive.**
- 6 Press F10.**

At the confirmation message, select [Yes] and press Enter.
The computer will restart.
- 7 Press 1 to execute [1. [Recovery]].**

The License Agreement screen appears.

 - To cancel partway, press 0.
- 8 Press 1 to select [1. Yes, I agree to the provisions above and wish to continue!].**
- 9 Select the settings.**
 - [2]: Enter the size of operating system partition and press Enter.
(The size of data partition will be determined by subtracting the operating system partition size from the maximum size.)
 - [3]: Windows will be installed in the first partition.
(The size of the first partition must be 20 GB or more. If smaller, installation will not be possible.)

At the confirmation message, press Y.
Reinstallation starts automatically. (It will take approximately 20 minutes.)

 - Do not interrupt reinstallation, for example by turning off the computer or pressing Ctrl + Alt + Del. Otherwise reinstallation may become unavailable as Windows may not start up or the data may be corrupted.
- 10 Remove the Product Recovery DVD-ROM, and then press any key to turn off the computer.**
- 11 Remove the CD/DVD drive.**

- 12 Turn on the computer, and press F2 several times while [Panasonic] boot screen is displayed.**

The Setup Utility starts up.

 - If the password is requested, enter the Supervisor Password.
- 13 Press F9.**

At the confirmation message, select [Yes] and then press Enter.
The Setup Utility settings excluding the password(s) will return to the default values.
- 14 Select the [Exit] menu and then select [Save Current Values], then press Enter.**

At the confirmation message, select [Yes] and press Enter.
- 15 Turn the computer off by using the power switch.**
 - If additional instructions are included with the computer, be sure to read them. It may be necessary to perform additional operations during the following procedure.
- 16 Perform the first-time operation (→ page 13).**
- 17 Start the Setup Utility and change the settings as necessary.**

Error Code/Message

Follow the instructions below when an error message or code appears. If the problem persists or if the error code/message is not shown here, contact Panasonic Technical Support (➔ page 36).

Error Code/Message	Solution
0211 Keyboard error	<ul style="list-style-type: none"> ● Disconnect external keyboard or mouse.
0251 System CMOS checksum bad - Default configuration used	<p>An error has occurred in the memory of Setup Utility settings. This occurs when the memory content is changed by an unexpected program operation, etc.</p> <ul style="list-style-type: none"> ● Start the Setup Utility and return the settings to the default values, and then change the settings as necessary. ● If the problem persists, the internal clock battery may need to be replaced. Contact Panasonic Technical Support (➔ page 36).
0271 Check date and time settings	<p>The date and time settings are not correct.</p> <ul style="list-style-type: none"> ● Start the Setup Utility and set the correct date and time. ● If the problem persists, the internal clock battery may need to be replaced. Contact Panasonic Technical Support (➔ page 36).
0280 Previous boot incomplete - Default configuration used	<p>Startup has failed repeatedly, so the Setup Utility settings have been returned to the default values to startup the computer.</p> <ul style="list-style-type: none"> ● Start the Setup Utility and return the settings to the default values, and then change the settings as necessary.
Press <F2> to Setup	<ul style="list-style-type: none"> ● Write down the error details and press F2 to start the Setup Utility. Change the settings if necessary.
0613: Serial Port^{*1} configuration changed 0614: Serial Port^{*1} config. error - device disabled ^{*1} "A" or "B" appears here to indicate the name of the conflicting port.	<p>The I/O and IRQ settings of the serial ports are in conflict.</p> <ul style="list-style-type: none"> ● Run the Setup Utility and in the [Advanced] menu, change the port's settings so there is no conflict.
Operating System not found	<p>The operating system is not installed in the floppy disk or the hard disk that you are going to boot from.</p> <ul style="list-style-type: none"> ● If using a floppy disk, change the disk to the one you can use for boot. ● If using the hard disk, check if the hard disk is recognized in [Information] menu of the Setup Utility. If the hard disk is recognized, perform the reinstallation (➔ page 22). If not, contact Panasonic Technical Support (➔ page 36). ● If a device is connected to the USB port, disconnect the device, or set [USB Port] or [Legacy USB Support] to [Disable] in the [Advanced] menu of the Setup Utility. ● If a device is connected to the ExpressCard slot, disconnect the device, or set [ExpressCard slot] to [Disable] in the [Advanced] menu of the Setup Utility.
RAM Module Failed	<p>When the RAM module is not inserted correctly or the RAM module is not conforming to the computer's specifications, a beep will sound and the "RAM Module Failed" message will be displayed when you turn the power on.</p> <ul style="list-style-type: none"> ● Slide the power switch for four seconds or longer to turn off the computer, confirm that the RAM module conforms to the specifications, and reinsert it.

■ To start the Setup Utility

- ① Restart the computer.
- ② Press **F2** several times while [Panasonic] boot screen is displayed.

Troubleshooting (Basic)

Follow the instructions below when a problem has occurred. There is also an advanced troubleshooting guide in the "Reference Manual". For a software problem, refer to the software's instruction manual. If the problem persists, contact Panasonic Technical Support (→ page 36). You can also check the computer's status in the PC Information Viewer (→  Reference Manual "Troubleshooting (Advanced)").

■ Starting Up



Cannot start up. The power indicator or battery indicator is not lit.	<ul style="list-style-type: none"> ● Connect the AC adaptor. ● Insert a fully charged battery. ● Remove the battery pack and the AC adaptor, then connect them again. ● If a device is connected to the USB port, disconnect the device, or set [USB Port] or [Legacy USB Support] to [Disable] in the [Advanced] menu of the Setup Utility. ● If a device is connected to the ExpressCard slot, disconnect the device, or set [ExpressCard slot] to [Disable] in the [Advanced] menu of the Setup Utility.
The power is turned on but "Warming up the system (up to 32 minutes)" appears.	<ul style="list-style-type: none"> ● The computer is warming up before start up. Wait for the computer to start up (takes up to 32 minutes). If, "Cannot warm up the system" is displayed, the computer failed to warm up and does not start. In this case, turn off the computer, leave it in an environment of 5 °C {41 °F} or higher temperature for about an hour, and then turn on the power again.
Cannot turn on the computer. The computer does not resume from standby. (The power indicator blinks quickly in green.)	<ul style="list-style-type: none"> ● Leave it in an environment of 5 °C {41 °F} or higher temperature for about an hour, then turn on the power again.
You have forgotten the password.	<ul style="list-style-type: none"> ● Supervisor Password or User Password: Contact Panasonic Technical Support (→ page 36). ● Administrator password: <ul style="list-style-type: none"> • If you have a password reset disk, you can reset the administrator password. Set the disk and enter any wrong password, then follow the on-screen instructions and set a new password. • If you do not have a password reset disk, reinstall (→ page 22) and set up Windows, and then set a new password.
"Remove disks or other media. Press any key to restart" or a similar message appears.	<ul style="list-style-type: none"> ● A floppy disk is in the drive and it does not contain system startup information. Remove the floppy disk and press any key. ● If a device is connected to the USB port, disconnect the device, or set [USB Port] or [Legacy USB Support] to [Disable] in the [Advanced] menu of the Setup Utility. ● If a device is connected to the ExpressCard slot, disconnect the device, or set [ExpressCard slot] to [Disable] in the [Advanced] menu of the Setup Utility. ● If the problem persists after removing the disk, it may be a hard disk failure. Contact Panasonic Technical Support (→ page 36).
Windows startup and operation is slow.	<ul style="list-style-type: none"> ● Press F9 in the Setup Utility (→ page 24 "To start the Setup Utility") to return the Setup Utility settings (excluding the passwords) to the default values. Start the Setup Utility and make the settings again. (Note that the processing speed depends on the application software, so this procedure may not make Windows faster.) ● If you installed a resident software after purchase, turn off the residence. ● Disable Indexing Service in the following menu. Click [start] - [Search] - [Change preferences] - [Without Indexing Service]
The date and time are incorrect.	<ul style="list-style-type: none"> ● Make the correct settings. Click [start] - [Control Panel] - [Date, Time, Language, and Regional Options] - [Date and Time]. ● If the problem persists, the internal clock battery may need to be replaced. Contact Panasonic Technical Support (→ page 36). ● When the computer is connected to LAN, check the date and time of the server. ● The 2100 A.D. or later year will not be correctly recognized on this computer.
[Executing Battery Recalibration] screen appears.	<ul style="list-style-type: none"> ● The Battery Recalibration was canceled before Windows was shut down last time. To start up Windows, turn off the computer by the power switch, and then turn on.
[Enter Password] does not appear when resuming from standby/hibernation.	<ul style="list-style-type: none"> ● To display [Enter Password] at resuming, set the Windows password. The password you have set in the Setup Utility is not requested at resuming. <ol style="list-style-type: none"> ① Click [start] - [Control Panel] - [User Accounts] and select the account, and set the password. ② Click [start] - [Control Panel] - [Performance and Maintenance] - [Power Options] - [Advanced] and add a check mark for [Prompt for password when computer resumes from standby].

Troubleshooting (Basic)

■ Starting Up

Cannot resume.	<ul style="list-style-type: none"> ● An error may occur when the computer automatically enters the standby or hibernation mode while the screensaver is active. In this case, turn off the screensaver or change the pattern of the screensaver.
Other startup problems.	<ul style="list-style-type: none"> ● Press F9 in the Setup Utility (→ page 24 “To start the Setup Utility”) to return the Setup Utility settings (excluding the passwords) to the default values. Start the Setup Utility and make the settings again. ● Remove all peripheral devices. ● Check to see if there was a disk error. <ol style="list-style-type: none"> ① Click [start] - [My Computer] and right-click [Local Disk(C:)], and click [Properties]. ② Click [Tools] - [Check Now]. ③ Select the option in [Check disk options] and click [Start]. ● Start the computer in Safe Mode and check the error details. When the [Panasonic] boot screen disappears^{*1} at startup, press and hold F8 until the Windows Advanced Options Menu is displayed. <p>^{*1} When [Password on boot] is set to [Enable] in the [Security] menu of the Setup Utility, [Enter Password] appears after the [Panasonic] boot screen disappears. As soon as you enter the password and press Enter, press and hold F8.</p>

■ Entering Password

On the [Enter Password] screen, a beep sounds and the password cannot be entered.	<ul style="list-style-type: none"> ● The computer may be in ten-key mode. If the NumLk indicator  lights, press NumLk to disable the ten-key mode, and then input.
Even after entering the password, [Type your password] is displayed again.	<ul style="list-style-type: none"> ● The computer may be in ten-key mode. If the NumLk indicator  lights, press NumLk to disable the ten-key mode, and then input. ● The computer may be in Caps Lock mode. If the Caps Lock indicator  lights, press Caps Lock to disable the Caps Lock mode, and then input.

■ Shutting down

Windows does not shut down.	<ul style="list-style-type: none"> ● Remove the USB device and the ExpressCard. ● Wait one or two minutes. It is not a malfunction.
-----------------------------	---

■ Display

No display.	<ul style="list-style-type: none"> ● The external display is selected. Press Fn + F3 to switch the display. Wait until the display has been switched completely before pressing Fn + F3 again. ● When using an external display, <ul style="list-style-type: none"> • Check the cable connection. • Turn on the display. • Check the settings of external display. ● The display is turned off by the power-saving function. To resume, do not press the direct selection keys, but press any other key like Ctrl. ● The computer entered standby or hibernation by the power-saving function. To resume, slide the power switch. ● The screen may not be displayed even after the computer resumed from standby or hibernation. In this case, press Fn + F7 to enter standby and resume the computer again.
The screen is dark.	<ul style="list-style-type: none"> ● The screen is darker when the AC adaptor is not connected. Press Fn + F2 and adjust the brightness. As you increase the brightness, battery consumption increases. You can separately set the brightness for when the AC adaptor is connected and when not connected.
The LCD brightness changes a number of times when the AC adaptor is disconnected.	<ul style="list-style-type: none"> ● Intel(R) Display Power Saving Technology is active and automatically changes the LCD brightness. This is not a malfunction.

■ Display

Image colors are not reproduced as expected when displaying photographs or other images.	<ul style="list-style-type: none"> ● Remove the check mark of [Intel(R) Display Power Saving Technology]. <ol style="list-style-type: none"> ① Click [start] - [Control Panel] - [Other Control Panel Options] - [Intel(R) GMA Driver for Mobile]. ② Click [Display Settings] - [Power Settings].
The screen is disordered.	<ul style="list-style-type: none"> ● Changing the number of display colors and resolution may affect the screen. Restart the computer. ● Connecting/disconnecting an external display may affect the screen. Restart the computer. ● When using Simultaneous display, set the same display colors for the external display as those for the LCD. ● When using Simultaneous display, do not press Fn + F3. ● Enable or disable Simultaneous display, and soon restart the computer.
During Simultaneous display, one of the screens becomes disordered.	<ul style="list-style-type: none"> ● When using the Extended Desktop, use the same display colors for the external display as those used by the LCD. ● If you continue to experience problems, try changing the display by clicking [start] - [Control Panel] - [Other Control Panel Options] - [Intel(R) GMA Driver for Mobile] - [Display Devices]. ● When the [Command Prompt] is set to "Full Screen" by pressing Alt + Enter, the picture is displayed on one of the screens only. When the window display is restored by pressing Alt + Enter, the picture is displayed on both screens. ● Simultaneous display cannot be used until Windows startup is complete (during Setup Utility, etc.).
The external display does not work normally.	<ul style="list-style-type: none"> ● If the external display does not support the power saving function, it may not work normally when the computer enters the power saving mode. Turn off the external display.

■ Touch Pad / Touchscreen (only for model with touchscreen)/Digitizer (only for model with digitizer)

The cursor does not work.	<ul style="list-style-type: none"> ● When using the external mouse, connect it correctly. ● Restart the computer using the keyboard. (Press Alt, U, and R to select [Restart].) ● If the computer does not respond to keyboard commands, read "No response" (→ page 28).
Cannot input using the touch pad.	<ul style="list-style-type: none"> ● Set [Touch Pad] to [Enable] in the [Main] menu of the Setup Utility. ● The drivers for some mice may disable the touch pad. Check your mouse's operating instructions.
Cannot point the correct position using the included stylus/pen.	<p><Only for model with touchscreen></p> <ul style="list-style-type: none"> ● Perform the touchscreen calibration (→ page 15). <p><Only for model with digitizer></p> <ul style="list-style-type: none"> ● Perform the digitizer calibration. ● Use the included pen. ● On the Windows logon screen or the Welcome screen, you may not be able to point the correct position using the included pen. Use the keyboard or the touch pad to log on.

■ Reference Manual

The Reference Manual is not displayed.	<ul style="list-style-type: none"> ● Install Adobe Reader. <ol style="list-style-type: none"> ① Log on to Windows as an administrator. ② Click [start] - [Run], input [c:\util\reader\AdbeRdr70_enu_full.exe], then click [OK]. Follow the on-screen instructions. ③ Update Adobe Reader to its latest version. If your computer is connected to the internet, start up Adobe Reader and click [Help] - [Check for updates now].
--	---

Troubleshooting (Basic)

■ Recover Pro

Cannot install Recover Pro	<ul style="list-style-type: none"> ● Recover Pro cannot be installed when four primary partitions exist. Reduce the number of primary partitions to three or less before installation. You can check the number of the primary partitions in the order of [start] - [Control Panel] - [Performance and Maintenance] - [Administrative Tools] - [Computer Management] - [Disk Management]. ● Recover Pro cannot be installed when a backup area is remaining on the hard disk. Try one of the following methods: <ul style="list-style-type: none"> • If the backup area has complete backup data and you want to restore that data: Follow the “Complete Restore” instructions in “Hard Disk Backup Function (Recover Pro)” (→ page 20) to restore the data. • To return the computer to its condition at the time of shipment: Reinstall the software (→ page 22). <ul style="list-style-type: none"> • In step 9, do not select “3. Reinstall Windows to the first partition.” • If you do not need the data in the backup area, or if it is corrupted, or if does not include complete backup data: <ol style="list-style-type: none"> ① Access [http://www.phoenix.com/en/Customer+Services/Utilities/Recover+Pro+6.htm#Where], and download/install “Cleanup Utility for Recover Pro 6”. ② Delete the backup area using “Cleanup Utility for Recover Pro 6”. ③ Reinstall Recover Pro. In this case, all data in the backup area will be lost.
An unnecessary backup area is present (is left) when Recover Pro is not installed.	<ol style="list-style-type: none"> ① Access [http://www.phoenix.com/en/Customer+Services/Utilities/Recover+Pro+6.htm#Where], and download/install “Cleanup Utility for Recover Pro 6”. ② Delete the backup region using “Cleanup Utility for Recover Pro 6”.
Some parts of the hard disk cannot be File Backed up.	<ul style="list-style-type: none"> ● The hard disk area encrypted by security software may not be backed up. Exclude the area from the File Backup object.

■ Others

No response.	<ul style="list-style-type: none"> ● Press Ctrl+Shift+Esc to open Task Manager and close the software application that is not responding. ● An input screen (e.g., password input screen at startup) may be hidden behind another window. Press Alt+Tab to check. ● Slide the power switch for four seconds or longer to shut down the computer, and then slide the power switch to turn it on. If the application program does not work normally, uninstall and reinstall the program. To uninstall, click [start] - [Control Panel] - [Add or Remove Programs].
--------------	--

Hardware Diagnostics

If it appears that the hardware installed in this computer is not operating properly, you can use the PC-Diagnostic Utility to determine whether or not there is a problem.

If the utility discovers a problem in the hardware, contact Panasonic Technical Support.

Hardware that can be checked using the PC-Diagnostic Utility

Software cannot be checked using this utility.

- CPU
- Memory
- Hard Disk
- Video Controller
- Sound^{*1}
- Modem
- LAN
- Wireless LAN^{*2}
- Wireless WAN^{*3}
- Bluetooth^{*4}
- GPS^{*5}
- USB
- IEEE 1394
- PC Card Controller
- SD Card Controller
- Serial Port
- Keyboard
- Touch Pad
- Touchscreen^{*6}
- Digitizer^{*7}

^{*1} When the diagnostic utility is running, a loud beep will sound, so do not use headphones at this time. (The beep will not sound if mute is using Windows.)

^{*2} Only for model with wireless LAN

^{*3} Only for model with wireless WAN

^{*4} Only for model with Bluetooth

^{*5} Only for model with GPS

^{*6} Only for model with touchscreen

^{*7} Only for model with digitizer. The display icon is "Touch Screen".

Regarding the PC-Diagnostic Utility

NOTE





- Run this utility using the default settings in the Setup Utility. If the Setup Utility or other settings will not allow a hardware to be executed, the hardware icon will be displayed in gray.
- For the hard disk and memory only, you can select standard diagnostic check or extended diagnostic check.
- When the PC-Diagnostic Utility starts up, it will run the standard diagnostic check. The extended diagnostic check is more detailed, and so requires a longer period of time to run.
When the video diagnostic check is running, the display may be distorted, and when the audio diagnostic check is running, sounds may be generated from the speakers. These are not malfunctions.
- You can check the status of the diagnostic check by the display color on the left side of the hardware icon (A).
 - Aqua: Not running diagnostic check
 - Alternating blue and yellow: Currently running diagnostic check. The interval of the alternating colors differs depending on the type of diagnostic check currently running.
During memory diagnostic check, the display may freeze for a long period of time. Wait until the process is complete.
 - Green: No problems discovered
 - Red: Problems discovered



Hardware Diagnostics

- We recommend that you use the touch pad for operations. When not using the touch pad, you can operate using the internal keyboard instead. Do not use the touchscreen or the digitizer.

Operations	Touch pad operations	Internal keyboard operations
Select icon	Place the cursor above the icon	Press Space , and then press → ← ↑ ↓ (⊗ (close) cannot be selected)
Click the icon	Tap or click (right click cannot be used)	Press Space above the icon
Complete the PC-Diagnostics Utility and then restart the computer	Click ⊗ (close)	Press Ctrl+Alt+Del .



- By clicking the icon, you can execute the following operations:
 -  : Start the diagnostic check from the beginning
 -  : Stop the diagnostic check (You cannot restart the check partway through by clicking )
 -  : Display help (click the screen or press **Space** to return to the original diagnostic check screen)

Running the Diagnostic Check

Disconnect any peripheral devices (e.g., storage device) before running the diagnostic check.

- 1 Connect the AC adaptor and turn on the wireless switch (→ page 11).**
During the diagnostic check, do not remove the AC adaptor, or attach any peripheral devices.
- 2 Turn on or restart the computer, and press **F2** while [Panasonic] boot screen is displayed.**
The Setup Utility starts up.
 - If the password is requested, enter the Supervisor Password.
 - If you are using the computer after changing the settings from the status at the time of purchase, we recommend that you make a note of the settings that are changed.
- 3 Press **F9**.**
At the confirmation message, select [Yes] and press **Enter**.
- 4 Press **F10**.**
At the confirmation message, select [Yes] and press **Enter**.
The computer will restart.
- 5 Press **Ctrl+ F7** while [Panasonic] boot screen is displayed.**
When the PC-Diagnostic Utility starts up, it will automatically begin the diagnostic check for all hardware components.
 - If the password is requested, enter the password.
 - The touch pad and the internal keyboard cannot be used until alternating blue and yellow colors are displayed on the left side of the hardware icon (→ page 29). If the touch pad does not operate properly, press **Ctrl+Alt+Del** to restart the computer, or slide the power switch to turn the power off, and then restart the PC-Diagnostic Utility.

NOTE

- Using the following procedure, you can run a diagnostic check on a specified hardware component, or run an extended diagnostic check on the hard disk.
 - ① Click  to stop the diagnostic check.
 - ② Click the icon for the hardware that is not to be checked, so that the icon is displayed in gray (B).
When running a check on the hard disk, clicking the icon once will turn on the extended diagnostic check ("FULL" (C) will be displayed below the icon); click again, and the icon will be displayed in gray.
 - ③ Click  to start the diagnostic check.

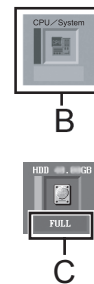

6 When all the hardware has been checked, confirm the diagnostic check results.

If the display is red and the message “Check Result TEST FAILED” is displayed, you can assume that there is a problem with the computer’s hardware. Confirm which hardware component is displayed as red, and contact Panasonic Technical Support.

If the display is green and the message “Check Result TEST PASSED” is displayed, the computer’s hardware is operating normally. Continue using the computer as is. If the computer still does not operate properly, reinstall the software. (→ page 22)

NOTE

- If you run a memory diagnostic check after installing a new RAM module (sold separately) and the message “Check Result TEST FAILED” is displayed:

Remove the additional RAM module and run the diagnostic check again. If the message “Check Result TEST FAILED” is still displayed, you can assume that there is a problem with the internal RAM module.

- ## 7 After the diagnostic check is complete, click (close), or press **Ctrl+Alt+Del** to restart the computer.

LIMITED USE LICENSE AGREEMENT

THE SOFTWARE PROGRAM(S) (“PROGRAMS”) FURNISHED WITH THIS PANASONIC® PRODUCT (“PRODUCT”) ARE LICENSED ONLY TO THE END-USER (“YOU”), AND MAY BE USED BY YOU ONLY IN ACCORDANCE WITH THE LICENSE TERMS DESCRIBED BELOW. YOUR USE OF THE PROGRAMS SHALL BE CONCLUSIVELY DEEMED TO CONSTITUTE YOUR ACCEPTANCE OF THE TERMS OF THIS LICENSE.

Matsushita Electric Industrial Co., Ltd. (“MEI”) has developed or otherwise obtained the Programs and hereby licenses their use to you. You assume sole responsibility for the selection of the Product (including the associated Programs) to achieve your intended results, and for the installation, use and results obtained therefrom.

LICENSE

- A. MEI hereby grants you a personal, non-transferable and non-exclusive right and license to use the Programs in accordance with the terms and conditions stated in this Agreement. You acknowledge that you are receiving only a LIMITED LICENSE TO USE the Programs and related documentation and that you shall obtain no title, ownership nor any other rights in or to the Programs and related documentation nor in or to the algorithms, concepts, designs and ideas represented by or incorporated in the Programs and related documentation, all of which title, ownership and rights shall remain with MEI or its suppliers.
- B. You may use the Programs only on the single Product which was accompanied by the Programs.
- C. You and your employees and agents are required to protect the confidentiality of the Programs. You may not distribute or otherwise make the Programs or related documentation available to any third party, by time-sharing or otherwise, without the prior written consent of MEI.
- D. You may not copy or reproduce, or permit to be copied or reproduced, the Programs or related documentation for any purpose, except that you may make one (1) copy of the Programs for backup purposes only in support of your use of the Programs on the single Product which was accompanied by the Programs. You shall not modify, or attempt to modify, the Programs.
- E. You may transfer the Programs and license them to another party only in connection with your transfer of the single Product which was accompanied by the Programs to such other party. At the time of such a transfer, you must also transfer all copies, whether in printed or machine readable form, of every Program, and the related documentation, to the same party or destroy any such copies not so transferred.
- F. You may not remove any copyright, trademark or other notice or product identification from the Programs and you must reproduce and include any such notice or product identification on any copy of any Program.

YOU MAY NOT REVERSE ASSEMBLE, REVERSE COMPILE, OR MECHANICALLY OR ELECTRONICALLY TRACE THE PROGRAMS, OR ANY COPY THEREOF, IN WHOLE OR IN PART.

YOU MAY NOT USE, COPY, MODIFY, ALTER, OR TRANSFER THE PROGRAMS OR ANY COPY THEREOF, IN WHOLE OR IN PART, EXCEPT AS EXPRESSLY PROVIDED IN THE LICENSE.

IF YOU TRANSFER POSSESSION OF ANY COPY OF ANY PROGRAM TO ANOTHER PARTY, EXCEPT AS PERMITTED IN PARAGRAPH E ABOVE, YOUR LICENSE IS AUTOMATICALLY TERMINATED.

TERM

This license is effective only for so long as you own or lease the Product, unless earlier terminated. You may terminate this license at any time by destroying, at your expense, the Programs and related documentation together with all copies thereof in any form. This license will also terminate effective immediately upon occurrence of the conditions thereof set forth elsewhere in this Agreement, or if you fail to comply with any term or condition contained herein. Upon any such termination, you agree to destroy, at your expense, the Programs and related documentation together with all copies thereof in any form.

YOU ACKNOWLEDGE THAT YOU HAVE READ THIS AGREEMENT, UNDERSTAND IT AND AGREE TO BE BOUND BY ITS TERMS AND CONDITIONS. YOU FURTHER AGREE THAT IT IS THE COMPLETE AND EXCLUSIVE STATEMENT OF THE AGREEMENT BETWEEN US, WHICH SUPERSEDES ANY PROPOSAL OR PRIOR AGREEMENT, ORAL OR WRITTEN, AND ANY OTHER COMMUNICATIONS BETWEEN US, RELATING TO THE SUBJECT MATTER OF THIS AGREEMENT.

About Intel® software products

The enclosed software products and documentation were developed at private expense, and are provided with “RESTRICTED RIGHTS.” Use, duplication or disclosure by the government is subject to restrictions as set forth in FAR 52.227-14 and DFARS 252.227-7013 et. seq. or its successor. The use of this product by the government constitutes acknowledgment of Intel’s proprietary rights in the product.

Contrat de licence d'usage limité

Le(s) logiciel(s) (les "Logiciels") fournis avec ce produit Panasonic® (le "Produit") sont exclusivement concédés en licence à l'utilisateur ultime ("vous"), et ils ne peuvent être utilisés que conformément aux clauses contractuelles ci-dessous. En utilisant les logiciels, vous vous engagez de manière définitive à respecter les termes, clauses et conditions des présentes.

Matsushita Electric Industrial Co., Ltd. ("MEI") a mis au point ou obtenu les Logiciels et vous en concède l'utilisation par les présentes. Vous assumez l'entière responsabilité du choix de ce Produit (y compris des Logiciels associés) pour obtenir les résultats escomptés, ainsi que de l'installation, de l'utilisation et des résultats obtenus.

Licence

- A. MEI vous octroie par les présentes le droit et la licence personnels, non cessibles et non exclusifs d'utiliser les Logiciels conformément aux termes, clauses et conditions de ce contrat. Vous reconnaissez ne recevoir qu'un droit limité d'utiliser les Logiciels et la documentation les accompagnant et vous vous engagez à n'obtenir aucun droit de titre, propriété ni aucun autre droit vis-à-vis des Logiciels et de la documentation les accompagnant ni vis-à-vis des algorithmes, concepts, dessins, configurations et idées représentés par ou incorporés dans les Logiciels et la documentation les accompagnant, dont les titres, propriété et droits resteront tous à MEI ou à leurs propriétaires.
- B. Vous ne pouvez utiliser les Logiciels que sur le Produit unique qui est accompagné par les Logiciels.
- C. Vous et vos employés ou agents êtes requis de protéger la confidentialité des Logiciels. Vous ne pouvez ni distribuer ni mettre les Logiciels et la documentation les accompagnant à la disposition d'un tiers, par partage de temps ou de quelque autre manière que ce soit, sans l'autorisation écrite préalable de MEI.
- D. Vous ne pouvez ni copier ni reproduire ni permettre la copie ni la reproduction des Logiciels ni de la documentation les accompagnant pour quelque fin que ce soit, à l'exception d'une (1) copie des Logiciels à des fins de sauvegarde uniquement pour soutenir votre utilisation des Logiciels sur le Produit unique qui est accompagné par les Logiciels. Vous ne pouvez ni modifier ni tenter de modifier les Logiciels.
- E. Vous ne pouvez céder les Logiciels et en octroyer la licence à une autre partie qu'en rapport avec votre cession du Produit unique qui est accompagné par les Logiciels à cette autre partie. Au moment de cette cession, vous devez céder également toutes les copies, que ce soit sous forme imprimée ou lisible par la machine, de tous les Logiciels ainsi que de la documentation les accompagnant, à la même partie ou détruire les copies non cédées.
- F. Vous ne pouvez retirer aucune marque de droits d'auteur, marque de commerce ou autre ni aucune identification de produit des Logiciels et vous devez reproduire et inclure toutes ces notices ou identifications de produit sur toutes les copies des Logiciels.

Vous ne pouvez assembler en sens inverse, compiler en sens inverse ni retracer les Logiciels ni aucune de leurs copies, de façon électronique ou mécanique, en tout ou en partie.

Vous ne pouvez utiliser, copier, modifier, altérer ni céder les Logiciels ni aucune de leurs copies, en tout ou en partie, à l'exception de ce qui est expressément stipulé dans ce contrat.

Si vous cédez la possession de toute copie ou de tout Logiciel à une autre partie, à l'exception de ce qui est autorisé au paragraphe E ci-dessus, votre licence est automatiquement résiliée.

Termes, clauses et conditions

Cette licence n'est effective que pour la durée de possession ou de crédit-bail du Produit, à moins d'une résiliation antérieure. Vous pouvez résilier cette licence à tout moment en détruisant, à vos frais, les Logiciels et la documentation les accompagnant avec toutes leurs copies, sous quelque forme que ce soit. Cette licence sera également résiliée, avec application immédiate, si les conditions de résiliation définies ailleurs dans ce contrat se sont réalisées ou si vous ne respectez pas les termes, clauses et conditions qui y sont contenues. Au moment de la résiliation, vous acceptez de détruire, à vos frais, les Logiciels et la documentation les accompagnant avec toutes leurs copies, sous quelque forme que ce soit.

Vous reconnaissez avoir lu ce contrat, en avoir compris toute la substance et avoir accepté de respecter ses termes, clauses et conditions. Vous reconnaissez en outre qu'ils sont la description complète et exclusive du contrat conclu entre nous, contrat qui remplace et annule toute proposition ou contrat précédent, écrit ou oral, et toute autre communication entre nous, relativement à l'objet du présent contrat.

Specifications

This page provides the specifications for the basic model CF-19CHBAXBM/CF-19CDBAXVM. The model number is different according to the unit configuration.

- To check the model number:
Check the bottom of the computer or the box the computer came in at the time of purchase.
- To check CPU speed, memory size and the hard disk drive (HDD) size:
Run the Setup Utility (→  *Reference Manual* "Setup Utility") and select [Information] menu.
[CPU Speed]: CPU speed, [System Memory]: Memory size, [Hard Disk]: Hard disk drive size

■ Main Specifications

Model No.		CF-19CHBAXBM	CF-19CDBAXVM
CPU		Intel® Core™ Duo Processor U2400 (1.06 GHz, 2 MB ^{*1} L2 cache, 533 MHz FSB)	
Chipset		Intel® 945GM	
Memory ^{*1*2}		512 MB (4096 MB Max.)	
Video Memory ^{*1*3}		UMA (128 MB Max.)	
Hard Disk Drive ^{*4}		80 GB	
Display Method		10.4 XGA type (TFT)	
Internal LCD ^{*5}		65,536/16,777,216 colors (800 × 600 dots/1024 × 768 dots)	
External Display ^{*6}		65,536/16,777,216 colors (800 × 600 dots/1024 × 768 dots/1280 × 768 dots/1280 × 1024 dots)	
Wireless LAN ^{*7}		→ page 35	
Bluetooth™ ^{*8}		→ page 35	
LAN		IEEE 802.3 10Base-T, IEEE 802.3u 100Base-TX	
Modem		Data: 56 kbps (V.92) FAX: 14.4 kbps	
Sound		WAVE and MIDI playback, Intel® High Definition Audio subsystem support, Monaural speaker	
Security Chip		TPM (TCG V1.2 compliant) ^{*9}	
Card Slot	PC Card	Type I or Type II x 1 (3.3 V: 400 mA, 5 V: 400 mA)	
	ExpressCard	ExpressCard/34 ^{*10} or ExpressCard/54 x 1	
	SD Memory Card ^{*11}	x 1, Data transfer rate = 8 MB per second ^{*12}	
RAM Module Slot		200-pin, 1.8 V, SO-DIMM, DDR2 SDRAM, PC2-4200 Compliant	
Interface		USB port (4-pin, USB 2.0) x 2, Serial Port (Dsub 9-pin male), Modem port (RJ-11), LAN port (RJ-45), External display port (Mini Dsub 15-pin female), Expansion Bus Connector (Dedicated 100-pin female), External Antenna Connector (Dedicated 50 Ω coaxial connector) x 2, IEEE 1394a Interface Connector (4-pin x 1), Microphone Jack (Miniature jack, 3.5 DIA, Stereo), Headphone Jack (Miniature jack, 3.5 DIA, Impedance 32 Ω, Output Power 4 mW x 2)	
Keyboard / Pointing Device		82 keys / Touch Pad / Touchscreen (Anti-Reflection, Stylus (included) touch capable)	82 keys / Touch Pad / Digitizer (Anti-Reflection)
Power Supply		AC adaptor or Battery pack	
AC Adaptor ^{*13}		Input: 100 V to 240 V AC, 50 Hz/60 Hz, Output: 16.0 V DC, 3.75 A	
Battery Pack		Li-ion 10.65 V, 5.7 Ah	
Operating Time ^{*14}		Approx. 4.5 hours to 8 hours ^{*15} (Approx. 7 hours ^{*16})	
Charging Time ^{*14}	Power on	Approx. 7.5 hours	
	Power off	Approx. 4.5 hours	
Clock Battery		Coin type lithium battery 3.0 V	
Power Consumption ^{*17}		Approx. 26 W ^{*18} / Approx. 55 W (Maximum when recharging in the ON state)	
Physical Dimensions (W × H × D) (excluding the hand strap/shoulder strap)		271 mm × 49 mm × 216 mm {10.7" × 1.93" × 8.5"}	
Weight (excluding the hand strap/shoulder strap)		Approx. 2.25 kg {Approx. 4.96 lb.}	Approx. 2.30 kg {Approx. 5.07 lb.}
Operation Environment		Temperature: 5 °C to 35 °C {41 °F to 95 °F} Humidity: 30% to 80% RH (No condensation)	
Storage Environment		Temperature: -20 °C to 60 °C {-4 °F to 140 °F} Humidity: 30% to 90% RH (No condensation)	

■ Main Specifications

Operating System	Microsoft® Windows® XP Professional Service Pack 2 with Advanced Security Technologies (NTFS File System)	Microsoft® Windows® XP Tablet PC Edition 2005 (NTFS File System)
Utility Programs	DMI Viewer, Microsoft® Windows® Media Player 10, Adobe Reader, PC Information Viewer, SD Utility, Icon Enlarger, Loupe Utility, Intel® Matrix Storage Manager, Intel® PROSet/Wireless Software ^{*7} , Bluetooth™ Stack for Windows® by TOSHIBA ^{*8} , Wireless Switch Utility, Hotkey Settings, Battery Recalibration Utility, Panasonic Hand Writing ^{*19} , Software Keyboard ^{*19} , Display Rotation Tool, Infineon TPM Professional Package ^{*20} , Recover Pro™ 6 ^{*20} , Tablet Buttons Settings ^{*19}	
	Setup Utility, Hard Disk Data Erase Utility ^{*21} , PC-Diagnostic Utility	

■ Wireless LAN <Only for model with wireless LAN>

Intel PRO / Wireless 3945 ABG (802.11 a + b + g)	
Data Transfer Rates ^{*22}	IEEE802.11a: 54/48/36/24/18/12/9/6 Mbps (automatically switched) IEEE802.11b: 11/5.5/2/1 Mbps (automatically switched) IEEE802.11g: 54/48/36/24/18/12/9/6 Mbps (automatically switched)
Standards Supported	IEEE802.11a/IEEE802.11b/IEEE802.11g
Transmission method	OFDM system, DSSS system
Wireless Channels Used	IEEE802.11a: Channels 36/40/44/48/52/56/60/64/149/153/157/161/165 IEEE802.11b/IEEE802.11g: Channels 1 to 11
RF Frequency Band	IEEE802.11a: 5.18-5.32 GHz, 5.745-5.825 GHz IEEE802.11b/IEEE802.11g: 2.412-2.462 GHz

■ Bluetooth™ <Only for model with Bluetooth>

Bluetooth Version	2.0 + EDR
Transmission method	FHSS system
Wireless Channels Used	Channels 1 to 79
RF Frequency Band	2.402-2.48 GHz
Power Class	Class1

^{*1} 1 MB = 1,048,576 bytes

^{*2} You can physically expand the memory upto 4 GB, but the total amount of usable memory available will be less depending on the actual system configuration.

^{*3} A segment of the main memory is allotted automatically depending on the computer's operating status. The size of the Video Memory cannot be set by the user.

^{*4} 1 GB = 1,000,000,000 bytes. Your operating system or some application software will report as fewer GB.

^{*5} A 16,777,216 color display is achieved by using the dithering function.

^{*6} Maximum resolution depends on the specifications of the external display.

^{*7} Only for model with wireless LAN

^{*8} Only for model with Bluetooth

^{*9} For information on TPM, click [start] - [Run] and input "c:\util\drivers\tpm\README.pdf", and refer to the Installation Manual of "Trusted Platform Module (TPM)".

^{*10} When using ExpressCard/34, the card slot cover cannot be closed.

^{*11} Operation has been tested and confirmed using Panasonic SD Memory Cards with a capacity of up to 2 GB.

The transfer rate using the SD Memory Card slot on this computer is 8 MB per second. (This is a theoretical value, and differs from actual speeds.)

The transfer rate is 8 MB per second even if you use an SD Memory Card that supports high-speed transfer rates.

Operation on other SD equipment is not guaranteed.

This computer is not compatible with MultiMediaCards or SDHC Memory Cards. Do not insert these kinds of cards.

^{*12} Theoretical value and not the actual speed. The transfer rate does not become higher even if you use a card that supports the higher transfer rate.

^{*13} The AC adaptor is compatible with power sources up to 240 V AC adaptor. The computer is supplied with a 125 V AC compatible AC cord. 20-M-2-1

^{*14} Varies depending on the usage conditions.

^{*15} Measured using BatteryMark™ Version 4.0.1 (LCD brightness: Maximum - Minimum)

^{*16} Measured using MobileMark™ 2005 (LCD brightness: 60 cd/m²)

^{*17} Approx. 26 W when the battery pack is fully charged (or not being charged) and the computer is OFF.

Approx. 1.2 W when the Wake up from LAN has been enabled.

^{*18} Rated power consumption 23-E-1

^{*19} Only for model with Windows XP Professional

^{*20} You need to install to use the feature.

^{*21} The Product Recovery DVD-ROM is required.

^{*22} These are speeds specified in IEEE802.11a+b+g standards. Actual speeds may differ.

LIMITED WARRANTY

For U.S.A.

PANASONIC PERSONAL COMPUTER AND PERIPHERALS LIMITED WARRANTY

Panasonic Computer Solutions Company (referred to as "Panasonic") will repair this product (other than software, which is covered by a separate warranty) with new or rebuilt parts, free of charge in the U.S.A. for three (3) years from the date of original purchase in the event of a defect in materials or workmanship. This warranty includes the AC adaptor but excludes the batteries and all other options and accessories which are covered for a period of one (1) year from the date of purchase.

This warranty is extended solely to the original purchaser. A purchase receipt or other proof of date of original purchase will be required before warranty performance is rendered.

This warranty only covers failures due to defects in materials or workmanship which occur during normal use. It does not cover damage which occurs in shipment or failures which are caused by products not supplied by Panasonic, or failures which result from alteration, accident, misuse, introduction of liquid or other foreign matter into the unit, abuse, neglect, installation, maladjustment of consumer controls, improper maintenance, modification or service by anyone other than a Factory Service Center or authorized Panasonic Service Dealer, or damage that is attributable to acts of God.

THIS PRODUCT IS NOT INTENDED FOR USE AS, OR AS PART OF, NUCLEAR EQUIPMENT/SYSTEMS, AIR TRAFFIC CONTROL EQUIPMENT/SYSTEMS, OR AIRCRAFT COCKPIT EQUIPMENT/SYSTEMS^{*1}. PANASONIC WILL NOT BE RESPONSIBLE FOR ANY LIABILITY RESULTING FROM THE USE OF THIS PRODUCT ARISING OUT OF THE FOREGOING USES.

^{*1} AIRCRAFT COCKPIT EQUIPMENT/SYSTEMS include Class2 Electrical Flight Bag (EFB) Systems and Class1 EFB Systems when used during critical phases of flight (e.g., during take-off and landing) and/or mounted on to the aircraft. Class1 EFB Systems and 2 EFB Systems are defined by FAA: AC (Advisory Circular) 120-76A or JAA: JAA TGL (Temporary Guidance Leaflets) No.36

Limits and Exclusions:

There are no other express warranties except as listed below.

PANASONIC SHALL NOT BE LIABLE FOR LOSS OF DATA OR OTHER INCIDENTAL OR CONSEQUENTIAL DAMAGES RESULTING FROM THE USE OF THIS PRODUCT, OR ARISING OUT OF ANY BREACH OF THIS WARRANTY. ALL EXPRESS AND IMPLIED WARRANTIES, INCLUDING THE WARRANTIES OF MERCHANTABILITY AND FITNESS FOR A PARTICULAR PURPOSE ARE LIMITED TO THE APPLICABLE WARRANTY PERIOD SET FORTH ABOVE. Some states do not allow the exclusion or limitation of incidental or consequential damages, or limitations on how long an implied warranty lasts, so the above limitations or exclusions may not apply to you.

This limited warranty gives you specific legal rights, and you may also have other rights which vary from state to state. If a problem with your product develops during or after the warranty period, you may contact our representatives at 1-800-LAPTOP5. If the problem is not handled to your satisfaction, then write to the Consumer Affairs Division at the address indicated below.

SOFTWARE LIMITED WARRANTY

Panasonic Computer Solutions Company (referred to as "Panasonic") warrants to you only that the disk(s) or other media on which the Programs are furnished will be free from defects in materials and workmanship under normal use for a period of sixty (60) days from the date of delivery thereof to you, as evidenced by your purchase receipt.

This is the only warranty Panasonic makes to you. Panasonic does not warrant that the functions contained in the Programs will meet your requirements or that the operation of the Programs will be uninterrupted or error free.

Panasonic's entire liability, and your exclusive remedy under this warranty shall be limited to the replacement, in the United States, of any defective disk or other media which is returned to Panasonic's Authorized Service Center, together with a copy of the purchase receipt, within the aforesaid warranty period.

Anything in the foregoing to the contrary notwithstanding, Panasonic shall have no obligation for any defects in the disk(s) or other media on which the Programs are furnished resulting from your storage thereof, or for defects that have been caused by operation of the disk(s) or other media otherwise than on the Product or in environmental conditions other than those specified by Panasonic by alteration, accident, misuse, abuse, neglect, mishandling, misapplication, installation, maladjustment of consumer controls, improper maintenance, modification of damage that is attributable to acts of God. In addition, Panasonic shall have no obligation for any defects in the disk(s) or other media if you have modified, or attempted to modify any Program.

DURATION OF IMPLIED WARRANTIES, IF ANY, IS LIMITED TO SIXTY (60) DAYS.

PANASONIC ASSUMES NO RISK OF AND SHALL NOT IN ANY CASE BE LIABLE FOR ANY DAMAGES, INCLUDING, WITHOUT LIMITATION, ANY SPECIAL, INCIDENTAL, CONSEQUENTIAL, OR PUNITIVE DAMAGES ARISING FROM BREACH OF WARRANTY OR CONTRACT, NEGLIGENCE OR ANY OTHER LEGAL THEORY, INCLUDING, WITHOUT LIMITATION LOSS OF GOODWILL, PROFITS OR REVENUE, LOSS OF USE OF THE PROGRAMS OR PRODUCTS OR ANY ASSOCIATED EQUIPMENT, COST OF CAPITAL, COST OF ANY SUBSTITUTE EQUIPMENT, FACILITIES, SERVICES, DOWNTIME COSTS, OR CLAIMS OF ANY PARTY DEALING WITH YOU FOR SUCH DAMAGES.

Some states do not allow the exclusion or limitation of incidental or consequential damages, or limitations on how long an implied warranty lasts, so the above limitations or exclusions may not apply to you.

This limited warranty gives you specific legal rights, and you may also have other rights which vary from state to state.

This Limited Warranty will be governed by the laws the State of New York, without regard to its conflict-of-laws rules.

* * *

To obtain service or technical assistance within the continental U.S.A. and Alaska

DIAL TOLL FREE: 1-800-LAPTOP5

Correspondence requesting product information should be sent to:

Panasonic Computer Solutions Company
3 Panasonic Way, Panazip 2F-5, Secaucus, NJ 07094

For Canada

PANASONIC COMPUTER AND PERIPHERALS LIMITED WARRANTY

Coverage – Panasonic Canada Inc. (“PCI”) warrants to you, the first end user customer, this computer product (excluding software media), when purchased from PCI or from a PCI authorized reseller, to be free from defects in materials and workmanship under normal use, subject to the terms set forth below, during the period of warranty coverage specified.

Scope of Coverage	Period of Coverage	Type of Failure Coverage
Whole Product (except Batteries), AC adaptor and CD-ROM (if factory installed)	Three (3) Years from Date of Original End User Customer Purchase	Defective Materials or Workmanship
Batteries, CD-ROM (unless factory installed), Port Replicator, Extra Memory Modules and all other Peripherals, Options and Accessories	One (1) Year from Date of Original End User Customer Purchase	Defective Materials or Workmanship

Remedy – In the event of a warranty claim, contact PCI’s representatives within the applicable warranty period, identifying the nature of the defect claimed, at 1-800-668-8386 between 9:00 A.M. and 5:00 P.M., Eastern Time Zone, Mon. – Fri. (excluding holidays) for instructions on how to obtain service. A purchase receipt or other proof of date of original purchase is required before warranty service is performed. Defective parts covered by this Limited Warranty will be repaired or replaced with new or comparable rebuilt parts on an exchange basis. Warranty replacement or repair is subject to the terms of this Limited Warranty for the balance of the original period of warranty coverage.

No Coverage – This Limited Warranty does not cover products purchased outside Canada. Neither does it cover damage to, failure of, or defects in a product or accessory through mishandling, improper installation, abnormal use, misuse, neglect, accident, introduction of liquid or other foreign matter into the product, alteration or servicing by anyone not authorized by PCI, or act of God. THIS PRODUCT IS NOT INTENDED FOR USE AS, OR AS PART OF, NUCLEAR EQUIPMENT/SYSTEMS, AIR TRAFFIC CONTROL EQUIPMENT/SYSTEMS, OR AIRCRAFT COCKPIT EQUIPMENT/SYSTEMS^{*1}. PANASONIC WILL NOT BE RESPONSIBLE FOR ANY LIABILITY RESULTING FROM THE USE OF THIS PRODUCT ARISING OUT OF THE FOREGOING USES.

^{*1} AIRCRAFT COCKPIT EQUIPMENT/SYSTEMS include Class2 Electrical Flight Bag (EFB) Systems and Class1 EFB Systems when used during critical phases of flight (e.g., during take-off and landing) and/or mounted on to the aircraft. Class1 EFB Systems and 2 EFB Systems are defined by FAA: AC (Advisory Circular) 120-76A or JAA: JAA TGL (Temporary Guidance Leaflets) No.36

IF YOU SHIP THE PRODUCT FOR WARRANTY SERVICE

Carefully pack the product, preferably in the original carton. Include details of defect claimed and proof of date of original purchase. No liability is assumed for loss or damage to the product while in transit, if you chose your own transportation carrier.

SOFTWARE MEDIA LIMITED WARRANTY

Coverage – Panasonic Canada Inc. (“PCI”) warrants to you, the first end user customer, that the disk(s) or other media on which software program(s) is/are supplied will be free from defects in materials and workmanship under normal use in Canada for a period of sixty (60) days from date of receipt as evidenced by your purchase receipt for your Panasonic Computer product.

THIS IS THE ONLY WARRANTY THAT PCI MAKES RESPECTING THE SOFTWARE MEDIA. PCI does not warrant the software. Please refer to the software licensor’s written warranty (accompanying the copy of the software) for any software warranty claim.

Claim Procedure – In the event of a defect in material or workmanship in the media during the sixty (60) day warranty period, and you return it, transportation costs prepaid, to Panasonic Canada Inc., Computer Products Marketing, at the above address, within the warranty period, together with a copy of your purchase receipt, and an explanation of the suspected defect, PCI will replace in Canada the defective disk(s) or other media.

Remedy – PCI’s entire liability, and your only remedy for any breach of this software media warranty is limited to replacement of the media only. It does not cover any other damages, including, but not limited to, loss of use or profit loss, or special, indirect or consequential damages, or other claims, whether or not of similar character.

No Coverage – This limited warranty does not apply if the disk(s) or other media has been used in other than a Panasonic product, or in environmental conditions other than those specified by PCI or the manufacturer, or if subjected to misuse, neglect, mishandling, modification or attempted modification of the program, or if damaged by accident or act of God. PCI is not responsible for damage to or loss of any program, data or removable storage media.

GENERAL

NO OTHER WARRANTIES – PCI DISCLAIMS ALL OTHER WARRANTIES, EITHER EXPRESS OR IMPLIED, INCLUDING, BUT NOT LIMITED TO, IMPLIED WARRANTIES OF MERCHANTABILITY AND FITNESS FOR A PARTICULAR PURPOSE, WITH RESPECT TO THE SOFTWARE, SOFTWARE MEDIA, COMPUTER PRODUCT, OPTIONS AND ACCESSORIES.

NO LIABILITY FOR CONSEQUENTIAL DAMAGES – IN NO EVENT SHALL PCI BE LIABLE FOR ANY SPECIAL, INDIRECT OR CONSEQUENTIAL DAMAGES ARISING FROM ANY BREACH OF THE LIMITED WARRANTIES SET OUT IN THIS DOCUMENT, OR FROM THE USE OF THE COMPUTER PRODUCT, INCLUDING, WITHOUT LIMITATION, LOSS OF DATA, BUSINESS, PROFIT OR GOODWILL.

IN ANY EVENT, PCI’S MAXIMUM LIABILITY FOR ANY BREACH SHALL NOT EXCEED THE AMOUNT ACTUALLY PAID BY YOU FOR THE COMPUTER PRODUCT.

NO ACTION, REGARDLESS OF ITS BASIS, MAY BE BEGUN AGAINST PCI MORE THAN TWO (2) YEARS AFTER THE CAUSE OF ACTION AROSE.

Statutory Warranties – Some jurisdictions do not allow these limitations or exclusions, so they may not apply to you.



As an ENERGY STAR® Partner, Matsushita Electric Industrial Co., Ltd. has determined that this product meets the ENERGY STAR® guidelines for energy efficiency.

Outline of the International ENERGY STAR® Office Equipment Program

The international ENERGY STAR® Office Equipment Program is an international program that promotes energy saving through the use of computers and other office equipment. The program backs the development and dissemination of products with functions that effectively reduce energy consumption. It is an open system in which business proprietors can participate voluntarily. The targeted products are office equipment such as computers, displays, printers, facsimiles, and copiers. Their standards and logos are uniform among participating nations.

22-E-1

Panasonic Computer Solutions Company
3 Panasonic Way, Panazip 2F-5,
Secaucus, NJ 07094

Panasonic Canada Inc.
5770 Ambler Drive Mississauga,
Ontario L4W 2T3

