

Panasonic®

Reference Manual

Personal Computer

Model No. **CF-19 Series**





We recommend that this Reference Manual be printed.

NOTE

- Do not repeatedly press the keys in quick succession.
- Do not use the key combinations together with touch pad (external mouse), touchscreen (only for model with touchscreen), digitizer (only for model with digitizer), tablet buttons, or other key operations.
- Do not use the key combinations before you log on to Windows. Wait until the hard disk drive indicator  turns off. On the Setup Utility screen, you can use the key combinations of **Fn+F1**, **Fn+F2** and **Fn+F3**.
- The key combinations may not work with some applications.
- The popup menu icon appears after logging on to Windows. It may not appear in some application conditions (e.g., when [Command Prompt] is set to “Full Screen”).

Key	Function	Popup menu icon
Fn+F1 Fn+F2	LCD brightness (Fn+F1 = down / Fn+F2 = up)	
Fn+F3	Display switching (→ page 45) (When an external display is connected) Internal LCD → Simultaneous display → External display ↑ CAUTION <ul style="list-style-type: none"> ● Do not press any keys until the display has finished switching. ● Do not use this function: <ul style="list-style-type: none"> • When an external display is not connected. • When playing motion video such as DVD or MPEG. • When using the Extended Desktop. • When showing a game screen such as pinball. ● Until Windows startup is completed (during Setup Utility, etc.), the simultaneous display cannot be used and pressing Fn+F3 switches the display between the internal LCD and the external display. 	—

Key	Function	Popup menu icon
<u>Fn</u>+<u>F4</u>	<p>Speaker on/off</p> <p>NOTE</p> <ul style="list-style-type: none"> • Beeps do not sound if you turn off the speaker sound. 	  OFF (MUTE) ON
<u>Fn</u>+<u>F5</u> <u>Fn</u>+<u>F6</u>	<p>Volume</p> <p>(<u>Fn</u>+<u>F5</u>= down / <u>Fn</u>+<u>F6</u>= up)</p>	
<u>Fn</u>+<u>F7</u>	Activate standby (→ page 15)	—
<u>Fn</u>+<u>F9</u>	Remaining battery level	(→ page 23)
<u>Fn</u>+<u>F10</u>	Activate hibernation (→ page 15)	—

Hotkey Settings

You can make two settings:

- **Fn key lock**
Fn is locked (pressed-down) until you press another key. Use this when pressing difficult key combinations.
- **Popup menu icon on/off**

1 Start up the Hotkey Settings.

Click [start] - [All Programs] - [Panasonic] - [Hotkey Settings].

2 Make the settings.



[Use Fn key lock]

- When using an **Fn** key combination
 - ① Press **Fn** once. (Locked)
 - ② Press another key. (Lock released)
- When using successive **Fn** key combinations
 - ① Press **Fn** twice. (Locked)
 - ② Press another key.
Fn key remains locked until you press **Fn** again.

[Notification]

[Make sounds when Fn key is pressed]^{*1}

[Show status on screen]: Displays the Fn key status on the notification area.

- : **Fn** is locked.
- : **Fn** is not locked.

[Disable popup]





The popup menu icon will not be displayed.

3 Click [OK].

NOTE

- You can have different settings for each user.

^{*1} If the speakers are muted, beeps do not sound.

Button	Function
	<p>LCD Brightness ▼: down / ▲: up</p>
	<p>Input Panel <Only for model with Windows XP Professional> Software keyboard on/off (→ page 9)</p> <p><Only for model with Windows XP Tablet PC Edition> Tablet PC Input Panel on/off</p> <ul style="list-style-type: none"> ● This button does not work on the Welcome screen.
	<p>Enter Works as <u>Enter</u>.</p>
	<p>Rotation Rotates the display. (→ page 12)</p> <ul style="list-style-type: none"> ● Do not press the button again until the display rotation is completed.
	<p>Security <Only for model with Windows XP Professional> Locks the computer.</p> <ul style="list-style-type: none"> ● On the Windows logon screen and the Welcome screen, this button work as <u>Ctrl</u> + <u>Alt</u> + <u>Del</u>. ● This button does not work on screensaver. <p><Only for model with Windows XP Tablet PC Edition> Works as <u>Ctrl</u> + <u>Alt</u> + <u>Del</u>.</p>

NOTE

- The Tablet buttons work when the Windows screen is displayed.
 - The Tablet buttons may not work immediately after Windows is started up or the Windows logon screen (or the Welcome screen) is displayed.
- <Only for model with Windows XP Professional>
- If you set password input for resuming from screensaver, the Input Panel, Enter and Rotation buttons do not work on screensaver.

Setting the Tablet Buttons

NOTE

- You can have different settings for each user.
- On the Windows logon screen and Welcome screen, the tablet buttons are enabled and work in default irrespective of the settings you made.

■ To change the tablet button functions

You can change the functions of the Input Panel () / Enter () / Rotation () buttons.

1 Open the setting screen.

<Only for model with Windows XP Professional>

Click [start] - [All Programs] - [Panasonic] - [Tablet Buttons Settings].

<Only for model with Windows XP Tablet PC Edition>

Click [start] - [Control Panel] - [Printers and Other Hardware] - [Tablet and Pen Settings] - [Tablet Buttons].

2 Click the tablet button and click [Change].

3 Select the function in [Action].

- You cannot select **Fn** for [Press a key or key combination].
- Click [Browse] to select the application if you select [Launch an application].

4 Click [OK].

5 Click [OK].

<Only for model with Windows XP Professional>

■ To disable the tablet buttons

You can disable the Security () / Input Panel () / Enter () / Rotation () buttons.

1 Click [start] - [All Programs] - [Panasonic] - [Tablet Buttons Settings].





2 Remove the check mark from [Enable Security, Input Panel, Enter, Rotation Button.]

3 Click [OK].

<Only for model with touchscreen>

You can use the touchscreen function to perform the same operation as the touch pad and mouse. Touch the screen surface with the stylus (included).

● To right-click

- ① Click  on the notification area.
 changes to .
- ② Click the object you want to right-click.
 returns to .

NOTE

- Do not touch the screen by hand or other object when you input using the stylus (included). Otherwise you may not be able to input correctly.
- You need to make the following setting for each user.
 - ① Click [start] - [All Programs] - [Fujitsu Touch Panel (USB)] - [Touch Panel Configuration].
 - ② Select the settings, and then click [OK].
 - Do not add a check mark to [Delete Cursor] since the display may be distorted.
- If you add a check mark for [Use] in [Hold [Ctrl] key down + Touch the screen] of [Touch Panel Configuration], touching the screen may always be recognized as a right-click. To return to the normal operation, press **Ctrl** on the keyboard.
- The touchscreen function does not work in the Setup Utility, in the full screen of [Command Prompt], or in Recover Pro (→ page 77).

Touchscreen Calibration

- 1 Run [Touch Screen Calibration Utility].**
Click [start] - [All programs] - [Fujitsu Touch Panel (USB)] - [Touch Screen Calibration Utility].
- 2 Using the stylus, touch each of the 12 “+” target marks one by one until it blinks, and then press Enter.**
- 3 Press Enter.**

NOTE

- Return the rotated display to [0 degree] (→ page 12) before the touchscreen calibration.
- Perform the touchscreen calibration for each user.

<Only for model with digitizer>

You can use the digitizer function to perform the same operation as the touch pad and mouse. Touch the screen surface with the pen (included).

For further information, click [start] - [All Programs] - [Get Going with Tablet PC].

● To right-click

- ① Press and hold the button (A) of the pen, and then tap the object.

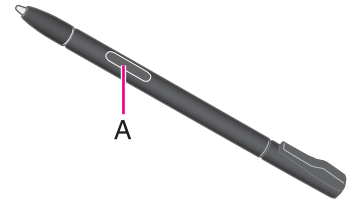

NOTE

- The digitizer function does not work in the Setup Utility, in the full screen of [Command Prompt], or in Recover Pro (→ [page 77](#)).

Digitizer Calibration

1 Run [Tablet and Pen Settings].

Double-click  or click [start] - [Control Panel] - [Printers and Other Hardware] - [Tablet and Pen Settings].

2 Click [Settings] - [Calibrate].

3 Using the pen, touch each of the four “+” target marks one by one, and then click [OK].

- Perform the calibration for both [Landscape] and [Portrait].

NOTE

- Perform the digitizer calibration for each user.

<Only for model with Windows XP Professional>

You can touch the screen keyboard using the stylus (included) to perform the same operation as the internal keyboard.

Starting the Software Keyboard



1 Press the Input Panel button (A).

- Alternatively you can click [start] - [All Programs] - [Panasonic] - [Software Keyboard].

2 Touch the software keyboard using the stylus.

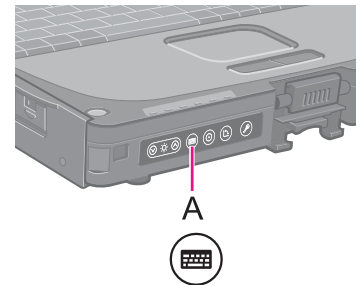
- To use shortcut key
Example: **Ctrl + C**
Press **Ctrl** (turns blue) and then press **C**.
- To select the keyboard language, use the language bar (e.g. **EN**) on the notification area. If the keyboard language does not change, click the title bar of the software keyboard and then click on the application.
- Press the Input Panel button again to close the software keyboard.



- A. Software keyboard menu (→ page 10)
- B. Moves the software keyboard to a corner of the screen.
- C. One tap : Works as shortcut key.
Two taps : Works as the  key.
- D. Works as a right-click. (Same function as the  key)

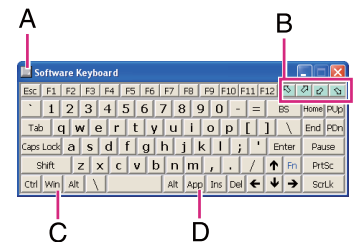

NOTE

- To use key combination (**Ctrl + C** etc.), use either of the internal keyboard or the software keyboard alone.
- You cannot use **Ctrl + Alt + Del** on the software keyboard after logging on.
- You cannot use the **Fn** key combination on the Windows logon screen and the Welcome screen.
- The software keyboard may not work during shutdown of Windows.
- You cannot use the software keyboard when the [Command Prompt] screen is set to “Full Screen”.
- You can set a different language to each application (⇒ Windows help), and the keyboard layout switches according to the application.
- Depending on the language, some keys are displayed in orange. You can use them to input characters such as Ë and Ö.

Software Keyboard Menu

1 Click  (A).

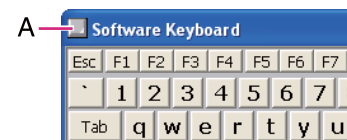

2 Add a check mark to the function you want to use.

- **[Auto Move]**
The software keyboard moves automatically to avoid overlapping the selected window.
- **[Auto Restore]**
The software keyboard minimized on the notification area will be restored when you change the input mode. This may not work on some applications.
- **[Always On Top]**
The software keyboard always appears on the top.
- **[Transparent]**
The software keyboard appears semi-transparent.
- **[Big Size]/[Medium Size]/[Small Size]**
Select the size of the software keyboard.
- **[Ten key (Big)]/[Ten key (Medium)]/[Ten key (Small)]**
Select the size of the numeric keypad.

NOTE

- You can change the currency symbol (B) of the numeric keypad.
Click [start] - [Control Panel] - [Date, Time, Language and Regional Options] - [Regional and Language Options] - [Regional Options] - [Customize] - [Currency] - [Currency symbol].
- After changing the currency symbol, click  (A), and then change the size of the numeric keypad so that the selected currency symbol is shown.

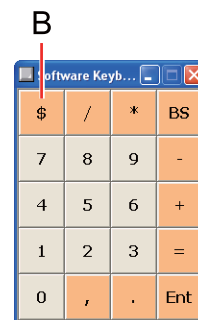

<Only for model with Windows XP Professional>

You can make a bitmap file (.bmp) of a simple character and a figure such as signature by handwriting on the touch pad and the touchscreen.

CAUTION

- Do not use the Fast User Switching function while Panasonic Hand Writing is active.
- If you install other pointing devices (e.g., commercially available mouse driver) and overwrite the touch pad driver, Panasonic Hand Writing will not work.

NOTE

- The display of Panasonic Hand Writing may be distorted if the number of display colors is changed. Right-click  on the notification area and click [Exit Panasonic Hand Writing], and then restart Panasonic Hand Writing.
- Panasonic Hand Writing may not work properly if another application software is active. In this case, close the application software and try handwriting again.

Starting Panasonic Hand Writing

1 Double-click on the notification area.

Alternatively you can click [start] - [All Programs] - [Panasonic] - [Panasonic Hand Writing].

NOTE

- Select the image size before handwriting by clicking [Option] - [Window size]. If you change the size after handwriting, the image quality will become lower.
- You can copy the bitmap image by clicking [Edit] - [Copy], and paste it in another application software that supports bitmap format.
- The touch pad mode will not work properly when using the extended desktop.
- The touch pad mode will not work properly when the display is rotated 90 or 270 degree.
- The touch pad mode will be canceled in the following cases.
 - Switching to another application
 - Resuming from standby or hibernation
 - Pressing **Alt**
 - Touching the touchscreen
- An external mouse or trackball connected via the keyboard/mouse port of the port replicator (optional) or the car mounter (optional) will not work during handwriting in the touch pad mode.

Rotating the Display

1 Press the Rotation button (A).

Each time you press the button, the screen display rotates counter-clockwise by 90°.

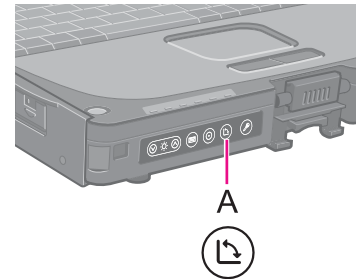

NOTE

- Alternatively you can rotate the display by the following procedure.
<Only for model with Windows XP Professional>
Double-click  on the notification area.
<Only for model with Windows XP Tablet PC Edition>
Click [start] - [Control Panel] - [Printers and Other Hardware] - [Tablet and Pen Settings] - [Display].
- While the display is rotated:
 - Do not use the Extended Desktop. The touch pad, touchscreen (only for model with touchscreen), or digitizer (only for model with digitizer) may not work properly.
 - Do not calibrate the touchscreen (only for model with touchscreen).
 - Do not set the resolution larger than that of the internal LCD.
 - The computer's performance is slightly lowered.
 - The touch pad scroll, zoom, and data zoom functions do not work.
- You cannot rotate the display when the [Command Prompt] is set to "Full Screen".
<Only for model with Windows XP Professional>
 - When the display is rotated, the motion video may not be displayed correctly or the sound may be distorted. Return the display angle to 0°.
 - When you set the resolution to 800 x 600 pixels and rotate the display, the resolution shown in [Screen resolution] of [Display Properties] may not correspond to the correct resolution. This is not a problem.
<Only for model with Windows XP Tablet PC Edition>
 - When the display is rotated, the motion video may not be displayed correctly or the sound may be distorted. Return the display angle to [Primary Landscape].
 - When you set the resolution to 800 x 600 pixels, you can rotate the display to [Primary Landscape] and [Secondary Landscape] only.

Changing the Settings

1 Right-click  on the notification area and click [Setting].

The Display Rotation Tool screen appears.

2 Change the settings.

3 Click [OK].

NOTE

- In the following cases, the display angle automatically returns to the default angle.
 - When starting up Windows
 - When switching the Laptop mode and Tablet mode
 - When switching the logon user by the Fast User Switching function

<Only for model with Windows XP Tablet PC Edition>

- You can set the order of display rotation positions in the following menu.
[start] - [Control Panel] - [Printers and Other Hardware] - [Tablet and Pen Settings] - [Display] - [Change]

The standby or hibernation function allows you to shut off the computer without closing programs and documents. You can quickly return to the programs and documents that you were working on before standby or hibernation.

Function	Data is saved to	Recovery time	Power supply
Standby	Memory	Short	Required. (If power is not supplied, all data will be lost.)
Hibernation	Hard disk	Rather long	Not required. (However power is slightly consumed to keep the hibernation.)

Setting Standby or Hibernation

- 1 Click [start] - [Control Panel] - [Performance and Maintenance] - [Power Options] - [Advanced].
- 2 Click [Stand by] or [Hibernate] for [When I close the lid of my portable computer:] / [When I press the power button on my computer:], and then click [OK].

NOTE

- You do not need to make the setting if you use the Windows menu to enter standby or hibernation.

Precautions

- Connect the AC adaptor if the computer will be in standby mode for a long period of time. If you cannot use the AC adaptor, use hibernation instead.
- Using standby or hibernation repeatedly may cause malfunction of the computer. To stabilize computer operation, restart Windows regularly (about once a week) without using standby or hibernation.
- Save the necessary data.
- Close files you have opened from removable disk and network drive.
- The password you set in the Setup Utility is not requested at resuming. You can use the Windows password for security in standby or hibernation.
 - ① Click [start] - [Control Panel] - [User Accounts], and select the account.
 - ② Click [Create a password] and set the password.
 - ③ Click [start] - [Control Panel] - [Performance and Maintenance] - [Power Options] - [Advanced], and add the check mark in [Prompt for password when computer resumes from standby].

- Do not enter standby or hibernation in the following conditions, otherwise the data or file may be corrupted, standby or hibernation may not work, or malfunction may occur in the computer or the peripheral devices.
 - When the hard disk drive indicator  or the SD Memory Card indicator is on.
 - When playing/recording audio files or displaying motion video such as MPEG files.
 - When writing to a disk.
 - When using communication software or network function.
 - When using a PC Card.
(If the card fails to work normally, restart the computer.)
 - When an external mouse is connected to the serial port.
- The computer does not enter standby or hibernation immediately after resuming. Wait approximately one minute.

Entering/Resuming from Standby or Hibernation

■ To enter standby or hibernation

1 Close the display, or slide the power switch (A) until a beep^{*1} sounds.

Standby: The power indicator (B) blinks green.

Hibernation: The power indicator (B) goes off.

- You can alternatively use the Windows menu to enter standby or hibernation. To enter standby, click [start] - [Turn Off Computer] - [Stand By]. To enter hibernation, click [start] - [Turn Off Computer], then press and hold **Shift** and click [Hibernate].

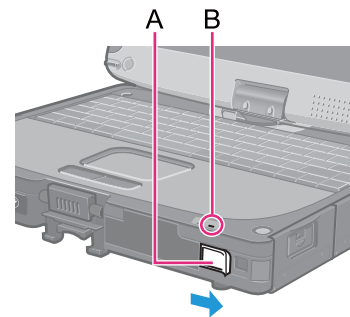

CAUTION

While the computer is entering standby or hibernation

- Do not:
 - Touch the keyboard, touch pad, touchscreen (only for model with touchscreen), digitizer (only for model with digitizer), tablet buttons, or power switch.
 - Use an external mouse or other peripheral device.
 - Connect or disconnect the AC adaptor.
 - Close or open the display.
- Wait until the power indicator blinks green (standby) or goes off (hibernation).
- It may take one or two minutes to enter standby or hibernation.
 - At the beep^{*1}, immediately release the power switch. If you slide and hold the power switch for longer than four seconds, the computer will forcibly shut down and unsaved data will be lost even if you have set [Shut down] in [When I press the power button on my computer:] (→ page 14 “Setting Standby or Hibernation”).

^{*1} If the speakers are muted, beeps do not sound.

In standby or hibernation

- Do not attach or remove a peripheral device. Doing so may cause malfunction.
- Power is consumed in standby mode. Power consumption may increase when a PC Card is inserted. When power is exhausted, the data retained in memory will be lost. Connect the AC adaptor when using the standby function.

■ To resume from standby or hibernation

1 Open the display, or slide the power switch (A).

- When [Stand by] or [Hibernate] is selected as the setting for [When I close the lid of my portable computer] (→ [page 14](#)), you can resume operation opening the display. Note however opening the display does not work in the Tablet mode.

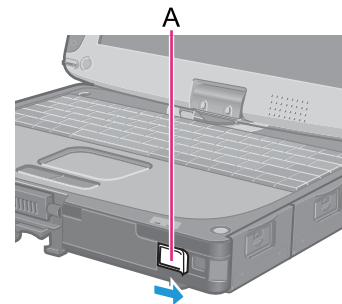

CAUTION

- Do not perform the following operations until resuming is complete. After the display has resumed, wait approximately 30 seconds (normally) or 60 seconds (when the computer is on a network).
 - Touch the keyboard (except for password input), touch pad, touchscreen (only for model with touchscreen), digitizer (only for model with digitizer), tablet buttons, or power switch.
 - Use an external mouse or other peripheral device.
 - Connect or disconnect the AC adaptor.
 - Close or open the display.
 - Shut down or restart Windows.
 - Enter standby or hibernation.

You can extend battery life and save power also during AC adaptor usage.

Reducing Power Consumption

Use the methods below to reduce power consumption.

- **Change [Power Options]**

Click [start] - [Control Panel] - [Performance and Maintenance] - [Power Options] to select [Max Battery] under [Power schemes]. While [Portable/Laptop] is selected under [Power Options] as the factory default, selecting [Max Battery] will further reduce power consumption.

Also, make detailed settings such as reducing the time entered in the [Turn off monitor] setting.

- **Use Power Saving Utility** → [page 18](#)

Power Saving Utility provides additional power saving functions not available in [Power Options].

- **Press **Fn** + **F1** to reduce LCD brightness**

Reducing internal LCD brightness will reduce power consumption.

- **Turn off the computer when it is not in use**

You can also turn off only the wireless LAN or Bluetooth power.

- **Disconnect external devices (USB devices, PC cards, external mice, etc.) that are not being used**

- **Use Standby/Hibernation**

Press **Fn** + **F7** to set the computer to standby or **Fn** + **F10** to set it to hibernation when you have to leave the computer. This shuts down computer operation to reduce power consumption.

Disable Wake Up from wired LAN and Wake Up from wireless LAN functions when they are not needed. This reduces power consumption in Standby/Hibernation.

To confirm current settings, click [start] - [All Programs] - [Panasonic] - [Power Saving Utility] to view [Wired LAN standby power saving function] or [Wireless LAN standby power saving function].

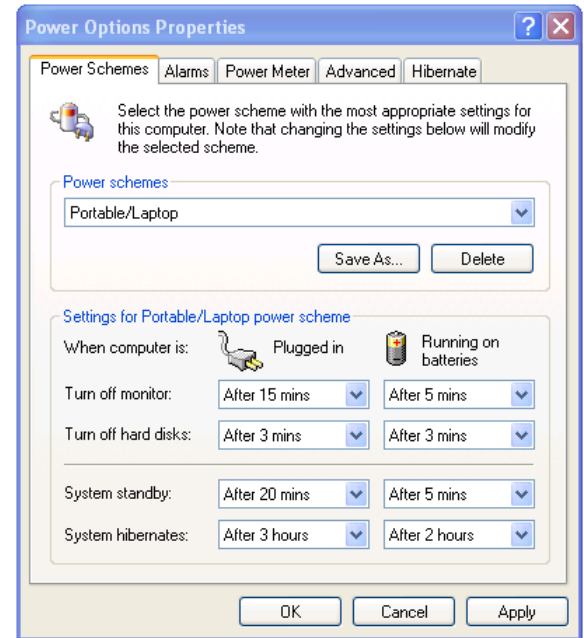

Using Power Saving Utility

A single setting allows you to enable all the following power saving features. Enable each of these functions to prolong battery operation time.

- **Intel video driver power saving function (Intel(R) Display Power Saving Technology)**
This function adjusts video contrast, color and other factors to lower internal LCD power consumption while retaining adequate image quality.
Disable this function for work that requires subtle image and color nuances or in video editing using video editing applications.
- **Wired LAN standby power saving function**
Enabling this function disables the Wake Up from wired LAN function to save power in standby/hibernation.
Disable this function if you want to use the Wake Up from wired LAN function.
- **Wireless LAN standby power saving function**
Enabling this function disables the Wake Up from wireless LAN function to save power in standby/hibernation.
Disable this function if you want to use the Wake Up from wireless LAN function.

■ Setup

- 1 Click [start] - [All Programs] - [Panasonic] - [Power Saving Utility].
- 2 Click [Enable] for each function.

Click [OK] in the confirmation screen that appears.

- **To enable “Intel video driver power saving function”**
Select [Enable], and slide the slide bar to the “Maximum Battery” end.

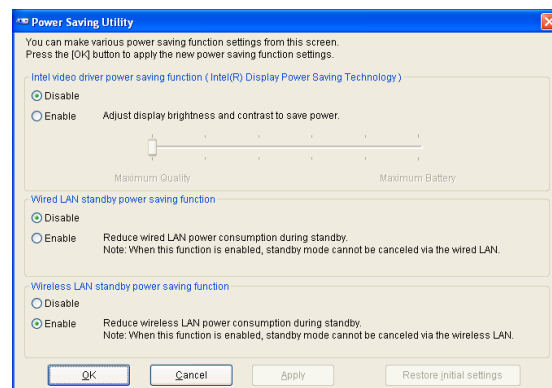

3 Click [OK].

Click [Restore initial settings] to return to the factory default settings, and click [OK].

NOTE

- You can also enable the Intel video driver power saving function as follows.
 - ① Click [start] - [Control Panel] and click [Other Control Panel Options] under [See Also] on the left side of the screen and select [Intel(R) GMA Driver for Mobile].
 - ② Click [Notebook], [Apply] and [OK].
 - ③ Click [Display Settings].
 - ④ Click [Power Settings].
 - ⑤ Click [Intel(R) Display Power Saving Technology] to add a check mark.
 - ⑥ Move the slide bar to [Maximum Battery] and click [OK].
 - ⑦ Click [OK].

There is no need to reboot the computer.
- For how to enable/disable the Wake Up from wired LAN function → [page 51](#)
For how to enable/disable the Wake Up from wireless LAN function → [page 61](#)

Use these features to protect your data.

- Other security measures
 - SD Security (→ [page 34](#))
 - Embedded Security (TPM) (→ [page 70](#)): For further information, refer to the *Installation Manual* of “Trusted Platform Module (TPM)”.

Setting the Supervisor Password/User Password

Set the Supervisor Password before setting the User Password.

- 1 Start up the Setup Utility (→ [page 65](#)).**
- 2 Select [Security].**
- 3 Select [Set Supervisor Password] or [Set User Password], and press Enter.**
- 4 Enter your password in [Enter New Password] and press Enter.**
 - When the password has been set, you need to enter your password in [Enter Current Password] and press Enter.
 - To disable the password, leave the input field empty and press Enter.
- 5 Enter your password again in [Confirm New Password] and press Enter.**
- 6 In [Setup Notice], press Enter.**
- 7 Press F10, and then select [Yes] and press Enter.**

CAUTION

- Do not forget your password. If you forget your Supervisor Password, you will not be able to use your computer. Contact Panasonic Technical Support.
- When running the Setup Utility, do not leave and go away from your computer even for a short time, since other people may set or change the password.

NOTE

- The password will not be displayed on the screen.
- You can use up to 32 alphanumeric characters (including spaces).
 - The case (upper/lower) is ignored.
 - To input numbers for the password, you cannot use the numbered keys on the keyboard.
 - You cannot use Shift and Ctrl to input a password.
- Disabling the Supervisor Password also disables the User Password.

Preventing Your Computer from Unauthorized Use

You can set a start-up password to protect your computer from unauthorized use.

- 1 Set the password (→ [page 20](#)), and select [Enable] in [Password on boot] in the [Security] menu of the Setup Utility (→ [page 70](#)).

NOTE

- If the Supervisor Password or User Password has been set, the password input screen will be displayed on starting-up of the Setup Utility even though [Password on boot] is set to [Disable].

Preventing Your Hard Disk Data from Being Read or Written

The hard disk lock function protects the hard disk data from being read or written when the hard disk is attached to another computer. The data can be read/written when the hard disk is returned to the original computer. (Note that the hard disk lock does not guarantee complete protection of the data.)

- 1 Select [Enable] in [Hard Disk Lock] in the [Security] menu of the Setup Utility (→ [page 70](#)).

CAUTION

- For the data being read/written on the original computer, the Setup Utility settings must be the same as when the hard disk was removed.
- You cannot use the hard disk lock function without setting the Supervisor Password. Set the Supervisor Password beforehand (→ [page 20](#)).
- When you have your hard disk drive repaired
 - Contact Panasonic Technical Support.
 - Before sending back the hard disk drive, be sure to set the [Hard Disk Lock] to [Disable].

NOTE

- The hard disk lock function works with the built-in hard disk. It does not work with the external hard disk.
- We recommend you to set [Password on boot] to [Enable] to ensure security though it is not required to enable the hard disk lock.

Battery Indicator

Battery indicator	Battery status
Not lit	The battery pack is not inserted or not being charged.
Orange	Charging is in progress.
Green	The battery is fully-charged.
Blinking green	In high temperature mode, the battery pack is discharging the power to 80% ^{*1} of normal temperature mode (→ page 24). Do not remove the battery pack in this status.
Red	The remaining battery is approximately 9% or less.
Blinking red	The battery pack or the charging circuit is not operating properly.
Blinking orange	The battery cannot be charged temporarily due to the following reasons: <ul style="list-style-type: none">• Its internal temperature is out of the acceptable range.• The power supply is not enough because software applications or peripheral devices are consuming a large amount of power.
Blinking green and orange alternately	The temperature is low and the computer is warming up to prevent the hard disk drive from malfunctioning. The computer will start automatically after warming-up.

^{*1} In high temperature mode, the 100% battery level is equivalent to 80% level of the normal temperature mode.

NOTE

- Once the battery is fully charged, the computer performs recharging only when the battery level becomes less than approximately 95%, so overcharging is avoided.

Checking the Remaining Battery Charge

You can check the remaining battery charge on the screen.

(After logging on to Windows)

1 Press **Fⁿ+F⁹**.

- When the battery pack is inserted (example)



: Normal temperature mode (→ [page 24](#))



: High temperature mode (→ [page 24](#))

- When the battery pack is not inserted



NOTE

- The battery display may not correspond to the actual remaining battery charge in the cases as below. To correct the display, perform the Battery Recalibration (→ [page 26](#)).
 - The battery indicator remains red.
 - The indicator lights orange and the display shows 99% for a long time.
 - Low battery warning appears soon after a short time of use.
This can occur when the computer is in standby mode for a long time without power supply from the AC adaptor.
- The battery display may not be the same as that of notification area or of [Power Meter] in [Power Options Properties]. This is not a malfunction.

High temperature mode

The high temperature mode can prevent the battery from deteriorating when the computer is used in high-temperature environment or used for a long time with its battery fully charged.

Select [Auto] (default) or [High Temperature] in [Environment] of the [Main] menu of the Setup Utility (→ [page 67](#)).

NOTE

- Note that a level corresponding to a 100% charge for high temperature mode is approximately equivalent to an 80% charge level for normal temperature mode.
 - After switching from [Normal Temperature] to [High Temperature] or vice versa, the remaining battery capacity will not be displayed correctly until the battery pack is completely discharged or fully charged.
 - In the [Auto] mode:
Once the computer has automatically switched from the normal temperature mode to the high temperature mode, the computer will not switch back to the normal temperature mode until the battery has been used and recharged to a total charge level of about five times as much as that of the fully-charged state. This is to avoid battery deterioration.
-

Computer behavior with low battery

The default settings are as follows.

When the battery level becomes 10% [Low battery alarm]	When the battery level becomes 5% [Critical battery alarm]
<ul style="list-style-type: none">● Displays a message that the battery level is low. <p style="text-align: center;">↓</p>	<ul style="list-style-type: none">● Displays a message that the battery level is low, and then the computer enters hibernation. <p style="text-align: center;">↓</p>
Charge the battery.	Connect the AC adaptor or replace the battery to start up the computer.
<ul style="list-style-type: none">● Connect the AC adaptor immediately. If you do not have the AC adaptor, exit the running programs and Windows, then confirm that the power indicator is off.● If you have a fully charged spare battery, turn off the computer, replace the battery and turn the computer on again.	<ul style="list-style-type: none">● Connect the AC adaptor and charge the battery.● If you have a fully charged spare battery, replace the battery and turn the computer on again. <p>When the computer enters hibernation with the battery down and you resume the operation without charging the battery, Windows may not start up normally or the alarm function may not operate normally from then on.</p>
Do not replace the battery pack when the computer is in standby mode.	

Correcting the Battery Display (Battery Recalibration)

The “Battery Recalibration” function measures and memorizes the battery capacity. To correct the battery display, use this function to fill the battery and then discharge it completely. Perform the procedure at least once immediately after purchasing the computer. Normally the interval of battery recalibration is three months. The battery display may not be correct when the battery pack deteriorates after a long time use. In this case, perform the procedure again.

1 Connect the AC adaptor.

2 Close all the applications.

3 Perform “Battery Recalibration”.

① Click [start] - [All Programs] - [Panasonic] - [Battery] - [Battery Recalibration].

② When the confirmation message appears, click [Start].

- Frequent recalibration of the battery can degrade the battery. A caution message appears when the battery recalibration is performed at the shorter interval than approximately a month. In this case, cancel the battery recalibration.

③ When the message requests shut down of Windows, click [Yes].

The battery recalibration starts.

After the battery pack is fully charged, discharging starts. When the discharging is completed, the power goes off automatically.

After the battery recalibration is finished, normal charging starts.

NOTE

- The temperature range should be 10°C to 30°C {50°F to 86°F}.
- The battery recalibration may take a long time due to the large battery capacity. This is not a malfunction.
 - Full charge: Approximately 4.5 hours [max.]
 - Complete discharge: Approximately 4.5 hours
- If the computer is turned off during the battery recalibration (e.g., due to power failure, or accidental removal of the AC adaptor and battery pack), the battery recalibration will not be completed.
- You can also perform the battery recalibration with the following procedure.
 - ① Restart the computer.
 - ② Press **F9** while the [Panasonic] boot screen is displayed just after the computer starts the startup procedure.
 - ③ When the remaining battery capacity is displayed, press **Enter**.
 - ④ Follow the on-screen instructions.

Replacing the Battery Pack

The battery pack is a consumable item so the replacement will be necessary. If the battery operation time becomes noticeably short and not recovered even after recalibrating the battery, replace with a new battery.

CAUTION

- The battery pack is not charged when you first purchase it. Be sure to charge it before using for the first time. Charging starts automatically when the AC adaptor is connected to the computer.
- Use only the specified battery pack with your computer.
- In the standby mode, do not remove/replace the battery pack. Otherwise your data will be lost and the computer may be damaged.

1 Turn off the computer.

- Do not use the standby function.

2 Remove/Insert the battery pack.

- To remove
 - ① Slide the latch (A) to the right to unlock the cover.
 - ② Slide the latch (A) down, and open the cover.

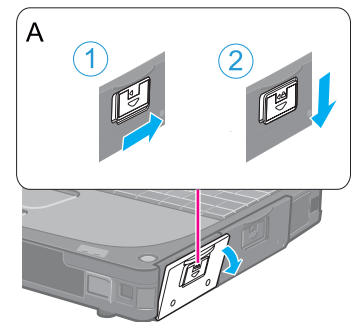

- ③ Pull the tab (B) of the battery pack.

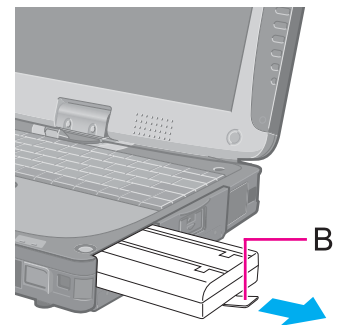

- To insert
- ① Insert the battery pack until it securely fits the connector.

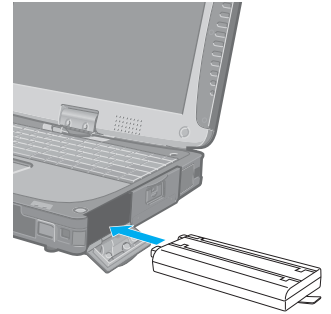

- ② Close the cover until it clicks.
- ③ Slide the latch (C) to the left to lock the cover.

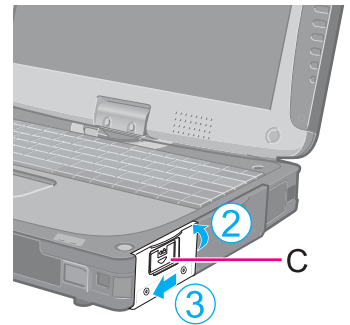

CAUTION

- Make sure the latch is securely locked, otherwise the battery pack may fall when you carry the computer.

You can insert the following cards.

- ExpressCard/34 or ExpressCard/54 to the ExpressCard slot (A)
- PC Card Type I (3.3 mm) or II (5.0 mm) to the PC Card slot (B)



NOTE

- The following types of card are not supported:
PC Card Type III (10.5 mm), ZV card, SRAM card, FLASH ROM card (excluding ATA interface type), and other cards that require 12 V of operating voltage.
- Dummy cards are inserted into both of the slots at the factory.
First remove the dummy cards. (→ [page 39 Step 1](#))
- Be sure to insert each dummy card when the slots are not in use.
- Insert the appropriate dummy card in the correct card slot. Insert the dummy PC Card in the PC Card slot, and the dummy ExpressCard in the ExpressCard slot.
Inserting a dummy card in the wrong slot may cause malfunction of the computer.

Inserting/Removing the Card

■ To insert the card

1 Open the cover.

- ① Slide the latch (C) to the right to unlock the cover.
- ② Slide the latch (C) down, and open the cover.

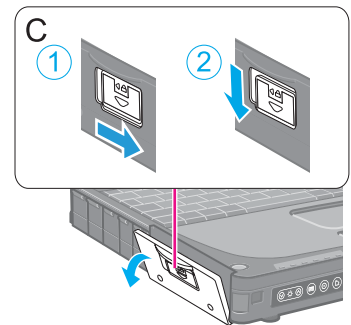

2 Insert the ExpressCard (upper slot) (D) or the PC Card (lower slot) (E) with the label side up until it securely fits in to the slot.

- For further information, refer to the instruction manual of the card.

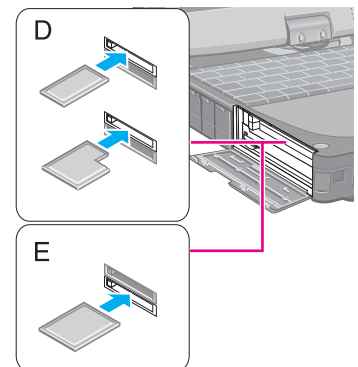

NOTE

<Only for model with Smart Card slot>

- The upper slot (D) is the PC Card slot, and the lower slot (E) is the Smart Card slot. Express Cards cannot be used. For how to insert/remove a Smart Card: → [page 38](#)

■ To remove the card

1 Disable the card function.

- ① Double-click  on the notification area and select the card, then click [Stop].
- ② Follow the on-screen instructions.
 - This step is not necessary when removing the card after turning off the computer.

2 Open the cover and remove the card.

- ① Press the eject button (F). The eject button pops out.
- ② Press the eject button (F) again so the card comes out of the slot.
- ③ Draw the card straight out.

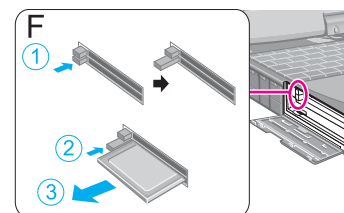

NOTE

- Check the card's specification to prevent the total operating current from exceeding the allowable limit. Otherwise malfunction may occur.
Permissible Current: 3.3 V: 400 mA, 5 V: 400 mA
- Some types of cards cannot be used simultaneously.
- After repeating insertion and removal, some types of card will not be recognized. In this case, restart the computer.
- If the computer freezes after resuming from standby or hibernation, remove and reinsert the card. If the problem persists, restart the computer.
- When a card is inserted, power consumption increases. Remove the card when it is not in use, especially when operating by battery power.
- To connect peripheral devices (SCSI, IEEE 1394, etc.) using a PC Card or an ExpressCard, follow the steps below (one example).
 - ① Connect the peripheral device to the card.
 - ② Turn on the power of device.
 - ③ Insert the card until it surely fits in the slot.

SD Memory Card Information

- The SD Memory Card has a copyright protection function which is compatible with content on-demand services on the Internet, etc.
- To format the SD Memory Card on this computer, do not use [Format] of Windows, but use the SD Memory Card format software.
You can download the software from the web site below.
http://panasonic.co.jp/pavc/global/cs/sd/download/sd_formatter.html
- To use the SD Memory Card on other devices, format the card on those devices. For further information, refer to the instruction manual of the devices.
- This computer supports SDHC Memory Cards (SD Memory Cards with a capacity of 2 GB or more).

Handling and storage cautions

- Store the SD Memory Card in the case after removing it from the computer.
- Do not:
 - Disassemble or modify the card.
 - Hit, bend, or drop the card.
 - Touch the terminals with fingers or metal object.
 - Remove the labels of the card / Attach other labels or stickers to the card.
- Do not place the card in the following locations.
 - In direct sunlight or in very hot location such as inside of a car.
 - In very dusty or humid location.
 - In location subject to corrosive gas, etc.

Data handling cautions

- Set the write-protect switch (A) to the LOCK position. Unlock the switch when recording (checkout), saving, or editing data.
- We recommend you to back up the important data to another storage medium.
- When disposing the card, we recommend you to physically destroy the card (using a hammer, etc.) to prevent personal or confidential data leakage.

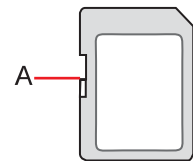

Inserting/Removing the SD Memory Card

CAUTION

- Do not remove or insert the SD Memory Card until Windows has completed loading.
- Do not remove the card or turn off the computer in the following cases, otherwise the data may be corrupted.
 - While the computer is in standby or hibernation.
 - Immediately after the writing operation.The computer may still continue the access to the card just after writing operation. If you remove the card before the operation is completed, the data may be damaged or the card access may no longer be performed normally.
- Note that Panasonic assumes absolutely no liability for any loss of data recorded by the user, or any other damages, direct or indirect.
- Do not forcibly draw out the card, otherwise the slot may be damaged.
- Insert the card in the correct direction, otherwise the card and the slot may be damaged.
- After resuming from standby or hibernation, do not access the SD Memory Card for approximately 30 seconds.

■ To insert the card

1 Open the cover.

- ① Slide the latch (A) to the right to unlock the cover.
- ② Slide the latch (A) down, and open the cover.

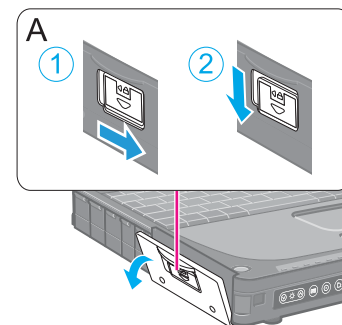

2 Insert the SD Memory Card with the label side facing up and with the cut corner facing in.

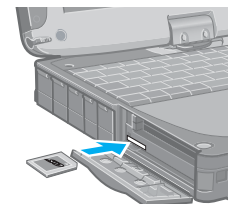

■ To remove the card

Preparation

- Save the data and close all applications.
- Open the cover and confirm the SD Memory Card indicator (B) is off.

1 Disable the card function.

- ① Double-click  on the notification area and click [Secure Digital Storage Device], then click [Stop].
- ② Follow the on-screen instructions.
 - This step is not necessary when removing the card after turning off the computer.

2 Remove the card.

- ① Press the card so it comes out of the slot.
- ② Draw it straight out.

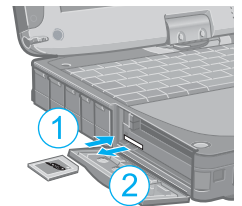
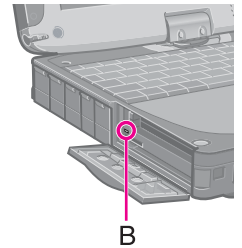

Inserting a specific SD Memory Card can work as an alternative to entering password in the cases below. Format the card and make the necessary settings.

- Starting up the computer
- Logging on to Windows
- Resuming the computer from standby, hibernation or screensaver

NOTE

- If you are unable to use the SD Memory Card, you can enter the Supervisor or User Password to start up the computer, then log on to Windows using your logon password.
- Use the formatted SD Memory Card (→ [page 31](#)).
- This function works only with the SD Memory Card slot. It does not work with other devices such as the SD card reader/writer connected through USB port.
- You cannot use SDHC Memory Cards (SD Memory Cards with capacities exceeding 2 GB or more) for this function. If an SD Memory Card with a capacity over 2 GB is inserted for this function, an error message will be displayed.
- You can use the setup SD Memory Card as an ordinary card on the computer and other devices.
- You can use a single setup SD Memory Card for multiple computers. However, when using the card to log on to Windows, you need to use the same logon user name and the same password on all of the computers.

SD Card Setup

Preparation

- To start up the computer
Set the Supervisor Password in the Setup Utility (→ [page 20](#)). (You can also set it during the configuration procedure.)
- To use the card to log on to Windows or to resume from standby, hibernation or screensaver
Set the Windows logon user account and the password in [Control Panel] in advance. For further information, refer to the Windows Help.

- 1 Log on to Windows as an administrator.**
- 2 Insert the SD Memory Card in the SD Memory Card slot.**
If [Secure Digital storage device] appears, click [Take no action], then click [OK].
- 3 Start the SD Card Setup program.**
Click [start] - [All Programs] - [Panasonic] - [SD Card Setup].
- 4 Click [Next] in the Welcome screen.**

5 Select the trigger operation (A).

[Leave set]

Insert and leave the card in the slot.
(You can remove the card afterward.)

[Set and eject]

Insert the card and eject.

When logging on to Windows or resuming from standby, hibernation or screen-saver, eject the card after the beep sounds to indicate card recognition. If the speakers are muted, beeps do not sound.

- Make the setting on each computer. You cannot use different settings on the same computer even with different SD Memory Cards.
- To select different settings for starting the computer and logging on to Windows:
In this screen, set the trigger operation to log on to Windows. After completing the SD Card Setup, start the Setup Utility and select the setting to start up the computer in [SD Setting Method] of the [Security] menu (→ page 70).

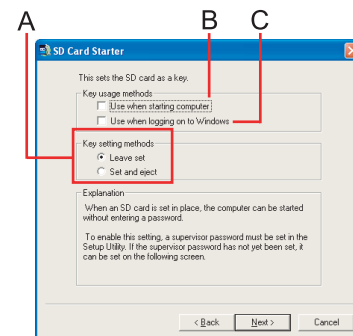

6 Make the necessary settings.

To start up the computer

The SD Memory Cards will be registered to the computer.

- You can register up to two cards (To set up the second SD Memory Card: → page 36).
- ① Add the check mark for [Use when starting computer] (B) and click [Next].
- ② Click [Restart the computer after entering settings] and click [Finish].
- ③ Enter the Supervisor Password and click [OK].
- If the Supervisor Password is not set, follow the on-screen instructions to set the Supervisor Password.
- You can use up to 32 alphanumeric characters (including spaces).
 - The case (upper/lower) is ignored.
 - To input numbers for the password, use the numbered keys on the keyboard.
 - You cannot use **Shift** and **Ctrl** to input a password.

To use the card to log on to Windows

The Windows logon user name and the password set in [Control Panel] are registered in the SD Memory Card.

- ① Add the check mark for [Use when logging on to Windows] (C) and click [Next].
- ② Click [Restart the computer after entering settings] and click [Finish].
- ③ Enter the Windows logon user name and the password.

- After making this setting, the following functions will be disabled.
 - Displaying the Welcome screen
 - The Fast User Switching function
 - Remote desktop connection
- When you add the check mark for [Do not check the user name], you can register the user name that is different from the Windows user name. Click [Yes] at the confirmation message. When restarting the computer and logging on to Windows, you will need to enter the Windows user name and the password without using the SD Memory Card.
- A [PRIVATE] folder will be created in the SD Memory Card, and the encrypted Windows logon user name and the password will be registered.
Do not delete [PRIVATE] folder. Doing so will cancel [Use when logging on to Windows].

To use both when starting the computer and when logging on to Windows

Add the check mark to both [Use when starting computer] and [Use when logging on to Windows], and follow the above steps.

CAUTION

- Do not lose the setup card.
- Do not leave the setup card in the slot when you go away from the computer.

■ To change the settings / To set up the second SD Memory Card

- ① Start the SD Card Setup program (→ page 34 Step 1-3).
The screen is different from the initial setup screen.
- ② Change the settings.
[Setting for this computer]
You can change the settings registered in this computer.
[Setting for this SD card]
You can change the settings of the inserted SD Memory Card.
- ③ Click [OK].
- ④ Make the necessary settings.
 - Refer to the initial setup procedure above.
 - You may need to enter the password to proceed the steps.
- ⑤ Restart the computer.

■ To disable the setup card

If you have lost the setup card, disable the card to avoid unauthorized startup or logon.

When using the card to start up the computer

- ① Start the SD Card Setup program. (→ [page 34 Step 1-3](#))
The current settings will be displayed.
- ② Remove the check mark from [Use the SD card when starting the computer].
- ③ Click [OK], and then follow the on-screen instructions.
All SD Memory Cards currently registered on this computer will no longer be usable to start up the computer.
 - Even if you add the check mark again for [Use the SD card when starting the computer], the card will not be usable to start up.

When using the card to log on to Windows

- ① Change the Windows logon password.
The card will no longer be usable to log on to Windows.

<Only for the model with Smart Card slot>

You need software to use a Smart Card.

You can insert the following cards.

- PC Card Type I (3.3 mm) or II (5.0 mm) to the PC Card slot (A)
- Smart Card to the Smart Card slot (B)



CAUTION

- Do not:
 - Hit, bend, or drop the card.
 - Touch the contact part with fingers or metal object.
 - Place the card in very hot location for a long time.
 - Remove the card immediately after inserting it.

Inserting/Removing the Smart Card

■ To insert the card

1 Open the cover.

- ① Slide the latch (A) to the right to unlock the cover.
- ② Slide the latch (A) down, and open the cover.

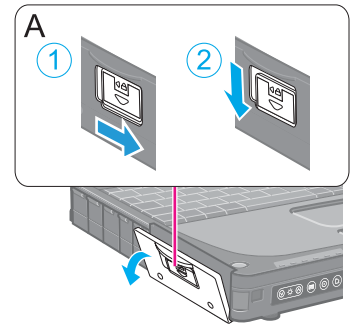

2 Inset the Smart Card to the lower slot (B) with the contact part (C) in front.

- Insert the card until it securely fits into the slot.

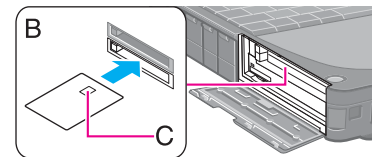

■ To remove the card

- 1 Open the cover and draw the card straight out.

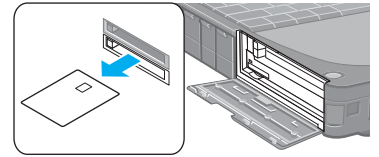

Use RAM modules that comply with the specifications below. Using any other module may cause malfunction or result in computer failure.

RAM module specifications:

200 pins, SO-DIMM, 1.8 V, DDR2 SDRAM, PC2-4200

(For information of RAM module compatibility, contact Panasonic Technical Support.)

CAUTION

- RAM modules are extremely sensitive to static electricity and can be affected even by static electricity from the human body. When inserting and removing RAM modules, do not touch the terminals or internal components, and do not allow foreign particles to enter the slots. Doing so may cause damage, fire, or electric shock.

Inserting/Removing the RAM Module

- 1 Turn off the computer.**
 - Do not use standby or hibernation.
- 2 Disconnect the AC adaptor and remove the battery pack (→ [page 27](#)).**
- 3 Remove the screws (A) and the cover (B) on the bottom of the computer.**

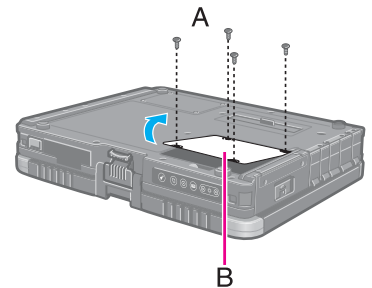

4 Insert/Remove the RAM module.

- To insert
 - ① Tilt the module slightly and insert it in the slot.
 - ② Press down the module so that the right and left hooks (C) are locked.

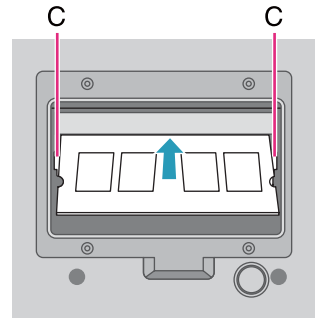

- To remove
 - ① Carefully open the right and left hooks (C). The module will rise.
 - ② Carefully remove the module from the slot.

5 Set the cover and battery pack.

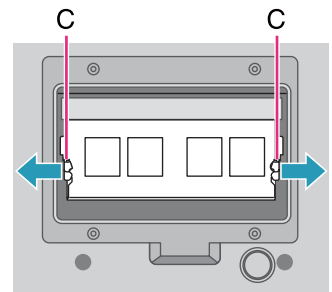

NOTE

- If it is hard to insert or to press down the RAM module, do not try forcibly but check the module's direction.
 - Use the appropriate screw driver so as not to strip the head of screw.
 - If the RAM module is recognized correctly, the total size of the RAM module memory is displayed on the [Information] menu of the Setup Utility (→ [page 66](#)).
- If the RAM module is not recognized, power off the computer and insert it again.

You can use an optional port replicator and a car mounter. These devices free you from being bothered by a lot of cable connections when you carry the computer. They also allow you to connect various peripherals.

Connect the port replicator or the car mounter to the expansion bus connector (A) on the bottom side of the computer.

For further information, refer to the instruction manual of the port replicator or the car mounter.

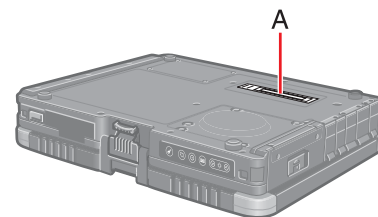

CAUTION

- The driver of the port replicator or the car mounter is preinstalled in the computer. Do not install the driver using the CD-ROM supplied with the port replicator or the car mounter.
- Make sure the slide cover is completely open.
- Hot or warm docking/undocking is not possible with the port replicator or the car mounter.
- To boot the computer from a USB floppy disk drive or a USB CD/DVD drive, be sure to connect the USB drive to the USB port on the computer, not to the USB port on the port replicator or the car mounter.

Using an External Mouse

When you connect an external mouse or trackball to the external keyboard/mouse port of the port replicator or the car mounter, some functions of the mouse or trackball (e.g. wheel function) will not work. To use the functions, perform the steps below.

After performing the steps below, some of the touch pad functions will not work.

NOTE

- You do not need to perform the following steps when using a USB mouse.

- 1** Click [start] - [Control Panel] - [Performance and Maintenance] - [System] - [Hardware] - [Device Manager].
- 2** Click [Mice and other pointing devices] and double-click [touchpad], and then click [Driver] - [Update Driver].
- 3** Click [No, not this time] and click [Next].
- 4** Click [Install from a list or specific location (Advanced)] and click [Next].
- 5** Click [Don't search. I will choose the driver to install.] and click [Next].

- 6 Click [PS/2 Compatible Mouse] and click [Next].
- 7 At the confirmation message, click [Yes].
- 8 Click [Finish] and click [Close].
- 9 When the message requests restart of Windows, click [Yes].
The computer will restart.

NOTE

- If you cannot use the functions of the external mouse and trackball even after the steps above, perform the steps below.
 - ① Turn off the computer and connect to the port replicator or to the car mounter.
 - ② Connect the external mouse or trackball to the port replicator or to the car mounter.
 - ③ Turn on the computer and start up the Setup Utility (→ [page 65](#)).
 - ④ Select the [Main] menu, and set [Touch Pad] to [Disable].
 - ⑤ Press **F10**, and then select [Yes] and press **Enter**.
 - ⑥ Log on to Windows as an administrator.
 - ⑦ When [Completing the Found New Hardware Wizard] appears, click [Finish].
 - ⑧ When the message requests restart of Windows, click [Yes].
The computer will restart.
 - ⑨ Install the necessary driver following the operating instructions of the connected device.

External Display

You can switch the output destination to an external display.
Connect the external display to the external display port (A).

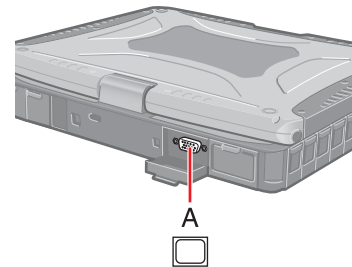

NOTE

- After resuming from hibernation or restarting the computer, the output destination may not be the same as the selected in the previous status.
- When you change the display after Windows starts up, do not press any key until switching is complete.
- Until Windows startup is completed (during Setup Utility, etc.), the simultaneous display cannot be used and pressing **Fn+F3** switches the display between the internal LCD and the external display.
- Display switching by pressing **Fn+F3** may not work when you use the Fast User Switching function to switch the user. In this case, log off all users and restart the computer.
- Display switching does not work when [Command Prompt] screen is set to “Full Screen”.
- When you use the external display only, set the suitable number of colors, resolution, or refresh rate separately from when you use the internal LCD only or when you use the simultaneous display. Depending on the settings, some external displays may be distorted or may not display the mouse cursor correctly. In this case, set the settings to lower value.
- When you use the simultaneous display, DVD-Video, MPEG files and other motion image files may not be played back smoothly.
- Carefully read the instruction manual of the external display.
- When connecting an external display that does not conform to the Plug & Play standards, select the display driver accordingly in the following menu, or use the driver disk supplied with the monitor.
[start] - [Control Panel] - [Appearance and Themes] - [Display] - [Settings] - [Advanced] - [Monitor] - [Properties] - [Driver] - [Update Driver]
- If a picture is not displayed normally, lower the level of [Hardware acceleration] in the following menu.
[start] - [Control Panel] - [Appearance and Themes] - [Display] - [Settings] - [Advanced] - [Troubleshoot]

CAUTION

- Before disconnecting the external display, switch to the internal LCD by pressing **Fn+F3**. Otherwise the displayed image quality may become different after disconnection (e.g., wrong resolution). In this case, press **Fn+F3** to reset the image quality.
- The screen may become distorted due to the following operations. In this case, restart the computer.
 - Disconnecting an external display for which you have set high resolution or high refresh rate.

- Connecting/disconnecting an external display during computer operations.

Switching the Display

1 Press **Fn+F3**.

Each time you press the key combination:

Internal LCD → Simultaneous display → External display
↑

Extended Desktop

The extended desktop function allows you to use the working area across both the internal LCD and the external display. You can drag an object from the internal LCD to the external display and vice versa.

1 Display the [Intel(R) Graphics Media Accelerator Driver for mobile] screen.

Click [start] - [Control Panel] - [Other Control Panel Options] - [Intel(R) GMA Driver for Mobile] - [Display Devices].

2 Click [Extended Desktop], and make the settings for [Primary Device] and [Secondary Device].

3 Click [OK].

At the confirmation message, click [OK].

NOTE

- It may not be possible to use the extended desktop with some software applications.
- When you click the maximize button, the window is displayed on one of the displays. You cannot move the maximized window to the other display.
- You cannot switch the display by pressing **Fn+F3**.
- Do not use the display rotation in the extended desktop.
- The popup menu icon displayed by **Fn** key combination appears only on the primary device.
- Set the internal LCD to the primary device when using the touchscreen (only for model with touchscreen) or digitizer (only for model with digitizer). The cursor will move on the primary device when you touch the internal LCD.

Connecting/Removing USB Devices

■ To connect the USB device

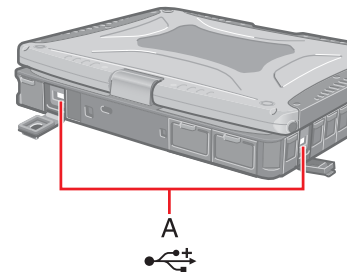

- 1 **Open the cover and connect the USB device to one of the USB ports (A).**

For further information, refer to the instruction manual of the USB device.



■ To remove the USB device

- 1 **Disable the USB device.**

- ① Double-click  on the notification area and select the USB device, then click [Stop].
- ② Follow the on-screen instructions.
 - This step is not necessary when;
 - Removing the device after turning off the computer.
 -  is not displayed.
 - The device does not appear in the list in step ①.

- 2 **Remove the USB device.**

NOTE

- You may need to install the driver for the USB device. Follow the on-screen instructions or refer to the instruction manual of the USB device.
- You may need to install the driver again when connecting the device to another port.
- When a USB device is connected, standby and hibernation may not function normally. If the computer does not start up normally, remove the USB device and restart the computer.
- When the USB device is removed and then inserted,  may appear in the Device Manager and the device may not be correctly recognized. In this case, remove and connect the device again.
- When a USB device is connected, power consumption increases. Remove the USB device when it is not in use, especially when operating by battery power.

You can connect a digital video camcorder or other IEEE 1394 standard device to the computer.

■ To connect IEEE 1394 device

- 1 Turn on the computer and the IEEE 1394 device.
- 2 Open the cover, and connect the IEEE 1394 device to the IEEE 1394 interface connector (A).
For further information, refer to the instruction manual of the IEEE 1394 device.

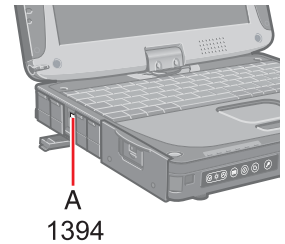

NOTE

- You may need to install the driver for the IEEE 1394 device. Follow the on-screen instructions or refer to the instruction manual of the IEEE 1394 device.

■ To remove IEEE 1394 device

CAUTION

- Turn off the IEEE 1394 device only after turning off the computer.

- 1 Turn off the computer and disconnect the cable from the IEEE 1394 interface connector.
- 2 Turn off the IEEE 1394 device and remove the cable.

<only for model with internal modem>

Connecting the Internal Modem with a Telephone Jack

CAUTION

- Do not use the PBX internal phone lines installed in company offices. Doing so may lead to a fire or electric shock.
- You cannot connect the modem to the following lines.
 - Interphone
 - Intercoms
 - ISDN
- Be sure to connect the telephone cable into the modem port, not into the LAN port.
- Use a surge protector since the modem may be damaged by a sudden high voltage surge that may occur in the event of a lightning strike.

1 Open the cover and connect the telephone jack (A) to the computer by using the telephone cable (included) (B).

- Hold the cable so that the shape of the connector (C) matches the port, and insert fully until it clicks.

2 Click [start] - [Control Panel] - [Printers and Other Hardware] - [Phone and Modem Options] and change the settings as necessary.

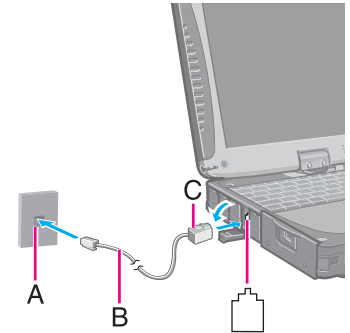

NOTE

- Do not enter standby or hibernation during communications.
- To remove the cable, press and hold the lever and pull out.

Ring Resume Function

The computer automatically resumes from standby when the telephone connected to the modem rings. You will need software to keep the computer in idle state waiting for a phone call, and if you prefer, to turn the computer to standby again afterward. For further information, refer to the instruction manual of the software application.

■ To enable this function

- 1 Click [start] - [Control Panel] - [Performance and Maintenance] - [System] - [Hardware] - [Device Manager] - [Modems], and double-click the internal modem.
- 2 Click [Power Management], add the check mark for [Allow this device to bring the computer out of standby.], and click [OK].

■ To set the time to return the computer to standby

The computer will enter standby after the set time even when the communication is not completed. You can avoid such an uncompleted communication if you select [Never], but the computer does not return to standby after resuming by a phone call.

- ① Click [start] - [Control Panel] - [Performance and Maintenance] - [Power Options] - [Power Schemes].
- ② Set the expected communication time.

NOTE

- This function does not work when the computer is off or is in hibernation.
- Connect the AC adaptor.
- The screen remains dark after the computer resumes from standby. The previous screen display will be restored when you touch the keyboard, touch pad, touchscreen (only for model with touchscreen) or tablet buttons. Do not touch the digitizer (only for model with digitizer).
- The computer cannot resume if the telephone is not connected to the internal modem. (e.g., you cannot use a PC Card modem.)
- The computer needs some time to respond, so set the calling time longer than normal. If this is not possible on the transmission side, reduce the number of rings before answering on the software that you are using to keep the computer in idle waiting for the call.

Connecting LAN

CAUTION

- Do not connect the telephone cable to the LAN port.

1 Turn off the computer.

- Do not use standby or hibernation.

2 Open the cover and connect the cable.

Connect the LAN port (A) and the network system (server, HUB, etc.) by using a LAN cable.

3 Turn on the computer.

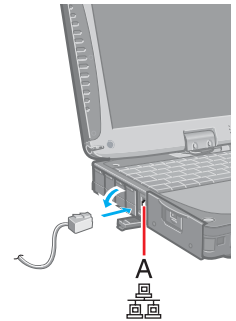

Power On by LAN/Wake Up from Wired LAN

NOTE

- Even when a password is set in the Setup Utility and [Password on boot] is set to [Enable], entering the password is unnecessary for turning on or resuming the computer.
- Connect the AC adaptor.
- The Power On by LAN function is off under the following conditions:
 - When you turn the computer off by sliding the power switch for four seconds or longer (e.g., after a hung-up).
 - When you reattach the AC adaptor and battery pack to the computer after removing them.
- The screen remains dark after the computer resumes from standby. The previous screen display will be restored when you touch the keyboard, touch pad, touchscreen (only for model with touchscreen) or tablet buttons. Do not touch the digitizer (only for model with digitizer).

Enabling the Power On by LAN function

The computer automatically turns from off to on when the computer is accessed from the network server via the internal LAN port.

- 1** Select **[Allow]** in **[Power On by LAN]** in the **[Advanced]** menu of the **Setup Utility** (→ [page 69](#)).
- 2** In **[Caution]**, press **Enter**.
- 3** Press **F10**, and then select **[Yes]** and press **Enter**.
- 4** Log on to Windows as an administrator.
- 5** Click **[start]** - **[Control Panel]** - **[Performance and Maintenance]** - **[System]** - **[Hardware]** - **[Device Manager]** - **[Network adapters]** and double-click **[Marvell Yukon 88E8055 PCI-E Gigabit Ethernet Controller]**, and then click **[Advanced]**.
- 6** Click **[Wake From Shutdown]** in **[Property]** and select **[On]** in **[Value]**, and then click **[OK]**.

NOTE

- The computer may accidentally turn on if the linkage status is changed. To prevent the accidental startup, make the setting by the following steps.
 - ① Click **[start]** - **[Control Panel]** - **[Performance and Maintenance]** - **[System]** - **[Hardware]** - **[Device Manager]** - **[Network adapters]** and double-click **[Marvell Yukon 88E8055 PCI-E Gigabit Ethernet Controller]**, and then click **[Advanced]**.
 - ② Click **[Wake Up Capabilities]** in **[Property]** and select **[Magic Pocket]** in **[Value]**, and then click **[OK]**.

Enabling/Disabling the Wake Up from wired LAN function

When the Wake Up from wired LAN function is enabled, the computer automatically resumes from standby or hibernation when the computer is accessed from the network server via the internal LAN port. (Default setting)

The Wake Up from wired LAN function can be switched to enable/disable by performing the following procedure.

- 1** Click **[start]** - **[Control Panel]** - **[Performance and Maintenance]** - **[System]** - **[Hardware]** - **[Device Manager]** - **[Network adapters]** and double-click **[Marvell Yukon 88E8055 PCI-E Gigabit Ethernet Controller]**, and then click **[Power Management]**.

2 Add check marks for [Allow the computer to turn off this device to save power.] and [Allow this device to bring the computer out of standby.], and click [OK].

We recommend you to make the above two settings ON/OFF simultaneously.

NOTE

- The computer may resume when another computer in the network makes unintentional access. Using the following procedure, you can prevent accidental startup by unintentional access.
 - ① Click [start] - [Control Panel] - [Performance and Maintenance] - [System] - [Hardware] - [Device Manager] - [Network adapters] and double-click [Marvell Yukon 88E8055 PCI-E Gigabit Ethernet Controller], and then click [Power Management].
 - ② Add a check mark for [Only allow management stations to bring the computer out of standby.], and click [OK].

<Only for model with wireless LAN, Bluetooth and/or wireless WAN>

There are three ways of disabling and enabling wireless communication.

- The wireless switch on the left side of the computer (below)
- Wireless Switch Utility (→ [page 55](#))
- Settings in the [Advanced] menu of the Setup Utility (→ [page 69](#))

NOTE

- For further information about wireless LAN: → [page 58](#)
- For further information about Bluetooth: → [page 62](#)
- For further information about wireless WAN: Refer to the instruction manual of the wireless device.
- The wireless communication is also enabled or disabled by connecting or disconnecting the LAN cable. (→ [page 56](#))

The Wireless Switch

■ To disable all wireless communication

1 Open the cover.



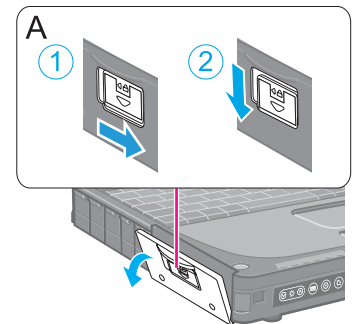

- ① Slide the latch (A) to the right to unlock the cover.
- ② Slide the latch (A) down, and open the cover.

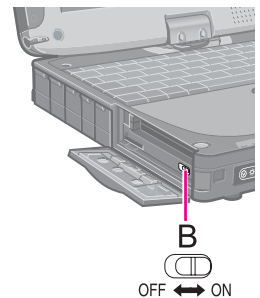

2 Slide the wireless switch (B) to OFF.



NOTE



- If you uninstall the Wireless Switch Utility, set the wireless switch to ON.
- Do not turn on/off the switch repeatedly at too short intervals.
- Do not restart, log off, or enter standby or hibernation immediately after turning on/off the switch.
- Do not turn on/off the switch while Windows is starting up.
- To use wireless communication, set the wireless device ([Wireless LAN] / [Bluetooth] / [Wireless WAN]) to [Enable] (default) in the [Advanced] menu of the Setup Utility (→ [page 69](#)).
- When you set [Wireless Switch] to [Disable] in the [Advanced] menu of the Setup Utility (→ [page 69](#)), the Wireless Switch Utility icon will not appear in the notification area. All wireless equipment (wireless LAN, Bluetooth, wireless WAN) will remain ready irrespective of the wireless switch setting.
- It may take some time to turn off wireless communication after switching the wireless switch off.
- If the IEEE802.11a setting is changed in [Device Manager] (→ [page 60](#)), the display will be changed accordingly.
- You can check the wireless LAN communication status in Intel® PROSet/Wireless Software. Perform either of the following procedures.
 - Double-click  ,  ,  , OR  on the notification area.
 - Click [start] - [All Programs] - [Intel PROSet Wireless] - [Intel PROSet Wireless].

Wireless Switch Utility

This utility allows you to control the function of the wireless switch. This utility also allows you to enable or disable wireless devices from a pop-up menu in the notification area. In the default setting, all wireless devices are enabled.

■ The Wireless Switch Utility icon

The icon appears in the notification area. It shows the status of wireless devices.

-  : Indicates that the wireless devices are enabled.
-  : Indicates that the wireless devices are off.
-  : Indicates that the wireless devices have been disabled in the Setup Utility.

■ To enable or disable particular wireless devices

- 1 Click the Wireless Switch Utility icon to show the pop-up menu.
- 2 Select On or Off for the device you want to enable or disable.

■ To change the function of the wireless switch

In the default setting, the on/off settings that were selected for each device at the time you last turned off the wireless switch are restored when you set the wireless switch to ON again. You can change this function.

[Selects the device for which to turn the device status on each time with the dialog box.]



Display a dialog each time you set the wireless switch to ON so you can choose which wireless device to enable.

[Turns on the following device.]

Only selected devices are enabled when you set the wireless switch to ON.

[Turns on the device that was on immediately before the wireless switch was turned off the last time.] (default)

When you turn on the wireless switch, the on/off settings that were selected when you last turned off the wireless switch will be restored.

- 1 Click the Wireless Switch Utility icon ( or ) on the notification area and click [Settings...].
- 2 Select the setting you want to assign to the wireless switch.
- 3 Click [OK].

Wireless Connection Disable Utility

You can automatically disable the wireless LAN connection and the wireless WAN connection when a LAN cable is connected to your computer. You need to install the Wireless Connection Disable Utility to use this function.

Installing the utility

- 1 Log on to Windows as an administrator.
- 2 Click [start] - [Run] and input [c:\util\wdisable\setup.exe], and click [OK].
- 3 Follow the on-screen instructions to install the Wireless Connection Disable Utility.

Checking the status of the wireless connection

NOTE

- The Wireless Switch Utility should also be installed so that the Wireless Connection Disable Utility works. The Wireless Switch Utility has already been installed at the factory.
- To use the utility, select [Enable] in [Wireless Switch] in the [Advanced] menu of the Setup Utility.
- The utility does not automatically disable the Bluetooth connection.

■ Status indication

After installation, the Wireless Connection Disable Utility is automatically started after a user is logged in. An icon appears on the notification area.



: Indicates that

- the utility is enabled, and
- the wireless connection is disabled since a LAN cable is connected.



: Indicates that

- the utility is enabled, and
- the wireless connection is enabled since no LAN cable is connected.



: Indicates one of the following statuses;

- The utility does not monitor the LAN port status,
- the Wireless Switch Utility has not been started, or
- the built-in LAN device is not detected or disabled with the device manager.

■ Menu

Right-clicking the utility icon in the notification area opens a menu as follows.

Clicking the menu item causes the following utility action.

Monitoring LAN Cable: ON

Enables the Wireless Connection Disable Utility to monitor the LAN port and disable wireless connection when a LAN cable is connected.

Monitoring LAN Cable: OFF

Disables the Wireless Connection Disable Utility, and enables wireless connection regardless of whether a LAN cable is connected or not.

Exit

Exits the Wireless Connection Disable Utility and enables wireless connection.

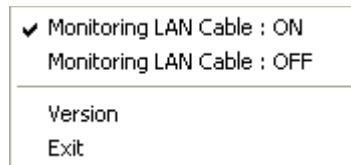

<Only for model with wireless LAN>

CAUTION

- **Do not use wireless LAN on airplanes, in hospitals, or in other locations where wireless LAN signals may affect peripheral devices.**
Follow the instructions of airline companies and hospitals. If you use the computer in these locations, turn off the wireless LAN.
- **To avoid unauthorized access to the computer through wireless LAN**
We recommend you to make security settings such as encryption before using wireless LAN. Otherwise the hard disk data such as the shared files can be exposed to the risk of unauthorized access.

NOTE

- Communication is established through the wireless LAN antenna (A). Do not block the antenna area with your hand or body.
- You cannot use the wireless LAN function together with the Fast User Switching function.
- The transmission rate will be lower when a microwave oven is used near by.
- To use wireless LAN, set [Wireless LAN] to [Enable] (default) in the [Advanced] menu of the Setup Utility (→ [page 69](#)).
- Wireless communication may momentarily be interrupted when you use the display rotation function in the Tablet mode.

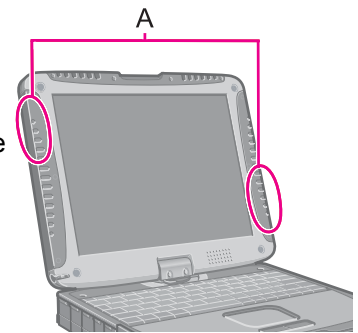







■ To turn on/off wireless LAN

→ [page 53](#), Disabling/Enabling Wireless Communication

■ To check the wireless LAN communication status

→ [page 56](#), Status indication

Setting the Profiles

- 1** Double-click  /  /  on the notification area.
The [Intel(R) PROSet/Wireless] screen appears.
 - When  or  is displayed, skip step 2.
- 2** When you double-clicked  in step 1, slide the wireless switch to turn on.
- 3** Click [Profiles...] at the lower right corner of the window, and click [Add...].
- 4** Enter the profile name and wireless network name (SSID), and make other necessary changes, then click [Next].
- 5** Make necessary settings and click [OK].
- 6** Select the profile you set and click [Connect].
- 7** Click [Close].



NOTE

- You need to set the profile for each user.
- The settings depend on the network environment. For further information, ask the system administrator or the person in charge of the network.
- For further information of Intel® PROSet/Wireless Software, refer to [Help] in the menu bar.

Enabling/Disabling the Wireless LAN Standard IEEE802.11a (802.11a)

- 1 Click  or  on the notification area.
- 2 Click [802.11a Disabled] or [802.11a Enabled].

NOTE

- In some countries, communication using IEEE802.11a (5 GHz wireless LAN) standard is restricted by law.
- The Wireless Switch Utility icon ( or ) indicates the on/off status of wireless LAN and/or Bluetooth and/or wireless WAN, not the setting of IEEE802.11a.
- If IEEE802.11a is enabled or disabled while the computer is connected to an IEEE802.11b/g access point, the connection will be temporarily interrupted.
- You can also change the IEEE802.11a setting in [Device Manager].
 - ① Click [start] - [Control Panel] - [Performance and Maintenance] - [System] - [Hardware] - [Device Manager].
 - ② Double-click [Network adapters] and double-click [Intel(R) Wireless WiFi Link 4965AG].
 - ③ Click [Advanced], and then click [Wireless Mode] in [Property].
 - ④ Remove the check mark from [Use default value] in [Value], and select the settings (e.g., [802.11a and 802.11g]).
 - ⑤ Click [OK].

If you turn on/off 802.11a using the popup menu of Wireless Switch Utility, the setting in [Device Manager] will be accordingly changed as below.

Settings in Device Manager	Settings in Wireless Switch Utility	
	When 802.11a is enabled	When 802.11a is disabled
[802.11a, 802.11b and 802.11g] [802.11b and 802.11g]	a+b+g is enabled	b+g is enabled
[802.11g only] [802.11a and 802.11g]	a+g is enabled	g is enabled
[802.11a only] [802.11b only]	a is enabled	b is enabled

Wake Up from Wireless LAN

Enabling the Wake Up from Wireless LAN function

The computer automatically resumes from standby or hibernation when the computer is accessed from the network server via the wireless LAN.

- 1** Click [start] - [Control Panel] - [Performance and Maintenance] - [System] - [Hardware] - [Device Manager] - [Network adapters] and double-click [Intel(R) Wireless WiFi Link 4965AG], and then click [Power Management].
- 2** Add check marks for [Allow the computer to turn off this device to save power.] and [Allow this device to bring the computer out of standby.], and click [OK].

CAUTION

- Even if the Wake Up from wireless LAN function is enabled, it will be disabled once the communication stops for even a moment (for example, when there is heavy signal traffic or the computer is taken out of the communication range of the access point).
The Wake Up from wireless LAN function will also be disabled if the wireless switch (→ [page 53](#)) at the ON position is set to OFF.
- While the Wake Up from wireless LAN function is enabled, the wireless ready LED indicator lights in standby or hibernation mode. This does not necessarily mean that the wireless connection is established.

NOTE

- The computer may resume when another computer in the network makes unintentional access.
Using the following procedure, you can prevent accidental startup by unintentional access.
 - ① Click [start] - [Control Panel] - [Performance and Maintenance] - [System] - [Hardware] - [Device Manager] - [Network adapters] and double-click [Intel(R) Wireless WiFi Link 4965AG], and then click [Power Management].
 - ② Add a check mark for [Only allow management stations to bring the computer out of standby.], and click [OK].
- If the wireless switch is set to ON, and the Wake Up from wireless LAN function is enabled, the computer consumes electricity, even in the standby/hibernation mode.
- The Wake Up from wireless LAN function does not work when network connection is established in ad hoc mode.

<Only for model with Bluetooth>

You can access internet and other Bluetooth devices without connecting cables.

NOTE

- Communication is established through the Bluetooth antenna (A). Do not block the antenna area with your hand or body.
- To use Bluetooth, set [Bluetooth] to [Enable] (default) in the [Advanced] menu of the Setup Utility (→ [page 69](#)).
- The transmission rate will be lower when a microwave oven is used near by.

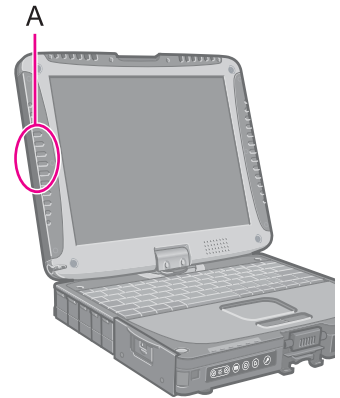

■ To turn on/off Bluetooth

→ [page 53](#), Disabling/Enabling Wireless Communication

■ To check the Bluetooth communication status

→ [page 56](#), Status indication

■ To access the online manual

- ① Click [start] - [All Programs] - [Bluetooth] - [User's Guide].

Inserting/Removing the Hard Disk Drive

To change your hard disk drive, contact Panasonic Technical Support.

CAUTION

- Back up all the important data before removing the hard disk drive.
- If you need to read the hard disk data on another computer for repair or any other purpose, set [Hard Disk Lock] to [Disable] in the [Security] menu of the Setup Utility (→ [page 70](#)) before removing the hard disk drive.
- Carefully remove/insert the hard disk drive since the hard disk drive is extremely sensitive to shock. Note that static electricity may affect some internal components.

1 Turn off the computer and disconnect the AC adaptor.

- Do not use standby or hibernation.

2 Remove the battery pack (→ [page 27](#)).

3 Insert/Remove the hard disk drive.

- To remove

- ① Slide the latch (A) to the right to unlock the cover.
- ② Slide the latch (A) down, and open the cover.

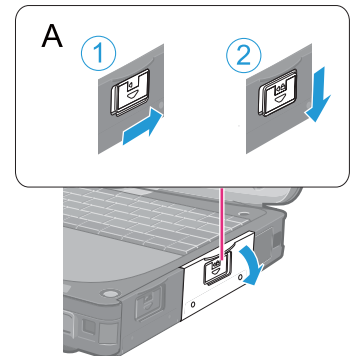

- ③ Pull the tab (B) of the hard disk drive and slide it out of the slot.

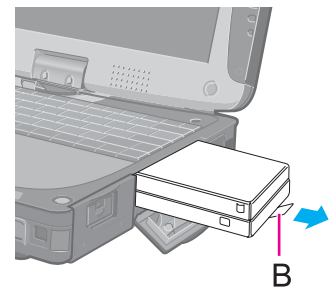

- To insert
- ① Insert the hard disk drive until it surely fits in the slot.

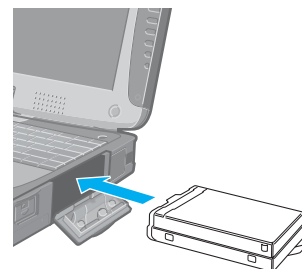

- ② Close the cover until it clicks, and slide the latch (C) to the left to lock the cover.

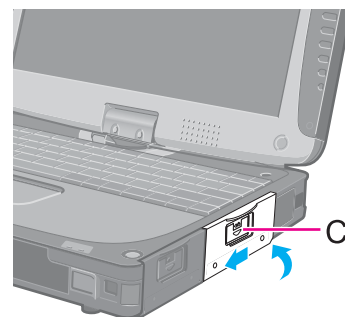

4 Insert the battery pack (→ [page 27](#)).

CAUTION

- Confirm that the latch is surely locked so that it does not fall when you carry the computer.

NOTE

- You can erase the data before changing the hard disk drive. (⇒ *Operating Instructions* “Hard Disk Data Erase Utility”)
- You can check that the hard disk is recognized or not in the [Information] menu of the Setup Utility (→ [page 66](#)). If the hard disk is not recognized, turn off the computer and insert it again.

You can make the settings of the computer's operating environment (password settings, startup drive selection, etc.)

Starting the Setup Utility

- 1 Turn on or restart the computer.
- 2 Press **F2** several times while [Panasonic] boot screen is displayed soon after the computer starts the startup procedure.

When [Enter Password] is displayed, enter your password.

When you start the Setup Utility with Supervisor Password

- You can make the settings of all items of the Setup Utility.

When you start the Setup Utility with User Password

- Note the following:
 - In the [Advanced] and [Boot] menus, you cannot make the settings of all items.
 - In the [Security] menu, you can change only the User Password when [User Password Protection] is set to [No Protection]. You cannot delete the User Password.
 - In the [Exit] menu, you cannot make the setting of [Get Default Values].
 - **F9** (Setup Defaults) does not function.

Information Menu

Underlined items are the factory presets.

Language	<u>English</u> Japanese
Model No.	Computer information (cannot be changed.)
Serial No.	
CPU Type	
CPU Speed	
BIOS	
Embedded Controller	
System Memory	
Available Memory	
Hard Disk	
Accumulative Operating Time	

Main Menu

Underlined items are the factory presets.

System Time <ul style="list-style-type: none"> • 24-hr. style. • You can use <u>Tab</u> to move the cursor. 	[xx:xx:xx]
System Date <ul style="list-style-type: none"> • Month/Day/Year. • You can use <u>Tab</u> to move the cursor. 	[xx/xx/xxxx]
Touch Pad	Disable <u>Enable</u>
Touchscreen Mode <ul style="list-style-type: none"> • Only for model with touchscreen 	Touchscreen Tablet <u>Auto</u>
Current Status <ul style="list-style-type: none"> • Only when [Touchscreen Mode] is set to [Auto]. 	Depending on the touchscreen mode setting, either "Touchscreen" or "Tablet" is displayed.
Display <ul style="list-style-type: none"> • The display during the Windows start-up process. When an external display is not connected, the information appears on the internal LCD even though an [External Monitor] is selected. 	<u>External Monitor</u> Internal LCD
Environment	Normal Temperature High Temperature <u>Auto</u>
Current Status <ul style="list-style-type: none"> • Only when [Environment] is set to [Auto]. 	Depending on the battery status, either "Normal Temperature" or "High Temperature" is displayed.

Advanced Menu

Underlined items are the factory presets.

Core Multi-Processing	Disable <u>Enable</u>
Intel (R) Virtualization Technology	Disable <u>Enable</u>
► Serial Port Settings <ul style="list-style-type: none"> Used to configure the serial port A/B and GPS. 	Enter the sub-menu ^{*1} .
Modem <ul style="list-style-type: none"> Only for model with internal modem 	Disable <u>Enable</u>
LAN	Disable <u>Enable</u>

*1 The submenu that appears when [Serial Port Settings] is selected:

Serial Port A	Disable Enable <u>Auto</u>
I/O IRQ <ul style="list-style-type: none"> Can be changed only when [Serial Port A] is set to [Enable]. 	3F8/IRQ4 2F8/IRQ3 3E8/IRQ11 2E8/IRQ10
Serial Port B	Disable Enable <u>Auto</u>
I/O IRQ <ul style="list-style-type: none"> Can be changed only when [Serial Port B] is set to [Enable]. 	3F8/IRQ4 2F8/IRQ3 3E8/IRQ11 2E8/IRQ10
GPS <ul style="list-style-type: none"> Only for model with GPS 	Disable Enable <u>Auto</u>
I/O IRQ <ul style="list-style-type: none"> Can be changed only when [Serial Port A] is set to [Enable]. Can be changed only when [GPS] is set to [Enable]. 	3F8/IRQ4 2F8/IRQ3 3E8/IRQ11 2E8/IRQ10

Power On by LAN <ul style="list-style-type: none"> • Can be changed only when [LAN] is set to [Enable]. • To use [Power On by LAN], make additional settings in [Device Manager] (→ page 50). 	<u>Deny</u> <u>Allow</u>
Wireless LAN <ul style="list-style-type: none"> • Only for model with wireless LAN 	<u>Disable</u> <u>Enable</u>
Wireless WAN <ul style="list-style-type: none"> • Only for model with wireless WAN 	<u>Disable</u> <u>Enable</u>
Bluetooth <ul style="list-style-type: none"> • Only for model with Bluetooth 	<u>Disable</u> <u>Enable</u>
Wireless Switch	<u>Disable</u> <u>Enable</u>
PC Card Slot	<u>Disable</u> <u>Enable</u>
ExpressCard Slot <ul style="list-style-type: none"> • Only for model without SmartCard slot • Can be changed only when [Wireless WAN] is set to [Enable]. 	<u>Disable</u> <u>Enable</u>
Smart Card <ul style="list-style-type: none"> • Only for model with Smart Card slot 	<u>Disable</u> <u>Enable</u>
SD Slot	<u>Disable</u> <u>Enable</u>
IEEE1394 Port	<u>Disable</u> <u>Enable</u>
USB Port	<u>Disable</u> <u>Enable</u>
Port Replicator USB Port <ul style="list-style-type: none"> • If [Port Replicator USB Port] is set to [Disable], the LAN port of port replicator or the car mounter is also disabled. 	<u>Disable</u> <u>Enable</u>
Legacy USB Support <ul style="list-style-type: none"> • Can be changed only when [USB Port] or [Port Replicator USB Port] is set to [Enable]. 	<u>Disable</u> <u>Enable</u>

Security Menu

Underlined items are the factory presets.

Execute-Disable Bit Capability • [Enable] indicates that this computer supports hardware-based Data Execution Prevention (DEP).	Disable <u>Enable</u>
Password on boot	Disable <u>Enable</u>
SD Startup • Only when [Password on boot] is set to [Enable] and one or more SD card is registered.	<u>Disable</u> Enable
SD Setting Method • Only when [SD Startup] is set to [Enable]	<u>Leave Set</u> Set and Eject
▶ Clear registered SD card • Only when one or more SD card is registered.	Enter the sub-menu.
▶ Set Supervisor Password	Enter the sub-menu.
Setup Utility Prompt • When [Setup Utility Prompt] is set to [Disable], the message “Press F2 for Setup / F12 for LAN” is not displayed on [Panasonic] boot screen. However, <u>F2</u> and <u>F12</u> will work even if the message is not displayed.	Disable <u>Enable</u>
Boot First Menu	Disable <u>Enable</u>
Hard Disk Lock	<u>Disable</u> Enable
User Password Protection	<u>No Protection</u> Protected
▶ Set User Password	Enter the sub-menu.
▶ Embedded Security (TPM) Sub-Menu • Only for model that supports TPM	Enter the sub-menu.
▶ Computrace (R) Sub-Menu	Enter the sub-menu.

Boot Menu

```
Boot priority order:
1: USB FDD:*1
2: Hard Disk: xxxxxxxxxx
3: USB CDD:
4: PCI LAN: xxxxxxxxxx
5:
6:
7:
8:
Excluded from boot order:*2
USB KEY:
USB HDD:
USB LS120:
```

*1 Use the Panasonic USB floppy disk drive (optional: CF-VFDU03U)

*2 The devices under [Excluded from boot order] are not booted.

■ To change the boot order

To move up, select the device with ↑ and ↓, and then press F6.

To move down, select the device with ↑ and ↓, and then press F5.

To move the device from [Excluded from boot order] to [Boot priority order] or vice versa, select the device with ↑ and ↓, and then press X.

To return to the default setting, press 1.

NOTE

- The default order is [USB FDD] -> [Hard Disk] -> [USB CDD] -> [PCI LAN].
- To boot from the following devices, make the settings as below.

To boot from

- USB connected device : [USB Port] and [Legacy USB Support] to [Enable] (→ [page 69](#))
- LAN : [LAN] to [Enable] (→ [page 68](#))

You need to set

- You can select the boot device during start-up of the computer, too. Press Esc soon after [Panasonic] boot screen is displayed. [Boot Menu] appears and you can select the device. [Boot Menu] appears only when [Boot First Menu] in the [Security] menu is set to [Enable] (→ [page 70](#)). When you change the setting in the [Boot] menu, [Boot Menu] will be changed accordingly.

Exit Menu

Save Values & Exit	To save the changes to CMOS and reboot.
Exit Without Saving Changes	To exit without saving the changes to CMOS.
Get Default Values	To return the settings to the default values.
Load Previous Values	To load the previous values from CMOS.
Save Current Values	To save the changes to CMOS.

Enlarging the screen items

You can enlarge the screen items such as characters, icons, title bars and cursor.

CAUTION

- “Icon Enlarger” will not start up if the display resolution is set lower than 1024 x 768 dots.

NOTE

- A part of the enlarged menu or some screen items may be hidden. In this case, overlay the cursor to display pop-ups, scroll the screen, or use other functions to display the hidden items.
- The Icon Enlarger setting affects the website characters displayed by Internet Explorer and the e-mail characters in Outlook Express. Some characters of website and e-mail may not be enlarged.

Preparation

Close all of the applications before using “Icon Enlarger”.

- 1 Click [start] - [All Programs] - [Panasonic] - [Icon Enlarger].**
- 2 Select the size.**
- 3 Click [OK].**

The screen will be displayed in the selected size.

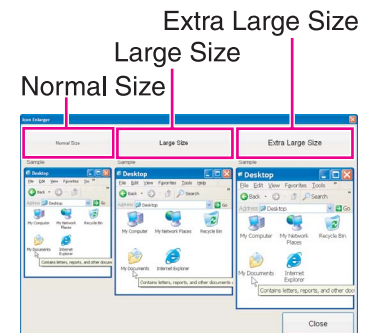



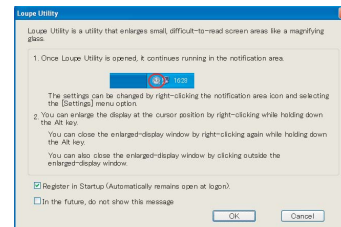

You can magnify the specific part of the screen.

Activating the Loupe Utility

- 1 Click [start] - [All Programs] - [Panasonic] - [Loupe Utility].
- 2 Click [OK].
 -  appears on the notification area.



Using the Loupe Utility

- 1 Point the cursor  at the part of the screen you want to magnify.
- 2 Press and hold **Alt**, and right-click.
 - The part pointed by the cursor is magnified.
 - Alternatively you can double-click , or right-click  and click [Show Loupe].
- 3 Drag the loupe window (A) to move the magnified part.
 - To hide the loupe window, click the Hide button  (B).
 - Alternatively you can click any part out of the loupe window, or press and hold **Alt** and right-click.
 - To change the loupe window size, drag the bottom-right corner (C).
The size range you can enlarge/shrink depends on the screen's resolution.

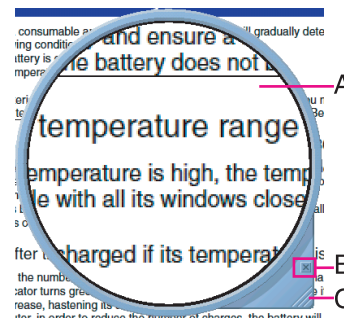

NOTE

- The magnified text or image in the loupe window is fixed at the moment that the part is magnified (e.g., at the moment you press and hold **Alt** and right-click). To reflect the change you made on the original screen to the loupe window, click the loupe window.
- The Loupe Utility does not work with some applications.

Setting the Loupe Utility

1 Right-click  on the notification area.



2 Click [Settings].

[Show/hide shortcuts assignment]

- When using the external mouse/touch pad

- ① Click [Mouse/Touch pad]
- ② Click a combination of **Alt**, **Ctrl**, and **Shift**, and add the check mark. (Multiple keys can be combined; for example, **Ctrl + Alt**)
- ③ Select either [Right click] or [Left Click] to use in combination with the key(s) selected in ② above.

- When using the keyboard

- ① Click [Keyboard].
- ② Click the text box and then press the key used for the shortcut. (e.g., **Alt + Z**, **Ctrl + Alt + Z**, etc.)

[Window shape]

Select the shape of the loupe window.

[Autorun]

Add a check mark to run the Loupe Utility when Windows starts up.

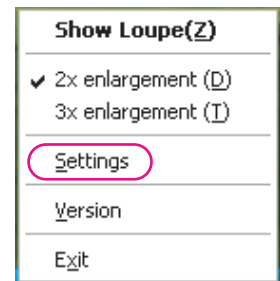

3 Click [OK].

This computer conforms to the specifications of the Desktop Management Interface (DMI). You can use the DMI Viewer to access the computer's information including the CPU, memory and supported system.

1 Click [start] - [All Programs] - [Panasonic] - [DMI Viewer].

The DMI Viewer screen appears.

2 Click the item to display the detailed information.

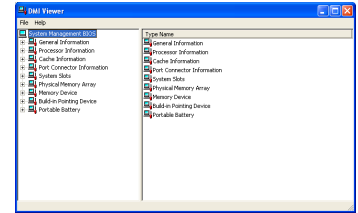

■ **To save the information as a text file**

① **To save the item that is displayed**

Click [File] - [Save Selected Data...].

To save all items

Click [File] - [Save All Data...].

② Select the folder, input the file name, then click [Save].

Recover Pro is a data backup software application developed by Phoenix Technologies Ltd. It provides 3 types of backup as follows:

- Quick Backup: Scheduled backup of the updated data
- File Backup: File backup at file save and change
- Complete Backup: Backup of the entire data on the internal hard disk

For further information, refer to the software's online manual.

Installing Recover Pro

1 Log on to Windows as an administrator.

2 Close all the applications.

- Disable antivirus software.

3 Click [start] - [Run] and input [c:\util\rcvpro\setup.exe], and click [OK].

Follow the on-screen instructions.

- After the computer restarts, Recover Pro starts initialization. Do not touch keys or switch including hot key, during initialization until an instruction message appears.

CAUTION

- Be sure to use the internal hard disk drive to create the backup area. Never use disk or device other than the internal hard disk drive.
- Some software (security software, backup software, encryption software, or hard disk accessible specific software, etc.) may be incompatible with Recover Pro.
For further information, refer to:
<http://www.phoenix.com/en/Customer+Services/White+Papers-Specs/Recover+Pro/default.htm>
- When using Personal Secure Drive (refer to the *Installation Manual* of "Trusted Platform Module (TPM)"), do not execute File Backup for Personal Secure Drive.

NOTE

- If you select [Typical] in installation, approximately 40% (max.) of the hard disk drive space is allocated as the backup area.
- You cannot change the size of backup area after creation.

■ To access the online manual

- ① Click [start] - [All Programs] - [Phoenix Applications] - [Docs], and double-click [UserGuides].
- ② Double-click the file of Recover Pro user's guide or Phoenix Always user's guide.

Network Connections and Communications Software

Close the communications software before using the power saving function.

- If the power saving function (standby or hibernation) is activated while communications software is used, the network connection may be interrupted, or the performance may be adversely affected. In this case, restart the computer.
- In a network environment, set the [System standby] and [System hibernates] settings to [Never].
Click [start] - [Control Panel] - [Performance and Maintenance] - [Power Options] - [Power Schemes].

Using the Windows Associated Files

The Windows files included in the retail version of the Windows CD-ROM for OS are contained in the following folders:

<Only for model with Windows XP Professional>

c:\windows\docs, c:\windows\dotnetfx, c:\windows\i386, c:\windows\support, c:\windows\valueadd

<Only for model with Windows XP Tablet PC Edition>

c:\windows\docs, c:\windows\dotnetfx, c:\windows\i386, c:\windows\support, c:\windows\valueadd, c:\windows\cmpnents

Serial Devices

The COM ports of the computer are assigned as below.

- COM1 : Serial Port A
- COM2 : Serial Port B (Port replicator^{*1}/Car mounter^{*1})
- COM3 : GPS^{*1}

^{*1} Optional

If you change the assignment, the serial devices may not work properly.

Refer to the following instructions when a problem occurs. If the remedies indicated in the chart do not solve the problem, contact Panasonic Technical Support. For a software problem, refer to the instruction manual of the software.

- To check the computer's usage status (→ [page 86](#)).

■ Shut Down

Cannot shut down or restart Windows.	<ul style="list-style-type: none">● Remove USB devices.● It may take one or two minutes to shut down.
--------------------------------------	--

■ Standby or Hibernation

Cannot enter standby or hibernation.	<ul style="list-style-type: none">● Remove USB devices temporarily. If the problem persists, restart the computer.● It may take one or two minutes to enter standby or hibernation.● The computer may not enter standby when the computer is communicating via modem.● The computer does not enter standby or hibernation immediately after resuming. Wait approximately one minute.
Cannot enter standby or hibernation automatically.	<ul style="list-style-type: none">● Disconnect peripheral devices.
The computer does not resume.	<ul style="list-style-type: none">● If you slide and hold the power switch for four seconds or longer, the power will be turned off forcibly and the computer will not resume. In this case, all unsaved data will be lost.● You disconnected the AC adaptor and the battery pack while the computer was in standby mode. If the computer's power supply is disconnected in standby mode, unsaved data will be lost and the computer will not resume.● The battery is exhausted. Standby and hibernation consume some power.
The computer will not automatically enter standby/hibernation mode.	<ul style="list-style-type: none">● If you connect to a network using wireless LAN function, select the profile and connect to the access point (→ page 59).● If you do not use wireless LAN function, turn off wireless LAN function (→ page 53).● Make sure that you are not using any software that regularly accesses the hard disk.



■ Sound

No sound.	<ul style="list-style-type: none">● Press Fn+F4 or Fn+F6 to cancel mute.● Restart the computer.
Distorted sound.	<ul style="list-style-type: none">● Performing Fn key combinations sometimes causes sound distortion. Stop and restart playback.

■ Sound

Cannot change the volume by pressing Fn+F5 or Fn+F6 .	<ul style="list-style-type: none"> ● Activate the Windows sound function. When it is not active, the volume does not change even if  is displayed.
“There was an error updating the registry” appears when Sound Recorder is started.	<ul style="list-style-type: none"> ● Sound Recorder is started by a limited account user whose language setting is not the same as the administrator user who last started Sound Recorder. This does not affect the operation.

■ Keyboard

Only numbers can be input.	<ul style="list-style-type: none"> ● When the indicator  is on, the keyboard is in ten-key mode. Press NumLk to cancel.
Only capital letters can be input.	<ul style="list-style-type: none"> ● When the indicator  is on, the keyboard is in Caps Lock mode. Press Caps Lock to cancel.
Cannot enter special characters (ß, à, ç, etc.) and symbols.	<ul style="list-style-type: none"> ● Use the character map. Click [start] - [All Programs] - [Accessories] - [System Tools] - [Character Map].
Cannot use the keyboard in the Tablet mode.	<ul style="list-style-type: none"> ● <Only for model with Windows XP Professional> Use the software keyboard. (→ page 9) ● <Only for model with Windows XP Tablet PC Edition> Use the Tablet PC Input Panel. (Refer to the Windows Help.)







■ Display Rotation

The display angle does not change automatically when switching Laptop mode and Tablet mode.	<ul style="list-style-type: none"> ● Set the default angle correctly for each mode. (→ page 13) ● Do not switch the mode until the Fast User Switching is completed.
Cannot rotate the display.	<ul style="list-style-type: none"> ● Close all of the applications. ● You cannot rotate the display to 90° and 270° in the Tablet mode if you uninstalled Wireless Switch Utility or Intel® PROSet/Wireless Software. To reinstall, click [start] - [Run] and input [c:\util\wswitch\Setup.exe] (Wireless Switch Utility) / [c:\util\drivers\wlan\XP\Apps\ix32\install.bat] (Intel® PROSet/Wireless Software), and click [OK]. Then restart the computer.
The operations of touch pad and touchscreen (only for model with touchscreen) do not match the rotation angle.	<ul style="list-style-type: none"> ● The operations do not match immediately after you start Windows. ● Close the applications and press the Rotation button until the operations match the rotation angle. The operations do not match in some applications or when you change the screen settings in [Display Properties] or Intel(R) GMA Driver for Mobile with the display rotated.

■ Network

Cannot connect to network.	<ul style="list-style-type: none"> ● Set [LAN], or [LAN] and [Modem] to [Enable] in the [Advanced] menu of the Setup Utility (→ page 68).
Cannot check the computer's MAC address.	<ul style="list-style-type: none"> ● Follow the steps below. <ol style="list-style-type: none"> ① Click [start] - [All Programs] - [Accessories] - [Command Prompt]. ② Input [ipconfig/all], and press Enter. ③ Write down the 12-digit string of alphanumeric displayed in the "Physical Address" line of the LAN or the wireless LAN (only for model with wireless LAN). ④ Input [exit], and press Enter.

■ Wireless Communication (only for model with wireless LAN/Bluetooth/wireless WAN)

Cannot connect to network.	<ul style="list-style-type: none"> ● Slide the wireless switch to turn on the wireless devices. ● Set the devices ([Wireless LAN] / [Bluetooth] / [Wireless WAN]) to [Enable] in the [Advanced] menu of the Setup Utility (→ page 69). ● Disable the Wireless Connection Disable Utility. ● Restart the computer. ● You cannot turn on wireless LAN if you uninstalled Display Rotation Tool. To reinstall it, click [start] - [Run] and input [c:\util\disprot\Setup.exe], and click [OK].
Access point is not detected.	<ul style="list-style-type: none"> ● Confirm that  /  /  is displayed on the notification area. ● If  /  /  is not displayed on the notification area, turn on the wireless communication (→ page 53).

■ Connecting Peripherals

An error occurs while installing the driver.	<ul style="list-style-type: none"> ● When you install a driver of card or peripheral device, make sure that the driver is compatible with the operating system. If it is not compatible, malfunction may occur. For information about the driver, contact the manufacturer of the peripheral device.
--	---

■ Connecting Peripherals

<p>A peripheral device does not work.</p>	<ul style="list-style-type: none"> ● Install the driver. ● Contact the manufacturer of the device. ● When operation resumes from standby or hibernation, devices such as a mouse, modem and PC Card may not function properly. In this case, restart the computer or reinitialize the device. ● When  is displayed in the Device Manager, remove and insert the device. If the problem persists, restart the computer. ● The computer may not recognize the connection/removal of some devices, or may not operate normally with some devices. <ol style="list-style-type: none"> ① Click [start] - [Control Panel] - [Performance and Maintenance] - [System] - [Hardware] - [Device Manager]. ② Select the device and remove the check mark for [Allow the computer to turn off this device to save power.] in [Power Management]. (This item may be unavailable for some types of devices.)
<p>The connected mouse does not work.</p>	<ul style="list-style-type: none"> ● Check the mouse connection. ● Install the driver compatible with the connected mouse. If the mouse does not work even after installing the driver, set [Touch Pad] to [Disable] in the [Main] menu of the Setup Utility (→ page 67).
<p>USB floppy disk drive does not work as a boot drive.</p>	<ul style="list-style-type: none"> ● You can use only the Panasonic CF-VFDU03U USB floppy disk drive (optional). ● Connect the floppy disk drive directly to a USB port of the computer. Do not connect it via a USB hub or USB connector of the port replicator or the car mounter. If you have connected to a USB port on the computer, try connecting it to one of the other USB ports. ● Set [USB Port] and [Legacy USB Support] to [Enable] in the [Advanced] menu of the Setup Utility (→ page 69). ● Move up [USB FDD] to the top of [Boot priority order] in the [Boot] menu of the Setup Utility (→ page 71). ● Turn off the computer and connect the USB floppy disk drive, and then restart the computer.
<p>The RAM module is not recognized.</p>	<ul style="list-style-type: none"> ● Insert the RAM module correctly. ● Use the compatible RAM module (→ page 40). ● Check the [Information] menu in the Setup Utility (→ page 66). If the RAM module is not recognized, turn off the computer and reinsert the RAM module.
<p>You do not know the address map for IRQ, I/O port address, etc.</p>	<ul style="list-style-type: none"> ● To check the current address map, click [start] - [Control Panel] - [Performance and Maintenance] - [System] - [Hardware] - [Device Manager] - [View] - [Resources by type].

■ Connecting Peripherals

<p>The device connected to the serial port does not work.</p>	<ul style="list-style-type: none"> ● Check the connection. ● The device driver may not work. Refer to the instruction manual of the device. ● Do not connect two mouse devices simultaneously. ● Set [Touch Pad] to [Disable] in the [Main] menu of the Setup Utility (→ page 67). ● Set [Serial Port A] or [Serial Port B] to [Auto] in the submenu of [Serial Port Settings] in the [Advanced] menu of the Setup Utility (→ page 68). ● The I/O and IRQ you can use vary depending on the device. If the setting does not work, try other settings in the Setup Utility.
<p>The Serial Port B of the port replicator or the car mounter does not work.</p>	<ul style="list-style-type: none"> ● Set [Serial Port B] to [Auto] in the submenu of [Serial Port Settings] in the [Advanced] menu of the Setup Utility (→ page 68).
<p>Cannot print.</p>	<ul style="list-style-type: none"> ● Check the printer connection. ● Turn on the printer. ● The printer is not online. ● No paper is in the printer tray or there is a paper jam. ● Turn on the printer and connect it to the computer, and then restart the computer.
<p>LAN transmission speed slows down noticeably. Poor performance during data transmission via a PC Card (e.g., distorted video image when writing to a DV camera using an IEEE1394 PC Card). <Only for model with wireless LAN> Wireless LAN connection is cut.</p>	<ul style="list-style-type: none"> ● These problems may occur due to performance loss that results from the CPU power-saving function. Log on to Windows as an administrator and follow the steps below. <ol style="list-style-type: none"> ① Click [start] - [Run] and input [c:\util\cpupower\setup.exe], and click [OK]. Follow the on-screen instructions. ② Click [start] - [All Programs] - [Panasonic] - [CPU Idle Setting]. ③ Click [Performance] and click [OK], then click [Yes]. The computer will restart. <ul style="list-style-type: none"> ● If the problem persists, click [start] - [Control Panel] - [Performance and Maintenance] - [Power Options] - [Power schemes], select [Always On] in [Power schemes], and click [OK]. ● The above remedy is effective for performance loss resulting from the CPU power saving function, but not for other causes (e.g., noise generated by high CPU load such as video playback). ● The above remedy slightly reduces the battery operation time. Normally it is recommended to select [Battery (Windows XP Standard)] in [CPU Idle Setting] and to select [Portable/Laptop] in [Power schemes].

■ Touch Pad / Touchscreen (only for model with touchscreen)/Digitizer (only for model with digitizer)

The cursor does not work.	<ul style="list-style-type: none"> ● Connect the external mouse correctly. ● Restart the computer using the keyboard. (Press F₈, U, and R to select [Restart].) ● If the computer does not respond to keyboard commands, read “No response” (→ page 85).
Cannot input using the touch pad.	<ul style="list-style-type: none"> ● Set [Touch Pad] to [Enable] in the [Main] menu of the Setup Utility (→ page 67). ● The touch pad may be disabled by some mouse drivers. Check your mouse’s operating instructions.
Cannot point the correct position using the included stylus/pen.	<ul style="list-style-type: none"> ● <Only for model with touchscreen> Perform the touchscreen calibration (→ page 7). ● <Only for model with digitizer> Perform the digitizer calibration (→ page 8).

■ PC Card / ExpressCard

A card does not work.	<ul style="list-style-type: none"> ● Insert the card correctly. ● The card does not conform to the card standard. ● Restart the computer after installing a driver (of card or other device). ● Set [PC Card Slot] and [ExpressCard Slot] to [Enable] in the [Advanced] menu of the Setup Utility (→ page 69). ● The port settings are not correct. ● Read the instruction manual of the card or contact the manufacturer of the card. ● Remove the card and insert it again (→ page 29). ● The driver is not compatible with the operating system.
-----------------------	---

■ SD Memory Card

Cannot use an SD Memory Card.	<ul style="list-style-type: none"> ● Set [SD Slot] to [Enable] in the [Advanced] menu of the Setup Utility (→ page 69).
Cannot use SD security function.	<ul style="list-style-type: none"> ● Setup the SD Memory Card (→ page 34).
Cannot log on using the SD Memory Card.	<ul style="list-style-type: none"> ● The user name and password set in the SD Memory Card are not correct. Enter the correct user name and password, and log on to Windows without using the SD Memory Card. Set the correct user name and password in [SD Card Setup] (→ page 34).

■ Fast User Switching Function

<p>Some applications do not work properly.</p>	<ul style="list-style-type: none">● When switching to a different user with the Fast User Switching function, the following problems may occur.<ul style="list-style-type: none">• Some applications may not work properly.• Key combination with Fn may not work.• The display settings may not be possible.• A serial mouse may not work.• <Only for model with wireless LAN> Wireless LAN cannot be used.• <Only for model with Bluetooth> Bluetooth cannot be used. <p>In these cases, log off all users without using Fast User Switching function and perform the operation once more. If the problem persists, restart the computer.</p>
--	---

■ Others

<p>No response.</p>	<ul style="list-style-type: none">● Press Ctrl+Shift+Esc to open Task Manager and close the software application.● An input screen (e.g., password input screen at startup) may be hidden behind another window. Use Alt+Tab to check.● Shut down by sliding and holding the power switch for four seconds or longer, and turn on the computer and open the application again. If it no longer works normally, delete and reinstall it. Click [start] - [Control Panel] - [Add or Remove Programs].
---------------------	---

Checking the Computer's Usage Status

You can check the computer's usage status in the PC Information Viewer. You may need this information when calling Panasonic Technical Support for advice.

NOTE

- This computer periodically records the management information including the hard disk information such as number of hours powered-on, number of times powered-on, internal temperature, replacement sector. The maximum data volume for each record is 750 byte. These information are only used for estimating the cause when the hard disk goes down by any possibility. They are never sent to outside via network nor used for any other purpose except for the purpose described the above.
To disable the function, add the check mark for [Disable the automatic save function for management information history] in [Hard Disk Status] of PC Information Viewer, and click [OK].
- If you have not logged on with the administrator authority, some information will be displayed as [Not Found].
- As long as it is activated, the PC Information Viewer will appear in front of all other screens.

- 1** Click [start] - [All Programs] - [Panasonic] - [PC Information Viewer] - [PC Information Viewer].
- 2** Select the item to display the detailed information.

■ To save the information as a text file

- ① Display the information you want to save.
 - ② Click [Save].
 - ③ Select the file save range option and click [OK].
 - ④ Select the folder to save the information, input the file name, and click [Save].
- If automatic saving of the management information record has not been disabled, the records already recorded are also saved.

■ To save a copy of the screen as an image file

- ① Display the screen you want to save.
- ② Press **Ctrl+Alt+F8**.
- ③ When the screen copy message appears, click [OK].
The screen image is saved in [My Documents] folder.
 - Alternatively you can save a copy of the screen in the following procedure.
Click [start] - [All Programs] - [Panasonic] - [PC Information Viewer] - [Screen Copy].

NOTE

- The image is a bitmap file in 256 colors.
 - When using the extended desktop (→ [page 45](#)), a copy of the primary device screen is saved.
 - The default key combination to copy is **Ctrl+Alt+F8**. You can change it in the following procedure.
 - ① Log on to Windows as an administrator, and click [start] - [All Programs] - [Panasonic] - [PC Information Viewer].
 - ② Right-click [Screen Copy] - [Properties] and click [Shortcut].
 - ③ Click [Shortcut key] and press the key(s) you want to use for the shortcut.
 - ④ Click [OK].
-

- Copyright

This manual is copyrighted by Matsushita Electric Industrial Co., Ltd. with all rights reserved. No part of this manual may be reproduced in any form without the prior written permission of Matsushita Electric Industrial Co., Ltd. No patent liability is assumed with respect to the use of the information contained herein.

© 2007 Matsushita Electric Industrial Co., Ltd. All Rights Reserved.

- Disclaimer

Computer specifications and manuals are subject to change without notice. Matsushita Electric Industrial Co., Ltd. assumes no liability for damage incurred directly or indirectly from errors, omissions or discrepancies between the computer and the manuals.

- Trademarks

- Microsoft, Windows and the Windows logo are registered trademarks of Microsoft Corporation of the United States and/or other countries.
- Intel, Core, Viiv, Centrino and PROSet are either registered trademarks or trademarks of Intel Corporation.



- SDHC Logo is a trademark.
- Adobe, the Adobe logo and Adobe Reader are either registered trademarks or trademarks of Adobe Systems Incorporated in the United States and/or other countries.
- PhoenixBIOS, Phoenix Always and Recover Pro are trademarks and/or registered trademarks of Phoenix Technologies Ltd.
- Bluetooth™ is a trademark owned by Bluetooth SIG, Inc., U.S.A. and licensed to Matsushita Electric Industrial Co., Ltd.
- PS/2® is a registered trademark of International Business Machines Corporation.
- Panasonic is a registered trademark of Matsushita Electric Industrial Co., Ltd.
- Names of products, brands, etc., appearing in this manual are trademarks or registered trademarks of their respective own companies.