

**Panasonic®**

# OPERATING INSTRUCTIONS

## Personal Computer

Model No. **CF-29 Series**



**TOUGHBOOK**

**XP**

**[Additional Manual]**

**Reference Manual**

This manual can be accessed on your computer.  
Refer to page 20 on how to access the Reference Manual.

## Contents

### Getting Started

Read Me First .....	3
Names and Functions of Parts .....	9
First-time Operation .....	11

**Reference Manual**

- Read Me First
- Key Combinations
- LED Indicators

### Operation

Starting Up/Shutting Down.....	16
Touch Pad (Basic Operation) .....	19
Reference Manual .....	20
Useful Information .....	21

**Reference Manual**

- Touch Pad
- Touchscreen\*1
- Panasonic Hand Writing
- Standby/Hibernation Functions
- Security Measures
- Computing on the Road
- Battery Power
- Multimedia Pocket
- PC Cards
- RAM Module
- Port Replicator
- External Display
- Printer
- USB Devices
- Modem
- LAN
- Wireless LAN\*2
- Hard Disk Drive
- Setup Utility
- Icon Enlarger
- Loupe Utility

\*1 Only for models with touchscreen \*2 Only for models with wireless LAN

### Troubleshooting

List of Error Codes .....	25
Dealing with Problems (Summary).....	26
Reinstalling Software .....	33

**Reference Manual**

- Technical Information
- DMI Viewer
- List of Error Codes
- Dealing with Problems (Advanced)

### Appendix

LIMITED USE LICENSE AGREEMENT .....	35
Hard Disk Backup Function .....	37
Hard Disk Data Erase Utility .....	41
Specifications .....	42
LIMITED WARRANTY .....	44

Getting Started

Operation

Troubleshooting

Appendix

## Customer's Record



Model No.* _____	Dealer's Name _____
Serial No. _____	_____
or	
Code No. _____	Dealer's Address _____
Date of Purchase _____	

\* For the Model No., insert the 12 digit number (for example, CF-29HTLGZBM) located on the bottom of the computer.

## Introduction

Thank you for purchasing the Panasonic computer. Read the operating instructions thoroughly for proper operation of your new computer.

## Illustrations and Terminology in this Manual

- NOTE:** **NOTE** provides a useful fact or helpful information.
- CAUTION:** **CAUTION** indicates a condition that may result in minor or moderate injury.
- Enter** : This illustration means to press the [Enter] key.
- Fn** + **F5** : This illustration means to press and hold the [Fn] key, then press the [F5] key.
- [start] - [Run] : This illustration means to click [start], then to click [Run]. For some applications, you may need to double-click.
-  : Where to go for referred information.
-  Reference Manual : This illustration means to refer to the Reference Manual, which is available on your computer. Refer to page 20 on how to access this manual.
- Some of the illustrations in this manual may differ slightly in shape from the actual items in order to make the explanation easier to understand.
  - The “CD/DVD drive” is a description about drives, such as DVD-ROM, CD-ROM, CD-R/RW, and DVD-ROM & CD-R/RW drives.
  - This manual covers two types of models, as distinguished by the type of LCD screen (models with touchscreen and models without touchscreen).
  - If the user has logged on without the administrator authority, some functions may not be executable, and some screens may be not displayed as shown in this manual. If this happens, log on with the administrator authority to enable these functions.
  - Confirm the latest information on optional products in catalogs, etc.
  - In this manual, “Microsoft® Windows® XP Professional Service Pack 2 with Advanced Security Technologies” is indicated as “Windows” or “Windows XP”.

## Copyright

This manual is copyrighted by Matsushita Electric Industrial Co., Ltd. with all rights reserved. No part of this manual may be reproduced in any form without the prior written permission of Matsushita Electric Industrial Co., Ltd.

No patent liability is assumed with respect to the use of the information contained herein.

© 2004 Matsushita Electric Industrial Co., Ltd. All Rights Reserved.

## Disclaimer

Computer specifications and manuals are subject to change without notice. Matsushita Electric Industrial Co., Ltd. assumes no liability for damage incurred directly or indirectly from errors, omissions or discrepancies between the computer and the manuals.

## Trademarks

Microsoft, Windows and the Windows logo are registered trademarks of Microsoft Corporation of the United States and/or other countries.

Intel, Pentium and PROSet are either registered trademarks or trademarks of Intel Corporation.

Adobe, the Adobe logo and Adobe Reader are either registered trademarks or trademarks of Adobe Systems Incorporated in the United States and/or other countries.

Panasonic is a registered trademark of Matsushita Electric Industrial Co., Ltd.

Names of products, brands, etc., appearing in this manual are trademarks or registered trademarks of their respective owner companies.

# Read Me First

## For U.S.A.

### Federal Communications Commission Radio Frequency Interference Statement

Note: This equipment has been tested and found to comply with the limits for a Class B digital device, pursuant to Part 15 of the FCC Rules. These limits are designed to provide reasonable protection against harmful interference in a residential installation. This equipment generates, uses and can radiate radio frequency energy and, if not installed and used in accordance with the instructions, may cause harmful interference to radio communications. However, there is no guarantee that interference will not occur in a particular installation. If this equipment does cause harmful interference to radio or television reception, which can be determined by turning the equipment off and on, the user is encouraged to try to correct the interference by one or more of the following measures:

- Reorient or relocate the receiving antenna.
- Increase the separation between the equipment and receiver.
- Connect the equipment into an outlet on a circuit different from that to which the receiver is connected.
- Consult the Panasonic Service Center or an experienced radio/TV technician for help.

### Warning

To assure continued compliance, use only shielded interface cables when connecting to a computer or peripheral. Also, any changes or modifications not expressly approved by the party responsible for compliance could void the user's authority to operate this equipment.

### FCC RF Exposure Warning:

- This equipment is provided with PC Card slot that could be used with wireless transmitters, which will be specifically recommended when they become available. Other third-party wireless transmitters have not been RF exposure evaluated for use with this computer and may not comply with FCC RF exposure requirements.

### <Only for models with wireless LAN>

- This equipment complies with FCC radiation exposure limits set forth for an uncontrolled environment.
- This equipment has been approved for mobile operation, and unless otherwise advised in separate supplemental instructions for individual wireless transmitter(s), requires minimum 20 cm spacing be provided between antenna(s) and all person's body (excluding extremities of hands, wrist and feet) during wireless modes of operation.
- This equipment may use multiple installed transmitters, which may be capable of simultaneous transmission.
- This equipment is provided with external antenna connector(s) for connection to optional Car Mounter or Port Replicator for mobile external mounted antenna(s). External antenna(s) must be professionally installed and cannot exceed recommended maximum antenna gain as described in individual provided supplement instructions for wireless transmitters. Also, user must maintain minimum 20 cm spacing between external antenna(s) and all person's body (excluding extremities of hands, wrist and feet) during wireless modes of operation.

### <Only for models with wireless LAN>

This product is restricted to indoor use due to its operation in the 5.15 to 5.25 GHz frequency range.

FCC requires this product to be used indoors for the frequency range 5.15 to 5.25 GHz to reduce the potential for harmful interference to co-channel Mobile Satellite systems.

High power radars are allocated as primary users of the 5.25 to 5.35 GHz and 5.65 to 5.85 GHz bands. These radar stations can cause interference with and /or damage this product.

This device complies with Part 15 of the FCC Rules. Operation is subject to the following two conditions:

- (1) This device may not cause harmful interference, and
- (2) This device must accept any interference received, including interference that may cause undesired operation.

Responsible Party: Panasonic Corporation of North America  
One Panasonic Way  
Secaucus, NJ 07094  
Tel No: 1-800-LAPTOP5 (1-800-527-8675)

### FCC Regulation Notice for modem This equipment contains a FCC approved modem.

Manufacturer of modem: AMBIT Microsystems Corporation  
Model No. T60M283.\*\* (\*\* = numbers or alphabet letters)

**FC** Tested To Comply  
With FCC Standards  
FOR HOME OR OFFICE USE

1. This equipment complies with CFR47 Part 68 rules. On the computer is a label that contains, among other information, the FCC registration number and ringer equivalence number (REN) for this equipment. If required, this information must be provided to the telephone company.
2. An FCC compliant telephone cord and modular plug is provided with this equipment. This equipment is designed to be connected to the telephone network or premises wiring using a compatible modular jack which is Part 68 compliant. See Installation Instructions for details.
3. The REN is used to determine the quantity of devices which may be connected to the telephone line. Excessive RENs on the telephone line may result in the devices not ringing in response to an incoming call. In most, but not all area, the sum of RENs should not exceed five (5.0). To be certain of the number of devices that may be connected to a line, as determined by the total RENs, contact the local telephone company.
4. If your telephone equipment cause harm to the telephone network, the telephone company will notify you in advance that temporary discontinuance of service may be required. But if advice notice isn't practical, the telephone company will notify the customer as soon as possible. Also, you will be advised of your right to file a complaint with the FCC if you believe it is necessary.
5. The telephone company may take changes in it's facilities, equipment, operations or procedures that could affect the operation of the equipment. If this happens the telephone company will provide advance notice in order for you to make necessary modifications to maintain uninterrupted service.
6. If trouble is experienced with this equipment, for repair or warranty information, please contact Panasonic Corporation of North America at DIAL TOLL FREE 1-800-LAPTOP5 (1-800-527-8675). If the equipment is causing harm to the telephone network, the telephone company may request that you disconnect the equipment until the problem is resolved.
7. There are no user serviceable parts contained in this equipment.
8. This equipment may not be used on coin service provided by the telephone company. Connection to party lines is subject to state tariffs.

# Read Me First

9. The Telephone Consumer Protection Act of 1991 makes it unlawful for any person to use a computer or other electronic device to send any message via a telephone fax machine unless such message clearly contains in a margin at the top or bottom of each transmitted page or on the first page of the transmission, the date and time it is sent and an identification of the business or other entry, or other individual sending the message and the telephone number of the sending machine or such business, other entity, or individual. In order to program this information into your fax software, you should refer to the manual of the Fax software being used.
10. According to the FCC's electrical safety advisory, we recommend that you may install an AC surge arrestor in the AC outlet to which this equipment is connected. Telephone companies report that electrical surges, typically lightning transients, are very destructive to customer terminal equipment connected to AC power sources and that this is a major nationwide problem.

“Caution: To reduce the risk of fire, use only No.26 AWG or larger telecommunication line cord.”

“ATTENTION: Pour réduire le risque d'incendie, utiliser uniquement des conducteurs de télécommunications 26 AWG ou de section supérieure.”

## For Canada

### Industry Canada (IC) Notice for modem

This equipment contains an Industry Canada approved modem unit. The Industry Canada label is affixed on the modem unit.

### EQUIPMENT ATTACHMENT LIMITATIONS

“NOTICE: The Industry Canada label identifies certified equipment. This certification means that the equipment meets telecommunications network protective, operational and safety requirements as prescribed in the appropriate Terminal Equipment Technical Requirements document(s). The Department does not guarantee the equipment will operate to the user's satisfaction.

Before installing this equipment, users should ensure that it is permissible to be connected to the facilities of the local telecommunications company. The equipment must also be installed using an acceptable method of connection. The customer should be aware that compliance with the above conditions may not prevent degradation of service in some situations.

Repairs to certified equipment should be coordinated by a representative designated by the supplier. Any repairs or alterations made by the user to this equipment, or equipment malfunctions, may give the telecommunications company cause to request the user to disconnect the equipment.

Users should ensure for their own protection that the electrical ground connections of the power utility, telephone lines and internal metallic water pipe system, if present, are connected together. This precaution may be particularly important in rural areas. Caution: Users should not attempt to make such connections themselves, but should contact the appropriate electric inspection authority, or electrician, as appropriate.”

“NOTICE: The Ringer Equivalence Number (REN) assigned to each terminal device provides an indication of the maximum number of terminals allowed to be connected to a telephone interface. The termination on an interface may consist of any combination of devices subject only to the requirement that the sum of the Ringer Equivalence Numbers of all the devices does not exceed 5.”

REN: See bottom of the computer

### Notice for the products using LCD

This product uses one or more fluorescent lamps containing a small amount of mercury. It also contains lead in some components. Disposal of these materials may be regulated in your community due to environmental considerations. For disposal or recycling information please contact your local authorities, or the Electronics Industries Alliance: <<http://www.eiae.org/>>

### UL1604-conforming model. (The model which has description of “UL1604” in the bottom of the computer.)

- THIS EQUIPMENT IS SUITABLE FOR USE IN CLASS I, DIVISION 2, GROUPS A, B, C AND D OR NON-HAZARDOUS LOCATIONS ONLY.
- WARNING – EXPLOSION HAZARD – SUBSTITUTION OF COMPONENTS MAY IMPAIR SUITABILITY FOR CLASS I, DIVISION 2.
- When connecting and using a device manufactured by a third party, enquire to the manufacturer as to whether the device suits CLASS I, DIVISION 2.

### RESTRICTIONS CONCERNANT LE RACCORDEMENT DE MATÉRIEL

“AVIS: L'étiquette d'Industrie Canada identifie le matériel homologué. Cette étiquette certifie que le matériel est conforme aux normes de protection, d'exploitation et de sécurité des réseaux de télécommunications, comme le prescrivent les documents concernant les exigences techniques relatives au matériel terminal. Le Ministère n'assure toutefois pas que le matériel fonctionnera à la satisfaction de l'utilisateur.

Avant d'installer ce matériel, l'utilisateur doit s'assurer qu'il est permis de le raccorder aux installations de l'entreprise locale de télécommunication. Le matériel doit également être installé en suivant une méthode acceptée de raccordement. L'abonné ne doit pas oublier qu'il est possible que la conformité aux conditions énoncées ci-dessus n'empêche pas la dégradation du service dans certaines situations.

Les réparations de matériel homologué doivent être coordonnées par un représentant désigné par le fournisseur. L'entreprise de télécommunications peut demander à l'utilisateur de débrancher un appareil à la suite de réparations ou de modifications effectuées par l'utilisateur ou à cause de mauvais fonctionnement.

Pour sa propre protection, l'utilisateur doit s'assurer que tous les fils de mise à la terre de la source d'énergie électrique, des lignes téléphoniques et des canalisations d'eau métalliques, s'il y en a, sont raccordés ensemble. Cette précaution est particulièrement importante dans les régions rurales. Avertissement: L'utilisateur ne doit pas tenter de faire ces raccordements lui-même; il doit avoir recours à un service d'inspection des installations électriques, ou à un électricien, selon le cas.”

“AVIS: L'indice d'équivalence de la sonnerie (IES) assigné à chaque dispositif terminal indique le nombre maximal de terminaux qui peuvent être raccordés à une interface. La terminaison d'une interface téléphonique peut consister en une combinaison de quelques dispositifs, à la seule condition que la somme d'indices d'équivalence de la sonnerie de tous les dispositifs n'excède pas 5.”

IES: Voir sous le fond de l'ordinateur



<Only for models with wireless LAN/GPS>

### Industry Canada

This product complies with RSS210 Industry Canada.

Operation is subject to the following two conditions;

- (1) this device may not cause interference, and
- (2) this device must accept any interference, including interference that may cause undesired operation of the device.

<Only for models with wireless LAN>

This product (local network devices) for the band 5150-5250 MHz is only for indoor usage to reduce potential for harmful interference to co-channel Mobile Satellite systems.

High power radars are allocated as primary users (meaning they have priority) of 5250-5350 MHz and 5650-5850 MHz and these radars could cause interference and/or damage to LELAN devices.

**CSA C22 2 NO.213-conforming model. (The model which has description of “CSA C22 2 NO.213” in the bottom of the computer.)**

- THIS EQUIPMENT IS SUITABLE FOR USE IN CLASS I, DIVISION 2, GROUPS A, B, C AND D OR NON-HAZARDOUS LOCATIONS ONLY.
- WARNING – EXPLOSION HAZARD – SUBSTITUTION OF COMPONENTS MAY IMPAIR SUITABILITY FOR CLASS I, DIVISION 2.
- When connecting and using a device manufactured by a third party, enquire to the manufacturer as to whether the device suits CLASS I, DIVISION 2.

## For Europe

(For models with a “CE” mark on the bottom of the computer)



### Declaration of Conformity (DoC)

“Hereby, we and Panasonic Service Europe GmbH (PSE), declares that this Personal Computer is in compliance with the essential requirements and other relevant provisions of the Directive 1999/5/EC.”

Hint:

If you want to get a copy of the original DoC of our products which relates to the R&TTE, please contact to our web address: <http://doc.panasonic-tc.de>

Network connection.

The terminal equipment is intended for connection to the following public network;

In all the countries of European Economical Area;

- Public Switched Telephony Networks

Technical Features.

The terminal equipment includes the following features;

- DTMF dialing
- Maximum bitrate receiving mode: 56 kbits/s
- Maximum bitrate sending mode: 33.6 kbit/s

This product is designed to interwork with the Public Switched Telecommunication Networks in UK, Ireland, Netherlands, Sweden, Denmark, Finland, Switzerland, Luxembourg, Belgium, France, Germany, Spain, Portugal, Iceland, Greece, Italy, Norway and Austria.

### Compliance Notice - CE Mark

This equipment is in conformance with the requirements of the European Council Directive listed below:

73/23/EEC Low Voltage Directive with amendment 93/68/EEC

89/336/EEC EMC Directive with amendments 92/31/EEC and 93/68/EEC

1999/5/EC

# Read Me First

## Important Safety Instructions / Importantes Mesures De Sécurité

When using your telephone equipment, basic safety precautions should always be followed to reduce the risk of fire, electric shock and injury to persons, including the following:

1. Do not use this product near water, for example, near a bath tub, wash bowl, kitchen sink or laundry tub, in a wet basement or near a swimming pool.
2. Avoid using a telephone (other than a cordless type) during an electrical storm. There may be a remote risk of electric shock from lightning.
3. Do not use the telephone to report a gas leak in the vicinity of the leak.
4. Use only the power cord and batteries indicated in this manual. Do not dispose of batteries in a fire. They may explode. Check with local codes for possible special disposal instructions.

SAVE THESE INSTRUCTIONS

Certaines mesures de sécurité doivent être prises pendant l'utilisation de matériel téléphonique afin de réduire les risques d'incendie, de choc électrique et de blessures. En voici quelquesunes:

1. Ne pas utiliser l'appareil près de l'eau, p.ex., près d'une baignoire, d'un lavabo, d'un évier de cuisine, d'un bac à laver, dans un sous-sol humide ou près d'une piscine.
2. Éviter d'utiliser le téléphone (sauf s'il s'agit d'un appareil sans fil) pendant un orage électrique. Ceci peut présenter un risque de choc électrique causé par la foudre.
3. Ne pas utiliser l'appareil téléphonique pour signaler une fuite de gaz s'il est situé près de la fuite.
4. Utiliser seulement le cordon d'alimentation et le type de piles indiqués dans ce manuel. Ne pas jeter les piles dans le feu: elles peuvent exploser. Se conformer aux règlements pertinents quant à l'élimination des piles.

CONSERVER CES INSTRUCTIONS

## Information to the User

<Only for models with wireless LAN>

### This product and your Health

This product, like other radio devices, emits radio frequency electromagnetic energy. The level of energy emitted by this product however is far much less than the electromagnetic energy emitted by wireless devices like for example mobile phones.

Because this product operates within the guidelines found in radio frequency safety standards and recommendations, we believe this product is safe for use by consumers. These standards and recommendations reflect the consensus of the scientific community and result from deliberations of panels and committees of scientists who continually review and interpret the extensive research literature.

In some situations or environments, the use of this product may be restricted by the proprietor of the building or responsible representatives of the organization. These situations may for example include:

- Using this product on board of airplanes, or
- In any other environment where the risk of interference to other devices or services is perceived or identified as harmful.

If you are uncertain of the policy that applies on the use of wireless devices in a specific organization or environment (e.g. airports), you are encouraged to ask for authorization to use this product prior to turning on the product.

### Regulatory Information

We are not responsible for any radio or television interference caused by unauthorized modification of this product. The correction of interference caused by such unauthorized modification will be the responsibility of the user. We and its authorized resellers or distributors are not liable for damage or violation of government regulations that may arise from failing to comply with these guidelines.

## Lithium Battery

### Lithium Battery!

This computer contains a lithium battery to enable the date, time, and other data to be stored. The battery should only be exchanged by authorized service personnel.

Warning! A risk of explosion from incorrect installation or misapplication may possibly occur.

### Pile au lithium!

Le micro-ordinateur renferme une pile au lithium qui permet de sauvegarder certaines données comme la date et l'heure notamment. Elle ne devra être remplacée que par un technicien qualifié.

Avertissement! Risque d'explosion en cas de non respect de cette mise en garde!

## Precautions

The CF-29 was developed based on thorough research into the real-world portable computing environments. Exhaustive pursuit of usability and reliability under harsh conditions led to innovations such as the magnesium alloy exterior, vibration damped hard disk drive and floppy disk drive, flexible internal connections. The CF-29's outstanding engineering has been tested using the strict MIL-STD- 810F (for vibration and shock) and IP (for dust and water) based procedures.

As with any portable computer device precautions should be taken to avoid any damage. The following usage and handling procedures are recommended.

Before putting the computer away, be sure to wipe off any moisture.

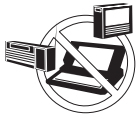

### Avoid Radio Frequency Interference

Do not place the computer near a television or radio receiver.



### Avoid Magnetic Fields

Keep the computer away from magnets. Data stored on the hard disk may be lost.



### Keep Small Objects Away

Do not insert paper clips or other small objects into the computer.



### Do Not Disassemble the Computer

Do not attempt to disassemble your computer.



### Avoid Excessive Force on the Display

Do not apply excessive downward force on the display when it is completely opened, especially when plugs and/or cables are connected to the rear of the computer.



### Avoiding Low-temperature Burns

Avoid more than casual contact with any heat producing area of the notebook computer, AC adaptor, and any option or accessory you use with it. Even low heat, if warmer than body temperature, can cause a burn, if the skin is exposed to the heat source for a long period of time.



### Do not touch the computer and cable when it starts thundering



### Do not connect a telephone line, or a network cable other than the one specified, into the LAN port

If the LAN port is connected to a network such as the ones listed below, a fire or electric shock may result.

- Networks other than 100BASE-TX or 10BASE-T
- Telephone lines
- Internal phone lines (on-premise switches)
- Digital public phones
- Phone lines other than those listed above

## Precautions (Battery Pack)

- Care should be exercised with regard to the following in order to avoid the possibility of overheating, fire or damage.



### Avoid Heat

Do not throw the battery pack into a fire or expose it to excessive heat.



### Keep Articles Away

Do not place the battery pack together with articles such as necklaces or hairpins when carrying or storing.



### Do Not Disassemble

Do not insert sharp objects into the battery pack, expose it to bumps or shocks, deform, disassemble, or modify it.



### Do Not Short

Do not short the positive (+) and negative (-) contacts.



### Avoid Extreme Heat, Cold and Direct Sunlight

Do not charge, use or leave the battery pack for extended periods where it will be exposed to direct sunlight, in a hot place (in an automobile on a sunny day, for example), or in a cold place.



### Do Not Put into a Microwave

Do not put the battery pack into a microwave oven or a pressurized chamber.



### Stop Using

Should the battery emit an abnormal odor, become hot to the touch, become discolored, change shape, or become in any way different from normal, remove it from the computer or charger and stop using it.



### Do Not Use With Any Other Computer

The battery pack is rechargeable and was intended for the specified computer or charger. Do not use it with a computer other than the one for which it was designed.



### Do not use this computer with a battery pack other than the one specified (the one included with the computer or the specified battery pack sold separately)

- Do not touch the terminals on the battery pack. The battery pack may no longer function properly if the contacts are dirty or damaged.
- Do not expose the battery pack to water, or allow it to become wet.

# Read Me First

## Precautions (Battery Pack)

- If the battery pack will not be used for a long period of time (a month or more), charge or discharge (use) the battery pack until the remaining battery level becomes 30% to 40% and store it in a cool, dry place.
- This computer prevents overcharging of the battery by recharging only when the remaining power is less than approx. 95% of capacity.
- The battery pack is not charged when the computer is first purchased. Be sure to charge it before using it for the first time. When the AC adaptor is connected to the computer, charging begins automatically.
- Should the battery leak and the fluid get into your eyes, do not rub your eyes. Immediately flush your eyes with clear water and see a doctor for medical treatment as soon as possible.

### NOTE

- The battery pack may become warm during recharging or normal use. This is completely normal.
- Recharging will not commence if internal temperature of the battery pack is outside of the allowable temperature range (0 °C to 50 °C {32°F to 122 °F}). (☞ Reference Manual “Battery Power”) Once the allowable range requirement is satisfied, charging begins automatically. Note that the recharging time varies based on the usage conditions. (Recharging takes longer than usual when the temperature is 10 °C {50 °F} or below.)
- If the temperature is low, the operating time is shortened. Only use the computer within the allowable temperature range.
- This computer has a high temperature mode function that prevents the degradation of the battery in high temperature environments. (☞ Reference Manual “Battery Power”) A level corresponding to a 100% charge for high temperature is approximately equivalent to an 80% charge level for normal temperature mode.
- The battery pack is a consumable item. If the amount of time the computer can be run by using a particular battery pack becomes dramatically shorter and repeated recharging do not restore its performance, the battery pack should be replaced with a new one.
- When transporting a spare battery inside a package, briefcase, etc., it is recommended that it be placed in a plastic bag so that its contacts are protected.
- Always power off the computer when it is not in use. Leaving the computer on when the AC adaptor is not connected will exhaust the remaining battery capacity.



# Names and Functions of Parts

The illustrations shown may differ from the actual physical appearances.

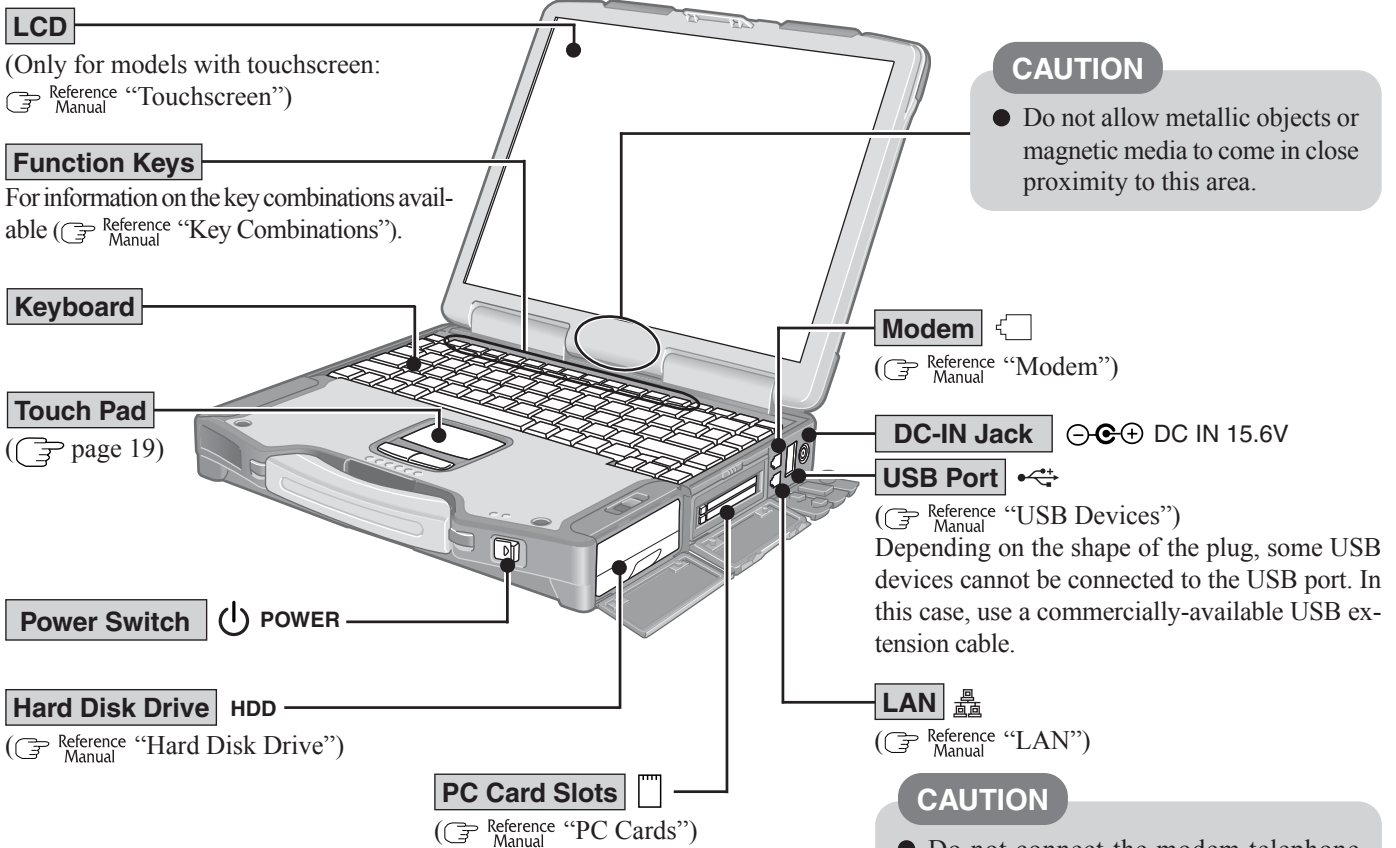

<Only for models with wireless LAN>

**Wireless LAN Antenna**  
(Reference Manual "Wireless LAN")

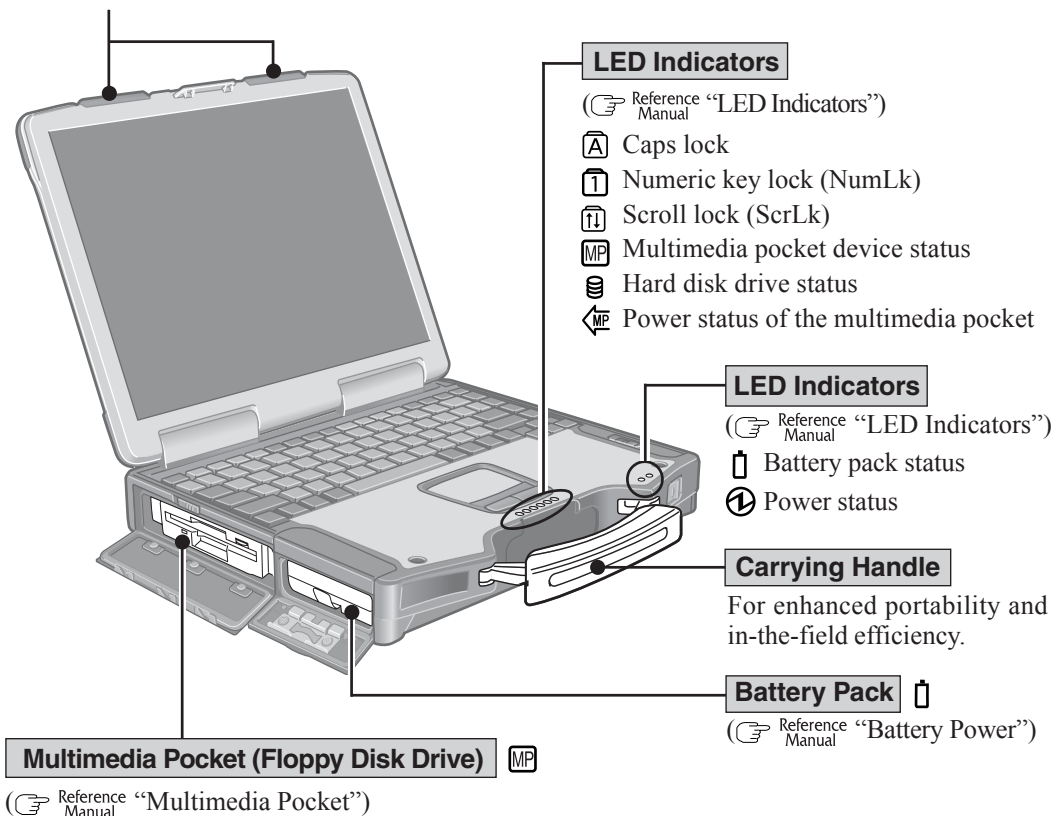

**RECYCLE**  
R B R C  
Li-ion  
1-800-822-8837

A lithium ion battery that is recyclable powers the product you have purchased. Please call 1-800-8-BATTERY for information on how to recycle this battery.

L'appareil que vous vous êtes procuré est alimenté par une batterie au lithium-ion. Pour des renseignements sur le recyclage de la batterie, veuillez composer le 1-800-8-BATTERY.

# Names and Functions of Parts

## Headphone Jack

Use this connector to connect headphones or amplifier-equipped speakers. Audio output from the internal speaker is disabled when headphones or external speakers are connected.

## USB Port

 Reference Manual “USB Devices”

Depending on the shape of the plug, some USB devices cannot be connected to the USB port. In this case, use a commercially-available USB extension cable.

## Security Lock **LOCK**

A Kensington cable can be connected to prevent theft of your computer. For more information, read the manual that comes with the cable.

## Microphone Jack

Use only a monaural condenser microphone (miniature jack). Using an input source other than a monaural condenser microphone may not allow audio to be input or may damage the equipment.

### NOTE

- When using an external microphone, do not remove the check mark for “Mute” under “Microphone Balance” of the Volume Control dialog box and do not increase the playback volume. Howling may result. Howling may occur in the same way when disconnecting an external microphone. (The microphone of “Volume Control” is in the state of mute at the time of factory shipment. This is not shown at the time of factory shipment.)

## RAM Module Slot

 Reference Manual “RAM Module”

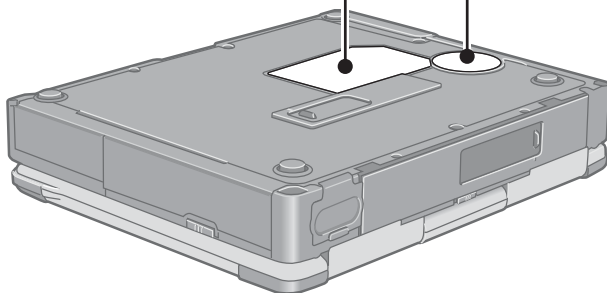

### CAUTION

- Do not cover the computer with a thick cloth, such as a blanket.

## External Display Port

 Reference Manual “External Display”

## Parallel Port

## Serial Port

## Expansion Bus Connector

 Reference Manual “Port Replicator”

### <Only for models with wireless LAN>

## External Antenna Connector

The external antenna connector is for use as an extension in the future.

### CAUTION

- FCC RF Exposure Warning:  
The optional Car Mounter may be configured to have 1 or 2 matching unique antenna passive pass-thru connectors, which would be hard-wired connected to its rear panel’s 1 or 2 external TNC antenna connectors.  
Depending upon exact computer configuration, the wireless LAN external antenna connector should be connected to recommended Radiall/Larsen wireless LAN antenna, type MS3E2400TNC with 3 dBi antenna gain.  
The other antenna connector is intended for licensed radio service external antenna and must be professionally installed.  
Supplemental instructions will be provided for any employed licensed radio service and will provided external antenna recommended maximum antenna dBi gain.

## Speaker

- To adjust the volume:  
**Fn** + **F5** / **Fn** + **F6**
- Speaker on/off : **Fn** + **F4**

### CAUTION



- Do not allow metallic objects or magnetic media to come in close proximity to the speaker on the bottom surface of the computer.
  - Because the speaker contains a magnet, metal objects may become attached to the bottom surface of the computer. This may cause the computer to be unstable, or may mark the surface of the desk on which it is sitting.
  - If floppy disks, magnetic memory cards, or other magnetic media approach the speaker, there is a risk that data will be destroyed.

# First-time Operation

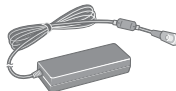
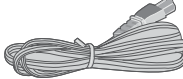
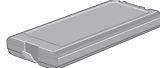

Read the steps below to help you learn what parts are included, and to gain an understanding of some basic computer-related operations.

## 1 Confirm the inclusion of all parts.

Make sure the parts shown in the figure have been supplied. If any of these items are missing or are not working properly, contact Panasonic Technical Support.

AC Adaptor ..... 1  Model No : CF-AA1653A	AC Cord ..... 1 
Battery Pack ..... 1  Model No : CF-VZSU29	Modem Telephone Cable ..... 1 
Operating Instructions (This book)*1 ..... 1	
Windows® Book ..... 1	
Product Recovery CD-ROM ..... 3	

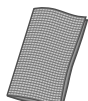
<Only for models with touchscreen>

Soft Cloth ..... 1 	Stylus ..... 1  <small>(Reference Manual "Touchscreen")</small>
---	--

\*1 If additional instructions are included with the computer, be sure to read them. It may be necessary to perform additional operations during the following procedures.

## 2 Read the LIMITED USE LICENSE AGREEMENT. (☞ page 35)

Be sure to read the LIMITED USE LICENSE AGREEMENT before breaking the seal on the computer's packaging.

## 3 Insert the battery pack.

① Unlock the cover by sliding the latch to the right.

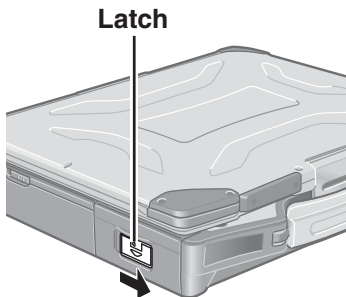

② Slide the latch down, and then without releasing it, open the cover as illustrated.

# First-time Operation

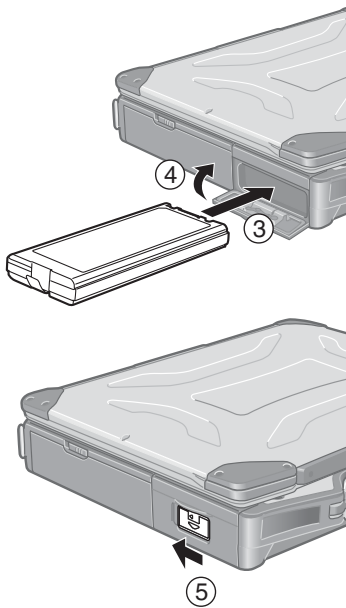

- Slide the battery pack inward until it is firmly in place.

### CAUTION

- Do not touch the terminals on the battery pack and the computer. The battery pack may no longer function properly if the contacts are dirty or damaged. Also, the computer may not operate properly.
- Be sure to insert the battery pack as illustrated.

- Close the cover until it clicks into place.
- Lock the cover by sliding the latch to the left.

### CAUTION

- Confirm that the latch lock is correctly in place. If you carry your computer without the latch lock in place, the battery pack may fall out.
- Before using the battery pack, carefully read “Precautions (Battery Pack)” (page 7-8).

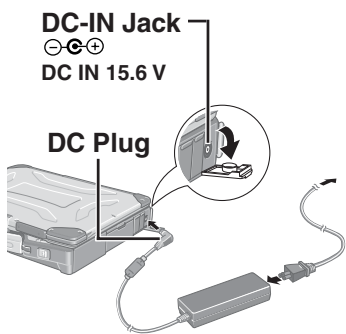

## 4 Connect your computer to a power outlet.

### CAUTION

- Be sure the AC adaptor is connected until completing the first-time use operation.
- When using the computer for the first time, do not connect any peripheral device except the battery pack and AC adaptor to the computer.

#### Handling the AC adaptor

- Do not twist or pull the AC power cord forcefully. Doing so may damage the connections.
- Use only the specified AC adaptor with your computer. Using an AC adaptor other than the one supplied might damage the battery and/or the computer.
- When the DC plug is not connected to the computer, disconnect the AC cord from your AC wall outlet.
- Problems such as sudden voltage drops may arise during periods of thunder and lightning. Since this could adversely affect your computer, an uninterruptible power source (UPS) is highly recommended unless the battery pack is installed.

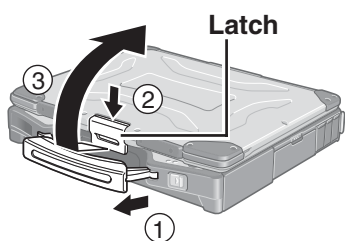

## 5 Open the display.

- Pull the carrying handle forward.
- Press the latch as illustrated.
- Lift up the latch and open the display.

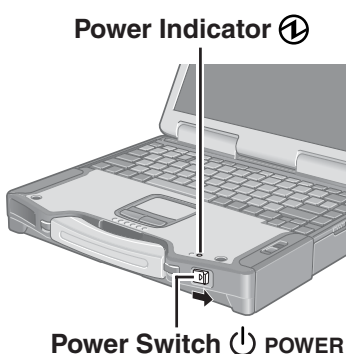

## 6 Turn your computer on.

Slide the power switch and hold it for approximately one second until the power indicator turns on before releasing it.

### CAUTION

- Do not slide the power switch and hold it for more than four seconds; this will cause the power to be turned off forcibly.
- Do not slide the power switch repeatedly.
- Once the computer is powered off, you must wait at least ten seconds before powering it on again.



## 7 Setup Windows.

Moving the cursor (⤵) or clicking buttons can be performed with the touch pad.

### NOTE

- The touchscreen does not work properly during the Windows setup.

### CAUTION

- Do not press any keys or touch the touch pad until [Windows XP Professional Setup] is displayed.

- ① At [Welcome to the Windows XP Setup Wizard], select [Next].
- ② After reading the agreement, select [I accept this agreement] or [I don't accept this agreement], then select [Next].

### NOTE

- If [I don't accept this agreement] is selected, the Windows setup will be aborted.

- ③ Select settings for your region, then select [Next].
- ④ Enter your name and organization and then select [Next].
- ⑤ Enter your computer name and administrator password and then select [Next].



### CAUTION

- Remember this password! If the password is forgotten, Windows cannot be operated.

- ⑥ Enter the correct date, time and time zone, then select [Next].  
The computer will restart.

### NOTE

- It may take some time before the computer restarts and the screen of step ⑦ is displayed. Wait, and do not press any keys, or touch the touch pad, etc.

- ⑦ Enter your administrator password and select .  
Wait until the hard disk drive indicator () has turned off.

### NOTE

- When Windows setup is completed, the following message will be displayed at the bottom right of the screen: "Your computer might be at risk." Continue to the next step.  
The message is generated by the [Security Center] function in [Control Panel], and does not indicate an error or malfunction. For more information about [Security Center]:  page 22.

## 8 <Only for models with touchscreen> Calibrate the touchscreen.

- ① Select [start] - [Control Panel] - [Printers and Other Hardware] - [Mouse] - [TouchScreen] - [Calibration].
- ② Touch the "+" mark on the calibration screen with the stylus (included) for about one second.
- ③ After the calibration procedure is executed (e.g., after the nine "+" marks are touched), the procedure ends when **Enter** is pressed.
- ④ Select [OK].

## 9 Create a new account.

- ① Select [start] - [Control Panel] - [User Accounts] - [Create a new account].
- ② Enter a name for the new account, then select [Next].
- ③ Select [Computer administrator], then select [Create Account].
- ④ <When you want to create a password for the new account>  
Select the new account you have created and select [Create a password].  
Follow the instructions on the screen to create a password.
- ⑤ Select [start] - [Turn Off Computer] - [Restart] to restart the computer.

### CAUTION

- Remember this password! If the password is forgotten, Windows cannot be operated. You can create a password reset disk beforehand (☞ page 15).

### NOTE

- **When creating a new user account:**
  - If you make mail settings, create password reset disks (☞ page 15), or conduct other related operations before creating the user account, you will be unable to use any previous mail history or settings.
  - When you create the first new account, you can only select [Computer administrator]. Once a “Computer Administrator” account has been created, you can create additional limited user accounts.  
Note also that only the added user account will be displayed in the Welcome screen. The account for the administrator created during Windows setup will not be displayed.
- The message “Your computer might be at risk,” which is displayed at the bottom right of the screen, is generated by the “Security Center” function in Windows XP, and does not indicate an error or malfunction.  
To prevent this message from being displayed, select  (red icon) on the taskbar, then select [Turn on Automatic Updates].
- **About the Icon Enlarger:**
  - If the characters or icons on the screen are too small and difficult to see, after completing step 9, select [start] - [All Programs] - [Panasonic] - [Icon Enlarger]. This will allow you to magnify the display of characters and icons on the screen.
  - The [Icon Enlarger] can be set separately for each account.
- You can also use [Loupe Utility], which enlarges a part of the screen. (☞ Reference Manual “Loupe Utility”)  
<Only for models with wireless LAN>
- If you use the wireless LAN, be sure to refer to the Reference Manual’s “Wireless LAN”.

**This concludes the first-time use operation guidelines.**

## Information for Windows XP

- Depending on the Windows settings, installed applications, and drivers, menus and other displays may differ, or some functions (such as use of the password reset disk) may be inoperable. Check with your system administrator for details.
- You can select Classic view for the Control Panel or select the Classic Start menu. You can also change the way a user logs on or off.  
The procedure in this manual uses the method or view of the Windows XP default setting (not Classic view or Classic Start menu etc.).
- **Resetting the password**  
Windows XP has a function to reset a forgotten password.  
To use this function, you need to create a password reset disk beforehand following the steps below.
  - 1 Select [start] - [Control Panel] - [User Accounts].
  - 2 Select [Prevent a forgotten password] from the [Related Tasks] menu of the account you have logged on to, and create a password reset disk following the on-screen instructions.  
Store the password reset disk in a safe place.
    - Only the logon password for each account can be reset.  
The password set in the Setup Utility ( Reference Manual “Setup Utility”) cannot be reset.