



Panasonic®

Personal Computer

OPERATING INSTRUCTIONS

Model No. **CF-51** series

XP

Contents

Getting Started

Read Me First	3
Names and Functions of Parts	9
First-time Operation	11

Getting Started

Operation

Starting Up/Shutting Down	15
Touch Pad	18
Reference Manual	19
Useful Information	20

Operation

Troubleshooting

List of Error Codes	24
Dealing with Problems (Summary)	25
Reinstalling Software	29

Troubleshooting

Appendix

LIMITED USE LICENSE AGREEMENT	31
Hard Disk Data Erase Utility	33
Specifications	34
LIMITED WARRANTY	37

Appendix

[Additional Manual]

Reference Manual

This manual can be accessed on your computer.

Refer to "Reference Manual" on how to access the Reference Manual.

(→ page 19)

Customer's Record

Model No.*¹	Dealer's Name
Serial No.	
or	
Code No.	Dealer's Address
Date of Purchase	

*¹ For the Model No., insert the 12 digit number (for example, CF-51GAKBAKM) located on the bottom of the computer.

Introduction

Thank you for purchasing the Panasonic computer. Read the operating instructions thoroughly for proper operation of your new computer.

Illustrations and Terminology in this Manual

NOTE	NOTE provides a useful fact or helpful information.
CAUTION	CAUTION indicates a condition that may result in minor or moderate injury.
Enter	This illustration means to press the [Enter] key.
Fⁿ + F⁵	This illustration means to press and hold the [Fn] key, then press the [F5] key.
[start] - [Run]	This illustration means to click [start], then to click [Run]. For some applications, you may need to double-click.
→ or ⇒	These symbols indicated related pages. ➔ : Refer to the page in this Operating Instructions ⇒ : Refer to the Reference Manual

- Some of the illustrations in this manual may differ slightly in shape from the actual items in order to make the explanation easier to understand.
- If the user has logged on without the administrator authority, some functions may not be executable, and some screens may be not displayed as shown in this manual.
If this happens, log on with the administrator authority to enable these functions.
- Confirm the latest information on optional products in catalogs, etc.
- In this manual, "Microsoft® Windows® XP Professional" is indicated as "Windows" or "Windows XP".
- In this manual, the following software packages are described as follows:
 "WinDVD™ 5 (OEM Version)" as "WinDVD"
 "B's Recorder GOLD7 BASIC" as "B's Recorder"
 "B's CLiP 5" as "B's CLiP"
- The following drives may be described as "CD/DVD drive".
 DVD-ROM & CD-R/RW drive, DVD MULTI drive
- Circular media such as DVD-ROM and CD-ROM are described as "discs".

Copyright

This manual is copyrighted by Matsushita Electric Industrial Co., Ltd. with all rights reserved. No part of this manual may be reproduced in any form without the prior written permission of Matsushita Electric Industrial Co., Ltd.

No patent liability is assumed with respect to the use of the information contained herein.

©2004 Matsushita Electric Industrial Co., Ltd. All Rights Reserved.

Disclaimer

Computer specifications and manuals are subject to change without notice. Matsushita Electric Industrial Co., Ltd. assumes no liability for damage incurred directly or indirectly from errors, omissions or discrepancies between the computer and the manuals.

Trademarks

Microsoft®, Windows® and the Windows logo are registered trademarks of Microsoft Corporation of the United States and/or other countries.

PS/2® is a registered trademark of International Business Machines Corporation.

Intel, Pentium and PROSet are either registered trademarks or trademarks of Intel Corporation.

Adobe® and Acrobat® are either registered trademarks or trademarks of Adobe Systems Incorporated in the United States and/or other countries.

WinDVD™ is a trademark of InterVideo, Inc.

Panasonic® is a registered trademark of Matsushita Electric Industrial Co., Ltd.

Names of products, brands, etc., appearing in this manual are trademarks or registered trademarks of their respective own companies.

Read Me First

For U.S.A.

Federal Communications Commission Radio Frequency Interference Statement

Note: This equipment has been tested and found to comply with the limits for a Class B digital device, pursuant to Part 15 of the FCC Rules. These limits are designed to provide reasonable protection against harmful interference in a residential installation. This equipment generates, uses and can radiate radio frequency energy and, if not installed and used in accordance with the instructions, may cause harmful interference to radio communications. However, there is no guarantee that interference will not occur in a particular installation. If this equipment does cause harmful interference to radio or television reception, which can be determined by turning the equipment off and on, the user is encouraged to try to correct the interference by one or more of the following measures:

- Reorient or relocate the receiving antenna.
- Increase the separation between the equipment and receiver.
- Connect the equipment into an outlet on a circuit different from that to which the receiver is connected.
- Consult the Panasonic Service Center or an experienced radio/TV technician for help.

Warning

To assure continued compliance, use only shielded interface cables when connecting to a computer or peripheral. Also, any changes or modifications not expressly approved by the party responsible for compliance could void the user's authority to operate this equipment.

This device complies with Part 15 of the FCC Rules. Operation is subject to the following two conditions:
(1) This device may not cause harmful interference, and
(2) This device must accept any interference received, including interference that may cause undesired operation.

Responsible Party:

Matsushita Electric Corporation of America
One Panasonic Way Secaucus, NJ 07094
Tel No: 1-800-LAPTOP-5 (1-800-527-8675)

FCC RF Exposure Warning:

This equipment complies with FCC radiation exposure limits set forth for an uncontrolled environment. This equipment must be installed and operated in accordance with provided instructions and minimum 1.5 cm spacing must be provided between antenna and all person's body (excluding extremities of hands, wrist and feet) during wireless modes of operation. This transmitter must not be co-located or operated in conjunction with any other antenna or transmitter. This computer is provided with a PC Card slot that could be used with wireless transmitter(s), which will be specifically recommended, when they become available. Other third-party wireless transmitter(s) have not been RF exposure evaluated for use with this computer and may not comply with FCC RF exposure requirements.

FCC Regulation Notice for modem

This equipment contains a FCC approved modem.

Manufacturer of modem: PC TEL Inc.

Model No. PCT2304WT

FCC Tested To Comply
With FCC Standards
FOR HOME OR OFFICE USE

1. This equipment complies with CFR47 Part 68 rules. On the computer is a label that contains, among other information, the FCC registration number and ringer equivalence number (REN) for this equipment. If required, this information must be provided to the telephone company.
2. An FCC compliant telephone cord and modular plug is provided with this equipment. This equipment is designed to be connected to the telephone network or premises wiring using a compatible modular jack which is Part 68 compliant. See Installation Instructions for details.
3. The REN is used to determine the quantity of devices which may be connected to the telephone line. Excessive RENs on the telephone line may result in the devices not ringing in response to an incoming call. In most, but not all area, the sum of RENs should not exceed five (5.0). To be certain of the number of devices that may be connected to a line, as determined by the total RENs, contact the local telephone company.
4. If your telephone equipment cause harm to the telephone network, the telephone company will notify you in advance that temporary discontinuance of service may be required. But if advance notice isn't practical, the telephone company will notify the customer as soon as possible. Also, you will be advised of your right to file a complaint with the FCC if you believe it is necessary.
5. The telephone company may take changes in its facilities, equipment, operations or procedures that could affect the operation of the equipment. If this happens the telephone company will provide advance notice in order for you to make necessary modifications to maintain uninterrupted service.
6. If trouble is experienced with this equipment, for repair or warranty information, please contact Matsushita Electric Corporation of America at DIAL TOLL FREE 1-800-LAPTOP5 (1-800-527-8675). If the equipment is causing harm to the telephone network, the telephone company may request that you disconnect the equipment until the problem is resolved.
7. There are no user serviceable parts contained in this equipment.
8. This equipment may not be used on coin service provided by the telephone company. Connection to party lines is subject to state tariffs.
9. The Telephone Consumer Protection Act of 1991 makes it unlawful for any person to use a computer or other electronic device to send any message via a telephone fax machine unless such message clearly

Read Me First

contains in a margin at the top or bottom of each transmitted page or on the first page of the transmission, the date and time it is sent and an identification of the business or other entry, or other individual sending the message and the telephone number of the sending machine or such business, other entity, or individual. In order to program this information into your fax software, you should refer to the manual of the Fax software being used.

10. According to the FCC's electrical safety advisory, we recommend that you may install an AC surge arrester in the AC outlet to which this equipment is connected. Telephone companies report that electrical surges, typically lightning transients, are very destructive to

customer terminal equipment connected to AC power sources and that this is a major nationwide problem.

"Caution: To reduce the risk of fire, use only No.26 AWG or larger telecommunication line cord."

"ATTENTION: Pour réduire le risque d'incendie, utiliser uniquement des conducteurs de télécommunications 26 AWG ou de section supérieure."

Notice for the products using LCD

This product uses one or more fluorescent lamps containing a small amount of mercury. It also contains lead in some components. Disposal of these materials may be regulated in your community due to environmental considerations. For disposal or recycling information please contact your local authorities, or the Electronics Industries Alliance: <<http://www.eiae.org/>>

For Canada

Industry Canada (IC) Notice for modem

This equipment contains an Industry Canada approved modem unit.

The Industry Canada label is affixed on the modem unit.

EQUIPMENT ATTACHMENT LIMITATIONS

"NOTICE: The Industry Canada label identifies certified equipment. This certification means that the equipment meets telecommunications network protective, operational and safety requirements as prescribed in the appropriate Terminal Equipment Technical Requirements document(s). The Department does not guarantee the equipment will operate to the user's satisfaction. Before installing this equipment, users should ensure that it is permissible to be connected to the facilities of the local telecommunications company. The equipment must also be installed using an acceptable method of connection. The customer should be aware that compliance with the above conditions may not prevent degradation of service in some situations.

Repairs to certified equipment should be coordinated by a representative designated by the supplier. Any repairs or alterations made by the user to this equipment, or equipment malfunctions, may give the telecommunications company cause to request the user to disconnect the equipment.

Users should ensure for their own protection that the electrical ground connections of the power utility, telephone lines and internal metallic water pipe system, if present, are connected together. This precaution may be particularly important in rural areas. Caution: Users should not attempt to make such connections themselves, but should contact the appropriate electric inspection authority, or electrician, as appropriate."

"NOTICE: The Ringer Equivalence Number (REN) assigned to each terminal device provides an indication of the maximum number of terminals allowed to be connected to a telephone interface. The termination on an interface may consist of any combination of devices subject only to the requirement that the sum of the Ringer Equivalence Numbers of all the devices does not exceed 5."

REN: See bottom of the computer

RESTRICTIONS CONCERNANT LE RACCORDEMENT DE MATÉRIEL

"AVIS: L'étiquette d'Industrie Canada identifie le matériel homologué. Cette étiquette certifie que le matériel est conforme aux normes de protection, d'exploitation et de sécurité des réseaux de télécommunications, comme le prescrivent les documents concernant les exigences techniques relatives au matériel terminal. Le Ministère n'assure toutefois pas que le matériel fonctionnera à la satisfaction de l'utilisateur.

Avant d'installer ce matériel, l'utilisateur doit s'assurer qu'il est permis de le raccorder aux installations de l'entreprise locale de télécommunication. Le matériel doit également être installé en suivant une méthode acceptée de raccordement. L'abonné ne doit pas oublier qu'il est possible que la conformité aux conditions énoncées ci-dessus n'empêche pas la dégradation du service dans certaines situations.

Les réparations de matériel homologué doivent être coordonnées par un représentant désigné par le fournisseur. L'entreprise de télécommunications peut demander à l'utilisateur de débrancher un appareil à la suite de réparations ou de modifications effectuées par l'utilisateur ou à cause de mauvais fonctionnement.

Pour sa propre protection, l'utilisateur doit s'assurer que tous les fils de mise à la terre de la source d'énergie électrique, des lignes téléphoniques et des canalisations d'eau métalliques, s'il y en a, sont raccordés ensemble. Cette précaution est particulièrement importante dans les régions rurales. Avertissement: L'utilisateur ne doit pas tenter de faire ces raccordements lui-même; il doit avoir recours à un service d'inspection des installations électriques, ou à un électricien, selon le cas."

"AVIS: L'indice d'équivalence de la sonnerie (IES) assigné à chaque dispositif terminal indique le nombre maximal de terminaux qui peuvent être raccordés à une interface. La terminaison d'une interface téléphonique peut consister en une combinaison de quelques dispositifs, à la seule condition que la somme d'indices d'équivalence de la sonnerie de tous les dispositifs n'excède pas 5."

IES: Voir sous le fond de l'ordinateur

Industry Canada

This product complies with RSS210 Industry Canada.

Operation is subject to the following two conditions;

(1) this device may not cause interference, and

(2) this device must accept any interference, including interference that may cause undesired operation of the device.

Important Safety Instructions / Importantes Mesures De Sécurité

When using your telephone equipment, basic safety precautions should always be followed to reduce the risk of fire, electric shock and injury to persons, including the following:

1. Do not use this product near water, for example, near a bath tub, wash bowl, kitchen sink or laundry tub, in a wet basement or near a swimming pool.
2. Avoid using a telephone (other than a cordless type) during an electrical storm. There may be a remote risk of electric shock from lightning.
3. Do not use the telephone to report a gas leak in the vicinity of the leak.
4. Use only the power cord and batteries indicated in this manual. Do not dispose of batteries in a fire. They may explode. Check with local codes for possible special disposal instructions.

SAVE THESE INSTRUCTIONS

Certaines mesures de sécurité doivent être prises pendant l'utilisation de matériel téléphonique afin de réduire les risques d'incendie, de choc électrique et de blessures. En voici quelquesunes:

1. Ne pas utiliser l'appareil près de l'eau, p.ex., près d'une baignoire, d'un lavabo, d'un évier de cuisine, d'un bac à laver, dans un sous-sol humide ou près d'une piscine.
2. Éviter d'utiliser le téléphone (sauf s'il s'agit d'un appareil sans fil) pendant un orage électrique. Ceci peut présenter un risque de choc électrique causé par la foudre.
3. Ne pas utiliser l'appareil téléphonique pour signaler une fuite de gaz s'il est situé près de la fuite.
4. Utiliser seulement le cordon d'alimentation et le type de piles indiqués dans ce manuel. Ne pas jeter les piles dans le feu: elles peuvent exploser. Se conformer aux règlements pertinents quant à l'élimination des piles.

CONSERVER CES INSTRUCTIONS

Information to the User

This product and your Health

This product, like other radio devices, emits radio frequency electromagnetic energy. The level of energy emitted by this product however is far much less than the electromagnetic energy emitted by wireless devices like for example mobile phones.

Because this product operates within the guidelines found in radio frequency safety standards and recommendations, we believe this product is safe for use by consumers. These standards and recommendations reflect the consensus of the scientific community and result from deliberations of panels and committees of scientists who continually review and interpret the extensive research literature.

In some situations or environments, the use of this product may be restricted by the proprietor of the building or responsible representatives of the organization. These situations may for example include:

- Using this product on board of airplanes, or
- In any other environment where the risk of interference to other devices or services is perceived or identified as harmful.

If you are uncertain of the policy that applies on the use of wireless devices in a specific organization or environment (e.g. airports), you are encouraged to ask for authorization to use this product prior to turning on the product.

Regulatory Information

We are not responsible for any radio or television interference caused by unauthorized modification of this product. The correction of interference caused by such unauthorized modification will be the responsibility of the user. We and its authorized resellers or distributors are not liable for damage or violation of government regulations that may arise from failing to comply with these guidelines.

Read Me First

Lithium Battery

Lithium Battery!

This computer contains a lithium battery to enable the date, time, and other data to be stored. The battery should only be exchanged by authorized service personnel.

Warning! A risk of explosion from incorrect installation or misapplication may possibly occur.

Pile au lithium!

Le micro-ordinateur renferme une pile au lithium qui permet de sauvegarder certaines données comme la date et l'heure notamment. Elle ne devra être remplacée que par un technicien qualifié.

Avertissement! Risque d'explosion en cas de non respect de cette mise en garde!

CD/DVD Drive Caution

CAUTION!

THIS PRODUCT UTILIZES A LASER.

USE OF CONTROLS, ADJUSTMENTS OR PERFORMANCE OF PROCEDURES OTHER THAN THOSE SPECIFIED HEREIN MAY RESULT IN HAZARDOUS RADIATION EXPOSURE.

DO NOT OPEN COVERS AND DO NOT REPAIR YOURSELF.

REFER SERVICING TO QUALIFIED PERSONNEL

AVERTISSEMENT!

CET APPAREIL UTILISE UN LASER.

L'UTILISATION DE COMMANDES OU DE RÉGLAGES OU L'EXÉCUTION DE PROCÉDURES AUTRES QUE CELLES SPÉCIFIÉES ICI PEUVENT PROVOQUER UNE EXPOSITION À DES RADIATIONS DANGEREUSES.

NE PAS OUVRIR LES COUVERCLES NI ESSAYER DE RÉPARER SOI-MÊME.

CONFIER TOUT TRAVAIL D'ENTRETIEN À UN PERSONNEL QUALIFIÉ.

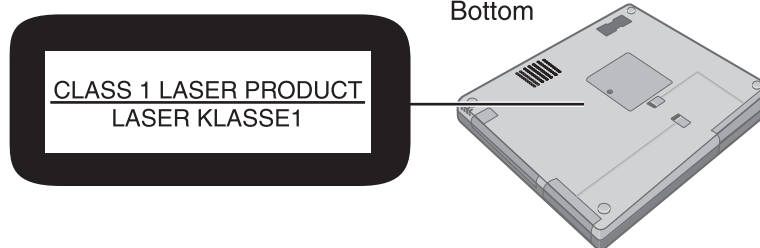

Precautions

■ Usage

Avoid Extreme Heat and Cold

Do not store or use the computer in locations exposed to heat, direct sunlight, or extreme cold.

Avoid moving the computer between locations with large temperature difference.

Operation: 5 °C to 35 °C {41 °F to 95 °F}

Storage: -20 °C to 60 °C {-4 °F to 140 °F}



Avoid Direct Sunlight on the LCD Panel

The LCD panel should not be exposed to direct sunlight or ultraviolet light.



Avoid Humidity, Liquids and Dust

Do not store or use the computer in locations exposed to high humidity, liquids (including rain) or dust.



Prevent Shock

Avoid subjecting the computer to severe vibrations or impact. Do not place the computer inside a car trunk.

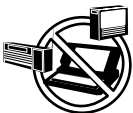

Avoid Radio Frequency Interference

Do not place the computer near a television or radio receiver.



Avoiding low-temperature burns

Avoid more than casual contact with any heat producing area of the notebook computer, AC adaptor, and any option or accessory you use with it. Even low heat, if warmer than body temperature, can cause a burn, if the skin is exposed to the heat source for a long enough period of time.

■ Handling



Avoid Magnetic Fields

Keep the computer away from magnets. Data stored on the hard disk may be lost.



Avoid Stacking

Do not place heavy objects on top of the computer.



Keep Small Objects Away

Do not insert paper clips or other small objects into the computer.



Do Not Disassemble the Computer

Do not attempt to disassemble your computer.



Avoid Excessive Force on the Display

Do not apply excessive downward force on the display when it is completely opened, especially when plugs and/or cables are connected to the rear of the computer.

Precautions (Battery Pack)

- Care should be exercised with regard to the following in order to avoid the possibility of overheating, fire or damage.



Avoid Heat

Do not throw the battery pack into a fire or expose it to excessive heat.



Keep Articles Away

Do not place the battery pack together with articles such as necklaces or hairpins when carrying or storing.



Do Not Disassemble

Do not insert sharp objects into the battery pack, expose it to bumps or shocks, deform, disassemble, or modify it.



Do Not Short

Do not short the positive (+) and negative (-) contacts.



Avoid Extreme Heat, Cold and Direct Sunlight

Do not charge, use or leave the battery pack for extended periods where it will be exposed to direct sunlight, in a hot place (in a car on a sunny day, for example), or in a cold place.



Do Not Use With Any Other Computer

The battery pack is rechargeable and was intended for the specified computer. Do not use it with a computer other than the one for which it was designed.



Do Not Put into a Microwave

Do not put the battery pack into a microwave oven or a pressurized chamber.



Stop Using

Should the battery emit an abnormal odor, become hot to the touch, become discolored, change shape, or become in any way different from normal, remove it from the computer and stop using it.

Read Me First

- Do not touch the terminals on the battery pack. The battery pack may no longer function properly if the contacts are dirty or damaged.
- Do not expose the battery pack to water, or allow it to become wet.
- If the battery pack will not be used for a long period of time (a month or more), charge or discharge (use) the battery pack until the remaining battery level becomes 30% to 40% and store it in a cool, dry place.
- This computer prevents overcharging of the battery by recharging only when the remaining power is less than approx. 95% of capacity.
- The battery pack is not charged when the computer is first purchased. Be sure to charge it before using it for the first time. When the AC adaptor is connected to the computer, charging begins automatically.
- Should the battery leak and the fluid get into your eyes, do not rub your eyes. Immediately flush your eyes with clear water and see a doctor for medical treatment as soon as possible.

NOTE

- The battery pack may become warm during recharging or normal use. This is completely normal.
- Recharging will not commence outside of the allowable temperature range (0 °C to 50 °C {32°F to 122°F}) (⇒ *Reference Manual* “Battery Power”). Once the allowable range requirement is satisfied, charging begins automatically. Note that the recharging time varies based on the usage conditions. (Recharging takes longer than usual when the temperature is 10 °C {50°F} or less.)
- If the temperature is low, the operating time is shortened. Only use the computer within the allowable temperature range.
- The battery pack is a consumable item. If the amount of time the computer can be run off a particular battery pack becomes dramatically shorter and repeated recharging does not restore its performance, the battery pack should be replaced with a new one.
- When transporting a spare battery inside a package, briefcase, etc., it is recommended that it be placed in a plastic bag so that its contacts are protected.
- Always power off the computer when it is not in use. Leaving the computer on when the AC adaptor is not connected will exhaust the remaining battery capacity.

Names and Functions of Parts

The illustrations shown may differ from the actual physical appearances.

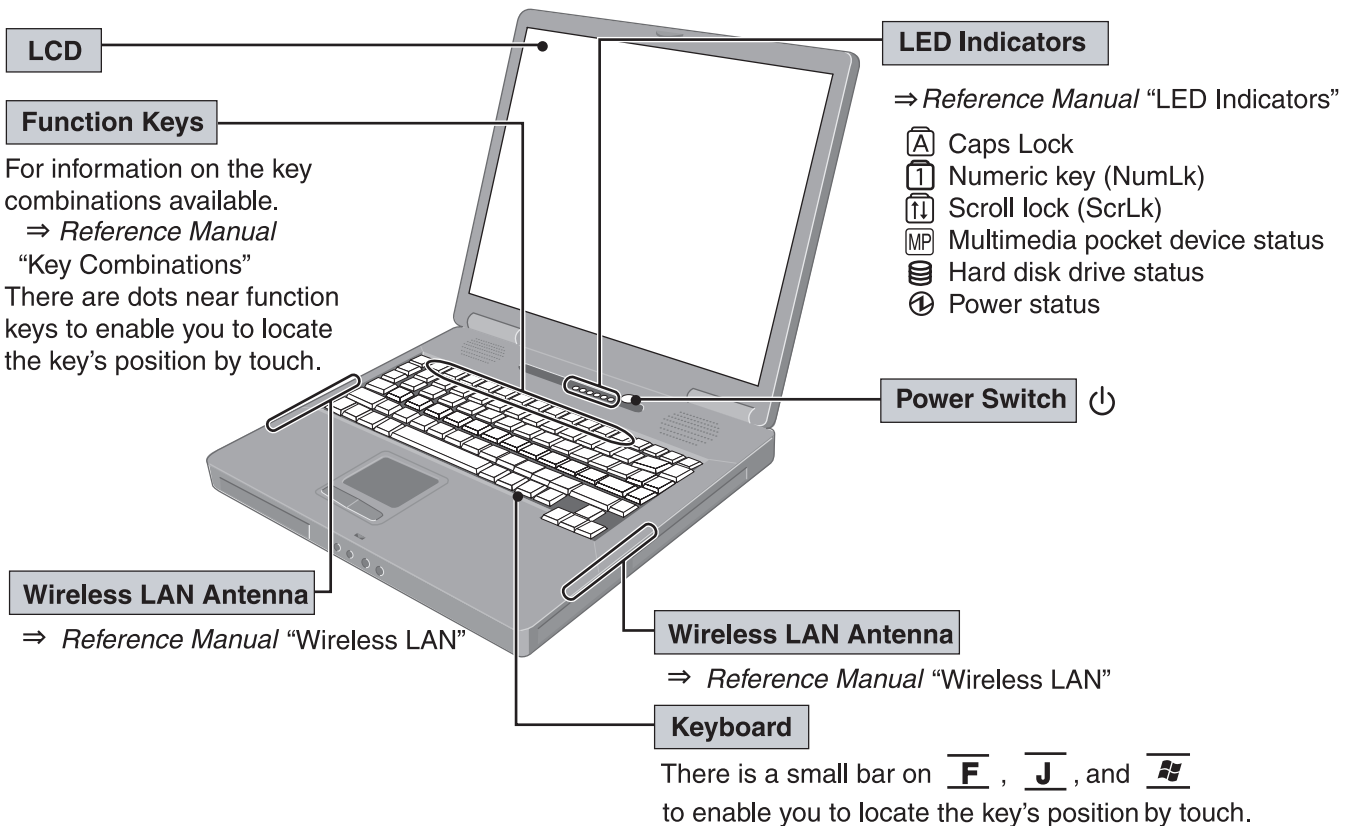

Getting Started

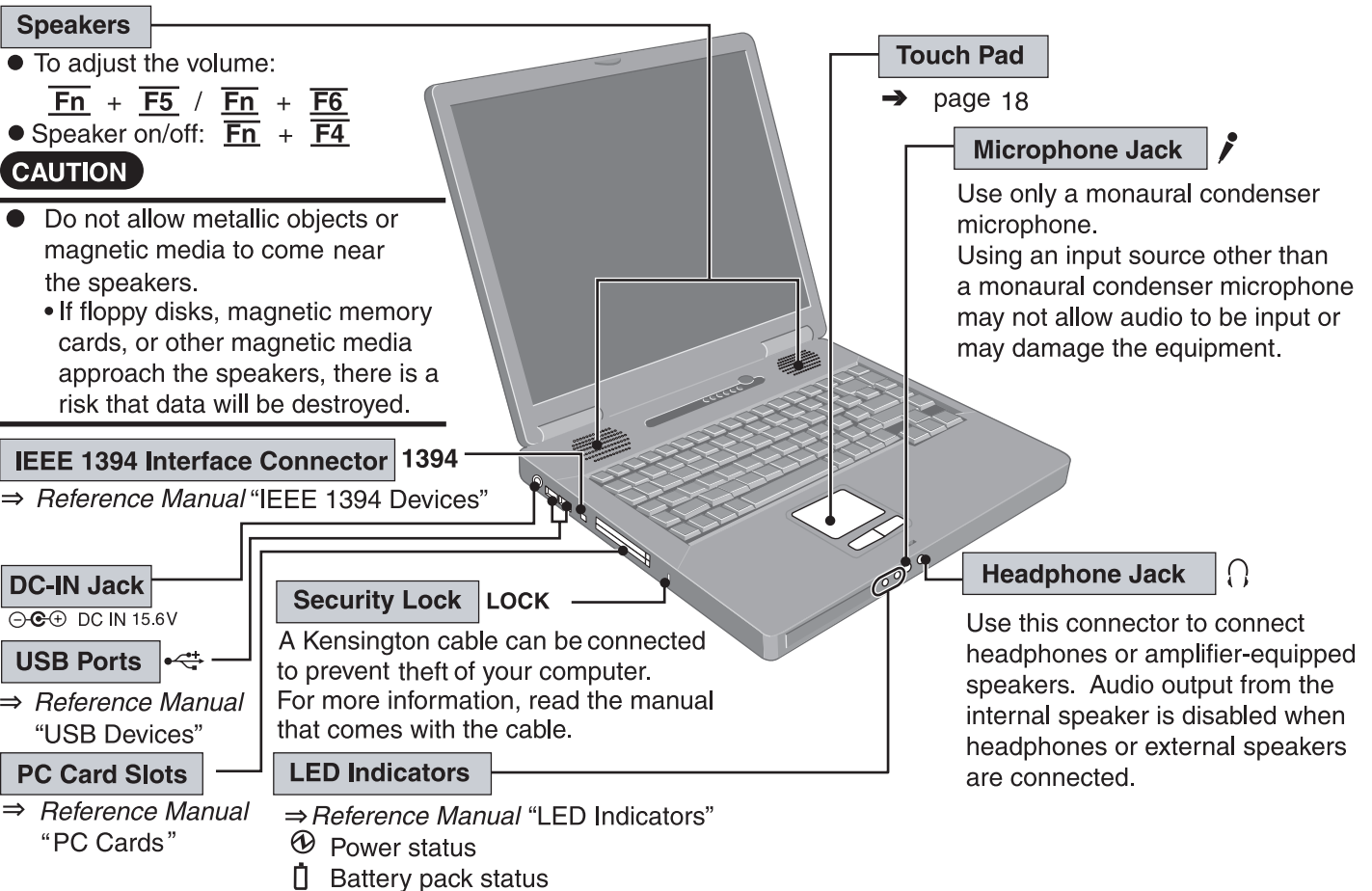

Names and Functions of Parts

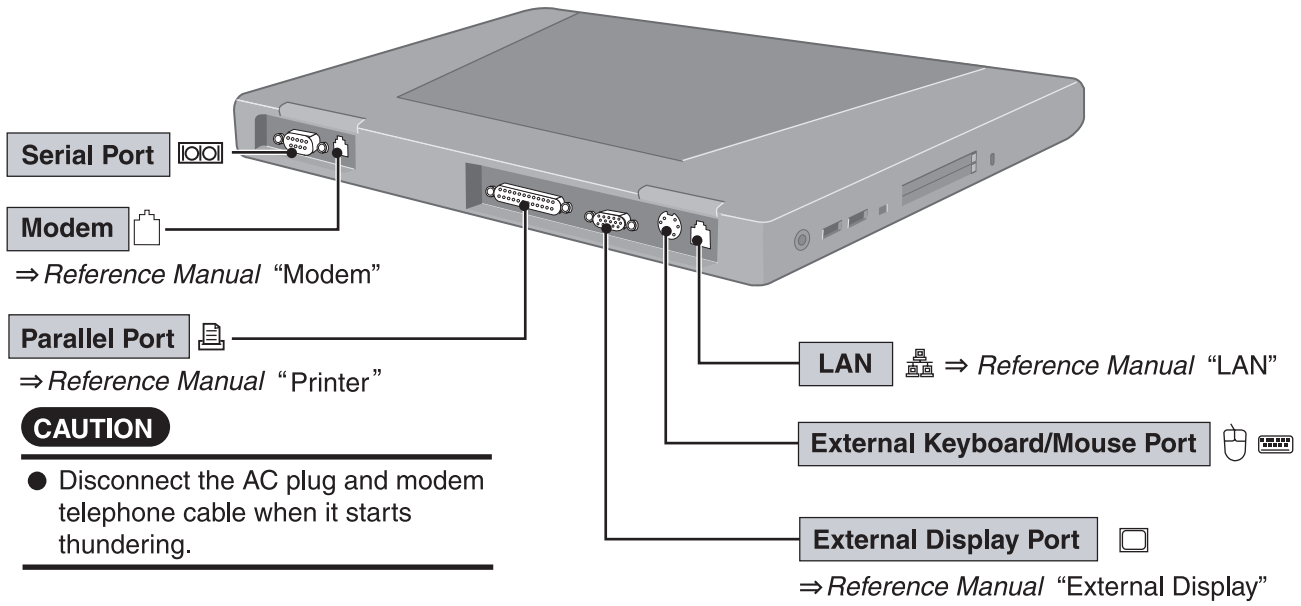

CAUTION

- Disconnect the AC plug and modem telephone cable when it starts thundering.

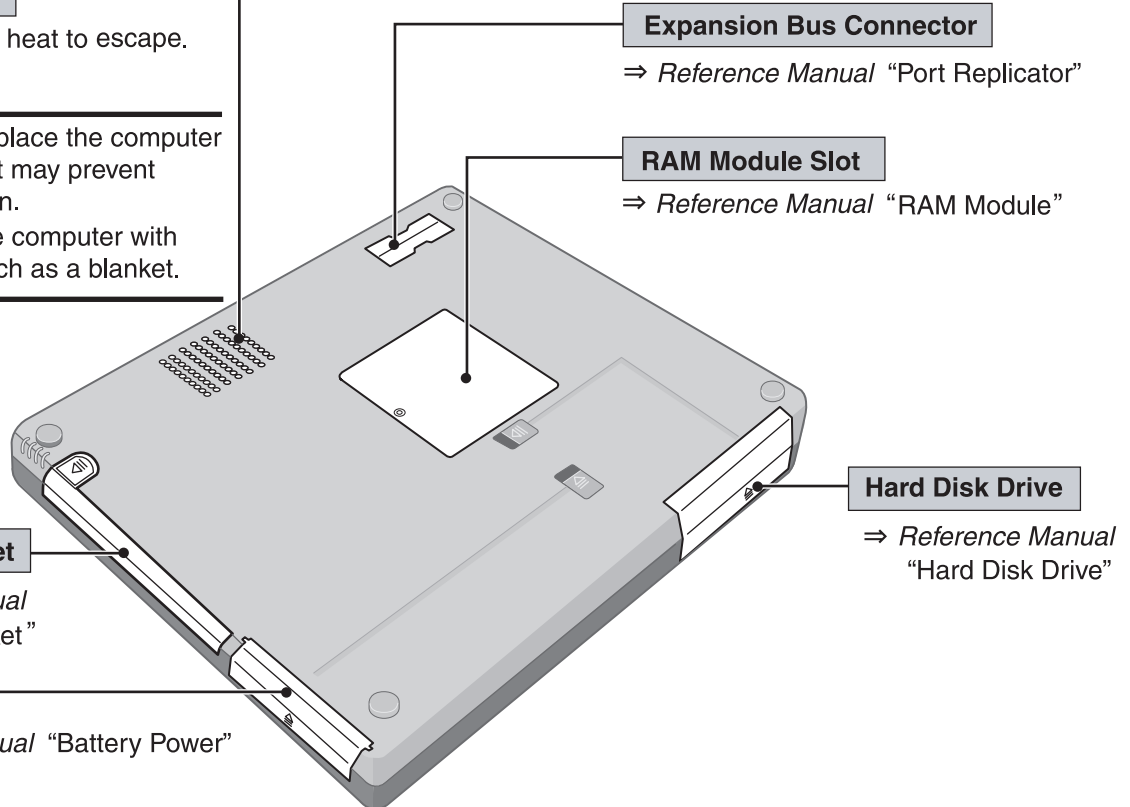
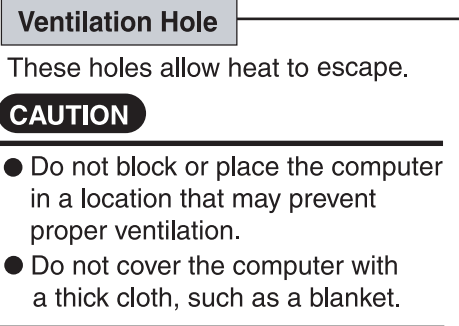

A lithium ion battery that is recyclable powers the product you have purchased. Please call 1-800-8-BATTERY for information on how to recycle this battery.



L'appareil que vous vous êtes procuré est alimenté par une batterie au lithium-ion. Pour des renseignements sur le recyclage de la batterie, veuillez composer le 1-800-8-BATTERY.

First-time Operation

Read the steps below to help you learn what parts are included, and to gain an understanding of some basic computer-related operations.

1 Confirm the inclusion of all parts.

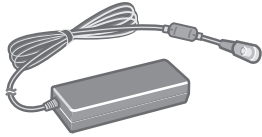
Make sure the parts shown in the figure have been supplied. If any of these items are missing or is not working properly, contact Panasonic Technical Support. (→ page 37)

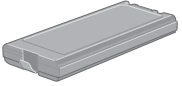
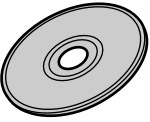
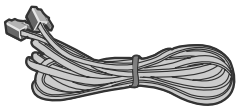
AC adaptor 1	AC Cord 1	Battery Pack 1
		
Model No :CF-AA1653A		Model No : CF-VZSU29
Product Recovery DVD-ROM 1	Modem Telephone Cable 1	Operating Instructions (This book) . . . 1
		Windows® Book 1
		DVD Drive Utility Disc 1

- When installing B's Recorder/B's CLiP with DVD Drive Utility Disc, the serial number is required. Take care not to lose the serial number marked on the sticker that is attached to the CD case.
- Some models include a floppy disk drive.

2 Read the LIMITED USE LICENSE AGREEMENT.(→ page 31)

Be sure to read the LIMITED USE LICENSE AGREEMENT before breaking the seal on the computer's packaging.

3 Insert the battery pack.

- ① Turn your computer over and remove the cover (A).
Slide and remove the cover without releasing the mark ≡ (B).
- ② Insert the battery pack (C).
Firmly attach the pack to the connector.
 - If the battery pack should be removed from the computer, slide the latch (D), and then without releasing it, pull the tab (E) on the battery pack. (→ Reference Manual "Battery Power")
- ③ Slide the cover back into place.
Be sure the tab does not get caught when closing the cover.

CAUTION

- For an improperly attached cover, your battery pack may fall out while you are carrying around your computer.
- Do not touch the terminals on the battery pack and the computer. The battery pack may no longer function properly if the contacts are dirty or damaged. Also, the computer may not operate properly.

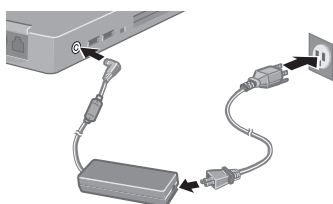
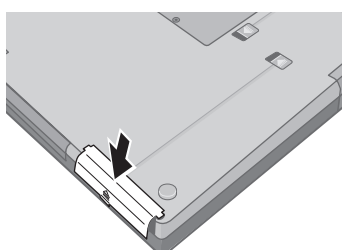
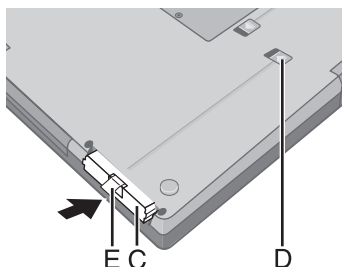
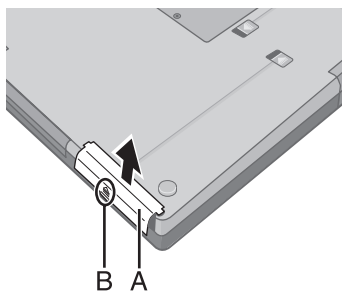

4 Connect your computer to a power outlet.

The battery pack will be charged automatically.
Charging Time: Approx. 3.8 hours
(Varies depending on the usage conditions.)

CAUTION

- Be sure the AC adaptor is connected until completing the first-time use operation.
- When using the computer for the first time, do not connect any peripheral device except the battery pack and AC adaptor to the computer.

Handling the AC adaptor

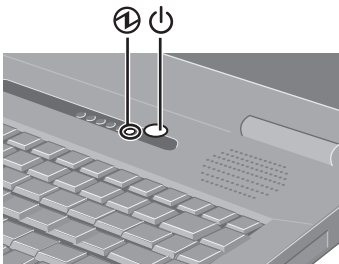
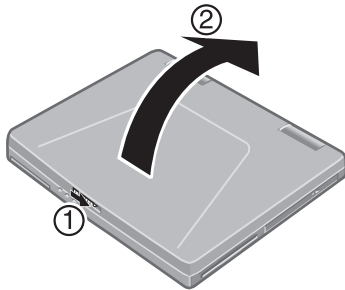

- Do not twist or pull the AC power cord forcefully. Doing so may damage the connections.
- Use only the specified AC adaptor with your computer. Using an AC adaptor other than the one supplied might damage the battery and/or the computer.
- When the DC plug is not connected to the computer, disconnect the AC cord from your AC wall outlet.
- Problems such as sudden voltage drops may arise during periods of thunder and lightning. Since this could adversely affect your computer, an uninterruptible power source (UPS) is highly recommended unless running from the battery pack alone.



5 Open the display.

- ① Slide the latch located at the front.
- ② Lift open the display.

6 Turn your computer on.

Press the power switch  and hold it for approximately one second until the power indicator  turns on before releasing it.

- Do not press the power switch repeatedly.
- Once the computer is powered off, you must wait at least ten seconds before powering it on again.

7 Setup Windows.

Moving the cursor  or clicking buttons can be performed with the touch pad. (→ page 18)

- Do not press any key or move the touch pad until [Windows XP Professional Setup] is displayed.
- ① At [Welcome to the Windows XP Setup Wizard], select [Next].
 - ② After reading the agreement, select [I accept this agreement] or [I don't accept this agreement], then select [Next].
 - If [I don't accept this agreement] is selected, the Windows setup will be aborted.
 - ③ Select settings for your region, then select [Next].
 - ④ Enter your name and organization and then select [Next].
 - ⑤ Enter your computer name and administrator password and then select [Next].
 - Remember this password! If the password is forgotten, Windows cannot be operated.
 - ⑥ Enter the correct date, time and the time zone, then select [Next]. The computer will restart.
 - It may take some time before the computer restarts and the screen of step ⑦ is displayed. Wait, and do not press any keys, or touch the touch pad, etc.
 - ⑦ Enter your administrator password and select .

8 Create a new account.

- ① Select [start] - [Control Panel] - [User Accounts] - [Create a new account].
- ② Enter a new name for the new account, then select [Next].

- ③ Select [Computer administrator], then select [Create Account].
- ④ <When you want to create a password for the new account> Select the new account you have created and select [Create a password]. Follow the instructions on the screen to create a password.
- ⑤ Select [start] - [Turn Off Computer] - [Restart] to restart the computer.

CAUTION

- Remember this password! If the password is forgotten, Windows cannot be operated. You can create a password reset disk beforehand (→ page 14).

NOTE

- When creating a new user account:
 - If you make mail settings, create password reset disks (→ page 14), or conduct other related operations before creating the user account, you will be unable to use any previous mail history or settings.
 - When you create the first new account, you can only select [Computer administrator].

Once a “Computer Administrator” account has been created, you can create additional limited user accounts.

Note also that only the added user account will be displayed in the Welcome screen. The account for the administrator created during Windows setup will not be displayed.
- About the Icon Enlarger:
 - If the characters or icons on the screen are too small and difficult to see, after completing step 8, select [start] - [All Programs] - [Panasonic] - [Icon Enlarger]. This will allow you to magnify the display of characters and icons on the screen.
 - The [Icon Enlarger] can be set separately for each account.

9 Start up Windows® Media Player.

Log on with the administrator authority, and select  on the screen.

After this, start up the application following the instructions on the screen.

- During this process, you will be required to agree to the license agreement. For Windows® Media Player, it is necessary to agree to the license agreement for each account created.
- If [I Decline] is selected or a window is closed without any decision being made in the license agreement, no icons on the desktop may be selected. In this case, restart the computer.
- To have DVD video and MPEG files played back automatically on WinDVD, start up Windows® Media Player, select [Tools] - [Options], and then remove the check mark from [DVD Video] and [Movie file (mpeg)] in [File Types] on the screen shown at left.
- After completing the settings, select  on the screen of the Windows® Media Player.



NOTE

- If you use the wireless LAN, be sure to refer to the Reference Manual's “Wireless LAN”.

This concludes the first-time use operation guidelines.

Information for Windows XP

- Depending on the Windows settings, installed applications, and drivers, menus and other displays may differ, or some functions (such as use of the password reset disk) may be inoperable. Check with your system administrator for details.
- You can select Classic view for the Control Panel or select the Classic Start menu. You can also change the way a user logs on or off. The procedure in this manual uses the method or view of the Windows XP default setting (not Classic view or Classic Start menu etc.).

■ Resetting the password

Windows XP has a function to reset a forgotten password.

To use this function, you need to create a password reset disk beforehand following the steps below.

- ① Insert the floppy disk drive into the multimedia pocket, or connect the USB floppy disk drive (optional: CF-VF DU03) to your computer.
- ② Select [start] - [Control Panel] - [User Accounts].
- ③ Select [Prevent a forgotten password] from [Related Tasks] menu of the account you used to logon and create a password reset disk following the on-screen instructions.

Store the password reset disk in a safe place.

- Only the logon password for each account can be reset. The password set in the Setup Utility (⇒ *Reference Manual* “Setup Utility”) cannot be reset.

Starting Up/Shutting Down

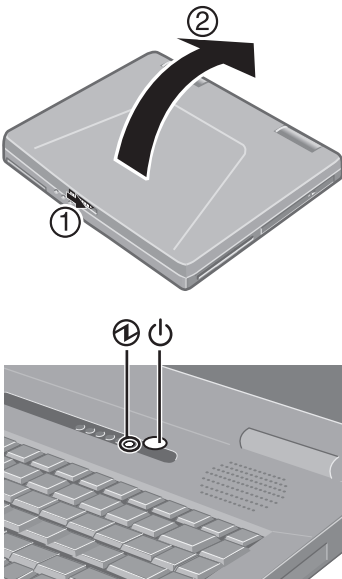

Starting Up



1 Open the display.

- ① Slide the latch located at the front.
- ② Lift open the display.

2 Turn your computer on.

Press the power switch  and hold it for approximately one second until the power indicator  turns on before releasing it.

- While booting, avoid the following until the hard disk drive indicator  has turned off.
 - Connecting or disconnecting the AC adaptor.
 - Touching the power switch.
 - Performing any keyboard or touch pad or external mouse operations.
 - Closing the display.
- Once the computer is powered off, you must wait at least ten seconds before powering it on again.

3 Log on to Windows.

Wait for 10 seconds after confirming that the hard disk access has been completed, select the user and input the password, then select . Until the correct password is entered, the computer will not operate.

4 Select your application.

You are able to start working on your computer.

NOTE

- The power saving function is factory set, so if there is no input from a key, the touch pad or an external mouse (when one is connected) for a certain interval of time, the power to the LCD and hard disk may be turned off. The LCD will resume operation when the touch pad or an external mouse (when one is connected) is used or a key is pressed.

The power to the LCD may be turned off even when an application software is being installed. In this case, because it is conceivable that a selection dialog box will be shown, do not press **Space** or **Enter** to attempt to resume from this condition as doing so may trigger a selection, but instead, press a key unrelated to the direct triggering of a selection, like **Ctrl**.

In addition, when the computer is left alone, it automatically enters the standby or hibernation mode. The computer will resume by pressing the power switch. (⇒ *Reference Manual* “Standby/Hibernation Functions”)
- When the CPU temperature rises, the computer may not power on to prevent the CPU from overheating. Should this happen, allow the computer to cool down then switch the power on again.

If the computer still does not power on, contact Panasonic Technical Support (→ page 37).

Starting Up/Shutting Down

- You may encounter the following situations when the computer is turned on at very low temperatures. These functions are designed to prevent hard disk drive malfunctions that may occur at low temperatures.

Situation	Action
The computer turns on, and the message "Warming up the system (up to 20 minutes)" is displayed.	The computer is warming up before start up. Wait for the computer to start up (takes up to 20 minutes). However, the computer may fail to warm up and the message "Cannot warm up the system" will be displayed, and the computer will not start. If this happens, turn off the computer, leave it in an environment with a temperature of 5°C {41°F} or more for about an hour, and then try turning the power on once more.
<ul style="list-style-type: none"> The computer does not turn on. The computer does not resume operation from standby or hibernation mode. (The power indicator blinks quickly in green.)	Leave it in an environment with a temperature of 5 °C {41 °F} or more for about an hour, then try turning the power on once more.

Enter Password []

■ If the screen on the left is displayed immediately after you turn on the power...

A password has been set to ensure the computer's security.

Enter your password^{*1} and press **Enter**. (⇒ *Reference Manual* "Security Measures")

- When the correct password is input, the computer will start.
- When three incorrect password attempts or nothing is input for one minute, the computer will power off.

^{*1} Supervisor Password or User Password set in the Setup Utility (not the Windows password).

Shutting Down (power off your computer)

- 1 Save important data and close each application.**
- 2 Select [start] - [Turn Off Computer].**
- 3 Select [Turn Off].**

Your computer will power off automatically.

 - Restarting your computer (without shutting down):
Select [Restart].

■ To shut down using the keyboard:

Press , U, and select [Turn Off] with U.

CAUTION

- Do not do the following during the shutdown/restart procedure.
 - Connecting or disconnecting the AC adaptor.
 - Touching the power switch.
 - Performing any keyboard, touch pad or external mouse operations.
 - Closing the display.

NOTE

- To quickly resume computer operation after shutting down, The standby or hibernation function is available (⇒ *Reference Manual* “Standby/Hibernation Functions”).

■ When you leave the computer or interrupt your work...

If you use the "Standby" or "Hibernation" function, then when you turn on the power next time, the application software and files you were using before will be displayed, and you can restart the same operations immediately. (⇒ *Reference Manual* “Standby/Hibernation Functions”)

Touch Pad

Use the touch pad to move the cursor on the screen and perform computer operations.

- A. Work Surface (Touch Pad)
- B. Left Button
- C. Right Button

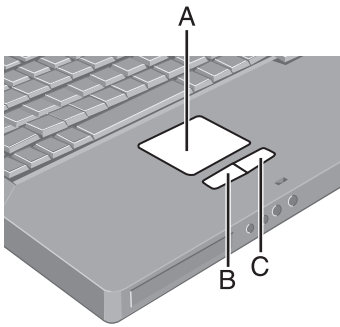

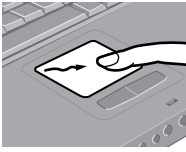
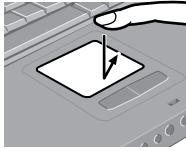
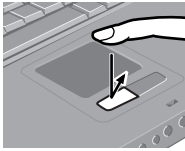
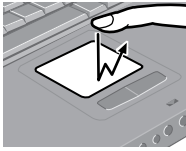
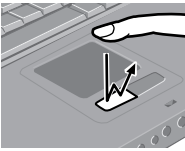
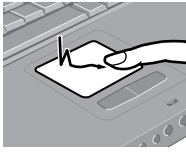
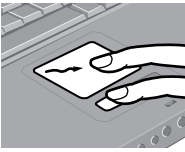
Function	Operation	
Moving the Cursor		Move the tip of your finger lightly over the surface.
Tapping/Clicking	 Tapping	or  Clicking
Double-Tapping/ Double-Clicking	 Double-Tapping	or  Double-Clicking
Dragging		
Scroll	⇒ <i>Reference Manual</i> "Touch Pad"	

NOTE

- Besides the above operations, operations such as Zoom and Pan are possible by allocating these functions to the buttons and/or pad. For more details, refer to [Mouse Properties]^{*1}.
- ^{*1} Select [start] - [Control Panel] - [Printers and Other Hardware] - [Mouse].
- The operations of Scroll, Pan or Zoom will differ depending on the application. There are cases the touch pad will not support these operations even with an application that supports the functions.
- When using the touch pad, keep the following in mind.
 - By design the touch pad is to be used with a finger tip only. Do not place any object on the work surface or press down forcefully with sharp-pointed objects (e.g., nails) or hard objects that can leave marks (e.g., pencils and ball point pens).
 - Try to avoid having any harmful substances, such as oil, come in contact with the touch pad. The cursor may not work properly in such cases.

Reference Manual

Reference Manual / Important Tips

The Reference Manual and the Important Tips can be accessed on your computer. When a printer is connected, the Reference Manual can also be printed.

■ Reference Manual

The Reference Manual explains functions for you to make greater use of the computer, such as how to add peripheral devices, how the Setup Utility works, and other useful information.

Contents		
• Read Me First	• WinDVD	• Hard Disk Drive
• Key Combinations	• B's Recorder/B's CLiP	• Setup Utility
• LED Indicators	• PC Cards	• Technical Information
• Touch Pad	• RAM Module	• DMI Viewer
• Standby/Hibernation Functions	• Port Replicator	• Icon Enlarger
• Security Measures	• External Display	• List of Error Codes
• Computing on the Road	• Printer	• Dealing with Problems (Advanced)
• Battery Power	• USB Devices	
• Multimedia Pocket	• IEEE 1394 Devices	
• CD/DVD Drive	• Modem	
	• LAN	
	• Wireless LAN	

- How to access the Reference Manual
Select [Reference Manual] in [start].

■ Important Tips

Important Tips provides information on how to maximize use of the battery pack, which is necessary for computing away from your home or office.

- How to access the Important Tips

Select  on the desktop.
Important Tips

Important Tips can also be accessed from the following menu.
Select [Important Tips] in [start] - [All Programs] - [Panasonic] - [On-Line Manuals].

When the Reference Manual or Important Tips is accessed for the first time, the License Agreement of the Acrobat Reader may be displayed. If it is displayed, after reading the agreement, select [Accept] to access the Reference Manual or Important Tips.

NOTE

- Illustrations may be difficult to view depending on the magnification. If the illustration is too small, magnify the display.
- When the taskbar is hidden at the bottom portion of Acrobat Reader, set the maximum display window size.
- If a printer is connected, we recommend printing pages. The illustrations and display samples may not print with a high quality.

Useful Information

Usage Environment

■ Environment

- Place the computer on a flat stable surface. Do not place the computer upright or allow it to tip over. When the computer receives extremely strong shock after falling, the hard disk or floppy disk drive, etc., may become inoperable.
- In use Temperature: 5 °C to 35 °C {41 °F to 95 °F}
 Humidity: 30% to 80% RH (No condensation)
- Not in use Temperature: -20 °C to 60 °C {-4 °F to 140 °F}
 Humidity: 30% to 90% RH (No condensation)

■ Places not to use your computer

- Such areas may result in damage to the computer.
 - Areas with electronic equipment**
These areas may interfere with your display or cause your computer to produce strange sounds.
 - Areas with extremely high/low temperatures**
- Do not leave things near the computer that are sensitive to heat. During operation, the computer may become warm.

Handling

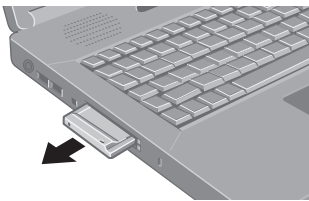

- This computer has been designed so as to minimize shock to the LCD and hard disk drive, etc., but no warranty is provided against such trouble. Therefore, as a precision instrument, be extremely careful in the handling.
- Do not drop or hit your computer against solid objects.
- Do not carry your computer when the power is on.
- Remove all external devices, cables, and PC Cards sticking out of the computer (see the figure on the left) before transporting the computer.
- We recommend preparing a fully charged battery.
When transporting a spare battery inside a package, briefcase, etc., it is recommended that it be placed in a plastic bag so that its contacts are protected.
- Do not carry the computer while the display is open, or carry it by gripping the display.
- Do not put anything (e.g., a piece of paper) between the display and keyboard.
- Always carry your computer with you. Never check it in with luggage. For use of the computer inside an aircraft, we recommend asking the airlines regarding their policy on this issue.
- It is a good idea to make backup copies on disks and carry them with you.
- Do not leave a disk in the drive while transporting your computer.

Maintenance

Display

Avoid using water when cleaning the panel. Ingredients included in water may leave scratches and reduce readability of the screen.

<When cleaning dust/dirt>

- Avoid rubbing off dust/dirt with cloth since it may leave scratch on the screen. Sweep dust/dirt with fine brush, then wipe it with a dry soft cloth used for cleaning glasses.

<When cleaning oily surface>

- Apply camera lens cleaner on a soft gauze and clean it with gentle force. Then, wipe with a dry soft cloth used for cleaning glasses.

Areas excluding the display

Wipe these areas with a soft cloth, after applying water or detergent diluted with water to the soft cloth and firmly wringing out excess water.

Touch Pad (→ page 18)

CAUTION

- Do not use benzene, thinner, or rubbing alcohol. Doing so may adversely affect the surface, e.g., discoloration. In addition, do not use commercially-available household cleaners and cosmetics, as they may contain components harmful to the surface.
- Do not directly add or spray water or detergent. If liquid enters the inside of the computer, it may cause it to work improperly or be damaged.

Computer Viruses

Users are advised to purchase the latest versions of virus protection software and use them regularly.

We recommend you run the software:

- When booting your computer.
- After receiving data.

We recommend that you check data received on disks or from external sources, such as data downloaded from the Internet, e-mail, etc. (For compressed files, uncompress them before running a check).

Windows Update

You can use the latest patches and service packs for Windows with the following menus.

Do not apply “Driver Updates” even if a message to update a driver appears. If a driver update is required, contact Panasonic Technical Support. (→ page 37)

[start] - [All Programs] - [Windows Update]

When Using Peripheral Devices

Pay strict attention to the following points to avoid damage to the computer, peripheral devices, cables, etc. Also, in addition to following this manual and the Reference Manual, carefully read the instruction manuals for the peripheral devices being used.

- Use only peripheral devices that conform to the computer's specifications.
- Connect the devices properly, paying close attention to the condition and position of the connectors.
- If a connection cannot be made easily, do not apply undue force; check once more to confirm the condition and position of the connector (alignment of pins, etc.) .
- If the connector has holding screws, fasten the screws firmly.
- Do not carry the computer with cables attached, and do not pull on the cables forcefully.

Saving Data on the Hard Disk

- **Do not expose your computer to shock.**
Use care when handling your computer, shock may damage your hard disk or make your software applications and data unusable.
- **Do not power down your computer while software applications are running or hard disk drive indicator  is on.**
Properly shut Windows down to avoid problems.
- **Save all valuable data to disks.**
Backing up data to disks will limit damage should trouble occur to your computer or should you inadvertently change or erase data.
- **Use the security function for all important data.** (⇒ *Reference Manual* “Security Measures”)

Hard Disk Lock

When the Hard Disk Lock is set to [Enable], it is impossible to read/write data from/to the hard disk when the hard disk is installed in a different computer, since a password is also set for the hard disk. When the hard disk is returned to the original computer, you can read/write data as before. In this case, however, make the settings in the Setup Utility exactly the same as they were before the hard disk was removed. (Note that this Hard Disk Lock does not guarantee the complete protection of data.) (⇒ *Reference Manual* “Security Measures”)

Saving Data on Floppy Disks

- **Do not power down your computer or press the floppy disk drive eject button while the MP indicator  is on.**
Doing so may damage the data on the floppy disk and render the floppy disk useless.
- **Use care when handling floppy disks.**
To protect the data on your floppy disks or to prevent a floppy disk from becoming stuck in your computer, avoid the following:
 - Sliding the shutter on the floppy disk manually.
 - Exposing the floppy disk to a magnetic field.
 - Storing the floppy disk in locations prone to high temperatures, low pitched noise, dampness, or dust.
 - Applying more than one label on the floppy disk.
- **Confirm the contents of a floppy disk before formatting it.**
Confirm that no important data is on the floppy disk, because all data on the floppy disk will be erased.
- **Use the write-protect tab (A).**
This is a must for preserving important data.
This prevents your data from being erased or overwritten.

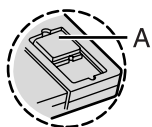

Write Enable

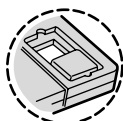

Write Disable

When Disposing of or Transferring Ownership of This Device

- When disposing of or transferring ownership of this device, erase all data on the hard disk in order to prevent the theft of hard disk data. Even if you delete data or initialize the hard disk through normal Windows commands, data can still be read using special software. In order to erase all data, either have the data erased by a specialist (at a charge) or use the hard disk data erase utility (included) (→ page 33). (Note that this hard disk data erase utility does not guarantee that data will be completely erased.)
Also, note that if you transfer ownership of this device without deleting commercial software that you have installed to the hard disk, you may be in violation of the licensing agreement for that software.

Wireless LAN

- **To prevent theft of data or unauthorized access to the hard disk via a wireless LAN**
 - If you plan to use wireless LAN functions, we recommend that you do so only after making the appropriate security settings, such as for data encryption.

List of Error Codes

When turning on the computer, if one of the following error codes or messages is displayed, follow the instructions shown below.

If the problem persists, or if the error code or message displayed is not shown here, contact Panasonic Technical Support. (→ page 37)

Error Code/Message	Solution
0211 Keyboard error	<ul style="list-style-type: none"> ● If an external keyboard or mouse is connected, disconnect these devices.
0251 System CMOS checksum bad - Default configuration used	<p>An error has occurred in the memory that stores the Setup Utility settings. This error occurs when the memory content is changed through some inadvertent operation by a program or other function.</p> <ul style="list-style-type: none"> ● Run the Setup Utility and load the default values, then change the settings to the appropriate values as needed. ● If the problem persists, the internal clock battery may need to be replaced. Contact Panasonic Technical Support.
0271 Check date and time settings	<p>The date and time setting are incorrect.</p> <ul style="list-style-type: none"> ● Run the Setup Utility and set the date and time correctly. ● If the problem persists, the internal clock battery may need to be replaced. Contact Panasonic Technical Support.
0280 Previous boot incomplete - Default configuration used	<p>Startup has failed repeatedly, so the Setup Utility settings have been returned to their default values, and the computer has been booted.</p> <ul style="list-style-type: none"> ● Run the Setup Utility and load the default values, then change the settings to the appropriate values as needed.
Press <F1> to resume, <F2> to Setup	<ul style="list-style-type: none"> ● Write down the error details and press F2 to run the Setup Utility. Confirm the settings, and change the settings to the appropriate values as needed.
Operating System not found	<p>The OS is not properly installed on the floppy disk or the hard disk that you are trying to boot from.</p> <ul style="list-style-type: none"> ● If the computer cannot be booted from the floppy disk, check the floppy disk drive to ensure that the disk is in fact bootable, and change it to another if not. ● If the computer cannot be booted from the hard disk, confirm whether the hard disk is properly recognized in [Information] menu of the Setup Utility. If the hard disk is recognized, perform the reinstallation procedure. If not, contact Panasonic Technical Support. ● If a device is connected to the USB port, disconnect the device, or run the Setup Utility and set [Legacy USB Support] to [Disable] in [Security] menu of the Setup Utility.

■ How to run the Setup Utility

- 1 Restart the computer.**
- 2 Press **F2** while [Panasonic] boot screen is displayed soon after the computer begins the startup procedure.**

Dealing with Problems (Summary)

When a problem occurs, refer to this page. The “Reference Manual” also contains detailed information. If a problem appears to be related to a software application, read the software related manual. If you still cannot troubleshoot the problem, contact Panasonic Technical Support (→ page 37). You can use the PC Information Viewer to check the computer’s usage status. (⇒Reference Manual “Dealing with Problems (Advanced)”)

■ Starting Up

The power indicator or battery indicator is not lit	<ul style="list-style-type: none"> ● Check the cable connection for the AC adaptor. ● Check to see if a fully charged battery is properly installed. ● Remove the battery pack and disconnect the AC adaptor, then connect them again.
The computer does not operate when a USB device is connected	<ul style="list-style-type: none"> ● The computer may not operate when certain USB devices are connected. Disconnect the USB device, or set [Legacy USB Support] to [Disable] in [Security] menu of the Setup Utility.
[Enter Password] is displayed	<ul style="list-style-type: none"> ● Input your Supervisor Password or User Password. If you have forgotten it, contact Panasonic Technical Support (→ page 37).
POST Startup Error(s) is displayed	→ page 24
Windows startup, or an operation is extremely slow	<ul style="list-style-type: none"> ● Press F9 in the Setup Utility (→ page 24). This will restore the Setup Utility’s settings to their default values (except the password settings). Then, the Setup Utility must be run once again for you to input the appropriate operating environment settings. (The processing speed depends on the application software used, so this operation may not cause the processing speed to increase.) ● Disable any resident software.
The date and time are incorrect	<ul style="list-style-type: none"> ● You can set the date and time using the following menu. [start] - [Control Panel] - [Date, Time, Language, and Regional Options] - [Date and Time] ● When the computer is connected to a LAN, confirm the date and time of the server. ● If you continue to experience problems, the internal battery maintaining the clock may need to be replaced. Contact Panasonic Technical Support (→ page 37). ● This computer will not correctly recognize the date and time starting from the year 2100 A.D.
When resuming from the standby or hibernation mode, [Enter Password] does not appear even if a password has been set in the Setup Utility	<ul style="list-style-type: none"> ● Even when a password has been set in the Setup Utility, [Enter Password] does not appear when the computer resumes from the standby or hibernation mode. If you want to use the security function when using the standby or hibernation mode, use the Windows password as follows: <ol style="list-style-type: none"> ① Select the account to change in [start] - [Control Panel] - [User Accounts] and set the password. ② Add the check mark for [Prompt for password when computer resumes from standby] in [Control Panel] - [Performance and Maintenance] - [Power Options] - [Advanced].
When “Remove disks or other media. Press any key to restart” (or a similar message) is displayed	<ul style="list-style-type: none"> ● This means a floppy disk that does not contain system startup information has been left in the floppy disk drive. Remove the floppy disk, and press any key. ● If the message still appears even after trying the above measure, this may be an indication that some type of hard disk failure has occurred. Contact Panasonic Technical Support.
When the administrator password is forgotten	<ul style="list-style-type: none"> ● If you have created a password reset disk (→ page 14), a message is displayed when you fail to correctly enter the password. Follow the message’s instructions and set the password again by using the password reset disk. If you have not created a password reset disk, after reinstalling, setup Windows and then set the password again.

Dealing with Problems (Summary)

■ Starting Up

<p>When the previous item is not the cause</p>	<ul style="list-style-type: none"> ● Press F9 in the Setup Utility. This will restore the Setup Utility's settings to their default values (except the password settings). ● Try removing all peripheral devices. ● Check a disk error using the following procedure. <ol style="list-style-type: none"> ① Display [Local Disk (C:) Properties]. Select [Local Disk(C:)] with the right button in [start] - [My Computer], and select [Properties]. ② Select [Tools] - [Check Now]. ③ Select [Start] after selecting required items in [Check disk options]. ● At startup, hold down F8 when [Panasonic] boot screen disappears^{*1}, and release your finger when the Windows Advanced Option Menu is displayed. Start the computer in Safe Mode, and confirm the details of the error. <p>^{*1} When [Password on boot] is set to [Enable], [Enter Password] appears after the [Panasonic] boot screen disappears. Hold down F8 soon after inputting the password and pressing Enter.</p>
--	---

■ Display

<p>No display after powering on</p>	<ul style="list-style-type: none"> ● When there is no display to an external display, <ul style="list-style-type: none"> • Check your cable connection to the external display. • Confirm your display is powered on. • Check the settings for your external display. ● The display destination may be set to the external display. Try changing the display by pressing Fn + F3. If you want to switch the display destination repeatedly by pressing Fn + F3, make sure that the display destination has switched completely each time before pressing Fn + F3 again. ● When displaying only through an external display, if the computer is shut down by using the standby or hibernation function, there will be no display on the LCD unless the external display is connected when operations are resumed. In this case, connect the external display or press Fn + F3. ● Press Fn+F2 and adjust the brightness.
<p>The power has not been turned off, but after a certain period of time, there is no display</p>	<ul style="list-style-type: none"> ● Has the computer been set to the power-saving mode? To resume operation of your computer from the condition the power of the display is off (for energy conservation purposes), press any key unrelated to the direct triggering of a selection, like Ctrl. ● To save power, your computer may have automatically entered the standby mode (power indicator blinks green) or hibernation mode (power indicator turns off). In such cases, press the power switch.
<p>When the battery pack is used, the screen is darker than when the AC adaptor is connected</p>	<ul style="list-style-type: none"> ● Press Fn + F2 and adjust the brightness. Note, however, that when the brightness is increased, the battery running time will become shorter. Brightness can be set to separate levels for when the AC adaptor is connected and when it is disconnected.
<p>The cursor cannot be controlled properly</p>	<ul style="list-style-type: none"> ● If you are using an external mouse, ensure that the external mouse has been connected correctly. ● Restart the computer by using the keyboard (Press Alt, U, and select [Restart] with R). ● If the computer does not respond to keyboard commands, read "No response" (→ page 28).
<p>An afterimage appears (e.g., green, red, and blue dots remain on the display) or there are dots not displaying the correct colors</p>	<ul style="list-style-type: none"> ● If an image is displayed for a prolonged period of time, an afterimage may appear. This is not a malfunction. The afterimage will disappear when a different screen is displayed. ● High-precision and advanced technologies are necessary in the production of color liquid crystal displays (color LCDs). Therefore, if 0.002% or less of the picture elements either fail to light or remain constantly lit (that is, more than 99.998% of elements are functioning properly), no defect is considered to exist.

■ Display

The screen becomes disordered	<ul style="list-style-type: none"> ● Changing the number of colors of the display may affect the screen. Restart the computer. ● When using Dualview, use the same display colors for the external display as those used by the LCD. ● When using Dualview, do not press Fn + F3. ● Restart your computer immediately after enabling or disabling Dualview.
The external display no longer displays properly	<ul style="list-style-type: none"> ● When an external display not compatible with the power saving mode is used with the computer, the display may not function correctly when the computer enters the power saving mode. In such cases, turn off the power to the external display.
When you want to display the fonts or icons at a larger size	<ul style="list-style-type: none"> ● Change the size of the icons, etc. using "Icon Enlarger" (⇒ <i>Reference Manual</i> "Icon Enlarger"). ● You can also change the settings as follows (for more details, refer to the Windows Help). <ol style="list-style-type: none"> ① Select [start] - [Control Panel] - [Appearance and Themes] - [Display] - [Appearance]. ② Select the font size in [Font size], and select [Effects] and then add the check mark for [Use large icons] to increase the icon size. ③ Select [OK], then select [OK].
When a video such as an MPEG file and a DVD video is being played with WinDVD or Windows® Media Player, the display destination cannot be switched using Fn+F3	<ul style="list-style-type: none"> ● The display destination cannot be switched while a video such as an MPEG file and a DVD video is playing. Stop playing the video before switching the display destination.
An error occurs or the computer freezes while using Dualview	<ul style="list-style-type: none"> ● If you use a 3D screen saver while in Dualview mode at a high resolution, an error may occur or the computer may freeze. Under these conditions, do not use a 3D screen saver.
When the screensaver is set, an error will occur during a resume operation	<ul style="list-style-type: none"> ● When the computer automatically enters the standby or hibernation mode while the screensaver is running, an error may occur during a resume operation. In such cases, turn off the screensaver or try changing the pattern of the screensaver.

■ Shutting down

Windows cannot be shut down or restarted	<ul style="list-style-type: none"> ● If a USB device is connected, try removing it.
--	--

■ Battery Indicator

The red indicator lights	<ul style="list-style-type: none"> ● The battery level is very low (the charge is approx. 9% or less). Connect the AC adaptor. You can use the computer when the indicator light is orange. If you do not have an AC adaptor, save your data and power off your computer. After replacing the battery pack with a fully charged one, turn your computer on.
The red indicator blinks	<ul style="list-style-type: none"> ● Quickly save your data and power off your computer. Remove the battery pack and disconnect the AC adaptor, then connect them again. If the problem persists, contact Panasonic Technical Support (⇒ page 37). The battery pack or charging circuit may be defective.
The green indicator blinks	<ul style="list-style-type: none"> ● In high temperature mode, the battery pack is discharging to a level of 80%^{*1} in normal temperature mode.(⇒ <i>Reference Manual</i> "Battery Power") Do not remove the battery pack while the battery indicator is blinking green. <p>^{*1} A level of 80% in normal temperature mode is displayed as [100%] in high temperature mode.</p>
The orange indicator blinks	<ul style="list-style-type: none"> ● Battery cannot be recharged temporarily because the internal temperature of the battery pack is outside of the acceptable temperature range for recharging. Once the allowable range requirement is satisfied, charging begins automatically. Your computer can be used normally in this state.

Dealing with Problems (Summary)

■ Reference Manual

<p>The Reference Manual is not displayed</p>	<ul style="list-style-type: none"> ● Is Acrobat Reader installed? If Acrobat Reader is not installed, run [c:\util\reader\acroreader51_enu_full.exe] in [start] - [Run] to reinstall the program. When installing the program, do not change the installation destination folder. If the destination folder is changed, the Reference Manual cannot be opened from [start] menu.
--	---

■ Fast User Switching function

<p>Some applications do not work properly</p>	<ul style="list-style-type: none"> ● When switching to a different user with the Fast User Switching function, the following problems may occur. <ul style="list-style-type: none"> ● Some applications may not work properly. ● Key combination with Fn may not work. ● It may not be possible to set the settings of the display. ● The wireless LAN cannot be used. ● A serial mouse may not work. ● The B's CLiP icon will no longer be shown on the taskbar and B's CLiP cannot be used. <p>In this case, log off all users without using Fast User Switching function, and try the operation once more. If the problem persists, restart the computer.</p>
---	---

■ Others

<p>No response</p>	<ul style="list-style-type: none"> ● Press Ctrl+Shift+Esc to open Task Manager and close the software application which is not responding. ● After shutting down by pressing the power switch for more than four seconds, press the power switch to power on and open the application again. If the program no longer works normally, delete the program using the following procedure. Then reinstall the program. [start] - [Control Panel] - [Add or Remove Programs]
<p>When trying to play back video files using Windows® Media Player, the message [Codec required] appears, and the file cannot be played back</p>	<ul style="list-style-type: none"> ● Some video files use a Codec that is not installed as a standard. In these cases, if you play back the video file after connecting to the Internet, the Codec may be downloaded automatically, allowing you to play back the file.
<p>The shortcut icon for the Windows® Media Player is not displayed on the desktop</p>	<ul style="list-style-type: none"> ● Start up Windows® Media Player from [start] - [All Programs]. Also, you can copy the icon from [All Programs] list to the desktop and use this icon to start Windows® Media Player.
<p>Two shortcut icons for the Windows® Media Player are displayed on the desktop</p>	<ul style="list-style-type: none"> ● Did the user who first accepted the Windows® Media Player license agreement have the administrator authority? Two icons will be displayed until someone with the administrator authority accepts the license agreement, but either icon can be used to start the program.

Reinstalling Software

When reinstallation procedure is performed, the contents of the hard disk will be erased. Be sure to back up any critical data that is on your hard disk before running the reinstallation procedure.

The reinstallation procedure will return the computer to its original condition.

- If you have created partitions for data, the data may be erased or become corrupt as a result of the reinstallation procedure.

Before Reinstallation

■ Preparing

- The Product Recovery DVD-ROM (included).
- Panasonic CD/DVD drive

■ Important

- Before the reinstallation procedure, remove all peripherals (except for the CD/DVD drive).
- Turn off the computer and insert the CD/DVD drive into the multimedia pocket. (⇒ *Reference Manual* "Multimedia Pocket")
- Be sure the AC adaptor is connected until the reinstallation procedure is completed.
- Even if reinstallation is executed, the number of times that the DVD video region code can be set will not be returned to the state set at the time of factory shipment.

Reinstalling

- ① Turn on the computer, and press **F2** while [Panasonic] boot screen is displayed.
The Setup Utility will start up.
If the password has been set, enter the Supervisor Password.
- ② Write down all of the contents of the Setup Utility and then press **F9**.
At the confirmation message, select [Yes] and press **Enter**.
- ③ Select [Boot] menu, then select [CD/DVD Drive] and press **F6** until [CD/DVD Drive] is at the top of [Boot] menu.
- ④ Place the Product Recovery DVD-ROM into the CD/DVD drive.
- ⑤ Press **F10**.
At the confirmation message, select [Yes] and press **Enter**. The computer will restart.
- ⑥ Press **1** to execute [1. [Recovery]].
(You can cancel this operation by pressing **0**.)
The License Agreement screen should appear.
- ⑦ Press **1** to select [1. Yes, I agree to the provisions above and wish to continue!].
This screen should appear.

```
-----
Select a number
-----
                                Reinstalling : Windows(R) XP Professional
1. Reinstall Windows to the whole HDD to factory default.
2. Make two partitions, for the operating system and data. And reinstall
   Windows to the operating system partition.
   (All existing partitions on HDD will be lost.)
3. Reinstall Windows to the first partition.
0. Cancel
-----
```

- ⑧ Make a selection from the menu.
 - When selecting [2], enter the basic partition size for the operating system installation and press **Enter**.
(The data partition size is the remainder after subtracting the basic partition size.)

Reinstalling Software

- To select [3], the first partition size must be 6 GB or more of the hard disk size. Reinstallation cannot be performed with a small partition size.
- ⑨ At the confirmation message, press **Y**.
The operation of reinstallation for the hard disk starts automatically. (The operations take about 15 minutes.)
 - Do not interrupt the reinstallation procedure before completion, for example by turning off the computer or pressing **Ctrl + Alt + Del**, as this may prevent Windows from starting up, or may cause data to be lost so that the reinstallation procedure cannot be executed.
- ⑩ After the reinstallation procedure completes, the screen should appear. Remove the Product Recovery DVD-ROM, and then press any key. The computer will be shut down.

```
[Recovery] is complete.
Windows(R) XP Professional install wizard will start after reboot.
Please remove the Product Recovery DVD-ROM, and then turn off the computer.
```

- ⑪ Turn on the computer, and press **F2** while [Panasonic] boot screen is displayed.
The Setup Utility will start up.
If the password has been set, enter the Supervisor Password.
- ⑫ Press **F9**.
At the confirmation message, select [Yes] and then press **Enter**. (The Setup Utility settings will return to their default values. Even the security settings with the exception of the password(s) will return to their default values.)
- ⑬ Select [Exit] and then select [Save Current Values], then press **Enter**.
At the confirmation messages, select [Yes] and press **Enter**.
- ⑭ Turn the computer off by using the power switch.
 - If additional instructions are included with the computer, be sure to read them. It may be necessary to perform additional operations during the following procedures.
- ⑮ Perform the first-time use operation. (→ page 12)
- ⑯ Run the Setup Utility and change the settings where necessary.

■ Changing the drive letter

You can change the drive letter for the CD/DVD drive or hard disk drive by the following steps.

- Drive letters can only be changed when two or more partitions have been created on the hard disk drive. The name of the C: drive cannot be changed.
- We recommend that you make these changes before installing applications.
- ① Select [start] - [Control Panel] - [Performance and Maintenance] - [Administrative Tools] - [Computer Management].
- ② Select [Disk Management] from [Storage].
- ③ Right click on the partition of the hard disk or the name of the CD/DVD drive and select [Change Drive Letter and Paths...].
- ④ Select [Change].
- ⑤ Select [Assign the following drive letter] and the new drive letter, and then select [OK].
- ⑥ At the confirmation message, select [Yes].

LIMITED USE LICENSE AGREEMENT

THE SOFTWARE PROGRAM(S) ("PROGRAMS") FURNISHED WITH THIS PANASONIC® PRODUCT ("PRODUCT") ARE LICENSED ONLY TO THE END-USER ("YOU"), AND MAY BE USED BY YOU ONLY IN ACCORDANCE WITH THE LICENSE TERMS DESCRIBED BELOW. YOUR USE OF THE PROGRAMS SHALL BE CONCLUSIVELY DEEMED TO CONSTITUTE YOUR ACCEPTANCE OF THE TERMS OF THIS LICENSE.

Matsushita Electric Industrial Co., Ltd. ("MEI") has developed or otherwise obtained the Programs and hereby licenses their use to you. You assume sole responsibility for the selection of the Product (including the associated Programs) to achieve your intended results, and for the installation, use and results obtained therefrom.

LICENSE

- A. MEI hereby grants you a personal, non-transferable and non-exclusive right and license to use the Programs in accordance with the terms and conditions stated in this Agreement. You acknowledge that you are receiving only a LIMITED LICENSE TO USE the Programs and related documentation and that you shall obtain no title, ownership nor any other rights in or to the Programs and related documentation nor in or to the algorithms, concepts, designs and ideas represented by or incorporated in the Programs and related documentation, all of which title, ownership and rights shall remain with MEI or its suppliers.
- B. You may use the Programs only on the single Product which was accompanied by the Programs.
- C. You and your employees and agents are required to protect the confidentiality of the Programs. You may not distribute or otherwise make the Programs or related documentation available to any third party, by time-sharing or otherwise, without the prior written consent of MEI.
- D. You may not copy or reproduce, or permit to be copied or reproduced, the Programs or related documentation for any purpose, except that you may make one (1) copy of the Programs for backup purposes only in support of your use of the Programs on the single Product which was accompanied by the Programs. You shall not modify, or attempt to modify, the Programs.
- E. You may transfer the Programs and license them to another party only in connection with your transfer of the single Product which was accompanied by the Programs to such other party. At the time of such a transfer, you must also transfer all copies, whether in printed or machine readable form, of every Program, and the related documentation, to the same party or destroy any such copies not so transferred.
- F. You may not remove any copyright, trademark or other notice or product identification from the Programs and you must reproduce and include any such notice or product identification on any copy of any Program.

YOU MAY NOT REVERSE ASSEMBLE, REVERSE COMPILE, OR MECHANICALLY OR ELECTRONICALLY TRACE THE PROGRAMS, OR ANY COPY THEREOF, IN WHOLE OR IN PART.

YOU MAY NOT USE, COPY, MODIFY, ALTER, OR TRANSFER THE PROGRAMS OR ANY COPY THEREOF, IN WHOLE OR IN PART, EXCEPT AS EXPRESSLY PROVIDED IN THE LICENSE.

IF YOU TRANSFER POSSESSION OF ANY COPY OF ANY PROGRAM TO ANOTHER PARTY, EXCEPT AS PERMITTED IN PARAGRAPH E ABOVE, YOUR LICENSE IS AUTOMATICALLY TERMINATED.

TERM

This license is effective only for so long as you own or lease the Product, unless earlier terminated. You may terminate this license at any time by destroying, at your expense, the Programs and related documentation together with all copies thereof in any form. This license will also terminate effective immediately upon occurrence of the conditions therefore set forth elsewhere in this Agreement, or if you fail to comply with any term or condition contained herein. Upon any such termination, you agree to destroy, at your expense, the Programs and related documentation together with all copies thereof in any form.

YOU ACKNOWLEDGE THAT YOU HAVE READ THIS AGREEMENT, UNDERSTAND IT AND AGREE TO BE BOUND BY ITS TERMS AND CONDITIONS. YOU FURTHER AGREE THAT IT IS THE COMPLETE AND EXCLUSIVE STATEMENT OF THE AGREEMENT BETWEEN US, WHICH SUPERSEDES ANY PROPOSAL OR PRIOR AGREEMENT, ORAL OR WRITTEN, AND ANY OTHER COMMUNICATIONS BETWEEN US, RELATING TO THE SUBJECT MATTER OF THIS AGREEMENT.

About Intel® software products

The enclosed software products and documentation were developed at private expense, and are provided with "RESTRICTED RIGHTS." Use, duplication or disclosure by the government is subject to restrictions as set forth in FAR 52.227-14 and DFARS 252.227-7013 et. seq. or its successor. The use of this product by the government constitutes acknowledgment of Intel's proprietary rights in the product.

Contrat de licence d'usage limité

Le(s) logiciel(s) (les "Logiciels") fournis avec ce produit Panasonic® (le "Produit") sont exclusivement concédés en licence à l'utilisateur ultime ("vous"), et ils ne peuvent être utilisés que conformément aux clauses contractuelles ci-dessous. En utilisant les logiciels, vous vous engagez de manière définitive à respecter les termes, clauses et conditions des présentes.

Matsushita Electric Industrial Co., Ltd. ("MEI") a mis au point ou obtenu les Logiciels et vous en concède l'utilisation par les présentes. Vous assumez l'entière responsabilité du choix de ce Produit (y compris des Logiciels associés) pour obtenir les résultats escomptés, ainsi que de l'installation, de l'utilisation et des résultats obtenus.

Licence

- A. MEI vous octroie par les présentes le droit et la licence personnels, non cessibles et non exclusifs d'utiliser les Logiciels conformément aux termes, clauses et conditions de ce Contrat. Vous reconnaissez ne recevoir qu'un droit limité d'utiliser les Logiciels et la documentation les accompagnant et vous vous engagez à n'obtenir aucun droit de titre, propriété ni aucun autre droit vis-à-vis des Logiciels et de la documentation les accompagnant ni vis-à-vis des algorithmes, concepts, dessins, configurations et idées représentés par ou incorporés dans les Logiciels et la documentation les accompagnant, dont les titres, propriété et droits resteront tous à MEI ou à leurs propriétaires.
- B. Vous ne pouvez utiliser les Logiciels que sur le Produit unique qui est accompagné par les Logiciels.
- C. Vous et vos employés ou agents êtes requis de protéger la confidentialité des Logiciels. Vous ne pouvez ni distribuer ni mettre les Logiciels et la documentation les accompagnant à la disposition d'un tiers, par partage de temps ou de quelque autre manière que ce soit, sans l'autorisation écrite préalable de MEI.
- D. Vous ne pouvez ni copier ni reproduire ni permettre la copie ni la reproduction des Logiciels ni de la documentation les accompagnant pour quelque fin que ce soit, à l'exception d'une (1) copie des Logiciels à des fins de sauvegarde uniquement pour soutenir votre utilisation des Logiciels sur le Produit unique qui est accompagné par les Logiciels. Vous ne pouvez ni modifier ni tenter de modifier les Logiciels.
- E. Vous ne pouvez céder les Logiciels et en octroyer la licence à une autre partie qu'en rapport avec votre cession du Produit unique qui est accompagné par les Logiciels à cette autre partie. Au moment de cette cession, vous devez céder également toutes les copies, que ce soit sous forme imprimée ou lisible par la machine, de tous les Logiciels ainsi que de la documentation les accompagnant, à la même partie ou détruire les copies non cédées.
- F. Vous ne pouvez retirer aucune marque de droits d'auteur, marque ou autre ni aucune identification de produit des Logiciels et vous devez reproduire et inclure toutes ces notices ou identifications de produit sur toutes les copies des Logiciels.

Vous ne pouvez assembler en sens inverse, compiler en sens inverse ni retracer les Logiciels ni aucune de leurs copies, de façon électronique ou mécanique, en tout ou en partie.

Vous ne pouvez utiliser, copier, modifier, altérer ni céder les Logiciels ni aucune de leurs copies, en tout ou en partie, à l'exception de ce qui est expressément stipulé dans ce contrat.

Si vous cédez la possession de toute copie ou de tout Logiciel à une autre partie, à l'exception de ce qui est autorisé au paragraphe E ci-dessus, votre licence est automatiquement résiliée.

Termes, clauses et conditions

Cette licence n'est effective que pour la durée de possession ou de crédit-bail du Produit, à moins d'une résiliation antérieure. Vous pouvez résilier cette licence à tout moment en détruisant, à vos frais, les Logiciels et la documentation les accompagnant avec toutes leurs copies, sous quelque forme que ce soit. Cette licence sera également résiliée, avec application immédiate, si les conditions de résiliation définies ailleurs dans ce contrat se sont réalisées ou si vous ne respectez pas les termes, clauses et conditions qui y sont contenues. Au moment de la résiliation, vous acceptez de détruire, à vos frais, les Logiciels et la documentation les accompagnant avec toutes leurs copies, sous quelque forme que ce soit.

Vous reconnaissez avoir lu ce contrat, en avoir compris toute la substance et avoir accepté de respecter ses termes, clauses et conditions. Vous reconnaissez en outre qu'ils sont la description complète et exclusive du contrat conclu entre nous, contrat qui remplace et annule toute proposition ou contrat précédent, écrit ou oral, et toute autre communication entre nous, relativement à l'objet du présent contrat.

Hard Disk Data Erase Utility

This computer is equipped with a utility for completely erasing hard disk data.

When disposing of or transferring ownership of this device, erase all data on the hard disk in order to prevent the theft of hard disk data following the steps below.

The hard disk data erase utility erases data using an overwriting method, but there is a possibility that due to malfunctions or other operational errors, data may not be completely erased. There are also specialized devices that may be able to read data that has been erased using this method. If you need to erase highly confidential data, we recommend that you contact a company that specializes in this process. Matsushita Electric Industrial Co., Ltd. will bear no responsibility for losses or damages suffered as a result of the use of this utility.

Preparing

- You will need the Product Recovery DVD-ROM (included) and Panasonic CD/DVD drive.
- Turn off the computer and insert the CD/DVD drive into the multimedia pocket. (⇒ *Reference Manual* “Multimedia Pocket”)
- Be sure the AC adaptor is connected until the procedure is completed.
- This utility can only be used for internal hard disk. It cannot be used to erase data from external hard disks.
- This utility cannot erase data from damaged disk.
- This utility cannot erase data for specific partitions.
- After executing this utility, the computer cannot be booted from the hard disk.

Procedure

- ① Turn on the computer, and press **F2** while [Panasonic] boot screen is displayed. The Setup Utility will start up.
If the password has been set, enter the Supervisor Password.
- ② Select [Boot] menu, then select [CD/DVD Drive] and press **F6** until [CD/DVD Drive] is at the top of [Boot] menu.
- ③ Place the Product Recovery DVD-ROM into the CD/DVD drive.
- ④ Press **F10**.
At the confirmation message, select [Yes] and press **Enter**.
The computer will restart.
- ⑤ Press **2** to execute [2. [Erase HDD]].
(You can cancel this operation by pressing **0**.)
- ⑥ At the confirmation message, press **Y**.
- ⑦ When [<<< Start menu >>>] is displayed, press **Enter**.
- ⑧ The approximate time required for erasing data will be displayed.
Press **Space**.
- ⑨ At the confirmation message, press **Enter**. The operation of erasing the hard disk starts.
If necessary, the “hard disk data erase” operation can be cancelled after it has begun by pressing **Ctrl + C**.
(If the operation is cancelled before being completed, a part of the data will not be erased.)
- ⑩ After the operation is complete:
Under normal conditions, the message [Hard disk data has been deleted.] will be displayed.
If a problem occurred during the operation, an error message will be displayed.
- ⑪ Remove the Product Recovery DVD-ROM, and then press any key to turn off the computer.

Specifications

This page provides the specifications for the basic model CF-51GAMBAKM/CF-51GAMDAKM/CF-51GAMEAKM/CF-51ABLDKAM/CF-51ABLEAKM/CF-51ABLBKAM. The model number will change depending on the configuration of the unit, such as, CPU speed, memory size, HDD size, Operating System, LCD type, and whether a DVD-ROM drive, a DVD-ROM & CD-R/RW drive or a DVD MULTI drive is included or not.

To check the model number:

Check the bottom of the computer or the box the computer came in at the time of purchase.

To check CPU speed, memory size and the hard disk drive (HDD) size:

Run the Setup Utility (⇒ *Reference Manual* “Setup Utility”) and select [Information] menu.

Confirm the required information by checking the following items.

CPU speed:[CPU Speed]

Memory size:[System Memory]

Hard disk drive size:[Primary Master]

■ Main Specifications

Model No.		CF-51GAMBAKM CF-51GAMDAKM CF-51GAMEAKM	CF-51ABLDKAM CF-51ABLEAKM CF-51ABLBKAM
CPU		Intel® Pentium® M Processor 1.6 GHz, 1 MB* ¹ L2 cache	Intel® Pentium® M Processor 735 (1.70 GHz, 2 MB* ¹ L2 cache, 400 MHz FSB)
Memory		256 MB* ¹ (2048 MB* ¹ * ² Max.)	512 MB* ¹ (2048 MB* ¹ * ² Max.)
Video Memory		64 MB* ¹	
LCD	Type	15.0 XGA type (TFT)	15.0 UXGA type (TFT)
	Displayed Colors* ³	65536/Approx.16,000,000 col- ors (800 × 600 dots/1024 × 768 dots)	65536/Approx.16,000,000 col- ors (800 × 600 dots/1024 × 768 dots/1280 × 1024 dots/1600 × 1200 dots)
External Display		65536/Approx.16,000,000 colors (800 × 600 dots/1024 × 768 dots/1280 × 1024 dots/1600 × 1200 dots/2048 × 1536 dots)* ⁴	
Hard Disk Drive		40 GB* ⁵	60 GB* ⁵
Battery Pack		Li-ion 11.1 V, 6.6 Ah	
Operating Time* ⁶	Main Battery		Approx. 2.5 hours - 6.5 hours* ⁷ (Approx. 6.0 hours* ⁸)
	Main Battery + Second Battery		Approx. 4.0 hours - 8.5 hours* ⁷ (Approx. 9.5 hours* ⁸)
Charging Time* ⁶	Power On	Main Battery	Approx. 4.0 hours
		Main Battery + Second Battery	Approx. 6.5 hours
	Power Off	Main Battery	Approx. 4.0 hours
		Main Battery + Second Battery	Approx. 6.5 hours
Clock Battery		Coin type lithium battery 3.0 V	

*¹ 1MB = 1,048,576 bytes

*² When expanding memory, remove the RAM module that was inserted at the time of factory shipment, and insert two 1024 MB-RAM modules.

*³ A 16,000,000 color display is achieved by using the dithering function.

*⁴ Maximum resolution depends on the specifications of the external display.

*⁵ 1GB = 1,000,000,000 bytes. Your operating system or some application software will report as fewer GB.

*⁶ Varies depending on the usage conditions.

*⁷ Measured using BatteryMark™ Version 4.0.1 (LCD brightness: Maximum - Minimum)

*⁸ Measured using MobileMark™ 2002 (LCD brightness: 60 cd/m²)

■ Main Specifications

Slots	PC Card Slots		Two Type I or Type II, or one Type III
		Allowable current (total for two slots)	3.3 V: 400 mA 5 V: 400 mA
	RAM Module Slot		200-pin, SO-DIMM, DDR SDRAM, PC2700 Compliant ^{*1}
Interface	Parallel Port		Dsub 25-pin female
	External Display Port		Mini Dsub 15-pin female
	Serial Port		Dsub 9-pin male
	Microphone Jack ^{*2}		Miniature jack, 3.5 DIA
	Headphone Jack		Miniature jack, 3.5 DIA Impedance 32 Ω, Output Power 4 mW × 2
	External Keyboard/ Mouse Port		Mini DIN 6-pin female
	Expansion Bus Connector		Dedicated 100-pin female
	USB Port		4-pin × 2, USB 2.0
	Modem		RJ-11 Data: 56 kbps (V.92 & K56flex) FAX:14.4 kbps
	LAN		RJ-45 IEEE 802.3 10Base-T, IEEE 802.3u 100Base-TX, IEEE 802.3ab 1000Base-T
	Wireless LAN		IEEE802.11b/g
IEEE1394 Interface Connector		4-pin × 1	
Pointing Device			Touch Pad
Speaker			Stereo Speaker
Sound			WAVE and MIDI playback
Keyboard			87 keys
Operating System			Microsoft® Windows® XP Professional with Service Pack 1a
Utility Programs			Setup Utility, DMI Viewer, Adobe® Acrobat® Reader, Hard Disk Data Erase Utility ^{*3} , PC Information Viewer, Icon Enlarger, WinDVD™ 5 (OEM Version), B's Recorder GOLD7 BASIC, B's CLiP 5, Intel® PROSet
AC Adaptor ^{*4}	Input		100 V - 240 V AC, 50 Hz/60 Hz
	Output		15.6 V DC, 5.0 A
Power Consumption ^{*5}			Approx. 35 W ^{*6} / Approx. 90 W (maximum when recharging in the ON state)
Environ- ment	In use	Temperature	5 °C to 35 °C {41 °F to 95 °F}
		Humidity	30% to 80% RH (No condensation)
	Not in use	Temperature	-20 °C to 60 °C {-4 °F to 140 °F}
		Humidity	30% to 90% RH (No condensation)
Physical Dimensions (W × H × D)			325 mm × 47 mm × 278 mm {12.8 " × 1.9 " × 10.9 "}
Weight	with the DVD-ROM & CD-R/RW drive inserted in the multimedia pocket		Approx. 3.0 kg {Approx. 6.7 lb.}
	with no devices inserted in the multi-media pocket		Approx. 2.8 kg {Approx. 6.2 lb.}

^{*1} Either a PC2700-compliant RAM module or a PC2100-compliant RAM module can be added.

^{*2} Use only a monaural condenser microphone.

^{*3} The Product Recovery DVD-ROM is required.

^{*4} The AC adaptor is compatible with power sources up to 240 V AC adaptor. This computer is supplied with a 125 V AC compatible AC cord.

^{*5} Approx. 0.9 W when the battery pack is fully charged (or not being charged) and the computer is OFF.

Approx. 1.5 W when the Wake up from LAN has been enabled.

^{*6} Rated power consumption.

Specifications

■ Multimedia Pocket (DVD-ROM & CD-R/RW Drive or DVD MULTI Drive)

Model No.		CF-51GAMBAKM CF-51GAMDAKM*1 CF-51ABLDADM*1 CF-51ABLABKM	CF-51GAMEAKM*1 CF-51ABLEAKM*1
Drive		DVD-ROM & CD-R/RW Drive	DVD MULTI Drive
Supports	DVD	DVD-ROM (Single Layer, Dual Layer), DVD-R*2 (3.95 GB*3, 4.7 GB*3), DVD-RW*2 (4.7 GB*3), DVD-RAM*2*4 (2.6 GB*3, 4.7 GB*3)	DVD-ROM (Single Layer, Dual Layer), DVD-R*2 (3.95 GB*3, 4.7 GB*3), DVD-RW (4.7 GB*3), DVD-RAM*2*4 (2.6 GB*3, 4.7 GB*3)
	CD	CD-Audio, CD-ROM, CD-R, Photo CD, VideoCD, Enhanced Music CD, CD-RW, CD-TEXT	
DVD-ROM read*5		8X speed (Max.)	
CD-ROM read*5		24X speed (Max.)	
CD-R write*6		4X speed, 8X speed, 16X speed (Max.), 24X speed (Max.)	4X speed, 8X speed, 16X speed (Max.)
CD-RW write		4X speed	
High-Speed CD-RW write		4X speed, 8X speed, 10X speed	4X speed, 8X speed
Ultra-Speed CD-RW write		10X speed, 16X speed (Max.), 24X speed (Max.)	_____
DVD-R write		_____	2X speed
DVD-RW write		_____	1X speed
DVD-RAM write		_____	2X speed

■ Multimedia Pocket (Floppy Disk Drive)

Model No.	CF-51GAMDAKM*1/CF-51GAMEAKM*1/CF-51ABLDADM*1/ CF-51ABLEAKM*1
Floppy Disk Drive	720 KB*7/1.44 MB*8 (two-mode)

*1 The drives included in the computer cannot be inserted into the multimedia pocket simultaneously.

*2 Read only.

*3 1GB = 1,000,000,000 bytes. Your operating system or some application software will report as fewer GB.

*4 In the case of DVD-RAM, only non-cartridge discs or removable cartridge discs can be used.

*5 If an unbalanced disc (e.g., a disc with which the balance has been displaced from the center) is inserted, the speed may become slower if there are large vibrations while the disc is rotating.

*6 Depending on the disc, the writing speed may become slower.

*7 1KB = 1,024 bytes

*8 1MB = 1,024,000 bytes. Your operating system or some application software will report as fewer MB.

LIMITED WARRANTY

For U.S.A.

PANASONIC PERSONAL COMPUTER AND PERIPHERALS LIMITED WARRANTY

Panasonic Computer Solutions Company (referred to as "Panasonic") will repair this product (other than software, which is covered by a separate warranty) with new or rebuilt parts, free of charge in the U.S.A. for three (3) years from the date of original purchase in the event of a defect in materials or workmanship. This warranty includes the AC adaptor but excludes the batteries and all other options and accessories which are covered for a period of one (1) year from the date of purchase.

This warranty is extended solely to the original purchaser. A purchase receipt or other proof of date of original purchase will be required before warranty performance is rendered.

This warranty only covers failures due to defects in materials or workmanship which occur during normal use. It does not cover damage which occurs in shipment or failures which are caused by products not supplied by Panasonic, or failures which result from alteration, accident, misuse, introduction of liquid or other foreign matter into the unit, abuse, neglect, installation, maladjustment of consumer controls, improper maintenance, modification or service by anyone other than a Factory Service Center or authorized Panasonic Service Dealer, or damage that is attributable to acts of God.

Limits and Exclusions:

There are no other express warranties except as listed below.

PANASONIC SHALL NOT BE LIABLE FOR LOSS OF DATA OR OTHER INCIDENTAL OR CONSEQUENTIAL DAMAGES RESULTING FROM THE USE OF THIS PRODUCT, OR ARISING OUT OF ANY BREACH OF THIS WARRANTY. ALL EXPRESS AND IMPLIED WARRANTIES, INCLUDING THE WARRANTIES OF MERCHANTABILITY AND FITNESS FOR A PARTICULAR PURPOSE ARE LIMITED TO THE APPLICABLE WARRANTY PERIOD SET FORTH ABOVE. Some states do not allow the exclusion or limitation of incidental or consequential damages, or limitations on how long an implied warranty lasts, so the above limitations or exclusions may not apply to you.

This limited warranty gives you specific legal rights, and you may also have other rights which vary from state to state. If a problem with your product develops during or after the warranty period, you may contact our representatives at 1-800-LAPTOP5. If the problem is not handled to your satisfaction, then write to the Consumer Affairs Division at the address indicated below.

SOFTWARE LIMITED WARRANTY

Panasonic Computer Solutions Company (referred to as "Panasonic") warrants to you only that the disk(s) or other media on which the Programs are furnished will be free from defects in materials and workmanship under normal use for a period of sixty (60) days from the date of delivery thereof to you, as evidenced by your purchase receipt.

This is the only warranty Panasonic makes to you. Panasonic does not warrant that the functions contained in the Programs will meet your requirements or that the operation of the Programs will be uninterrupted or error free.

Panasonic's entire liability, and your exclusive remedy under this warranty shall be limited to the replacement, in the United States, of any defective disk or other media which is returned to Panasonic's Authorized Service Center, together with a copy of the purchase receipt, within the aforesaid warranty period.

Anything in the foregoing to the contrary notwithstanding, Panasonic shall have no obligation for any defects in the disk(s) or other media on which the Programs are furnished resulting from your storage thereof, or for defects that have been caused by operation of the disk(s) or other media otherwise than on the Product or in environmental conditions other than those specified by Panasonic by alteration, accident, misuse, abuse, neglect, mishandling, misapplication, installation, maladjustment of consumer controls, improper maintenance, modification of damage that is attributable to acts of God. In addition, Panasonic shall have no obligation for any defects in the disk(s) or other media if you have modified, or attempted to modify any Program.

DURATION OF IMPLIED WARRANTIES, IF ANY, IS LIMITED TO SIXTY (60) DAYS.

PANASONIC ASSUMES NO RISK OF AND SHALL NOT IN ANY CASE BE LIABLE FOR ANY DAMAGES, INCLUDING, WITHOUT LIMITATION, ANY SPECIAL, INCIDENTAL, CONSEQUENTIAL, OR PUNITIVE DAMAGES ARISING FROM BREACH OF WARRANTY OR CONTRACT, NEGLIGENCE OR ANY OTHER LEGAL THEORY, INCLUDING, WITHOUT LIMITATION LOSS OF GOODWILL, PROFITS OR REVENUE, LOSS OF USE OF THE PROGRAMS OR PRODUCTS OR ANY ASSOCIATED EQUIPMENT, COST OF CAPITAL, COST OF ANY SUBSTITUTE EQUIPMENT, FACILITIES, SERVICES, DOWNTIME COSTS, OR CLAIMS OF ANY PARTY DEALING WITH YOU FOR SUCH DAMAGES.

Some states do not allow the exclusion or limitation of incidental or consequential damages, or limitations on how long an implied warranty lasts, so the above limitations or exclusions may not apply to you.

This limited warranty gives you specific legal rights, and you may also have other rights which vary from state to state.

This Limited Warranty will be governed by the laws the State of New York, without regard to its conflict-of-laws rules.

* * *

To obtain service or technical assistance within the continental U.S.A. and Alaska.

DIAL TOLL FREE: 1-800-LAPTOP5

Correspondence requesting product information should be sent to:
Panasonic Computer Solutions Company
50 Meadowlands Parkway, Panazip 2F-5, Secaucus, NJ 07094

LIMITED WARRANTY

For Canada

PANASONIC COMPUTER AND PERIPHERALS LIMITED WARRANTY

Coverage - Panasonic Canada Inc. ("PCI") warrants to you, the first end user customer, this computer product (excluding software media), when purchased from PCI or from a PCI authorized reseller, to be free from defects in materials and workmanship under normal use, subject to the terms set forth below, during the period of warranty coverage specified.

Scope of Coverage	Period of Coverage	Type of Failure Coverage
Whole Product (except Batteries), AC adaptor and CD-ROM (if factory installed)	Three (3) Years from Date of Original End User Customer Purchase	Defective Materials or Workmanship
Batteries, CD-ROM (unless factory installed), Port Replicator, Extra Memory Modules and all other Peripherals, Options and Accessories	One (1) Year from Date of Original End User Customer Purchase	Defective Materials or Workmanship

Remedy - In the event of a warranty claim, contact PCI's representatives within the applicable warranty period, identifying the nature of the defect claimed, at 1-800-668-8386 between 9:00 A.M. and 5:00 P.M., Eastern Time Zone, Mon. - Fri. (excluding holidays) for instructions on how to obtain service. A purchase receipt or other proof of date of original purchase is required before warranty service is performed. Defective parts covered by this Limited Warranty will be repaired or replaced with new or comparable rebuilt parts on an exchange basis. Warranty replacement or repair is subject to the terms of this Limited Warranty for the balance of the original period of warranty coverage.

No Coverage - This Limited Warranty does not cover products purchased outside Canada. Neither does it cover damage to, failure of, or defects in a product or accessory through mishandling, improper installation, abnormal use, misuse, neglect, accident, introduction of liquid or other foreign matter into the product, alteration or servicing by anyone not authorized by PCI, or act of God.

IF YOU SHIP THE PRODUCT FOR WARRANTY SERVICE

Carefully pack the product, preferably in the original carton. Include details of defect claimed and proof of date of original purchase. No liability is assumed for loss or damage to the product while in transit, if you chose your own transportation carrier.

SOFTWARE MEDIA LIMITED WARRANTY

Coverage - Panasonic Canada Inc. ("PCI") warrants to you, the first end user customer, that the disk(s) or other media on which software program(s) is/are supplied will be free from defects in materials and workmanship under normal use in Canada for a period of sixty (60) days from date of receipt as evidenced by your purchase receipt for your Panasonic Computer product.

THIS IS THE ONLY WARRANTY THAT PCI MAKES RESPECTING THE SOFTWARE MEDIA. PCI does not warrant the software. Please refer to the software licensor's written warranty (accompanying the copy of the software) for any software warranty claim.

Claim Procedure - In the event of a defect in material or workmanship in the media during the sixty (60) day warranty period, and you return it, transportation costs prepaid, to Panasonic Canada Inc., Computer Products Marketing, at the above address, within the warranty period, together with a copy of your purchase receipt, and an explanation of the suspected defect, PCI will replace in Canada the defective disk(s) or other media.

Remedy - PCI's entire liability, and your only remedy for any breach of this software media warranty is limited to replacement of the media only. It does not cover any other damages, including, but not limited to, loss of use or profit loss, or special, indirect or consequential damages, or other claims, whether or not of similar character.

No Coverage - This limited warranty does not apply if the disk(s) or other media has been used in other than a Panasonic product, or in environmental conditions other than those specified by PCI or the manufacturer, or if subjected to misuse, neglect, mishandling, modification or attempted modification of the program, or if damaged by accident or act of God. PCI is not responsible for damage to or loss of any program, data or removable storage media.

GENERAL

NO OTHER WARRANTIES - PCI DISCLAIMS ALL OTHER WARRANTIES, EITHER EXPRESS OR IMPLIED, INCLUDING, BUT NOT LIMITED TO, IMPLIED WARRANTIES OF MERCHANTABILITY AND FITNESS FOR A PARTICULAR PURPOSE, WITH RESPECT TO THE SOFTWARE, SOFTWARE MEDIA, COMPUTER PRODUCT, OPTIONS AND ACCESSORIES.

NO LIABILITY FOR CONSEQUENTIAL DAMAGES - IN NO EVENT SHALL PCI BE LIABLE FOR ANY SPECIAL, INDIRECT OR CONSEQUENTIAL DAMAGES ARISING FROM ANY BREACH OF THE LIMITED WARRANTIES SET OUT IN THIS DOCUMENT, OR FROM THE USE OF THE COMPUTER PRODUCT, INCLUDING, WITHOUT LIMITATION, LOSS OF DATA, BUSINESS, PROFIT OR GOODWILL.

IN ANY EVENT, PCI'S MAXIMUM LIABILITY FOR ANY BREACH SHALL NOT EXCEED THE AMOUNT ACTUALLY PAID BY YOU FOR THE COMPUTER PRODUCT.

NO ACTION, REGARDLESS OF ITS BASIS, MAY BE BEGUN AGAINST PCI MORE THAN TWO (2) YEARS AFTER THE CAUSE OF ACTION AROSE.

Statutory Warranties - Some jurisdictions do not allow these limitations or exclusions, so they may not apply to you.



As an ENERGY STAR[®] Partner, Matsushita Electric Industrial Co., Ltd. has determined that this product meets the ENERGY STAR[®] guidelines for energy efficiency.

Outline of the International ENERGY STAR[®] Office Equipment Program

The international ENERGY STAR[®] Office Equipment Program is an international program that promotes energy saving through the use of computers and other office equipment. The program backs the development and dissemination of products with functions that effectively reduce energy consumption. It is an open system in which business proprietors can participate voluntarily. The targeted products are office equipment such as computers, displays, printers, facsimiles, and copiers. Their standards and logos are uniform among participating nations.

Panasonic Computer Solutions Company
50 Meadowlands Parkway, Panazip 2F-5,
Secaucus, NJ 07094

Panasonic Canada Inc.
5770 Ambler Drive Mississauga,
Ontario L4W 2T3

