

**Personal Computer
Model No. CF-20 Series
Connect to a network**



Disclaimer

Computer specifications and manuals are subject to change without notice. Panasonic Corporation assumes no liability for damage incurred directly or indirectly from errors, omissions or discrepancies between the computer and the manuals. Refer for the latest information about optional products to the catalogs, etc.

Trademarks

- Microsoft, Windows and the Windows logo are registered trademarks or trademarks of Microsoft Corporation of the United States and/or other countries.
- Intel, Core, and PROSet are either registered trademarks or trademarks of Intel Corporation.
- Names of products, brands, etc., appearing in this manual are trademarks or registered trademarks of their respective own companies.

© Panasonic Corporation 2017

HS1217-0
20170278ZAP

Illustrations and Terminology in this manual

- This manual explains using the default setting.
- In principle, this manual explains based on the following conditions:
 - When the tablet and keyboard base have been installed
 - When the keyboard and touchpad are used for operation
- Some illustrations are simplified to help your understanding and may look different from the actual unit.
- Some types of software are automatically updated, and differences may occur from descriptions in this manual.
- If you do not sign in as an administrator, you cannot use some functions or cannot display some screens.
- This manual explains operation procedures using the touchpad or mouse as typical examples. In addition, you can touch the display screen to operate the computer.
When using the touch operation, please replace the terms as described below, and read the instructions.



Operation terms to be replaced:

- Click → Touch
- Double-click → Double-touch
- Right-click → Touch and hold (Long touch)

Terms and illustrations in these instructions.

- CAUTION: Conditions that may result in minor or moderate injury.
- NOTE: Useful and helpful information.
- « Enter » : This means to press the Enter key.
- « Fn » + « F7 » :
This illustration means to press and hold « Fn » key, and then press « F7 » key.
- The display of the key may be different from this manual according to the keyboard used. (e.g. "Delete" instead of "Del")



- Click  (Start) and then click  (Power).

In these instructions, the names are referred as follows.

- "Windows 10 Pro 64-bit" as "Windows" or "Windows 10"

Regarding Windows 10

Desktop mode and Tablet mode

Windows 10 offers the desktop mode in which operation is performed using the keyboard or touchpad, and also the tablet mode optimized for the touch panel operation.

The mode can be switched by clicking  (Notification), and then clicking  (Tablet mode) tile.

In this manual, the tablet mode may refer to the status when the tablet detached from the keyboard base is used.

In the tablet mode, operations from the Start screen are explained.

NOTE

If some icons do not appear on the task bar, perform the following operations.

1. Touch and hold the task bar.
2. Select the item to display.

Screen Messages

Screen messages are explained in [English (United States)].

(Depending on the language preference, some screen messages in these instructions are different from the actual screen messages. For example, [Flight mode] may be displayed instead of [Airplane mode] in some language preference)

Opening the Control Panel

1. Click  (Start) - [Windows System] - [Control Panel].

Opening the Settings

1. Click  (Start) -  (Settings).

Alternatively, click  (Settings) in the tablet mode.

Latest Information on Windows 10

When Microsoft® Windows® 10 is updated, the screen display or operation procedures may be changed.

For the latest information on Windows 10, see the following web page.

<http://pc-dl.panasonic.co.jp/itn/addendum/>

<Only for model with LAN>

Connecting LAN

CAUTION

- Do not connect the telephone cable to the LAN port.

1. Turn off the computer.
 - Do not use sleep or hibernation.
2. Slide the cover and open it.
3. Connect the LAN cable.
 - Connect the LAN port (A) and the network system (server, HUB, etc.) using a LAN cable.

Keyboard base

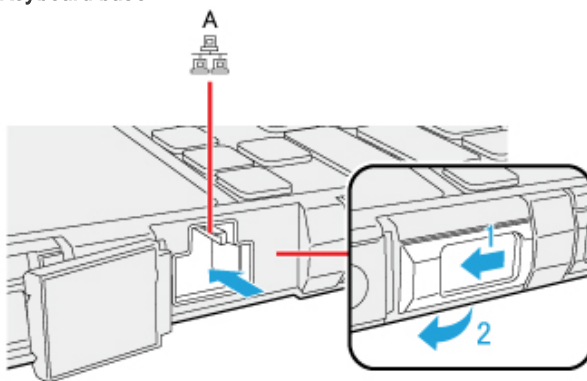

CAUTION

- Do not remove the main unit from keyboard base while using the LAN function.

Main Unit

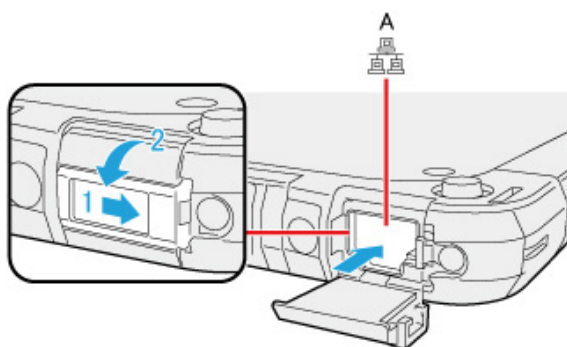

4. Turn on the computer.

Wake Up from wired LAN function

When the Wake Up from wired LAN function is enabled, the computer automatically resumes from sleep or hibernation when the computer is accessed from the network server via the internal LAN port.



1. Right-click  (Start) - [Device Manager].
2. Double-click the Ethernet device under “Network adapters”, and then click [Power Management].
3. Add a checkmark to [Allow this device to wake the computer].
4. Click [OK].

NOTE

- The setting made is enabled after restarting the computer.
- The LAN port of keyboard base does not support the Wake Up from wired LAN function.

Disabling/Enabling Wireless Communication

<Only for model with wireless LAN>

There are several ways of disabling and enabling wireless communication.

- Using airplane mode
- Setting [\[Wireless Configuration\]](#) in the [\[Advanced\]](#) menu of the Setup Utility
- Settings in the Network and Sharing Center ( [Using the Wireless LAN Function](#))

NOTE

- For further information about [Wireless LAN](#).

Using airplane mode^{*1}

(For wireless LAN)

1. Click  (Start) -  (Settings) - [\[Network & Internet\]](#) - [\[Airplane mode\]](#)^{*1}.

Alternatively click  (Settings) - [\[Network & Internet\]](#) - [\[Airplane mode\]](#)^{*1} in the tablet mode.

2. **To disable wireless communications, set [\[Airplane mode\]](#)^{*1} to [\[On\]](#).**
To enable wireless communications, set [\[Airplane mode\]](#)^{*1} to [\[Off\]](#), and then;
 - set [\[Wi-Fi\]](#)^{*1} to [\[On\]](#) (for wireless LAN).

^{*1} : Screen messages are explained in [\[English \(United States\)\]](#).

(Depending on the language preference, some screen messages in these instructions are different from the actual screen messages. For example, [\[Flight mode\]](#)/[\[Wi-Fi\]](#) may be displayed instead of [\[Airplane mode\]](#)/[\[Wi-Fi\]](#) in some language preference.)

Wireless LAN

<Only for model with wireless LAN>

CAUTION

- **Do not use wireless LAN on airplanes, in hospitals, or in other locations where wireless LAN signals may affect devices.**
Follow the instructions of airline companies and hospitals. If you use the computer in these locations, turn off the wireless LAN.
- **To avoid unauthorized access to the computer through wireless LAN**
We recommend you to make security settings such as encryption before using wireless LAN.
Otherwise the hard disk data such as the shared files can be exposed to the risk of unauthorized access.

NOTE

- Communication is established through the wireless LAN antenna (A). Do not block the antenna area with your hand or body.

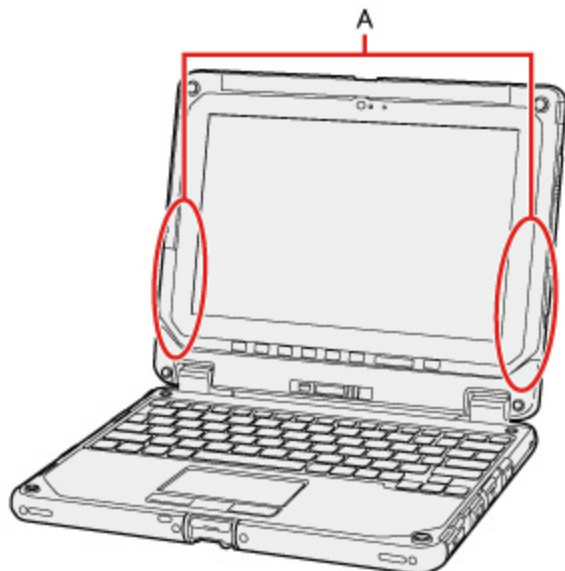

- The transmission rate will be lower when a microwave oven is used near by.
- To use wireless LAN, set [Wireless LAN] of [Wireless Configuration] to [Enabled] (default) in the [Advanced] menu of the Setup Utility.

Using the Wireless LAN Function

Before using a wireless LAN, turn the wireless LAN communication on.



Turning on/off the wireless LAN communication

1. To enable the wireless communication (→ [Disabling/Enabling Wireless Communication](#)).

Setting the wireless LAN access point

Preparation

Follow the instruction manual of the wireless LAN access point to make settings for the access point to recognize the computer.

1. Turn the wireless LAN on.
2. Click  or  on the task tray.
3. Select an access point, and click [Connect].
4. Input the key you set for the access point to recognize the computer, and click [Next].

Wait for the computer to connect to the wireless LAN access point.

When the icon on the task tray is changed to , the wireless LAN setting is complete.







NOTE

- The settings depend on the network environment. For further information, ask the system administrator or the person in charge of the network.
- If you use the stealth type wireless LAN access point which restricts automatic detection of the wireless LAN access point, take the following procedure.
If you do not perform the procedure below, you may not be able to access the wireless LAN access point automatically or the wireless LAN access point may not be displayed.

1. Click  on the task tray, and then click [Hidden network].
2. Click [Connect], enter the necessary information such as the network name (SSID), and click [Next].

For further information, ask the system administrator or the person in charge of the network.

Enabling/Disabling the Wireless LAN Standard IEEE802.11a (802.11a)

1. Click  (Start) - [Panasonic] - [Panasonic PC Settings Utility], and click  (Settings) -  (Network).
Alternatively click  (All apps) - [Panasonic] - [Panasonic PC Settings Utility], and click  (Settings) -  (Network) in the tablet mode.
2. Click [Enabled] or [Disabled] for the wireless LAN IEEE802.11a.

NOTE

- In some countries, communication using IEEE802.11a (5 GHz wireless LAN) standard is restricted by law.
- If IEEE802.11a is enabled or disabled while the computer is connected to an IEEE802.11b/g access point, the connection will be temporarily interrupted.

Troubleshooting (Advanced)



Refer to the following instructions when a problem occurs. If the remedies indicated in the chart do not solve the problem, contact Panasonic Technical Support.

For a software problem, refer to the instruction manual of the software.

Network

Cannot connect to a network.	<ul style="list-style-type: none"> Set the device ([Tablet LAN] / [Wireless LAN]) to [Enabled] in the [Advanced] menu of the Setup Utility.
Cannot check the computer's MAC address.	<ul style="list-style-type: none"> Follow the steps below. <ol style="list-style-type: none"> Right-click  (Start) - [Windows Power-Shell]. Input "getmac /fo list /v", and press << Enter >> . <ul style="list-style-type: none"> Insert a space between "fo" and "list", and between "list" and "/v". Wireless LAN's MAC address: Make a note of the 12-digit string of alphanumeric displayed on "Physical Address" line of "Wi-Fi". Wired LAN's MAC address: Make a note of the 12-digit string of alphanumeric displayed on "Physical Address" line of "Ethernet". Input "exit", and press << Enter >> .

Wireless Communication (only for model with wireless LAN)

Cannot connect to a network.	<ul style="list-style-type: none"> Confirm the airplane mode is Off. To turn off the airplane mode, follow the steps below. <ol style="list-style-type: none"> Click  (Start) -  (Settings) - [Network & Internet] - [Airplane mode]^{*1}. Alternatively click  (Settings) - [Network & Internet] - [Airplane mode]^{*1} in the tablet mode. Click [Airplane mode]^{*1} to [Off], and then; set [Wi-Fi]^{*1} to [On] (for wireless LAN). Restart the computer.
Access point is not detected.	<ul style="list-style-type: none"> Shorten the distance between the computer and the access point, and try the detection again. Confirm the following settings: <ul style="list-style-type: none"> Wireless LAN in the [Advanced] menu of the Setup Utility Confirm that Wireless LAN of [Wireless Configuration] is set to [Enabled]. Airplane mode Confirm that Wireless LAN (Wi-Fi) is ON. This computer uses channels 1 through 11^{*2} when using IEEE802.11b/g/n. Check the channel being used by the access point.

*1 : Screen messages are explained in [English (United States)].



(Depending on the language preference, some screen messages in these instructions are different from the actual screen messages. For example, [Flight mode] / [Wi-Fi] may be displayed instead of [Airplane mode] / [Wi-Fi] in some language preference.)

*2 : In the case of wireless communications, the frequency band being used can be divided into segments, so that different communications can be conducted on each band segment. A "Channel" refers to the individual frequency bandwidth divisions.

Setup Utility

You can make the settings of the computer's operating environment (password settings, startup drive selection, etc.)

Starting the Setup Utility

1. Click  (Start) -  (Settings) - [Update & security] - [Recovery].
2. Click [Restart now] under "Advanced startup"*1.

*1: Screen messages are explained in [English (United States)].

(Depending on the language preference, some screen messages in these instructions are different from the actual screen messages. For example, [Advanced start-up] may be displayed instead of [Advanced startup] in some language preference.)

3. Click [Troubleshoot] - [Advanced options] - [UEFI Firmware Settings] - [Restart].
The computer restarts, and the Setup Utility screen appears.

NOTE

- When the fast startup is enabled, Setup Utility cannot be started by pressing << F2 >> or << Del >> during the startup procedure.

When [Enter Password] is displayed, enter your password.

When you start the Setup Utility with Supervisor Password

- You can make the settings of all items of the Setup Utility.

When you start the Setup Utility with User Password

- Note the following:
 - In the [Advanced] and [Boot] menus, you cannot make the settings of all items.
 - In the [Security] menu, you can change only the User Password when [User Password Protection] is set to [No Protection]. You cannot delete the User Password.
 - In the [Exit] menu, you cannot make the setting of [Load Default Values] and [Boot Override].
 - << F9 >> (Setup Defaults) does not function.

NOTE

- Setup Utility screen is displayed on the internal LCD even when an external display is connected to the computer as the factory default. However, if the LID (display) is closed, it will come to be displayed on an external display.
- Windows 10 supports UEFI boot.
- The [Panasonic] boot screen may not appear when only the external display is being used. In this case, as soon as the computer starts up, press << F2 >> or << Del >> several times and start the Setup Utility.

Advanced Menu

Underlined items are the factory presets.

Peripheral Configuration

Tablet LAN <ul style="list-style-type: none">• Only for Main Unit	Disabled <u>Enabled</u>
Power On by LAN <ul style="list-style-type: none">• Can be changed only when [LAN] is set to [Enabled].	<u>Deny</u> Allow
▶ Wireless Configuration <ul style="list-style-type: none">• The submenu appears when this item is selected.	Enters the sub-menu.

Sub-menu (Wireless Configuration)

Wireless Ready Indicator	Disabled <u>Enabled</u>
Wireless LAN <ul style="list-style-type: none">• Only for model with wireless LAN	Disabled <u>Enabled</u>