

Personal Computer Model No. FZ-M1 Series Connect to a network

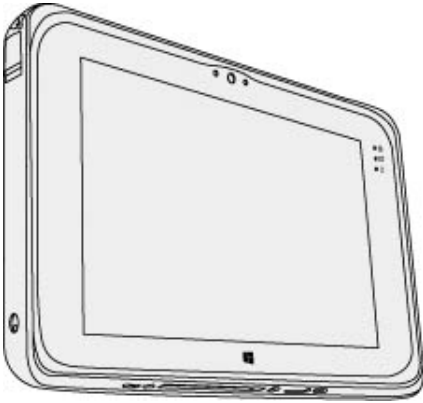

Disclaimer

Computer specifications and manuals are subject to change without notice. Panasonic Corporation assumes no liability for damage incurred directly or indirectly from errors, omissions or discrepancies between the computer and the manuals. Refer for the latest information about optional products to the catalogs, etc.

Trademarks

- Microsoft, Windows, and the Windows logo are registered trademarks or trademarks of Microsoft Corporation of the United States and/or other countries.
- Intel, Core, and PROSet are either registered trademarks or trademarks of Intel Corporation.
- Names of products, brands, etc., appearing in this manual are trademarks or registered trademarks of their respective own companies.

Introduction

Illustrations and Terminology in this manual

This manual explains using the default setting.





"Windows 10 Pro" as "Windows" or "Windows 10"

Terms and illustrations in these instructions.

<Only when connected to the external keyboard>



«Enter»: This means to press the Enter key.

«Ctrl» + «F7»: This means to press and hold «Ctrl» key, and then press «F7» key.

- The display of the key may be different from this manual according to the keyboard used. (e.g. "Delete" instead of "Del")
-  -  :
Touch  (Start) and then touch  (Power).
- Some illustrations and display examples may look different from the actual product. Some types of software are automatically updated, and differences may occur from descriptions in this manual.

Tablet mode and Desktop mode

Windows 10 offers the tablet mode optimized for the touch panel operation, and also the desktop mode in which operation is performed using the keyboard and touch panel.

The mode can be switched by touching  (Notification), and then touching  (Tablet mode) tile.

NOTE

If some icons do not appear on the task bar, perform the following operations.

1. Touch and hold the task bar.
2. Select the item to display.



Regarding Windows 10

Screen Messages



Screen messages are explained in [English (United States)].

(Depending on the language preference, some screen messages in these instructions are different from the actual screen messages. For example, [Flight mode] may be displayed instead of [Airplane mode] in some language preference)

Displaying Apps

1. Touch  (All apps).
Alternatively, touch  (Start) at the bottom left corner in the desktop mode.

Opening the "Settings" screen

1. Touch  (Settings).
Alternatively, touch  (Start) -  (Settings) in the desktop mode.

Opening the Control Panel

On the Start screen, proceed as follows.

1. Touch  (All apps) - [Windows System] - [Control Panel].

Alternatively, touch  (Start) - [Windows System] - [Control Panel] in the desktop mode.

Notification area

The notification area is on the right side of the screen.

To display the notification, touch  (Notification) on the task tray.

LAN

<Only for model with LAN>

Connecting LAN

CAUTION

- Do not connect the telephone cable to the LAN port.
-

1. Turn off the computer.
 - Do not use sleep or hibernation.
2. Connect the cable.
 - Connect the LAN port (A) and the network system (e.g., server, hub) using a LAN cable.

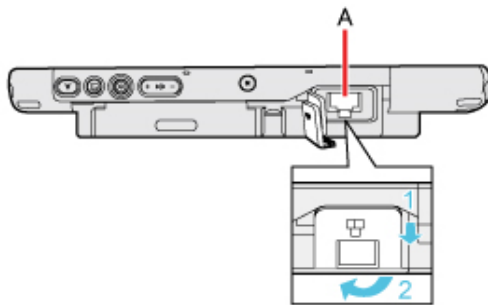

3. Turn on the computer.

Disabling/Enabling Wireless Communication

<Only for model with wireless LAN, Bluetooth, and/or wireless WAN>

There are several ways of disabling and enabling wireless communication.

- Using airplane mode
- Setting [Wireless Configuration] in the [Advanced] menu of the Setup Utility
- Settings in the Network and Sharing Center ( Using the Wireless LAN Function)

NOTE

- For further information about [Wireless LAN](#).
 - For further information about [Bluetooth](#).
 - For further information about [Wireless WAN](#).
-

Using airplane mode*1

(For wireless LAN, wireless WAN, Bluetooth, and GPS)

1. Touch  (Settings) - [Network & Internet] - [Airplane mode]*1.

Alternatively, touch  (Start) -  (Settings) - [Network & Internet] - [Airplane mode]*1 in the desktop mode.

2. To disable wireless communications, set [Airplane mode]*1 to [On].
To enable wireless communications, set [Airplane mode]*1 to [Off], and then;
 - set [Cellular] to [On] (for wireless WAN).
 - set [Wi-Fi]*1 to [On] (for wireless LAN).
 - set [GPS] to [On] (for wireless WAN).
 - set [Bluetooth] to [On] (for Bluetooth).
 - set [GPS/GNSS] to [On] (for GPS).

*1 : Screen messages are explained in [English (United States)].

(Depending on the language preference, some screen messages in these instructions are different from the actual screen messages. For example, [Flight mode]/[WiFi] may be displayed instead of [Airplane mode]/[Wi-Fi] in some language preference.)

Wireless LAN

<Only for model with wireless LAN>

CAUTION

- **Do not use wireless LAN on airplanes, in hospitals, or in other locations where wireless LAN signals may affect devices.**
Follow the instructions of airline companies and hospitals. If you use the computer in these locations, turn off the wireless LAN.
 - **To avoid unauthorized access to the computer through wireless LAN**
We recommend you to make security settings such as encryption before using wireless LAN. Otherwise the disk data such as the shared files can be exposed to the risk of unauthorized access.
-

NOTE

- Communication is established through the wireless LAN antenna (A). Do not block the antenna area with your hand or body.

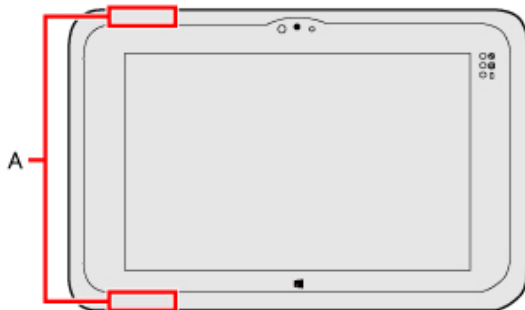

- The transmission rate will be lower when a microwave oven is used near by.
 - To use wireless LAN, set [\[Wireless LAN\]](#) of [Wireless Configuration] to [Enabled] (default) in the [Advanced] menu of the Setup Utility.
-

Using the Wireless LAN Function

Before using a wireless LAN, turn the wireless LAN communication on.



Turning on/off the wireless LAN communication

1. To enable the wireless communication (➡ [Disabling/Enabling Wireless Communication](#)).

Setting the wireless LAN access point

■ Preparation

Follow the instruction manual of the wireless LAN access point to make settings for the access point to recognize the computer.

1. Turn the wireless LAN on.
2. Touch  or  on the task tray.
3. Select an access point, and touch [Connect].
4. Input the key you set for the access point to recognize the computer, and touch [Next].
Wait for the computer to connect to the wireless LAN access point.
When the icon on the notification area is changed to , the wireless LAN setting is complete.

NOTE

- The settings depend on the network environment. For further information, ask the system administrator or the person in charge of the network.
- If you use the stealth type wireless LAN access point which restricts automatic detection of the wireless LAN access point, take the following procedure.





If you do not perform the procedure below, you may not be able to access the wireless LAN access point automatically or the wireless LAN access point may not be displayed.

1. Touch  on the task tray, and then touch [Hidden network].
2. Touch [Connect], enter the necessary information such as the network name (SSID), and touch [Next].

For further information, ask the system administrator or the person in charge of the network.

Enabling/Disabling the Wireless LAN Standard IEEE802.11a (802.11a)

1. Touch  (Panasonic PC Settings Utility) -  (Settings) -  (Network).

Alternatively, touch  (Start) -  (Panasonic PC Settings Utility) -  (Settings) -  (Network) in the desktop mode.

2. Touch [Enabled] or [Disabled] for the wireless LAN IEEE802.11a.

NOTE

- In some countries, communication using IEEE802.11a (5 GHz wireless LAN) standard is restricted by law.
 - If IEEE802.11a is enabled or disabled while the computer is connected to an IEEE802.11b/g access point, the connection will be temporarily interrupted.
-

Bluetooth

<Only for model with Bluetooth>

You can access internet and other Bluetooth devices without connecting cables.

NOTE

- Communication is established through the Bluetooth antenna (A). Do not block the antenna area with your hand or body.

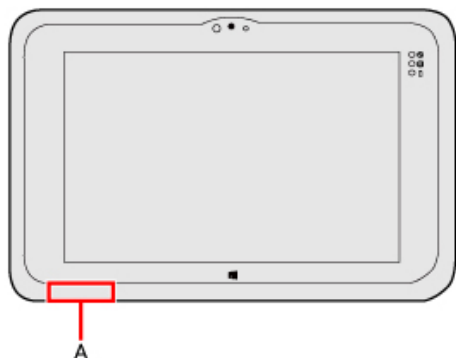

- To use Bluetooth, set [Bluetooth] of [Wireless Configuration] to [Enabled] (default) in the [Advanced] menu of the Setup Utility.
 - The transmission rate will be lower when a microwave oven is used near by.
 - When you uninstall the Bluetooth Driver, turn Bluetooth off.
-



Using the Bluetooth Function

Before using a Bluetooth, turn the Bluetooth communication on.

Turning on/off the Bluetooth communication

1. To enable the wireless communication (➡ [Disabling/Enabling Wireless Communication](#)).

2. Touch  (Settings) - [Network & Internet] - [Airplane mode]*1 to [Off].

Alternatively, touch  (Start) -  (Settings) - [Network & Internet] - [Airplane mode]*1 to [Off] in the desktop mode.



3. To turn off the Bluetooth communications, set [Bluetooth] to [Off].
To turn on the Bluetooth communications, set [Bluetooth] to [On], and then;

*1 : Screen messages are explained in [English (United States)].



(Depending on the language preference, some screen messages in these instructions are different from the actual screen messages. For example, [Flight mode] may be displayed instead of [Airplane mode] in some language preference.)

To check the Bluetooth communication status

1. Touch  (Settings) - [Devices] - [Bluetooth].

Alternatively, touch  (Start) -  (Settings) - [Devices] - [Bluetooth] in the desktop mode.

NOTE

- You can also touching  on the task tray, and then touch  (Bluetooth) - [Show Bluetooth Devices] to check the communication status.
-

Wireless WAN

<Only for model with wireless WAN>

This computer is equipped with the Wireless WAN enabling you to communicate using radio frequencies.

NOTE

- Communication is established through the Wireless WAN antenna (A). Do not block the antenna area with your hand or body.

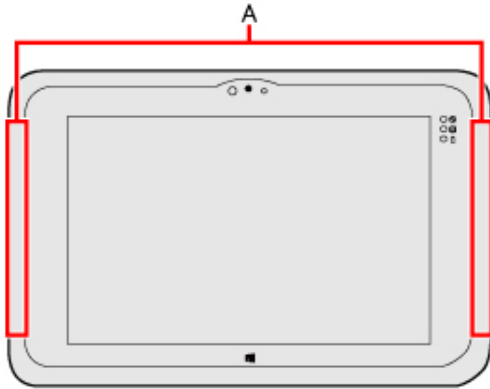

- To use wireless WAN, set [Wireless WAN] of [Wireless Configuration] to [Enabled] (default) in the [Advanced] menu of the Setup Utility.
 - Before the computer enters sleep or hibernation, cut the Wireless WAN communication. Entering sleep or hibernation without cutting the connection may disable communication after resuming. In this case, restart the computer.
 - If "Device driver software was not successfully installed" (or a similar message) appears when starting the computer or resuming from sleep or hibernation.
 - When communication works normally, Wireless WAN is operating correctly.
 - If communication fails, the device may not be recognized correctly. In this case, restart the computer.
 - Do not use the microSIM card adapter.
 - Do not insert microSIM cards on which labels or stickers are affixed. Failure to obey may result in malfunction.
-

Inserting/Removing a microSIM Card

Before using the Wireless WAN, set a microSIM card to the microSIM card slot.

CAUTION

- Be sure to turn off the computer before inserting or removing the microSIM card.
-

To insert a microSIM card

1. Turn off the computer.
2. Disconnect the AC adaptor, remove the battery pack. (➡ [Remove the Battery Pack](#))
3. Open the cover (A).

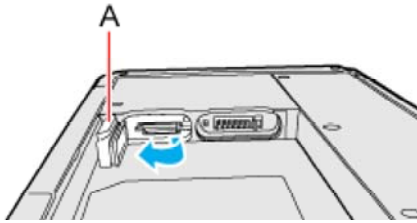

4. Insert the microSIM card into the microSIM card slot (B) with the contact side facing downward and with the cut corner oriented as shown in the illustration.

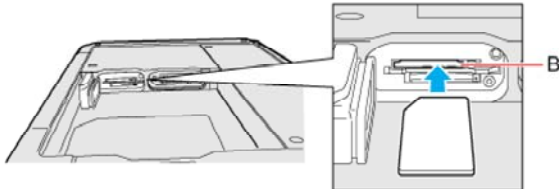

CAUTION

- Do not insert the microSIM card upside down.

5. Close the microSIM card slot cover.
 - If the cover is not closed, the microSIM card may jump out when the computer falls.
6. Insert the battery pack and connect the AC adaptor.

To remove a microSIM card

1. Turn off the computer.
2. Disconnect the AC adaptor, remove the battery pack. (➡ [Remove the Battery Pack](#))
3. Push the card.
It will come out of the slot a little bit.

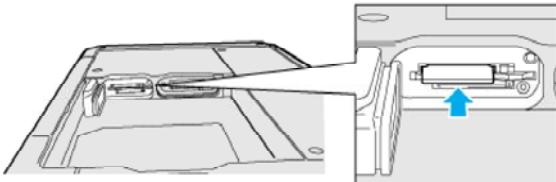

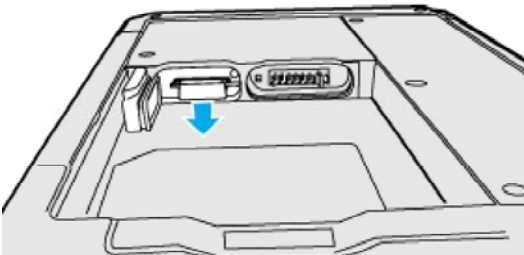

4. Pull the card all the way out.



5. Close the microSIM card slot cover.
6. Insert the battery pack and connect the AC adaptor.

Connecting to a network

1. Touch  (Settings) - [Network & Internet] - [Cellular].

Alternatively, touch  (Start) -  (Settings) - [Network & Internet] - [Cellular] in the desktop mode.

2. Touch "Cellular".
3. Touch [Advanced options].

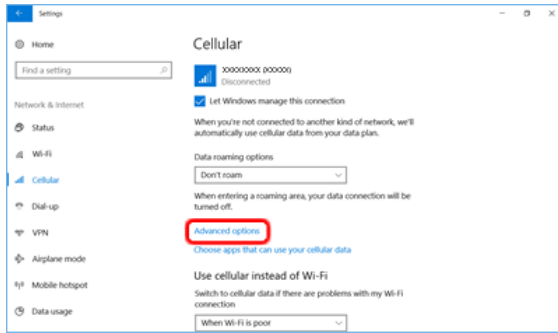

If an APN is not displayed under "Internet APN":

1. Touch [Add an APN].
2. Input detailed information such as APN, and then touch [Save].

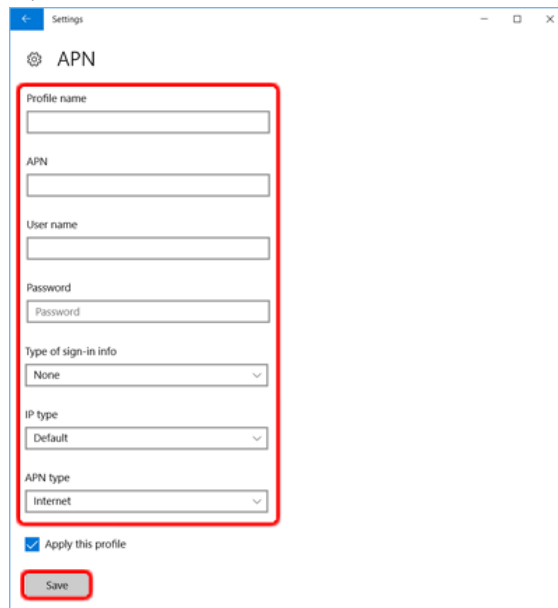



3. Touch [OK].
You are connected to the Internet.
4. Touch arrow upper left (return to previous page).
5. If you are not connected to the Internet, select created APN profile, and then touch [Apply].

NOTE

- When "Use cellular instead of Wi-Fi" is set to [When Wi-Fi is poor] (default), wireless WAN connections will be established only when there is no Internet connection via Wi-Fi.

Disconnecting to a network

1. Touch  (Settings) - [Network & Internet] - [Cellular], and then touch connected ISP.
Alternatively, touch  (Start) -  (Settings) - [Network & Internet] - [Cellular] in the desktop mode, and then touch connected ISP.

NOTE

- You can also touch  on the task tray, and then touch the connected ISP to display the connected ISP screen.

2. Touch [Disconnect].

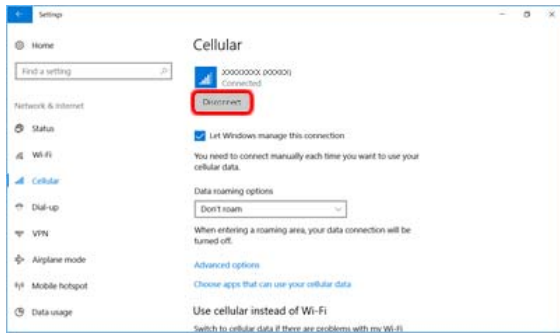



Troubleshooting (Advanced)





Refer to the following instructions when a problem occurs. If the remedies indicated in the chart do not solve the problem, contact Panasonic Technical Support.





For a software problem, refer to the instruction manual of the software.

Network

<p><Only for model with LAN> Cannot connect to a network.</p>	<ul style="list-style-type: none"> Set the device [Extension Port] to [Enabled] in the [Advanced] menu of the Setup Utility. 										
<p><Only when using the Cradle with LAN> Cannot connect to a network.</p>	<ul style="list-style-type: none"> Set [Cradle USB Port] to [Enabled] in the [Advanced] menu of the Setup Utility. 										
<p>Cannot check the computer's MAC address.</p>	<ul style="list-style-type: none"> Follow the steps below. <ol style="list-style-type: none"> Touch  (All apps) - [Windows System] - [Command Prompt]. Alternatively, touch  (Start) - [Windows System] - [Command Prompt] in the desktop mode. Input "getmac /fo list /v", and press <<Enter>>. <ul style="list-style-type: none"> Insert a space between "fo" and "list", and between "list" and "/v". <p>The MAC address of each device appears. The MAC addresses are the 12 alphanumeric characters that appear in the "Physical Address" rows of each of the items. The names of each of the devices are as follows.</p> <table border="1" data-bbox="710 1030 1337 1317"> <thead> <tr> <th>Device</th> <th>Connection Name</th> </tr> </thead> <tbody> <tr> <td>Wireless WAN</td> <td>Cellular</td> </tr> <tr> <td>Wireless LAN</td> <td>Wi-Fi (WLAN)</td> </tr> <tr> <td><Only for model with LAN> LAN</td> <td>Ethernet</td> </tr> <tr> <td>Bluetooth</td> <td>Bluetooth Network Connection</td> </tr> </tbody> </table> <p>* The content displayed will vary depending on the device and model.</p> Input "exit", and press <<Enter>>. 	Device	Connection Name	Wireless WAN	Cellular	Wireless LAN	Wi-Fi (WLAN)	<Only for model with LAN> LAN	Ethernet	Bluetooth	Bluetooth Network Connection
Device	Connection Name										
Wireless WAN	Cellular										
Wireless LAN	Wi-Fi (WLAN)										
<Only for model with LAN> LAN	Ethernet										
Bluetooth	Bluetooth Network Connection										

Wireless Communication (only for model with wireless LAN/Bluetooth/wireless WAN)

<p>Cannot connect to a network.</p>	<ul style="list-style-type: none"> Set the device ([Wireless LAN] / [Bluetooth] / [Wireless WAN]) of [Wireless Configuration] to [Enabled] in the [Advanced] menu of the Setup Utility ( Wireless Configuration). Confirm the airplane mode is Off. To turn off the airplane mode, follow the steps below. <ol style="list-style-type: none"> Touch  (Settings) - [Network & Internet] - [Airplane mode]. Alternatively, touch  (Start) -  (Settings) - [Network & Internet] - [Airplane mode] in the desktop mode. Touch [Airplane mode] to [Off], and then; <ul style="list-style-type: none"> set [Cellular] to [On] (for wireless WAN). set [Wi-Fi]*1 to [On] (for wireless LAN). set [GPS] to [On] (for wireless WAN). set [Bluetooth] to [On] (for Bluetooth). set [GPS/GNSS] to [On] (for GPS).
-------------------------------------	--

	<ul style="list-style-type: none"> ● Restart the computer.
<p>Access point is not detected.</p>	<ul style="list-style-type: none"> ● Shorten the distance between the computer and the access point, and try the detection again. ● Confirm the following settings: <ul style="list-style-type: none"> ● [Wireless LAN] in the [Advanced] menu of the Setup Utility <ul style="list-style-type: none"> ● Confirm that [Wireless LAN] of [Wireless Configuration] is set to [Enabled]. ● Airplane mode <ul style="list-style-type: none"> ● Confirm that Wireless LAN ([Wi-Fi]) is [On]. ● This computer uses channels 1 through 11*2 to [On] when using IEEE802.11b/g/n. Check the channel being used by the access point.
<p><Only for model with wireless WAN> Cannot communicate.</p>	<ul style="list-style-type: none"> ● Confirm the following settings: <ul style="list-style-type: none"> ● [Wireless WAN] in the [Advanced] menu of the Setup Utility <ul style="list-style-type: none"> ● Confirm that [Wireless WAN] of [Wireless Configuration] is set to [Enabled]. ● Airplane mode <ul style="list-style-type: none"> ● Confirm that Wireless WAN (Cellular) is [On]. ● Confirm that the microSIM card is inserted correctly. <p>If communication is not established after proceeding with the above remedies, the wireless WAN device may not be correctly recognized. Restart the computer.</p>
<p><When using the GPS function on the model with the built-in Wireless WAN modem> COM port number setting is requested when trying to use the GPS function.</p>	<ul style="list-style-type: none"> ● To use a COM port, follow the steps below. <ol style="list-style-type: none"> 1. Uninstall "Sierra Wireless Mobile Broadband Driver Package". <ol style="list-style-type: none"> 1. Touch  (Settings) - [Apps]. 2. Touch [Sierra Wireless Mobile Broadband Driver Package], and then touch [Uninstall]. Alternatively, touch  (Start) -  (Settings) - [Apps] in the desktop mode. 3. Touch [Sierra Wireless Mobile Broadband Driver Package], and then touch [Uninstall]. 4. Touch [Uninstall]. 2. Restart the computer. 3. Touch and hold  (Start) - [Run], and then input "C:\util\drivers\wwan_xx\Port_install.bat" in [Open:], and touch [OK]. ("xx" will vary depending on the model.) 4. Confirm that "Sierra Wireless NMEA Port(COMx)" is displayed, open the device manager, and then touch [Ports(COM & LPT)]. Specify "COMx" as the COM port number.

*1 : Screen messages are explained in [English (United States)].
(Depending on the language preference, some screen messages in these instructions are different from the actual screen messages. For example, [Flight mode]/[WiFi] may be displayed instead of [Airplane mode]/[Wi-Fi] in some language preference.)

*2 : In the case of wireless communications, the frequency band being used can be divided into segments, so that different communications can be conducted on each band segment. A "Channel" refers to the individual frequency bandwidth divisions.

Setup Utility

You can make the settings of the computer's operating environment (password settings, startup drive selection, etc.)

Starting the Setup Utility

1. Touch  (Settings) - [Update & security] - [Recovery].

Alternatively, touch  (Start) -  (Settings) - [Update & security] - [Recovery] in the desktop mode.

2. Touch [Restart now] under "Advanced startup"*1.

*1 : Screen messages are explained in [English (United States)].

(Depending on the language preference, some screen messages in these instructions are different from the actual screen messages. For example, [Advanced start-up] may be displayed instead of [Advanced startup] in some language preference.)

3. Touch [Troubleshoot] - [Advanced options] - [UEFI Firmware Settings] - [Restart].

The computer restarts, and the Setup Utility screen appears.

When [Enter Password] is displayed, enter your password.

When you start the Setup Utility with Supervisor Password

- You can make the settings of all items of the Setup Utility.

When you start the Setup Utility with User Password

- Note the following:

- In the [Advanced] and [Boot] menus, you cannot make the settings of all items.
- In the [Security] menu, you can change only the User Password when [User Password Protection] is set to [No Protection]. You cannot delete the User Password.
- In the [Exit] menu, you cannot make the setting of [Load Default Values] and [Boot Override].
- «F9» (Setup Defaults) does not function.

To set Setup Utility, alternatively you can use pen input and touch input.

Using touch screen:

Double-touch the setting value to be changed, select the new value, and touch it again.

Using on-screen keyboard:



To input characters and symbols, touch  at the upper right corner of the Setup Utility screen to display the on-screen keyboard.

ESC	1	2	3	4	5	6	7	8	9	0	BKS
q	w	e	r	t	y	u	i	o	p	ENTER	
a	s	d	f	g	h	j	k	l	↑	SPACE	
z	x	c	v	b	n	m	CAP	←	↓	→	SYM

To operate special keys such as a function key, touch [SYM] on the on-screen keyboard so that the key is highlighted as illustrated below.

F1	F2	F3	F4	F5	F6	F7	F8	F9	F10	F11	F12
`	-	=	~	!	@	#	\$	%	^	ENTER	
&	*	()	_	+	[]	\	{	}	SPC
	:	'	:	"	.	.	/	<	>	?	SYM

The Tablet buttons operates at follows.

- "-" side of  : ↓ (move to the item below)
- "+" side of  : → (move to the item right)
-  : Enter (select)

NOTE

- Setup Utility screen is displayed on the internal LCD even when an external display is connected to the computer as the factory default.
 - Windows 10 supports UEFI boot.
-

Advanced Menu

Underlined items are the factory presets.

Peripheral Configuration

▶ Wireless Configuration ● The sub-menu appears when this item is selected.	Enters the sub-menu.
--	----------------------

Sub-menu (Wireless Configuration)

Wireless LAN ● Only for model with wireless LAN	Disabled <u>Enabled</u>
Wireless WAN ● Only for model with wireless WAN	Disabled <u>Enabled</u>
Bluetooth ● Only for model with Bluetooth	Disabled <u>Enabled</u>

Battery Power

Remove the Battery Pack

CAUTION

- Use only the specified battery pack with your computer.
 - Turn off the computer. In sleep, do not remove the battery pack. Otherwise your data will be lost and the computer may be damaged.
 - The battery pack is not charged when you first purchase it. Be sure to charge it before using for the first time. Charging starts automatically when the AC adaptor is connected to the computer.
-

Insert the Battery Pack

CAUTION

- Use only the specified battery pack with your computer.
 - Turn off the computer.
 - The battery pack is not charged when you first purchase it. Be sure to charge it before using for the first time. Charging starts automatically when the AC adaptor is connected to the computer.
 - Make sure the latch is securely locked, otherwise the battery pack may fall when you carry the computer.
 - Do not remove the battery pack forcibly when the latches are locked. Doing so may damage the battery pack.
-

Replacing the Battery Pack

The battery pack is a consumable item so the replacement will be necessary. If the battery operation time becomes noticeably short and not recovered even after recalibrating the battery, replace with a new battery.

CAUTION

- The battery pack is not charged when you first purchase it. Be sure to charge it before using for the first time. Charging starts automatically when the AC adaptor is connected to the computer.
 - Use only the specified battery pack with your computer.
 - Make sure no foreign objects are under the computer.
-

NOTE

<Only for model with built-in bridge battery>

- If the built-in bridge battery has enough remaining power, you can replace the battery pack without turning off the computer (Hot swap) and during sleeping the computer (Warm swap).
-

1. **Turn off the computer.**
Do not use the sleep function.
2. **Turn your computer over and remove/insert the battery pack.**
 - To remove
Push and slide the latch to the unlocked position, and raise the battery pack.

<Only for model with Built-in Bridge Battery>

Confirm that the battery indicator on the rear of the computer lights green; this means that the built-in bridge battery has enough remaining power required for a hot swap. When the battery indicator on the rear of the

computer doesn't light; Shutdown, Hibernation and while the AC adaptor is connected to the computer.

CAUTION

- In the case of a hot swap, finish replacing the battery within a minute. Depending on the built-in bridge battery status, the computer may enter hibernation within one minute. Replace the battery pack as soon as possible.
 - If you start a hot swap with the AC adaptor connected, do not disconnect the AC adaptor until the battery pack has been replaced. If you unplug the AC adaptor, even if Built-in Bridge Battery is charged, the computer will turn off.
-

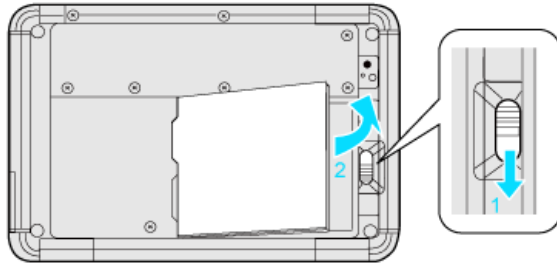

● To insert

- Close the battery pack until it touch to the secured position.

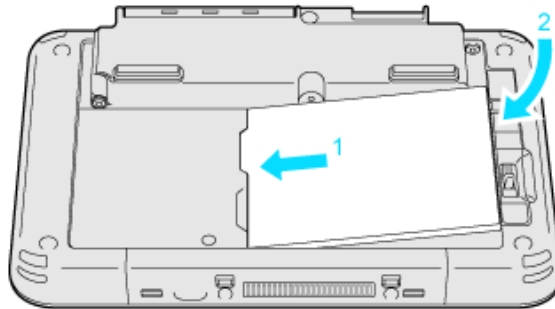

Be careful about the battery pack direction.

In case that the projection does not match the dents of the computer, detach the battery pack once, then slide it while pushing it lightly to avoid floating.

CAUTION

- <Only for model with Built-in Bridge Battery>
If the built-in bridge battery has not enough remaining power, you cannot replace the battery pack without turning off the computer.
Turn off your computer before replacing the battery pack.
 - Make sure the latch is securely locked, otherwise the battery pack may fall when you carry the computer.
 - Do not remove the battery pack forcibly when the latches are locked. Doing so may damage the battery pack.
-