

Disabling/Enabling Wireless Communication

<Only for model with wireless LAN, Bluetooth, and/or wireless WAN>

There are several ways of disabling and enabling wireless communication.

- **Windows 8**
Using airplane mode
- **Windows 7**
Wireless switch utility
- Setting [Wireless Configuration] in the [Advanced] menu of the Setup Utility
- **Windows 7**
Setting in the Wireless Connection Disable Utility
- Settings in the Network and Sharing Center (➔Using the Wireless LAN Function)

NOTE

- For further information about [Wireless LAN](#).
- For further information about [Bluetooth](#).
- For further information about [Wireless WAN](#).
- **Windows 7**

<Only for model with LAN>

The wireless communication can be enabled or disabled by connecting or disconnecting the LAN cable. (➔[Wireless Connection Disable Utility](#))

Using airplane mode **Windows 8**

(For wireless LAN, wireless WAN and Bluetooth)

1. Display "Charm" and touch  - [Change PC Settings] - [Wireless].
2. Set [Airplane mode] to [Off], and then;
 - set [Wi-Fi] in "Wireless device" to [On] (for wireless LAN).
 - set [Mobile broadband] in "Wireless device" to [On] (for wireless WAN).
 - set [Bluetooth] in "Wireless device" to [On] (for Bluetooth).



To check the wireless communication status **Windows 7**

1. Touch  on the notification area and place the cursor over the **Wireless Switch Utility icon** ( or ).

A tooltip appears.

The Wireless Switch Utility icon

The icon appears when touch  on the notification area. It shows the status of wireless devices.

-  : Indicates that the wireless devices are enabled.
-  : Indicates that the wireless devices are off.
-  : Indicates that the wireless devices have been disabled in the Setup Utility.

NOTE

- You can check the wireless LAN communication status in Intel® PROSet/Wireless Software. Perform the following procedure.

Touch  (Start) - [All Programs] - [Intel PROSet Wireless] - [WiFi Advanced Statistics].

Wireless Switch Utility **Windows 7**

This utility allows you to enable or disable wireless devices from a pop-up menu. In the default setting, all wireless devices are enabled.

To enable or disable particular wireless devices

1. Touch the Wireless Switch Utility icon to show the pop-up menu.
2. Select ON or OFF for the device you want to enable or disable.

Wireless Connection Disable Utility **Windows 7**

<Only for model with LAN>

You can automatically disable the wireless LAN/wireless WAN connection when a LAN cable is

connected to your computer. You need to install the Wireless Connection Disable Utility to use this function.

Installing the utility

1. Log on to Windows as an administrator.
2. Touch  (Start), input "c:\util\wdisable\setup.exe" in [Search programs and files], and press «Enter».
3. Follow the on-screen instructions to install the Wireless Connection Disable Utility.

Checking the status of the wireless connection

NOTE

- The Wireless Switch Utility should also be installed so that the Wireless Connection Disable Utility works. The Wireless Switch Utility has already been installed at the factory.
 - The utility does not automatically disable the Bluetooth connection.
-

Status indication

After installation, the Wireless Connection Disable Utility is automatically started after a user is logged in. An icon appears on the notification area.



: Indicates that

- the utility is enabled, and
- the wireless connection is disabled since a LAN cable is connected.



: Indicates that

- the utility is enabled, and
- the wireless connection is enabled since no LAN cable is connected.



: Indicates one of the following statuses;

- the utility does not monitor the LAN port status,
- the Wireless Switch Utility has not been started, or
- LAN is disabled in the [Advanced] menu of the Setup Utility or in the device manager.

Menu

Long touching the utility icon opens a menu as follows.

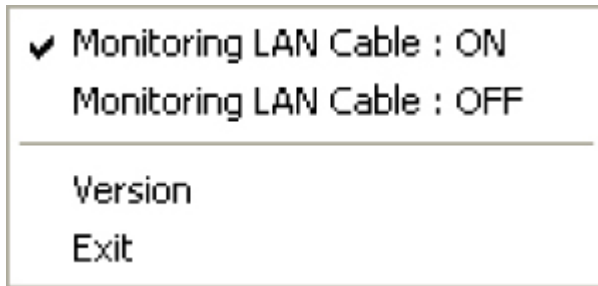

Touching the menu item causes the following utility action.

- **Monitoring LAN Cable: ON**

Enables the Wireless Connection Disable Utility to monitor the LAN port and disable wireless connection when a LAN cable is connected.

- **Monitoring LAN Cable: OFF**

Disables the Wireless Connection Disable Utility, and enables wireless connection regardless of whether a LAN cable is connected or not.

- **Exit**

Exits the Wireless Connection Disable Utility and enables wireless connection.

Wireless LAN

<Only for model with wireless LAN>

CAUTION

- **Do not use wireless LAN on airplanes, in hospitals, or in other locations where wireless LAN signals may affect devices.**
Follow the instructions of airline companies and hospitals. If you use the computer in these locations, turn off the wireless LAN.
 - **To avoid unauthorized access to the computer through wireless LAN**
We recommend you to make security settings such as encryption before using wireless LAN.
Otherwise the flash memory data such as the shared files can be exposed to the risk of unauthorized access.
-

NOTE

- **Communication is established through the wireless LAN antenna (A). Do not block the antenna area with your hand or body.**

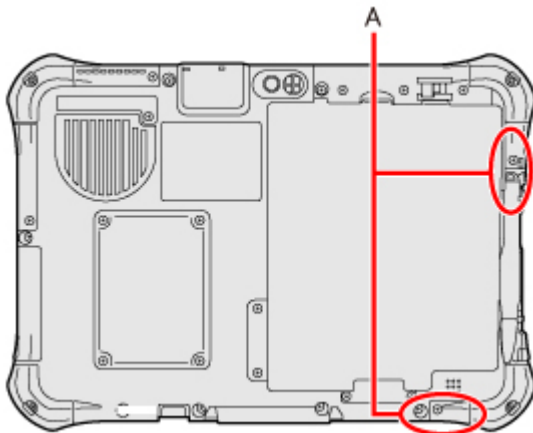

- **The transmission rate will be lower when a microwave oven is used near by.**
 - **To use wireless LAN, set [\[Wireless LAN\]](#) of [\[Wireless Configuration\]](#) to [\[Enabled\]](#) (default) in the [\[Advanced\]](#) menu of the Setup Utility.**
-

Using the Wireless LAN Function

Before using a wireless LAN, turn the wireless LAN communication on.

Turning on/off the wireless LAN communication

1. To enable the wireless communication ([▶ Disabling/Enabling Wireless Communication](#)).

NOTE

- **Windows 7**

You can use the following procedure instead of turning on wireless LAN in the Wireless Switch Utility.

1. Touch  (Start) - [Control Panel] - [Adjust commonly used mobility settings].
 2. Touch [Turn wireless on] in [Wireless Network].
 - When [Turn wireless off] is displayed, the wireless network is already on.
-

Setting the wireless LAN access point

Preparation

Follow the instruction manual of the wireless LAN access point to make settings for the access point to recognize the computer.

1. Turn the wireless LAN on.
2. Touch **Windows 8**  or  / **Windows 7**  or  on the notification area.

Windows 8

The notification area is available on the desktop screen.

3. Select an access point, and touch [Connect].
4. Input the key you set for the access point to recognize the computer, and touch [OK].

Wait for the computer to connect to the wireless LAN access point.





When the icon on the notification area is changed to , the wireless LAN setting is complete.

5. Touch [Close].

NOTE



- The settings depend on the network environment. For further information, ask the system administrator or the person in charge of the network.
- If you use the stealth type wireless LAN access point which restricts automatic detection of the wireless LAN access point, take the following procedure.

If you do not perform the procedure below, you may not be able to access the wireless LAN access point automatically or the wireless LAN access point may not be displayed on the [Connect to a network] screen.



1. **Windows 8** Touch  or  / **Windows 7** ,  or  on the notification area, touch [Open Network and Sharing Center] - [Set up a new connection or network] - [Manually connect to a wireless network] and touch [Next].
2. Input necessary information and add check marks for [Start this connection automatically] and [Connect even if the network is not broadcasting] and touch [Next].

Enabling/Disabling the Wireless LAN Standard IEEE802.11a (802.11a)

Windows 8

1. Touch  on the notification area and touch  (Wireless Toolbox).
2. Touch [802.11a Enabled] or [802.11a Disabled].

Windows 7

1. Touch  on the notification area and touch  or .
2. Touch [802.11a Enabled] or [802.11a Disabled].

NOTE

- In some countries, communication using IEEE802.11a (5 GHz wireless LAN) standard is restricted by law.

- Windows 7

The Wireless Switch Utility icon ( or ) indicates the on/off status of wireless LAN and/or Bluetooth and/or wireless WAN, not the setting of IEEE802.11a.

- If IEEE802.11a is enabled or disabled while the computer is connected to an IEEE802.11b/g access point, the connection will be temporarily interrupted.

Bluetooth

<Only for model with Bluetooth>

You can access internet and other Bluetooth devices without connecting cables.

NOTE

- Communication is established through the Bluetooth antenna (A). Do not block the antenna area with your hand or body.

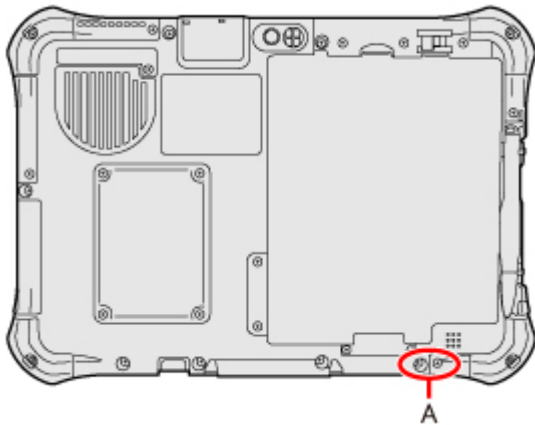



- To use Bluetooth, set **[Bluetooth]** of **[Wireless Configuration]** to **[Enabled]** (default) in the **[Advanced]** menu of the Setup Utility.
 - The transmission rate will be lower when a microwave oven is used near by.
 - When you uninstall the Bluetooth Driver, turn Bluetooth off.
-

Using the Bluetooth Function

1. To enable the wireless communication (➡ **Disabling/Enabling Wireless Communication**).

NOTE

- Though the power of Bluetooth keeps turning on, the electric wave of Bluetooth can be turned off. Perform the following procedure.



1. Click  on the notification area and click  (Bluetooth Manager), then right-click **[Disable Bluetooth Function]**.
-

To check the Bluetooth communication status

Windows 8

1. Display "Charm" and touch  - [Change PC Settings] - [Wireless].

Windows 7

1. Touch  on the notification area and place the cursor over the Wireless Switch Utility icon ( or ).
A tooltip appears.

To access the online manual

1. Windows 8

Display [All apps], and then touch [Bluetooth User Guide] under "Bluetooth".
To display [All apps], proceed as follows on the Start screen.

1. Flick from bottom side to inside of the screen.
2. Touch [All apps] on the toolbar.

Windows 7

Touch  (Start) - [All Programs] - [Bluetooth] - [Bluetooth User Guide].

Wireless WAN

<Only for model with wireless WAN >

This computer is equipped with the Wireless WAN enabling you to communicate using radio frequencies.

Inserting/Removing a SIM Card

Before using the Wireless WAN, set a SIM card to the SIM card slot.

CAUTION

- Be sure to turn off the computer before inserting or removing the SIM card.

- **Windows 8**

Perform the following steps to turn off the computer.

1. Display "Charm" and touch  - [Change PC settings] - [General].
2. Touch [Restart now] under "Advanced startup".
3. Touch [Turn off your PC].

NOTE

- Communication is established through the Wireless WAN antenna (A). Do not block the antenna area with your hand or body.

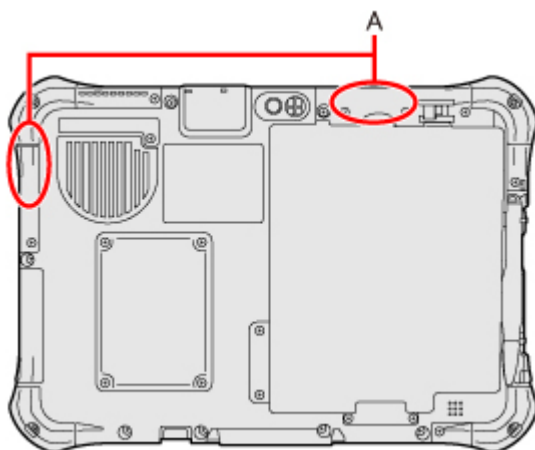

- To use wireless WAN, set **[Wireless WAN]** of [Wireless Configuration] to [Enabled] (default) in the [Advanced] menu of the Setup Utility.

- Before the computer enters sleep or hibernation, cut the Wireless WAN communication. Entering sleep or hibernation without cutting the connection may disable communication after resuming. In this case, restart the computer.

- If the computer repeatedly enters sleep, connection using Wireless WAN Manager may become impossible. In this case, restart the computer.
- If "Device driver software was not installed correctly." (or a similar message) appears when starting the computer or resuming from sleep or hibernation.
 - When communication works normally, Wireless WAN is operating correctly.
 - If communication fails, the device may not be recognized correctly. In this case, restart the computer.

To insert a SIM card

1. Turn off the computer.
2. Disconnect the AC adaptor, remove the battery pack (▶ [Replacing the Battery Pack](#)).
3. Remove the screws (A) and the SIM card slot cover (B).

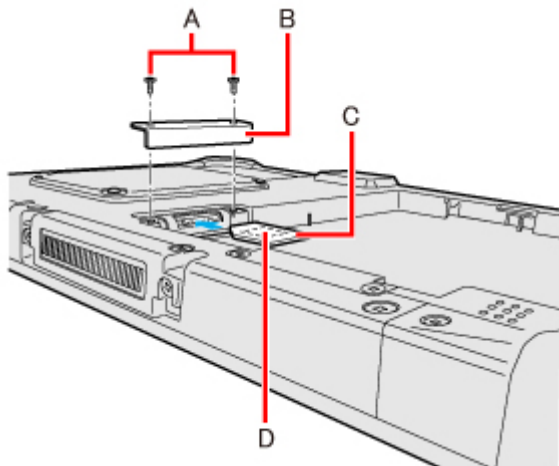

4. Insert the SIM card (C) into the SIM card slot with the contact side (D) facing downward and with the cut corner oriented as shown in the illustration.

CAUTION

- Do not insert the SIM card upside down.
-

5. Close the SIM card slot cover.
 - If the cover is not closed, the SIM card may jump out when the computer falls.
6. Insert the battery pack and connect the AC adaptor.

To remove a SIM card

1. Turn off the computer.

2. Disconnect the AC adaptor, remove the battery pack.
3. Remove the screws (E) and the SIM card slot cover (F).

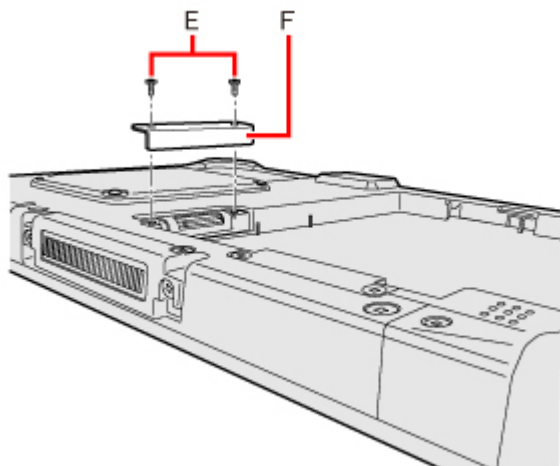

4. Push the card.

It will come out of the slot a little bit.

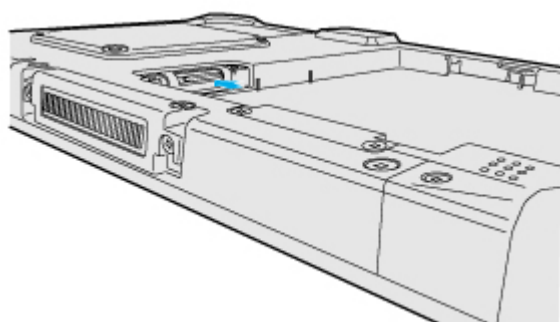

5. Pull the card all the way out.

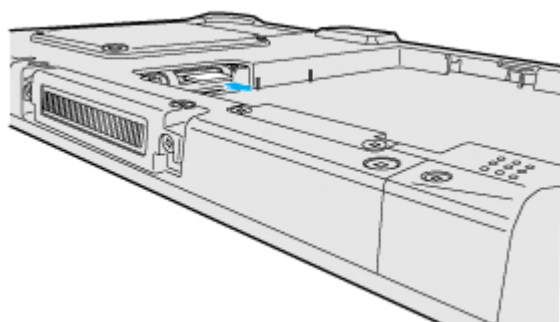

6. Close the SIM card slot cover.
7. Insert the battery pack and connect the AC adaptor.

For some internet service providers, they may be specified the "PAP" or "CHAP" as authentication protocol.

In this case, perform the following steps.

Preparation

- **Insert a SIM card.**
- **Turn on the Wireless function.(➡Using airplane mode).**
- **Perform the following procedure within the communication area .**

1. Check IMSI and SIM ICC ID.

1. Touch  on the notification area on the desktop screen.
2. Long touch the name of your mobile broadband network, and touch [View connection properties].
3. Check "IMSI" (A) and "SIM ICC ID" (B).

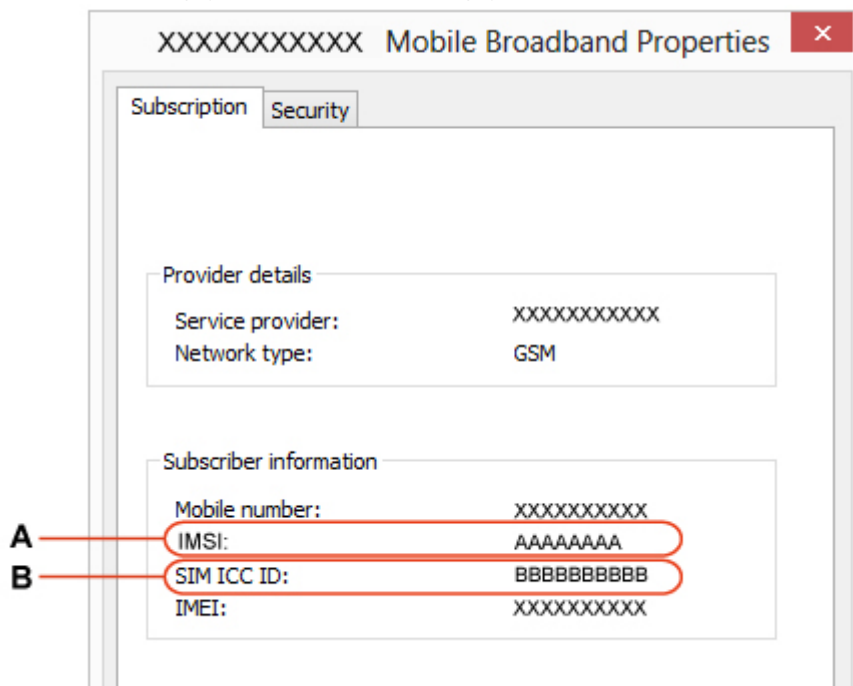

2. Check your ISP information (APN, UserName, Password, Authentication Protocol).

A UserName and a Password may not be specified.

3. Created a XML file and save in arbitrary folder. (Example c:\tmp\A.xml)

Add the following contents.

```
<?xml version="1.0"?>
<MBNProfile xmlns="http://www.microsoft.com/networking/WWAN/profile/v1">
<Name>Profile</Name>
<IsDefault>true</IsDefault>
<SubscriberID>AAAAAAAAA</SubscriberID>
<SimIccID>BBBBBBBBBB</SimIccID>
<Context>
<AccessString>APN</AccessString>
```

```
<UserLogonCred>  
<UserName>USERNAME</UserName>  
<Password>PASSWORD</Password>  
</UserLogonCred>  
<AuthProtocol>CHAP</AuthProtocol>  
</Context>  
</MBNProfile>
```

Change the settings.

SubscriberID: Replace the "IMSI". (Step 1)

SimIccID: Replace "SIM ICC ID". (Step 1)

AccessString: Replace "APN". (Step 2)

UserName: Replace "UserName". (Step 2)

When a UserName is not specified, delete this line.

Password: Replace "Password". (Step 2)

When a Password is not specified, delete this line.

AuthProtocol: Replace "Authentication Protocol". (Step 2)

When the XML file is already been created, touch [Forget this network].

1. Touch  on the notification area on the desktop screen.
2. Long touch name of your mobile broadband network, and touch [Forget this network].

4. Execute the following command by "Command Prompt".

```
netsh mbn add profile interface="Mobile broadband" name="c:\tmp\a.xml"
```

To open "Command Prompt":

Display [All apps], and then touch [Command Prompt] under "Windows System".