

**EXHIBIT D – User Manual**

---

Not Available at Time of Test

Reference the Following Pages Below for User Manual

# EXHIBIT D: USERS MANUAL



## Operating Instructions Microwave Oven

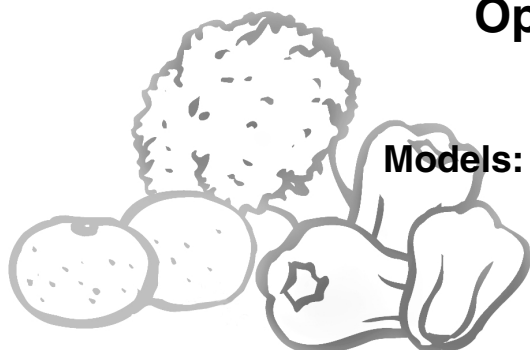

**Models:** NN-H965

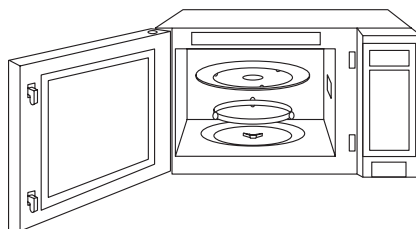

### Safety Information

Precautions .....	Inside cover
Important Safety Instructions .....	1-3
Installation and Grounding .....	
Instructions .....	3-4
Safety Precautions .....	5-6

### Operation

Control Panel .....	9
Starting to Use Your Oven .....	10
Setting the Clock .....	10
Function Features .....	10-11
Selecting Power & Cook Time .....	12
Quick Min Feature .....	12
Keep Warm Feature .....	12
Popcorn Feature .....	13
More/Less Feature .....	13
Inverter Turbo Defrost Feature .....	14
Defrosting Tips & Techniques .....	14-15
Sensor Reheat Feature .....	16
Sensor Cook Feature .....	16
Sensor Cook Chart .....	17

### Operation

Microwave Recipes .....	18
Timer Feature (Kitchen Timer/Stand Time/Delay Start) .....	19
Microwave Shortcuts .....	20-21
Food Characteristics .....	22
Cooking Techniques .....	22-23
Quick Guide to Operation .....	27

### Maintenance

Care and Cleaning of Your Microwave Oven .....	24
Accessory Purchases .....	24
Before Requesting Service .....	25
Limited Warranty & Customer Service Directory .....	26

### General Information

Cookware Guide .....	7
Oven Components Diagram .....	8
Specifications .....	28
User's Record .....	28

**READ ALL INSTRUCTIONS CAREFULLY BEFORE USING THE OVEN.**

Para instrucciones en español, voltee el libro.

For assistance, please call: 1-800-211-PANA(7262)  
or send e-mail to: [consumerproducts@panasonic.com](mailto:consumerproducts@panasonic.com)  
or visit us at [www.panasonic.com](http://www.panasonic.com)

(U.S.A)

For assistance, please call: 787-750-4300  
or visit us at [www.panasonicpr.com](http://www.panasonicpr.com)

(Puerto Rico)

F00037C50AP  
FLE0305-0  
Printed in China

# Microwave Oven Safety

**Your safety and the safety of others are very important.**

We have provided important safety messages in this manual and on your appliance. Always read and obey all safety messages.



This is the safety alert symbol. It is used to alert you to potential hazards that can kill or hurt you and others.

All safety messages will follow the safety alert symbol and either the word "DANGER", "WARNING" or "CAUTION". These words mean:



**DANGER**

You can be killed or seriously injured if you don't immediately follow instructions.



**WARNING**

You can be killed or seriously injured if you don't follow instructions.



**CAUTION**

CAUTION indicates a potentially hazardous situation which, if not avoided, may result in minor or moderate injury.

All safety messages will tell you what the potential hazard is, tell you how to reduce the chance of injury, and tell you what can happen if the instructions are not followed.



## **PRECAUTIONS TO AVOID POSSIBLE EXPOSURE TO EXCESSIVE MICROWAVE ENERGY**

- (a) Do not attempt to operate this oven with the door open since open-door operation can result in harmful exposure to microwave energy. It is important not to defeat or tamper with the safety interlocks.
- (b) Do not place any object between the oven front face and the door or allow soil or cleaner residue to accumulate on sealing surfaces.
- (c) Do not operate the oven if it is damaged. It is particularly important that the oven door close properly and that there is no damage to the:
  - (1) door (bent),
  - (2) hinges and latches (broken or loosened),
  - (3) door seals and sealing surfaces.
- (d) The oven should not be adjusted or repaired by anyone except properly qualified service personnel.

Thank you for purchasing a Panasonic Microwave Oven.

Your microwave oven is a cooking appliance and you should use as much care as you use with a stove or any other cooking appliance. When using this electric appliance, basic safety precautions should be followed, including the following:



## IMPORTANT SAFETY INSTRUCTIONS

### **! WARNING**

—To reduce the risk of burns, electric

**shock, fire, injury to persons, or exposure to excessive microwave energy:**

1. Read all instructions before using this appliance.
2. Read and follow the specific “PRECAUTIONS TO AVOID POSSIBLE EXPOSURE TO EXCESSIVE MICROWAVE ENERGY,” found on the inside front cover.
3. This appliance must be grounded. Connect only to a properly grounded outlet. See “GROUNDING INSTRUCTIONS” found on page 4.
4. As with any cooking appliance, **DO NOT** leave oven unattended while in use.
5. Install or locate this appliance only in accordance with the installation instructions found on page 3.
6. **DO NOT** cover or block any openings on this appliance.
7. **DO NOT** store this appliance outdoors. **DO NOT** use this product near water—for example, near a kitchen sink, in a wet basement, or near a swimming pool or similar locations.
8. Use this appliance only for its intended use as described in this manual. **DO NOT** use corrosive chemicals, vapors, or non-food products in this appliance. This type of oven is specifically designed to heat, or cook food. It is not designed for industrial or laboratory use. The use of corrosive chemicals in heating or cleaning will damage the appliance and may result in radiation leaks.
9. When cleaning surfaces of the door and oven that come together on closing the door, use only mild, non-abrasive soaps or detergents applied with a sponge or soft cloth.
10. **DO NOT** allow children to use this appliance, unless closely supervised by an adult. **DO NOT** assume that because a child has mastered one cooking skill he/she can cook everything.
11. **DO NOT** operate this appliance if it has a damaged cord or plug, if it is not working properly, or if it has been damaged or dropped.
12. **DO NOT** immerse cord or plug in water.
13. Keep cord away from heated surfaces.
14. **DO NOT** let cord hang over edge of a table or counter.
15. This appliance should be serviced only by qualified service personnel. Contact the nearest authorized service center for examination, repair or adjustment.
16. Some products such as whole eggs with or without shell, narrow neck bottles and sealed containers—for example, closed glass jars—may explode and should not be heated in this oven.
17. To reduce the risk of fire in the oven cavity:
  - (a) Do not overcook food. Carefully attend appliance when paper, plastic, or other combustible materials are placed inside the oven to facilitate cooking.
  - (b) Remove wire twist-ties from paper or plastic bags before placing bag in oven.
  - (c) **If material inside the oven ignites, keep oven door closed, turn oven off, and disconnect the power cord, or shut off power at the fuse or circuit breaker panel.**
  - (d) **DO NOT** use the cavity for storage purposes. **DO NOT** leave paper products, cooking utensils or food in the cavity when not in use.



## IMPORTANT SAFETY INSTRUCTIONS

(continued)

18. Liquids, such as water, coffee, or tea are able to be overheated beyond the boiling point without appearing to be boiling. Visible bubbling when the container is removed from the microwave oven is not always present. **THIS COULD RESULT IN VERY HOT LIQUIDS SUDDENLY BOILING OVER WHEN THE CONTAINER IS DISTURBED OR A UTENSIL IS INSERTED INTO THE LIQUID.**
- To reduce the risk of injury to persons:
- STIR THE LIQUID BOTH BEFORE AND HALFWAY THROUGH HEATING IT.**
  - Do not heat water and oil, or fats together. The film of oil will trap steam, and may cause a violent eruption.**
  - Do not use straight-sided containers with narrow necks.
  - After heating, allow the container to stand in the microwave oven for a short time before removing the container.
19. **DO NOT** cook directly on the turntable. It can crack, cause injury or damage to the oven.

### **WARNING**

#### **TO AVOID THE RISK OF SHOCK:**

**DO NOT** remove outer panel from oven. Repairs must be done only by a qualified service person.

#### **TO REDUCE THE RISK OF EXPOSURE TO MICROWAVE ENERGY:**

**DO NOT** tamper with, or make any adjustments or repairs to Door, Control Panel Frame, Safety Interlock Switches, or any other part of oven, microwave leakage may result.

#### **TO AVOID THE RISK OF FIRE:**

- DO NOT** operate the oven empty. The microwave energy will reflect continuously throughout the oven causing overheating and damage, if food or water is not present to absorb energy.
- DO NOT** store flammable materials next to, on top of, or in the oven.
- DO NOT** dry clothes, newspapers or other materials in the oven, or use newspaper or paper bags for cooking.
- DO NOT** hit or strike Control Panel. Damage to controls may occur.
- DO NOT** use recycled paper products unless the paper product is labeled as safe for microwave oven use. Recycled paper products may contain impurities which may cause sparking.

#### **TO AVOID THE RISK OF SCALDING:**

**POT HOLDERS** should always be used when removing items from the oven. Heat is transferred from the **HOT** food to the cooking container and from the container to the Glass Tray. The Glass Tray can also be very **HOT** after removing the cooking container from the oven.

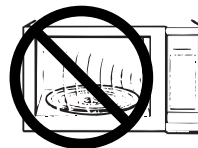
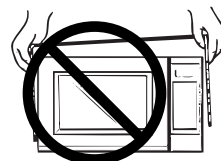

## SAVE THESE INSTRUCTIONS

For proper use of your oven read remaining safety cautions and operating instructions.



## IMPORTANT SAFETY INSTRUCTIONS

*(continued)*

### Glass Tray

1. **DO NOT** operate the oven without the Roller Ring and the Glass Tray in place.
2. **DO NOT** operate the oven without the Glass Tray fully engaged on the drive hub. Improper cooking or damage to the oven could result. Verify that the Glass Tray is properly engaged and rotating by observing its rotation when you press Start. **Note:** The Glass Tray can turn in either direction.
3. Use only the Glass Tray specifically designed for this oven. **DO NOT** substitute any other glass tray.
4. If the Glass Tray is hot, allow to cool before cleaning or placing in water.
5. **DO NOT** cook directly on the Glass Tray. Always place food in a microwave safe dish, or on a rack set in a microwave safe dish.
6. If food or utensil on the Glass Tray touches oven walls, causing the tray to stop moving, the tray will automatically rotate in the opposite direction.

### Roller Ring

1. The Roller Ring and oven floor should be cleaned frequently to prevent excessive noise.
2. Always replace the Roller Ring and the Glass Tray in their proper positions.
3. The Roller Ring must always be used for cooking along with the Glass Tray.



## INSTALLATION AND GROUNDING INSTRUCTIONS

### Examine Your Oven

Unpack oven, remove all packing material and examine the oven for any damage such as dents, broken door latches or cracks in the door. Notify dealer immediately if oven is damaged. **DO NOT** install if oven is damaged.

### Placement of Oven

1. The oven must be placed on a flat, stable surface. Place the front surface of the door three inches or more from the counter top edge to avoid accidental tipping of the microwave oven during normal use. For proper operation, the oven must have sufficient air flow. Allow 3-inches (7.6 cm) of space on both sides of the oven and 1-inch (2.5 cm) of space on top of the oven.
  - (a) **DO NOT** block air vents. If they are blocked during operation, the oven may be overheated and damaged.
  - (b) **DO NOT** place oven near a hot, damp surface such as a gas or electric range, or dishwasher.
  - (c) **DO NOT** operate oven when room humidity is excessive.
2. This oven is manufactured for counter top household use only. It is not intended for built-in operation and is not approved or tested for mobile vehicle, marine, or commercial use.

### Installation

**DO NOT** block air vents. If they are blocked during operation, the oven may overheat. If the oven overheats, a thermal safety device will turn the oven off. The oven will remain inoperable until it has cooled.



# INSTALLATION AND GROUNDING INSTRUCTIONS

(continued)

## **! WARNING**

—IMPROPER USE OF THE GROUNDING PLUG

**CAN RESULT IN A RISK OF ELECTRIC SHOCK.**

Consult a qualified electrician or service person if the grounding instructions are not completely understood, or if doubt exists as to whether the appliance is properly grounded. If it is necessary to use an extension cord, use only a three wire extension cord that has a three prong polarized grounding plug, and a three slot receptacle that will accept the plug on the appliance. The marked rating of the extension cord should be equal to or greater than the electrical rating of the appliance.

### **Grounding Instructions**

**THIS APPLIANCE MUST BE GROUNDED.** In the event of an electrical short circuit, grounding reduces the risk of electric shock by providing an escape wire for the electric current. This appliance is equipped with a cord having a grounding wire with a grounding plug. The plug must be plugged into an outlet that is properly installed and grounded.

- **Plug into properly installed and grounded 3 prong outlet.**
- **DO NOT remove ground prong.**
- **DO NOT use an adapter.**

### **Power Supply**

1. A short power-supply cord is provided to reduce the risks resulting from becoming entangled in or tripping over a longer cord.
2. Longer cord sets or extension cords are available and may be used if care is exercised in their use. **Do not** let cord hang over edge of a table or counter.
3. If a long cord or extension cord is used, (1) the marked electrical rating of the cord set or extension cord should be at least as great as the electrical rating of the appliance, (2) the extension cord must be a grounding-type 3-wire cord, and (3) the longer cord should be arranged so that it will not drape over the counter top or table-top where it can be pulled on by children or tripped over accidentally.

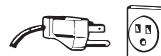

### **Wiring Requirements**

The oven must be operated on a SEPARATE CIRCUIT. No other appliance should share the circuit with the microwave oven. If it does, the branch circuit fuse may blow or the circuit breaker may trip. The oven must be plugged into at least a 15 AMP, 120 VOLT, 60 Hz GROUNDED OUTLET. Where a standard two-prong outlet is encountered, it is the personal responsibility and obligation of the consumer to have it replaced with a properly grounded three-prong outlet. The VOLTAGE used must be the same as specified on this microwave oven (120 V, 60 Hz). Using a higher voltage is dangerous and may result in a fire or oven damage. Using a lower voltage will cause slow cooking. Panasonic is NOT responsible for any damages resulting from the use of the oven with any voltage other than specified.

### **TV / Radio Interference**

1. Operation of the microwave oven may cause interference to your radio, TV or similar equipment.
2. When there is interference, it may be reduced or eliminated by taking the following measures:
  - (a) Place the radio, TV, etc. away from the microwave oven as far as possible.
  - (b) Use a properly installed antenna to obtain stronger signal reception.
  - (c) Clean door and sealing surfaces of the oven. (See Care and Cleaning of Your Microwave Oven)



## Safety Precautions

Follow These Safety Precautions When Cooking in Your Oven.

### **IMPORTANT**

Proper cooking depends upon the power, the time setting and quantity of food. If you use a smaller portion than recommended but cook at the time for the recommended portion, fire could result.

### **1) HOME CANNING / STERILIZING / DRYING FOODS / SMALL QUANTITIES OF FOODS**

- **DO NOT** use your oven for home canning. Your oven cannot maintain the food at the proper canning temperature. The food may be contaminated and then spoil.
- **DO NOT** use the microwave oven to sterilize objects (baby bottles, etc.). It is difficult to keep the oven at the high temperature needed for sterilization.
- **DO NOT** dry meats, herbs, fruits or vegetables in your oven. Small quantities of food or foods with low moisture content can dry out, scorch or catch on fire if overheated.

### **2) POPCORN**

Popcorn may be popped in a microwave oven corn popper. Microwave popcorn which pops in its own package is also available. Follow popcorn manufacturers' directions and use a brand suitable for the cooking power of your microwave oven.

**CAUTION:** When using pre-packaged microwave popcorn, you can follow recommended package instructions or use the popcorn pad (refer to page 13). Otherwise, the popcorn may not pop adequately or may ignite and cause a fire. Never leave oven unattended when popping popcorn. Allow the popcorn bag to cool before opening, always open the bag facing away from your face and body to prevent steam burns.

### **3) DEEP FAT FRYING**

- **DO NOT** deep fat fry in your microwave oven. Cooking oils may burst into flames and may cause damage to the oven and perhaps result in burns. Microwave utensils may not withstand the temperature of the hot oil, and can shatter or melt.

### **4) FOODS WITH NONPOROUS SKINS**

- **DO NOT COOK/REHEAT WHOLE EGGS, WITH OR WITHOUT THE SHELL.**

Steam buildup in whole eggs may cause them to explode, and possibly damage the oven or cause injury. Reheating SLICED hard-boiled eggs and cooking SCRAMBLED eggs is safe.

- **Potatoes, apples, whole squash and sausages** are examples of foods with non-porous skins. These types of foods must be pierced before microwave cooking to prevent them from exploding.

**CAUTION:** Cooking dry or old potatoes can cause fire.





## Safety Precautions

(continued)

### 5) GLASS TRAY / COOKING CONTAINERS / FOIL

- Cooking containers get hot during microwaving. Heat is transferred from the HOT food to the container and the Glass Tray. Use pot holders when removing containers from the oven or when removing lids or plastic wrap covers from cooking containers, to avoid burns.
- The Glass Tray will get hot during cooking. It should be allowed to cool before handling or before paper products, such as paper plates or microwave popcorn bags, are placed in the oven for microwave cooking.
- When using foil in the oven, allow at least 1-inch (2.5 cm) of space between foil and interior oven walls or door.
- Dishes with metallic trim should **not** be used, as arcing may occur.

### 6) PAPER TOWELS / CLOTHS

- **DO NOT** use paper towels or cloths which contain a synthetic fiber woven into them. The synthetic fiber may cause the towel to ignite. Use paper toweling under supervision.

### 7) BROWNING DISHES / OVEN COOKING BAGS

- Browning dishes or grills are designed for microwave cooking only. Always follow instructions provided by the manufacturer. **DO NOT** preheat browning dish more than 6 minutes.
- If an oven cooking bag is used for microwave cooking, prepare according to package directions. **DO NOT** use a wire twist-tie to close bag, instead use plastic ties, cotton string or a strip cut from the open end of the bag.

### 8) THERMOMETERS

- **DO NOT** use a conventional meat thermometer in your oven. Arcing may occur. Microwave safe thermometers are available for both meat and candy.

### 9) BABY FORMULA / BABY FOOD

- **DO NOT** heat baby formula or baby food in the microwave oven. The glass jar or surface of the food may appear warm while the interior can be so hot as to burn the infant's mouth and esophagus.

### 10) REHEATING PASTRY PRODUCTS

- When reheating pastry products, check temperatures of any fillings before eating. Some foods have fillings which heat faster and can be extremely hot, while the surface remains warm to the touch (ex. Jelly Donuts).

### 11) GENERAL OVEN USAGE GUIDELINES

- **DO NOT** use the oven for any purpose other than the preparation of food.

# Oven Components Diagram

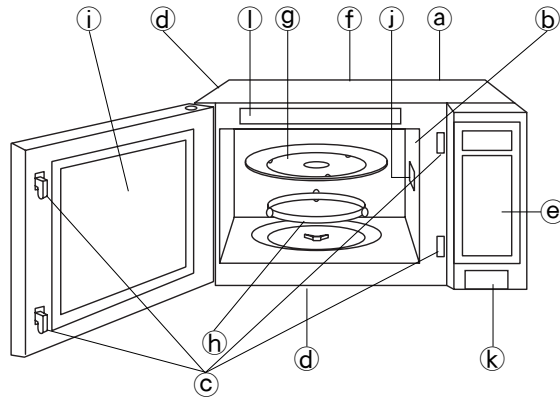

- Ⓐ External Air Vent
- Ⓑ Internal Air Vent
- Ⓒ Door Safety Lock System
- Ⓓ Exhaust Air Vent
- Ⓔ Control Panel
- Ⓕ Identification Plate
- Ⓖ Glass Tray
- Ⓗ Roller Ring
- Ⓘ Heat/Vapor Barrier Film  
(do not remove)
- Ⓙ Waveguide Cover (do not remove)
- Ⓚ Door Release Button
- Ⓛ Menu Label



# Care and Cleaning of Your Microwave Oven

## BEFORE CLEANING:

Unplug oven at wall outlet. If outlet is inaccessible, leave oven door open while cleaning.

## AFTER CLEANING:

Be sure to place the Roller Ring and the Glass Tray in the proper position and press Stop/Reset Pad to clear the Display.

### Menu Label:

Do not remove, wipe with a damp cloth.

### Glass Tray:

Remove and wash in warm soapy water or in a dishwasher.

### Outside oven surfaces:

Clean with a damp cloth. To prevent damage to the operating parts inside the oven, water should not be allowed to seep into ventilation openings.

### Inside of the oven:

Wipe with a damp cloth after using. Mild detergent may be used if needed. Do not use harsh detergents or abrasives.

### Control Panel:

\* Covered with a removable protective film to prevent scratches during shipping. Small bubbles may appear under this film. (Hint - To remove film, apply masking or clear tape to an exposed corner and pull gently.)

### Oven Door:

Wipe with a soft dry cloth when steam accumulates inside or around the outside of the oven door. During cooking, especially under high humidity conditions, steam is given off from the food. (Some steam will condense on cooler surfaces, such as the oven door. This is normal.)

Inside surface is covered with a heat and vapor barrier film. **Do not remove.**

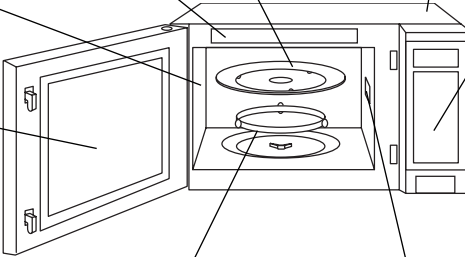

### Roller Ring and oven cavity floor:

Clean the bottom surface of the oven with mild detergent water or window cleaner, and dry. Roller Ring may be washed in mild soapy water or dishwasher. These areas should be kept clean to avoid excessive noise.

\* If the Control Panel becomes wet, clean it with a soft dry cloth. Do not use harsh detergents or abrasives.

**Do not remove waveguide cover: It is important to keep cover clean in the same manner as the inside of the oven.**

**IT IS IMPORTANT TO KEEP THE OVEN CLEAN AND DRY. FOOD RESIDUE AND CONDENSATION MAY CAUSE RUSTING OR ARCING AND DAMAGE TO THE OVEN. AFTER USE, WIPE DRY ALL SURFACES-INCLUDING VENT OPENINGS, OVEN SEAMS, AND UNDER GLASS TRAY.**

PARTS DESCRIPTION	PART NUMBER
Instructions / Operating Manual (this book)	F00037C50AP
Glass Tray	F06014W00AP F06014M00AP
Roller Ring Assembly	F290D9330AP

## Accessory Purchases

Purchase Parts, Accessories and Instruction Books online for all Panasonic Products by visiting our Web Site at: <http://www.pasc.panasonic.com> or, send your request by E-mail to: [npcparts@us.panasonic.com](mailto:npcparts@us.panasonic.com)

You may also contact us directly at:  
 1-800-332-5368 (Phone) 1-800-237-9080 (Fax Only) (Monday-Friday 9 am to 8 pm, EST.)  
 Panasonic Services Company  
 20421 84th Avenue South,  
 Kent, WA 98032  
 (We Accept Visa, MasterCard, Discover Card, American Express, and Personal Checks)

For hearing or speech impaired TTY users, TTY: 1-866-605-1277



## Before Requesting Service

### These things are normal:

The oven causes interference with my TV.

Some radio and TV interference might occur when you cook with the microwave oven. This interference is similar to the interference caused by small appliances such as mixers, vacuums, blow dryers, etc. It does not indicate a problem with your oven.

Steam accumulates on the oven door and warm air comes from the oven vents.

During cooking, steam and warm air are given off from the food. Most of the steam and warm air are removed from the oven by the air which circulates in the oven cavity. However, some steam will condense on cooler surfaces such as the oven door. This is normal. After use, the oven should be wiped dry (see page 24).

PROBLEM	POSSIBLE CAUSE	REMEDY
Oven will not turn on.	The oven is not plugged in securely.	Remove plug from outlet, wait 10 seconds and re-insert.
	Circuit breaker or fuse is tripped or blown.	Reset circuit breaker or replace fuse.
	There is a problem with the outlet.	Plug another appliance into the outlet to check if it is working.
Oven will not start cooking.	The door is not closed completely.	Close the oven door securely.
	<b>Start</b> Pad was not pressed after programming.	Press <b>Start</b> Pad.
	Another program is already entered into the oven.	Press <b>Stop/Reset</b> Pad to cancel the previous program and enter new program.
	The program is not correct.	Program again according to the Operating Instructions.
The Glass Tray wobbles.	<b>Stop/Reset</b> Pad has been pressed accidentally.	Program oven again.
	The Glass Tray is not positioned properly on the Roller Ring or there is food under the Roller Ring.	Take out Glass Tray and Roller Ring. Wipe with a damp cloth and reset Roller Ring and Glass Tray properly.
When the oven is operating, there is noise coming from the glass tray.	The Roller Ring and oven bottom are dirty.	Clean these parts according to <b>Care and Cleaning of your Microwave Oven</b> (see page 24).
The word "LOCK" appears in the <b>Display Window</b> .	The CHILD LOCK was activated.	See <b>Function</b> Pad on page 11.

# Limited Warranty & Customer Services Directory

PANASONIC CONSUMER ELECTRONICS COMPANY,  
DIVISION OF PANASONIC CORPORATION OF  
NORTH AMERICA  
One Panasonic Way  
Secaucus, New Jersey 07094

PANASONIC SALES COMPANY,  
DIVISION OF PANASONIC PUERTO  
RICO, INC.  
Ave. 65 de Infantería, Km. 9.5  
San Gabriel Industrial Park  
Carolina, Puerto Rico 00985

## Panasonic Microwave Oven Product Limited Warranty

### Limited Warranty Coverage

If your product does not work properly because of a defect in materials or workmanship, Panasonic Consumer Electronics Company or Panasonic Sales Company (collectively referred to as "the warrantor") will, for the length of the period indicated on the chart below, which starts with the date of original purchase ("warranty period"), at its option either (a) repair your product with new or refurbished parts, or (b) replace it with a new or a refurbished product. The decision to repair or replace will be made by the warrantor.

	<b>PARTS</b>	<b>LABOR</b>
<b>ALL PARTS (EXCEPT MAGNETRON TUBE)</b>	<b>1 (ONE) YEAR</b>	<b>1 (ONE) YEAR</b>
<b>MAGNETRON TUBE</b>	<b>5 (FIVE) YEAR</b>	<b>1 (ONE) YEAR</b>

During the "Labor" warranty period there will be no charge for labor. During the "Parts" warranty period, there will be no charge for parts. You must carry-in or mail-in your product during the warranty period. This warranty only applies to products purchased and serviced in the United States or Puerto Rico. This warranty is extended only to the original purchaser of a new product which was not sold "as is". A purchase receipt or other proof of the original purchase date is required for warranty service.

### Carry-In or Mail-In Service

For Carry-In or Mail-In Service in the United States call 1-800-211-PANA(7262) or visit Panasonic Web Site: <http://www.panasonic.com>

For assistance in Puerto Rico call Panasonic Sales Company (787)-750-4300 or fax (787)-768-2910.

### Limited Warranty Limits And Exclusions

This warranty ONLY COVERS failures due to defects in materials or workmanship, and DOES NOT COVER glass, plastic parts, temperature probes(if included) and normal wear and tear or cosmetic damage. The warranty ALSO DOES NOT COVER damages which occurred in shipment, or failures which are caused by products not supplied by the warrantor, or failures which result from accidents, misuse, abuse, neglect, mishandling, misapplication, alteration, faulty installation, set-up adjustments, misadjustment of consumer controls, improper maintenance, power line surge, lightning damage, modification, or commercial use (such as in a hotel, office, restaurant, or other business), rental use of the product, service by anyone other than a Factory Service center or other Authorized Servicer, or damage that is attributable to acts of God.

**THERE ARE NO EXPRESS WARRANTIES EXCEPT AS LISTED UNDER "LIMITED WARRANTY COVERAGE". THE WARRANTOR IS NOT LIABLE FOR INCIDENTAL OR CONSEQUENTIAL DAMAGES RESULTING FROM THE USE OF THIS PRODUCT, OR ARISING OUT OF ANY BREACH OF THIS WARRANTY.** (As examples, this excludes damages for lost time, cost of having someone remove or re-install an installed unit if applicable, or travel to and from the servicer. The items listed are not exclusive, but are for illustration only.) **ALL EXPRESS AND IMPLIED WARRANTIES, INCLUDING THE WARRANTY OF MERCHANTABILITY, ARE LIMITED TO THE PERIOD OF THE LIMITED WARRANTY.**

Some states do not allow the exclusion or limitation of incidental or consequential damages, or limitations on how long an implied warranty lasts, so the exclusions may not apply to you.

This warranty gives you specific legal rights and you may also have others rights which vary from state to state. If a problem with this product develops during or after the warranty period, you may contact your dealer or Service center. If the problem is not handled to your satisfaction, then write to the warrantor's Consumer Affairs Department at the addresses listed for the warrantor.

**PARTS AND SERVICE WHICH ARE NOT COVERED BY THIS LIMITED WARRANTY ARE YOUR RESPONSIBILITY.**

## Customer Services Directory

Obtain Product Information and Operating Assistance; locate your nearest Dealer or servicer; purchase Parts and Accessories; or make Customer Service and Literature requests by visiting our Web Site at: <http://www.panasonic.com/consumersupport> or, contact us via the web at: <http://www.panasonic.com/contactinfo>

You may also contact us directly at: **1-800-211-PANA(7262)**,  
Monday-Friday 9 am-9 pm; Saturday-Sunday 10 am-7 pm, EST.

For hearing or speech impaired TTY users, TTY: 1-877-833-8855

## Service in Puerto Rico

Panasonic Puerto Rico, Inc.  
Ave. 65 de Infantería, Km. 9.5, San Gabriel Industrial Park, Carolina, Puerto Rico 00985  
Phone (787)750-4300, Fax (787)768-2910



# Specifications

	NN-H965
Power Source:	120 V, 60 Hz
Power Consumption:	12.7 Amps, 1,460 W
Cooking Power:*	1,250 W
Outside Dimensions (H x W x D):	14" x 23 <sup>7</sup> / <sub>8</sub> " x 19 <sup>7</sup> / <sub>16</sub> " (356 mm x 606 mm x 493 mm)
Oven Cavity Dimensions (H x W x D):	10 <sup>15</sup> / <sub>16</sub> " x 18 <sup>7</sup> / <sub>16</sub> " x 18 <sup>1</sup> / <sub>2</sub> " (278 mm x 469 mm x 470 mm)
Operating Frequency:	2,450 MHz
Net Weight:	Approx 36 lbs. (16.4 kg.)

\*IEC Test procedure

Specifications subject to change without notice.

# User's Record

The serial number of this product may be found on the back side of the oven. You should note the model number and the serial number of this oven in the space provided and retain this book as a permanent record of your purchase for future reference.

Model No. \_\_\_\_\_

Serial No. \_\_\_\_\_

Date of Purchase \_\_\_\_\_

**Panasonic Consumer Electronics Company, Division of Panasonic Corporation of North America**  
 One Panasonic Way  
 Secaucus, New Jersey 07094

**Panasonic Sales Company, Division of Panasonic Puerto Rico, Inc. ("PSC")**  
 Ave. 65 de Infanteria, Km. 9.5  
 San Gabriel Industrial Park,  
 Carolina, Puerto Rico 00985

**Matsushita Electric Industrial Co., Ltd.**  
**Panasonic Home Appliances Microwave Oven (Shanghai) Co., Ltd.**  
 898 Long Dong Road, Pu Dong, Shanghai, China 201203  
 Web Site: <http://www.panasonic.co.jp/global>