



# Operating Instructions

## Wireless System and Digital Transmitter

Model No. **SH-FX65**



Designed for Panasonic DVD Home Theater Sound Systems that are compatible with the SH-FX65.

### Dear customer

Thank you for purchasing this product. For optimum performance and safety, please read these instructions carefully.

**Before connecting, operating or adjusting this product, please read the instructions completely.**

**Please keep this manual for future reference.**

<b>System</b>	SH-FX65
<b>Digital transmitter</b>	SH-FX65T
<b>Wireless system</b>	SE-FX65

P

### Table of Contents

#### Introduction

IMPORTANT SAFETY INSTRUCTIONS.....	3
Accessory .....	3

#### Use

Setup.....	4
Connections .....	5
Making the wireless link .....	6

#### Reference

Product service .....	7
Maintenance .....	7
Troubleshooting guide .....	7
Limited Warranty .....	8
Specifications .....	10



As an ENERGY STAR® Partner,\*  
Panasonic has determined that  
this product meets  
the ENERGY STAR® guidelines  
for energy efficiency.

RQTX0047-Y

**WARNING:**

**TO REDUCE THE RISK OF FIRE, ELECTRIC SHOCK OR PRODUCT DAMAGE,**

- **DO NOT EXPOSE THIS APPARATUS TO RAIN, MOISTURE, DRIPPING OR SPLASHING AND THAT NO OBJECTS FILLED WITH LIQUIDS, SUCH AS VASES, SHALL BE PLACED ON THE APPARATUS.**
- **USE ONLY THE RECOMMENDED ACCESSORIES.**
- **DO NOT REMOVE THE COVER (OR BACK); THERE ARE NO USER SERVICEABLE PARTS INSIDE. REFER SERVICING TO QUALIFIED SERVICE PERSONNEL.**

**CAUTION!**

**DO NOT INSTALL OR PLACE THIS UNIT IN A BOOKCASE, BUILT-IN CABINET OR IN ANOTHER CONFINED SPACE. ENSURE THE UNIT IS WELL VENTILATED. TO PREVENT RISK OF ELECTRIC SHOCK OR FIRE HAZARD DUE TO OVERHEATING, ENSURE THAT CURTAINS AND ANY OTHER MATERIALS DO NOT OBSTRUCT THE VENTILATION VENTS.**

The following mark and symbols are located on bottom of the unit.

	<b>CAUTION</b> RISK OF ELECTRIC SHOCK DO NOT OPEN	
CAUTION: TO REDUCE THE RISK OF ELECTRIC SHOCK, DO NOT REMOVE SCREWS. NO USER-SERVICEABLE PARTS INSIDE. REFER SERVICING TO QUALIFIED SERVICE PERSONNEL.		

The lightning flash with arrowhead symbol, within an equilateral triangle, is intended to alert the user to the presence of uninsulated "dangerous voltage" within the product's enclosure that may be of sufficient magnitude to constitute a risk of electric shock to persons.

The exclamation point within an equilateral triangle is intended to alert the user to the presence of important operating and maintenance (servicing) instructions in the literature accompanying the appliance.

RQTX0047

2

**FCC Note:**

This equipment has been tested and found to comply with the limits for a Class B digital device, pursuant to Part 15 of the FCC Rules. These limits are designed to provide reasonable protection against harmful interference in a residential installation. This equipment generates, uses and can radiate radio frequency energy and, if not installed and used in accordance with the instructions, may cause harmful interference to radio communications. However, there is no guarantee that interference will not occur in a particular installation. If this equipment does cause harmful interference to radio or television reception, which can be determined by turning the equipment off and on, the user is encouraged to try to correct the interference by one or more of the following measures:

- Reorient or relocate the receiving antenna.
- Increase the separation between the equipment and receiver.
- Connect the equipment into an outlet on a circuit different from that to which the receiver is connected.
- Consult the dealer or an experienced radio/TV technician for help.

FCC caution: To maintain compliance with FCC regulations, shielded interface cables must be used with this equipment. Operation with non-approved equipment or unshielded cables may result in interference to radio and TV reception. Any changes or modifications not approved by the party responsible for compliance could void the user's authority to operate this equipment.

This device complies with Part 15 of the FCC Rules. Operation is subject to the following two conditions: (1) This device may not cause harmful interference, and (2) this device must accept any interference received, including interference that may cause undesired operation.

Responsible Party:  
Panasonic Corporation of North America  
One Panasonic Way  
Secaucus, NJ 07094

Support Contact:  
Panasonic Consumer Electronics Company  
Telephone No.: 1-800-211-7262

 **WARNING:**

To satisfy FCC RF exposure requirements for mobile transmitting devices, a separation distance of 20 cm or more should be maintained between the antenna of this device and persons during device operation. To ensure compliance, operations at closer than this distance is not recommended. The antenna used for this transmitter must not be co-located in conjunction with any other antenna or transmitter.

Marking sign is located on bottom of the unit.

# IMPORTANT SAFETY INSTRUCTIONS

Read these operating instructions carefully before using the unit. Follow the safety instructions on the unit and the applicable safety instructions listed below. Keep these operating instructions handy for future reference.

- 1) Read these instructions.
- 2) Keep these instructions.
- 3) Heed all warnings.
- 4) Follow all instructions.
- 5) Do not use this apparatus near water.
- 6) Clean only with dry cloth.
- 7) Do not block any ventilation openings. Install in accordance with the manufacturer's instructions.
- 8) Do not install near any heat sources such as radiators, heat registers, stoves, or other apparatus (including amplifiers) that produce heat.
- 9) Do not defeat the safety purpose of the polarized or grounding-type plug. A polarized plug has two blades with one wider than the other. A grounding-type plug has two blades and a third grounding prong. The wide blade or the third prong are provided for your safety. If the provided plug does not fit into your outlet, consult an electrician for replacement of the obsolete outlet.
- 10) Protect the power cord from being walked on or pinched particularly at plugs, convenience receptacles, and the point where they exit from the apparatus.
- 11) Only use attachments/accessories specified by the manufacturer.
- 12) Use only with the cart, stand, tripod, bracket, or table specified by the manufacturer, or sold with the apparatus. When a cart is used, use caution when moving the cart/apparatus combination to avoid injury from tip-over.
- 13) Unplug this apparatus during lightning storms or when unused for long periods of time.
- 14) Refer all servicing to qualified service personnel. Servicing is required when the apparatus has been damaged in any way, such as power-supply cord or plug is damaged, liquid has been spilled or objects have fallen into the apparatus, the apparatus has been exposed to rain or moisture, does not operate normally, or has been dropped.



## - If you see this symbol-

### Information on Disposal in other Countries outside the European Union



This symbol is only valid in the European Union. If you wish to discard this product, please contact your local authorities or dealer and ask for the correct method of disposal.

The socket outlet shall be installed near the equipment and easily accessible. The mains plug of the power supply cord shall remain readily operable.

To completely disconnect this apparatus from the AC Mains, disconnect the power supply cord plug from AC receptacle.

## Accessory

Please check and identify the supplied accessory. Use number indicated in parentheses when asking for replacement part. (Product number correct as of December 2006. This may be subject to change.)

To order this accessory, refer to "Accessory Purchases" on page 9.

- 1 **AC power supply cord (K2CB2CB00018)**  
For use with this unit only. Do not use it with other equipment. Also, do not use cords for other equipment with this unit.

# Setup

## Preparation

- Turn off all equipment before connection and read the appropriate operating instructions.
- Connect the AC power supply cord after all other connections are complete.

Setup

### ■ Wireless setup diagram

e.g.

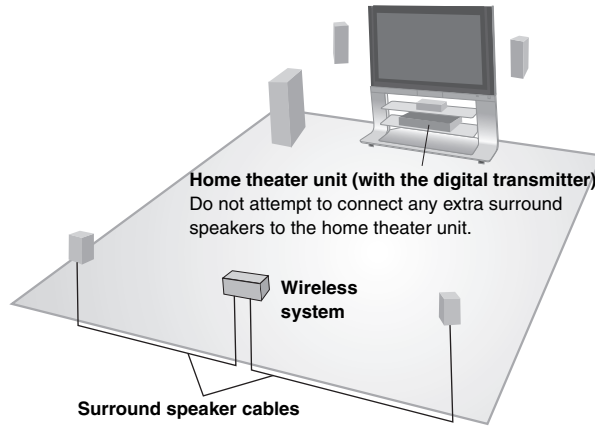

Place the wireless system within approximately 10 m (33 ft) from the home theater unit.

#### Note

Do not use the wireless system and digital transmitter in a metal cabinet or bookshelf.

To avoid interference, maintain the following distances between the wireless system and other electronic devices that use the same radio frequency (2.4 GHz band).

e.g.

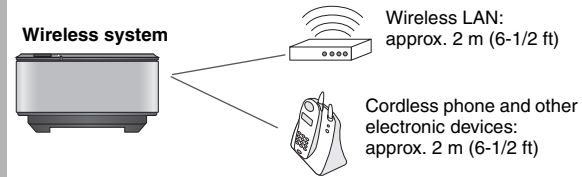

The wireless system will automatically seek a clear channel if any of these other devices interfere with its communication. When this happens, the wireless link indicator ("W1" or an indicator) flashes on the home theater unit, and there is a brief interruption in audio coming from the surround speakers.

This is the normal operation of the product working to assure the best possible performance of your home theater unit.

If the interference persists, try moving the other devices to another location outside the range of the wireless system, or move the wireless system nearer to your home theater unit.

RQTX0047

## Connections

### ■ Digital transmitter

Refer also to the operating instructions for your home theater unit.

**Do not insert or remove while the home theater unit is on.**

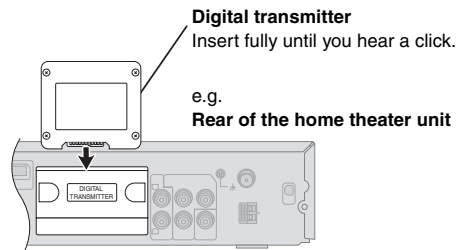

### ■ Wireless system

- 1 If the surround speaker cables have already been connected **Disconnect the surround speaker cables from your home theater unit.**
- 2 **Connect the surround speaker cables to the wireless system.**

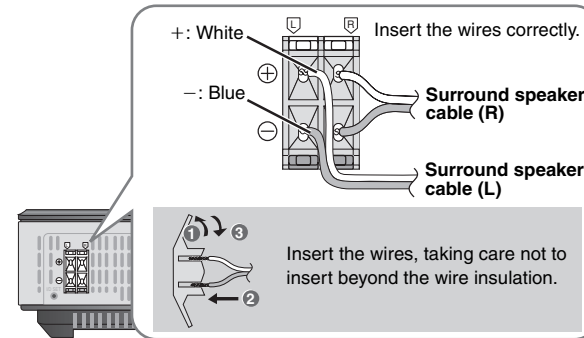

### ■ AC cord

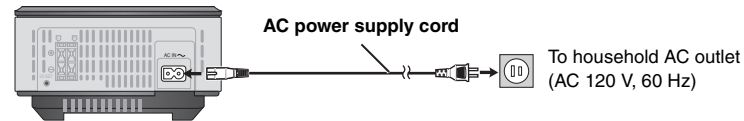

Setup

RQTX0047

5

# Setup

## Making the wireless link

**Setup**

Refer also to the operating instructions for your home theater unit.

### 1 Turn on the wireless system.

#### Unit on/off button [POWER I, ]

Use this button to turn the unit on and off.

 I: The unit is on.  : The unit is off.



#### AUTO OPERATION ON/OFF indicator

The indicator lights red when the unit is turned on and lights green when the wireless link is activated.

When the wireless link is inactive for a long time, it turns red.

### 2 Turn on your home theater unit and check the wireless link indicator on the home theater unit.

e.g. Display on the home theater unit



“W1” or an indicator should light up.

- If “W1” or an indicator is flashing, refer to page 7, Troubleshooting guide.

### 3 Start play on the home theater unit.

#### Conserving power

The wireless system consumes a small amount of power, even when it is off (approx. 0.2 W). To save power when the unit is not to be used for a long time, unplug it from the household AC outlet.

RCTX0047

6

### ■ Pairing with existing SH-FX85 (not included)

Your SE-FX65 can be used with SH-FX85, both operating on the same wireless system as SH-FX85. By pairing, you can enjoy the benefits of both systems working together simultaneously.

#### Preparation

##### ● Use the SH-FX85T transmitter card for pairing.

Store your SH-FX85T transmitter card in a cool dry place for later use.

● Make sure that the speaker and AC cord connections on page 5 are completed.

● Turn on the home theater unit and SH-FX85, and then reduce the volume.

- 1 Turn on SE-FX65.
- 2 While pressing [▶▶/▶▶] on the home theater unit, press the numbered button [3] on the remote control until “P” lights in the home theater unit’s display.
  - The indicator on SE-FX65 turns green.
- 3 While “P” is displayed, press [I/D SET].

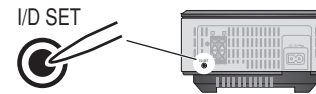

Use a pointed object.

- 4 While pressing [▶▶/▶▶] on the home theater unit, press the numbered button [3] on the remote control.
  - “W1” or the wireless link indicator lights on the home theater unit.
- 5 Turn off and on SE-FX65.
  - Make sure the indicator on SE-FX65 lights up green.

## Product service

- 1. Damage requiring service**—The unit should be serviced by qualified service personnel if:
  - (a) The AC power supply cord or AC adaptor has been damaged; or
  - (b) Objects or liquids have gotten into the unit; or
  - (c) The unit has been exposed to rain; or
  - (d) The unit does not operate normally or exhibits a marked change in performance; or
  - (e) The unit has been dropped or the cabinet damaged.
- 2. Servicing**—Do not attempt to service the unit beyond that described in these operating instructions. Refer all other servicing to authorized servicing personnel.
- 3. Replacement parts**—When parts need replacing ensure the servicer uses parts specified by the manufacturer or parts that have the same characteristics as the original parts. Unauthorized substitutes may result in fire, electric shock, or other hazards.
- 4. Safety check**—After repairs or service, ask the servicer to perform safety checks to confirm that the unit is in proper working condition.

The servicer will require all components to service your system. Therefore, should service ever be necessary, be sure to bring the entire system.

### Product information

For product information or assistance with product operation:

Refer to “Customer Services Directory” on page 9.

## Maintenance

**Clean this unit with a soft, dry cloth.**

- Never use alcohol, paint thinner or benzene to clean this unit.
- Before using chemically treated cloth, carefully read the instructions that came with the cloth.

## Troubleshooting guide

Before requesting service, make the following checks. If you are in doubt about some of the check points, or if the solutions indicated in the table do not solve the problem, refer to the “Customer Services Directory” on page 9.

### On your home theater unit

<b>The wireless link indicator (e.g. “WI” or an indicator) is flashing.</b>	<ul style="list-style-type: none"> <li>• There is no link between the home theater unit and the wireless system. Turn the wireless system off and then back on. Alternatively, turn the wireless system off, disconnect the AC power supply cord, and then reconnect it.</li> </ul>
<b>The wireless link indicator (e.g. “WI” or an indicator) does not light.</b>	<ul style="list-style-type: none"> <li>• Check that the home theater unit is turned on, and the wireless system is turned on.</li> <li>• Ensure that the digital transmitter is fully inserted into the slot of the home theater unit.</li> </ul>

### User memo:

DATE OF PURCHASE \_\_\_\_\_  
 DEALER NAME \_\_\_\_\_  
 DEALER ADDRESS \_\_\_\_\_  
 \_\_\_\_\_  
 TELEPHONE NUMBER \_\_\_\_\_

The model number and serial number of this product can be found on either the back or the bottom of the unit. Please note them in the space provided below and keep for future reference.

MODEL NUMBER \_\_\_\_\_ SH-FX65 \_\_\_\_\_  
 SERIAL NUMBER \_\_\_\_\_

# Limited Warranty

**Panasonic Consumer Electronics Company,  
Division of Panasonic Corporation of North America**  
One Panasonic Way Secaucus, New Jersey 07094

**Panasonic Puerto Rico, Inc.**  
Ave. 65 de Infantería, Km. 9.5  
San Gabriel Industrial Park, Carolina, Puerto Rico 00985

Limited Warranty

## Panasonic Audio Products Limited Warranty

### Limited Warranty Coverage

If your product does not work properly because of a defect in materials or workmanship, Panasonic Consumer Electronics Company or Panasonic Puerto Rico, Inc. (collectively referred to as "the warrantor") will, for the length of the period indicated on the chart below, which starts with the date of original purchase ("warranty period"), at its option either (a) repair your product with new or refurbished parts, or (b) replace it with a new or a refurbished product. The decision to repair or replace will be made by the warrantor.

Product or Part Name	Parts	Labor
Audio Products (except items listed below)	One (1) year	One (1) year
USB Reader-Writer, Personal Computer Card Adapters (in exchange for defective item)	One (1) year	Not Applicable
Accessories: Headphones, Cartridges, Microphones, Adapters	Ninety (90) days	Ninety (90) days
Rechargeable Batteries, DVD-R/-RAM Discs (in exchange for defective item)	Ten (10) days	Not Applicable
SD Memory Cards, Rechargeable Battery Packs (in exchange for defective item)	Ninety (90) days	Not Applicable

During the "Labor" warranty period there will be no charge for labor. During the "Parts" warranty period, there will be no charge for parts. You must carry-in or mail-in your product during the warranty period.

If non-rechargeable batteries are included, they are not warranted. This warranty only applies to products purchased and serviced in the United States or Puerto Rico. This warranty is extended only to the original purchaser of a new product which was not sold "as is". A purchase receipt or other proof of the original purchase date is required for warranty service.

### Carry-In or Mail-In Service

For Carry-In or Mail-In Service in the United States call 1-800-211-PANA (1-800-211-7262) or visit Panasonic web site: <http://www.panasonic.com>  
For assistance in Puerto Rico call Panasonic Puerto Rico, Inc. (787)-750-4300 or fax (787)-768-2910.

### Limited Warranty Limits And Exclusions

This warranty ONLY COVERS failures due to defects in materials or workmanship, and DOES NOT COVER normal wear and tear or cosmetic damage. The warranty ALSO DOES NOT COVER damages which occurred in shipment, or failures which are caused by products not supplied by the warrantor, or failures which result from accidents, misuse, abuse, neglect, mishandling, misapplication, alteration, faulty installation, set-up adjustments, misadjustment of consumer controls, improper maintenance, power line surge, lightning damage, modification, or commercial use (such as in a hotel, office, restaurant, or other business), rental use of the product, service by anyone other than a Factory Servicenter or other Authorized Servicer, or damage that is attributable to acts of God.

**THERE ARE NO EXPRESS WARRANTIES EXCEPT AS LISTED UNDER "LIMITED WARRANTY COVERAGE". THE WARRANTOR IS NOT LIABLE FOR INCIDENTAL OR CONSEQUENTIAL DAMAGES RESULTING FROM THE USE OF THIS PRODUCT, OR ARISING OUT OF ANY BREACH OF THIS WARRANTY.**

(As examples, this excludes damages for lost time, travel to and from the servicer, loss of media or images, data or other memory content. The items listed are not exclusive, but are for illustration only.) **ALL EXPRESS AND IMPLIED WARRANTIES, INCLUDING THE WARRANTY OF MERCHANTABILITY, ARE LIMITED TO THE PERIOD OF THE LIMITED WARRANTY.**

Some states do not allow the exclusion or limitation of incidental or consequential damages, or limitations on how long an implied warranty lasts, so the exclusions may not apply to you.

This warranty gives you specific legal rights and you may also have other rights which vary from state to state. If a problem with this product develops during or after the warranty period, you may contact your dealer or Servicenter. If the problem is not handled to your satisfaction, then write to the warrantor's Consumer Affairs Department at the addresses listed for the warrantor.

**PARTS AND SERVICE WHICH ARE NOT COVERED BY THIS LIMITED WARRANTY ARE YOUR RESPONSIBILITY.**

F1104

RQTX0047



### *Customer Services Directory*

Obtain Product Information and Operating Assistance; locate your nearest Dealer or Servicer; purchase Parts and Accessories; or make Customer Service and Literature requests by visiting our Web Site at:

<http://www.panasonic.com/consumersupport>

or, contact us via the web at:

<http://www.panasonic.com/contactinfo>

You may also contact us directly at: 1-800-211-PANA (7262),  
Monday-Friday 9 am-9 pm; Saturday-Sunday 10 am-7 pm, EST.

For hearing or speech impaired TTY users, TTY : 1-877-833-8855

### *Accessory Purchases*

Purchase Parts, Accessories and Instruction Books online for all Panasonic Products by visiting our Web Site at:

<http://www.pasc.panasonic.com>

or, send your request by E-mail to:

[npcparts@us.panasonic.com](mailto:npcparts@us.panasonic.com)

You may also contact us directly at: 1-800-332-5368 (Phone) 1-800-237-9080 (Fax Only) (Monday – Friday 9 am to 8 pm, EST.)

Panasonic Services Company

20421 84th Avenue South, Kent, WA 98032

(We Accept Visa, MasterCard, Discover Card, American Express, and Personal Checks)

For hearing or speech impaired TTY users, TTY : 1-866-605-1277

### *Service in Puerto Rico*

*Panasonic Puerto Rico, Inc.*

*Ave. 65 de Infantería, Km. 9.5, San Gabriel Industrial Park, Carolina, Puerto Rico 00985*

*Phone (787)750-4300, Fax (787)768-2910*

Limited Warranty

F1104

RQTX0047

9

# Specifications

Specifications

## RF SECTION

<b>Wireless module</b>	
Frequency range	2.400 to 2.4835 GHz
Number of channels	3

## AMPLIFIER SECTION

<b>Output power</b>	
<b>RMS output power</b>	
Surround Ch	125 W per channel (3 Ω), 1 kHz, 10 % THD
Total RMS power	250 W
<b>FTC output power</b>	
Surround Ch	34 W per channel (3 Ω), 120 Hz–20 kHz, 1 % THD
Total FTC power	68 W

## GENERAL

<b>Power supply</b>	AC 120 V, 60 Hz
<b>Power consumption</b>	SH-FX65T 1.5 W
	SE-FX65 35 W
<b>Dimensions (W×H×D)</b>	
SH-FX65T	65 mm×52 mm×8.6 mm (2 9/16"×2 1/16"×11/32")
SE-FX65	165 mm×90 mm×164 mm (6 1/2"×3 17/32"×6 15/32")
<b>Mass</b>	SH-FX65T 0.02 kg (0.04 lbs)
	SE-FX65 0.655 kg (1.54 lbs)
<b>Operating temperature range</b>	+5 °C to +35 °C (+41 °F to +95 °F)
<b>Operating humidity range</b>	5 % to 90 % RH (no condensation)

<b>Power consumption in off mode</b>	approx. 0.2 W
--------------------------------------	---------------

**Note**

- Specifications are subject to change without notice. Mass and dimensions are approximate.
- Total harmonic distortion is measured by a digital spectrum analyzer.

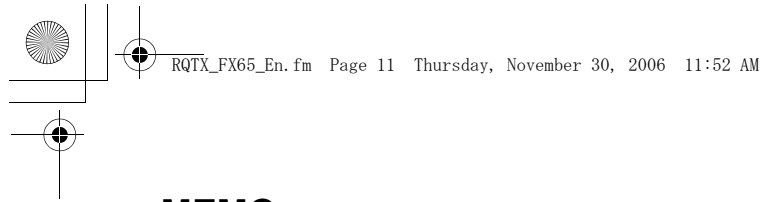

**MEMO**

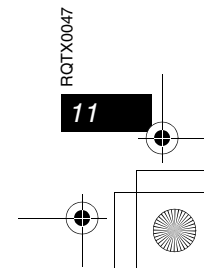
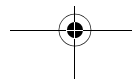
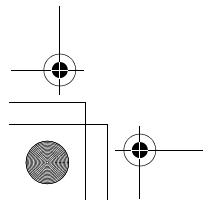
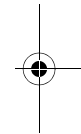
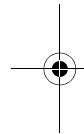
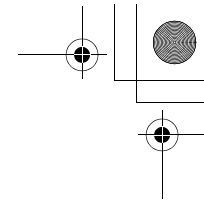

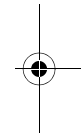
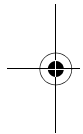
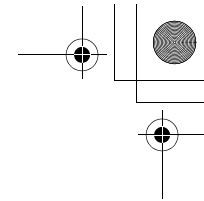
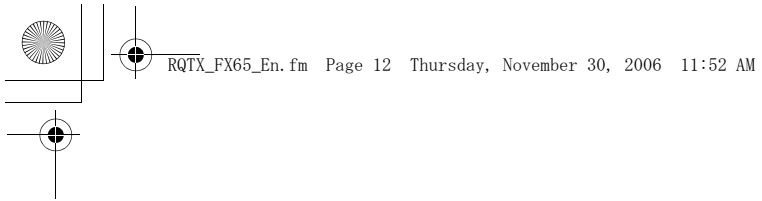

**Panasonic Consumer Electronics  
Company, Division of Panasonic  
Corporation of North America**  
One Panasonic Way Secaucus,  
New Jersey 07094  
<http://www.panasonic.com>

**Panasonic Puerto Rico, Inc.**  
Ave. 65 de Infantería, Km. 9.5  
San Gabriel Industrial Park, Carolina,  
Puerto Rico 00985

En

© 2006 Matsushita Electric Industrial Co., Ltd.  
Printed in Malaysia

RQTX0047-Y  
F1206YM0

