

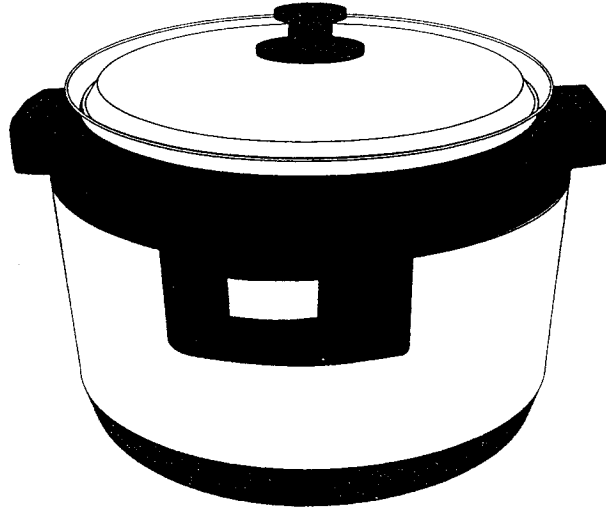

Instruction Manual  
for  
**SUZUMO IH Rice Cooker**

Model : **IH-MS2000**



Use well and economize power cleverly



Suzumo Machinery Co., Ltd.

———— CONTENTS ————

	<i>Page</i>
Cautions on Safety .....	1
Cautions on Use .....	3
Preparation before Boiling Rice .....	4
● How to Set the Present Time .....	4
● Boiling Rice Capacity and How to Wash Rice .....	5
● How to Prepare a Proper Quantity of Water for Boiling Rice .....	5
● Preparation .....	6
Rice cooking instruction .....	7
How to Reserve Boiling Rice .....	8
How to Clean Rice Cooker .....	9
Remedial Measures to be Observed when Rice Cannot be Boiled Well .....	10
Troubleshooting .....	11
Specifications .....	13

# Cautions on Safety

Observe the following cautions without fail

Observe the following cautions without fail for preventing injuries to users and other persons and damage to property in advance.

The degrees of injuries and damage that may be caused by wrong uses as a result of the negligence of the display contents are divided by the following displays and explained.

	<b>WARNING</b>	Negligence of this warning, if any, may cause an accident resulting in series injuries or death.
	<b>CAUTION</b>	Negligence of this caution, if any, may cause an accident resulting in injuries or physical damage only.

The kinds of the contents to be observed are divided by the following graphic displays and described. (The following marks show the examples of graphic displays.)

	This graphic display shows the <b>[Prohibited]</b> contents.
	This graphic display shows the <b>[Forced]</b> contents to be executed without fail.

## **WARNING**

Connect the grounding conductor securely without fail.



Negligence of this caution may cause an electric shock accident if a trouble or electric leak occurs.

Connection of grounding conductor

- For connecting the grounding conductor, please consult your nearest sales agent.

Don't allow any child or unskilled person only to use the rice cooker. Don't use the rice cooker at a place within babies' reach.



Prohibited

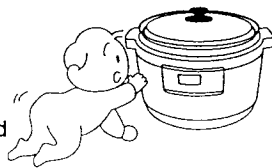

Negligence of this caution may cause a burn or injuries.

Don't dip the rice cooker into water or spray it with water.



Prohibited

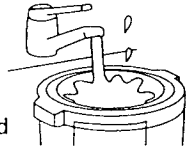

Negligence of this caution may cause a short-circuit failure or an electric shock accident.

- If water was introduced into the body interior, please consult your nearest sales agent.

Wipe off dust particles from power plug.



Negligence of this caution may cause a fire.

Never modify, disassemble, or repair the rice cooker.



Never disassemble



Negligence of this caution may cause a fire, an electric shock accident, or injuries.

- For repair, please contact the customer care center on the seal attached to the body.

Use a power supply having the rating of at least 20A independently.



Don't connect many loads to one electric plug socket together, otherwise the plug socket may be heated abnormally to cause an ignition failure.

**CAUTION**

■ Don't allow your face or hand to be close to the steam blowing out.



Don't touch



Negligence of this caution may cause a burn.

● Don't allow babies to touch the rice cooker, in particular.

■ Don't scratch the power cord. Don't repair the power cord for connection by yourself.



Prohibited

Negligence of this caution may cause a fire or an electric shock accident

■ Hold the power plug without fail whenever you pull it out.



Negligence of this caution may cause an electric shock accident or a short-circuit failure to result in an ignition failure.

■ Disconnect the power plug from the plug socket at all times other than during use.



Disconnect the power plug

Negligence of this caution may cause an electric shock accident due to poor insulation or a fire due to an electric leak.

■ Don't use the rice cooker at a place subjected to water splash or near a fire.



Prohibited

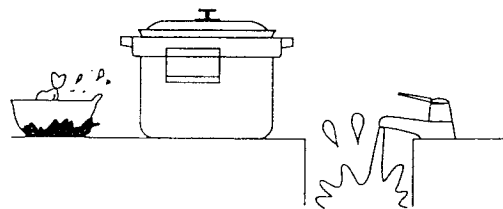

Negligence of this caution may cause an electric shock accident, an electric leak, or a fire.

■ Don't use any pot other than the exclusive inner pot.



Prohibited

Negligence of this caution may cause a burn due to overheat or injuries due to abnormal operation.

■ Don't use the power cord or power plug if damaged or if it is inserted loose to the plug socket.



Prohibited

Negligence of this caution may cause an electric shock accident, a short-circuit failure, or an ignition failure.

■ Don't bend, bundle, or pull the power cord forcibly.



Prohibited

Negligence of this caution may cause a fire or an electric shock accident.

■ Don't use any power supply other than single-phase 208V.



Prohibited

Negligence of this caution may cause a fire or an electric shock accident.

■ Don't use the rice cooker at an unstable place or on a floor-cloth being not resistible against heat.



Prohibited

Negligence of this caution may cause a burn due to tilt down or thermal deformation of the floor-cloth.

■ This product must not be used by cardiac pacemaker wearers.



# Cautions on Use

- Don't use the rice cooker without removing grains or foreign substances.

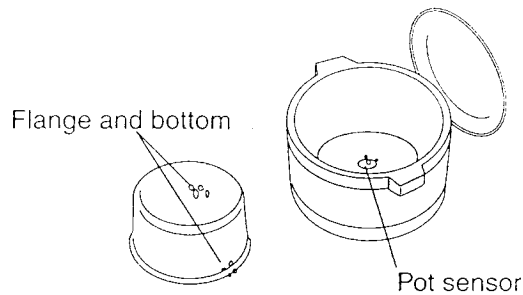

Otherwise a trouble may occur.

- Don't use the rice cooker at the following places.

- A place where the suction port and exhaust port are stopped up.  
A place within 10cm from a wall or the like, or a place on a paper, a cloth, or an easily sucked up substance.
- A place exposed to the direct sunlight.

Otherwise a trouble may occur.

- Don't put any article that may be easily affected by magnetism to be close to the rice cooker.

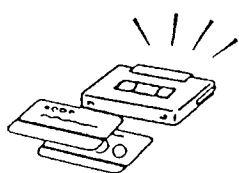

Otherwise saved data may be erased or noises may be produced.

Magnetic cards (cash cards, commutation tickets, etc.)

Magnetic tapes (cassette tape, etc.)

Radio units (TV units, radio receivers, etc.)

- Don't put any dishcloth on the outer lid.

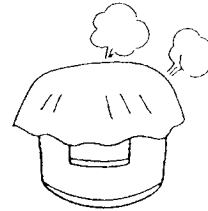

Otherwise it causes a trouble, deformation, a color change, or cracking.

- Don't put any substance near the steam blowing out.

Otherwise the portion exposed to steam may be deformed.

# Preparation before Boiling Rice

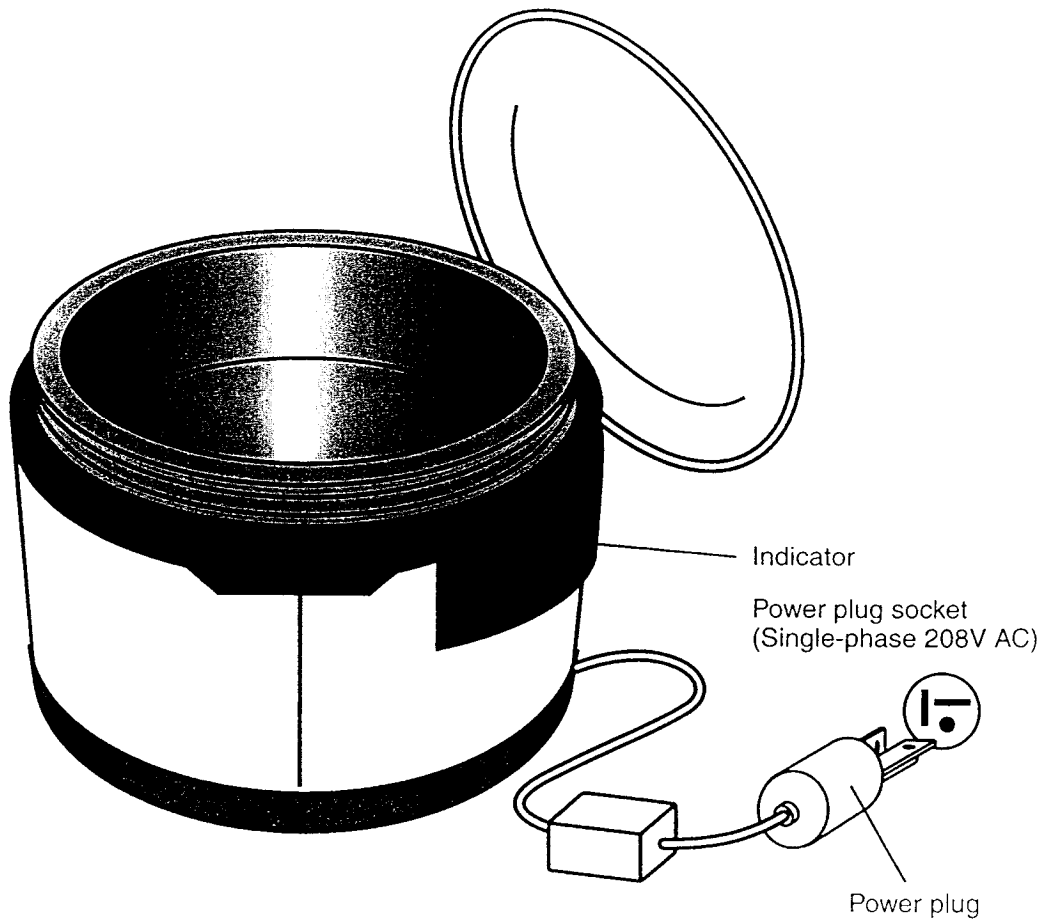

The illustrations on each page show those of SR-IHFA54 (single-phase).

## How to Set the Present Time

(Set the present time correctly, if incorrect.)

- ① Connect the power plug.
- ② Set the present time by pressing [Hour] and [Minute] keys.

- [Hour] or [Minute] key flickers when pressing it.
- Flickering shows that the unit is ready for setting the present time.
- Hour or minute can be fed quickly by pressing the corresponding key continuously.
- Flickering stops when leaving it as it is for 5 seconds.

Indicator      Hours      Minutes

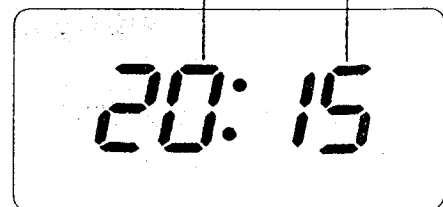

Example: 20:15 hours

### Remarks

- A 24-hoursí clock is provided. Set the indicator to 0:00 at 12:00 hours at midnight or set it to 12:00 hours at noon.
- Time cannot be set during rice cooking, heat insulation, or reservation.

## Boiling Rice Capacity and How to Wash Rice

### Quantity of rice that can be boiled once

(Unit: L)

Polished rice	1.8 ~ 5.4
Rice with assorted mixtures	1.8 ~ 3.6

### Remarks

- Wash rice sufficiently, otherwise incomplete polishing may cause a slightly marked scorched part of boiled rice or smell of rice bran.
- Don't put any rice on a basket for an excessively long time, otherwise rice may crack.

### Caution

- Don't wash any rice by using the inner pot.

## How to Prepare a Proper Quantity of Water for Boiling Rice

**Example:** Assume that polished rice of 3.6L is boiled.

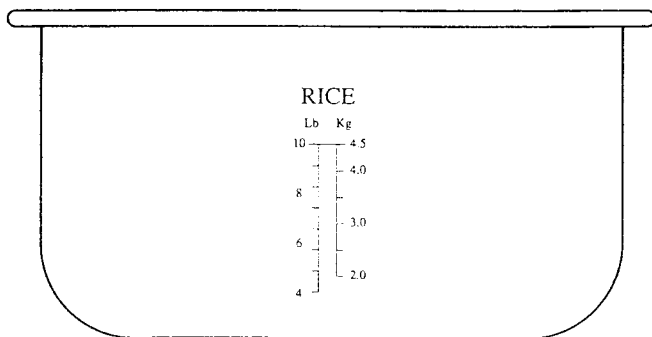

### Caution

- Prepare a proper quantity of water for boiling rice according to the leveled rice.
- Set the water quantity to the same level while monitoring the right and left scales.

### Caution

- Don't put water excessively, otherwise it may boil over.
- By replacing the boiling water after dipping rice with water, a scorched part of boiled rice may be reduced.

### How to handle the inner pot (for preventing the fluorine-coated film from being damaged)

- Don't put any spoons or tableware.
- Don't use any vinegar.
- Wash the inner pot soon after using seasonings.
- Don't wash the inner pot with polishing powder or pot cleaning brushes.
- Don't strike or rub the fringe of the inner pot with rice scoop, basket, bowl, or other articles.
- Use either plastic or wooden rice scoop.
- Don't scratch the inner pot when using a metallic rice scoop.

### If a scorched part of boiled rice weighs on your mind;

- Spread the option rice boiling sheet at the bottom of the inner pot before transferring rice into the inner pot.
- Use the cleanly washed and stuffing-free rice boiling sheet.
- For preparing a proper quantity of water for boiling rice, put water slowly so as not to introduce any rice below the rice boiling sheet or not to displace the sheet.

## Preparation

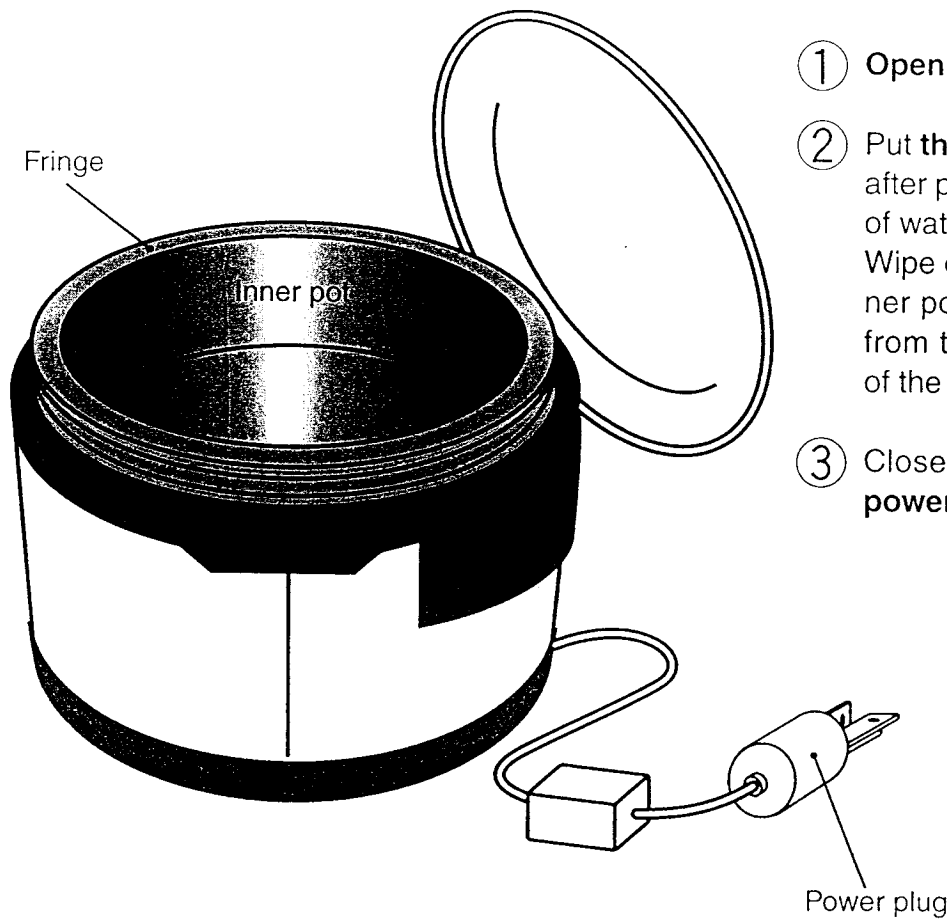

- ① Open the lid.
- ② Put the inner pot into the body after preparing a proper quantity of water for boiling rice. Wipe off moisture around the inner pot and foreign substances from the fringe and the bottom of the pot.
- ③ Close the lid and **connect the power plug.**

Grip (both sides)

- Don't grip the handle, but hold these grips when carrying the rice cooker.

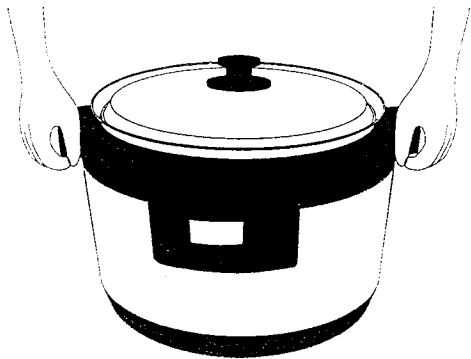



# Rice cooking instruction

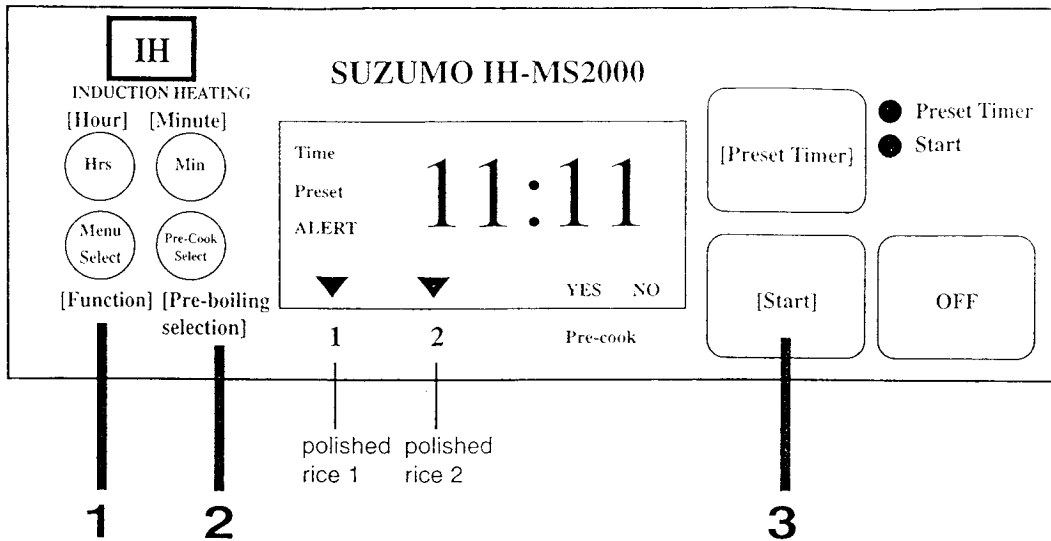

## 1 Select a menu by pressing [Menu Select] key.

- Display ▼ transfers sequentially each time this key is pressed once.  
Polished rice 1 → Polished rice 2

### (Selection method of a menu)

Polished rice 1	Normal boiling
Polished rice 2	Boiling rice with assorted mixtures when scorching weighs on your mind

## 2 Select [Yes] or [No] by pressing [Pre-boiling selection] key.

- [Yes] ... Select [Yes] when boiling is done soon after washing rice.
- [No] .... Select [No] when dipping rice into water for longer than 30 minutes before starting boiling.
- If boiling is done by selecting [Yes] after dipping rice into water for longer than 30 minutes, a scorched part of boiled rice may become noticeable.

## 3 Start boiling by pressing [Start] key.

- Boiling lamp lights.
- The time required to finish boiling is started indicating about 13 minutes before. (or approx. 5 minutes before in case of rice gruel)  
When rice has boiled up, a bleep sounds and rice is thermally insulated automatically.



Reference time required to finish boiling (with pre-boiling)	
Polished rice 1	Polished rice 2
Approx. 50 min.	Approx. 50 min.

- If pre-boiling is not selected, the required time shortens about 13 minutes as counted from the above reference time.

## 4 Mix the entire boiled rice well within 30 minutes after rice has been boiled up for the purpose of preventing from being sticky.

- Since ripening has been completed, boiled rice can be taken soon after it has been boiled up.
- After use, press [OFF] key and disconnect the power plug.
- If power supply is turned off by [OFF] key without disconnecting the power plug, power of about 3W is continued consuming.

# How to Reserve Boiling Rice

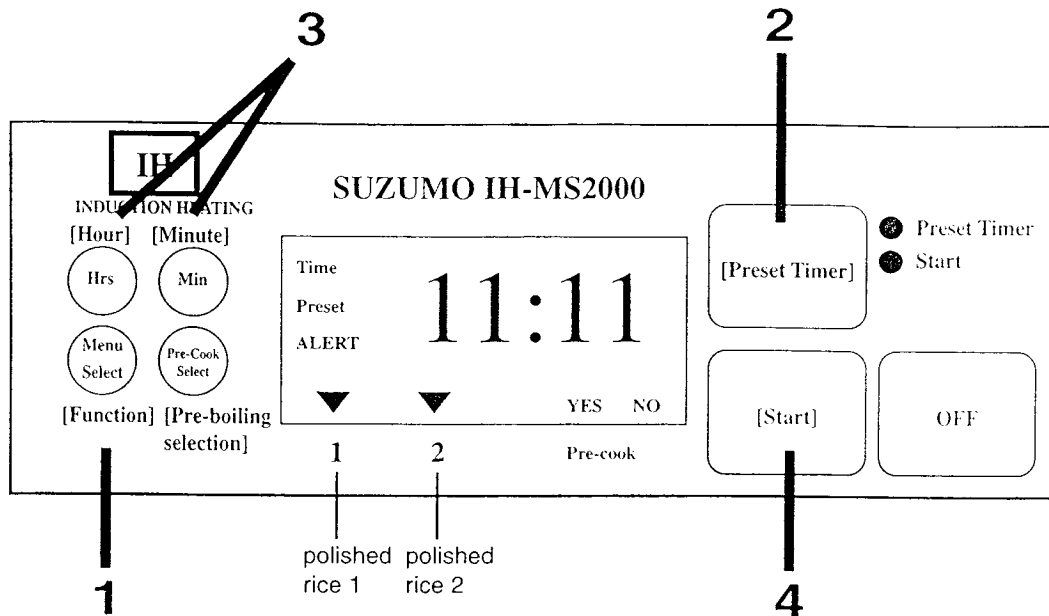

## Rice can be boiled up at a desired time to eat.

- This reservation can be done over the following range.

Polished rice 1	From the present time to a range of 1 ~ 13 hours
Polished rice 2	From the present time to a range of 70 minutes ~ 13 hours

### Note:

- A scorched part of boiled rice may become noticeable in case of reserved boiling rice.
- Select **Polished rice 2** menu or use the boiling rice sheet.
- Refer to page 13, if an error is displayed.
- The residual time required to finish boiling is not displayed.

## 1 Check if the present time is indicated correctly, and select [Menu Select].

- Display ▼ transfers sequentially, each time this key is pressed once.  
Polished rice 1 ↔ Polished rice 2

## 2 Select [Reservation] by pressing [Preset Timer] key.

## 3 Set the time indication to the desired time to eat by pressing [Hour] and [Minute] keys.

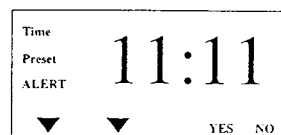

Example: 11:11PM

- [Minute] key advances every 10 minutes.

## 4 Reservation is completed by pressing [Start] key.

- A change of reserved time after the end of reservation.

- Press [OFF] key and repeat the procedure starting with step 1.

# How to Clean Rice Cooker

After disconnecting the power plug, wait for a while until the body is cooled down before starting cleaning.

Don't use any benzine, thinner, polishing powder, or metallic cleaning brushes.

## Inner Pot

Wash the inner pot with a kitchen detergent and a sponge brush, and wipe off water from the outside. If the outside is rusty, remove rust by rubbing the outside with a nylon brush.

**Remarks** Replace the inner pot, if the inner pot is deformed or worn.

## Body

Wipe off with a tightly squeezed cleaning cloth. Never wash them with water.

**Remarks**  
Don't use any kitchen detergent.

## Lid

Wash the lid with a kitchen detergent and a sponge brush.

## Pot Sensor

If the pot sensor is coated with foreign substances, polish the pot sensor lightly with a fine sandpaper (No. 600 or so) and wipe it off with a tightly squeezed cleaning cloth.

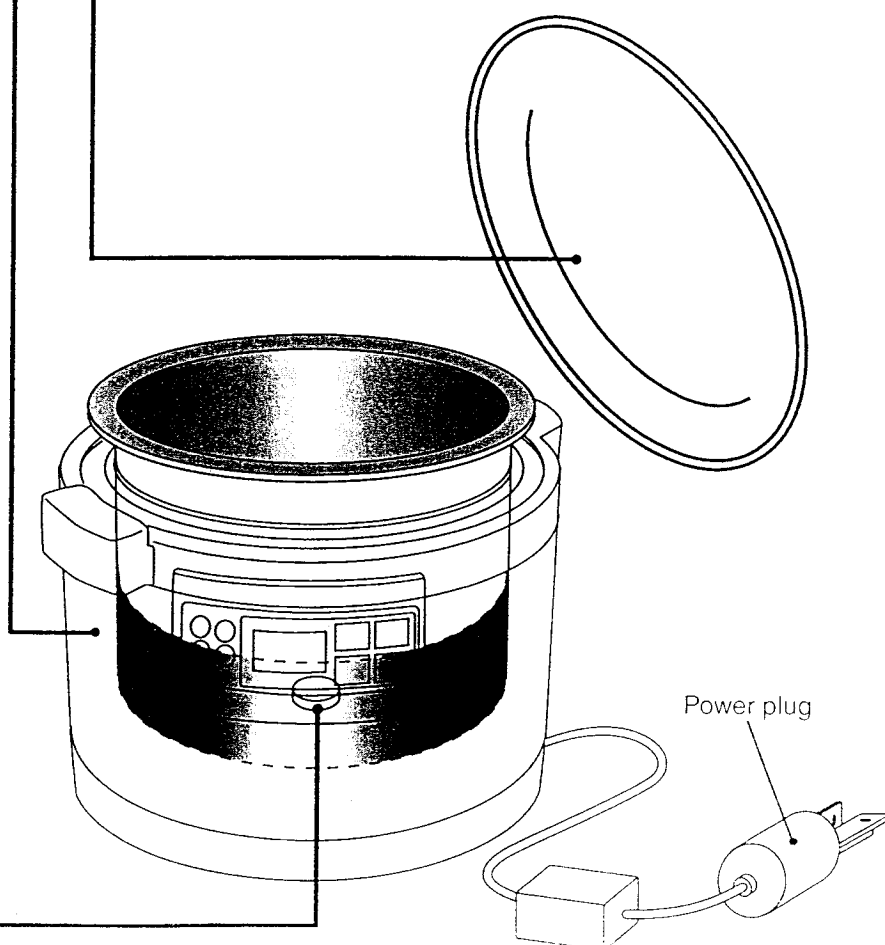

# Remedial Measures to be Observed when Rice Cannot be Boiled well

Symptoms	Check (Reference pages )
<p><b>Boiling over failure</b></p>	<ul style="list-style-type: none"> <li>● Was rice measured correctly?                             <ul style="list-style-type: none"> <li>➔ An error may appear if rice is measured by a measuring rice bin.</li> </ul> </li> <li>● Was water measured correctly? (See Page 5)                             <ul style="list-style-type: none"> <li>➔ For preparing a proper quantity of water, level water to the same level while monitoring the right and left scales.</li> </ul> </li> <li>● Is the boiling rice capacity correct? (See Page 5)</li> <li>● Was rice washed until water becomes clean? (See Page 5)</li> <li>● Has [Menu] been set correctly? (See Page 7)</li> <li>● Is the inner cover mounted? (See Page 6)</li> </ul>
<p><b>Rice is hard, soft, or half-boiled</b></p>	<ul style="list-style-type: none"> <li>● Was rice measured correctly?                             <ul style="list-style-type: none"> <li>➔ An error may appear if rice is measured by a measuring rice bin.</li> </ul> </li> <li>● Was water measured correctly? (See Page 5)                             <ul style="list-style-type: none"> <li>➔ For preparing a proper quantity of water, level water to the same level while monitoring the right and left scales.</li> </ul> </li> <li>● Was the side face or bottom (outside) of the inner pot free of oil or grease deposit?</li> <li>● Was the reserved boiling not done with assorted mixtures or seasonings? (See Page 8)</li> <li>● Was rice boiled without mixing it with assorted mixtures? (See Page 8)</li> <li>● Was polished rice not kept in a basket for a long time or not saved in a refrigerator before starting boiling? (See Page 5)</li> </ul>
<p><b>Boiled rice is scorched</b></p> <p>( Boiled rice is slightly scorched light brown at the bottom to boil up nice-smelling boiled rice. )</p>	<ul style="list-style-type: none"> <li>● Was rice washed until water becomes clean? (See Page 5)</li> <li>● Has [Pre-boiling selection] key been set correctly? (See Page 7)</li> <li>● Was rice not boiled with assorted mixtures or seasonings?</li> <li>● Are foreign substances not attached to the outside of the inner pot or pot sensor? (See Page 3)</li> <li>● Was the inner pot washed cleanly?                             <ul style="list-style-type: none"> <li>➔ Wash the inner pot particularly carefully after boiling rice with assorted mixtures.</li> </ul> </li> </ul>

Rice just boiled up may becomes slightly hollow at its center, because the entire pot is heated to wrap rice during boiling as a feature of IH heating.

# Troubleshooting

Check the following items before asking your nearest customer care center for servicing.

Symptoms	Check (Reference pages )
<p>Rice cannot be boiled up at the reserved time.</p>	<ul style="list-style-type: none"> <li>● Is the present time indicated correctly? (See Page 4)                             <ul style="list-style-type: none"> <li>➔ Recheck the 24-hoursí indication timer</li> </ul> </li> <li>● Is the reservation not set for longer than 13 hours? (See Page 8)                             <ul style="list-style-type: none"> <li>➔ Setting exceeding 13 hours is not allowable for preventing rice from being rotted. The reserved time is changed automatically, and rice is boiled up after 13 hours.</li> </ul> </li> </ul>
<p>Boiling is started soon after Presetting timer.</p>	<ul style="list-style-type: none"> <li>● Is the present time indicated correctly? (See Page 4)                             <ul style="list-style-type: none"> <li>➔ Recheck the 24-hoursí indication timer.</li> </ul> </li> <li>● Is reservation not set to be within 1 hour (or within 70-minutes in case of rice gruel)? (See Page 8)                             <ul style="list-style-type: none"> <li>➔ If Timer is set to be within 1 hour (or within 70 minutes in case of rice gruel), boiling is started at once.</li> </ul> </li> </ul>
<p>Preset memory has been erased. Present time indication is thin or it goes out.</p>	<ul style="list-style-type: none"> <li>● Lithium cell has reached its life.                             <ul style="list-style-type: none"> <li>➔ Replace it at your sales agent. It lasts about 4 ~ 5 years. (under the disconnected condition of power plug) The rice cooker can be used by connecting the power plug even if the lithium cell has reached its life. However, the time is started with 8:30 hours when the power plug is disconnected.</li> </ul> </li> </ul>
<p>An error display has appeared after bleeping 6 times.</p>	<ul style="list-style-type: none"> <li>● Is the presrt not set for longer than 13 hours? (See Page 8)                             <ul style="list-style-type: none"> <li>➔ Setting exceeding 13 hours is not allowable for preventing rice from being rotted. The reserved time is changed automatically, and rice is boiled up after 13 hours. Set the reservation again to be within 13 hours.</li> </ul> </li> </ul>
<p>Key operation is impossible. Boiling is not started by pressing [Start] key.</p>	<ul style="list-style-type: none"> <li>● Is the power plug connected to the plug socket?</li> <li>● Is [U10] or [H10] not displayed on the indicator? (See Page 14)</li> </ul>

## Error displays

## Check items

U 10

- Has the inner pot been set?  
➔ Set the exclusive inner pot and press [OFF] key.

U 11

- Is the reservation not set for longer than 13 hours?  
➔ Press [OFF] key.  
For thermally insulating as it is, press [OFF] key again.

U 12

- Are the inner pot bottom and pot sensor free of foreign substances?  
➔ Remove foreign substances and press [OFF] key.
- Is the water quantity proper without being excessive?  
➔ Press [OFF] key.  
For next boiling rice, reduce the water quantity more or less.

H 01~H 09

- Ask your nearest customer care center for repair.  
For the customer care center, see the seal being attached on the body.

Power was interrupted halfway during boiling

- Boiled up time may be delayed.
- A boiling failure may occur depending upon the power interruption duration.

A tone sounds during boiling or heat insulation

- Whirring is caused by the turning of the heat exhaust fan.
- A current feeding tone sounds.
- A steam discharge tone sounds, but this does not show any abnormal symptom.

※ If the inner pot is deformed due to its drop or striking, it must be replaced with new one.

# Specifications

Model		IH-MS2000
Power supply		Single-phase 208V 50/60Hz
Power consumption (Approx.) W	During boiling	3750
Boiling capacity L	Polished rice	1.8 ~ 5.4
	Boiled rice with assorted mixtures	1.8 ~ 3.6
Cord length m		1.8
Weight (Approx.) kg		16
Dimensions (Approx.) cm	Width	55.0
	Depth	48.0
	Height	38.0

- The power consumption is approx. 3W when the power supply is turned off.



Suzumo Machinery Co.,Ltd.  
 Ohashi Gyoen Bldg.,  
 2-3-15 shinjuku, Sfinjuku-ku, Tokyo 160-0022  
 Tel. (03) 3356-1271  
 (03) 3356-1276 (Direct line)  
 Fax. (03) 3356-1210

<http://www.suzumo.co.jp>

Suzumo Machinery USA Inc.  
 27 Mauchly, Suite 212  
 Irvine, CA 92618  
 USA  
 Phone: (949) 585-0032 Fax: (949) 585-0034