

Panasonic®

Owner's Manual
Manuel d'utilisation
Instrucciones de funcionamiento
Manual de instruções

Digital Wireless Stereo Headphones Casque d'écoute stéréo sans fil numérique Cascos auriculares estéreo inalámbricos digitales Auscultadores estéreo sem fios digitais

Model No. **RP-BTD10**
N° de modèle



ENGLISH
FRANÇAIS
ESPAÑOL
PORTUGUÊS



If you have any questions, visit:
In the U.S.A. and Puerto Rico:
www.panasonic.com/support
In Canada:
www.panasonic.ca/english/support

Pour toute question, visitez :
www.panasonic.ca/french/support

Si usted tiene alguna pregunta, visite:
www.panasonic.com/support

For U.S.A. and Puerto Rico only
The warranty can be found on page 10.
Register online at
www.panasonic.com/register
(U.S. customers only)

For Canada only
The warranty can be found on page 11.
La garantie se trouve à la page 10.
La garantía se puede encontrar en la página 9.

PP

VQT5J78

Dear customer

Thank you for purchasing this product. Please read these instructions carefully before using this product, and save this manual for future use.

Table of contents

Before use

Accessories	2
Part names	2

Preparation

Charging	3
Turning the power on/off.....	3
Connecting a Bluetooth® device	3
One-Touch Connection (Connecting by NFC)	4

Operation

Listening to music.....	4
Making a phone call.....	5
Useful functions	5

Other

Restoring to the factory settings.....	6
Maintenance	6
About Bluetooth®	6
Safety precautions.....	7
Troubleshooting guide	8
Specifications	9
Copyright, etc.	9
Limited Warranty (ONLY FOR U.S.A. AND PUERTO RICO).....	10
Limited Warranty (ONLY FOR CANADA)	11
To remove the battery when disposing of this unit.....	38

VQT5J78

2

2

Accessories

Please check and identify the supplied accessories.

Use numbers indicated in parentheses when asking for replacement parts. (As of February 2014)

Only for U.S.A. and Puerto Rico:
To order accessories, refer to “Accessory Purchases (United States and Puerto Rico)” on page 10.

Only for Canada:
To order accessories, contact the dealer from whom you have made your purchase.

- 1 Detachable cord [RFX0H75]
- 1 USB charging cord [RFX0H76]

Part names

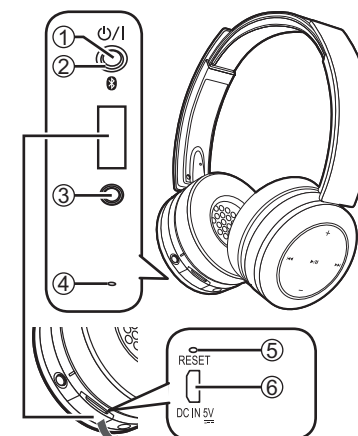

Open the cover

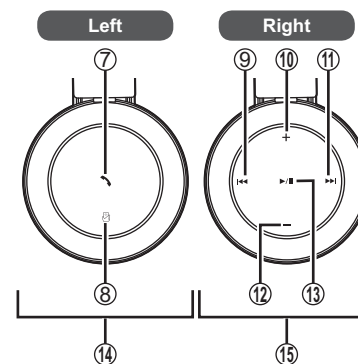

The product illustrations may differ from the actual product.

① Power \mathcal{P} /I / Pairing \mathcal{P} button

② LED indicator light*

- The number of blinks or color notifies the status of the unit. (* hereafter referred to as “LED”)

③ Audio input terminal

- Connect the detachable cord (supplied) to this terminal when using the unit as wired headphones.

④ Microphone

⑤ RESET hole

⑥ Charging terminal (DC IN)

- Connect the USB charging cord (supplied) to this terminal when charging. (→ P. 3)

⑦ Call \mathcal{P}

⑧ NFC touch area

⑨ Previous \mathcal{P}

⑩ Volume +

⑪ Next \mathcal{P}

⑫ Volume -

⑬ Play/Pause \mathcal{P}

⑭ Left speaker

⑮ Right speaker

■ Note

- Excessive sound pressure from earphones and headphones can cause hearing loss.
- Listening at full volume for long periods may damage the user's ears.
- Do not use any other USB charging cords except the supplied one.
- Do not use any other detachable cords except the supplied one.
- When using the unit, do not cover the left speaker with the palm of your hand. The Bluetooth® connection may be blocked.

Charging

The rechargeable battery (installed in the unit) is not charged initially. Charge the battery before using the unit.

1 Connect this unit to a computer using the USB charging cord

- During charging, the LED on the left speaker will light in red. When charging is completed, the LED will go out.
- Charging will take approximately 4.5 hours from empty state to fully charged.

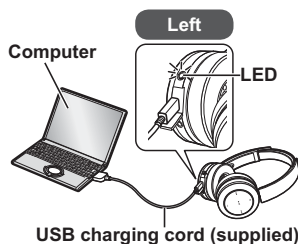

■ Note

- Recharge in a room temperature between 10 °C and 35 °C (50 °F and 95 °F).
- The power cannot be turned on while charging.
- Do not use any other USB charging cords except the supplied one.

Caution: Use only the supplied USB charging cord when connecting to a computer.

■ About Bluetooth®

- The Bluetooth® feature cannot be used when this unit is connected to a computer using the USB charging cord.

Turning the power on/off

1 Press and hold the power ϕ /I button for approximately 2 seconds

- A beep will sound and the LED on the left speaker will light.

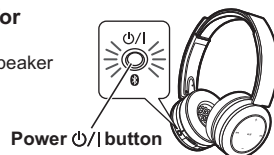

To turn the power off

- Press and hold the power ϕ /I button for 2 seconds or more. A beep will sound and the power will be turned off.

■ Note

- When the unit is not operated for approximately 5 minutes, the power will automatically turn off. (See "Auto power off" (P. 5))

Connecting a Bluetooth® device

To establish a wireless connection, register the unit with Bluetooth® compatible devices.

Preparation on the Bluetooth® device

- Turn on the power, and enable the Bluetooth® feature.
- Place the device within 1 m (3.3 feet) from the unit.
- Check the device operation in its operation instructions, as required.

Power on for the first time

1 Turn on the unit

- The unit will start searching for the Bluetooth® device to connect to, and the LED on the left speaker will blink in blue and red alternately. (Only one operation after purchase)

2 When the unit ("RP-BTD10") is detected by the Bluetooth® device, select it

- If prompted for a passkey, input "0000 (four zeros)".
- If the Bluetooth® profile selection screen appears, select the "A2DP" profile. If "A2DP" is not supported or if you want to just use phone calls, select the "HSP" or "HFP" profile. (For details on profiles, see "Listening to music" (P. 4) and "Making a phone call" (P. 5))

3 Check the connection with the Bluetooth® device on the unit

- First the LED on the left speaker lights in blue and repeats on and off. When the connection is established, it will blink in blue.

Connection after the second time

<Connect the same Bluetooth® device>

When the unit is turned on, it will search for the previously setup Bluetooth® device and automatically start connecting to it. First the LED on the left speaker lights in blue and repeats on and off. When the connection is established, it will blink in blue.

<Connect a different Bluetooth® device>

Disable the Bluetooth® feature on the previously connected device. Check that the unit is turned off. Press and hold the pairing ϕ button for approximately 5 seconds. The unit will start searching for other Bluetooth® device. The LED on the left speaker will blink in blue and red alternately. A beep will sound. Continue steps 2 and 3 on the left.

■ Note

- If connection to a device is not established within approximately 5 minutes, the unit will be turned off. Start from step 1 again.
- 2 or more Bluetooth® devices cannot be connected to the unit at the same time.
- You can pair up to 8 devices with this unit. If a 9th device is paired, the device with the oldest connection will be replaced. To use it, pair it again.

One-Touch Connection (Connecting by NFC)

For NFC-compatible Android™ devices only

The NFC (Near Field Communication) feature allows this unit to connect easily to an NFC-compatible Bluetooth® device. Just touch this unit with your Bluetooth® device to automatically turn on this unit, pair the Bluetooth® device, and establish a connection.

Preparation

Turn on the NFC feature of the Bluetooth® device.

1 Start the application to play music/video on the Bluetooth® device

- Follow on-screen instructions on your device.

2 Touch and hold your device on the NFC touch area of this unit (until a pop-up window on your device indicates that the connection is established)

- The unit is turned on. First the LED on the left speaker lights in blue and repeats on and off. When the connection is established, it will blink in blue.
- If the connection is not established, change the position to touch.

3 Start playing music/video on your Bluetooth® device

■ Connecting to another device

Touch this unit with another device to establish a new Bluetooth® connection. The previously connected device will be automatically disconnected.

Listening to music

If the Bluetooth® compatible device supports the "A2DP" and "AVRCP" Bluetooth® profiles, music can be played back with remote control operations on the unit.

- **A2DP** (Advanced Audio Distribution Profile): Transmits audio to the unit.
- **AVRCP** (Audio/Video Remote Control Profile): Allows remote control of the device using the unit.

1 Connect the Bluetooth® device and the unit (→ P. 3)

2 Select and play the music on the Bluetooth® device

- The selected music is output to the speakers of the unit.

Operating time of battery

V01T5J78

4

Battery type	Operating time
Rechargeable battery (installed in the unit)	Approx. 40 hours

4 Operating time may be less depending on the operating conditions.

■ Note

- Bluetooth® devices that support aptX® can transmit higher quality music.

■ Attention

- The unit might leak sound depending on the volume level.
- When the volume is increased to near maximum level, music may sound distorted. Decrease the volume until the distortion is cleared.

Remote controlling

You can control the Bluetooth® device using the unit.

- Depending on Bluetooth® devices, some functions below do not work, or work differently via operation of the unit.

(Operation example)

Play/Pause	
▶/	Press Play/Pause
Previous/Next	
◀◀	Press during playback Press and hold Return to the start of current track Rewind
▶▶	Press during playback Press and hold Forward to the start of next track Fast forward
Volume	
+	Press Increase the volume
	Press and hold Increase the volume continuously
-	Press Decrease the volume
	Press and hold Decrease the volume continuously

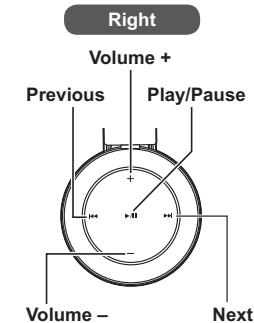

■ Note

- The volume can be adjusted in 15 levels. When the maximum or minimum volume is reached, a beep will sound.

Making a phone call

With Bluetooth® enabled phones (cell phones or smartphones) that support the “HSP” or “HFP” Bluetooth® profile, you can use the unit for phone calls.

- **HSP** (Headset Profile):
Hands-free phone calls are possible using the unit.
- **HFP** (Hands-Free Profile):
In addition to the HSP function, an advanced communication feature is available.

1 Connect the Bluetooth® enabled phone and unit (→ P. 3)

2 When answering an incoming call

Press Call on the unit and answer the call

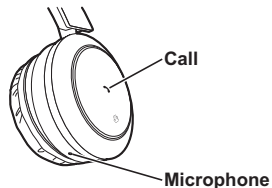

- During an incoming call, ringtone will sound from the speaker and the LED will blink.
- **(HFP only)** To reject the incoming call, press and hold Call  until the ringtone stops.

Left



When making an outgoing call

Make an outgoing call on the Bluetooth® enabled phone

- Also refer to the operating manual for the Bluetooth® enabled phone.
- (Checking and operation steps on the unit are explained below)**
- During an outgoing call, ringtone will sound from the speaker and the LED will blink.
- To cancel the outgoing call, press Call . A beep will sound.
- **(HFP only)** When the phone is idle, press and hold Call  for approximately 2 seconds. An outgoing call will be made to the last dialed number. One short continuous ringtone will sound from the speaker and the LED will blink.

3 Start talking

- The LED will repeatedly blink 3 times during a call.
- The volume can be adjusted during a phone call. For setting instructions, see page 4.

4 Press Call to end the phone call

- A beep will sound.

■ Note

- There may be instances when hands free operation needs to be set on the Bluetooth® enabled phone.
- Depending on the Bluetooth® enabled phone, you may hear incoming and outgoing call ringtones of the phone from the unit.
- If you cannot check the outgoing call, press and hold Call  on the unit for approximately 2 seconds and switch the device used for the call from the Bluetooth® enabled phone to the unit.
(HFP only) Each time you perform the above operation when dialing or taking a call, the calling device will switch between the Bluetooth® enabled phone and the unit.

Useful functions

Resetting the unit

This unit can be reset when all operations are rejected. Connect the unit to a computer using the USB charging cord. Then press the RESET hole with a thin, pointed object, such as a needle. Check that the LED (red) goes out. Keep pressing the RESET hole (→ P. 2) for approximately 5 seconds to reset the unit. All the previous operations will be canceled. (The pairing device information will not be deleted.)

Auto power off

If the unit is silent for approximately 5 minutes and operations for Bluetooth® devices are idle during that period, a beep will sound and the power will be automatically turned off.

LED indicator light

When the battery level is low during use of the unit, the blue blinking LED on the left speaker will change to red. A beep will sound every 1 minute. When the battery runs out, the power will turn off.

Restoring to the factory settings

When you want to delete all pairing device information, etc., you can restore the unit to the factory settings (original settings upon purchase).

1 Turn off the unit

2 Press and hold the power /| button and Previous for 5 seconds or more simultaneously

- The LED on the left speaker will light in red for approximately 2 seconds. The unit will restore to the factory settings.

Maintenance

Clean this unit with a dry and soft cloth.

- Do not use solvents including benzine, thinner, alcohol, kitchen detergent, a chemical wiper, etc. This might cause the exterior case to be deformed or the coating to come off.

About Bluetooth®

Panasonic bears no responsibility for data and/or information that is compromised during a wireless transmission.

■ Frequency band used

This unit uses the 2.4 GHz frequency band.

■ Certification of this unit

- This unit conforms to frequency restrictions and has received certification based on frequency laws. Thus, a wireless permit is not necessary.
- The actions below are punishable by law in some countries:
 - Taking apart/modifying the unit.
 - Removing specification indications.

■ Restrictions of use

- Wireless transmission and/or usage with all Bluetooth® equipped devices is not guaranteed.
- All devices must conform to standards set by Bluetooth SIG, Inc.
- Depending on the specifications and settings of a device, it can fail to connect or some operations can be different.
- This system supports Bluetooth® security features. But depending on the operating environment and/or settings, this security is possibly not sufficient. Transmit data wirelessly to this system with caution.
- This system cannot transmit data to a Bluetooth® device.

■ Range of use

Use this unit at a maximum range of 10 m (33 feet).

The range can decrease depending on the environment, obstacles or interference.

■ Interference from other devices

- This unit may not function properly and troubles such as noise and sound jumps may arise due to radio wave interference if this unit is located too close to other Bluetooth® devices or the devices that use the 2.4 GHz band.
- This unit may not function properly if radio waves from a nearby broadcasting station, etc. is too strong.

■ Intended usage

- This unit is for normal, general use only.
- Do not use this system near an equipment or in an environment that is sensitive to radio frequency interference (example: airports, hospitals, laboratories, etc).

Safety precautions

■ Unit

- Avoid using or placing this unit near sources of heat.
- Do not operate this unit while driving or cycling.
- Do not listen with this unit at high volume in places where you need to hear sounds from the surrounding environment for safety, such as at railroad crossings, and construction sites.

WARNING:

- To reduce the risk of fire, electric shock or product damage,
- Do not expose this unit to rain, moisture, dripping or splashing.
 - Do not place objects filled with liquids, such as vases, on this unit.
 - Use only the recommended accessories.
 - Do not remove covers.
 - Do not repair this unit by yourself. Refer servicing to qualified service personnel.

■ Allergies

- Discontinue use if you experience discomfort with the speakers or any other parts that directly contact your skin.
- Continued use may cause rashes or other allergic reactions.

THE FOLLOWING APPLIES IN THE U.S.A. AND CANADA

This device complies with Part 15 of FCC Rules and Industry Canada licence-exempt RSS standard(s).

Operation is subject to the following two conditions:

- (1) This device may not cause interference, and
- (2) this device must accept any interference, including interference that may cause undesired operation of this device.

FCC ID : ACJ-RP-BTD10

IC : 216A-RPBD10

This transmitter must not be co-located or operated in conjunction with any other antenna or transmitter.

This equipment complies with FCC/IC radiation exposure limits set forth for an uncontrolled environment and meets the FCC radio frequency (RF) Exposure Guidelines and RSS-102 of the IC radio frequency (RF) Exposure rules. This equipment has very low levels of RF energy that are deemed to comply without testing of specific adsorption ratio (SAR).

THE FOLLOWING APPLIES ONLY IN THE U.S.A.

FCC Note:

This equipment has been tested and found to comply with the limits for a Class B digital device, pursuant to Part 15 of the FCC Rules.

These limits are designed to provide reasonable protection against harmful interference in a residential installation. This equipment generates, uses and can radiate radio frequency energy and, if not installed and used in accordance with the instructions, may cause harmful interference to radio communications. However, there is no guarantee that interference will not occur in a particular installation. If this equipment does cause harmful interference to radio or television reception, which can be determined by turning the equipment off and on, the user is encouraged to try to correct the interference by one or more of the following measures:

- Reorient or relocate the receiving antenna.
- Increase the separation between the equipment and receiver.
- Connect the equipment into an outlet on a circuit different from that to which the receiver is connected.
- Consult the dealer or an experienced radio/TV technician for help.

Any unauthorized changes or modifications to this equipment would void the user's authority to operate this device.

This device complies with Part 15 of the FCC Rules. Operation is subject to the following two conditions: (1) This device may not cause harmful interference, and (2) this device must accept any interference received, including interference that may cause undesired operation.

Declaration of Conformity

Trade Name: Panasonic

Model No.: RP-BTD10

Responsible Party: Panasonic Corporation of North America
Two Riverfront Plaza, Newark, NJ 07102-5490

Support Contact: <http://www.panasonic.com/contactinfo>

THE FOLLOWING APPLIES ONLY IN CANADA.

CAN ICES-3(B)/NMB-3(B)

Troubleshooting guide

Before requesting service, make the following checks. If you are in doubt about some of the check points, or if the remedies indicated in the chart do not solve the problem, refer to "Customer Services Directory (United States and Puerto Rico)" on page 10 if you reside in the U.S.A. or Puerto Rico, or refer to "Limited Warranty (ONLY FOR CANADA)" on page 11 if you reside in Canada.

General

No operation

- Press RESET hole while connecting the USB charging cord to the charging terminal (DC IN). (→ P. 5)

Power supply and charging

Cannot charge the unit

- Make sure the computer is turned on and is not on standby or sleep mode.
- Is the USB port you are currently using working properly? If your computer has other USB ports, unplug the connector from its current port and plug it into one of the other ports.
- If the measures mentioned above are not applicable, unplug the USB charging cord and plug it in again.
- Is the LED blinking in red ? There is a charging malfunction if the LED is blinking.
- If the LED is blinking fast in red even when the unit is being recharged in a room temperature within 10 °C and 35 °C (50 °F and 95 °F), the battery may have run down. (Number of recharging times of the included battery: Approximately 500).

LED does not light during charging/Charging takes longer

- Is the USB charging cord (supplied) connected firmly to the USB terminal of the computer? (→ P. 3)

The power does not turn on

- Is the unit being charged? The power cannot be turned ON during charging. (→ P. 3)
- Is the detachable cord connected? The power cannot be turned on when the detachable cord is connected to the unit.

Bluetooth® device connecting

The device cannot be connected

- Delete the pairing information for this unit from the Bluetooth® device, then pair them again. (→ P. 3)

Sound and audio volume

No sound

- Make sure that the unit and the Bluetooth® device are connected correctly. (→ P. 3)
- Check if music is playing on the Bluetooth® device.
- Make sure that the unit is turned on and the volume is not set too low.
- Pair and connect the Bluetooth® device and the unit again. (→ P. 3)

Low volume

- Increase the volume of the unit. (→ P. 4)
- Increase the volume on the Bluetooth® device.

Sound from the device is cut off / Sound quality is bad

- Sound may be disrupted if signals are blocked. Do not fully cover this unit with the palm of your hand, etc.
- The device may be out of the 10 m (33 feet) communication range. Move the device nearer to this unit.
- Remove any obstacle between this unit and the device.
- Switch off any wireless LAN device when not in use.
- A communication problem may arise if the battery is depleted. Charge the unit. (→ P. 3)

Calls

You cannot hear the other person

- Make sure that the unit and the Bluetooth® enabled phone are turned on.
- Check if the unit and the Bluetooth® enabled phone are connected. (→ P. 3)
- Check the audio settings of the Bluetooth® enabled phone. Switch the calling device to the unit if it is set to the Bluetooth® enabled phone. (→ P. 3)
- If the volume of the other person's voice is too low, increase the volume of both the unit and the Bluetooth® enabled phone.

Specifications

■ General

Power supply	DC 5 V, 500 mA (Internal battery : 3.6 V (Li-ion 690 mAh))
Operating time*¹ (SBC mode)	Approx. 40 hours
Charging time*² (25 °C (77 °F))	Approx. 4.5 hours
Charging temperature range	10 °C to 35 °C (50 °F to 95 °F)
Operating temperature range	0 °C to 40 °C (32 °F to 104 °F)
Operating humidity range	35%RH to 80%RH (no condensation)
Mass (Weight)	Approx. 198 g (7.0 oz)

*¹ It may be shorter depending on the operating conditions.

*² Time taken to recharge from empty to full

■ Bluetooth® section

Bluetooth® system specification	Ver.3.0
Wireless equipment classification	Class 2 (2.5 mW)
Frequency band	2.4 GHz band FH-SS
Supported profiles	A2DP, AVRCP, HSP, HFP
Supported codec	SBC, aptX®
Operating distance	up to 10 m (33 ft.)

■ Speaker section

Driver units	Φ 40 mm (1 - 9/16 in.)
Impedance	32 Ω

■ Terminal section

DC IN	DC 5 V, 500 mA
Audio input	Stereo jack Φ 3.5 mm (1/8 in.)

■ Microphone section

Type	Mono
-------------	------

■ Accessories section

USB charging cord	1.0 m (3.3 ft.)
Detachable cord	1.5 m (4.9 ft.)

- Specifications are subject to change without notice.

Copyright, etc.

- aptX® software is copyright CSR plc or its group companies. All rights reserved. The aptX® mark and the aptX logo are trademarks of CSR plc or one of its group companies and may be registered in one or more jurisdictions.
- The Bluetooth® word mark and logos are owned by the Bluetooth SIG, Inc. and any use of such marks by Panasonic Corporation is under license. Other trademarks and trade names are those of their respective owners.
- Other system names and product names appearing in this document are in general the registered trademarks or trademarks of the respective developer companies. Note that the ™ mark and ® mark do not appear in this document.

ENGLISH

The serial number of this product can be found on the speaker. Remove the right earpad to see it. Please note them in the space provided below and keep for future reference.
 MODEL NUMBER **RP-BTD10**
 SERIAL NUMBER _____

User memo:

DATE OF PURCHASE _____
 DEALER NAME _____
 DEALER ADDRESS _____
 TELEPHONE NUMBER _____

-If you see this symbol-

Information on Disposal in other Countries outside the European Union
 This symbol is only valid in the European Union. If you wish to discard this product, please contact your local authorities or dealer and ask for the correct method of disposal.

VQT5J78

9

9

Limited Warranty (ONLY FOR U.S.A. AND PUERTO RICO)

Panasonic Products Limited Warranty

Limited Warranty Coverage (For USA and Puerto Rico Only)

If your product does not work properly because of a defect in materials or workmanship, Panasonic Corporation of North America (referred to as "the warrantor") will, for the length of the period indicated on the chart below, which starts with the date of original purchase ("warranty period"), at its option either (a) repair your product with new or refurbished parts, (b) replace it with a new or a refurbished equivalent value product, or (c) refund your purchase price. The decision to repair, replace or refund will be made by the warrantor.

Product or Part Name	Parts	Labor
Accessories	90 Days	Not Applicable
Batteries (Non-rechargeable batteries are not warranted.)	10 Days	Not Applicable

During the "Labor" warranty period there will be no charge for labor. During the "Parts" warranty period, there will be no charge for parts. This Limited Warranty excludes both parts and labor for non-rechargeable batteries, antennas, and cosmetic parts (cabinet). This warranty only applies to products purchased and serviced in the United States or Puerto Rico. This warranty is extended only to the original purchaser of a new product which was not sold "as is".

Mail-In Service--Online Repair Request

Online Repair Request

To submit a new repair request and for quick repair status visit our Web Site at www.panasonic.com/repair.

When shipping the unit, carefully pack, include all supplied accessories listed in the Owner's Manual, and send it prepaid, adequately insured and packed well in a carton box. When shipping Lithium Ion batteries please visit our Web Site at www.panasonic.com/BatteryHandling as Panasonic is committed to providing the most up to date information. Include a letter detailing the complaint, a return address and provide a daytime phone number where you can be reached. A valid registered receipt is required under the Limited Warranty.

IF REPAIR IS NEEDED DURING THE WARRANTY PERIOD, THE PURCHASER WILL BE REQUIRED TO FURNISH A SALES RECEIPT/PROOF OF PURCHASE INDICATING DATE OF PURCHASE, AMOUNT PAID AND PLACE OF PURCHASE. CUSTOMER WILL BE CHARGED FOR THE REPAIR OF ANY UNIT RECEIVED WITHOUT SUCH PROOF OF PURCHASE.

Limited Warranty Limits And Exclusions

This warranty ONLY COVERS failures due to defects in materials or workmanship, and DOES NOT COVER normal wear and tear or cosmetic damage. The warranty ALSO DOES NOT COVER damages which occurred in shipment, or failures which are caused by products not supplied by the warrantor, or failures which result from accidents, misuse, abuse, neglect, mishandling, misapplication, alteration, faulty installation, set-up adjustments, misadjustment of consumer controls, improper maintenance, power line surge, lightning damage, modification, introduction of sand, humidity or liquids, commercial use such as hotel, office, restaurant, or other business or rental use of the product, or service by anyone other than a Factory Service Center or other Authorized Servicer, or damage that is attributable to acts of God.

THERE ARE NO EXPRESS WARRANTIES EXCEPT AS LISTED UNDER "LIMITED WARRANTY COVERAGE".

THE WARRANTOR IS NOT LIABLE FOR INCIDENTAL OR CONSEQUENTIAL DAMAGES RESULTING FROM THE USE OF THIS PRODUCT, OR ARISING OUT OF ANY BREACH OF THIS WARRANTY.

(As examples, this excludes damages for lost time, travel to and from the servicer, loss of or damage to media or images, data or other memory or recorded content. The items listed are not exclusive, but for illustration only.)

ALL EXPRESS AND IMPLIED WARRANTIES, INCLUDING THE WARRANTY OF MERCHANTABILITY, ARE LIMITED TO THE PERIOD OF THE LIMITED WARRANTY.

Some states do not allow the exclusion or limitation of incidental or consequential damages, or limitations on how long an implied warranty lasts, so the exclusions may not apply to you.

This warranty gives you specific legal rights and you may also have other rights which vary from state to state. If a problem with this product develops during or after the warranty period, you may contact your dealer or Service Center. If the problem is not handled to your satisfaction, then write to the warrantor's Consumer Affairs Department at the addresses listed for the warrantor.

PARTS AND SERVICE, WHICH ARE NOT COVERED BY THIS LIMITED WARRANTY, ARE YOUR RESPONSIBILITY.

Customer Services Directory (United States and Puerto Rico)

Obtain Product Information and Operating Assistance; locate your nearest Dealer or Service Center; purchase Parts and Accessories; or make Customer Service and Literature requests by visiting our Web Site at: <http://www.panasonic.com/support> or, contact us via the web at: <http://www.panasonic.com/contactinfo>

For hearing or speech impaired TTY users, TTY: 1-877-833-8855

Accessory Purchases (United States and Puerto Rico)

Purchase Parts, Accessories and Owner's Manual online for all Panasonic Products by visiting our Web Site at: <http://www.pstc.panasonic.com>
Or, send your request by E-mail to: npcparts@us.panasonic.com
You may also contact us directly at: 1-800-237-9080 (Fax Only)
(Monday-Friday 9am-9pm EST)

Panasonic National Parts Center
20421 84th Avenue South, Kent, WA 98032
(We accept Visa, MasterCard, Discover Card, American Express)

For hearing or speech impaired TTY users, TTY: 1-866-605-1277

As of November 2013

Limited Warranty (ONLY FOR CANADA)

Panasonic Canada Inc.
5770 Ambler Drive, Mississauga, Ontario L4W 2T3

PANASONIC PRODUCT – LIMITED WARRANTY EXCHANGE PROGRAM

Panasonic Canada Inc. warrants this product to be free from defects in material and workmanship under normal use and for a period as stated below from the date of original purchase agrees to, at its option either (a) repair your product with new or refurbished parts, (b) replace it with a new or a refurbished equivalent value product, or (c) refund your purchase price. The decision to repair, replace or refund will be made by Panasonic Canada Inc.

Accessories including rechargeable batteries

Ninety (90) days

This warranty is given only to the original purchaser, or the person for whom it was purchased as a gift, of a Panasonic brand product mentioned above sold by an authorized Panasonic dealer in Canada and purchased and used in Canada, which product was not sold "as is", and which product was delivered to you in new condition in the original packaging.

IN ORDER TO BE ELIGIBLE TO RECEIVE WARRANTY SERVICE HEREUNDER, A PURCHASE RECEIPT OR OTHER PROOF OF DATE OF ORIGINAL PURCHASE, SHOWING AMOUNT PAID AND PLACE OF PURCHASE IS REQUIRED

LIMITATIONS AND EXCLUSIONS

This warranty ONLY COVERS failures due to defects in materials or workmanship, and DOES NOT COVER normal wear and tear or cosmetic damage. The warranty ALSO DOES NOT COVER damages which occurred in shipment, or failures which are caused by products not supplied by Panasonic Canada Inc., or failures which result from accidents, misuse, abuse, neglect, mishandling, misapplication, alteration, faulty installation, set-up adjustments, misadjustment of consumer controls, improper maintenance, power line surge, lightning damage, modification, introduction of sand, humidity or liquids, commercial use such as hotel, office, restaurant, or other business or rental use of the product, or service by anyone other than a Authorized Servicer, or damage that is attributable to acts of God.

Dry cell batteries are also excluded from coverage under this warranty.

THIS EXPRESS, LIMITED WARRANTY IS IN LIEU OF ALL OTHER WARRANTIES, EXPRESS OR IMPLIED, INCLUDING ANY IMPLIED WARRANTIES OF MERCHANTABILITY AND FITNESS FOR A PARTICULAR PURPOSE. IN NO EVENT WILL PANASONIC CANADA INC. BE LIABLE FOR ANY SPECIAL, INDIRECT OR CONSEQUENTIAL DAMAGES RESULTING FROM THE USE OF THIS PRODUCT OR ARISING OUT OF ANY BREACH OF ANY EXPRESS OR IMPLIED WARRANTY. (As examples, this warranty excludes damages for lost time, travel to and from the Authorized Servicer, loss of or damage to media or images, data or other memory or recorded content. This list of items is not exhaustive, but for illustration only.)

In certain instances, some jurisdictions do not allow the exclusion or limitation of incidental or consequential damages, or the exclusion of implied warranties, so the above limitations and exclusions may not be applicable. This warranty gives you specific legal rights and you may have other rights which vary depending on your province or territory.

CONTACT INFORMATION

For product operation and information assistance, please visit our Support page:
www.panasonic.ca/english/support

For defective product exchange within the warranty period, please contact the original dealer.

ENGLISH

ENGLISH

To remove the battery when disposing of this unit

The following instructions are not intended for repairing purposes but for the disposal of this unit. This unit is not restorable once disassembled. When disposing of this unit, take out the battery installed in this unit and recycle it.

- Disassemble after the battery runs out.
- Keep disassembled parts out of reach of children.

1 Take off the earpad **A** from the right speaker and remove the 3 screws

- Use a cross-slot screwdriver (commercially available).

2 Remove the front cover **B**

3 Lifting the 2 latches **D**, rotate the back cover **C** in the counterclockwise direction

4 Remove the 4 screws and remove the housing **E**

5 Hold both sides of the battery away from the terminals **F**, and remove it

Regarding the handling of used batteries

- Insulate the terminals with adhesive tape or similar.
- Do not disassemble.

■ Batteries

- Do not heat or expose to flame.
- Do not leave the battery(ies) in a car exposed to direct sunlight for a long period of time with doors and windows closed.
- Battery mishandling can cause electrolyte leakage which can damage items the leaked fluid comes into contact with. If electrolyte leaks from the battery, consult your dealer. Wash thoroughly with water if electrolyte comes in contact with any part of your body.
- When disposing of the battery, please contact your local authorities or dealer and ask for the correct method of disposal.



A lithium ion battery that is recyclable powers the product you have purchased. Please call 1-800-8-BATTERY for information on how to recycle this battery.

VQT5J78

FRANÇAIS

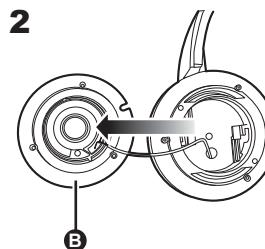
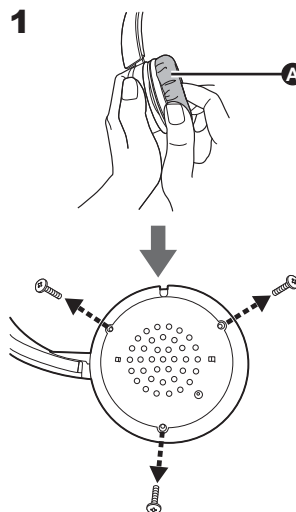

2

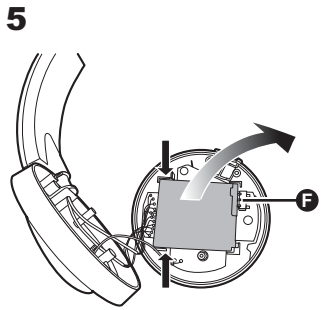
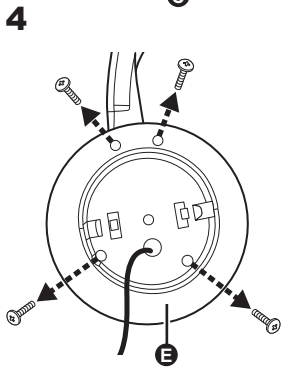
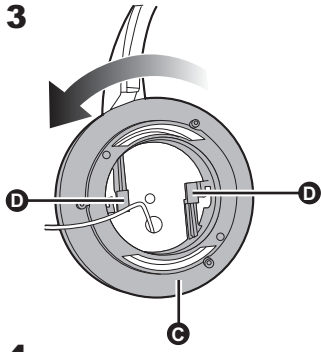

ESPAÑOL

PORTUGUÊS

ENGLISH
FRANÇAIS
ESPAÑOL
PORTUGUÊS

Panasonic Corporation of North America
Two Riverfront Plaza, Newark, NJ 07102-5490
<http://www.panasonic.com>

Panasonic Canada Inc.
5770 Ambler Drive, Mississauga, Ontario L4W 2T3
www.panasonic.com

© Panasonic Corporation 2014
Printed in China/Imprimé en Chine/Impreso en China/Impresso na China

(En) (Cf) (Sp) (Pr)

VQT5J78
M0214KZ0

