

Panasonic[®]

Multi Format Digital HD Video Cassette Recorder Operating Instructions (Hardware)

Model No. **AJ-HD3700B**_{PE}

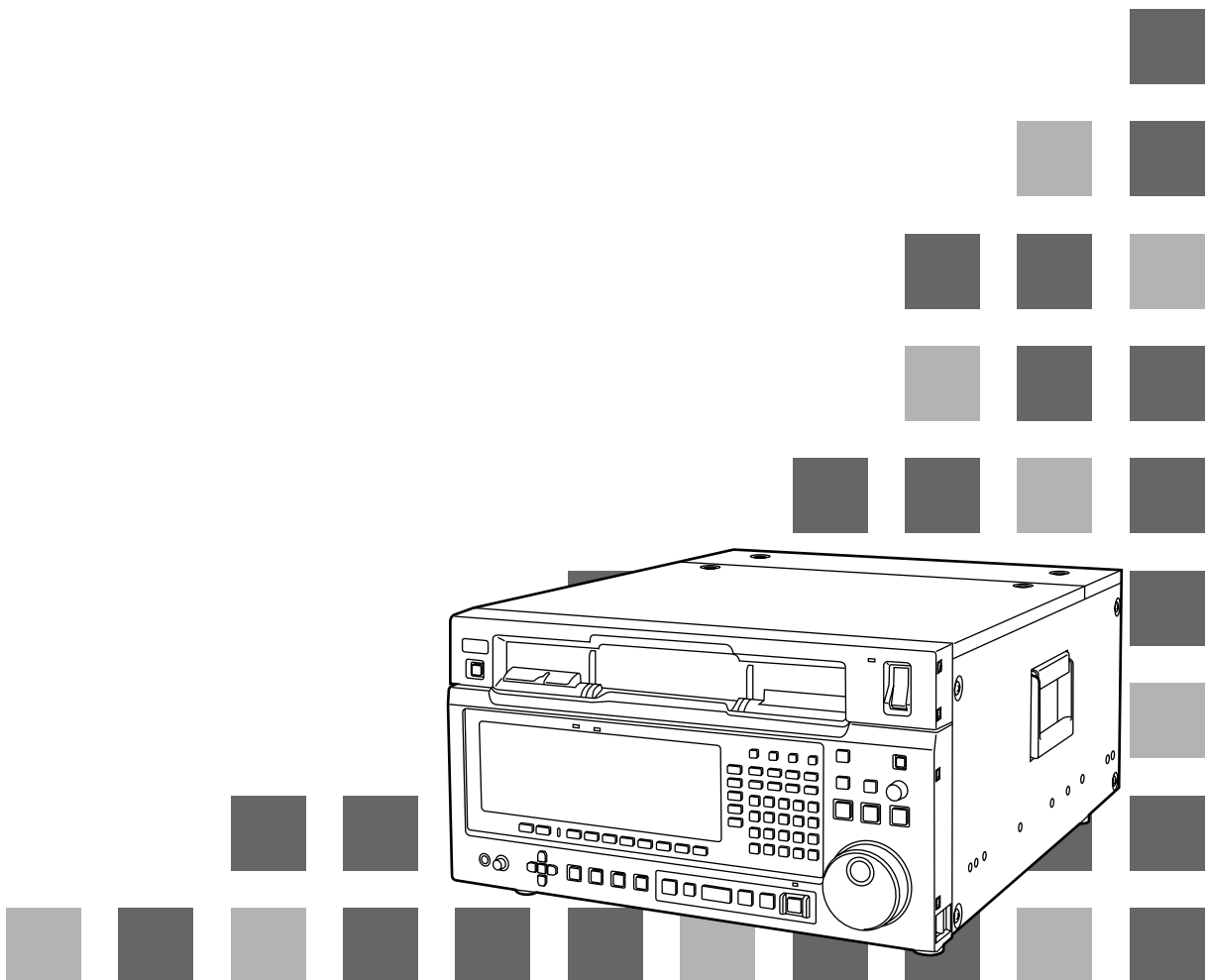

Before operating this product, please read the instructions carefully and save this manual for future use.

For your safety (General)

Since this VTR is designed for metal tapes only, make sure that only the designated tapes are used. An ordinary VHS tape cannot be used. Removal of the covers on electrical appliances for maintenance purposes may lead to electric shocks.

Personnel should therefore adhere strictly to the normal safety precautions.

Some customer-preference switches are located on printed circuit boards within the unit. Be sure to turn off the power prior to opening the unit, before changing the position of any switch, and especially before removing or reinserting any circuit board.

WARNING:

- **TO REDUCE THE RISK OF FIRE OR SHOCK HAZARD, DO NOT EXPOSE THIS EQUIPMENT TO RAIN OR MOISTURE.**
- **TO REDUCE THE RISK OF FIRE OR SHOCK HAZARD, KEEP THIS EQUIPMENT AWAY FROM ALL LIQUIDS-USE AND STORE ONLY IN LOCATIONS WHICH ARE NOT EXPOSED TO THE RISK OF DROPPING OR SPLASHING LIQUIDS, AND DO NOT PLACE ANY LIQUID CONTAINERS ON TOP OF THE EQUIPMENT.**

CAUTION:

Do not install or place this unit in a bookcase, built-in cabinet or in another confined space in order to keep well ventilation condition. Ensure that curtains and any other materials do not obstruct the ventilation condition to prevent risk of electric shock or fire hazard due to overheating.

CAUTION:

THE AC OUTLET (MAINS SOCKET) SHALL BE INSTALLED NEAR THE EQUIPMENT AND SHALL BE EASILY ACCESSIBLE.

THIS APPARATUS MUST BE GROUNDED

To ensure safe operation the three-pin plug must be inserted only into a standard three-pin power outlet (socket) which is effectively grounded through normal household wiring. Extension cords used with the equipment must be three-core and be correctly wired to provide connection to the ground. Incorrectly wired extension cords can be extremely hazardous. The fact that the equipment operates satisfactorily does not imply that it is grounded, and the installation is not necessarily safe. For your safety, if in any doubt about the effective grounding of the equipment or power outlet (socket), please consult a qualified electrician.

CAUTION:

TO REDUCE THE RISK OF FIRE OR SHOCK HAZARD AND ANNOYING INTERFERENCE, USE THE RECOMMENDED ACCESSORIES ONLY.

CAUTION:

TO REDUCE THE RISK OF FIRE OR SHOCK HAZARD, REFER MOUNTING OF THE OPTIONAL BOARD AND CHANGE OF THE SWITCH SETTING INSIDE THE UNIT TO AUTHORIZED SERVICE PERSONNEL.

CAUTION:

EVEN WHEN THE POWER SWITCH IS IN THE OFF POSITION, A SMALL CURRENT FLOWS THE FILTER CIRCUIT.

 is the safety information.

Operating precaution

Operation near any appliance which generates strong magnetic fields may give rise to noise in the video and audio signals. If this should be the case, deal with the situation by, for instance, moving the source of the magnetic fields away from the unit before operation.

For your safety

For USA and Canada

 <p>CAUTION RISK OF ELECTRIC SHOCK DO NOT OPEN</p> <p>CAUTION: TO REDUCE THE RISK OF ELECTRIC SHOCK, DO NOT REMOVE COVER (OR BACK). NO USER-SERVICEABLE PARTS INSIDE. REFER SERVICING TO QUALIFIED SERVICE PERSONNEL.</p>	<p>FCC NOTE: This device complies with Part 15 of the FCC Rules. To assure continued compliance follow the attached installation instructions and do not make any unauthorized modifications.</p> <p>This equipment has been tested and found to comply with the limits for a Class A digital device, pursuant to Part 15 of the FCC Rules. These limits are designed to provide reasonable protection against harmful interference when the equipment is operated in a commercial environment. This equipment generates, uses, and can radiate radio frequency energy and, if not installed and used in accordance with the instruction manual, may cause harmful interference to radio communications. Operation of this equipment in a residential area is likely to cause harmful interference in which case the user will be required to correct the interference at his own expense.</p>
---	---



The lightning flash with arrowhead symbol, within an equilateral triangle, is intended to alert the user to the presence of uninsulated “dangerous voltage” within the product’s enclosure that may be of sufficient magnitude to constitute a risk of electric shock to persons.



The exclamation point within an equilateral triangle is intended to alert the user to the presence of important operating and maintenance (servicing) instructions in the literature accompanying the appliance.

For Europe

<p>CAUTION: DO NOT REMOVE PANEL COVER BY UNSCREWING</p> <p>To reduce the risk of electric shock, do not remove cover. No user serviceable parts inside. And do not insert fingers or any other objects into the video cassette holder.</p>
--

 is the safety information.

Caution for AC Mains Lead

FOR YOUR SAFETY PLEASE READ THE FOLLOWING TEXT CAREFULLY.

This product is equipped with 2 types of AC mains cable. One is for continental Europe, etc. and the other one is only for U.K.

Appropriate mains cable must be used in each local area, since the other type of mains cable is not suitable.

FOR CONTINENTAL EUROPE, ETC.

Not to be used in the U.K.

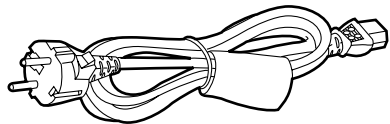

FOR U.K. ONLY

If the plug supplied is not suitable for your socket outlet, it should be cut off and appropriate one fitted.

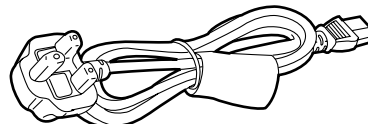

FOR U.K. ONLY

This appliance is supplied with a moulded three pin mains plug for your safety and convenience.

A 13 amp fuse is fitted in this plug.

Should the fuse need to be replaced please ensure that the replacement fuse has a rating of 13 amps and that it is approved by ASTA or BSI to BS1362.

Check for the ASTA mark  or the BSI mark  on the body of the fuse.

If the plug contains a removable fuse cover you must ensure that it is refitted when the fuse is replaced.

If you lose the fuse cover the plug must not be used until a replacement cover is obtained.

A replacement fuse cover can be purchased from your local Panasonic Dealer.

IF THE FITTED MOULDED PLUG IS UNSUITABLE FOR THE SOCKET OUTLET IN YOUR HOME THEN THE FUSE SHOULD BE REMOVED AND THE PLUG CUT OFF AND DISPOSED OF SAFELY. THERE IS A DANGER OF SEVERE ELECTRICAL SHOCK IF THE CUT OFF PLUG IS INSERTED INTO ANY 13 AMP SOCKET.

If a new plug is to be fitted please observe the wiring code as shown below.

If in any doubt please consult a qualified electrician.

WARNING: THIS APPLIANCE MUST BE EARTHED.

IMPORTANT: The wires in this mains lead are coloured in accordance with the following code:

Green-and-Yellow:	Earth
Blue:	Neutral
Brown:	Live

As the colours of the wires in the mains lead of this appliance may not correspond with the coloured markings identifying the terminals in your plug, proceed as follows:

- The wire which is coloured GREEN-AND-YELLOW must be connected to the terminal in the plug which is marked with the letter E or by the Earth symbol  or coloured GREEN or GREEN-AND-YELLOW.
- The wire which is coloured BLUE must be connected to the terminal in the plug which is marked with the letter N or coloured BLACK.
- The wire which is coloured BROWN must be connected to the terminal in the plug which is marked with the letter L or coloured RED.

How to replace the fuse

1. Open the fuse compartment with a screwdriver.

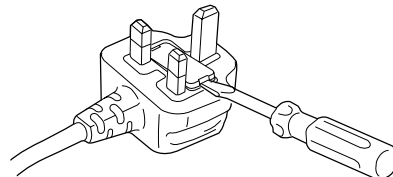

2. Replace the fuse.

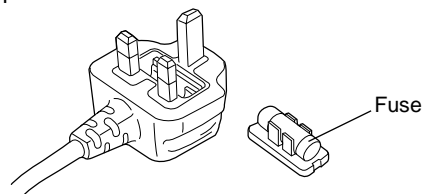

Contents

For your safety	2
Features	6
Controls and their functions	
●Front Panel	8
●Connector section	14
Connections	
●Connections for a single unit	18
●Connections for 2 units	19
●Connection with an editing controller	20
Tapes	21
Recording	22
Playback	28
Basic operations	29
Manual Editing	35
Manual audio cross editing	37
Automatic insert/assemble editing	38
Audio split editing	40
Variable memory Function	42
Connector signals	44
Video head cleaning	49
Rack-mounting	50
Troubleshooting	51
Dip switch	52
Specifications	53

Features

This HD VTR is a hi-vision digital VTR for recording and playing back the video and audio signals complying with BTAS-001A (1125/60 high-definition TV system studio standard) and SMPTE 274M standards.

By image-compressing the hi-vision signals and digitally recording them, this unit delivers up to 124 minutes of recording and playback using a 1/2" cassette (the maximum length with the 1080/23.98p format is 155 minutes.). It is possible to switch between the following system formats to record and play back the signals in one of these formats: 1080/23.98p (8-channel audio), 1080/24p (8-channel audio), 1080/25p (8-channel audio), 1080/59.94i (4-channel audio version), 1080/59.94i (8-channel audio version), 1080/50i (8-channel audio), 720/59.94p (4-channel audio version), 720/59.94p (8-channel audio version), 576/50i (8-channel audio), 480/59.94i (4-channel audio version) and 480/59.94i (8-channel audio version).

Only playback is possible with 576/50i (4 audio channels) format tapes which have been recorded using the VTR (AJ-D580).

Simultaneous output of HD (hi-vision signals) and SD (standard signals) can be achieved.

In the case of the 1080/23.98p, 1080/24p and 1080/25p formats, the 1080/23.98psf, 1080/24psf and 1080/25psf (Progressive Segmented Frame) formats which divide the frames into two segments every 1/47.96, 1/48 and 1/50 of a second, respectively, for interfacing are also used.

Picture/sound quality at a reasonable price

●High picture quality digital recording of signals complying with studio standard

The hi-vision studio standard signals, which have been 10-bit quantized using sampling frequencies of 74.25 MHz for Y signals and 37.125 MHz for the P_B and P_R signals, are image-compressed and digitally recorded to meet the full range of specifications under the hi-vision studio standard.

Virtually distortion-free recording and playback at a low compression rate—and with a signal-to-noise ratio of 60 dB and a wide band (Y: 30 MHz, P_B/P_R: 15 MHz), which have to date proved difficult to achieve with analog VTRs using 1/2-inch tapes—are now made possible by utilizing a high recording rate of around 300 Mbps: the result is a consistently high picture quality all the way through from the initial recording to editing.

●Compact size, light weight and low power consumption

The unit is compact (height equivalent to 5U, depth at 20 1/2"), lightweight (69.96 lbs), low in power consumption (260 W) and easy to handle.

●High cost performance

In addition to featuring the basic functions and performance of HDD5, this HDVTR makes it possible to switch between the 1080/23.98p (8-channel audio), 1080/24p (8-channel audio), 1080/25p (8-channel audio), 1080/59.94i (4-channel audio version), 1080/59.94i (8-channel audio version), 1080/50i (8-channel audio), 720/59.94p (4-channel audio version), 720/59.94p (8-channel audio version), 576/50i (8-channel audio), 480/59.94i (4-channel audio version) and 480/59.94i (8-channel audio version) system formats to record and play back the signals in one of these formats. Furthermore, installation of a format converter board enables HS and SD signals to be output simultaneously.

●Digital audio with high sound quality

A high sound quality with a dynamic range of 100 dB is delivered by 20 (24)-bit 48 kHz sampling. Not only can recording, playback and editing be conducted separately for each of the 4 (8) channels but channel mixing is also possible. Moreover, one channel is provided for the analog (cue) track. (At 1080/23.98p, 1080/24p, 1080/25p, 1080/50i and 576/50i formats, 8-channel audio and 24 bit format.)

With the 1080/59.94i, 480/59.94i, or 720/59.94p system format, either the 4-channel 20-bit format or the 8-channel 24-bit format can be selected. However, due caution should be exercised in operation since the recording format used for the 8-channel audio version and the one used for the 4-channel audio version differ, and these differences pertain to their video recording areas as well. As such, these two system formats are not mutually compatible.

●Compact 1/2" tape cassette

Two sizes of cassette, [L: 124 minutes (1080/59.94i, 720/59.94p and 480i), 149 minutes (1080/50i, 1080/25p), 155 minutes (1080/23.98p and 1080/24p), 112 minutes (576/50i) and M: 63 minutes (1080/59.94i, 720/59.94p and 480/59.94i), can be used with this unit: this enables the size best suited to the intended application to be selected. The compact 1/2" cassette takes up minimal storage space and offers excellent handling ease.

Features

I/O specifications and interfaces

●Serial digital I/O facilities

The unit is equipped with hi-vision serial digital interfaces which meet the BTAS-004A, S-005A and S-006A standards and which enable both video and audio signals to be transferred using the same coaxial cable. An SD (525/625-line standard TV) serial digital interface is provided for operation with HD/SD mixing.

●Format converter function

A format converter board has already been equipped in the unit as a standard accessory. This facilitates conversion between HD and SD, and it makes the integrated production of Hi-Vision and standard TV broadcast much simpler.

In addition to the composite analog signals, a serial digital interface (SDI signals) which can switch the multiplex transfer of audio signals ON or OFF is included in the SD output signals. SDI signals enable digital connection to a DVCPRO/D5VTR.

●AES audio input/output facilities

Separate digital audio inputs and outputs are provided for each of the 4 (8) channels, and standard interfacing with a variety of digital audio units is possible. (8 channels with 1080/23.98p, 1080/24p, 1080/25p, 1080/50i and 576/50i formats. 4 channels/8 channels with 1080/59.94i, 720/59.94p and 480/59.94i formats.)

●Remote control

In addition to the standard 9-pin serial (RS-422A) connector, 50P parallel and RS-232C connectors are provided on the unit for remote control. An AV control connector is also featured.

Slow motion, search and editing functions

●Slow motion/jog

The incorporation of Panasonic's unique AT (auto tracking) mechanism makes slow-motion playback and jogging possible at a speed which can be varied from $-1\times$ to $+2\times$ normal tape speed.

●50× shuttle search

Shuttle search is possible at up to 50× normal tape speed in the forward or reverse direction.

●Simultaneous playback monitoring

Simultaneous playback monitoring of video, digital audio, time code and CTL signals is possible.

●Automatic editing functions

A full range of editing modes are provided including assemble, insert, audio split and variable memory.

●Multi cue points

One hundred cue points can be marked for searches and prerolling.

Operation and maintenance

●Channel condition monitoring

The error rate is monitored at all times. When the setting is exceeded, an indicator on the front panel lights to warn the operator that the tape is approaching the end of its service life or that the heads are clogged.

●Built-in test signal generator

Color bar signals and other test signals, which come in handy for conducting maintenance and adjustments and for checking the connections, are generated internally.

Controls and their functions

Front panel

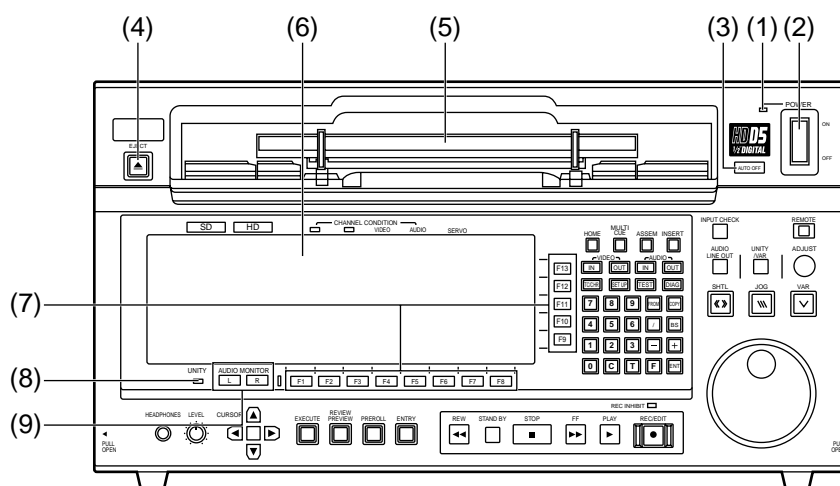

- (1) **POWER lamp** This lights when the power is turned on.
- (2) **POWER switch** When the ON side is pressed, the power is turned on; when the OFF side is pressed, the power is turned off.
- (3) **AUTO OFF Lamp** This lights when trouble has occurred in the unit and operation cannot be continued without taking any remedial action.
- (4) **EJECT button** When this button pressed, the cassette tape is ejected.
- (5) **Cassette holder** This is the slot where the 1/2-inch metal cassette tape is loaded.
- (6) **Display panel** The different kinds of data are displayed on this large 640-dot by 200-line display panel.
- (7) **Function keys** Menu function keys F1 to F13 are provided.
- (8) **UNITY lamp** This lights when all the digital audio output signals are in the UNITY state or when the audio input/output and the video output are in the UNITY state.
- (9) **AUDIO MONITOR L/R selector buttons**
 - These buttons switch the output of the audio monitor connector and headphone jack.
 - They are used to select which of the 5 (9) channel [4 (8) digital audio signal channels and 1 cue audio signal channel] signals is to be output to L/R.
 - Each time the L (or R) button is pressed, the selected output L (or R) signal changes in the sequence of CH1, CH2, CH3, CH4 (CH5, CH6, CH7, CH8)*, and CUE.
 - *When a 4-channel digital audio format is used, either no sound is output or the sound of channels 1 through 4 is copied as the sound and output for the channels in the parentheses.
 - The channel now selected can be monitored by observing the L and R indications on the display panel.
 - L and R displays are highlighted corresponding to the channels now selected on the display panel.
 - Default settings: CH1 for L and CH2 for R.

<Note>

1080/23.98p, 1080/24p, 1080/25p, 1080/50i and 576/50i formats are digital audio 8ch. Either the 4-channel or 8-channel digital audio signals are selected for the 1080/59.94i, 720/59.94p and 480/59.94i system formats.

Controls and their functions

Front panel

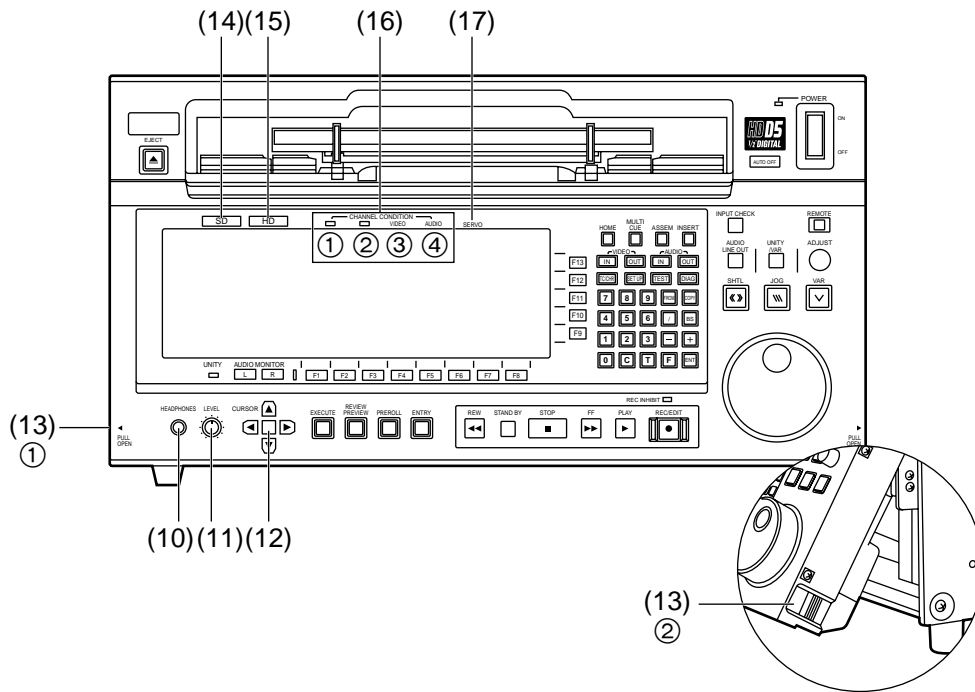

- (10) **Headphone jack** ●The stereo headphones are connected to this M6 headphone jack.
- (11) **Headphone VR** ●This volume control is used to adjust the headphones output level and monitoring output level.
The headphone output level and the monitoring output level are interlinked [when the F7 (A. MONI) key on the AUDIO OUT MONITOR menu is set to VAR].
- (12) **CURSOR** These keys move the cursor on the display. The center key displays the cursor.
- (13) **Panel opening buttons** ●The front panel can be opened and closed by pulling the buttons ① and ② at the front of the sides.
- (14) **SD lamp** This lamp lights when SD is selected as the recording format.
- (15) **HD lamp** This lamp lights when HD is selected as the recording format.
- (16) **Error display lamps (channel condition)** ●These lamps light in response to the number of errors.
 - ① Lights during normal operation (when the error value is minimal).
 - ② Lights when the number of inner errors has increased.
 - ③ Lights when the number of video outer errors has increased.
 - ④ Lights when the number of audio outer errors has increased.
- (17) **SERVO lamp** ●This lights when the servo is locked.

Controls and their functions

Front panel

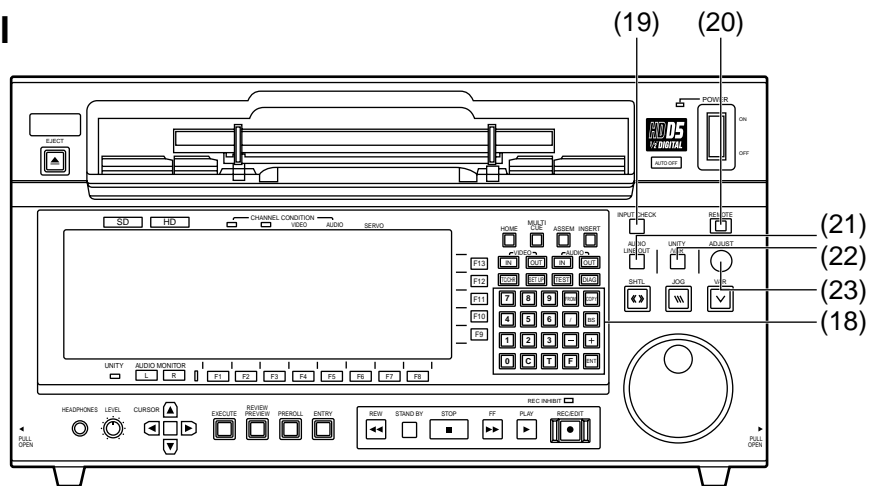

(18) Number keys (0 to 9)

● These are used to enter numbers.

- C
- ENT
- F
- BS
- - +
- FROM
- COPY
- T
- /

Clear key for clearing input data.
 For registering the data which have been entered.
 Used in combination with other keys.
 Backspace key
 Keys for adding and subtracting

(19) INPUT CHECK

While these keys are kept depressed, the input signals can be checked. It enables the video input signals to be checked at the SD SDI MONITOR OUT connector or HD SDI MONITOR OUT connector and the audio input signals to be checked at the MONITOR connector and headphone jack. When the F7 (TCG OUT) key has been set to MOMNT on the TC/CHR SET UP menu, the INPUT CHECK is established for the time code signals but only while the INPUT CHECK key is held down. When the INPUT CHECK key is pressed while the F7 key is set to LATCH, the INPUT CHECK mode is established, and the mode remains established even when the key is released. The mode is released when one of the tape modes is established.

(20) REMOTE button

- This is the switch for switching between operation from the front panel of the unit and operation from the remote control terminals (RS-422A, RS-232C) at the rear connector panel.
- When REMOTE (lamp lit) is selected, the recorder can be controlled via the remote control terminals at the rear connector panel.
- When LOCAL (lamp not lit) is selected, the recorder can be operated from the front panel.

(21) AUDIO LINE OUT

When the ADJUST control (23) is turned while this button is being pressed, the output of all audio channels can be changed at the same time (HOME, AUDIO OUT menus only).

(22) UNITY/VAR

This is used to switch between UNITY and VAR when the video output signals or audio level is to be adjusted.

(23) ADJUST control

This is used to adjust the levels.

Controls and their functions

Front panel

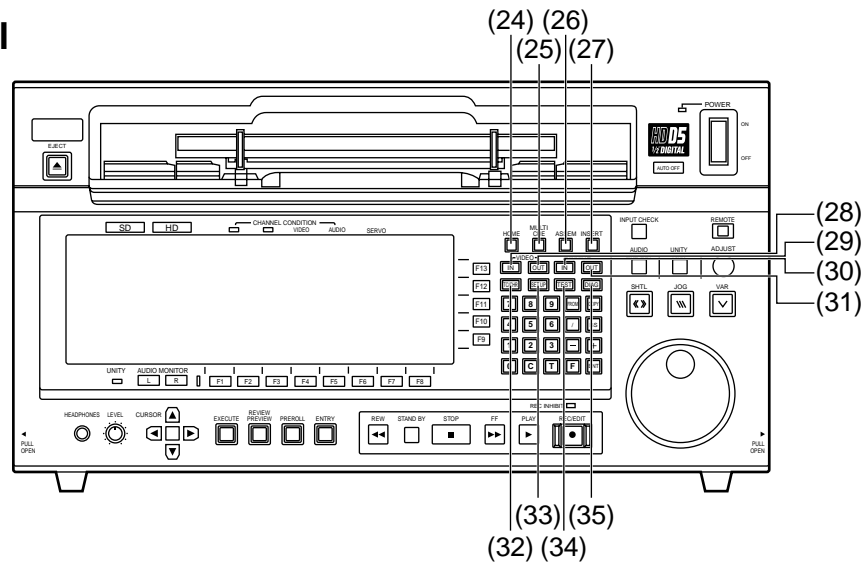

(24) HOME button

(25) MULTI CUE button

(26) ASSEM (ASSEMBLE) button

(27) INSERT button

(28) VIDEO IN

(29) VIDEO OUT

(30) AUDIO IN

(31) AUDIO OUT

(32) TC/CHR

(33) SET UP

(34) TEST

(35) DIAG

Controls and their functions

Front panel

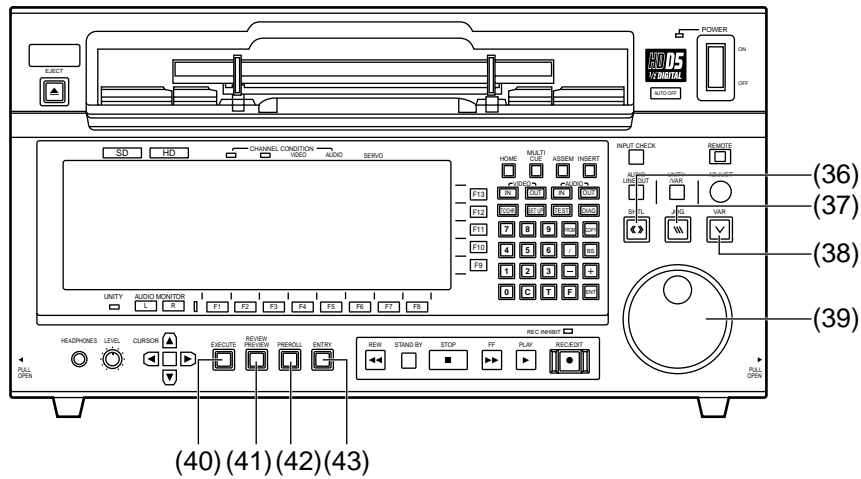

(36) SHTL button

(37) JOG button

(38) VAR button

(39) SEARCH dial

(40) EXECUTE button This executes the variable memory operation etc.

(41) REVIEW/PREVIEW button This previews what has been recorded before editing or reviews the recording after editing.

(42) PREROLL button (The tape is cued up when the F key and PREROLL keys are pressed.)

(43) ENTRY button

Controls and their functions

Front panel

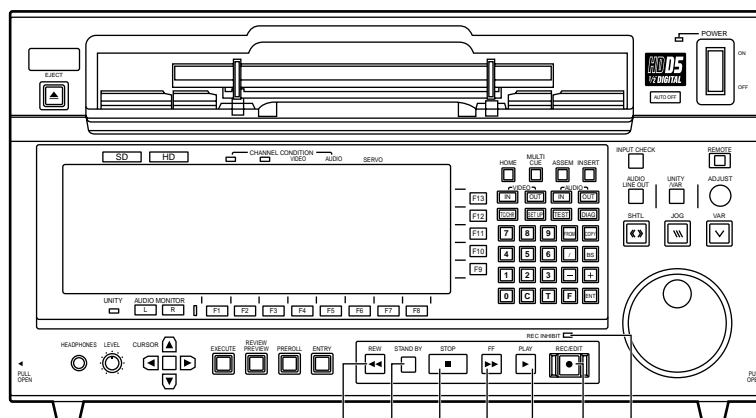

(44)(45)(46)(47)(48)(49)(50)

- (44) REW button
- (45) STAND BY button
- (46) STOP button
- (47) FF button
- (48) PLAY button
- (49) REC/EDIT button
- (50) REC INHIBIT lamp

Controls and their functions

Connector section

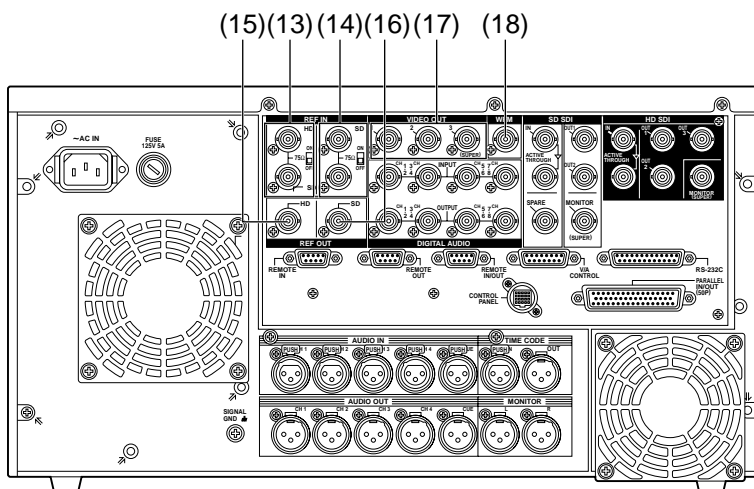

Analog input/output section

- | | |
|---|---|
| (13) HD REF IN connectors (BNC×2) | Input of tri-level sync signals as the HD reference signals. A loop-through/75 Ω termination switch is provided. |
| (14) SD REF IN connectors (BNC×2) | Input of black burst* ¹ signals as the SD reference signals. A loop-through/75 Ω termination switch is provided. |
| (15) HD REF OUT terminal (BNC×1) | Output of HD SYNC (tri-level SYNC). |
| (16) SD REF OUT terminal (BNC×1) | Output of black burst* ² . |
| (17) VIDEO OUT1, 2, 3 connectors (BNC×3) | Composite video signal output.
For OUT3, superimpose output is also possible. |
| (18) WFM (waveform) connector | Signals output to the waveform monitor. |

*¹When the normal black burst signal (59.94 Hz) is input as the SD REF signal with the 1080/24p system, asynchronization and a picture error will result.

*²This signal is not output with the 1080/24p system.

Controls and their functions

Connector section

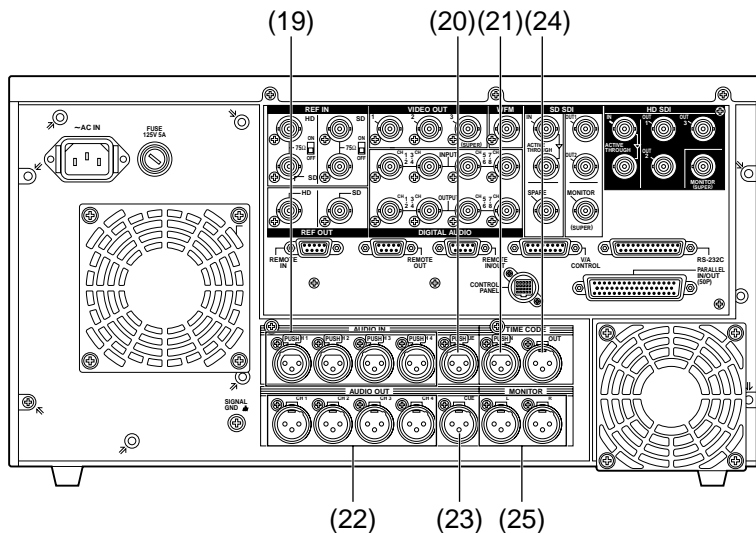

Analog input/output section

- (19) **AUDIO IN connectors (XLR 3P×4)** Analog audio signals input to digital audio CH1 to CH4.

- (20) **CUE IN connector (XLR 3P)** Audio signal input for the analog cue channel.

- (21) **TIME CODE IN connector (XLR 3P)** Time code signal input.

- (22) **AUDIO OUT connectors (XLR 3P×4)** Analog audio signal output from digital audio CH1 to CH4.

- (23) **CUE OUT connector (XLR 3P)** Audio signal output from the analog cue channel.

- (24) **TIME CODE OUT connector (XLR 3P)** Time code signal output.

- (25) **MONITOR OUT connectors (XLR 3P×2)** These are the audio monitor connectors. L, R audio output is made. Digital audio signals [CH1/CH2/CH3/CH4 (CH5/CH6/CH7/CH8)*] and cue audio can be selected.
 *The items in brackets are not operative with 1080/59.94i audio (4 channels), 720/59.94p audio (4 channels) or 480/59.94i audio (4 channels) format.

Controls and their functions

Connector section

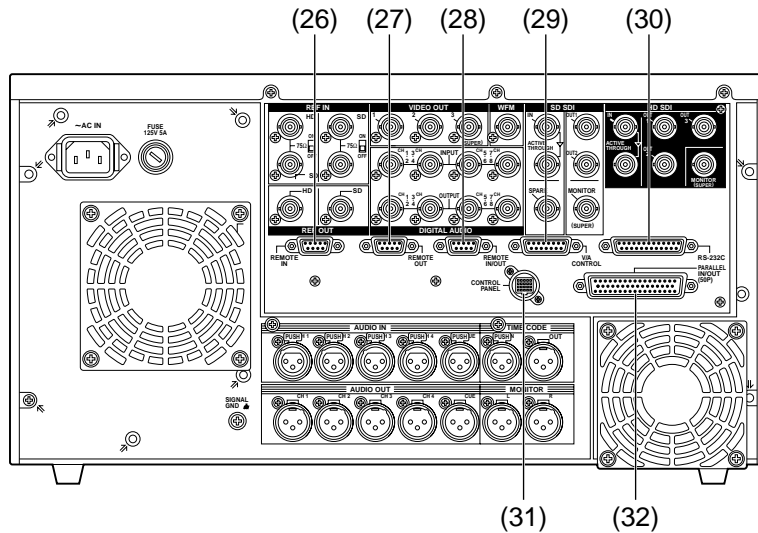

Remote control section

- (26) **REMOTE IN connector (RS-422A) (9P)** RS-422A serial mode input connector.
- (27) **REMOTE OUT connector (RS-422A) (9P)** RS-422A serial mode output connector.
- (28) **REMOTE IN/OUT connector (9P)** RS-422A serial mode I/O connector.
- (29) **V/A CONTROL terminal (15P)** Encoder remote (AJ-ER50) connector. (see Note)
- (30) **RS-232C connector (25P)** Data communication is possible by connection to a personal computer or a modem.
- (31) **CONTROL PANEL connector (20P)** For connection of the cable of a control panel.
The control panel connector enables the connectors on the front panel and connectors on the rear panel to be connected, and when these connectors are simultaneously connected, it is possible to switch between them using the menu.
- (32) **PARALLEL (IN/OUT) terminal (50P)** 50-pin parallel remote connector.
(Mainly for connection of equipment produced by the user.)

<Note>

The AJ-ER50 "Video input" and "VIDEO-PHASE" functions are not operational, as there is no correspondence with this recorder. Also, SYS-PHASE should be set at this recorder and not at the AJ-ER50.

Connections

Connection for a single unit

Press the REMOTE button on the front panel to turn the lamp (LOCAL) off.

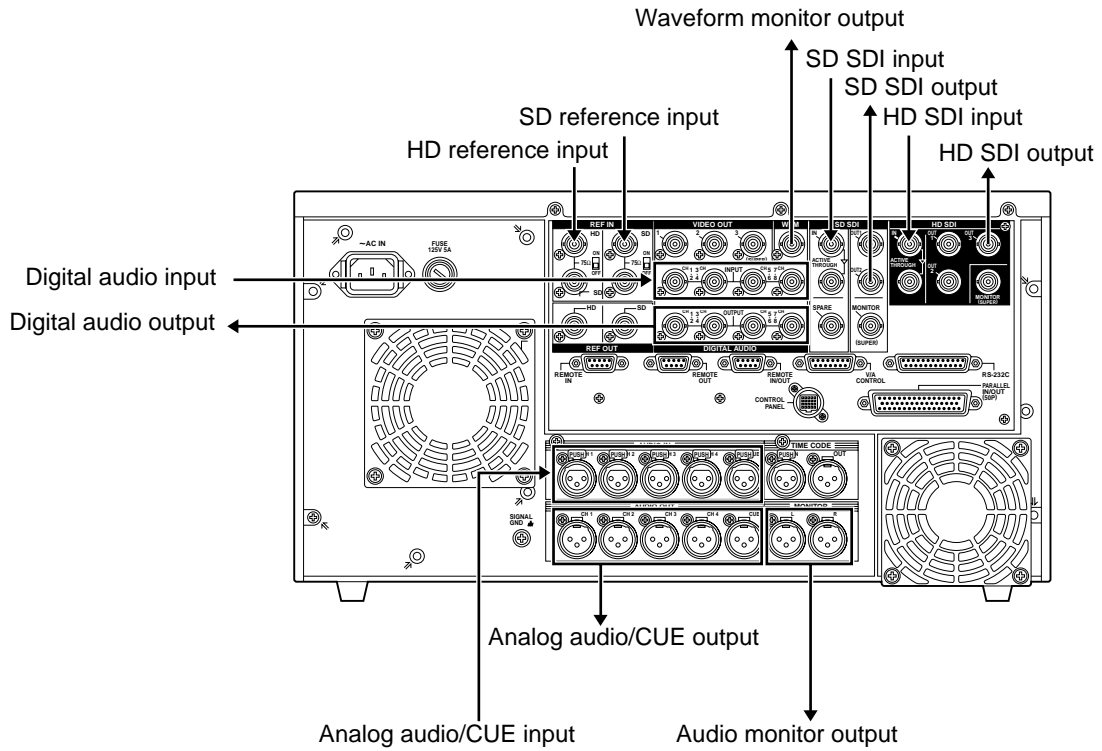

Connections

Connection for 2 units

- Source side** Press the REMOTE button at the front panel to light the lamp (REMOTE).
- Recorder side** Press the REMOTE button at the front panel to extinguish the lamp (LOCAL).
- When performing automatic editing with RS-422A, press the F1 (P-2) key at the SET UP INTERFACE menu to switch. (See figure below)

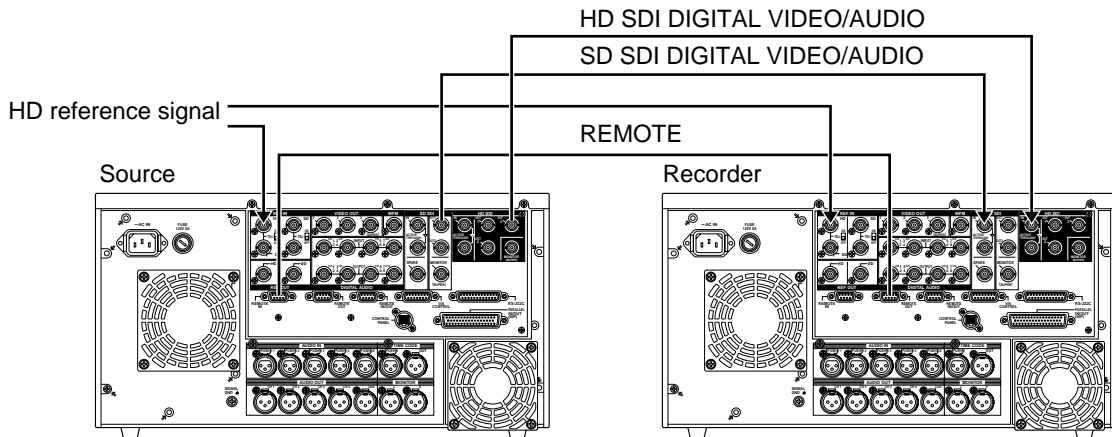
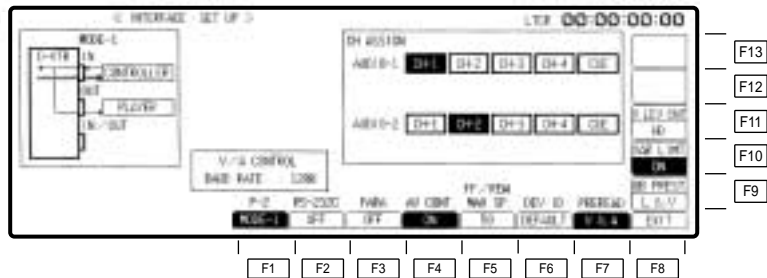

- When matching the CF (color frame) of SD output and time code output phase, also make SD reference matching. Then select SD REF as the OUT REF setting on the HOME SET UP menu.

Connections

Connection with an editing controller

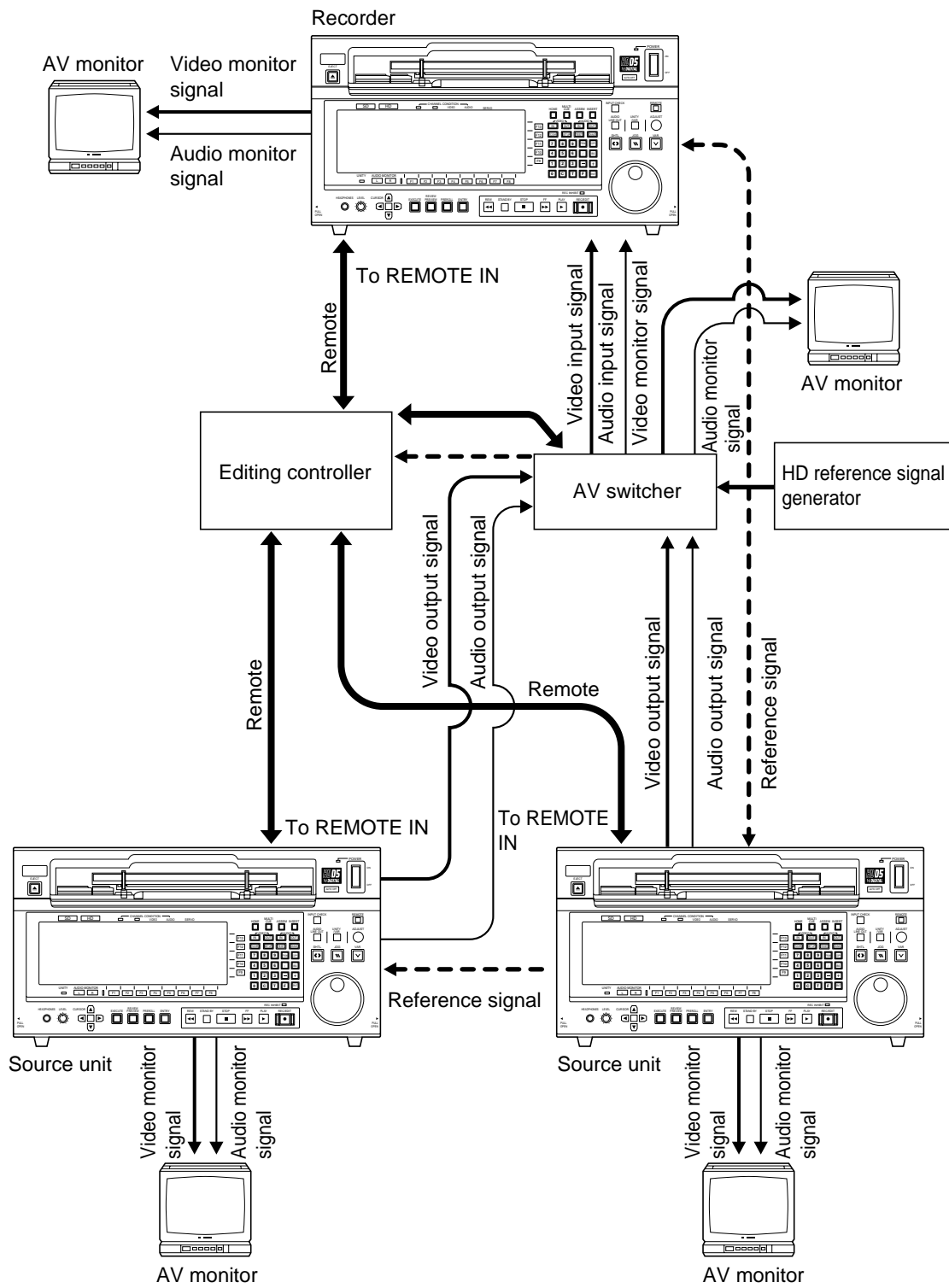

- Please use LTC: VITC+ as the time code setting on the controller side.
- When 720/59.94p mode has been set, input the SD_REF (BB) signal as the reference signal.

Tapes

There are two tape types: M and L.

M-cassettes: 57 minutes (576/50i), 63 minutes (1080/59.94i, 720/59.94p and 480/59i),
75 minutes (1080/25p and 1080/50i), 79 minutes (1080/23.98 and 1080/24p)

L-cassettes: 112 minutes (576/50i), 124 minutes (1080/59.94i, 720/59.94p and 480/59i),
149 minutes (1080/25p and 1080/50i), 155 minutes (1080/23.98p and 1080/24p)

Align the cassette with the marks on the unit's insertion slot and push it in gently.

The cassette tape will be loaded automatically.

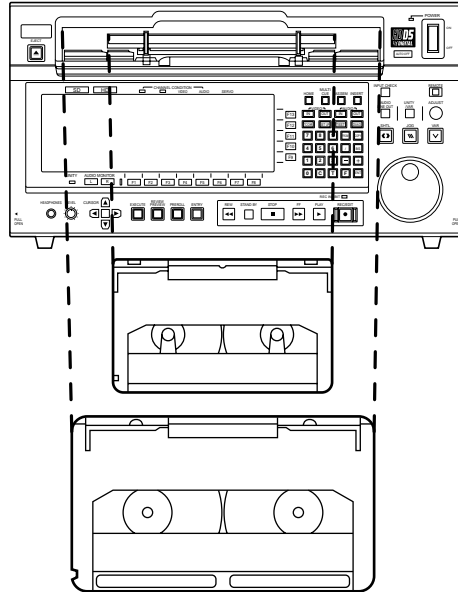

Prohibiting recording on a tape (when pins A and B are at the "up" position)

Use a screwdriver to push down the accidental erasure prevention pins, turn them 90° counterclockwise, and then lift the screwdriver to set the pins at their "up" positions.

The recording prohibition status is displayed on the MANUAL EDIT SET UP menu and the AUTO EDIT SET UP menu respectively.

<Note>

C bit pin: Raised position → 4-channel audio recording formats (1080/59.94i: 4-channel audio version, 720/59.94p: 4-channel audio version, 480/59.94i: 4-channel version, 576/50i: 4-channel version*)

Lowered position → 8-channel audio recording formats (1080/59.94i: 8-channel audio version, 720/59.94p: 4-channel audio version, 1080/23.98p, 1080/24p, 1080/25p, 1080/50i, 480/59.94i: 8-channel version, 576/50i: 8-channel version)

*The D5 VTR (AJ-D580) records in the 576/50i 4-channel format.

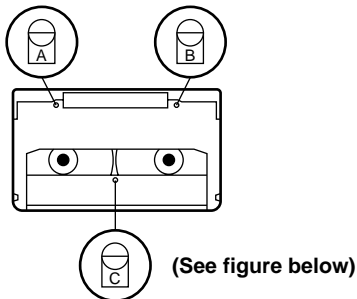

Enabling recording (when pins A and B are at the "down" position)

Use a screwdriver to push down the accidental erasure prevention pins, turn them 90° clockwise, and then lift the screwdriver to set the pins at their "down" positions.

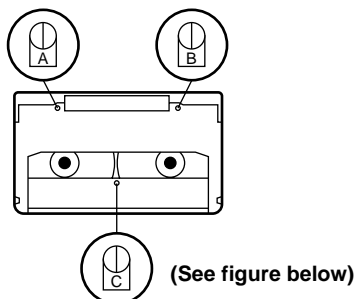

<Note> Important! Recording

VTR system format / Cassette C bit pin	4-channel recording mode	8-channel recording mode
Raised position (4-channel format)	Signals of 4 audio channels can be recorded.	Warning Recording inhibited (REC inhibit release menu item available)
Lowered position (8-channel format)	Warning Recording inhibited (REC inhibit release menu item available)	Signals of 8 audio channels can be recorded.

- Pin A:** For inhibiting the recording of any signals
- Pin B:** For inhibiting the recording of video/control signals
- Pin B is effective only when pin A is in the recording enabled position.
- Pin C:** For identifying the 4-channel audio or 8-channel audio format

* Normal playback cannot be performed for tapes on which the audio signals of 8 channels were recorded with the C bit pin at the raised position or for tapes on which the audio signals of 4 channels were recorded with the pin at the lowered position.

Recording

Preparation

Release the recording inhibit mode

- Confirm that the REC INHIBIT lamp has gone out.

REC INHIBIT 

If the lamp has not gone out, set the positions of the cassette's accidental erasure prevention pins and the F13 (REC INH) setting on the HOME menu to the recording enabled status.

Selecting the input signals and adjusting their levels

- Select the video input signal (INT SG or DIGITAL) on the VIDEO IN menu.
- Select the audio input signal on the AUDIO IN PCM menu and the AUDIO IN CUE menu.
- Adjust the audio input signal level on the AUDIO IN menu.

Adjust the audio input signal levels for the digital audio channels CH1 to CH4 (or CH1-CH8 when the 8-channel format has been selected) and for analog cue.

Normally, UNITY should be selected.

- When adjusting the recording levels, select the channel whose level is to be adjusted using the AUDIO IN menu (for example, to adjust the PCM CH1 level, press the F1 key to set to white-on-black display), and adjust the levels using the ADJUST control in such a way that 0 dB is not exceeded for the digital signals and -20 dB is not exceeded for the analog cue signal.



- The OVER display lights when the recording level is too high.

- The level meter display can be switched.

The level meter display can be set to FULL or FINE using the F7 (SCALE) key on the AUDIO IN SET UP menu or the F7 (SCALE) key on the AUDIO OUT SET UP menu.

How to display the menus:

- VIDEO IN menu:

VIDEO IN

- AUDIO IN menu:

AUDIO IN

- AUDIO OUT menu:

AUDIO OUT

- AUDIO IN SET UP menu:

AUDIO IN → F8

- AUDIO IN PCM menu:

AUDIO IN → F6

- AUDIO IN CUE menu:

AUDIO IN → F7

Recording

Preparation

□ Setting the time code

- Press the F4 (TC/CTL) key on the HOME menu to select TC.
- Select the internal or external time code on the TC/CHR menu and set the generating mode.

Operation

- (1) Press the PLAY button while pressing the REC/EDIT button.
Recording will start.

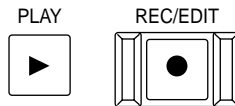

- (2) Recording stops when the STOP button is pressed.
If the JOG, SHTL, or VAR button is pressed in place of the STOP button, operation is directly transferred to the mode that corresponds to the respective button.

How to display the menus:

●HOME menu:

HOME

●TC/CHR menu:

TC/CHR

Recording

Simultaneous playback monitoring

Video monitoring

- Set VIDEO during recording to TAPE on the VIDEO OUT HD SET UP STATE menu.



Audio monitoring

- Set AUDIO during recording to TAPE on the AUDIO OUT SET UP STATE menu.

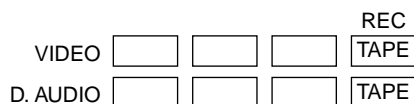

- The digital audio and the digital video signals are interlinked at all times. They can not be set separately.
- Simultaneous playback of the analog cue signal is not possible.
- Simultaneous playback monitoring is not possible when the F1 (OUTPUT) key on the HOME menu is set to EE.
- Even when the state menu setting is EE1 or EE2, simultaneous playback monitoring of both the video and audio signals is possible by setting the F1 (OUTPUT) key on the HOME menu to TAPE.

Checking the input signals

- To monitor the input signals during recording:

- (1) Connect a TV monitor to the serial monitor connector.
Connect the audio monitor connector to the monitor speaker.
- (2) Press the INPUT CHECK button.



While this button is held down, the video signal can be checked using the serial monitor output connector.

- Only the audio signal selected by the L and R buttons can be monitored (via the audio monitor connector or the headphone connector).

* In the HD mode, only the HD-SDI monitor output can be switched to the input signals; in the SD mode, only the SD-SDI monitor output and VIDEO3 output can be switched to the input signals.

How to display the menus:

- STATE menu:

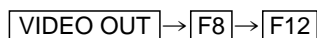

or

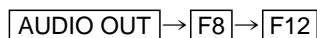

- HOME menu:



Recording

This flowchart shows the steps for recording the digital signals which are supplied to the unit from an external digital device.

1. Check the connections.
2. Turn on the power.
3. After making sure that no cassette tape is inserted in this unit, set the system frequency 59.94, 23.98, 24, 25 or 50 by F1 (FREQ) key of the SYSTEM SET UP menu.

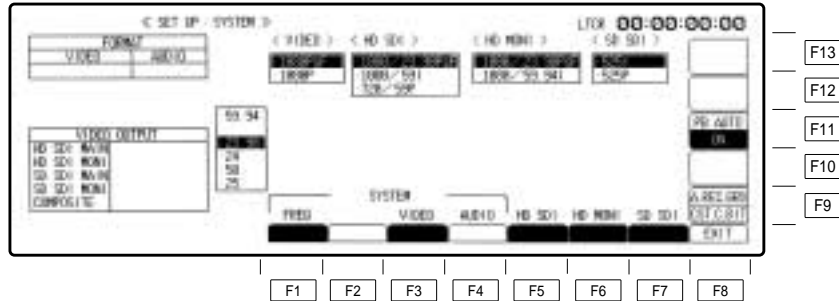

The frequency setting is possible when the F1 key is pressed. Select the frequency by cursor keys [▲, ▼] and press the ENT key, then the frequency is secured. In 59 Hz mode, the selection window will be further displayed (1080i/525i/720p). Select the format by the cursor key, and press the ENT key to secure the format. Then, select its 4-channel or 8-channel audio version, and enter the format by pressing the ENT key.

In the 23.98 Hz, 24 Hz or 25 Hz mode, a window appears offering the user the option of selecting PsF or P for the VIDEO signal interface format. When the format is selected using the cursor keys [▲, ▼] and the ENT key is then pressed, the format is entered. In the same way, the HD MAIN output and HD MONI output formats are selected using the cursor keys [▲, ▼] and then entered by pressing the ENT key.

(The table below lists the possible combinations of the output signals of the video output connectors.)

System format	HDTV output		SDTV output		
	HD MAIN	HD MONI	SD SDI MAIN	SD SDI MONI	Analog composite
1080/59.94i ^{*1}	1080/59.94i	1080/59.94i	525/59.94i	525/59.94i	NTSC
720/59.94p	720/59.94p	720/59.94p	525/59.94i	525/59.94i	NTSC
	720/59.94p	720/59.94p	525/59.94p	525/59.94i	NTSC
1080/23.98p, PsF ^{*3}	1080/23.98PsF	1080/23.98PsF	525/59.94i	525/59.94i	NTSC
	1080/23.98PsF	1080/23.98PsF	525/59.94p	525/59.94i	NTSC
	1080/23.98PsF	1080/59.94i	—	—	—
	1080/23.98p	1080/23.98p	525/59.94i	525/59.94i	NTSC
	1080/59.94i	1080/59.94i	525/59.94i	525/59.94i	NTSC
	1080/59.94i	1080/59.94i	525/59.94p	525/59.94i	NTSC
	720/59.94p	720/59.94p	525/59.94i	525/59.94i	NTSC
	720/59.94p	720/59.94p	525/59.94p	525/59.94i	NTSC
1080/24.00p, PsF ^{*3}	1080/24PsF	1080/24PsF	—	—	—
	1080/24PsF	1080/60i	—	—	—
	1080/24p	1080/24p	—	—	—
	1080/60i	1080/60i	—	—	—
	720/60p	720/60p	—	—	—
1080/25p, PsF	1080/25PsF	1080/25PsF	625/50i	625/50i	PAL
	1080/25p	1080/25p	625/50i	625/50i	PAL
1080/50i ^{*2}	1080/50i	1080/50i	625/50i	625/50i	PAL
480/59.94i	1080/59.94i	1080/59.94i	525/59.94i	525/59.94i	NTSC
576/50i	1080/50i	1080/50i	625/50i	625/50i	PAL

How to display the menus: ●SYSTEM SET UP menu:



^{*1}The 1035/59.94i format signals cannot be recorded on this VTR but a tape recorded using the AJ-HD2000 or other model can be played back.

^{*2}1080/23.98p 1080/25p and 1080/24p format tapes can be played back and 1080/50i format signals can be output automatically.

^{*3}1080/25p tapes can be played back and a variety of images can be output.

Recording

- Insert a recording-enabled cassette.
It should be borne in mind that the 4-channel or 8-channel audio version will be identified in accordance with the position selected for the cassette C bit pin, as mentioned on page 25.
Note that when the cassette tape is inserted, it is not possible to change the system frequency which was set using the F1 (FREQ) key on the SYSTEM SET UP menu of the previous page.
- Press the F13 (REC INH) key on the HOME menu to set to "FREE".



- Perform input signal setting with the F1 to F6 (CH1 to CH4) keys on the AUDIO IN PCM INPUT SELECT menu. [In the case of the 1080/23.98, 1080/24p, 1080/25p, 1080/50i and 576/50i formats or 1080/59.94i (8-channel audio version), 720/59.94i (8-channel audio version) and 480/59.94i (8-channel audio version) formats, perform input signal setting with the F7 to F13 (CH5 to CH8).] Select DIGITAL (AES/SERIAL.), INT SG or ANALOG.

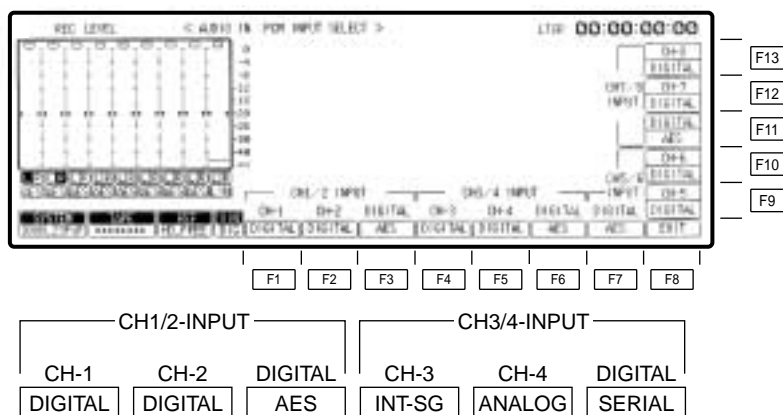

- When the input audio signal is to be mixed with the analog cue channel for recording, press the F9 (CUE) key on the AUDIO IN CUE INPUT menu to set it to "D-MIX" and select the mixing channel with the F1 to F4 (CUE MIX CH1 to CUE MIX CH4) keys. (In the case of the 1080/23.98, 1080/24p, 1080/25p, 1080/50i and 576/50i formats or 1080/59.94i (8-channel audio version), 720/59.94i (8-channel audio version) and 480/59.94i (8-channel audio version) formats, select CH1 to CH4 and CH5 to CH8 with the F1 to 4 and the F10 to F13 keys.)

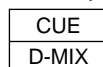

- Adjust the audio input level on the AUDIO IN menu.
- When the time code is to be recorded, perform the time code-related settings on the TC/CHR menu.

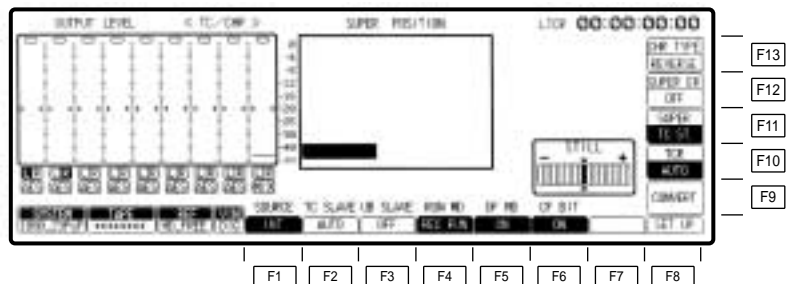

- To enter the time code default value as desired, press the cursor center key at the HOME menu and set the value.
- When the preparation for the signals to be recorded has been established, press the REC/EDIT button and the PLAY button together.
Recording will start.
- To stop recording at any time, press the STOP button.

How to display the menus:

●HOME menu:

HOME

●AUDIO IN PCM menu:

AUDIO IN	→	F6
----------	---	----

●AUDIO IN CUE menu:

AUDIO IN	→	F7
----------	---	----

●TC/CHR menu:

TC/CHR

Recording

- The REF synchronization specifications applying when the 1080/23p, 24p or 25p True-P (Non-PsF) system format is selected are the same specifications as for the PsF system format. Use an interlace format signal for the HD tri-level SYNC signal.
- The True-P (Non-PsF) input/output interface does not support EMBEDDED AUDIO/TC/VANC.
- The enhance and filter response picture quality adjustments do not work for True-P (Non-PsF) outputs.
- Other signals cannot be superimposed onto HD monitor outputs using True-P signals.
- When PsF signals have been recorded using a PsF system format and they are subsequently played back using a True-P system format, the PsF signals are converted into True-P signals. Conversely, when True-P signals have been recorded using a True-P system format and they are subsequently played back using a PsF system format, the True-P signals are converted into PsF signals.
- Bear in mind that when recording 1080/50i signals using the 1080/25PsF system format, the signals will be recorded but the images will be blurred.

Playback

Operation



- (1) Press the PLAY button.
Playback will start.
- (2) Playback stops when the STOP button is pressed.
If the JOG, SHTL, VAR, FF, or REW button is pressed in place of the STOP button, operation is directly transferred to the mode that corresponds to the respective button.

Monitoring the audio signals

- Select the audio channel for output from the AUDIO MONITOR L/R connector or the HEADPHONES jack using the L/R buttons. (The audio channel can be switched to the opposite direction when the L or R button is pressed while the F key is being held down.)

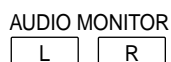

Adjusting the audio level

Adjust the playback level of the digital audio CH1 to CH4 (or CH1–CH8 when the 8-channel format has been selected) signal and the analog cue audio signal.

To adjust the audio signal level, first press the F key allocated to the channel concerned on the AUDIO OUT menu to highlight it, and then adjust the level using the ADJUST control.

The adjustment range is from $-\infty$ to +12 dB for digital audio signals as well as for the analog cue signal.

- To adjust all digital audio signal playback levels together, adjust with the ADJUST knob while pressing the AUDIO LINE OUT button.
- The level meter display can be switched between FULL and FINE.

Fine adjustment is possible by setting the F7 (SCALE) key on the AUDIO IN SET UP menu or the F7 (SCALE) key on the AUDIO OUT SET UP menu to "FINE".

How to display the menus:

- AUDIO OUT SET UP menu:

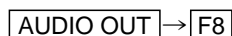

- AUDIO IN SET UP menu:



Basic operations

□ Stop

Press the STOP button.
The tape will stop.

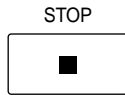

- In order to protect the tape, the tape tension is automatically released (a process called “loosening”) when the time selected by the F12 (STILL) key on the HOME SET UP menu has elapsed. The READY lamp will flash.
- Furthermore, the READY OFF mode is automatically established when the time selected by the F13 (STBY OFF) key on the HOME SET UP menu has elapsed. The READY lamp will go out and the STOP lamp will light. (Refer to the item STANDBY on this page.)

□ FF/REW

Press the FF or the REW button.

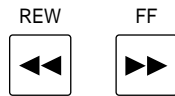

- The tape will now be fast forwarded or rewound at approximately 50 times of the normal playback speed.
- In order to protect the tape, the speed is reduced as the tape end is approached.
- Use the F5 (FF/REW MAX SP) key on the INTERFACE SET UP menu to change the fast forward or the rewind speed.
- While the FF and the REW button are pressed at the same time, the tape is stopped.

□ STAND BY

- When the STAND BY lamp is lit, the unit is in the STAND BY ON status.



STAND BY OFF mode is established automatically when the time selected with the F13 (STBY OFF) key on the HOME SET UP menu has elapsed and loosening status has been reached. (Refer to the item STOP on this page.)

- When the STAND BY lamp is not lit, the unit is in the STAND BY OFF status.



Two modes are associated with this mode.

- (1) Drum rotation stop mode with tension release
Set the F6 (TAPE MODE) key on the HOME SET UP menu to HD.STOP.
- (2) Half loading mode
Set the F6 key on the HOME SET UP menu to HLF LOAD.

How to display the menus:

●HOME SET UP menu:

[HOME] → [F8]

●HOME menu:

[HOME]

●SET UP INTERFACE menu:

[SET UP] → [F8]

Basic operations

□ Shuttle (SHTL)



(1) The unit is placed in the shuttle mode when the SHTL button is pressed and the lamp lights.

(2) Turn the search dial.

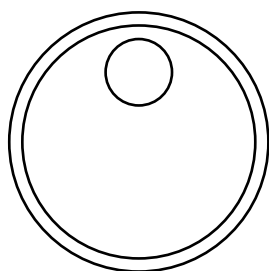

- The tape speed changes depending on the angle by which the dial is turned.
- The tape speed is displayed on the search indicator.
- The tape speed can be varied up to a maximum of ± 50 times the normal tape speed.
- The maximum speed can be set by pressing the F6 (SHTL MAX SP) key on the PANEL SET UP menu.

(3) When the STOP, FF, REW, PLAY, JOG, or VAR button is pressed, operation is directly transferred to the mode that corresponds to the respective button.

□ Jog

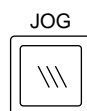

(1) The unit is placed in the JOG mode when the JOG button is pressed and the lamp lights.

(2) Turn the search dial.

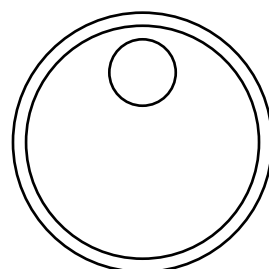

- When the dial rotation is stopped, the unit is placed in the still-picture (STILL) mode.
- The tape protection mode is established after the still-picture holding time has elapsed. (This time can be set using the F12 (STILL) key on the HOME SET UP menu and the ADJUST control.)
- The tape speed changes depending on the speed by which the dial is turned.
- The tape speed ranges from -2 times to $+2$ times of the normal tape speed. In the range from -1 to $+2$ times of the normal tape speed, the audio signals for all channels are output from the AUDIO OUT connectors.

(3) When the STOP, FF, REW, PLAY, SHTL, or VAR button is pressed, operation is directly

How to display the menus:

●HOME SET UP menu:

[HOME] → [F8]

●PANEL SET UP menu:

[SET UP] → [F11]

Basic operations

□ Variable (VAR)

The variable mode is a low-speed version of the shuttle mode.
This operation may be initiated from STOP or PLAY mode or during normal recording.

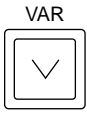

- (1) The unit is placed in the variable mode when the VAR button is pressed and the lamp lights.
- (2) Turn the search dial.

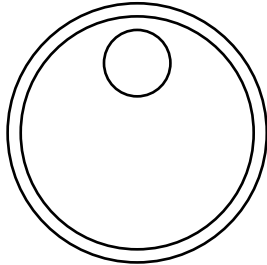

- The tape speed changes depending on the angle by which the dial is turned, and it is displayed on the search indicator.
- The tape protection mode is established after the still-picture holding time has elapsed. (This time can be set using the F12 (STILL) key on the HOME SET UP menu and ADJUST control.)
- Turning the dial enables shuttle operations across a range from -1 to +2 times of the normal tape speed. The audio signals for all channels are output from the AUDIO OUT connectors.
- The maximum speed can be set by pressing the F12 (VAR MAX SP) key on the PANEL SET UP menu.

- (3) When the STOP, FF, REW, PLAY, JOG, or SHTL button is pressed, operation is directly transferred to the mode that corresponds to the respective button.

●Preset variable mode

When the variable speed is preset, playback starts at the set speed when the VAR button is pressed.

- (1) Set the desired speed by turning the search dial.
The tape speed changes depending on the angle by which the dial is turned. The speed is displayed on the search indicator.
 - (2) Press the VAR button. (The VAR lamp lights.) Playback will start at the set speed.
 - (3) To release the preset variable mode, turn the search dial. The normal variable mode will be established.
- The preset variable mode can be operated only in STOP or PLAY mode or during normal recording.

How to display the menus:

●PANEL SET UP menu:

SET UP → F11

●HOME SET UP menu:

HOME → F8

Basic operations

□ Tape speed override (TSO) function

This is a function for finely adjusting the normal playback speed in the range of $\pm 15\%$.



- (1) Press the PLAY button.
Normal playback starts.
- (2) Turn the search dial while pressing the PLAY button, or press the + or – keys. When using the search dial, the tape speed changes depending on the angle to which the search dial is turned. When using the + or – keys, the tape speed changes according to how long the key is pressed continuously. The speed is displayed in numeric values on the search indicator.
- (3) To return to normal playback, release the PLAY button.

□ Cue

This function sets any point on the tape for preroll and search operations.

When TC INPUT is set to the STANDARD mode*

- (1) Press the cursor center key to display the cursor.
The time code value will be highlighted.



- (2) Move the cursor with the cursor key (▼) to the CUE TIME display section.
The cue display section will be highlighted.

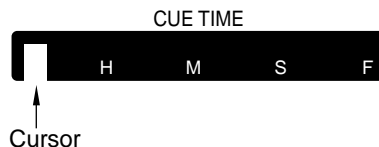

- (3) Press the cursor center key again to change it to a bar cursor.
Enter the cue point with the number keys.

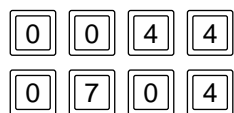

- Cue points also can be entered by pressing the ENTRY button. In this case, the time data of the current tape position will be entered.

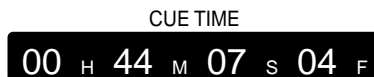

- (4) Press the ENT key.
The cursor will disappear.
- (5) Press the PREROLL button.

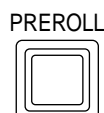

- When the PREROLL button is pressed, cue-up operation will start, and the tape will stop at the preroll point (the point preceding the cue point by the preroll time).
- To stop at the cue point, either set the preroll time to "0" or press the F key and PREROLL button together. (This results in the cue-up operation.)

*The STANDARD mode is set using the F9 key on the PANEL SET UP menu. (This key can be set in either the STANDARD or REVERSE mode.)

Basic operations

When TC INPUT is set to the REVERSE mode*

- (1) Press the cursor center key to display the cursor.
The time code value will be highlighted.

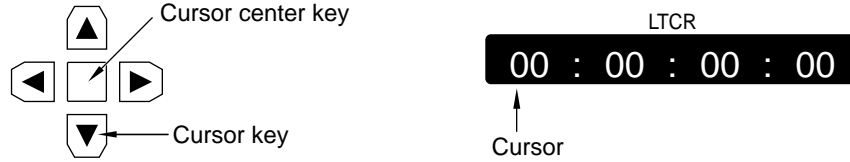

- (2) Move the cursor with the cursor key (▼) to the CUE TIME display section.
The cue display section will be highlighted.

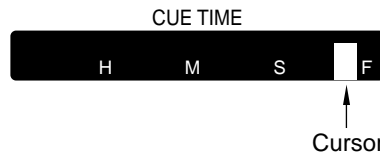

- (3) Press the cursor center key again to change it to a bar cursor.
Enter the cue point with the number keys.

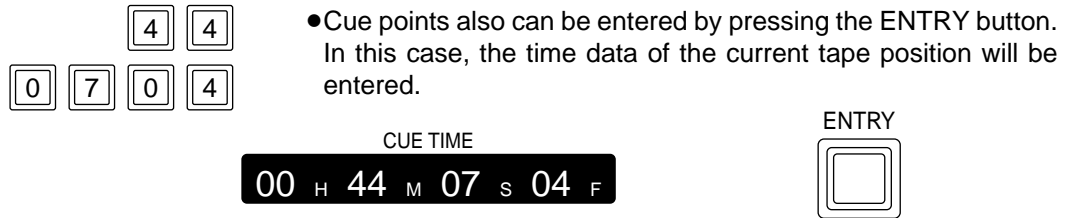

- (4) Press the ENT key.
The cursor will disappear.

- (5) Press the PREROLL button.

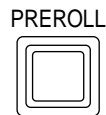

- When the PREROLL button is pressed, cue-up operation will start, and the tape will stop at the preroll point (the point preceding the cue point by the preroll time).
- To stop at the cue point, either set the preroll time to "0" or press the F key and PREROLL button together. (This results in the cue-up operation.)

*The REVERSE mode is set using the F9 key on the PANEL SET UP menu. (This key can be set in either the STANDARD or REVERSE mode.)

Basic operations

□ Correction of the cue point

When TC INPUT is set to the STANDARD mode

(1) Move the cursor to the place which is to be corrected.

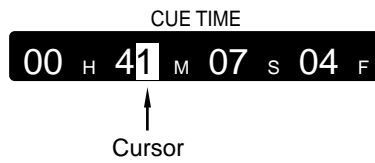

(2) ENTER the new value with the number keys.

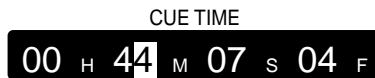

(3) Press the ENT key.

- Cue points cannot be cleared.

When TC INPUT is set to the REVERSE mode

Partial corrections cannot be made for cue points.

Repeat the input starting from step (1) when TC INPUT on page 33 was set to the REVERSE mode.

Manual editing

Manual editing is a method used for editing which does not involve the REGISTRATION of edit points (IN/OUT points).

1. Check the connections.
2. Switch on the power.
3. Insert the cassette to be edited.
4. Press the F13 (REC INH) key on the HOME menu to set to FREE or NRML.REC.

REC INH
FREE

5. Select and adjust the input signals.
6. To record the time code, perform the time code-related settings on the TC/CHR menu.
7. To enter the desired default value for the time code, press the cursor center key at the HOME menu and set the desired value.
8. Press the ASSEMBLE or the INSERT button to display the INSERT/ASSEMBLE EDIT menu.
9. Press the F12 key on the INSERT (or the ASSEMBLE) EDIT menu to set to MANUAL EDIT, display the MANUAL EDIT menu, and highlight the F9 (INSERT or ASSEMBLE) key.

MANUAL EDIT

10. When insert editing was selected in step 8 by pressing the INSERT button, press the F13 key on the INSERT MANUAL EDIT menu to display the INSERT MANUAL EDIT CH SELECT menu, and select the channels to be edited.
11. Set the editing timing with the F1 (TIMING) key on the INSERT (or ASSEMBLE) MANUAL EDIT SET UP menu.

TIMING F2

How to display the menus:

●HOME menu:

HOME

●TC/CHR menu:

TC/CHR

●INSERT (or ASSEMBLE) EDIT menu:

INSERT

 (or

ASSEM

) →

F12

●INSERT (or ASSEMBLE) MANUAL EDIT CH SELECT menu:

INSERT

 (or

ASSEM

) →

F12

 →

F13

●INSERT (or ASSEMBLE) MANUAL EDIT SET UP menu:

INSERT

 (or

ASSEM

) →

F12

→

F8

Manual editing

12. Search the edit start (IN) point and set the picture to the still mode.
13. Press-the PREROLL button if preroll is required.
14. Provide input of the editing source.
15. Press the PLAY button to place the unit into playback mode.
16. Press the REC/EDIT button at the edit start (IN) point.
Editing will start.
17. To end editing, press the STOP or the REC/EDIT button.

Manual audio cross editing

Below is a flowchart showing the steps taken for editing in which audio signals are cross-faded (while the preceding playback sound is being faded out, the player sound is faded in) in the manual edit mode.

1. Prepare for manual editing by referring to steps 1 to 14 in the manual editing flowchart.
2. Set the F13 (MODE) key on the INSERT (OR ASSEMBLE) MANUAL EDIT SET UP menu to XFADE.

MODE
X FADE

3. Use the F12 (FD TIME) key on the INSERT (OR ASSEMBLE) MANUAL EDIT SET UP menu to set the fade time.

MODE FD TIME
X FADE 20

4. Refer to steps 15 to 17 of manual editing, and proceed with editing.
- For audio V fading, set the F13 (MODE) key on the INSERT (OR ASSEMBLE) MANUAL EDIT SET UP menu to VFADE.
 - The settings for audio cross editing can be performed only when EE1 has been set as the EDIT REC status.

How to display the menu:

- INSERT (or ASSEMBLE) AUTO EDIT SET UP menu:

INSERT (or ASSEM) → F8

Automatic insert/assemble editing

The following flowchart shows the operation for automatic insert editing or automatic assemble editing with two digital VTRs.

1. Check the connections.
2. Switch on the power to the player and to the recorder.
3. Insert the cassettes required for editing into the VTRs.
4. Press the REMOTE button on the player and set the button to REMOTE (lamp is lit).

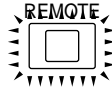

5. Press the REMOTE button on the recorder and set the button to LOCAL (lamp is not lit).



6. Set the F3 (W/PLYR) key on the recorder's INSERT (or ASSEMBLE) AUTO EDIT menu to ON.

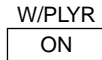

7. Set the F1 (P-2) key on the recorder's SET UP INTERFACE menu to MODE-1. Set the RS-422A control mode for each VTR depending on the player/recorder connections. (Refer to the F1 (P-2) key on the SET UP INTERFACE menu.)

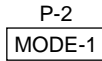

8. Set the F13 (REC INH) key on the recorder's HOME menu to FREE or NRML.REC.



9. Select and adjust the input signals on the recorder.
10. To record the time code, perform the time code-related settings on the recorder's TC/CHR menu.
11. To enter the desired default value for the time code, press the cursor center key at the recorder's HOME menu and set the desired value.

How to display the menus:

●INSERT (or ASSEMBLE) AUTO EDIT SET UP menu:

[INSERT] or [ASSEM] → [F8]

●SET UP INTERFACE menu:

[SET UP] → [F10]

●HOME menu:

[HOME]

●TC/CHR menu:

[TC/CHR]

Automatic insert/assemble editing

12. Press the INSERT or the ASSEM button to display the INSERT (or the ASSEMBLE) EDIT menu, and then press the F12 key to set to AUTO EDIT.
When the F9 (INSERT/ASSEMBLE) key is highlighted, the editing mode is established.
13. When insert editing was selected in step 12 by pressing the INSERT button, press the F13 (CH SELECT) key on the INSERT AUTO EDIT menu, and select the channels to be edited on the editing channel selection menu.
14. Enter the edit points on the INSERT (or the ASSEMBLE) AUTO EDIT menu.
Register 3 points of the player's IN and OUT points and the recorder's IN and OUT points.*
15. Set the recording inhibit mode on the INSERT (or the ASSEMBLE) AUTO EDIT SET UP menu. (For assemble editing, release recording inhibition for all channels.)
16. Perform the settings on the AUTO EDIT SET UP menu.
17. Press the PREVIEW/REVIEW button to preview.
18. When the REC/EDIT button is pressed, automatic editing will start.
19. To review the edited contents, press the PREVIEW/REVIEW button after completion of editing.

*When the ENTRY button is pressed on its own, the recorder's IN point is entered if there is no cursor. Conversely, if the cursor is displayed on the IN point side, the point indicated by the cursor will be entered as the IN point.

When the ENTRY button is pressed while holding down the F key, the recorder's OUT point is entered if there is no cursor. Conversely, if the cursor is displayed on the OUT point side, the point indicated by the cursor will be entered as the OUT point.

<Note>

To set the editing accuracy to ± 0 , select ON for the PLR SYNC setting. (Refer to the F4 key on the INSERT/ASSEMBLE AUTO EDIT SET UP menu.)

How to display the menus:

● INSERT (or ASSEMBLE) AUTO EDIT SET UP menu:

INSERT or ASSEM → F8

Audio split editing

The following flowchart shows the operation for separately entering the audio and video edit point positions for automatic editing.

1. Press the INSERT button to display the INSERT AUTO EDIT menu.



2. Press the F10 (SPLIT) key on the INSERT AUTO EDIT menu to set it to be highlighted.
3. Refer to the flowchart for automatic insert editing operation, and register the video edit points.
4. Register the audio edit points.

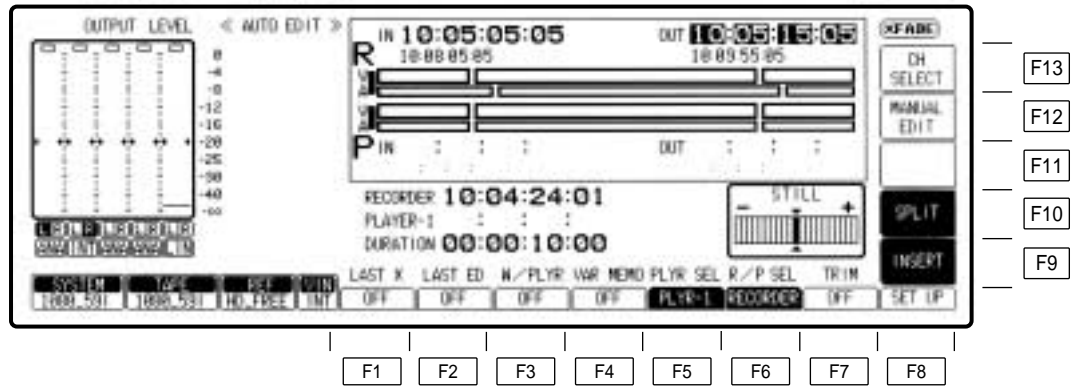

5. Press the PREVIEW button to preview.
6. When the REC/EDIT button is pressed, automatic editing will start.
7. To review the edited contents, press the REVIEW button after completion of editing.

<Notes>

- Do not make any changes to CH SELECT while split editing is being performed. Otherwise, errors may occur in the operation.
- Assemble (audio split) editing can also be performed in the same operation.

Audio split editing

OUT point preview

■ Previewing the automatic insert editing OUT point (when audio split is OFF)

This flowchart shows the operation to preview the automatic insert editing OUT point.
The OUT point for automatic assemble editing can not be previewed.

1. Press the INSERT button to display the INSERT AUTO EDIT menu.
2. Use the automatic insert editing flowchart as a reference and register the VIDEO OUT point.
3. Press the EXECUTE and the PREVIEW/REVIEW button together to preview the OUT point.

■ Previewing the automatic insert editing OUT point (when audio split is ON)

This flowchart shows the operation to preview the automatic insert editing (audio split) OUT point.
The OUT point for automatic assemble editing can not be previewed.

1. Press the INSERT button to display the INSERT AUTO EDIT menu.
2. Press the F10 (SPLIT) key on the INSERT AUTO EDIT menu to set it to be highlighted.
3. Use the automatic insert editing flowchart as a reference and register the VIDEO OUT point.
4. Register the audio edit points.
5. To preview the VIDEO OUT point:
 1. Use the cursor keys to move the cursor to the places where the VIDEO IN and OUT points were registered.
 2. Press the EXECUTE and the PREVIEW/REVIEW buttons together to preview the VIDEO OUT point.
6. To preview the AUDIO OUT point:
 1. Use the cursor keys to move the cursor to the places where the AUDIO IN and OUT points were registered.
 2. Press the EXECUTE and the PREVIEW/REVIEW buttons together to preview the AUDIO OUT point.
7. To preview the OUT point without moving the cursor to where the IN and OUT points were registered:

When the cursor is not available, the preview operation is started from the point 12 seconds before the external OUT point.
Then press the EXECUTE and the PREVIEW/REVIEW button together to preview the OUT point.

Variable memory Function

1. Set the F3 (W/PLYR) key to OFF.

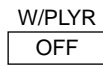

2. Set the F4 (VAR MEMO) key to ON.



- If the IN and OUT points have already been entered, they will be automatically cleared.
 - If the split mode is ON, it will be forcibly turned off.
 - When the variable memory function is used, the AUDIO IN and OUT points cannot be entered.
3. Input the unit's edit IN point.
The variable memory playback will start at this point.
 - There is no need to set the OUT point for variable memory playback.
 4. Set the initial speed using the search dial.
The initial speed is displayed on the search indicator.
 5. Press the PREROLL and EXECUTE buttons together to start the operation.
The tape runs as far as the preroll point where playback starts at the initial speed.
 6. When the edit IN point is passed, the EXECUTE button's lamp starts to blink.
 7. Turn the search dial and store the tape speed in the memory.
 - The speed can be stored in the memory while the EXECUTE button's lamp is blinking.
When the memory becomes full, the EXECUTE button's lamp lights, and no further settings can be stored in the memory.
 - To make changes to the initial speed or memory contents, repeat the procedure from step 4.
 8. To exit the variable memory, press the STOP button.
 9. When the memory contents are to be played back, they will be regenerated by pressing the EXECUTE button.
 - The memory contents are regenerated as soon as the IN point is passed, and the tape continues to travel at the speed last stored in the memory until the STOP button is pressed.
 - The contents stored in the memory are cleared by setting the F4 (VAR MEMO) key from OFF to ON. Alternatively, they are cleared by setting the power switch to OFF.

Variable memory function

By operating the VTR search dial which is connected to the unit's RS-422A REMOTE OUT or REMOTE IN/OUT connector, the playback speeds and directions can be stored in the memory, after which the stored contents can be regenerated during automatic editing and stored in the memory of the unit (recorder).

1. Set the F3 (W/PLYR) key to ON.

W/PLYR
ON

- To operate the VTR connected to the REMOTE OUT connector by remote control, set F5 (PLYR SEL) on the ASSEMBLE/INSERT AUTO EDIT menu to PLAY-1.
- To operate the VTR connected to the REMOTE IN/OUT connector by remote control, set F5 (PLYR SEL) on the ASSEMBLE/INSERT AUTO EDIT menu to PLAY-2.

2. Set the F4 (VAR MEMO) key to ON.

VAR MEMO
ON

3. Enter the recorder's VIDEO IN and OUT points together with the player's IN point.
4. Select PLAYER using the F6 (R/P SEL) key, and set the initial speed using the search dial. The initial speed is displayed on the search indicator.
5. Press the PREVIEW button.
The tape runs as far as the preroll point where playback starts at the initial speed.
6. When the edit IN point is passed, the EXECUTE button's lamp starts to blink.
7. Set the F6 (R/P SEL) key to PLAYER, and store the speed up to the recorder's OUT point in the memory using the search dial.
The speed can be stored in the memory while the EXECUTE button's lamp is blinking until the recorder's OUT point is reached.
When the memory becomes full, the EXECUTE button's lamp lights, and no further settings can be stored in the memory.
8. To preview the memory contents, press the PREVIEW button, and the memory contents will be regenerated. Phase synchronization is not performed. Adjust the edit timing using the F9 (DLY STRT) key on the ASSEMBLE/INSERT AUTO EDIT SET UP menu.
9. To make changes to the contents stored in the memory while preview is underway, operate the search dial. The EXECUTE button's lamp now blinks, and the contents are stored in the memory.
10. To make changes to the initial speed which was stored in the memory, press the STOP button.
Set the F6 (R/P SEL) key to PLAYER, and then use the search dial to set the initial speed while holding down the STOP button. Since the memory contents will be cleared when the initial speed is changed, repeat the procedure from step 5.
11. To proceed with variable memory automatic editing, press the REC/EDIT button. The tape in the player is played back in accordance with the memory contents, and the contents are stored in the memory of the unit (recorder).
12. When the PREVIEW/REVIEW button is pressed upon completion of the editing, the editing will be reviewed.
 - The contents stored in the memory are cleared by setting the F10 (VAR MEMO) key from OFF to ON.
 - They are also cleared by setting the power switch to OFF.

Connector signals

VIDEO IN

HD SDI (DIGITAL)	BNC×2, active through
SD SDI IN (DIGITAL)	BNC×2, active through
SD SDI SPARE	BNC×1
HD REF IN	BNC×2, loop-through with 75Ω termination switch
SD REF IN	BNC×2, loop-through with 75Ω termination switch

VIDEO OUT

HD SDI OUT (DIGITAL)	BNC×3
HD SDI MONITOR OUT (DIGITAL) (SUPER)	BNC×1
SD SDI OUT (DIGITAL)	BNC×2
SD SDI MONITOR (DIGITAL) (SUPER)	BNC×1
VIDEO OUT (ANALOG)	BNC×3
HD REF OUT	BNC×1
SD REF OUT	BNC×1
WFM	BNC×1, Waveform output, 75Ω.

TIME CODE

TIME CODE IN	XLR×1
TIME CODE OUT	XLR×1

AUDIO IN

AUDIO IN (DIGITAL)	BNC×4, CH1/2, CH3/4, CH5/CH6, CH7/CH8, AES/EBU format
AUDIO IN (ANALOG)	XLR×4, CH1, CH2, CH3, CH4
CUE IN	XLR×1

AUDIO OUT

AUDIO OUT (DIGITAL)	BNC×4, CH1/2, CH3/4, CH5/CH6, CH7/CH8, AES/EBU format
AUDIO OUT (ANALOG)	XLR×4, CH1, CH2, CH3, CH4
CUE OUT	XLR×1
MONITOR	XLR×2
HEADPHONES (FRONT)	¼" phone

Connector signals

□ PARALLEL I/O (50P) connector

(1) **PULSE SIGNAL:** The signal fall is detected and the signal becomes active.

Pin no.	Signal	Direction	Type	Description
1	REC COMMAND	INPUT	PULSE SIGNAL	When this signal becomes active simultaneously with the play command, it transfers the VTR to the REC PLAY mode. However, the VTR is not transferred to the REC mode if the insert or assemble mode has been set.
2	PLAY COMMAND	INPUT	PULSE SIGNAL	This transfers the VTR to the PLAY mode.
3	FF COMMAND	INPUT	PULSE SIGNAL	This transfers the VTR to the FF mode.
4	REW COMMAND	INPUT	PULSE SIGNAL	This transfers the VTR to the REW mode.
5	STOP COMMAND	INPUT	PULSE SIGNAL	This transfers the VTR to the STOP mode.
6	STBY ON COMMAND	INPUT	PULSE SIGNAL	When the VTR is in the loosing or STBY OFF mode, it is set to the STNBY ON mode as soon as it receives this command.
7	STBY OFF COMMAND	INPUT	PULSE SIGNAL	When the VTR is in the loosing or STBY ON mode, it is set to the STNBY OFF mode as soon as it receives this command.
8	RS-422 REMOTE ON COMMAND	INPUT	PULSE SIGNAL	This enables RS-422 control. However, the VTR must be in the REMOTE mode for this command to take effect.
9	RS-422 REMOTE OFF COMMAND	INPUT	PULSE SIGNAL	This disables RS-422 control.
10	LOCAL ENABLE COMMAND	INPUT	PULSE SIGNAL	This enables the REMOTE OP MAP functions. When the MAP MODE is set to ALL, it also enables EJECT.
11	EJECT COMMAND	INPUT	PULSE SIGNAL	This transfers the VTR to the EJECT mode.
12	ENTRY COMMAND	INPUT	PULSE SIGNAL	When this signal has become active, the VTR's current time (TC, CTL) is entered on the following menus: When the VTR has opened the HOME menu: <ul style="list-style-type: none"> ●The time is entered in CUE TIME on the HOME menu. When the VTR has opened the AUTO EDIT menu: <ul style="list-style-type: none"> ●The time is entered in CUE TIME on the HOME menu. ●The time is entered at the IN point on the AUTO EDIT menu. When the VTR has opened the EXTEND MULTI CUE menu: <ul style="list-style-type: none"> ●The time is entered at the cursor position of the EXTEND MULTI CUE menu. When the VTR has opened the MULTI CUE menu: <ul style="list-style-type: none"> ●The time is not entered on any of the menus. When the VTR has opened a menu other than the ones above: <ul style="list-style-type: none"> ●The time is entered in CUE TIME on the HOME menu.
13	ALL_REC_INH_ON COMMAND	INPUT	PULSE SIGNAL	This selects ALL as the REC INH menu setting.
14	PRE_CTL_INH_ON COMMAND	INPUT	PULSE SIGNAL	This selects PRE_CTL as the REC INH menu setting.
15	LOCAL DISABLE COMMAND	INPUT	PULSE SIGNAL	This disables the REMOTE OP MAP functions. When the MAP MODE is set to ALL, it also disables EJECT.

Connector signals

Pin no.	Signal	Direction	Type	Description
16	TC_SOURCE_EXT COMMAND	INPUT	PULSE SIGNAL	This sets TC SOURCE to EXT and TC SLAVE to ON.
17	TC_SLAVE_AUTO COMMAND	INPUT	PULSE SIGNAL	This sets TC SOURCE to INT and TC SLAVE to AUTO. During normal recording, the TCG value is recorded. During editing, the signal is regenerated at TC on the tape.
18	TL_SLAVE_MUST COMMAND	INPUT	PULSE SIGNAL	This sets TC SOURCE to INT and TC SLAVE to SLAVE. During normal recording and editing, the signal is regenerated at TC on the tape.
19	TC_RESET COMMAND	INPUT	PULSE SIGNAL	This clears the TCG value to zero.
20	STBY ON/OFF COMMAND	INPUT	PULSE SIGNAL	This sets the toggling action below. However, it takes effect in the STOP mode or STANDBY OFF mode. STANDBY ON ↔ STANDBY OFF
21	ERR O STATUS	OUTPUT	SIGNAL	Refer to the 50P error status output table below. (This pin is related with pins 24 and 34.)
22	SPARE	INPUT		Spare
23	CUE COMMAND	INPUT	PULSE SIGNAL	When this has become active, the tape is prerolled from the cue-up point on the VTR's menu. When the VTR has opened the AUTO EDIT menu: <ul style="list-style-type: none"> ●The tape is prerolled from the time for the IN point when the AUTO EDIT menu IN point has been entered. ●The tape is prerolled from the time for the current position when the AUTO EDIT menu IN point has not been entered. When the VTR has opened a menu other than the ones above: <ul style="list-style-type: none"> ●The tape is prerolled from the time for the CUE TIME when CUE TIME of the HOME menu has been entered. ●The tape is prerolled from the time for current position when the CUE TIME of the HOME menu has not been entered.
24	ERR 1 STATUS	OUTPUT	SIGNAL	Refer to the 50P error status output table below. (This pin is related with pins 21 and 34.)
25	SPARE	INPUT		Spare
26	+15 V POWER	OUTPUT		+15 V power
27	REC STATUS	OUTPUT	ACTIVE_L	This becomes active when the VTR is in the REC mode. It also becomes active when the REC button lamp on the front panel is lighted.
28	PLAY STATUS	OUTPUT	ACTIVE_L	This becomes active when the VTR is in the PLAY mode. It also becomes active when the PLAY button lamp on the front panel is lighted.

●50P error status output table

Output priority sequence	Pin 21 ERR 0	Pin 24 ERR 1	Pin 34 ERR 2	VTR status
1	0	0	0	NO SERVO LOCK
6	0	0	1	SERVO LOCK
5	0	1	0	HIGH ERROR
4	0	1	1	CONCEAL/V
3	1	0	0	CONCEAL/A
2	1	0	1	CONCEAL/VA
—	1	1	0	
—	1	1	1	

Connector signals

□ RS-422A REMOTE

Pin No.	Signal	Pin No.	Signal
1	FRAME GROUND	6	GND
2	REM IN (-) LINE(-)	7	REM IN (-) CMD LINE (-)
3	REM OUT (-) STATUS LINE (+)	8	REM OUT (-) STATUS LINE (+)
4	GND	9	FRAME GROUND
5	_____		

□ RS-232C REMOTE

Pin No.	Signal	Pin No.	Signal
1	FRAME GROUND	7	GND Signal ground
2	TX Send data	8	DCR Receive carrier detect
3	RX Receive data	9-19	_____
4	RTS Request to send	20	DTR Data terminal ready
5	CTS Clear to send	21-25	_____
6	DSR Data set ready		

□ V/A CONTROL

Pin No.	Signal	Pin No.	Signal
1	FRAME GROUND	8	REM TX (X) REMOTE CONTROL PROTOCOL TRANSMIT
2		9-13	_____
3	_____	14	REM RX (Y) REMOTE CONTROL PROTOCOL RECEIVE
4	REM (G)	15	REM TX (Y) REMOTE CONTROL PROTOCOL TRANSMIT
5-6	_____		
7	REM RX (X) REMOTE CONTROL PROTOCOL RECEIVE		

□ CONTROL PANEL

Pin No.	Signal	Pin No.	Signal
1	Headphone (L)	11	Headphone (GND)
2	Clock (+)	12	GND
3	RECEIVE DATA (+)	13	+24 V unregulated DC power
4	RECEIVE ENABLE (+)	14	RECEIVE STROBE (+)
5	TRANSMIT DATA (+)	15	TRANSMIT ENABLE (+)
6	Headphone (R)	16	DC control signal
7	Clock (-)	17	GND
8	RECEIVE DATA (-)	18	+24 V unregulated DC power
9	RECEIVE ENABLE (-)	19	RECEIVE STROBE (-)
10	TRANSMIT DATA (-)	20	TRANSMIT ENABLE (-)

Video head cleaning

Although this unit comes with an auto head cleaning function which reduces the amount of dirt on the heads, it is recommended that the video heads be cleaned every day for even more dependable operation. (For further details, please consult with your local dealer.)

□ Operation

Remove the cover of the upper portion on the cylinder. Soak some alcohol in a cleaning cloth, press it lightly against the middle drum as shown in the figure, and rotate the drum 2 or 3 times in the direction indicated by the arrow. After this, wipe the drum dry using a dry cleaning cloth and attach the removed cover after completion.

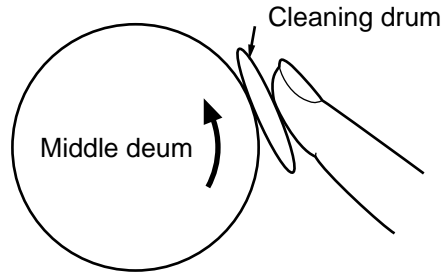

- Make sure that the power is off before proceeding with the head cleaning.
- Do not move your fingers up and down while cleaning.
This may damage the heads.
- Cut the cleaning cloth to the right size of the use.
- Proceed with the cleaning until no more dirt is taken up by the cleaning cloth.
- Make absolutely sure that no fluff from the cleaning cloth remains inside the VTR.
- When grease (from the VTR) is found to adhere to the cleaning cloth, be absolutely sure to replace the cleaning cloth.
- Before using the optional digital VTR dedicated head cleaning tape (AJ-TDCLS-P) to clean the heads, be sure to read carefully the "Precautions" provided with the cleaning tape.
- In addition to cleaning the video heads every day, make it a rule once a week to clean the tape transport system and once a month to clean the reel bases and carriage (cassette holder, front guide angles). For further details, please consult with your local dealer.

□ Maintenance

Before proceeding with maintenance, set the power switch to "OFF", and be sure to take hold of the power plug (and not the cord) to disconnect it from the power outlet.

Clean the cabinet with a soft cloth. With stubborn dirt, dilute some neutral kitchen detergent, dip the cloth in it, wring it out well and wipe the surface. After the dirt has been wiped off, take up any remaining moisture using a dry a cloth. Under no circumstances must paint thinners or benzene be used for cleaning purposes.

□ Storage

- Do not store the unit in an extremely hot or cold location.
- The unit must never be left outdoor.
- If the unit is not going to be used for a long time, set the power switch to OFF and be sure to take hold of the power plug (and not the cord) to disconnect it from the power outlet. This step is taken to safeguard against accidents.
- Be sure to eject the cassette tape.

Rack-mounting

The VTR can be installed in a 19-inch standard rack using the AJ-MA37P rack-mounting adapters (optional accessory).

It is recommended that the slide rail (CC3001-99-0191) made by Chassis Trak be used as the installed rails. For further details, consult your dealer.

1. Attach the inner members on each side of the VTR using the four screws supplied with the slide rails .

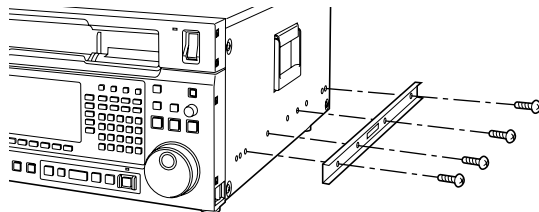

The length of the screws used is limited.

If the mounting screws have been lost or misplaced, use screws with a maximum length of 2/5".

Be absolutely sure to attach the inner members to the VTR using the screws for all of the four holes.

2. Mount the outer member brackets onto the rack.
Check that the height of the brackets is the same at the left and right.
3. Remove the two front screws on the VTR's two side panels.
4. Mount the AJ-MA37P rack-mounting adapters using the four supplied M4 screws with spring washers.

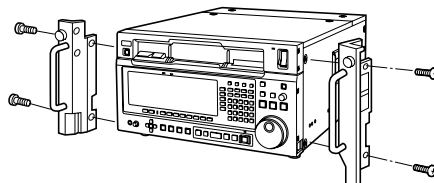

Rack-mounting adapter

5. Mount the VTR in the rack.
After mounting the VTR, check that it moves smoothly along the rails.

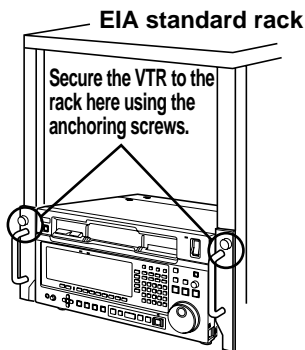

- Keep the temperature inside the rack within the +41 °F (5 °C) to 104 °F (40 °C) range.
- Bolt the rack securely to the floor so that it will not topple over when the VTR is drawn out.

Troubleshooting

Symptom	Cause and countermeasure
VTR fails to operate as per the mode selected on the menu screen.	Has the mode been changed on another menu? <ul style="list-style-type: none"> •The mode selected last has priority. •REC INHIBIT takes priority in the following sequence: CASSETTE, HOME and MANUAL/AUTO EDIT SET UP. Therefore, signals cannot be recorded if the REC INHIBIT status has been established on the cassette tape itself.
VTR fails to operate even when a function button is pressed.	•Check that the CONTROL switch is at LOCAL.
Recording and/or editing cannot be performed.	•Check that the cassette pins are set to the recording enable status.

How to eject the tape in an emergency

1. Remove four screws from both sides of the front panel and then remove the VTR's top panel.
2. The mechanism is moved in the unloading direction by turning the loading motor clockwise. Since tape slack now develops, proceed with the following 4 steps to take up the tape.
3. Insert a screwdriver into hole A (for an S or M cassette) or hole A' (for an L cassette), and press the manual lever of the take-up reel. The tape will be taken up by pressing this lever.
4. Remove the tape from the cylinder by performing the operations in steps 2 and 3. (When turning the loading motor, keep turning it until the position is reached where it will turn no further. Bear in mind that turning the motor past this position will cause the gear engagement to fail and/or other problems.)
5. To release the sub-loading, insert a screwdriver or other tool into hole B, and while turning it clockwise, take up the tape by performing the operation in step 3. (Bear in mind that continuing to turn the screwdriver even after the sub-loading status has been released will cause the gear engagement to fail and/or other problems.)
6. Check that all the tape has been taken up, and that its unloading has been completed. In order to eject the cassette, insert a screwdriver or other similar tool into hole C, and turn it counterclockwise. (Bear in mind that continuing to turn the screwdriver even after the cassette has been ejected will cause the gear engagement to fail and/or other problems.)

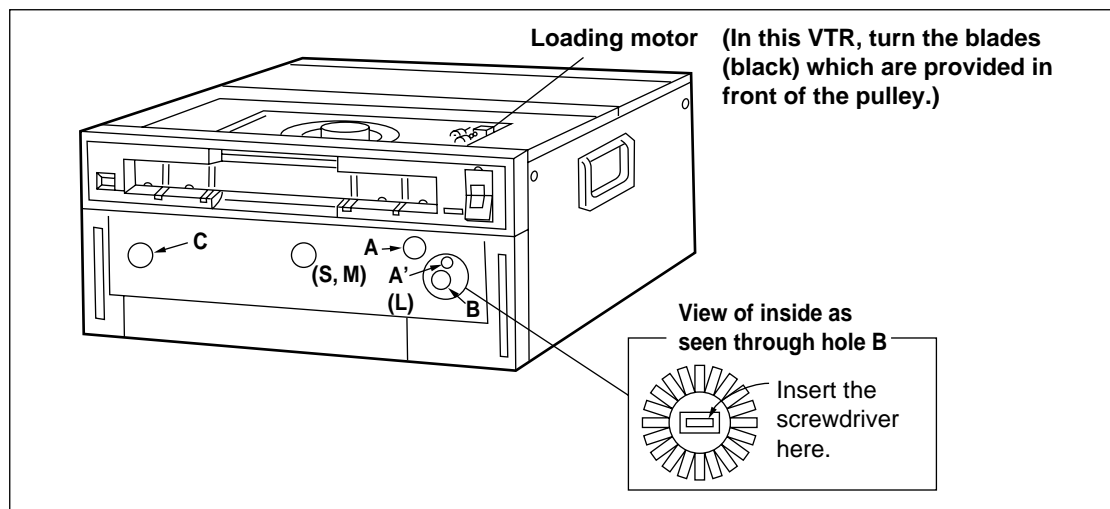

DIP switch

AV microcomputer DIP switch specifications

SW6501	ON (0)	OFF (1)	Remarks
1		Normal	Not used
2		Normal	Not used
3		Normal	Not used
4		Normal	Not used
5	Normal	—	Keep this switch at the factory setting.
6	Normal	—	Keep this switch at the factory setting.
7	—	Normal	Keep this switch at the factory setting.
8		Normal	Keep this switch at the factory setting.

SYSCON microcomputer DIP switch specifications

SW6071	ON	OFF	Remarks
1	Normal		Keep it at the factory setting.
2		<u>Normal</u>	For test purposes.
3		<u>Prohibited</u>	[This sets whether to accept or prohibit the selection of the editing mode when the X-value adjustment master tape (D3 recorded tape) has been loaded.]
4		Normal	For test purposes.
6	Ejected	<u>Not ejected</u>	The D3 cassette holes are detected, and the cassette is forcibly ejected automatically.
7	—	<u>Normal</u>	For test purposes.
8	—	<u>Normal</u>	For test purposes.

History: No.6: From SYSCON Ver.0.12

The underlining indicates the factory settings.

SERVO microcomputer DIP switch specifications

SW2001	Purpose	ON	OFF
1	For AT adjustments	When adjusting	At all other times
2	For AT adjustments	When adjusting	At all other times
3	For AT adjustments	When adjusting	At all other times
4	For AT adjustments	When adjusting	At all other times

CAUTION:

These servicing instructions are for use by qualified service personnel only. To reduce the risk of electric shock do not perform any servicing other than that contained in the operating instructions unless you are qualified to do so.

Specifications

Power supply	AJ-HD3700BP: AC 120V, 50–60 Hz AJ-HD3700BE: AC 220–240V, 50–60 Hz
Power consumption:	260W

 indicates safety information.

General

Permissible ambient operating temperature	41 °F to 104 °F (5 °C to 40 °C)
Permissible ambient operating humidity	10% to 90% (no condensation)
Weight	69.96 lbs (31.8 kg)
Dimensions	16 ³ / ₄ " (W) × 8 ¹¹ / ₁₆ " (H) × 20 ¹ / ₂ " (D) mm (424 × 220 × 520 mm) (Excluding feet, jacks, jog dial and fan)
Recording formats	HD: HDD5 (Video Compression Intra-Field DCT + VLC) SD: D5 (Non-Compression Digital Component Recording)
Video signals recorded	1080/23.98p, 1080/24p, 1080/25p, 1080/59.94i, 720/59.94p, 1080/50i, 576/50i, 480/59.94i switching
Audio signals recorded	48 kHz, 20 bits, 4 channels (480/95.94i, 1080/59.94i, 720/59.94p) 48 kHz, 24 bits, 8 channels (1080/23.98p, 1080/24p, 1080/25p, 1080/50i, 1080/59.94i, 720/59.94p, 576/50i, 480/59.94i)
Recording tracks	Digital video audio: 12 tracks/field; 1080/23.98p, 1080/24p, 1080/25p, 1080/50i, 1080/59.94i, 720/59.94p, 480/59.94i 16 tracks/field; 576/50i Cue track: 1 track Time code track: 1 track Control track: 1 track
Tape speed	185.995 mm/sec. (576/50i) 167.228 mm/sec. (1080/59.94i, 720/59.94p, 480/59.94i) 139.496 mm/sec. (1080/50i, 1080/25p) 133.782 mm/sec. (1080/23.98p, 1080/24p)
Tapes used	D5 cassette tapes
Maximum recording time	When the AJ-D5C124LP is used: 112 min. (576/50i) 124 min. (1080/59.94i, 720/59.94p, 480/59.94i) 149 min. (1080/50i or 1080/25p) 155 min. (1080/23.98p, 1080/24p)
Fast forward/rewind time	Approx. 195 sec. (using AJ-D5C124LP, 1080/59.94i, 576/50i or 480/59.94i) Approx. 234 sec. (using AJ-D5C124LP, 1080/50i, 1080/25p) Approx. 244 sec. (using AJ-D5C124LP, 1080/23.98p or 1080/24p)
Search speed	Max. ±50 times normal speed (color)
AT playback range	–1 to +2 times normal speed
Editing accuracy	±0 frame (using time code)
Tape timer accuracy	±1 frame (using continuous CTL signal)
Servo lock time	Less than 1 sec. (in standby ON/2F AUTO)

Specifications

Video system

Sampling frequency/ quantizing	HD: Y: 74.176 MHz; P _B /P _R : 37.088 MHz/10 bits SD: Y: 13.5 MHz; P _B /P _R : 6.75 MHz/10 bits
Video compression system (with HD)	Intra-Field DCT + VLC
Video compression rate (with HD)	1/4
Error correction	Reed-Solomon product code
Data rates	323 Mbps (1080/59.94i/8CH, 720/59.94p/8CH, 480/59.94i/8CH) 319 Mbps (576/50i/8CH) 300 Mbps (1080/59.94i/4CH, 720/59.94p/4CH, 480/59.94i/4CH) 258 Mbps (1080/23.98p/8CH, 1080/24p/8CH) 269 Mbps (1080/50i/8CH, 1080/25p/8CH, 576/50i/8CH)
Samples × active lines (HD)	1080/59.94i, 1080/23.98p, 1080/24p, 1080/25p, 1080/50i: 1920 × 1080/frame 720/59.94p: 1280 × 720/frame
SD video format	525 lines/59.94 fields/2:1 interlace (SMPTE 259M) 625 lines/50 fields/2:1 interlace (ITU-R BT.656-4)

Input connectors

HD serial input	1.5 Gbps (Embedded Audio, TC), SMPTE 291M/292M standards complied with (BNC × 2 active through)
SD serial input	4:2:2 component SDI (SMPTE 259M/272M/ITU-R BT.656-4 standards complied) (BNC × 2 active through)
HD reference input	Analog tri-level sync ($\pm 0.3V$), loop through, 75 ohms, ON/OFF switchable (BNC × 2)
SD reference input	Analog composite, loop through, 75 ohms, ON/OFF switchable (BNC × 2)

Output connectors

HD serial output	1.5 Gbps
SD serial output	Superimposing possible for monitor OUT (BNC × 4) Component SDI output (SMPTE 259M/272M/294M*/ITU-R BT.656-4 standards complied with) (BNC × 3) Superimposing possible for monitor OUT *525p mode output (excluding monitor output) with 1080/23p or 720/59.94p system
HD reference output	Analog HD tri-level sync ($\pm 0.3 V$) (BNC × 1)
SD reference output	Black burst (BNC × 1)
Analog composite output	Video 1/video 2/video 3 (superimposing ON/OFF) (BNC × 3)

Video adjustment ranges

HD SDI Y output gain	$-\infty$ ~+3 dB
HD SDI P_B output gain	$-\infty$ ~+3 dB
HD SDI P_R output gain	$-\infty$ ~+3 dB
HD SDI Y black level	± 100 mV
HD SDI output system phase	± 0.5 H (1 sample = 13.5 ns)
SD SDI Y output gain	$-\infty$ ~+3 dB
SD SDI P_B output gain	$-\infty$ ~+3 dB
SD SDI P_R output gain	$-\infty$ ~+3 dB
SD SDI black level	± 100 mV
SD SDI output system phase	-2.5 H~+1.5 H

Specifications

Composite video output	
Y gain	−∞−+3 dB (synchronized to SD SDI)
Composite video output	
P_B/P_R gain	−∞−+3 dB (synchronized to SD SDI)
Composite video output	
setup	±14 IRE (synchronized to SD SDI)
Composite video output	
system phase	±0.5 H
Composite video output SYS	
SC phase	more than ±180 °

Audio

Sampling frequency	48 kHz (synchronized to video)
Quantizing	1080/23.98p, 1080/24p, 1080/25p, 1080/50i and 576/50i: 24 bits 20 or 24 bits selected for 1080/59i, 720/59.94p and 480/59.94i
Frequency response	20 Hz to 20 kHz ±0.5 dB (reference level)
Dynamic range	More than 100 dB (1 kHz, emphasis OFF): 20 bits More than 105 dB (1 kHz, emphasis OFF): 24 bits
Distortion	Less than 0.03% (1 kHz, emphasis OFF, reference level): 20 bits Less than 0.01% (1 kHz, emphasis OFF, reference level): 24 bits
Crosstalk	Less than −80 dB (1 kHz, between 2 channels)
Wow & flutter	Below measurable limits
Headroom	20 dB/18 dB switchable

Cue track

Frequency response	100 Hz to 12 kHz ±3.0 dB
---------------------------	--------------------------

Audio input connectors

Analog input (CH1–CH4)	+4/0/−20 dBm (dBu) switchable (with 600 Ω load), 600 Ω/high impedance (switchable) (XLR × 4)
Digital input	AES3 format (75 ohms, unbalanced) (BNC × 4)
(CH1/CH2, CH3/CH4, CH5/CH6, CH7/CH8)	(No operation for CH5/CH6 and CH7/CH8 in 480/59.94i/4CH, 1080/59i/4CH or 720/59p/4CH format)
Cue track input	+4/0/−20 dBm (dBu) switchable (with 600 Ω load), 600 Ω/high impedance (switchable) (XLR × 1)

Audio output connectors

Analog output (CH1–CH4)	+4/0/−20 dBm (dBu) switchable (with 600 Ω load), low impedance (XLR × 4)
Digital output	AES3 format (75 ohms, unbalanced) (BNC × 4)
(CH1/CH2, CH3/CH4, CH5/CH6, CH7/CH8)	[When the 1080/59.94i/4CH, 720/59p/4CH or 480/59.94i/4CH format is selected, either no sound is output or the sound of CH1/CH2 and CH3/CH4 is copied and output as the sound for CH5/CH6 and CH7/CH8. (AUTO COPY function)]
Cue track output	+4/0/−20 dBm (dBu) switchable (with 600 Ω load), low impedance (XLR × 1)
Monitor output	L/R, +4/0/−20 dBm (dBu) switchable (with 600 Ω load), low impedance (XLR × 2)
Headphone output	Level variable

(dBu): applied for AJ-HD3700BE.

Specifications

Audio adjustment ranges

Audio input gain	$-\infty$ – $+12$ dB
Audio output gain	$-\infty$ – $+12$ dB
Monitor output gain	$-\infty$ – $+12$ dB (when coupled to headphone control)
Headphone output gain	$-\infty$ – $+12$ dB

Other input/output signals

Time code input	2.4 V \pm 1.4 V [p-p], 10 k Ω , balanced (XLR \times 1)
Time code output	2.0 V \pm 0.5 V [p-p], low impedance, balanced (XLR \times 1)
RS-422A input	RS-422A interface (D-Sub 9P \times 1)
RS-422A output	RS-422A interface (D-Sub 9P \times 1)
RS-422A input/output	RS-422A interface (D-Sub 9P \times 1)
RS-232C	RS-232C interface (D-Sub 25P \times 1)
Parallel input/output	Parallel communication (D-Sub 50P \times 1)
V/A control	Video remote control (D-Sub 15P \times 1)
Control panel	For connecting front control panel (20P \times 1)

Accessory (supplied)

Power cord (1)

Optional accessory

AJ-MA37P Rack-mounting adapter

Weight and dimensions when shown are approximate.
Specifications are subject to change without notice.

Panasonic

PANASONIC BROADCAST & TELEVISION SYSTEMS COMPANY
UNIT COMPANY OF MATSUSHITA ELECTRIC CORPORATION OF AMERICA

Executive Office:

One Panasonic Way 4E-7, Secaucus, NJ 07094 (201) 348-7000

EASTERN ZONE:

One Panasonic Way 4E-7, Secaucus, NJ 07094 (201) 348-7621

Southeast Region:

1225 Northbrook Parkway, Ste 1-160, Suwanee, GA 30024 (770) 338-6835

Central Region:

1707 N Randall Road E1-C-1, Elgin, IL 60123 (847) 468-5200

WESTERN ZONE:

3330 Cahuenga Blvd W., Los Angeles, CA 90068 (323) 436-3500

Government Marketing Department:

52 West Gude Drive, Rockville, MD 20850 (301) 738-3840

Broadcast PARTS INFORMATION & ORDERING:

9:00 a.m.–5:00 p.m. (EST) (800) 334-4881/24 Hr. Fax (800) 334-4880

Emergency after hour parts orders (800) 334-4881

TECHNICAL SUPPORT:

Emergency 24 Hour Service (800) 222-0741

Panasonic Canada Inc.

5770 Ambler Drive, Mississauga, Ontario L4W 2T3 (905) 624-5010

Panasonic de Mexico S.A. de C.V.

Av angel Urraza Num. 1209 Col. de Valle 03100 Mexico, D.F. (52) 1 951 2127

Panasonic Sales Company

Division of Matsushita Electric of Puerto Rico Inc.

San Gabriel Industrial Park, 65th Infantry Ave., Km. 9.5, Carolina, Puerto Rico 00630 (787) 750-4300

Panasonic Broadcast Europe

Panasonic Broadcast Europe Ltd.

West Forest Gate, Wellington Road, Wokingham, Berkshire RG40 2AQ U.K. Tel: 0118 902 9200

Panasonic Broadcast Europe GmbH

Hagenauer Str. 43, 65203 Wiesbaden-Biebrich Deutschland Tel: 49-611-1816-0