

Panasonic

Operating Instructions

Multi-format Live Switcher

Model No. **AV-HS400AE**

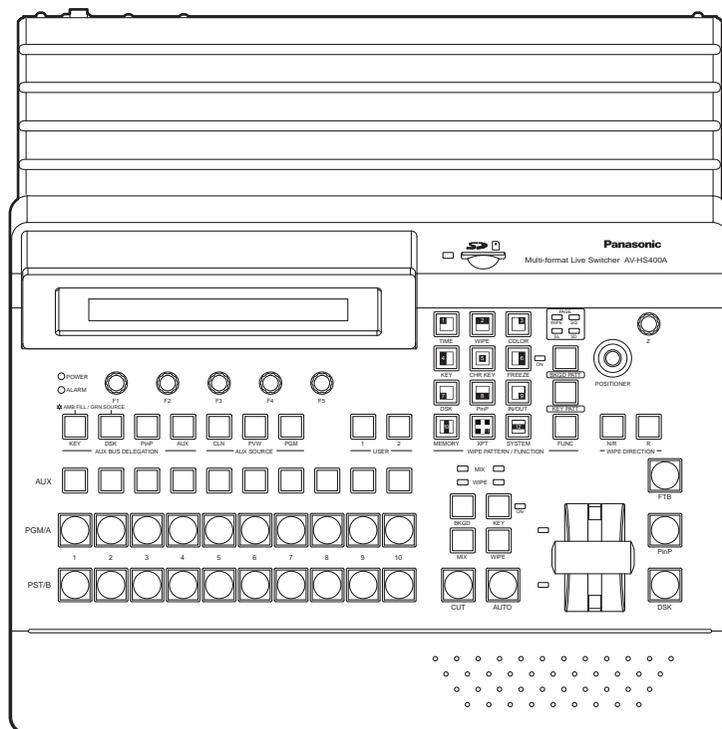

Before operating this product, please read the instructions carefully and save this manual for future use.

Safety precautions

FOR YOUR SAFETY PLEASE READ THE FOLLOWING TEXT CAREFULLY

	CAUTION RISK OF ELECTRIC SHOCK DO NOT OPEN	
CAUTION: TO REDUCE THE RISK OF ELECTRIC SHOCK, DO NOT REMOVE COVER (OR BACK). NO USER SERVICEABLE PARTS INSIDE. REFER TO SERVICING TO QUALIFIED SERVICE PERSONNEL.		

 The lightning flash with arrowhead symbol, within an equilateral triangle, is intended to alert the user to the presence of uninsulated “dangerous voltage” within the product’s enclosure that may be of sufficient magnitude to constitute a risk of electric shock to persons.

 The exclamation point within an equilateral triangle is intended to alert the user to the presence of important operating and maintenance (service) instructions in the literature accompanying the appliance.

WARNING:

■ THIS APPARATUS MUST BE EARTHED

To ensure safe operation, the three-pin plug must be inserted only into a standard three-pin power point which is effectively earthed through the normal household wiring.

Extension cords used with the apparatus must have three cores and be correctly wired to provide connection to the earth. Wrongly wired extension cords are a major cause of fatalities.

The fact that the apparatus operates satisfactorily does not imply that the power point is earthed or that the installation is completely safe. For your safety, if you are in any doubt about the effective earthing of the power point, please consult a qualified electrician.

WARNING:

- TO REDUCE THE RISK OF FIRE OR ELECTRIC SHOCK, DO NOT EXPOSE THIS APPARATUS TO RAIN OR MOISTURE.
- THE APPARATUS SHALL NOT BE EXPOSED TO DRIPPING OR SPLASHING AND THAT NO OBJECTS FILLED WITH LIQUIDS, SUCH AS VASES, SHALL BE PLACED ON THE APPARATUS.

CAUTION:

TO REDUCE THE RISK OF FIRE OR SHOCK HAZARD AND ANNOYING INTERFERENCE, USE THE RECOMMENDED ACCESSORIES ONLY.

CAUTION:

In order to maintain adequate ventilation, do not install or place this unit in a bookcase, built-in cabinet or any other confined space. To prevent risk of electric shock or fire hazard due to overheating, ensure that curtains and any other materials do not obstruct the ventilation.

The socket outlet shall be installed near the equipment and easily accessible or the mains plug or a power switch shall remain readily operable.

A warning that an apparatus with CLASS I construction shall be connected to a MAINS socket outlet with a protective earthing connection.

 indicates safety information.

Safety precautions

Caution for AC Mains Lead

FOR YOUR SAFETY PLEASE READ THE FOLLOWING TEXT CAREFULLY.

This product is equipped with 2 types of AC mains cable. One is for continental Europe, etc. and the other one is only for U.K.

Appropriate mains cable must be used in each local area, since the other type of mains cable is not suitable.

FOR CONTINENTAL EUROPE, ETC.

Not to be used in the U.K.

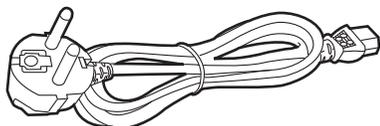

FOR U.K. ONLY

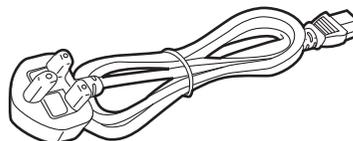

FOR U.K. ONLY

This appliance is supplied with a moulded three pin mains plug for your safety and convenience.

A 13 amp fuse is fitted in this plug.

Should the fuse need to be replaced please ensure that the replacement fuse has a rating of 13 amps and that it is approved by ASTA or BSI to BS1362.

Check for the ASTA mark  or the BSI mark  on the body of the fuse.

If the plug contains a removable fuse cover you must ensure that it is refitted when the fuse is replaced.

If you lose the fuse cover the plug must not be used until a replacement cover is obtained.

A replacement fuse cover can be purchased from your local Panasonic Dealer.

IF THE FITTED MOULDED PLUG IS UNSUITABLE FOR THE SOCKET OUTLET IN YOUR HOME THEN THE FUSE SHOULD BE REMOVED AND THE PLUG CUT OFF AND DISPOSED OF SAFELY. THERE IS A DANGER OF SEVERE ELECTRICAL SHOCK IF THE CUT OFF PLUG IS INSERTED INTO ANY 13 AMP SOCKET.

If a new plug is to be fitted please observe the wiring code as shown below.

If in any doubt please consult a qualified electrician.

WARNING: This apparatus must be earthed.

IMPORTANT

The wires in this mains lead are coloured in accordance with the following code.

Green-and-Yellow:	Earth
Blue:	Neutral
Brown:	Live

As the colours of the wire in the mains lead of this appliance may not correspond with the coloured markings identifying the terminals in your plug, proceed as follows.

- The wire which is coloured **green-and-yellow** must be connected to the terminal in the plug which is marked with the letter **E** or by the earth symbol  or coloured **green** or **green-and-yellow**.
- The wire which is coloured **blue** must be connected to the terminal in the plug which is marked with the letter **N** or coloured **black**.
- The wire which is coloured **brown** must be connected to the terminal in the plug which is marked with the letter **L** or coloured **red**.

How to replace the fuse

1. Open the fuse compartment with a screwdriver.

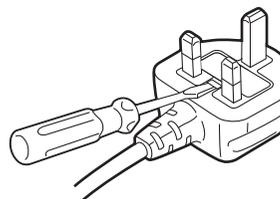

2. Replace the fuse.

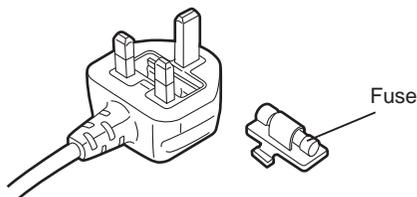

 indicates safety information.

Safety precautions

Information for Users on Collection and Disposal of Old Equipment and used Batteries



These symbols on the products, packaging, and/or accompanying documents mean that used electrical and electronic products and batteries should not be mixed with general household waste. For proper treatment, recovery and recycling of old products and used batteries, please take them to applicable collection points, in accordance with your national legislation and the Directives 2002/96/EC and 2006/66/EC.



By disposing of these products and batteries correctly, you will help to save valuable resources and prevent any potential negative effects on human health and the environment which could otherwise arise from inappropriate waste handling.

For more information about collection and recycling of old products and batteries, please contact your local municipality, your waste disposal service or the point of sale where you purchased the items.

Penalties may be applicable for incorrect disposal of this waste, in accordance with national legislation.



For business users in the European Union

If you wish to discard electrical and electronic equipment, please contact your dealer or supplier for further information.

[Information on Disposal in other Countries outside the European Union]

These symbols are only valid in the European Union. If you wish to discard these items, please contact your local authorities or dealer and ask for the correct method of disposal.



Note for the battery symbol (bottom two symbol examples):

This symbol might be used in combination with a chemical symbol. In this case it complies with the requirement set by the Directive for the chemical involved.

Cd

Contents

Description	7	3-4. PinP (picture in picture).....	40
Features	7	3-4-1. Selecting the PinP material	40
Precautions for use	8	3-4-2. PinP transitions.....	40
1. Functions in each area	9	3-4-3. PinP preview.....	40
1-1. Control panel.....	9	3-4-4. PinP adjustments.....	41
1-2. Crosspoint area.....	10	3-4-5. PinP decorations.....	42
1-3. Wipe area	11	3-4-6. Trimming settings.....	43
1-4. User button area.....	12	3-5. DSK (downstream key).....	44
1-5. Transition area	13	3-5-1. Selecting the DSK type.....	44
1-6. LCD menu area.....	15	3-5-2. Selecting the DSK material.....	45
1-7. Positioner area	16	3-5-3. DSK transitions	46
1-8. SD memory card area.....	17	3-5-4. DSK preview	46
1-9. Rear panel connections area	18	3-5-5. DSK adjustments.....	46
2. System	20	3-5-6. DSK decorations.....	47
2-1. Configuration.....	20	3-5-7. Masking the DSK signals.....	48
2-2. Connections	21	3-6. FTB (fade to black).....	49
3. Basic operations	23	3-7. Internal colour signals	50
3-1. Background transition.....	23	3-7-1. Setting the colour background	50
3-1-1. Selecting the bus	23	3-8. Freezing the input signals	51
3-1-2. Selecting the bus mode	23	3-8-1. Displaying the freeze status.....	51
3-1-3. Selecting the transition mode	24	3-8-2. Setting freeze.....	51
3-1-4. Manual transition (using the fader lever)....	24	3-9. Switching the AUX output.....	52
3-1-5. Auto transition.....	24	3-10. Preset memory.....	53
3-1-6. Cut transition.....	24	3-11. Frame memories	56
3-2. Wipe	25	3-11-1. Transferring images from the AUX bus ...	56
3-2-1. Selecting the wipe pattern	25	3-12. SD memory cards	57
3-2-2. Selecting the wipe direction.....	26	3-12-1. Initializing the SD memory cards	58
3-2-3. Wipe decorations (border, soft effect)	26	3-12-2. Saving data on SD memory cards.....	59
3-2-4. Setting the wipe start position.....	27	3-12-3. Loading data from SD memory cards.....	60
3-2-5. Modifying wipe.....	28	3-12-4. Deleting files on SD memory cards	61
3-3. Key	29	3-12-5. Displaying the SD memory card information.....	61
3-3-1. Selecting the key type.....	30		
3-3-2. Selecting the key material.....	31		
3-3-3. Key transitions	32		
3-3-4. Key preview.....	33		
3-3-5. Adjusting the luminance key and linear key ...	33		
3-3-6. Adjusting the chroma key	34		
3-3-7. Key decorations	37		
3-3-8. Masking the key signals.....	38		
3-3-9. Flying key.....	39		

Contents

4. Input/output signal settings.....	62	5. System settings	84
4-1. Setting the SDI input signals and analogue input signals	62	5-1. Selecting the video format.....	84
4-1-1. Setting the frame synchronizer	62	5-2. Setting the crosspoints	85
4-1-2. Setting the input mode.....	63	5-2-1. Assigning signals to the crosspoints.....	85
4-1-3. Setting the analogue input gain	64	5-2-2. Setting the crosspoint switching	86
4-1-4. Setting the analogue composite input signals.....	64	5-3. Button assignments.....	87
4-2. Setting the up-converter (option).....	65	5-3-1. Setting the user buttons.....	87
4-3. Setting the DVI input signals (option)	66	5-3-2. Setting the FTB button.....	87
4-3-1. Setting the DVI input signals.....	66	5-4. Setting the date and time	88
4-3-2. Adjusting the DVI input signals	68	5-5. Network settings.....	89
4-4. Setting the output signals.....	69	5-6. Other settings.....	90
4-4-1. Types of output signals	69	5-6-1. Setting the LCD backlight	90
4-4-2. Assigning the output signals.....	70	5-6-2. Setting editor enable.....	90
4-5. Setting the sync signals.....	71	5-6-3. Setting the protocol.....	90
4-6. Adjusting the output signal phase	72	5-6-4. Setting the GPI	91
4-7. Setting the multi view display	76	5-7. Camera control.....	92
4-7-1. Setting the screen layout	76	5-8. Status displays	98
4-7-2. Setting the split frame and characters	78	5-8-1. Alarm status displays.....	98
4-7-3. Setting the tally displays	78	5-8-2. Displaying the version information and option information	99
4-7-4. Changing the material names.....	79	5-9. Initialization.....	100
4-8. Setting the on-screen display (OSD).....	80	6. External interfaces	101
4-9. Setting the DVI output signals (option)	81	6-1. RS-422 connector	101
4-10. Setting the ancillary data.....	82	6-2. GPI connector	102
4-11. Setting the down-converter	83	6-3. Tally connector.....	103
		7. Image transmission functions.....	104
		8. Setting menu table.....	109
		9. Appearance	116
		10. Specifications and standard accessories	117
		Appendix (glossary).....	120

Description

This is a 1 ME digital video switcher which supports a multiple number of HD and SD formats.

Despite its compact dimensions, the video switcher comes standard with 4 input connectors and can support 8 input connectors when an option board is used.

It also has a multi view display function that allows split-screen display with up to 10 screens.

It is capable of providing transitions (wipe, mix and DVE) as video effects, and keyer (luminance keys and chroma keys), DSK and PinP specialized hardware is provided as a standard feature to enable video productions in many different forms.

The unit also supports SD memory cards so still image data (BMP, JPEG) can be imported from SD memory cards into the unit's frame memories for use as background images or key materials.

Features

Compact design, wide variety of input/output signals

- As a standard feature, the HD and SD-SDI formats are supported for the input and output signals. If an optional board is added, HD/SD analogue component, DVI-I and analogue composite (input only) signals can also be accommodated.

The input optional board contains an up-converter.

The SDI output board (option) also contains a down-converter.

- Under the standard specifications, there are four SDI lines for the input signals, and this number can be optionally increased by the user up to eight lines (supported by the optional board). Similarly, there are three SDI lines for the output signals under the standard specifications, and this number can be optionally increased by the user to five lines (PGM, PVW, AUX, KEYOUT and multi view display).

Multiple formats supported

Both HD formats (1080/59.94i, 1080/50i, 720/59.94p and 720/50p) and SD formats (480/59.94i and 576/50i) as well as the DVI-I format are supported for the signals.

Multi view display function

This unit enables up to 10 lines of programme video (PGM), preview video (PVW) and input video signals to be displayed altogether on a single screen at the same time.

Frame synchronizer system and external synchronization system supported

- A high-performance 10-bit frame synchronizer is incorporated for all the inputs, and asynchronous video signals can be input. By using the black burst (BB) output, it is possible to construct a system referenced to the synchronization of the switcher.
- A genlock function is provided, and an external synchronization system using external sync signals (BB or TRI signals) as a reference are also supported.

Many different effect functions incorporated

- Along with the standard wipe, mix and cut functions, the unit can provide size reduction, slide and other DVE transitions.
- The unit comes with luminance keys and chroma keys are provided as keyers as well as specialized hardware in the form of the DSK (downstream key) and PinP (picture in picture) functions as a standard option, enabling video productions in many different forms.

SD memory cards supported

Still image data (BMP, JPEG) can be imported from SD memory cards into the unit's frame memories for use as background images or key materials. Conversely, the images or setting data in the unit's frame memories can be stored on the SD memory cards.

Simple operations

Live transmissions can be delivered speedily thanks to the simple panel layout which enables the various functions to be operated directly.

Presetting and other similar operations are performed using menus on the unit's LCD screen or in the form of on-screen displays (OSD) which appear on an external monitor.

Precautions for use

- **Handle carefully.**

Do not drop the product, or subject it to strong shock or vibration.
Do not carry or move the product by the fader lever. This is important to prevent trouble.

- **Use the product in an ambient temperature of 32 °F to 104 °F (0 °C to 40 °C).**

Avoid using the product at a cold place below 32 °F (0 °C) or at a hot place above 104 °F (40 °C) because extremely low or high temperature will adversely affect the parts inside.

- **Power off before connecting or disconnecting cables.**

Before plugging or unplugging the cables, be sure to switch power off.

- **Avoid humidity and dust.**

Avoid using the product at a humid, dusty place because much humidity and dust will cause damage to the parts inside.

- **Maintenance**

Wipe the product using a dry cloth. To remove stubborn dirt, dip a cloth into a diluted solution of kitchen detergent (neutral), wring it out well, and wipe the product gently. Then, after wiping the product with a moist cloth, wipe it again with a dry cloth.

Caution

- Avoid using benzene, paint thinners and other volatile fluids.
- If a chemical cleaning cloth is to be used, carefully read through the precautions for its use.

- **Precaution to be observed during production**

This product's image switching and image effect functions can be used to produce images which flicker rapidly or images which change rapidly.

However, bear in mind when using these functions in production that the kinds of images produced may have an adverse effect on the viewer's physical well-being.

- **Handling the optional boards**

Be absolutely sure to turn off the power of the product before installing or removing any of the optional boards. Furthermore, when installing or removing the optional boards, take care not to hurt yourself on the edges and metal parts of the boards.

- **When the product is to be discarded**

When the product is to be discarded at the end of its service life, ask a specialized contractor to dispose of it properly in order to protect the environment.

- **Concerning the consumable parts**

Cooling fan:

This is a consumable part. As a general rule, replace it every 5 years or so (when the unit has been operated for 15 hours a day).

Power supply unit:

This is a consumable part. As a general rule, replace it every 5 years or so (when the unit has been operated for 15 hours a day).

The period when the consumable parts need to be replaced will differ depending on the operating conditions.

When the time comes to replace one of these parts, be absolutely sure to ask your dealer to do the job.

1. Functions in each area

1-1. Control panel

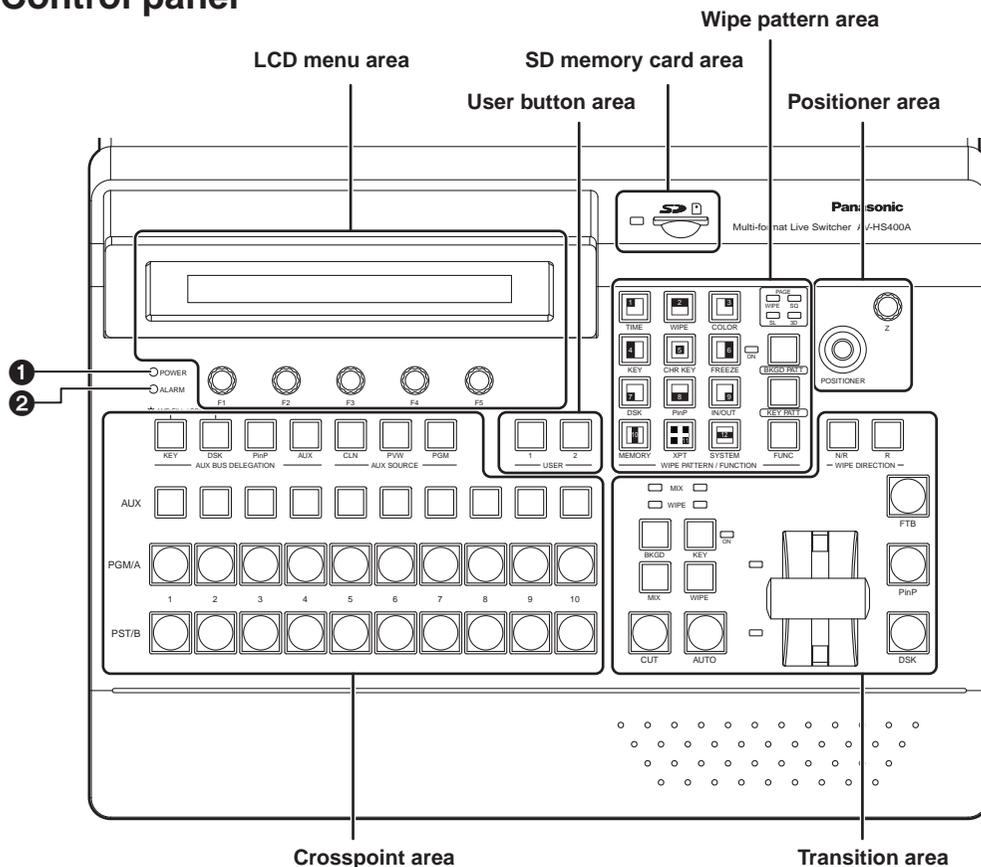

1 Power indicator [POWER]

This indicator lights when the power switch (47) on the rear panel is set to ON while power is supplied to the AC power input socket.

It goes off when the power switch (47) is set to OFF.

2 Alarm indicator [ALARM]

This indicator lights when the fan is stopped or there is a problem with the power supply (such as a drop in voltage).

When an alarm has occurred, the type of trouble can be checked on the System/Alarm (8/16) menu.

In addition, an alarm message is displayed on the LCD screen and the OSD screen of the external monitor.

ALARM TYPE	System/Alarm (8/16)	ALARM MESSAGE
Fan alarm	Alarm display in Fan items	ALARM! FAN STOP
Power alarm	Alarm display in Power items	ALARM! POWER FAILURE
Power alarm and fan alarm	Alarm display in Fan items and Power items	ALARM! POWER FAILURE & FAN STOP

If the alarm goes off, stop using the unit immediately and be sure to contact your dealer.

Continuing to use the unit even after the alarm goes off could damage it.

1. Functions in each area

1-2. Crosspoint area

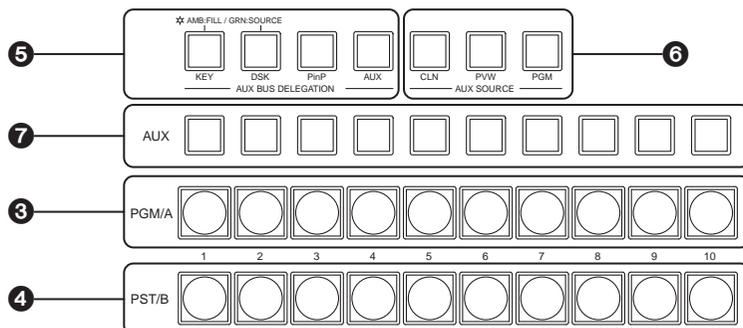

③ PGM/A bus crosspoint buttons [PGM/A 1 to 10]

These are used to select the PGM/A bus video signals. In the case of the flip-flop system, the main line video (PGM) signals are always selected.

④ PST/B bus crosspoint buttons [PST/B 1 to 10]

These are used to select the PST/B bus video signals. In the case of the flip-flop system, the images inserted next (PST) are always selected.

⑤ AUX bus selector buttons [KEY, DSK, PinP, AUX]

Press the [KEY] button, [DSK] button, [PinP] button or [AUX] button to switch the bus which is selected using the AUX bus crosspoint buttons (⑦). The indicator of the button that was pressed lights.

[KEY]: Press this button to switch the AUX bus crosspoint buttons to the key fill bus or key source bus.

(Each time the button is pressed, the key fill bus or key source bus is selected alternately. When the key fill bus is selected, the indicator of the button lights in amber, and when the key source bus is selected, it lights in green.)

[DSK]: Press this button to switch the AUX bus crosspoint buttons to the DSK fill bus or DSK source bus.

(Each time the button is pressed, the DSK fill bus or DSK source bus is selected alternately. When the DSK fill bus is selected, the indicator of the button lights in amber, and when the DSK source bus is selected, it lights in green.)

[PinP]: Press this button to switch the AUX bus crosspoint buttons to the PinP bus.

[AUX]: Press this button to switch the AUX bus crosspoint buttons to the AUX bus.

⑥ AUX bus dedicated crosspoint buttons [CLN, PVW, PGM]

These buttons are used to select the AUX bus source while the indicator of the [AUX] button is lit. The indicator of the pressed button lights in amber.

[CLN]: The clean signals (images whose DSK signals have been removed from the PGM signals) are output to the AUX bus.

[PVW]: PVW signals are output to the AUX bus.

[PGM]: PGM signals are output to the AUX bus.

⑦ AUX bus crosspoint buttons

These buttons are used to select the source of the bus which was selected by the AUX bus selector button (⑤).

1. Functions in each area

1-3. Wipe area

8 Wipe pattern selector buttons

These 12 buttons are used to select the corresponding wipe patterns while the indicator of the [BKGD PATT] button (9) or [KEY PATT] button (9) is lit.

They are used to select the corresponding setting menus when the indicator of the FUNC button (11) is lit.

The indicator of the selected button lights in amber.

9 BKGD, KEY pattern selector buttons

These buttons are used to switch the wipe pattern selection.

The wipe pattern of a background transition is selected when the indicator of the [BKGD PATT] button is lit after it was pressed.

The wipe pattern of a key transition is selected when the indicator of the [KEY PATT] button is lit after it was pressed.

Each time the [BKGD PATT] button or [KEY PATT] button is pressed, the pattern page is changed in the sequence of WIPE, SQ (squeeze), SL (slide) and 3D (3 dimensions), and the pattern page indicator LED (10) is also switched.

10 Pattern page indicator LEDs

These LEDs indicate the pages selected by the background transitions while the indicator of the [BKGD PATT] button is lit.

They indicate the pages selected by the key transitions while the indicator of the [KEY PATT] button is lit.

The WIPE, SQ (squeeze), SL (slide) or 3D (3 dimensions) LED lights.

11 FUNC button

When this button is pressed, its indicator lights in amber. When a wipe pattern selector button (8) is pressed while the indicator of the FUNC button is lit, the setting menu indicated below the button is displayed on the LCD screen.

[TIME]:	The auto transition time settings are performed.	☞ See 3-1-5.
[WIPE]:	The modify, border or soft effect decoration settings are performed for wipe.	☞ See 3-2.
[COLOR]:	The colour background settings are performed.	☞ See 3-7.
[KEY]:	The key settings are performed.	☞ See 3-3.
[CHR KEY]:	The chroma key settings are performed.	☞ See 3-3-6.
[FREEZE]:	The freeze status is displayed and freeze settings are performed.	☞ See 3-8.
[DSK]:	DSK settings are performed.	☞ See 3-5.
[PinP]:	PinP settings are performed.	☞ See 3-4.
[IN/OUT]:	The input/output signals are set.	☞ See 4.
[MEMORY]:	The preset memory, frame memory or SD memory card settings are performed.	☞ See 3-10, 3-11 and 3-12.
[XPT]:	The crosspoint assignment is displayed and set.	☞ See 5-2.
[SYSTEM]:	The system settings are performed.	☞ See 5.

12 Freeze status indicator LED

When this LED is lit, it means that one of the input signals is in the freeze status.

The freeze status of the input signals assigned to the crosspoint buttons can be checked on the menu.

☞ See 3-8.

Since the freeze status is established while this indicator is lit, the input image handled inside the unit will remain unchanged even when a different image is input.

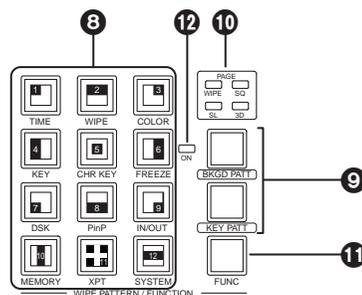

1. Functions in each area

1-4. User button area

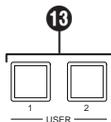

13 User buttons [USER 1, USER 2]

These are used to allocate some functions of the menu settings to the USER 1 button and USER 2 button.

☞ See 5-3-1.

1. Functions in each area

1-5. Transition area

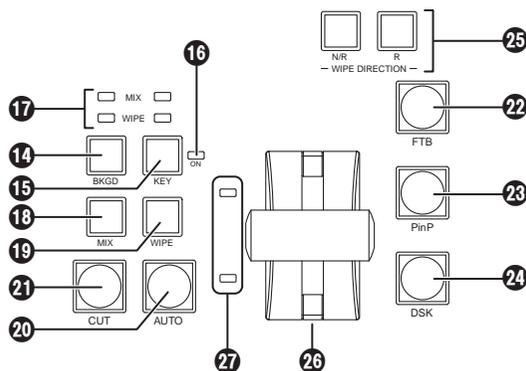

14 [BKGD] button

This executes the background transition when the [AUTO] button (20) or fader lever (26) has been operated. When the [BKGD] button is pressed and it is selected, its indicator lights in amber. If the [KEY] button (15) is now pressed, the indicator goes off, and the de-selected status is established. When the [BKGD] button and [KEY] button (15) are pressed at the same time, both buttons are set to the selected status.

15 [KEY] button

This executes the key transition when the [AUTO] button (20) or fader lever (26) has been operated. When the [KEY] button is pressed and it is selected, its indicator lights in amber. If the [BKGD] button (14) is now pressed, the indicator goes off, and the de-selected status is established. When the [BKGD] button (14) and [KEY] button are pressed at the same time, both buttons are set to the selected status.

16 KEY ON tally LED

This lights in red when the key ON status is established.

17 MIX, WIPE selection status tally LEDs

These light up to indicate whether MIX or WIPE has been selected when background transitions or key transitions are executed.

18 [MIX] button

This is used to switch the A and B bus images while making them overlap. During the transition, the A and B bus output total is kept at 100 %. When the [MIX] button is pressed and it is selected, its indicator lights in amber. If the [WIPE] button (19) is now pressed, it goes off, and the de-selected status is established.

19 [WIPE] button

This is used to execute the transition using the pattern selected by the wipe pattern selector button (3). When the [WIPE] button is pressed and it is selected, its indicator lights in amber. If the [MIX] button (18) is now pressed, it goes off, and the de-selected status is established.

1. Functions in each area

20 [AUTO] button

This is used to automatically execute transitions (auto transition) using the transition time which has been set. During auto transition its indicator lights in amber. When the button is pressed again during auto transition, the auto transition operation is suspended, and the indicator lights in green. When it is pressed again while auto transition is suspended, the remaining transition is executed.

The indicator goes off when auto transition is completed.

When the [AUTO] button is pressed while the fader lever (26) is at an interim setting, the transition is executed in the time remaining from the interim setting.

21 [CUT] button

This button is used to execute transitions instantly.

Its indicator lights in amber during a transition, and it goes off when the transition is completed.

22 [FTB] button

This button is used to execute fade-out to a black screen or fade-in from a black screen for the transition time which has been set.

23 [PinP] button

This button is used to execute fade-in or fade-out of the picture in picture for the transition time which has been set.

24 [DSK] button

This button is used to execute fade-in or fade-out of downstream key for the transition time which has been set.

25 Wipe direction selection buttons

These buttons are used to select the direction in which to wipe for executing background transitions.

When the [R] indicator is off:

Wiping proceeds in the normal direction.

When the [R] indicator is lit:

Wiping proceeds in the reverse direction.

When the [N/R] indicator is lit:

The normal direction is replaced with the reverse direction (or vice versa) when the transition is completed. (The lit and extinguished statuses of the [R] button are also switched in line with the direction of the wiping.)

26 Fader lever

This is used to execute background or key transitions. When it is moved as far as it will go, the transition is completed. When it has been operated during auto transition, auto transition will be switched to manual operation as soon as the fader position overtakes the amount of the transition being executed.

27 Bus tally LEDs

These indicate the output statuses of the A bus and B bus. The LED corresponding to the bus whose programme signals (PGM) are being output lights.

1. Functions in each area

1-6. LCD menu area

28 LCD

The setting menus are displayed on the LCD.
 When the [FUNC] button (1) is pressed and its indicator is lit and then one of the wipe pattern selector buttons (8) is pressed, the setting menu is displayed.
 When the buttons listed below are double-clicked, the specified menu is selected. (The menu delegation function)
 The operation corresponding to the button pressed is also executed.

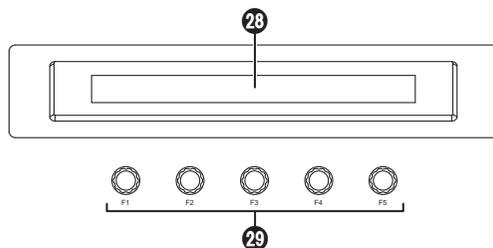

<List of menu delegation functions>

	Button	Menu
Crosspoint area (AUX bus selector buttons)	KEY	KEY menu/Adjust sub menu (2/9) CHR KEY menu/Auto sub menu (1/3) (with chroma key selection)
	DSK	DSK menu/Adjust sub menu (2/7)
	PinP	PinP menu/Position sub menu (4/6)
Transition area	BKGD	TIME menu/BKGD sub menu (1/5)
	KEY	TIME menu/KEY sub menu (2/5)
	WIPE	WIPE menu/Border sub menu (1/5)
Wipe pattern area	WIPE #5	WIPE menu/WIPEPos sub menu (3/5) (BKGD or KEY)
	SQ #5	WIPE menu/SQPos sub menu (4/5) (BKGD or KEY)
	SL #5	KEY menu/FlyKEY sub menu (9/9) (KEY)

29 Rotary encoders [F1] to [F5]

These are used to set the parameters displayed on the menus (LCD screen or external monitor).
 For details on the operations, refer to the sections in "3. Basic operations".

[F1]: Rotate this rotary encoder to switch the sub menu.

[F2] to [F5]: Rotate these rotary encoders to set the parameters.

When the down arrow (↓) is shown at a menu item, its parameter is set by pressing the corresponding rotary encoder.

When the parameter is one which is set using a numerical value, its default will be restored when the rotary encoder is held down.

(However, the network settings and the date and time settings will not be returned to the defaults.)

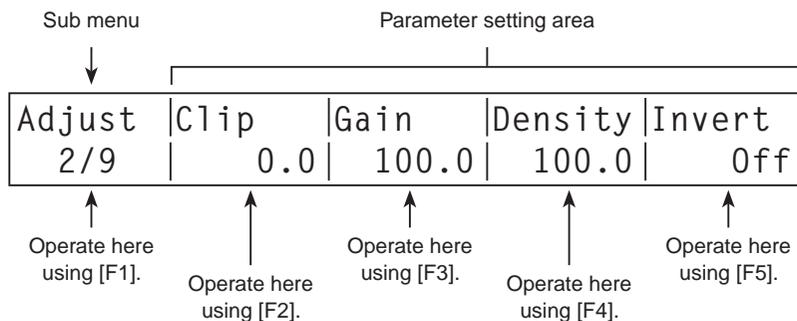

1. Functions in each area

1-7. Positioner area

30 Positioner [X/Y]

These are used when performing the settings below.

- PinP position setting
- Wipe start position setting (WIPE, SQ #5)
- Camera control
- Flying key position setting
- Chroma key area

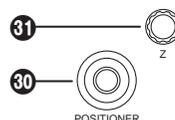

In each case, the settings take effect only when the following menu items have been selected.

The centre values of the positioner are set during the time it takes for the unit to start up after its power is turned on. Do not operate the positioner until after the switcher has started up.

31 Rotary encoder [Z]

This is used to set the PinP size, flying key size or to select the chroma key area.

In each case, the settings take effect only when the following menu items have been selected.

	Positioner	Rotary encoder		Valid menu
	X/Y	Z	Switch	
PinP	Position adjustments	Size adjustments (size increased by rotating the encoder clockwise and reduced by rotating it counterclockwise)	Hold switch down to restore initial values (X/Y, Z).	All PinP menus
Wipe	Start position adjustments	—	Hold switch down to restore initial values (X/Y).	WIPE/WIPEPos WIPE/SQPos
Chroma key	Selected area position adjustments	Selected area size adjustments (size increased by rotating the encoder clockwise and reduced by rotating it counterclockwise)	Hold switch down to restore initial values (X/Y, Z).	CHR KEY/Auto (only when Marker item is set to On)
Flying key	Position adjustments	Size adjustments (size increased by rotating the encoder clockwise and reduced by rotating it counterclockwise)	Hold switch down to restore initial values (X/Y, Z).	KEY/FlyKEY
Camera control	X: Pan control or focus control Y: Tilt control or zoom control	—	Switching between pan/tilt control and zoom/focus control	System/CamCTL1 System/CamCTL2

1. Functions in each area

1-8. SD memory card area

③② SD memory card slot

The SD memory card (sold separately) is inserted into this slot.

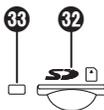

SD Logo is a trademark.

③③ SD memory card access LED

This LED lights while the data on the SD memory card is being accessed.

Do not turn off the unit's power or eject the SD memory card while the access LED is lit.

Doing so can damage the data on the SD memory card.

■ Concerning the recommended SD memory cards

Use of the following SD memory cards made by Panasonic Corporation is recommended.

RP-SD128B, RP-SD256B, RP-SDR512,
RP-SDR01G, RP-SDM01G, RP-SDM02G

1. Functions in each area

1-9. Rear panel connections area

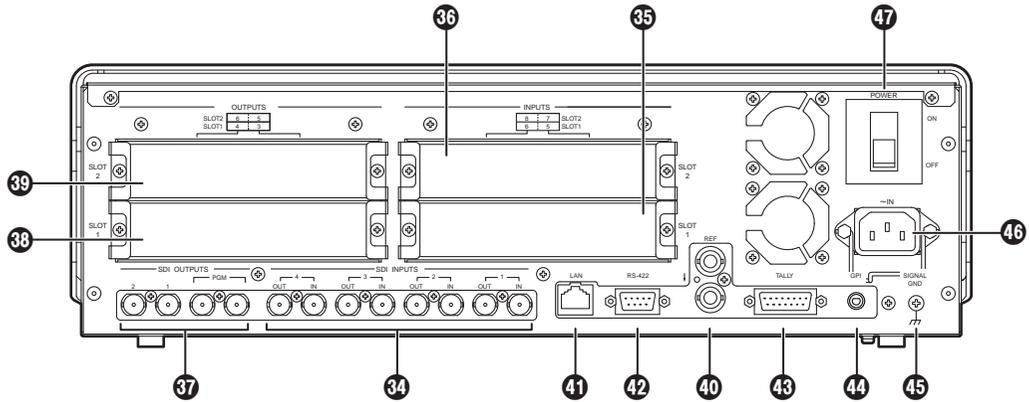

34 SDI signal input connectors [SDI INPUTS 1 to 4]

IN: SDI signal input

OUT: active through output (Use this as a monitor output application.)

35 Optional input connector SLOT1 [INPUTS 5, 6] (optional)

36 Optional input connector SLOT2 [INPUTS 7, 8] (optional)

A board (with built-in up-converter), whether an SDI input board, analogue input board, DVI input board or analogue composite input board, can be connected to each of these slots.

For further details, refer to the operating instructions of the optional board concerned.

37 SDI signal output connectors [SDI OUTPUTS PGM, 1, 2]

PGM: PGM output connectors

1, 2: The signals for these connectors can be assigned using a menu.

38 Optional output connector SLOT1 [OUTPUTS 3, 4] (optional)

39 Optional output connector SLOT2 [OUTPUTS 5, 6] (optional)

A board, whether an analogue output board, DVI/analogue output board or SDI output board (with built-in down-converter), can be connected to each of these slots.

For further details, refer to the operating instructions of the optional board concerned.

40 Reference input connector/BB output connector [REF]

Loop-through output in the external sync mode.

If the loop-through output is not going to be used, provide a 75-ohm termination.

BB signals output from both connectors in the internal sync mode.

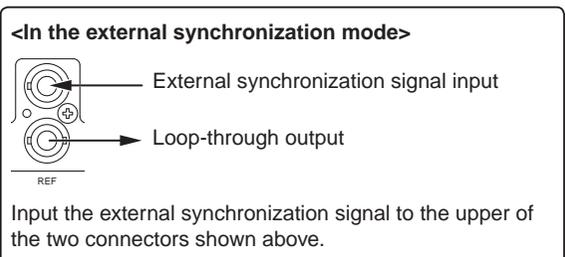

1. Functions in each area

41 LAN connector [LAN] (RJ-45) (10BASE-T)

42 RS-422 interface connector [RS-422] (D-sub 9-pin, female, inch screw)

☞ For details on connection, refer to “6. External interfaces”.

43 Tally output connector [TALLY] (D-sub 15-pin, male, inch screw)

☞ For details on connection, refer to “6. External interfaces”.

44 GPI input connector [GPI] (3.5 mm diameter stereo mini jack)

☞ For details on connection, refer to “6. External interfaces”.

45 Ground connector

Connect to the system’s earth ground.

46 AC power input socket [~ IN] (AC 220 V to 240 V)

Connect one end of the supplied power cable to this socket and the other end to the AC outlet.

The supplied power cable comes with a 3-pin power plug. Be absolutely sure to plug it into a 3-point power outlet as the power source in order to earth the unit securely.

If a 3-point power outlet is not available for this connection, be absolutely sure to consult your dealer.

47 Power switch

This is used to turn the power on and off.

2. System

2-1. Configuration

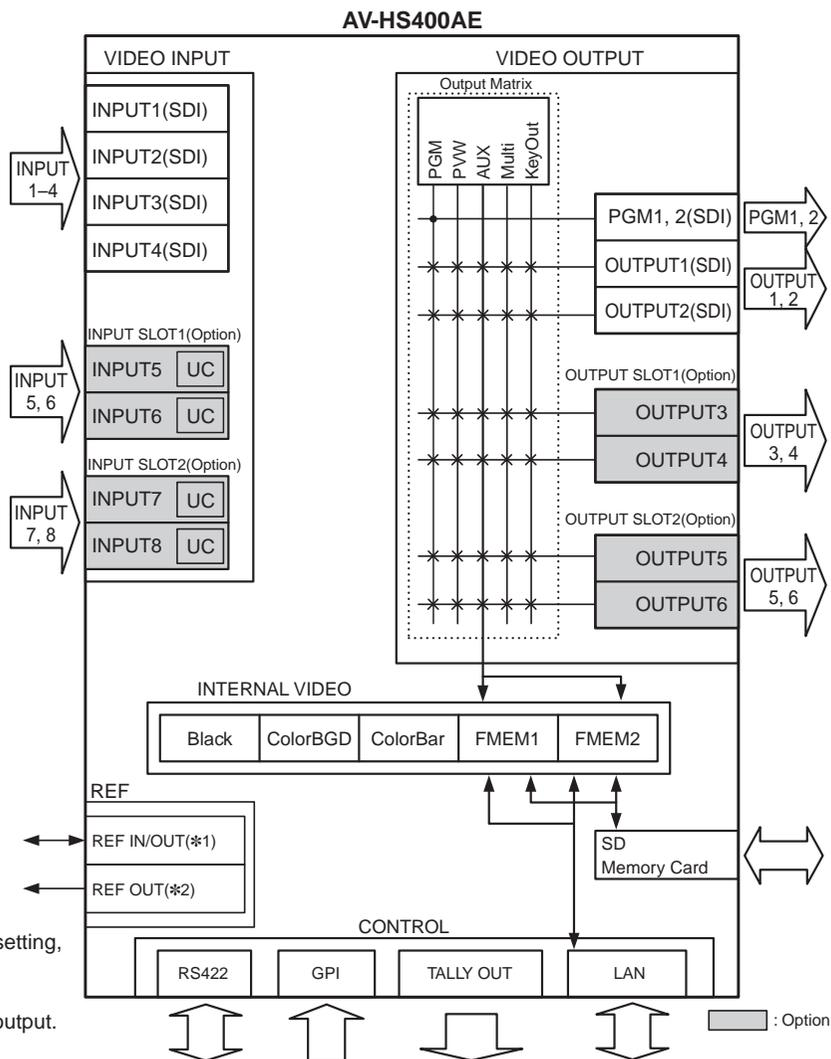

*1: When external synchronization is selected as the reference signal setting, the reference signal is input. When internal synchronization is selected, the reference signal is output.

*2: When external synchronization is selected as the reference signal setting, the signals are looped through and output. When internal synchronization is selected, the reference signal is output.

Table of optional boards

Board	Model number	Function	Where connected
SDI Input Board	AV-HS04M1	SDI input ×2 lines	INPUT SLOT1 or SLOT2
Analogue Input Board	AV-HS04M2	Analogue component input ×2 lines	
DVI Input Board	AV-HS04M3	DVI-I input ×2 lines	
Analogue Composite Input Board	AV-HS04M6	Analogue composite input ×2 lines	
Analogue Output Board	AV-HS04M4	Analogue component output ×2 lines	OUTPUT SLOT1 or SLOT2
DVI/Analogue Output Board	AV-HS04M5	DVI-I output ×1 line Analogue component output ×1 line	
SDI Output Board	AV-HS04M7	SDI output ×2 lines	

2. System

■Connections when not implementing gen-lock (frame synchronizer ON)

• Example where the optional board is used

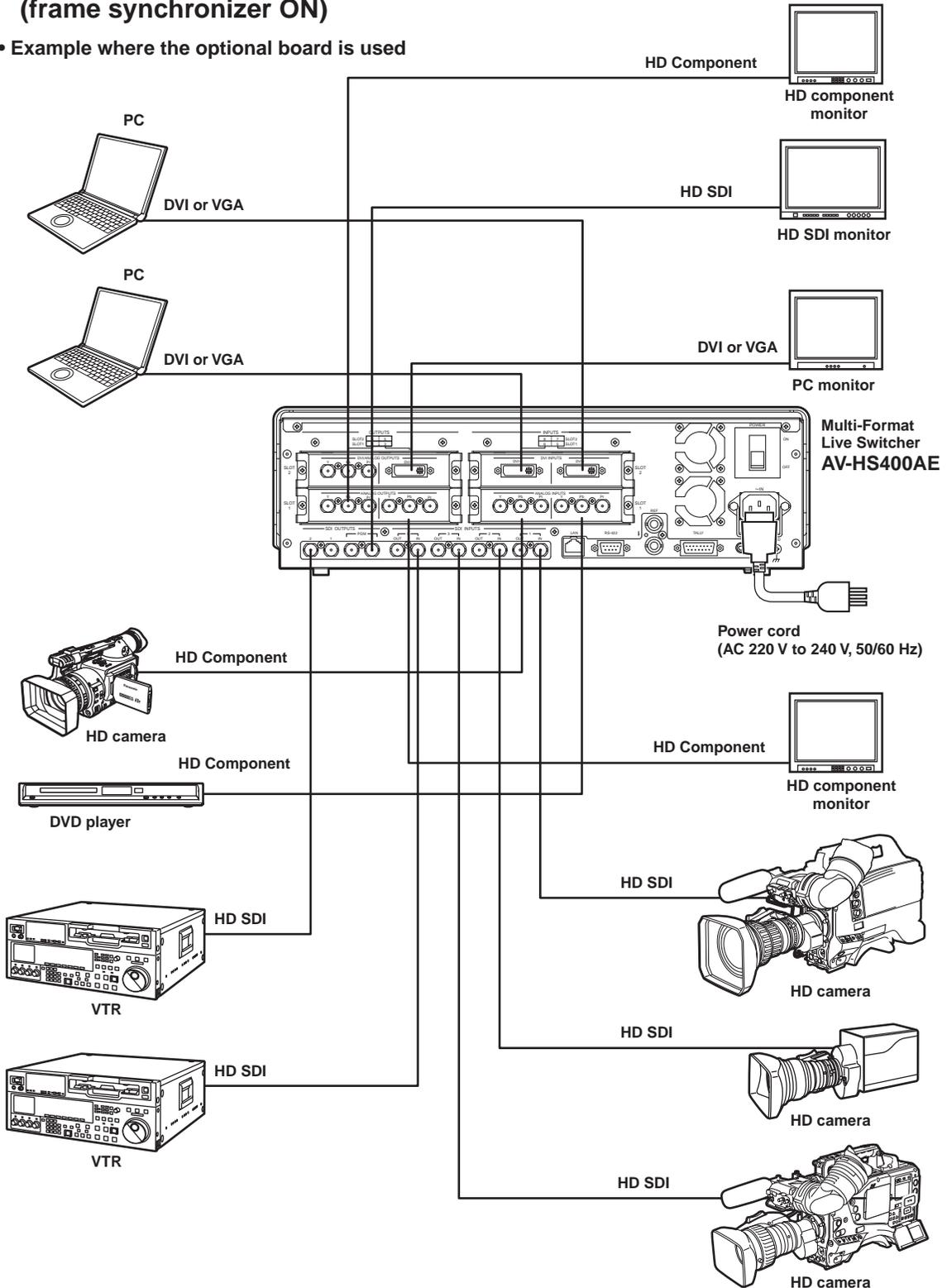

3. Basic operations

3-1. Background transition

3-1-1. Selecting the bus

Press the crosspoint buttons to select the material which will be targeted for the background transition. By pressing these buttons, the signals are selected, and the indicators of the selected buttons light. The colour in which the button indicators light differs depending on the operation status.

Lighting in red: When the selected input signals are output to PGM.
(However, the indicator lights in amber during FTB operations.)

Lighting in green: When the selected input signals are not output to PGM.

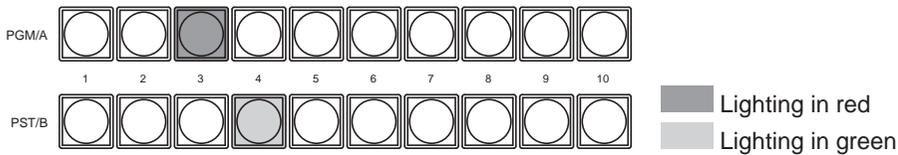

3-1-2. Selecting the bus mode

Select the A/B bus system or flip-flop system (PGM/PST system) from the setting menu.

- ① Press the [FUNC] button to light its indicator, and press the [SYSTEM] button to display the SYSTEM menu.
- ② Turn [F1] to display the System sub menu.
- ③ Turn [F2], and select the A/B or PGM/PST (flip-flop system) using the BusMode item.

<Menu display>

System	BusMode	LCD-BL	EditEN
2/16	PGM/PST	0n	0n
	A/B	Off	Off

With the flip-flop system (PGM/PST), the PGM/A bus selected signals are always output as PGM images, and the PST/B bus selected signals are always output as PVW (PST) images.

System	Video output	Before transition	During transition	After transition completion
A/B	PGM	PGM/A	PGM/A, PST/B	PST/B
	PVW (PST)	PST/B	PST/B	PGM/A

- With an A → B transition

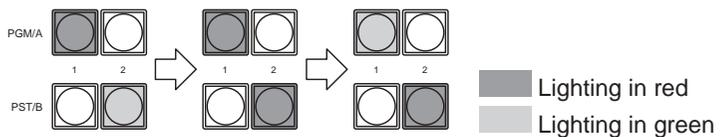

System	Video output	Before transition	During transition	After transition completion
Flip-flop PGM/PST	PGM	PGM/A	PGM/A, PST/B	PGM/A
	PVW (PST)	PST/B	PST/B	PST/B

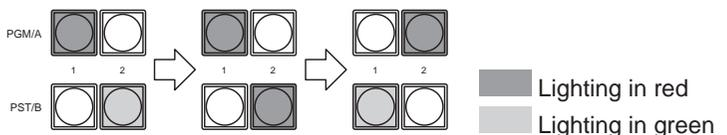

3. Basic operations

3-1-3. Selecting the transition mode

Press the [BKGD] button in the transition area so that its indicator lights in amber.
When the [BKGD] button and [KEY] button are pressed at the same time, both buttons are selected.

Use the [MIX] and [WIPE] buttons in the transition area to select the background transition mode.
The indicator of the selected button lights in amber.

3-1-4. Manual transition (using the fader lever)

Operate the fader lever to execute transitions manually.
If the fader lever has been operated during auto transition, auto transition will be switched to manual operation as soon as the fader position overtakes the amount of the transition being executed.
The bus tally LEDs on the left of the fader lever indicate the programme bus output status.

- Top LED only lights:** PGM/A bus output
- Top and bottom LEDs light:** during the transition
- Bottom LED only lights:** PST/B output

3-1-5. Auto transition

- When the [AUTO] button is pressed, the transition is executed automatically using the transition time which has been set.
- When the [AUTO] button is pressed while the fader lever is at an interim setting, the transition is executed in the time remaining from the interim setting.
- The auto transition time is set using the menu.
 - ① Press the [FUNC] button to light its indicator, and press the [TIME] button to display the TIME menu.
 - ② Turn [F1] to display the BKGD sub menu.
 - ③ Turn [F4] to select the display unit using the Unit item.
 - ④ When frames (F) have been selected as the unit, turn [F2] or [F3] to set the transition time.
 - ⑤ When seconds (Sec) have been selected as the unit, turn [F2] to set the second units or [F3] to set the frame units.

<Menu display>

BKGD	TransTime	Unit	
1/5	16s	39f	Sec

BKGD	TransTime	Unit	
1/5	999f	Frame	

- Any time from 0 to 999f can be set. The time which can be set when seconds are used as the display unit differs depending on the video format.

59.94i: max. 33s09f, **59.94p:** max. 16s39f

50i: max. 39s24f, **50p:** max. 19s49f

3-1-6. Cut transition

When the [CUT] button is pressed, the transition is executed instantly.

3. Basic operations

3-2. Wipe

3-2-1. Selecting the wipe pattern

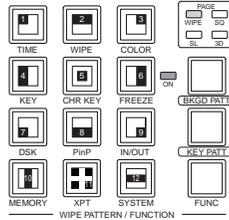

The wipe patterns which are allocated to the 12 wipe pattern buttons are used as the basis for wiping, and each button has four pages — wipe, squeeze, slide and 3D — of patterns. (Refer to the table of wipe patterns.) Displayed for each wipe pattern selector button are an image of the basic wipe pattern and a number.

<How to select the wipe patterns>

- ① Press the [BKGD PATT] button or [KEY PATT] button to select the page.
Each time the button is pressed, the page is selected, and the indicator LED (WIPE, SQ, SL or 3D) for the selected page lights.
- ② Select the button from among the 12 wipe pattern selector buttons for which the number of the pattern concerned is indicated.
The selected pattern lights, and a wipe pattern image appears on the external monitor (OSD).

The pattern page indicator LEDs light only when the [BKGD PATT] button or [KEY PATT] button has been selected.

<Table of wipe patterns>

WIPE			SQ (squeeze)			SL (slide)			3D (3 dimensions)		
1	2	3	1	2	3	1	2	3	1	2	3
4	5	6	4	5	6	4	5	6	4	5	6
7	8	9	7	8	9	7	8	9	7	8	9
10	11	12	10	11	12	10	11	12	10	11	12

- There are no corresponding patterns for 11 of SQ and 10, 11 and 12 for SL, therefore, they cannot be selected.

3. Basic operations

3-2-2. Selecting the wipe direction

Operate the wipe direction selector buttons to select the wipe direction for the background transition. (The key transitions are set by the menu. The direction which is set here will not be reflected. See 3-3-3.)

When the [R] indicator is off:

Wiping proceeds in the normal direction.

When the [R] indicator is lit:

Wiping proceeds in the reverse direction.

When the [N/R] indicator is lit:

The normal direction is replaced with the reverse direction (or vice versa) when the transition is completed.

(The lit and extinguished statuses of the [R] button are also switched in line with the direction of the wiping.)

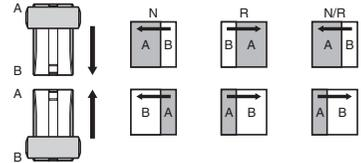

3-2-3. Wipe decorations (border, soft effect)

A border effect or soft effect can be added to the wiping of background transitions (but not for key transitions).

Setting the border and soft effect

- ① Press the [FUNC] button to light its indicator, and press the [WIPE] button to display the WIPE menu.
- ② Turn [F1] to display the Border sub menu.
- ③ Turn [F2] to set On (or Off) for the border using the Border item.
- ④ Turn [F3] to set the width of the border using the Width item.
- ⑤ Turn [F4] to set the amount of soft effect using the Soft item. The soft effect is OFF if 0.0 is set.

<Menu display>

Border	Border	Width	Soft
1/5	Off	5.0	0.0
	On	0.1	0.0
		100.0	100.0

When "On" has been selected as the Border item setting, the ratio of the soft effect to the border width is indicated as the amount of soft effect.

When only the soft effect is to be added to wipe, select "Off" as the Border item setting.

Setting the border colour

- ① On the WIPE menu, turn [F1] to display the BodrCol sub menu.
- ② Turn [F2], [F3] and [F4] to adjust the Hue, Sat and Lum of the border colour.

To call the preset colour

Turn [F5] to select the preset colour using the Load item, and press the [F5] switch.

The Hue, Sat and Lum values are changed to the preset colour values.

- To save the values that were set before calling the preset colour, refer to "3-10. Preset memory".

<Menu display>

BodrCol	Hue	Sat	Lum	Load↓
2/5	0.0	0.0	100.0	White
	0.0	0.0	0.0	Yellow
				Cyan
	359.9	100.0	108.0	Green
				Magenta
				Red
				Blue
				Black

3. Basic operations

3-2-4. Setting the wipe start position

Any start position can be set for wipe pattern WIPE and SQ #5.

The start position has one set of values for a background pattern and another set for a key pattern.

- ① Press the [FUNC] button to light its indicator, and press the [WIPE] button to display the WIPE menu.
- ② Turn [F1] to display the WIPEPos sub menu or the SQPos sub menu.

<Menu display>

WIPEPos	Select	X-Pos	Y-Pos	CopyTo↓
3/5	BKGD	0.00	0.00	KEY
	KEY	-100.00	-100.00	
		+100.00	+100.00	

- ③ Turn [F2] to select the pattern (background or key) to be set using the Select item.
- ④ Either operate the positioners or turn [F3] and [F4] to set the wipe start position using the X-Pos item and Y-Pos item.
These settings can be established only when WIPE or SQ #5 has been selected as the background pattern or key pattern.
- ⑤ Either operate the fader lever or press the [AUTO] button to check the wipe operation.
(When, for instance, -50 has been set for X-Pos and -50 for Y-Pos, the following screen (or key) appears from the bottom left and wipe is performed while the screen (or key) moves to the screen centre.)

<X-Pos, Y-Pos setting range>

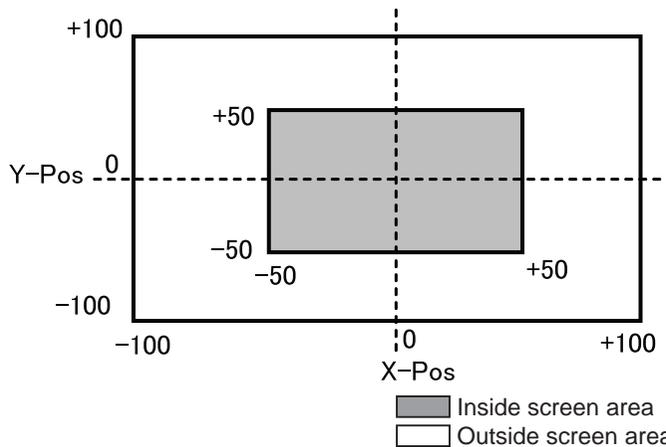

- ⑥ To copy the start position settings, press [F5].
The copy destination appears under the CopyTo item. (It will not change even if [F5] is turned.)

3. Basic operations

3-2-5. Modifying wipe

■ Setting the lighting effect

Lighting effects can be added when the following wipe patterns have been selected:

3D page: #1, #3, #7, #9

- ① Press the [FUNC] button to light its indicator, and press the [WIPE] button to display the WIPE menu.
- ② Turn [F1] to display the Modify sub menu.

<Menu display>

Modify	Light-B	Light-K	Trim	4:3Auto
5/5	Off	Off	16:9	Off
	On	On	4:3	On
			4:3Smth	
			Off	

- ③ Turn [F2] to select whether the lighting effect at the time a background transition is executed is to be added using the Light-B item.
On: The lighting effect is added.
Off: The lighting effect is not added.
- ④ Turn [F3] to select whether the lighting effect at the time a key transition is executed is to be added using the Light-K item.
On: The lighting effect is added.
Off: The lighting effect is not added.

■ Setting the trimming

When SQ, SL or 3D has been selected as the wipe pattern, the trimming at the time a background transition is executed can be set.

The “4:3” and “4:3Smth” settings for the Trim item take effect when the HD format has been selected as the system format setting.

- ① On the WIPE menu, turn [F1] to display the Modify sub menu.
- ② Turn [F4] to set the trimming operation and transition operation using the Trim item.
16:9 (On): For trimming the edges around the material.
This setting is used when a black border, for instance, can be seen around the material.
When HD has been selected as the system format setting, “16:9” is displayed on the menu, but when SD has been selected as the system format setting, “On” is displayed on the menu.
4:3: For trimming using the 4:3 aspect ratio and releasing the trimming when the transition is completed.
4:3Smth: For trimming using the 4:3 aspect ratio and executing the transition to 16:9 images smoothly.
Off: No trimming
- ③ Turn [F5] to select the setting for automatic trimming (4:3 or 4:3Smth) in accordance with the material using the 4:3Auto item.
Off: All input materials are targeted for automatic trimming.
On: Using the up-converter setting, the input materials for which EC (edge crop) is selected are targeted for automatic trimming.

3. Basic operations

3-3. Key

This operation combines the background image with another image. The key definition can be adjusted, and an edge can be added to the combined image.

Also available as materials besides KEY for combining with the background image are PinP (picture in picture) and DSK (downstream key). The figure below shows their priorities.

<Key, PinP and DSK priorities>

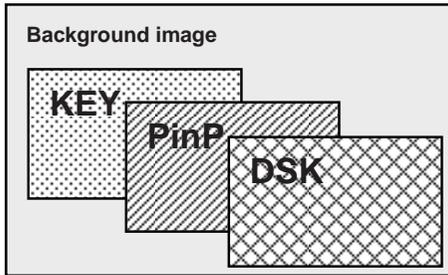

How key combinations work is shown in the figure below.

<How key composition works>

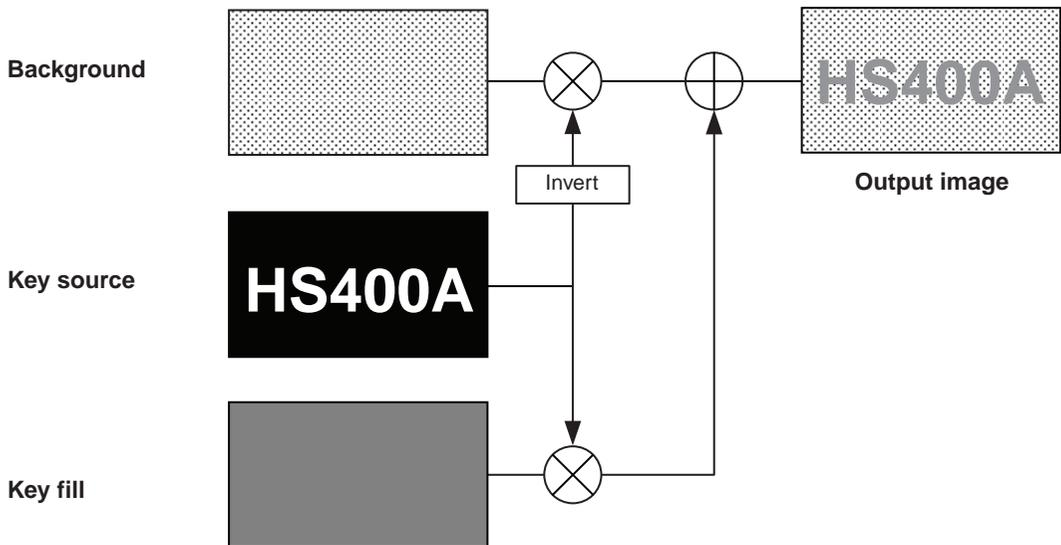

3. Basic operations

3-3-1. Selecting the key type

- ① Press the [FUNC] button to light its indicator, and press the [KEY] button to display the KEY menu.
- ② Turn [F1] to display the KEY sub menu.
- ③ Turn [F2] to select the Type item.

<Menu display>

KEY	Type	LumKey	Fill	PVW
1/9	Linear	ChrmOff	Bus	Auto
	Lum	ChrmOn	Matte	Off
	Chroma			On
	Full			

Lum (luminance key/self key):

This is for creating the key signals from the luminance component or luminance and chroma component of the key fill signal.

Linear (linear key/EXT key):

This is for creating the key signals from the luminance component of the key source signal. It is used when the key source signal and key fill signal are different.

Chroma (chroma key/self key):

This is for creating the key signals using a specific hue of the key fill signal as the reference.

Full (full key/self key):

This is for creating the key signals using the images on the full screen as the key source signals. PinP combinations are possible in conjunction with the flying key.  See 3-3-9.

Since the luminance and chroma keys are operated as self keys, the key fill signals are used as the key source signals. For the full key, the images on the full screen are used as the key source signals.

When the luminance key, chroma key or full key has been selected as the key type, the key signals will remain unchanged even when the key source signals are switched.

Furthermore, when “Lum”, “Chroma” or “Full” is selected, the KEY button in the crosspoint area changes to lighting in amber (key fill bus selection status).

When using the linear key, use material with a black background and white characters or shape to be combined by the key as the key source signal. Material which is not black and white may not be combined clearly. Material with a white background and black characters, etc. can be reversed using the key invert function for use.

- ④ When the luminance key has been selected, the chroma component can be included in the generation of the key signals in view of the self key application. (This does not apply to the linear key.) Turn [F3], and select the setting using the LumKey item.

ChrmOn: In addition to the luminance component, the chroma component is also taken into account in the generation of the key signals.

This is the setting for using a colour with a low luminance component for the key signals (such as when defining blue characters).

ChrmOff: The key signals are generated from only the luminance component.

- ⑤ Turn [F4] to select the fill type using the Fill item.

Bus: The bus signal is used for the key fill signal.

Matte: The internal fill matte is used for the key fill signal.

3. Basic operations

3-3-2. Selecting the key material

■ Selecting the key fill and key source signals

Press the KEY button in the AUX bus selection area, and switch the selection of the key fill signal (indicator lights in amber) and key source signal (indicator lights in green).

<Selecting the key fill signal>

With the indicator of the KEY button lit in amber, press one of the AUX bus crosspoint buttons 1 to 10 to select the key fill signal.

The indicator of the selected crosspoint button lights in amber. (It will light in red if the selected signal is being output from the PGM connector.)

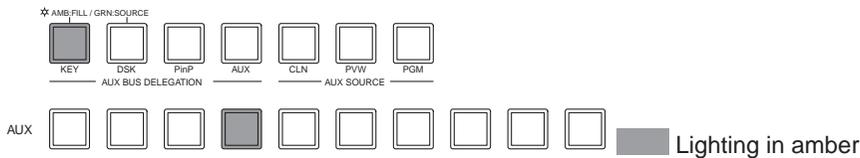

<Selecting the key source signal>

With the indicator of the KEY button lit in green, press one of the AUX bus crosspoint buttons 1 to 10 to select the key source signal.

The indicator of the selected crosspoint button lights in green. (It will light in red if the selected signal is being output from the PGM connector.)

Since the luminance and chroma keys are operated as self keys, the key fill signals are used as the key source signals. When the luminance key or chroma key has been selected as the key type, the key signals will remain unchanged even when the key source signals are switched.

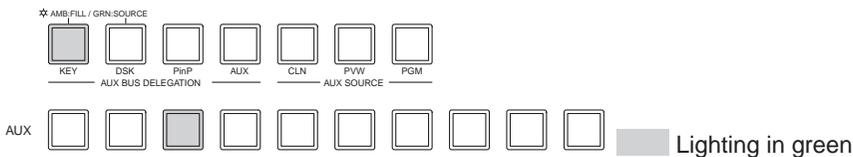

■ Setting the fill matte colour

- ① Press the [FUNC] button to light its indicator, and press the [KEY] button to display the KEY menu.
- ② Turn [F1] to display the FillMatt sub menu.
- ③ Turn [F2], [F3] and [F4] to adjust the Hue, Sat and Lum of the fill matte.

To call the preset colour

Turn [F5] to select the preset colour using the Load item, and press the [F5] switch.

The Hue, Sat and Lum values are changed to the preset colour values.

- To save the values that were set before calling the preset colour, refer to "3-10. Preset memory".

<Menu display>

FillMatt	Hue	Sat	Lum	Load↓
3/9	0.0	0.0	100.0	White
	0.0	0.0	0.0	Yellow
				Cyan
359.9	100.0	108.0		Green
				Magenta
				Red
				Blue
				Black

3. Basic operations

3-3-3. Key transitions

① Select key in the transition mode.
 Press the [KEY] button in the transition area to light its indicator.
 To execute a background transition and key transition at the same time, press the [BKGD] button and [KEY] button together to turn on both indicators.

② Select the transition type.
 Use the [MIX] button or [WIPE] button in the transition area to select the key transition mode.
 The indicator of the selected button lights in amber. At the same time, the MIX or WIPE selection status indicator LED lights.
 When WIPE has been selected, press the [KEY PATT] button to light its indicator, and select the wipe pattern.

③ Set the time of the transition.
 On the TIME menu, turn [F1] to display the KEY sub menu.
 As with a background transition, set the transition time.

④ Set the wipe direction.
 On the KEY menu, turn [F1] to display the Trans sub menu.
 Turn [F1] to set Nor (normal) or Rev (reverse) using the OutPatt item.

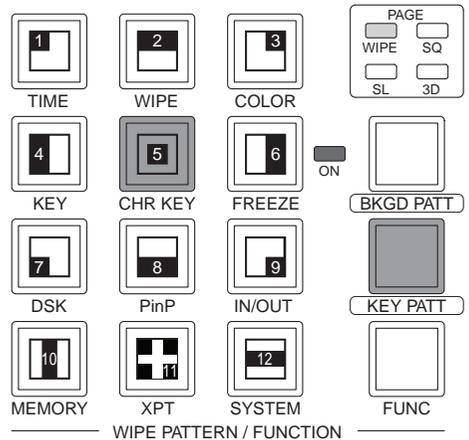
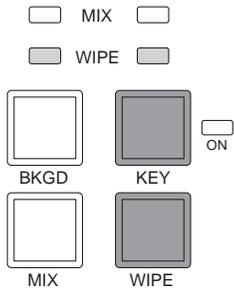

Nor (normal): The key out pattern moves in the same direction as the key in pattern.

Rev (reverse): The key out pattern moves in the opposite direction from the key in pattern.

However, the operations in pattern example 3 are performed for “WIPE 5, 10, 11, 12”, and the operations in pattern example 4 (same operations for normal and reverse) are performed for “SQ 5, 10, 12” and “3D 5, 10, 11, 12”.

<Pattern examples>

	Pattern example 1	Pattern example 2	Pattern example 3 (WIPE5, 10, 11, 12)	Pattern example 4 (SQ5, 10, 12) (3D 5, 10, 11, 12)
Key in				
Key out (Nor)				
Key out (Rev)				

: This indicates the areas where keys are combined.

3. Basic operations

⑤ Execute the transition.

Press the [AUTO] button to execute the transition automatically for the transition time which has been set. Alternatively, execute the transition manually by operating the fader lever.

When the KEYAuto function has been assigned to the [FTB] button, the transition will be executed automatically for the transition time which has been set when the [FTB] key is pressed no matter which transition mode has been selected.

During key in, the indicator of the [FTB] button blinks in red, and it lights in red when the transition is completed.

If the [FTB] button is pressed with the picture completely keyed in, the Key image transition (key out) is executed.

During key out, the indicator of the [FTB] button lights in red, and it goes off when the transition is completed.

If the [FTB] button is pressed during the transition, the transition direction is reversed.

3-3-4. Key preview

Key preview images can be output to the preview output, and the keys can be adjusted and checked.

On the KEY menu, turn [F1] to display the KEY sub menu.

Turn [F5] to set the preview mode using the PVW item.

On: An image with key effects added is output to the preview output.

Off: An image with no key effects added is output to the preview output.

Auto: The preview image of the next transition is output to the preview output.

3-3-5. Adjusting the luminance key and linear key

These steps are taken to adjust the luminance key and linear key definition.

① Press the [FUNC] button to light its indicator, and press the [KEY] button to display the KEY menu.

② Turn [F1] to display the Adjust sub menu.

<Menu display>

Adjust	Clip	Gain	Density	Invert
2/9	0.0	100.0	100.0	Off

③ Turn [F2], [F3] and [F4] to adjust the key definition.

④ Turn [F5] to set key invert.

When On is selected, the key signals to be generated internally are inverted.

Operation	Parameter	Description of setting	Setting range
F2	Clip	Reference level for generating key signals	0.0 to 108.0
F3	Gain	Key amplitude	0.0 to 200.0
F4	Density	Key density	0.0 to 100.0
F5	Invert	Key signal inversion	On, Off

3. Basic operations

3-3-6. Adjusting the chroma key

These steps are taken to adjust the chroma key definition. Before proceeding with the adjustments, select "Chroma" as the Type item setting in "3-3-1. Selecting the key type."

The signal for the chroma key is created using a specific colour tone as a reference. For instance, the background colour is detected from the image of a person who is standing in front of a specific background colour, the key signal is created, and a different background is combined.

This unit employs an area system which is designated using a rectangular frame. The colour of the pixels inside the area which have been averaged is used as the reference colour of the chroma key (key reference), and the maximum deviation from the average value is used as the radius of the chroma key oval. Chroma keys faithful to the chroma space sample (area © in the figure) can be generated.

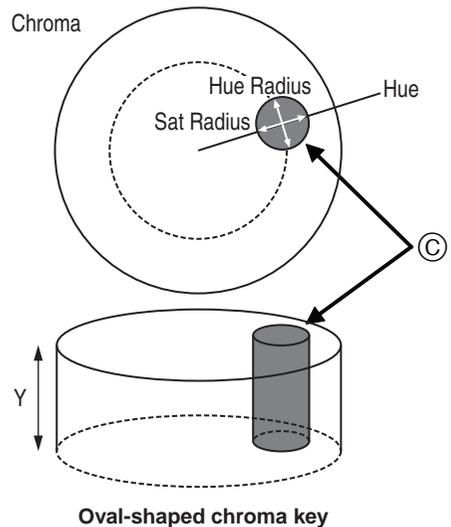

■ Executing auto sampling

The chroma component is sampled by specifying the screen area.

- ① Press the [FUNC] button to light its indicator, and press the [CHR KEY] button to display the CHR KEY menu.
- ② Turn [F1] to display the Auto sub menu, and turn [F2] to set On using the Marker item.

Even when a setting other than "Chroma" has been selected by the Type item in "3-3-1. Selecting the key type," "Chroma" will still be automatically selected.

<Menu display>

Auto	Marker	Aspect		Sample↓
1/3	On	0.0		Start
	Off	-50.00		
		+50.00		

- ③ The sample marker is displayed on the preview screen. Select the area to be sampled using the positioner, rotary encoder [Z] and Aspect item (turn [F3] to adjust).

Positioner:

Specify the X coordinate and Y coordinate of the sample marker.

Rotary encoder [Z]:

Adjust the size of the sample marker.

When rotary encoder [Z] is held down, the X and Y coordinates of the sample marker as well as the size of the marker are returned to their initial values.

Aspect:

Change the aspect ratio of the sample marker.

- ④ When the [F5] switch or the rotary encoder [Z] is pressed, the hue component of the area selected by the marker is sampled.
- ⑤ On completion of the sampling, the sampled values are reflected on the Adjust1 and Adjust2 sub menus, and a chroma key combined image is output to preview. (Set the key preview function to ON.)

3. Basic operations

■ Adjusting the chroma key

- ① Press the [FUNC] button to light its indicator, and press the [CHR KEY] button to display the CHR KEY menu.
- ② Turn [F1] to display the Adjust1 sub menu, and turn [F2] to [F5] to set the items.

<Menu display>

Adjust1	Hue	Sat	Lum	Y-Infl
2/3	100.0	100.0	100.0	0.0

<Item operations>

Operation	Parameter	Description of setting	Setting range	Initial value
F2	Hue	Hue serving as reference	359.9 to 0.0	*1
F3	Sat	Colour saturation serving as reference	0.0 to 100.0	*1
F4	Lum	Luminance serving as reference	0.0 to 108.0	*1
F5	Y-Infl	Extent of Y component influence *2	0.0 to 100.0	0.0

*1: After auto sampling has been executed, the sampled values the reference.

*2: The extent of the Y (Lum) component influence is set using the Y-Infl item. The higher the setting, the greater the influence, and at the 0 setting, the Y component is irrelevant.

- ③ Turn [F1] to display the Adjust2 sub menu, and turn [F2] to [F5] to set the items.

<Menu display>

Adjust2	Hue-Rad	Sat-Rad	Soft	Cancel
3/3	100.0	100.0	0.0	0.0

<Item operations>

Operation	Parameter	Description of setting	Setting range	Initial value
F2	Hue-Rad	Size of range of hue to be defined	0.0 to 100.0	*1
F3	Sat-Rad	Size of range of saturation to be defined	0.0 to 100.0	*1
F4	Soft	Extent of soft effect on border of colour to be defined	0.0 to 100.0	0.0
F5	Cancel	Cancel amount *2	0.0 to 100.0	0.0

*1: After auto sampling has been executed, the sampled values the reference.

*2: The amount of colour cancellation is adjusted using the Cancel item. This adjustment is made when the background colour covers the fill image.

Tips for chroma key adjustments

Chroma key adjustments can be facilitated by taking the steps below.

- ① Execute auto sampling, and decide on which colour is to be removed.
- ② Using the Hue-Rad item and Sat-Rad item, adjust in such a way that the background colour is completely removed.
- ③ Using the Soft item, finely adjusting the border of the key signal.

3. Basic operations

■ Making other adjustments

Perform the key density and key invert settings.

- ① Press the [FUNC] button to light its indicator, and press the [KEY] button to display the KEY menu.
- ② Turn [F1] to display the Adjust sub menu.

<Menu display>

Adjust	Clip	Gain	Density	Invert
2/9	-	-	100.0	Off

0.0	On
100.0	

(Neither the Clip item nor the Gain item can be set when the chroma key is selected.)

- ③ Turn [F4] to select the key density using the Density item.
- ④ Turn [F5] to set key invert.

3. Basic operations

3-3-7. Key decorations

A border, shadow or other edge can be added to the key.

■ Setting the key edge

- ① Press the [FUNC] button to light its indicator, and press the [KEY] button to display the KEY menu.
- ② Turn [F1] to display the Edge sub menu.
- ③ Turn [F2] to select the edge type.

- Off:** An edge is not added.
- Border:** A border is added around the entire edge.
- Drop:** A diagonal border is added.
- Shadow:** A shadow is added.
- Outline:** An outline (only a border with no fill) is added.

<Menu display>

Edge	Type	Width	Dirac
4/9	Off	2	0
Border	0-4	45	
Drop		90	
Shadow		135	
Outline		180	
		225	
		270	
		315	

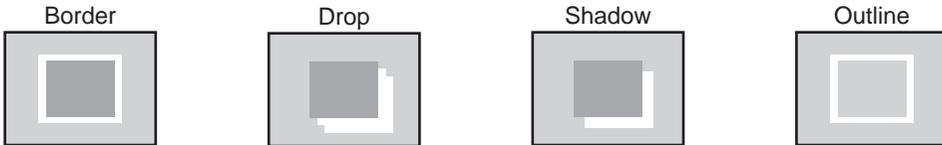

- ④ Turn [F3] to set the edge width.
- ⑤ Turn [F4] to set the direction (in 45-degree increments) in which “Drop” and “Shadow” will be added.

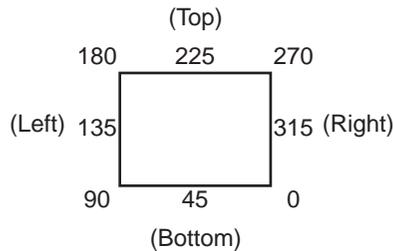

■ Setting the edge colour

- ① On the KEY menu, turn [F1] to display the EdgeCol sub menu.
- ② Turn [F2], [F3] and [F4] to adjust the Hue, Sat and Lum of the edge colour.

To call the preset colour

Turn [F5] to select the preset colour using the Load item, and press the [F5] switch. The Hue, Sat and Lum values are changed to the preset colour values.

- To save the values that were set before calling the preset colour, refer to “3-10. Preset memory”.

<Menu display>

EdgeCol	Hue	Sat	Lum	Load↓
5/9	0.0	0.0	0.0	Black
	0.0	0.0	0.0	Yellow
				Cyan
	359.9	100.0	108.0	Green
				Magenta
				Red
				Blue
				White

3. Basic operations

3-3-8. Masking the key signals

These steps are taken to mask the key signals using the mask signal of the box pattern.

- ① Press the [FUNC] button to light its indicator, and press the [KEY] button to display the KEY menu.
- ② Turn [F1] to display the Mask sub menu.

<Menu display>

Mask	Mask	Invert		
6/9	Off	Off		
	Manual	On		
	4:3			

- ③ Turn [F2], and select the masking method using the Mask item.
 - Off:** The key signals are not masked.
 - Manual:** The area that is set using the MaskAdj sub menu is masked.
 - 4:3:** The signals are masked to the 4:3 aspect ratio.
- ④ Turn [F3] to set whether to invert the mask signal using the Invert item.
 - On:** The mask signal is inverted.
 - Off:** The mask signal is not inverted.

- ⑤ Turn [F1] to display the MaskAdj sub menu.

<Menu display>

MaskAdj	Left	Top	Bottom	Right
7/9	-25.00	+25.00	-25.00	+25.00

- ⑥ Turn [F2] to [F5] to set the area to be masked.

Operation	Parameter	Description of setting	Setting range	Initial value
F2	Left	Key left position	-50.00 to +50.00	-25.00
F3	Top	Key top position	-50.00 to +50.00	+25.00
F4	Bottom	Key bottom position	-50.00 to +50.00	-25.00
F5	Right	Key right position	-50.00 to +50.00	+25.00

The Left setting cannot exceed the Right setting (and vice versa) and, similarly, the Top setting cannot exceed the Bottom setting (and vice versa).

<Key mask setting> (figure shows the default values)

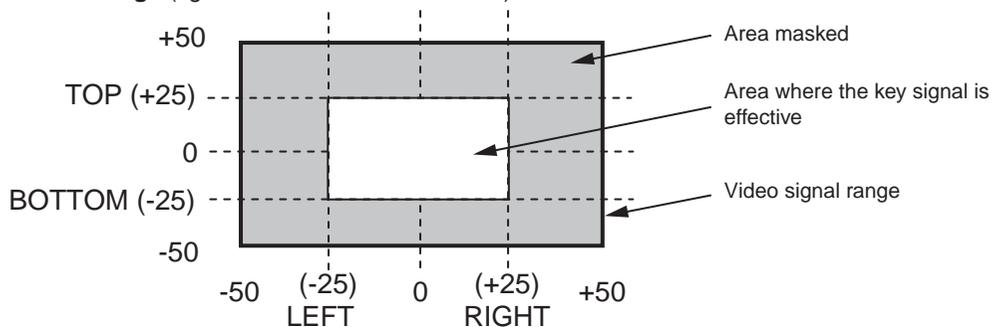

3. Basic operations

3-3-9. Flying key

Using DVE effects, this key enables the key signals that have been input to be moved, expanded or contracted. In order for the flying key to take effect, select SL #5 as the key transition.

When the key transition is executed, the keys are combined by the key signals set using the flying key menu. (The transition effect is fixed at MIX.)

Since the flying key uses DVE effects, the image is delayed by one frame.

When the SL #5 button is double-clicked, delegation to the FlyKEY menu is initiated.

- ① Press the [FUNC] button to light its indicator, and press the [KEY] button to display the KEY menu.
- ② Turn [F1] to display the FlyKEY sub menu.

<Menu display>

FlyKEY	X-Pos	Y-Pos	Size
9/9	0.00	0.00	100.0
-100.00	-100.00	0.0	
100.00	100.00	400.0	

- ③ Turn [F2] to set the X coordinate of the key signal using the X-Pos item.
- ④ Turn [F3] to set the Y coordinate of the key signal using the Y-Pos item.
- ⑤ Turn [F4] to set the key signal change size (max. 400: 400 %) using the Size item.

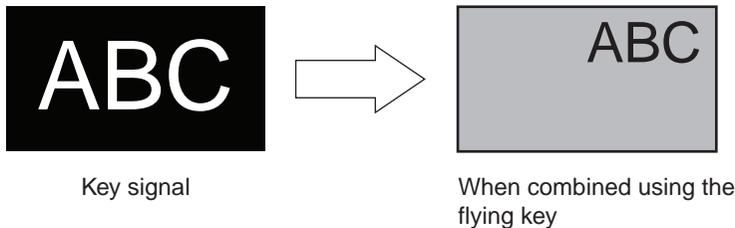

In order to add the edge of the key before the DVE effect, the thickness of the edge is also changed when the size is changed.

■ PinP combinations using the flying key

When "Full" is selected by the Type item in "3-3-1. Selecting the key type," PinP combinations are enabled using the flying key.

(At this point in time, the Clip item and Gain item cannot be set on the Adjust sub menu.)

With the full key, the image on the full screen serves as the key source signal so an edge will not be added unless a further step is taken.

To add an edge, mask the key signals so that the key source signals are made smaller than the entire screen. For details on masking, refer to "3-3-8. Masking the key signals".

3. Basic operations

3-4. PinP (picture in picture)

Another image can be combined with the background image.

3-4-1. Selecting the PinP material

Press the [PinP] button among the AUX bus selector buttons to light its indicator, and press one of the AUX bus crosspoint buttons 1 to 10 to select the PinP signal.

The indicators of both the [PinP] button and the selected AUX bus crosspoint button light in amber. (They light in red if the selected signal is being output to the PGM connector.)

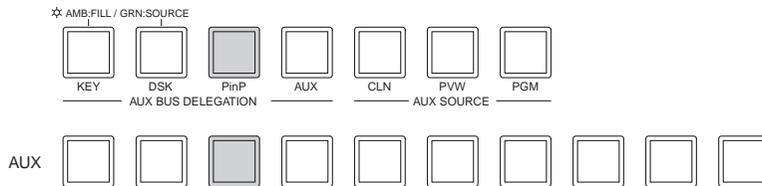

3-4-2. PinP transitions

- ① Set the transition time.
On the TIME menu, turn [F1] to display the PinP menu.
Set the transition time in the same way as for background transitions.
- ② When the [PinP] button in the transition area is pressed, the PinP image transition (fade-in) is executed for the transition time which has been set.

During fade-in, the indicator of the [PinP] button blinks in red, and it lights in red when the transition is completed.

If the [PinP] button is pressed with the picture completely faded in, the PinP image transition (fade-out) is executed.

During fade-out, the indicator of the [PinP] button lights in red, and it goes off when the transition (fade-out) is completed.

If the [PinP] button is pressed during the transition, the transition direction is reversed.



3-4-3. PinP preview

The user can select whether to output the PinP preview image to the preview output.

On the PinP sub menu, turn [F5] to set the PVW item.

<Menu display>

PinP	Density			PVW
1/6	100.0			Off
	0.0			On
	100.0			

On: The image with the PinP effect added is output to the preview output.

Off: The image with no PinP effect added is output to the preview output.

PVW On and Off can be allocated to the user buttons. See 5-3-1.

3. Basic operations

3-4-4. PinP adjustments

■ Adjusting the PinP position and size

While the PinP menu is selected, adjust the X and Y coordinates using the positioner in the positioner area, and adjust the size using the rotary encoder [Z]. Alternatively, the settings can be performed on the menus.

- ① Press the [FUNC] button to light its indicator, and press the [PinP] button to display the PinP menu.
- ② Turn [F1] to display the Position sub menu.
- ③ Either operate the positioner and the rotary encoder [Z] or turn [F2], [F3] and [F4] to set the X and Y coordinates and the size using the X-Pos, Y-Pos and Size items.

<Menu display>

Position	X-Pos	Y-Pos	Size
4/6	0.00	0.00	100.00
	-50.00	-50.00	0.00
	+50.00	+50.00	100.00

■ Select the dot by dot mode

When the system is set to the HD mode and an SD format image is to be used for the PinP material, the images can be combined in the dot by dot mode (actual-size images).

In this mode, the SD format image will not be up-converted so image deterioration can be prevented.

Furthermore, since the images are handled in their actual size, the PinP size is fixed.

On the IN/OUT menu, turn [F1] to display the Input menu, and select D by D using the Mode item.

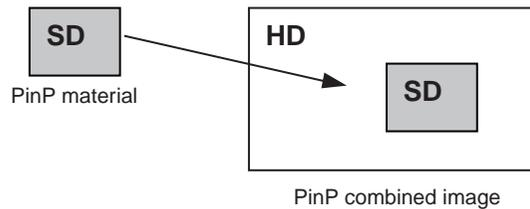

■ Adjusting the density

The step below is taken to adjust the PinP transparency (density).

On the PinP sub menu, turn [F2] to set the Density item.

3. Basic operations

3-4-5. PinP decorations

A border or soft effect can be added to PinP.

- ① Press the [FUNC] button to light its indicator, and press the [PinP] button to display the PinP menu.
- ② Turn [F1] to display the Border sub menu.

<Menu display>

Border	Border	Width	Soft	Mode
2/6	Off	5.0	0.0	Fix
	On	0.1	0.0	Var
		100.0	100.0	

- ③ Turn [F2] to set On (or Off) for the border using the Border item.
- ④ Turn [F3] to set the width of the border using the Width item.
- ⑤ Turn [F4] to set the amount of soft effect using the Soft item. The soft effect is OFF if 0.0 is set.
When "On" has been selected as the Border item setting, the ratio of the soft effect to the border width is indicated as the amount of soft effect.
When only the soft effect is to be added to PinP, select "Off" as the Border item setting.
- ⑥ Turn [F5] to set the change in the border width using the Mode Item.
Fix: The border width is kept constant.
Var (Variable): The border width changes to suit the PinP size.

■ Setting the border colour

- ① On the KEY menu, turn [F1] to display the BodrCol sub menu.
- ② Turn [F2], [F3] and [F4] to adjust the Hue, Sat and Lum of the border colour.

To call the preset colour

Turn [F5] to select the preset colour using the Load item, and press the [F5] switch.

The Hue, Sat and Lum values are changed to the preset colour values.

- To save the values that were set before calling the preset colour, refer to "3-10. Preset memory".

<Menu display>

BodrCol	Hue	Sat	Lum	Load↓
3/6	0.0	0.0	100.0	White
	0.0	0.0	0.0	Yellow
				Cyan
	359.9	100.0	108.0	Green
				Magenta
				Red
				Blue
				Black

3. Basic operations

3-4-6. Trimming settings

- ① Press the [FUNC] button to light its indicator, and press the [PinP] button to display the PinP menu.
- ② Turn [F1] to display the Trim sub menu.

<Menu display>

Trim 5/6	Trim Off	Manual Free		
	4:3 Manual	Pair		

- ③ Turn [F2] to select the trimming type using the Trim item.

Off: No trimming

4:3: Automatic trimming so that the aspect ratio is 4:3

Manual: Trimming using the value set on the TrimAdj sub menu

- ④ Turn [F3] to select the operation to be performed during the manual setting using the Manual item.

Free: The Left, Right, Top and Bottom parameters change independently.

However, the Left setting cannot exceed the Right setting (and vice versa) and, similarly, the Top setting cannot exceed the Bottom setting (and vice versa).

Pair: The settings are changed in such a way that the Left and Right trimming amounts and the Top and Bottom trimming amount are the same. (This makes for a top-bottom and left-right symmetry.)

- ⑤ Turn [F1] to display the TrimAdj sub menu, and turn [F2], [F3], [F4] and [F5] to set the trimming values.

Operation	Parameter	Description of setting	Setting range	Initial value
F2	Left	Trimming value at left	-50.00 to +50.00	-40.00
F3	Top	Trimming value at top	-50.00 to +50.00	+40.00
F4	Bottom	Trimming value at bottom	-50.00 to +50.00	-40.00
F5	Right	Trimming value at right	-50.00 to +50.00	+40.00

<Trimming settings> (figure shows the default values)

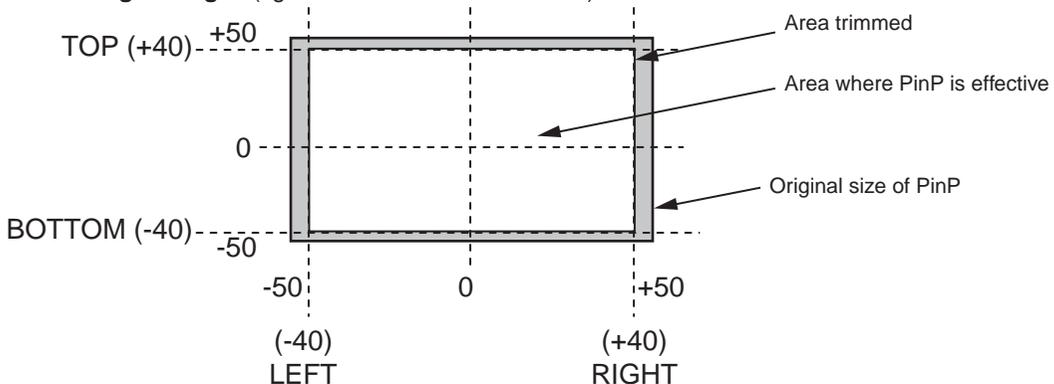

3. Basic operations

3-5. DSK (downstream key)

Characters or other images can be combined with the background image.

3-5-1. Selecting the DSK type

- ① Press the [FUNC] button to light its indicator, and press the [DSK] button to display the DSK menu.
- ② Turn [F1] to display the DSK sub menu.
- ③ Turn [F2] to select the Type item.

<Menu display>

DSK	Type		Fill	PVW
1/7	Linear		Bus	Off
	Lum		Matte	On

Lum (luminance key/self key):

This is for creating the key signals from the luminance component of the key fill signal.

Linear (linear key/EXT key):

This is for creating the key signals from the luminance component of the key source signal.

It is used when the key source signal and key fill signal are different.

Since the luminance key is operated as a self key, the key fill signals are used as the key source signals.

When the luminance key has been selected as the downstream key type, the key signals will remain unchanged even when the key source signals are switched.

Furthermore, when "Lum" is selected, the DSK button in the crosspoint area changes to lighting in amber (key fill bus selection status).

When using the linear key, use material with a black background and white characters or shape to be combined by the key as the key source signal.

Material which is not black and white may not be combined clearly.

Material with a white background and black characters, etc. can be reversed using the key invert function for use.

- ④ Turn [F4] to select the fill type using the Fill item.

Bus: The bus signal is used for the key fill signal.

Matte: The internal fill matte is used for the key fill signal.

3. Basic operations

3-5-2. Selecting the DSK material

■ Selecting the DSK fill signal and DSK source signal

Press the [DSK] button in the AUX bus selection area to switch the selection of the DSK fill signal (indicator lights in amber) and DSK source signal (indicator lights in green).

<Selecting the DSK fill signal>

While the indicator of the [DSK] button is lit in amber, press one of the AUX bus crosspoint buttons 1 to 10 to select the DSK fill signal.

The indicator of the selected AUX bus crosspoint button lights in amber. (It lights in red if the selected signal is being output from the PGM connector.)

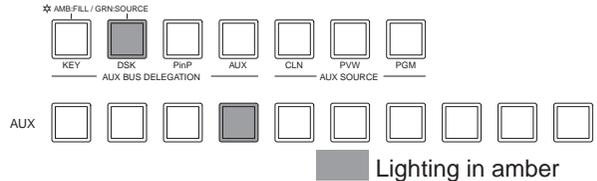

<Selecting the DSK source signal>

While the indicator of the [DSK] button is lit in green, press one of the AUX bus crosspoint buttons 1 to 10 to select the DSK source signal.

The indicator of the selected AUX bus crosspoint button lights in green. (It lights in red if the selected signal is being output from the PGM connector.)

Since the luminance key is operated as a self key, the key fill signals are used as the key source signals. When the luminance key has been selected as the downstream key type, the key signals will remain unchanged even when the key source signals are switched.

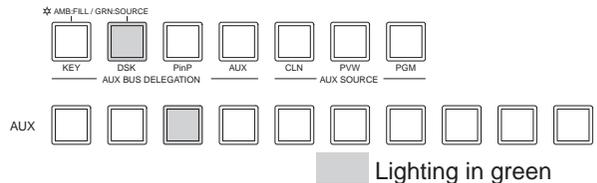

■ Setting the fill matte colour

- ① On the KEY menu, turn [F1] to display the FillMatt sub menu.
- ② Turn [F2], [F3] and [F4] to adjust the Hue, Sat and Lum of the fill matte.

To call the preset colour

Turn [F5] to select the preset colour using the Load item, and press the [F5] switch.

The Hue, Sat and Lum values are changed to the preset colour values.

- To save the values that were set before calling the preset colour, refer to “3-10. Preset memory”.

<Menu display>

FillMatt	Hue	Sat	Lum	Load↓
3/7	0.0	0.0	100.0	White
	0.0	0.0	0.0	Yellow
				Cyan
359.9	100.0	108.0		Green
				Magenta
				Red
				Blue
				Black

3. Basic operations

3-5-3. DSK transitions

- ① Set the duration of the transition.

On the TIME menu, turn [F1] to display the DSK sub menu.
As with a background transition, set the transition time.

- ② When the [DSK] button in the transition area is pressed, the DSK image is combined (fade-in) for the transition time which was set.

During fade-in, the indicator of the [DSK] button blinks in red, and it lights in red when the transition (fade-in) is completed.

If the [DSK] button is pressed with the picture completely faded in, the DSK image transition (fade-out) is executed.

During fade-out, the indicator of the [DSK] button lights in red, and it goes off when the transition (fade-out) is completed.

If the [DSK] button is pressed during the transition, the transition direction is reversed.



3-5-4. DSK preview

The user can select whether to output the DSK preview image to the preview output.

On the DSK sub menu, turn [F5] to set the PVW item.

On: The image with the DSK effect added is output to the preview output.

Off: The image with no DSK effect added is output to the preview output.

PVW On and Off can be allocated to the user buttons. See 5-3-1.

3-5-5. DSK adjustments

The DSK definition can be adjusted.

- ① Press the [FUNC] button to light its indicator, and press the [DSK] button to display the DSK menu.
- ② Turn [F1] to display the Adjust sub menu.

<Menu display>

Adjust	Clip	Gain	Density	Invert
2/7	0.0	100.0	100.0	Off

- ③ Turn [F2], [F3] and [F4] to adjust the DSK (downstream key) definition.

Operation	Parameter	Description of setting	Setting range
F2	Clip	Reference level for generating key signals	0.0 to 108.0
F3	Gain	Key amplitude	0.0 to 200.0
F4	Density	Key density	0.0 to 100.0
F5	Invert	Key signal inversion	On, Off

3. Basic operations

3-5-6. DSK decorations

A border, shadow or other edge can be added to the DSK.

■ Setting the edge

- ① Press the [FUNC] button to light its indicator, and press the [DSK] button to display the DSK menu.
- ② Turn [F1] to display the Edge sub menu.
- ③ Turn [F2] to select the edge type.

- Off:** An edge is not added.
- Border:** A border is added around the entire edge.
- Drop:** A diagonal border is added.
- Shadow:** A shadow is added.
- Outline:** An outline (only a border with no fill) is added.

<Menu display>

Edge	Type	Width	Dirac
4/7	Off	2	0
Border	0-4	45	
Drop		90	
Shadow		135	
Outline		180	
		225	
		270	
		315	

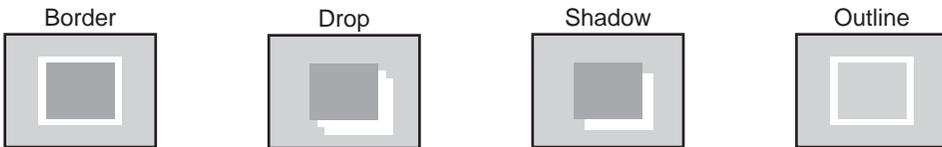

- ④ Turn [F3] to set the edge width.
- ⑤ Turn [F4] to set the direction (in 45-degree increments) in which “Drop” and “Shadow” will be added.

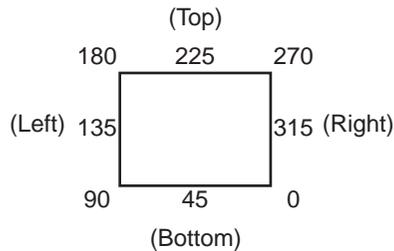

■ Setting the edge colour

- ① On the DSK menu, turn [F1] to display the EdgeCol sub menu.
- ② Turn [F2], [F3] and [F4] to adjust the Hue, Sat and Lum of the edge colour.

To call the preset colour

Turn [F5] to select the preset colour using the Load item, and press the [F5] switch. The Hue, Sat and Lum values are changed to the preset colour values.

- To save the values that were set before calling the preset colour, refer to “3-10. Preset memory”.

<Menu display>

EdgeCol	Hue	Sat	Lum	Load↓
5/7	0.0	0.0	0.0	Black
	0.0	0.0	0.0	Yellow
				Cyan
	359.9	100.0	108.0	Green
				Magenta
				Red
				Blue
				White

3. Basic operations

3-5-7. Masking the DSK signals

These steps are taken to mask the DSK signals using the mask signal of the box pattern.

- ① Press the [FUNC] button to light its indicator, and press the [DSK] button to display the DSK menu.
- ② Turn [F1] to display the Mask sub menu.

<Menu display>

Mask	Mask	Invert		
6/7	Off	Off		
	Manual	On		
	4:3			

- ③ Turn [F2], and select the masking method using the Mask item.
 - Off:** The DSK signals are not masked.
 - Manual:** The area that is set using the MaskAdj sub menu is masked.
 - 4:3:** The signals are masked to the 4:3 aspect ratio.
- ④ Turn [F3] to set whether to invert the mask signal using the Invert item.
 - On:** The mask signal is inverted.
 - Off:** The mask signal is not inverted.

- ⑤ Turn [F1] to display the MaskAdj sub menu.

<Menu display>

MaskAdj	Left	Top	Bottom	Right
7/7	-25.00	+25.00	-25.00	+25.00

- ⑥ Turn [F2] to [F5] to set the area to be masked.

Operation	Parameter	Description of setting	Setting range	Initial value
F2	Left	DSK left position	-50.00 to +50.00	-25.00
F3	Top	DSK top position	-50.00 to +50.00	+25.00
F4	Bottom	DSK bottom position	-50.00 to +50.00	-25.00
F5	Right	DSK right position	-50.00 to +50.00	+25.00

The Left setting cannot exceed the Right setting (and vice versa) and, similarly, the Top setting cannot exceed the Bottom setting (and vice versa).

<DSK mask setting> (figure shows the default values)

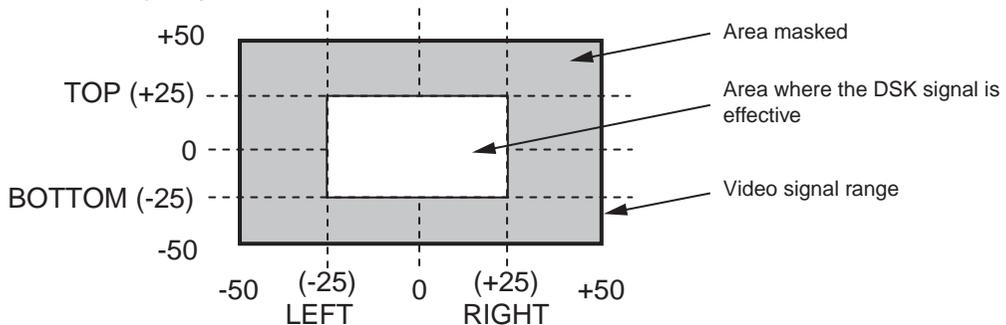

3. Basic operations

3-6. FTB (fade to black)

The user can fade out from a programme image to the black screen or fade in to a programme image from a black screen.

- ① Set the duration of the transition.

On the TIME menu, turn [F1] to display the FTB sub menu.
As with a background transition, set the transition time.

- ② When the [FTB] button in the transition area is pressed, fade-out to the black screen is initiated.

During fade-out, the indicator of the [FTB] button blinks in red, and it lights in red when the transition (fade-out) is completed, and the black screen is displayed.*1

When the [FTB] button is pressed with the black screen displayed, fade-in to the programme image is initiated.

During fade-in, the indicator of the [FTB] button lights in red, and it goes off when the transition (fade-in) is completed.

If the [FTB] button is pressed during the transition, the transition direction is reversed.



*1: In the FTB status, the crosspoint button which is normally lit in red lights in amber. However, it will light in green when the key source and DSK source have been selected.

The KEYAuto function can be assigned to the [FTB] button. See “5-3. Button assignments”.

3. Basic operations

3-7. Internal colour signals

3-7-1. Setting the colour background

The colour background to be used by the bus can be set.

Two methods are available: under one method the Hue (hue), Sat (colour saturation) and Lum (luminance) are set, and under the other the 8 preset colours (white, yellow, cyan, green, magenta, red, blue and black) are called. The Hue, Sat and Lum of the called colours can also be adjusted.

■ Adjusting the colours

- ① Press the [FUNC] button to light its indicator, and press the [COLOR] button to display the COLOR menu.
- ② Turn [F2], [F3] and [F4] to perform the colour adjustments (Hue, Sat and Lum).

■ Calling the preset colours

Turn [F5] to select the preset colour using the Load item, and press the [F5] switch.

The Hue, Sat and Lum values are changed to the preset colour values.

- To save the values that were set before calling the preset colour, refer to “3-10. Preset memory”.

<Menu display>

CBGD	Hue	Sat	Lum	Load↓
1/1	100.0	100.0	100.0	White
	0.0	0.0	0.0	Yellow
				Cyan
	359.9	100.0	108.0	Green
				Magenta
				Red
				Blue
				Black

3. Basic operations

3-8. Freezing the input signals

The input signals can be frozen and used. If any of the input signals has been frozen, the freeze status indicator LED lights. While signals are frozen, the tally signals of the corresponding input will not be output.

3-8-1. Displaying the freeze status

- ① Press the [FUNC] button to light its indicator, and press the [FREEZE] button to display the Freeze menu.
- ② Turn [F1] to display the Status sub menu.
Asterisks (*) appear above the numbers of the crosspoint buttons which are currently in the freeze status.

<Menu display>

Status	FRZ: * *
1/2	XPT:1 2 3 4 5 6 7 8 9 10

3-8-2. Setting freeze

- ① On the freeze menu, turn [F1] to display the Freeze sub menu.

<Menu display>

Freeze	Signal	Select		Freeze↓
2/2	IN1	Frame		Off
	IN1-8	Field		On

- ② Turn [F2] to select the input video signal using the Signal item.
- ③ Turn [F3] to select the freeze method using the Select item.

Frame: The images are frozen frame by frame.

Field: The images are frozen field by field.

This is used to freeze moving images.

With interlace signals, however, diagonal lines and moving parts appear jagged.

Frame or Field can also be selected while an image is frozen.

- ④ Press the [F5] switch to freeze the input image or cancel the freeze.
If the [F5] switch is pressed while the display is “Off”, the video signal is frozen, and the display is set to “On”.
If the [F5] switch is pressed while the display is “On”, the video signal freezing is cancelled, and the display is set to “Off”.

When the unit is used with the frame synchronizer function OFF, the output images may be disturbed when freezing is executed, but the frozen images will not be adversely affected.

The frame synchronizer function will automatically be switched ON.

3. Basic operations

3-9. Switching the AUX output

The user can switch the AUX output signals.

The signals of any of the AUX bus crosspoint button 1 to 10, PGM (programme) signals, PVW (preview) signals or CLN (clean) signals can be selected for output to the AUX bus.

[PGM]: The PGM signals are output to the AUX bus.

[PVW]: The PVW signals are output to the AUX bus.

[CLN]: The clean signals (images whose DSK signals have been removed from the PGM signals) are output to the AUX bus.

■ Selecting the output signals using the crosspoint buttons

Press the [AUX] button among the AUX bus selector buttons to light its indicator, and press one of the AUX bus crosspoint buttons 1 to 10, CLN, PVW or PGM button to select the AUX output signals.

The indicators of the [AUX] button and the selected button light in amber.

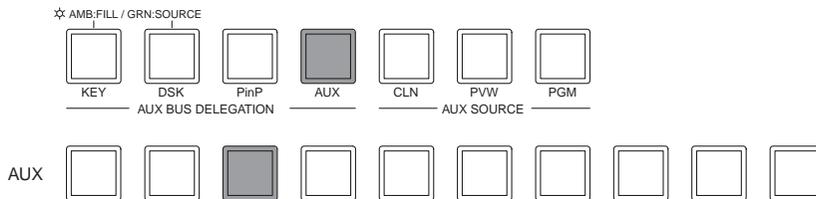

3. Basic operations

3-10. Preset memory

Up to 10 panel settings can be stored in this memory.
The table below lists the settings which are stored.

<Table of stored preset memory>

Item	Description of setting	Initial value (factory default)
Crosspoint	A bus	1
	B bus	1
	KEY FILL bus	1
	KEY SOURCE bus	1
	PinP bus	1
	DSK FILL bus	1
	DSK SOURCE bus	1
	AUX bus	1
Transition area	BKGD/KEY selection	BKGD
	MIX/WIPE selection	MIX
	N/R selection	N (Normal)
	Auto transition time (BKGD)	1s
	Auto transition time (KEY)	1s
	Transition time (PinP)	1s
	Transition time (DSK)	1s
	Transition time (FTB)	1s
	KEY ON status * ON at an interim point	Off
	PinP ON status * ON at an interim point	Off
	DSK ON status * ON at an interim point	Off
FTB status * ON at an interim point	Off	
Border (BKGD Wipe)	Border ON/OFF	Off
	Border width	5.0
	Soft effect width	0.0
	Border colour	Hue: 0.0, Sat: 0.0, Lum: 100.0
Wipe	Wipe pattern (BKGD)	WIPE5
	Centre position of BKGD pattern WIPE5	centre (X: 0, Y: 0)
	Centre position of BKGD pattern SQ5	centre (X: 0, Y: 0)
	Wipe pattern (KEY)	WIPE5
	Centre position of KEY pattern WIPE5	centre (X: 0, Y: 0)
	Centre position of KEY pattern SQ5	centre (X: 0, Y: 0)
	Lighting (Light) (background)	Off
	Lighting (Light) (KEY)	Off
	Wipe (DVE) trimming (Trim)	16:9 (On)
4:3 Auto	Off	

3. Basic operations

Item	Description of setting	Initial value (factory default)
Key	Key type (Type)	Linear
	Luminance key setting	ChrmOff
	Key adjustment (Adjust)	Gain: 100.0, Clip: 0.0, Density: 100.0
	Invert	Off
	Fill type	Bus
	Fill matte	Hue: 0.0, Sat: 0.0, Lum: 100.0
	Edge colour	Hue: 0.0, Sat: 0.0, Lum: 0.0
	Edge type	Off
	Edge width	2
	Edge direction	0
	Key out pattern (OutPatt)	Nor
	Mask	Off
	Mask invert	Off
	Mask setting	Left, Bottom: -25.00 Right, Top: +25.00
Flying key position, size	X: 0.00, Y: 0.00, Z: 100.00	
Chroma key	Chroma key reference colour	Hue: 354.0, Sat: 100.0, Lum: 100.0
	Extent of Y component effect (Y-Infl)	0.0
	Chroma key range	Hue-Rad: 100.0, Sat-Rad: 50.0
	Chroma key border soft effect (Soft)	0.0
	Chroma cancel amount (CANCEL)	0.0
	Marker position, size	X: 0.0, Y: 0.0, Z: 5.0
Marker aspect ratio	0.0	
DSK	Key type (Type)	Linear
	Key adjustment (Adjust)	Gain: 100.0, Clip: 0.0, Density: 100.0
	Invert	Off
	Fill type	Bus
	Fill matte	Hue: 0.0, Sat: 0.0, Lum: 100.0
	Edge colour	Hue: 0.0, Sat: 0.0, Lum: 0.0
	Edge type	Off
	Edge width	2
	Edge direction	0
	Mask	Off
	Mask invert	Off
	Mask setting	Left, Bottom: -25.00 Right, Top: +25.00
PinP	Position, Size (X, Y, Z)	X: 0.00, Y: 0.00, Z: 25.00
	Border ON/OFF	Off
	Border width	5.0
	Border soft effect amount	0.0
	Border width change (Fix, Var)	Fix
	Border colour	Hue: 0.0, Sat: 0.0, Lum: 100.0
	Density	100.0
	Trimming	Off
Trimming setting	Left, Bottom: -40.00 Right, Top: +40.00	
Color	CBGD (colour background)	Hue: 0.0, Sat: 0.0, Lum: 100.0

3. Basic operations

■ STORE: This is used to store the panel settings in the preset memory.

- ① Press the [FUNC] button to light its indicator, and press the [MEMORY] button to display the MEMORY menu.
- ② Turn [F1] to display the PSMEM sub menu.
- ③ Turn [F2], select "Store" using the Mode item, turn [F3], and set the preset memory number using the NO.Sel item.
- ④ Press the [F5] switch (Exec) to store the settings.

<Menu display>

PSMEM	Mode	NO.Sel	XPT	Exec↓
1/4	Store	■1	Disable	
	Recall	1-10	Enable	
	Clear			

The "■" appears at the left of the number when data has been saved in the preset memory.

■ RECALL: This is used to recall the preset memory data and change the panel settings.

- ① On the MEMORY menu, turn [F1] to display the PSMEM sub menu.
- ② Turn [F2], select "Recall" using the Mode item, turn [F3], and set the preset memory number using the NO.Sel item.
- ③ Turn [F4] to select whether to call the crosspoint selection status using the XPT item.
Enable: The data stored in the preset memory is used.
Disable: The data stored in the preset memory is not used, and the settings prior to recall are retained.
- ④ Press the [F5] switch (Exec) to recall the settings.

■ CLEAR: This is used to clear contents in the preset memory.

- ① On the MEMORY menu, turn [F1] to display the PSMEM sub menu first.
- ② Turn [F2], select "Clear" using the Mode item, turn [F3], and set the preset memory number using the NO.Sel item.
- ③ Press the [F5] switch (Exec) to clear the content.

3. Basic operations

3-11. Frame memories

Still images can be stored in the unit's two internal frame memories for use.

The still images are transferred to the frame memories through the AUX bus and an SD memory card.

Conversely, the images in the frame memories can be transferred to an SD memory card.

Images in the frame memories can be used as bus images by assigning FMEM1 and FMEM2 using the crosspoint assignment function.

Since the images stored in the frame memories are stored in the unit's RAM area, the image data is erased once the power is turned off.

Transfer them again after the power has been turned back on.

3-11-1. Transferring images from the AUX bus

- ① Press the [FUNC] button to light its indicator, and press the [MEMORY] button to display the MEMORY menu.
- ② Turn [F1] to display the FMEM sub menu.

<Menu display>

FMEM	Signal	Store	Review	Exec↓
2/4	AUX	FMEM1	Off	
		FMEM2	On	

- ③ Turn [F3] to select the frame memory in which to store the images using the Store item.
- ④ Turn [F4] to select on or off for the review display setting using the Review item.
 - On:** After the image is imported, the FMEM1 or FMEM2 image is displayed (for 2 seconds) in the AUX bus.
 - Even during review display, the next image can be imported.
 - Off:** No review display.
- ⑤ Press the [F5] switch (Exec) to import the still images to the frame memory.

The still images can also be imported using the user buttons.

“StrFM1” and “StrFM2” have been allocated to the user buttons (☞ See 5-3-1.), and when one of these buttons is pressed, it will light for an instant, and the still image is then imported.

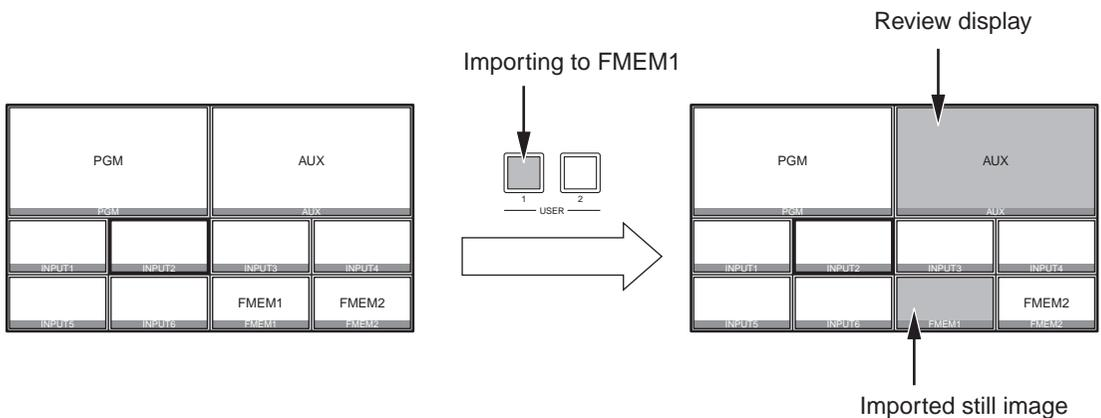

3. Basic operations

3-12. SD memory cards

The unit's frame memory data and system data can be stored on SD memory cards. Conversely, this data can be loaded from the SD memory cards to the unit.

Frame memory data (still image data):

The unit supports 24-bit (uncompressed) BMP (bitmap) and JPEG (baseline) is the only file formats.

JPEG format files can be loaded, but they become BMP format files when they are stored from the unit to the SD memory card.

This unit cannot resize the images so resize them appropriately using another device such as a personal computer before saving them on the SD memory card.

<Applicable sizes>

HD/1080i: 1920×1080, HD/720p: 1280×720,
SD/NTSC: 720×487, SD/PAL: 720×576

BMP files:

If the sizes are different, the centre of the images will be lined up.

If the image is large, it will be cropped.

If the image is small, the area around it will be filled in with a black border.

JPEG files:

Images in the sizes listed in "Applicable sizes" above can be loaded.

The pixels of images in SD format are not square, so the aspect ratio will be different when the images are displayed on the computer and when they are imported into frame memory (with NTSC format, they will be vertically long).

To keep the images true to their actual proportions, make sure the original size is 720×540 pixels. If the images are in NTSC format, use images shrunk to 720×487 pixels. If the images are in PAL format, use images enlarged to 720×576 pixels.

System data:

The "system data" refers to all the data stored in the unit with the exception of the date, time and network settings and of the still image data. The extension used for the system data files is "hs4".

SD memory card handling precautions

- Do NOT eject the SD memory card while the SD memory card access LED is lit.
When an SD memory card is ejected while the SD memory card access LED is lit, the transition of the operation from data access to card ejection may be temporarily suspended.
In addition, the data stored on the SD memory card may be lost.
- The data stored on SD memory cards may be lost as a result of misplacing the cards or performing erroneous operations, for instance. It is recommended that valuable data be stored on a personal computer or other device.

3. Basic operations

3-12-1. Initializing the SD memory cards

In order for an SD memory card to be used in the unit, **it must first be initialized by the unit**. Initializing the SD memory card formats it (in compliance with the SD standard) and creates the dedicated directory. (All files saved on the SD memory card will be erased.)

- ① Insert the SD memory card into the unit's SD memory card slot.
- ② Press the [FUNC] button to light its indicator, and press the [MEMORY] button to display the MEMORY menu.
- ③ Turn [F1] to display the SDCard sub menu.
- ④ Turn [F2] to select "Init" using the Mode item, and then press the [F2] switch.
The "Init?" message now appears.
If the SD memory card has not been inserted, "No Card" will appear at the Mode item.
When the mode is selected, an asterisk (*) appears on the left of the selected mode (Init, Save, Load or Delete). If an asterisk does not appear, press the [F2] switch to select a mode.
- ⑤ Turn [F5] to select "Yes," and press the [F5] switch to initialize the card.
To cancel the initializing, turn [F5] to select "No", and press the [F5] switch.

<Menu display>

SDCard	Mode↓	Select	Init?	Exec↓
3/4	*Init		-	No



SDCard	Mode↓	Select	Init?	Exec↓
3/4	*Init		-	Yes

If "Load", "Save" or "Delete" is selected and then the [F2] switch is pressed after a SD memory card not formatted in compliance with the SD standard has been inserted, a message indicating that "This card is not usable Please initialize it" is displayed. See 3-12-2, 3-12-3 and 3-12-4.
Before using a SD memory card in this unit, initialize it.

The same message will be displayed when an SDHC memory card has been inserted. However, SDHC memory cards cannot be used at all with this unit.

3. Basic operations

3-12-2. Saving data on SD memory cards

- ① Insert the SD memory card which has been initialized by the unit, into the SD memory card slot.
- ② On the MEMORY menu, turn [F1] to display the SDCard sub menu.
- ③ Turn [F2] to select "Save" using the Mode item, and then press the [F2] switch.

<Menu display>

SDCard	Mode↓	Select	SaveFile	Exec↓
3/4	*Save	FMEM1		
		FMEM2		
		System		

- ④ Turn [F3] to select the data which is to be stored on the SD memory card using the Select item.

FMEM1, 2: Still image data of frame memory 1, frame memory 2

System: System data

- ⑤ If the [F5] switch is now pressed, the file is stored on the SD memory card.
(Filenames are allocated automatically.)

System data: "HS400/SYSTEM" folder
Still image data: "HS400/IMAGE" folder

While the file is being stored, the following message and filename are displayed.

SDCard	...Saving File...
3/4	HS070531100000

3. Basic operations

3-12-3. Loading data from SD memory cards

- ① Insert the SD memory card on which the data is stored into the SD memory card slot.
Load the file after its data has been stored in the each folder. Data stored in other folders will not be recognized by the unit.

System data: "HS400/SYSTEM" folder
Still image data: "HS400/IMAGE" folder

- ② On the MEMORY menu, turn [F1] to display the SDCard sub menu.
③ Turn [F2] to select "Load" using the Mode item, and then press the [F2] switch.

<Menu display>

SDCard	Mode↓	Select	LoadFile	Exec↓
3/4	*Load	FMEM1	HS070531100000	

FMEM2
System

- ④ Turn [F3] to select the transfer destination using the Select item.
⑤ Using the LoadFile item, turn [F4] to select the name of the file to be loaded.
⑥ If the [F5] switch is now pressed, the file is loaded from the SD memory card and stored in the unit's internal memory.

While the file is being loaded, the following message and filename are displayed.

SDCard	...Loading File...
3/4	HS070531100000

- Up to 100 files can be loaded.
- The following alphanumeric characters and symbols can be used as the characters for filenames (see below). Files using other characters will not be displayed by the unit.

<Characters which can be used for filenames>

A to Z, a to z, 0 to 9, Space, ! # \$ % & ' () + , - . : ; = @ [] ^ _ ` { }

3. Basic operations

3-12-4. Deleting files on SD memory cards

- ① Insert the SD memory card on which the data is stored into the SD memory card slot.
- ② On the MEMORY menu, turn [F1] to display the SDCard sub menu.
- ③ Turn [F2] to select “Delete” using the Mode item, and then press the [F2] switch.

<Menu display>

SDCard	Mode↓	Select	DelFile?	No
3/4	*Delete	FMEM	HS070531100000	
		System		Yes↓

- ④ Turn [F3] to select the FMEM (Still image data) or System (System data) using the Select item.
- ⑤ Using the DelFile? item, turn [F4] to select the name of the file to be deleted.
- ⑥ Turn [F5] to select “Yes”, then press the [F5] switch, and the file is now deleted.

3-12-5. Displaying the SD memory card information

The number of images stored on the SD memory card as well as the card’s total memory and remaining free space are displayed.

- ① Insert the SD memory card on which the data is stored into the SD memory card slot.
- ② On the MEMORY menu, turn [F1] to display the CardInfo sub menu.

<Menu display>

CardInfo	Images	FreeSpace	GetInf↓
4/4	10	10MB/512MB	

Images: The number of still image files stored on the SD memory card is displayed.
The number of files that can be loaded using the unit is 100.
“Over100” is displayed when an attempt is made to store 101 or more files.

FreeSpace: The SD memory card’s total memory and remaining free space are displayed.
(Free space/card’s total memory)

- ③ Press the [F5] switch, and the display of information of Images item and FreeSpace item is updated.

4. Input/output signal settings

4-1. Setting the SDI input signals and analogue input signals

The user can set the SDI input signals and analogue input signals.

IN5 to IN8 can be set only when one of the following optional boards has been connected:

- SDI input board
- Analogue input board
- Analogue composite input board

4-1-1. Setting the frame synchronizer

The frame synchronizer can be set to On or Off for each input.

The DVI input (option) frame synchronizer is permanently On. It cannot be set from On to Off or vice versa.

- ① Press the [FUNC] button to light its indicator, and press the [IN/OUT] button to display the IN/OUT menu.
- ② Turn [F1] to display the Input sub menu.
- ③ Turn [F2], select the input signals using the Signal item, turn [F3], and select On or Off for the frame synchronizer using the FS item.

* If the output signal phase is set to 0H, Off cannot be selected as the FS item setting.

<Menu display>

Input	Signal	FS	Mode↓	AnaGain
1/15	In1	On	*Normal	0
	IN1-8	Off	D by D	-30-+30
			UC	
			Auto	

AVDL function is active while the frame synchronizer function is set to Off.

The AVDL function automatically adjusts the input image signal phase to the horizontal synchronization reference signal phase.

For details, refer to "4-6. Adjusting the output signal phase".

4. Input/output signal settings

4-1-2. Setting the input mode

The mode can be set for each input only when HD has been selected as the system format. When SD is selected as the system format, the input mode is always the same as Normal.

Normal: Input signals in conformity with the system format take effect.

D by D: When SD signals with the same frame rate as the system format have been input, they are input on a dot by dot (1× magnification) basis with no up-conversion. (This setting is only possible when the system format is 1080i.) In this mode, there is minimal deterioration in the image quality and, as such, the mode is used to combine SD format material using the PinP function.

UC: When SD signals with the same frame rate as the system format have been input, they are up-converted. (This mode can be selected for inputs 5 to 8 only.)

Auto: Input signals in conformity with the system format take effect. Furthermore, if SD signals with the same frame rate as the system format are input when HD is selected as the system format, they are up-converted. (This mode can be selected for SDI inputs 5 to 8 only.)

- In the Auto mode, the images may be disturbed when the input signals are switched.

- ① On the Input sub menu, turn [F2] to select the input signals using the Signal item.
- ② Turn [F4] to set the input mode using the Mode item, and press the [F4] switch to enter the selection. An asterisk (*) appears at the left of the input mode currently selected.

<List of input modes supported>

System	Mode	Input						
		480/59.94i	576/50i	1080/59.94i	1080/50i	720/59.94p	720/50p	
SD	480/59.94i	○	■	■	■	■	■	
	576/50i	■	○	■	■	■	■	
HD	1080/59.94i	Normal	■	■	○	■	■	■
		D by D	○	■	■	■	■	■
		UC	○	■	■	■	■	■
		Auto	○ (UC)	■	○	■	■	■
	1080/50i	Normal	■	■	■	○	■	■
		D by D	■	○	■	■	■	■
		UC	■	○	■	■	■	■
		Auto	■	○ (UC)	■	○	■	■
	720/59.94p	Normal	■	■	■	■	○	■
		UC	○	■	■	■	■	■
		Auto	○ (UC)	■	■	■	○	■
	720/50p	Normal	■	■	■	■	■	○
UC		■	○	■	■	■	■	
Auto		■	○ (UC)	■	■	■	○	

- ■ denotes a black screen.
- The UC mode or Auto mode cannot be selected for inputs 1 to 4.
- If D by D, UC or Auto mode is selected, the frame synchronizer will be turned on.
- The input mode cannot be changed when freeze is set to on.

4. Input/output signal settings

4-1-3. Setting the analogue input gain

When the analogue input board (option) has been connected, the gain of the input signals can be set. Alternatively, when the analogue composite input board (option) has been connected, the gain of the Y signals can be set.

The setting range is ± 30 steps, and the gain changes by approximately ± 2 dB. The amount of change in the gain when it is changed by one step is not fixed.

- ① On the Input sub menu, turn [F2] to select the input signals using the Signal item.
- ② Turn [F5] to set the input signal (or Y signal) gain using the AnaGain item.

4-1-4. Setting the analogue composite input signals

When the analogue composite input board (option) has been connected, the analogue composite input signals can be set.

- ① Press the [FUNC] button to light its indicator, and press the [IN/OUT] button to display the IN/OUT menu.
- ② Turn [F1] to display the CmpsitIn sub menu.
- ③ Turn [F2] to select the input signal using the Signal item.

<Menu display>

CmpsitIn	Signal	Chroma	Ped	Hue
14/15	IN5	0	0	0
	IN5-8	-8-+7	-100 +100	-30-+30

- ④ Turn [F3] to adjust the chroma level using the Chroma item.
(Maximum amount of variation: approx. ± 3 dB)
The Auto Colour Control function is activated, and the chroma level is kept at the value that has been set.
- ⑤ Turn [F4] to adjust the pedestal level using the Ped item.
(Maximum amount of variation: approx. ± 100 mV)
- ⑥ Turn [F5] to adjust the hue using the Hue item.
(Maximum amount of variation: approx. $\pm 20^\circ$)
Adjustment of Hue is possible when the system format is 1080/59.94i, 720/59.94p and 480/59.94i.

For details on the other settings, refer to the operating instructions of the optional board.

4. Input/output signal settings

4-2. Setting the up-converter (option)

Select the settings for the up-converter that is built into the optional boards listed below.

- SDI input board
- Analogue input board
- Analogue composite input board

- ① Press the [FUNC] button to light its indicator, and press the [IN/OUT] button to display the IN/OUT menu.
- ② Turn [F1] to display the UpConvrt sub menu.
An asterisk (*) appears at the left of the parameter currently selected.

<Menu display>

UpConvrt	Signal	Scale↓	MovDet↓	Sharp↓
13/15	IN5	*SQ	*3	*3
	IN5-8	EC	1-5	1-5
		LB		

- ③ Turn [F2] to select the input signal using the Signal item.
- ④ Turn [F3] to select the scaling system using the Scale item, and press the [F3] switch to enter the selection.

SQ (squeeze): The image is enlarged both horizontally and vertically to fill the entire screen.

EC (edge crop): The aspect ratio of the image is maintained, the image size is increased in accordance with the vertical resolution, and black bands are added at the left and right.

LB (letter box): The aspect ratio of the image is maintained, the image size is increased in accordance with the horizontal resolution, and the image is cropped at the top and bottom.

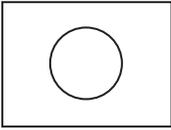
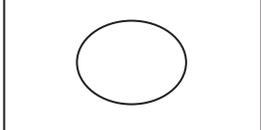
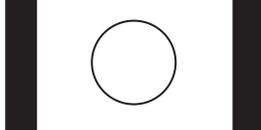
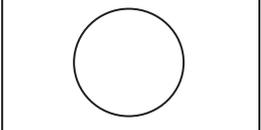
Input image	SQ	EC	LB
			

- ⑤ Turn [F4] to set the image movement detection sensitivity using the MovDet item, and press the [F4] switch to enter the selection.
1: Toward still images ↔ 3: standard ↔ 5: toward moving images
- ⑥ Turn [F5] to set the extent of the edge sharpness for the images using the Sharp item, and press the [F5] switch to enter the selection.
1: Not sharp edges ↔ 3: standard ↔ 5: very sharp edges

For details on the other settings, refer to the operating instructions of the optional board.

4. Input/output signal settings

4-3. Setting the DVI input signals (option)

4-3-1. Setting the DVI input signals

The user can set the DVI input signals when the DVI input board (option) has been connected. Signals with the following resolutions can be input. If signals with any other resolution or frequency are input, the picture will turn black.

- XGA (1024×768), 60 Hz
- WXGA (1280×768), 60 Hz
- SXGA (1284×1024), 60 Hz

- ① Press the [FUNC] button to light its indicator, and press the [IN/OUT] button to display the IN/OUT menu.
- ② Turn [F1] to display the DVIIN sub menu.

<Menu display>

DVIIN	Signal	Mode	Scale	Auto↓
10/15	IN5	Dig	Fit-V	Black
	IN5-8	Ana	Fit-H	White
			Full	Init

- ③ Turn [F2] to select the input signal using the Signal item, and turn [F3] to select the signal system using the Mode item.

Dig: Digital input signals of the DVI connector are effective.

Ana: Analogue input signals of the DVI connector are effective.

- ④ Turn [F4] to select the scaling method.

Fit-V: The aspect ratio of the input images is maintained, and the size of the images is increased or reduced in accordance with the vertical resolution.

Fit-H: The aspect ratio of the input images is maintained, and the size of the images is increased or reduced in accordance with the horizontal resolution.

Full: The size of the input images is increased or reduced in accordance with the system resolution. (The aspect ratio of the input images is not kept the same. The rate at which the image size is increased or reduced in the vertical direction and in the horizontal direction differs.)

For details on the sizes that correspond to the formats, refer to “DVI input scaling size table” on the next page.

- ⑤ The black level (offset) and white level (gain) of the analogue input signals are adjusted automatically. Depending on the personal computer used, there may be some deviation from the correct levels of the black level or white level.

To proceed with automatic adjustment to correct this deviation, display the black-and-white signals (BW.bmp) on the supplied CD-ROM or the full-screen black signals and full-screen white signals on the personal computer connected to the DVI input connector, and input these signals as the DVI input signals. When using the black-and-white signals, position them so that the boundary between black and white comes to the centre of the monitor screen.

When using the full-screen black signals or full-screen white signals, display the black or white in an area that covers at least 80 % of the screen from the screen centre.

Before making any adjustments, follow the instructions given in the “Automatic adjustment of the black level” section.

Automatic adjustment of the black level

Input the black-and-white signals (BW.bmp) or full-screen black signals.

Turn [F5] to select “Black” in the Auto item, and press [F5] to adjust the black level automatically.

After the level has been adjusted, an asterisk (*) appears to the left of Black.

Automatic adjustment of the white level

Input the black-and-white signals (BW.bmp) or full-screen white signals.

Turn [F5] to select “White” in the Auto item, and press [F5] to adjust the white level automatically.

After the level has been adjusted, an asterisk (*) appears to the left of White.

Initializing the adjusted values

Turn [F5] to select “Init” in the Auto item, and press [F5] to return the adjusted values to their factory settings.

At this time, the asterisk (*) displayed on the left is cleared.

4. Input/output signal settings

<DVI input scaling size table>

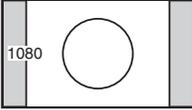
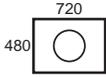
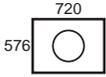
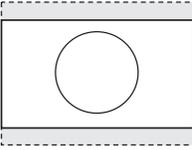
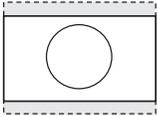
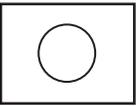
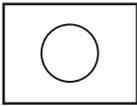
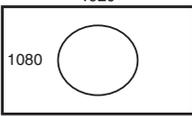
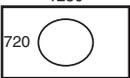
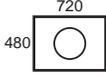
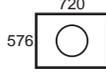
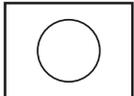
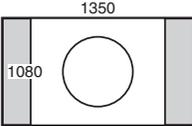
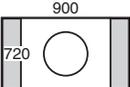
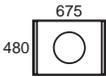
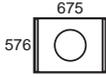
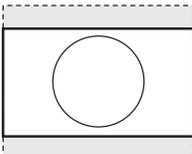
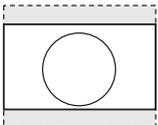
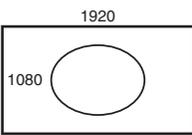
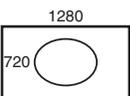
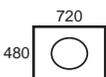
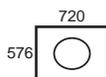
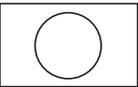
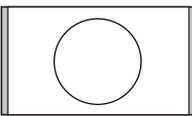
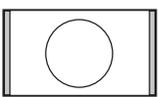
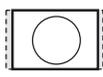
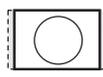
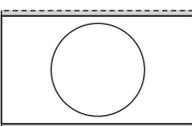
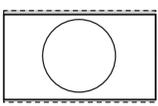
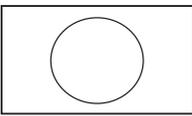
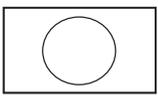
DVI format	Mode	HD/1080i	HD/720P	SD/NTSC	SD/PAL
		1920 × 1080	1280 × 720	720 × 480	720 × 576
XGA 1024×768 	Fit-V	1440 	960 	720 	720 
	Fit-H				
	Full	1920 1080 	1280 720 	720 480 	720 576 
SXGA 1280×1024 	Fit-V	1350 1080 	900 720 	675 480 	675 576 
	Fit-H				
	Full	1920 1080 	1280 720 	720 480 	720 576 
WXGA 1280×768 	Fit-V				
	Fit-H				
	Full				

 : Black images are inserted here.
 : The parts of the images protruding in these areas are cropped.

4. Input/output signal settings

4-3-2. Adjusting the DVI input signals

Adjust the clock/phase and position of the DVI input signals.

- ① Press the [FUNC] button to light its indicator, and press the [IN/OUT] button to display the IN/OUT menu.
- ② Turn [F1] to display the DVIPhs sub menu.

<Menu display>

DVIPhs	Signal	ClkPhs	H-Pos	V-Pos
11/15	IN5	0	0	0
	IN5-8	-16	-100	-100
		+15	+100	+100

- ③ Turn [F2] to select the input signal using the Signal item.
- ④ Turn [F3] to adjust the clock phase of the analogue input signals using the ClkPhs item.
While viewing the image quality, set the value at which the noise level is minimized.
- ⑤ Turn [F4] to adjust the horizontal position using the H-Pos item.
- ⑥ Turn [F5] to adjust the vertical position using the V-Pos item.

4. Input/output signal settings

4-4. Setting the output signals

4-4-1. Types of output signals

There are five output signal types: PGM, PVW, AUX, MULTI and KEYOUT.

Five lines of output signals can be assigned to OUTPUT1 to 6.

PGM: This is the main-line output of the switcher; images with wipe, mix, key and other effects added to them are output.

PVW: This is the preview output which enables the next operation to be checked in advance.

AUX: Signals selected by the AUX bus are output.

MULTI: This is the multi view display output. The multiple input signals and output signals are reduced and output to one screen.

KEYOUT: This outputs the key signals.

Connector	Signal type	Output (default)	Assignment
PGM1, 2	SDI	PGM	Cannot be assigned.
OUTPUT1	SDI	MULTI	PGM, PVW, AUX, MULTI, KEYOut
OUTPUT2	SDI	AUX	
OUTPUT3 (optional output slot 1-1)	ANALOG, SDI, DVI	MULTI	
OUTPUT4 (optional output slot 1-2)	ANALOG, SDI	AUX	
OUTPUT5 (optional output slot 2-1)	ANALOG, SDI, DVI	MULTI	
OUTPUT6 (optional output slot 2-2)	ANALOG, SDI	AUX	

4. Input/output signal settings

4-4-2. Assigning the output signals

Assign the output signals to OUTPUT1 to 6.

- ① Press the [FUNC] button to light its indicator, and press the [IN/OUT] button to display the IN/OUT menu.
- ② Turn [F1] to display the Output sub menu.
- ③ Turn [F2] to select the signal name using the Signal item, and turn [F3] to set the type of output signal using the Output item.

<Menu display>

Output	Signal	Output	Mode↓
2/15	OUT1	PGM	*Normal
	OUT1-6	PVW	DC
		AUX	
		Multi	
		KEYOut	

- ④ When the SDI output board (option) has been connected, turn [F4] to set the output mode using the Mode item, and press the [F4] switch to enter the setting.
An asterisk (*) appears on the left of the currently selected output mode.

Normal:

The same signals as the system format signals are output.

DC (down-converter):

When the system format is 1080/59.94i or 720/59.94p, the signals are output in the 480/59.94i format.

When the system format is 1080/50i or 720/50p, the signals are output in the 576/50i format.

When the system format is SD (480/59.94i or 576/50i), this setting cannot be selected.

4. Input/output signal settings

4-5. Setting the sync signals

The sync signals to be used by the system can be selected.

External sync: For synchronization with an external sync signal (gen-lock).

The reference input signal is looped through and output.

BBST: Black burst signal (vertical phase of 0H)

BBAD: Black burst signal

(Vertical phase of 90H when the 59.94i or 59.94p format is selected;
vertical phase of 75H when the 50i or 50p format is selected)

TRI: Tri-level sync signal (vertical phase of 0H)

This can be selected when HD format signals are supplied.

Internal sync: For synchronization with an internal reference signal (INT).

The REFOUT signal (black burst signal) is output from the two reference connectors.

- ① Press the [FUNC] button to light its indicator, and press the [IN/OUT] button to display the IN/OUT menu.
- ② Turn [F1] to display the Ref sub menu.

<Menu display>

Ref	Sync↓	BBSetup	GenLock
3/15	*BBST	7.5IRE	Locked
	BBAD	0IRE	UnLock
	TRI		
	INT		

- ③ Turn [F2], select the sync signal using the Sync item, and press the [F2] switch to enter the selection.
An asterisk (*) appears at the left of the reference signal currently selected.
- ④ Turn [F3] to select the setup level of the black burst signal in the internal synchronization mode using the BBSetup item.
This setting takes effect when the video system is 59.94i or 59.94p.
The setup level is fixed at 0 IRE when the system is 50i or 50p.

The genlock status is displayed in the GenLock item.

Locked: Synchronized with the external sync signal or internal reference signal.

UnLock: Not synchronized with the external sync signal or internal reference signal.

4. Input/output signal settings

4-6. Adjusting the output signal phase

The phase of the output video signals can be adjusted.

- ① Press the [FUNC] button to light its indicator, and press the [IN/OUT] button to display the IN/OUT menu.
- ② Turn [F1] to display the OutPhs sub menu.

<Menu display>

OutPhs	System	H-Phase	V-Phase
4 / 15	0H	0	0
	1H	-1320	-100
		+1319	+100

- ③ Turn [F2], and select 0H or 1H using the System item.

0H: The output video signals are output to the system REF signal with using in-phase.
The frame synchronizer function is ON for all input signals.

1H: The output video signals are output to the system REF signal with 1H delay.
When the frame synchronizer function is ON, the output video signals are output with 1 frame + 1H delay.

- ④ Turn [F3] to adjust H phase using the H-Phase item.
H-Phase can be adjusted within a range of $-0.5H$ to $+0.5H$.
- ⑤ Turn [F4] to adjust V phase using the V-Phase item.
V-Phase can be adjusted within a range of $-100H$ to $+100H$.

Output video signal phase adjustment

Phase	Video format	Adjustment range
H-Phase	1080i/59.94i	-1100 to 1099
	1080/50i	-1320 to 1319
	720/59.94p	-825 to 824
	720/50p	-990 to 989
	480/59.94i	-429 to 428
576/50i	-432 to 431	
V-Phase	Same for all formats	-100 to 100

4. Input/output signal settings

<Phase adjustment setup>

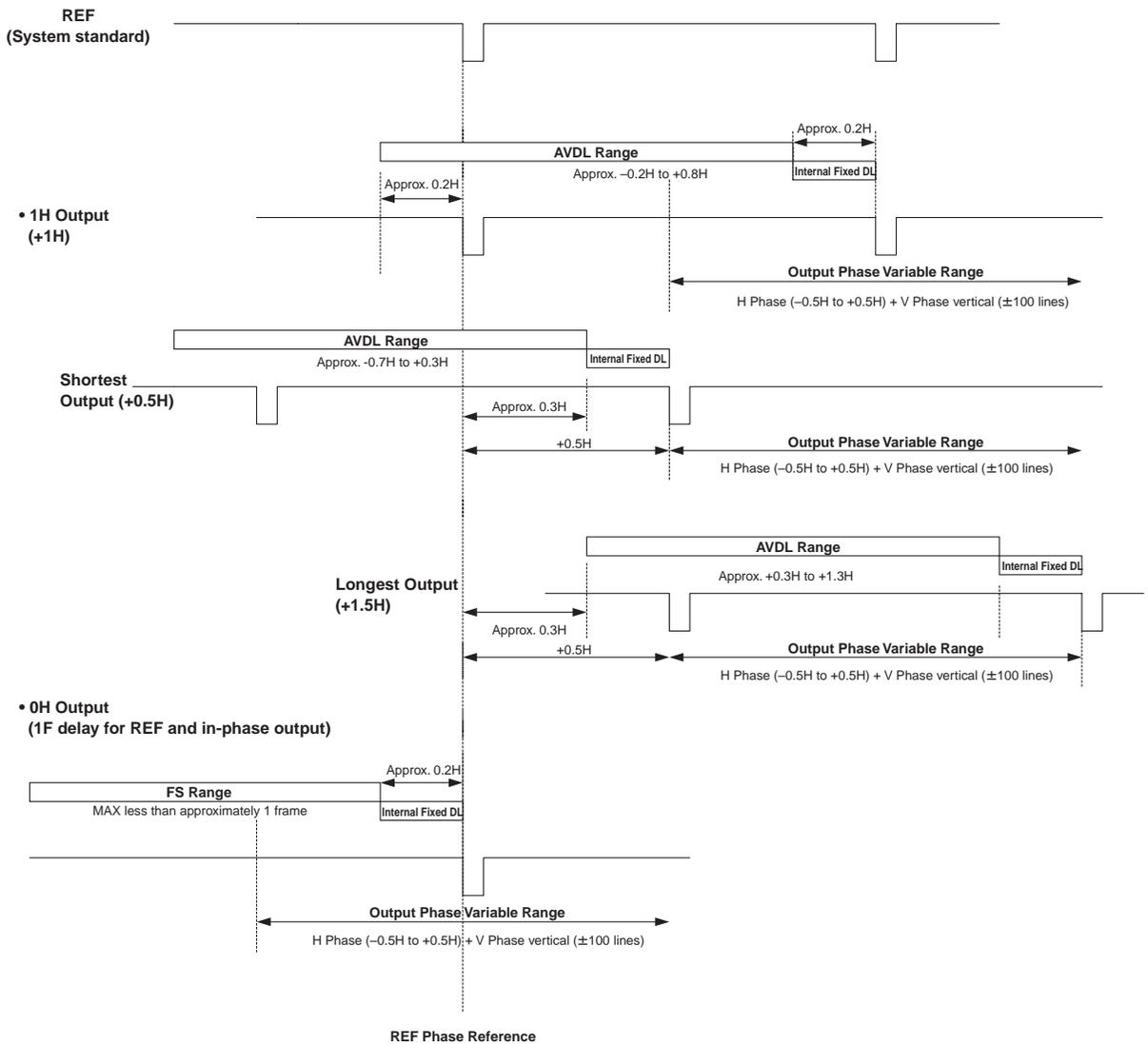

AVDL Range: Range for automatic phase adjustment.

4. Input/output signal settings

<Phases and delay amounts of input/output signals during HD format use>

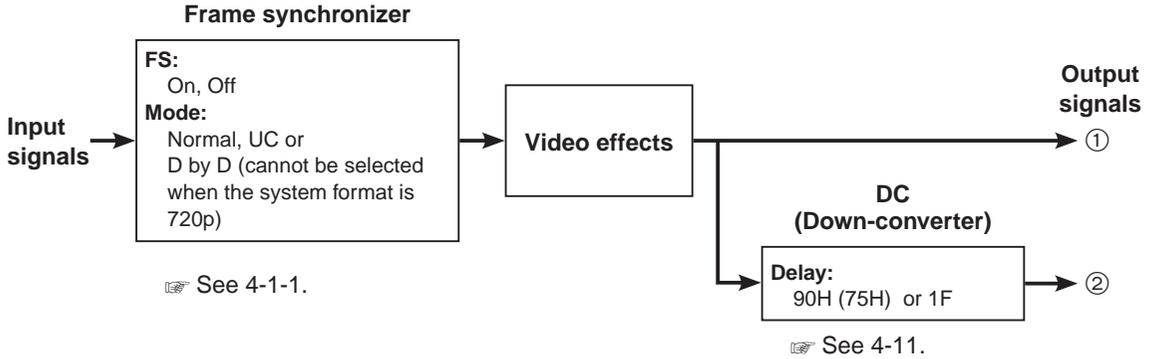

When the 1080/59.94i format is used:

- * For 1080/50i, 720/59.94p and 720/50p, the delay of "Output signal ② DC (90H)" is further delayed by +1F.
- * For 1080/50i and 720/50p, 90H indicated below becomes 75H.

OutPhs	Input		Non-synchronized input	Output signal ① Normal		Output signal ② DC (90H)		Output signal ② DC (1F)	
	Mode	FS		Phase	Delay amount	Phase	Delay amount	Phase	Delay amount
Sync signal (Ref): Black burst signal (BBST), tri-level sync signal (TRI), internal reference signal (INT)									
1H	Normal	Off	Not possible	Ref+1H	1H	①+90H	1H+90H	In-phase with ①	1H+1F
	Normal	On	Possible	Ref+1H	Max. 1F+1H	①+90H	Max. 1F+1H+90H	In-phase with ①	Max. 2F+1H
	UC/D by D	On (Forced)	Possible						
0H (Example 1)	Normal/UC/D by D	On (Forced)	Possible	In-phase with Ref	Max. 1F	①+90H	Max. 1F+90H	In-phase with ①	Max. 2F
Sync signal (Ref): Black burst signal (BBAD)									
1H	Normal	Off	Not possible	Ref-90H+1H	1H	①+90H	1H+90H	In-phase with ①	1F+1H
	Normal	On	Possible	Ref-90H+1H	Max. 1F-90H+1H	①+90H	Max. 1F+1H	In-phase with ①	Max. 2F-90H+1H
	UC/D by D	On (Forced)	Possible						
0H (Example 2)	Normal/UC/D by D	On (Forced)	Possible	Ref-90H	Max. 1F-90H	①+90H (In-phase with Ref)	Max. 1F	In-phase with ①	Max. 2F-90H

- * Conversion based on the HD format applies for 1H.
- * When DVE effects (SQ, SL, 3D) have been used as the video effects, the output signal is delayed by +1F.
- * The phase and delay amount for the DVI-I input signals are the same as when UC/D by D is selected since the frame synchronizer is set to the On mode.
- * The DVI-I output signals are delayed by +1F.
- * When images are output to a multi view display, they are delayed by +1F.
When DVI-I output signals are output to a multi view display, the output images are delayed by +2F.

4. Input/output signal settings

<Phase relationship between input signals and output signals> (for 1080/59.94i format)

(Example 1)

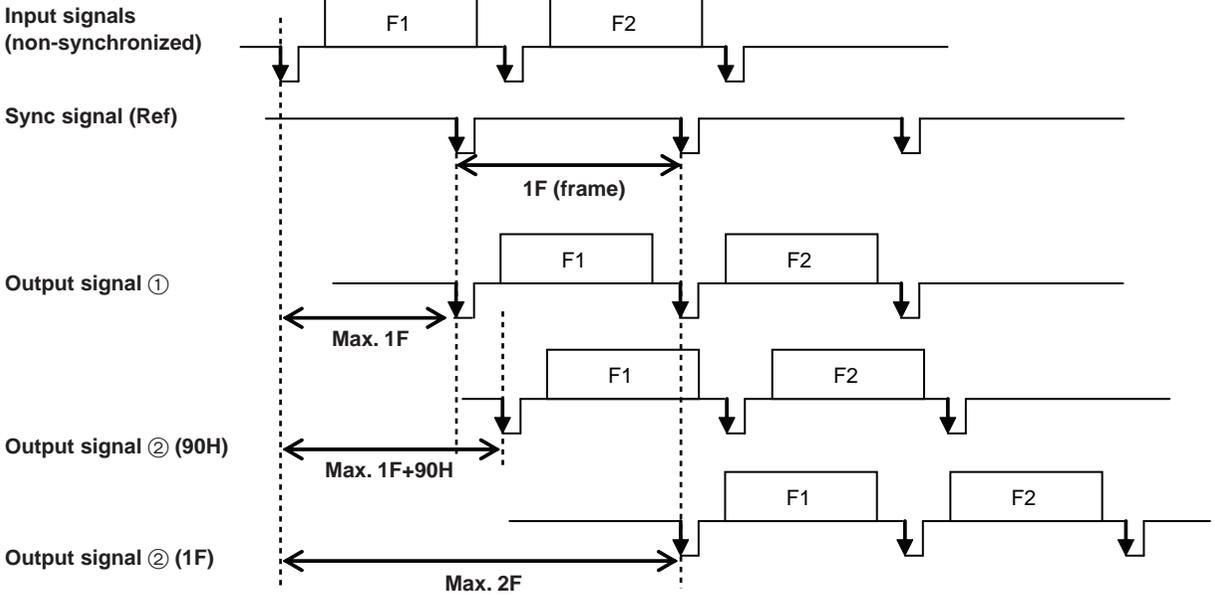

(Example 2)

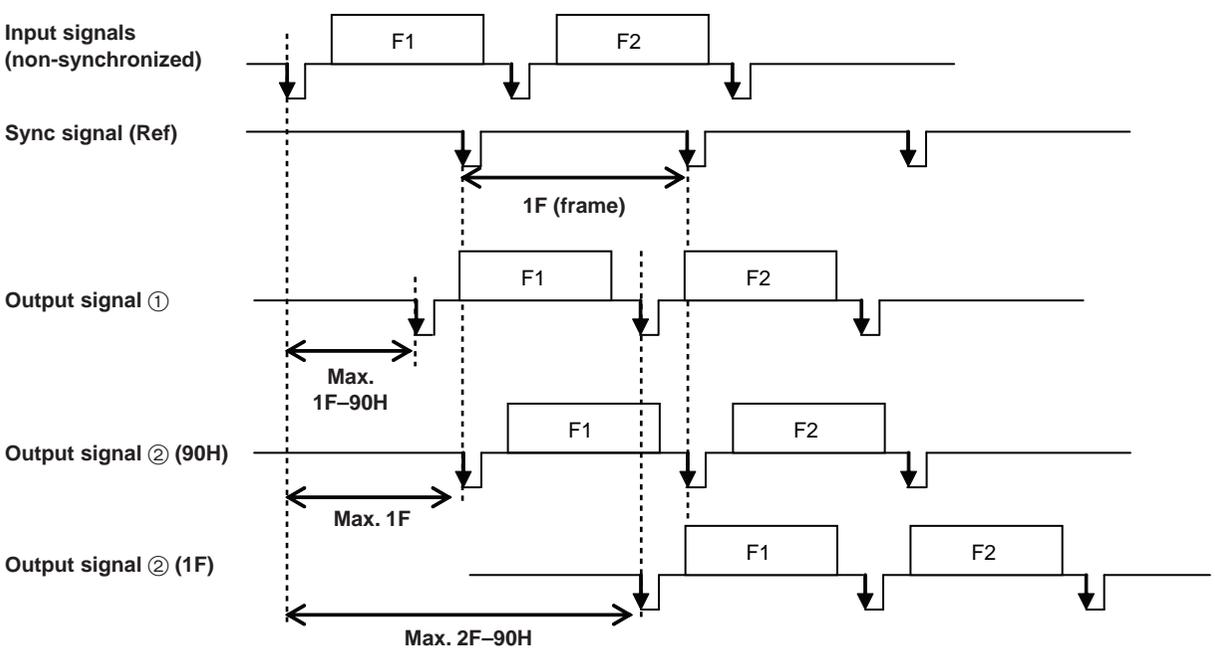

4. Input/output signal settings

4-7. Setting the multi view display

The input images, programme images and preview images can be output side by side on one screen on the external monitor.

4-7-1. Setting the screen layout

The multi view display has three display modes: 10-division mode, 4-division mode and 8-division mode.

Inputs 1 to 8, frame memory and colour background can be assigned to sub screens ① to ⑧.

It is also possible to assign programme (PGM), preview (PVW), AUX and KeyOut to the Upper-L and Upper-R sub screens.

When OSD is displayed for PVW, it is also displayed for PVW of the multi view display.

In 8-division mode, the aspect ratio can be kept at 16:9 for the display of HD format images when these images are displayed in the SXGA size from the DVI output (option).

(Size is set to "SXGA" and Scale is set to "5:4" using the DVI output settings.)

<Display modes>

10-division mode:

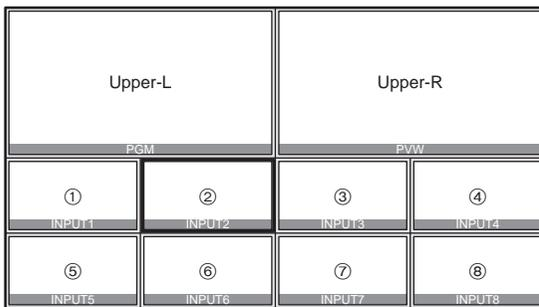

4-division mode:

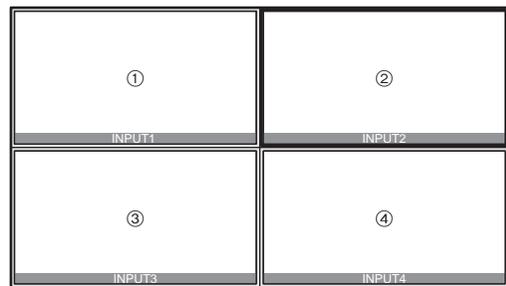

8-division mode:

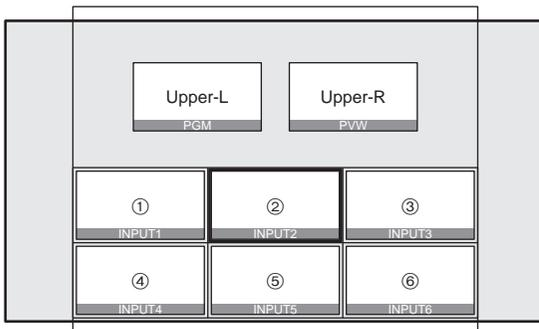

4. Input/output signal settings

- ① Press the [FUNC] button to light its indicator, and press the [IN/OUT] button to display the IN/OUT menu.
- ② Turn [F1] to display the Multi1 sub menu.

<Menu display>

Multi1 6/15	Split 10Split	Pos 1	Signal IN1
	4Split 8Split	1-8	IN1-8 FMEM1 FMEM2 CBGD
		Upper-L Upper-R	PGM PVW AUX KeyOut

- ③ Turn [F2] to select the display mode using the Split item.
- ④ Turn [F4] to select the position (① to ⑧, Upper-L and Upper-R in the figures) using the Pos item, and turn [F5] to set the name of the signal using the Signal item.
Different settings are stored for 10-division mode, 4-division mode and 8-division mode.

1 to 8:

This can be set to IN1 to IN8, FMEM1, FMEM2 or CBGD.
IN1 to IN8 is the default setting for Pos1 to Pos8 in any of the modes.

Upper-L, Upper-R:

These can be set to PGM, PVW, AUX or KeyOut.
They cannot be set when the 4-division mode (4Split) is selected.
The default settings are PGM for Upper-L and PVW for Upper-R.
The names of the signals selected as the AUX output signals are displayed in [] as with [CLN], [PVW] and [PGM].

Some signal names are abbreviated as shown below, and displayed.
FMEM1 → [FM1], FMEM2 → [FM2], CBGD → [CBG], CBAR → [BAR]

4. Input/output signal settings

4-7-2. Setting the split frame and characters

Set the frame, character brightness and background of the split screens to be displayed on the multi view display.

- ① Press the [FUNC] button to light its indicator, and press the [IN/OUT] button to display the IN/OUT menu.
- ② Turn [F1] to display the Multi2 sub menu.

<Menu display>

Multi2	Frame	Char	Label	Tally
7/15	LUM 50%	LUM 75%	On	Red+GRN
	LUM 0%	LUM 0%	Off	Red
	LUM 25%	LUM 25%		Off
	LUM 75%	LUM 50%		
	LUM100%	LUM100%		
	Off	Off		

- ③ Turn [F2] to set the split frame brightness and split frame display using the Frame item.

LUM (0%, 25%, 50%, 75%, 100%):

Select one of these settings for the brightness of the split frame (gray scale).

Off: The split frame is not displayed, and tally display is not performed.

- ④ Turn [F3] to set the character brightness and character display using the Char item.

LUM (0%, 25%, 50%, 75%, 100%):

Select one of these character (gray scale) brightness settings.

The “!” mark appears in front of the name of the material when no signals are input or signals with a different format are input.

Furthermore, when signals amenable to camera control have been input, the “c” mark is displayed in front of the name of the material.

(When the “!” mark is displayed, the “c” mark will not be displayed.)

Off: The characters are not displayed. Neither is the character background shown.

- ⑤ Turn [F4] to set whether the character background (half-tone) is to be displayed using the Label item.

On: The character background is displayed.

Off: The character background is not displayed.

4-7-3. Setting the tally displays

Set the tally displays to be superimposed onto the split frame of the multi view display.

The red tally indicates material consisting of programme outputs.

The green tally indicates material selected by the preset bus.

On the Multi2 sub menu, turn [F5] to set the tally displays using the Tally item.

Red+GRN: Both the red tally and green tally are displayed.

Red: Only the red tally is displayed.

Off: No tally displays are shown.

* The red tally is not displayed during FTB operation while the programme images have been completely faded out to a black screen. At this time, the green tally is displayed for images consisting of programme images.

* The red tally signals are output from the tally output connector on the rear panel. Green tally signals are not supported.

4. Input/output signal settings

4-7-4. Changing the material names

Change the INPUT1 to INPUT8 material names shown on the multi view display.

The default settings, preset settings or user settings can be selected for these names.

When the preset settings and user settings are established, the “input number : material name” (1 : CAM1, etc.) display format is used.

- ① Press the [FUNC] button to light its indicator, and press the [IN/OUT] button to display the IN/OUT menu.
- ② Turn [F1] to display the Multi3 sub menu.

<Menu display>

Multi3	Signal	Type↓	Name
8/15	IN1	*Default	INPUT1
	IN1-8	Preset	INPUT1
		User	INPUT8

- ③ Turn [F2] to select the input signals using the Signal item.
- ④ Turn [F3] to select the type of material name using the Type item, and press the [F3] switch to enter the type. An asterisk (*) appears at the left of the type of material name currently selected.

Default: The default settings for INPUT1 to INPUT8 are selected.

Preset: The material names and number provided ahead of time are selected.

User: The material names are set using 6 characters.

If the Type item setting is changed when “Preset” or “User” is selected, the previously provided material names will be lost.

■ Preset type setting procedure

- ① On the Multi3 sub menu, turn [F3] to select “Preset” using the Type item.
- ② Turn [F4] to select the material name using the Name item.
- ③ Turn [F5] to select the material number using the NO. item, and press the [F5] switch to enter the number.

<Menu display>

Multi3	Signal	Type↓	Name	NO.(*)↓
8/15	IN1	*Preset	CAM*	1
	IN1-8		C*	1-9
			CG*	
			CGV*	
			CGK*	
			PC*	
			V*	
			VTR*	
			VCR*	

■ User type setting procedure

- ① On the Multi3 sub menu, turn [F3] to select “User” using the Type item.
- ② Turn [F4] to move the “■” cursor to the position of the character to be changed using the Name item.
- ③ Turn [F5] to select the character, and press the [F5] switch to enter it.
- ④ Set all the characters in the material name by repeating steps ② and ③.

<Menu display>

Multi3	Signal	Type↓	Name	(■)↓
8/15	IN1	*User	■am1	C
	IN1-8			

4. Input/output signal settings

4-8. Setting the on-screen display (OSD)

The menu screen is superimposed on the preview output or multi view display output for display.

- ① Press the [FUNC] button to light its indicator, and press the [IN/OUT] button to display the IN/OUT menu.
- ② Turn [F1] to display the OSD sub menu.

<Menu display>

OSD	OSD	Select		
5/15	On	PVW		
	Off	Multi		

- ③ Turn [F2] to set whether to display the OSD using the OSD item.
 - On:** OSD is displayed.
 - Off:** OSD is not displayed.

This function can be assigned to a user button. See 5-3-1.
- ④ Turn [F3] to set the output destination using the Select item.
 - PVW:** The menu screen is superimposed onto the preview output, and output.
 - Multi:** The menu screen is superimposed onto the multi view display output, and output.

* When On is selected as the OSD item setting, the multi view display split frame and tally information are not displayed on the monitor.

Examples of OSD displays

">" appears to the left of the selected menu.

This indicates the wipe pattern for the background transition.

This indicates the wipe pattern for the key transition.

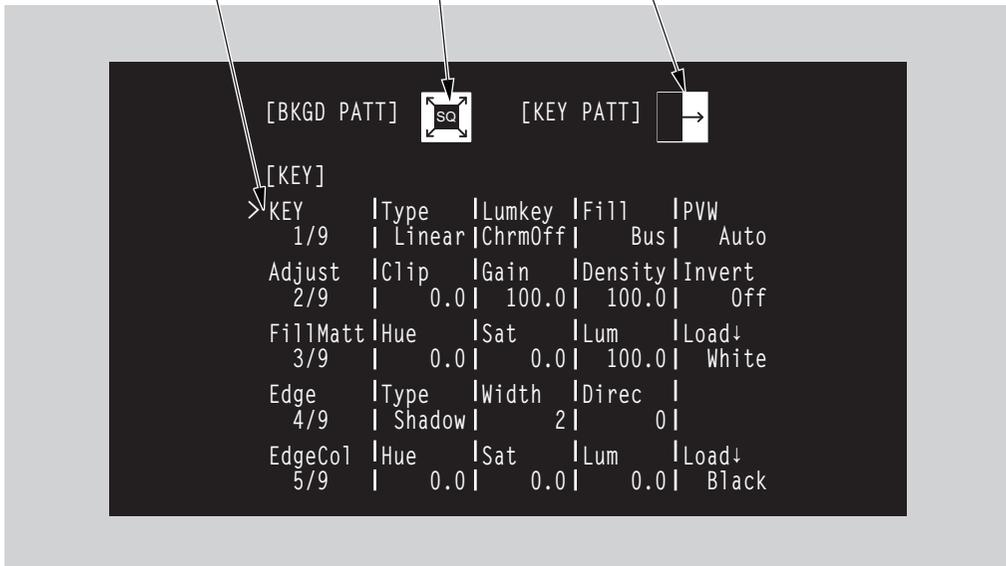

4. Input/output signal settings

4-9. Setting the DVI output signals (option)

Set the DVI output signals when the DVI/analogue output boards (option) have been connected.

- ① Press the [FUNC] button to light its indicator, and press the [IN/OUT] button to display the IN/OUT menu.
- ② Turn [F1] to display the DVIOut sub menu.
An asterisk (*) appears at the left of the parameter currently selected.

<Menu display>

DVIOut	Signal	Mode↓	Size↓	Scale↓
12/15	OUT3	*Dig	*Auto	*Fit-V
	OUT5	Ana	XGA	Fit-H
			WXGA	Full
			SXGA	5:4
			WSXGA+	
			UXGA	
			WUXGA	

- ③ Turn [F2] to select the output signal using the Signal item.
- ④ Turn [F3] to select the signal system using the Mode item, and press the [F3] switch to enter the selection.

Dig: DVI digital signals are output from the DVI connector.

Ana: DVI analogue signals (RGB) are output from the DVI connector.

When “Ana” has been selected, the display position of the image may be off depending on the monitor which is connected. If it is off, adjust the position at the monitor.

For details on the adjustment method, refer to the operating instructions of the monitor.

- ⑤ Turn [F4] to select the resolution of the images to be output, and press the [F4] switch to enter the selection.

Auto: The equipment information of the output destination is captured by the DVI signals, and the images are output at the optimum resolution. (The vertical frequency is 60 Hz, and the maximum resolution is SXGA for analogue output signals and WUXGA for digital output signals.)
If the equipment information cannot be captured or if the resolution and frequency which can be output by the product are not contained in the equipment information, the images will be output at the XGA setting.

XGA: The images are output at the 1024×768 resolution and 60 Hz frequency.

WXGA: The images are output at the 1280×768 resolution and 60 Hz frequency.

SXGA: The images are output at the 1280×1024 resolution and 60 Hz frequency.

WSXGA+: The images are output at the 1680×1050 resolution and 60 Hz frequency.
(This can be selected only when digital signals are output.)

UXGA+: The images are output at the 1600×1200 resolution and 60 Hz frequency.
(This can be selected only when digital signals are output.)

WUXGA: The images are output at the 1920×1200 resolution and 60 Hz frequency.
(This can be selected only when digital signals are output.)

- ⑥ Turn [F5] to select the scaling method, and press the [F5] switch to enter the selection.

Fit-V: The aspect ratio of the output images is maintained, and the size of the images is increased or reduced in accordance with the vertical resolution.
(Black bands are inserted into the areas where there are no images. The protruding parts of the images are cropped.)

Fit-H: The aspect ratio of the output images is maintained, and the size of the images is increased or reduced in accordance with the horizontal resolution.
(Black bands are inserted into the areas where there are no images. The protruding parts of the images are cropped.)

Full: The size of the output images is increased or reduced in accordance with the system resolution.
(The aspect ratio of the output images is not maintained. The rate at which the image size is increased or reduced in the vertical direction differs from that in the horizontal direction.)

5:4: When HD is set as the system format and SXGA is set for the resolution of the images to be output, the display in the 8-division mode of the multi view display fills the entire screen with no change in the aspect ratio.

4. Input/output signal settings

4-10. Setting the ancillary data

In this section, the function for allowing the ancillary data of the SDI input signals to pass through is set. If SD format signals are input while the HD format has been set as the system format, it will not be possible for their ancillary data to be passed through.

■ Setting the V ancillary data

It is possible to decide whether to allow the V ancillary data, which is superimposed in the vertical blanking period of the input images, to pass through the PGM bus.

The background bus data which is output to programme (PGM) is passed through for images whose transition has been cut off.

During a transition, the background bus data which was output to programme (PGM) immediately before is passed through.

- ① Press the [FUNC] button to light its indicator, and press the [IN/OUT] button to display the IN/OUT menu.
- ② Turn [F1] to display the Anci sub menu.

<Menu display>

Anci	VAnci	E.Audio		
9/15	Off	Off		
	On	On		

- ③ Turn [F2] to select On or Off for the V ancillary data using the VAnci item.

On: In the case of the HD format, the ancillary data starting with line 10 is passed through.

In the case of the SD format, the ancillary data starting with line 14 is passed through.

Off: The data is not passed through.

■ Setting the embedded audio data

The embedded audio data of the input images can be passed through the AUX bus.

(If PGM, PVW or CLN is selected as the AUX bus source, the embedded audio data cannot be passed through.)

On the Anci sub menu, turn [F3] to select On or Off for the embedded audio data using the E.Audio item.

On: The data is passed through.

Off: The data is not passed through.

When "On" has been selected, the V ancillary data of the input images is also passed through at the same time.

4. Input/output signal settings

4-11. Setting the down-converter

Select the settings for the down-converter that is built into the SDI output board (option).

- ① Press the [FUNC] button to light its indicator, and press the [IN/OUT] button to display the IN/OUT menu.
- ② Turn [F1] to display the DownConv sub menu.

An asterisk (*) appears at the left of the parameter currently selected.

<Menu display>

DownConv	Signal	Scale↓	Delay↓	Sharp↓
15/15	OUT3*	SQ*	90H*	1
	OUT4	EC	1F	1-5
	OUT5	LB		
	OUT6			

- ③ Turn [F2] to select the output signal using the Signal item.
- ④ Turn [F3] to select the scaling system using the Scale item, and press the [F3] switch to enter the setting.

SQ (squeeze):

The top, bottom, left and right are reduced so that the aspect ratio is set to 4:3.

EC (edge crop):

The aspect ratio is maintained, the image is reduced in size in line with the vertical resolution, and it is cropped at the left and right.

LB (letter box):

The aspect ratio is maintained, the image is reduced in size in line with the horizontal resolution, and a black image is added at the top and bottom.

System image (HD)	Output image (SD)		
	SQ	EC	LB

- ⑤ Turn [F4] to set the delay time of the output using the Delay item, and press the [F4] switch to enter the setting.

90H (75H):

When the system format is 1080/59.94i, the image is delayed from the system image (HD) by 90H, and output.

When the system format is 720/59.94p, the image is delayed from the system image (HD) by 90H+1F (frame), and output.

When the system format is 1080/50i, the image is delayed from the system image (HD) by 75H, and output.

When the system format is 720/50p, the image is delayed from the system image (HD) by 75H+1F (frame), and output.

When the system format is 1080/50i or 720/50p, "75H" is displayed on the menu.

1F: The image is output in-phase with a delay of 1 frame from the system image (HD).

For details on the phase and delay amounts, refer to "4-6. Adjusting the output signal phase".

- ⑥ Turn [F5] to set the degree of sharpness of the edges for the image using the Sharp item, and press the [F5] switch to enter the setting.

1: Standard up to **5:** sharper edges

For details on the other settings, refer to the operating instructions of the optional board.

5. System settings

5-1. Selecting the video format

One system (input/output signal) video format can be selected.

- ① Press the [FUNC] button to light its indicator, and press the [SYSTEM] button to display the SYSTEM menu.
- ② Turn [F1] to display the Format sub menu.
- ③ Turn [F2], select the format using the Mode item, and press the [F2] switch to enter the selection.
An asterisk (*) appears at the left of the format currently selected.

<Menu display>

Format	Mode↓		16:9SQ
1/16	*1080/59.94i		Off
	1080/50i		On
	720/59.94p		
	720/50p		
	480/59.94i		
	576/50i		

■ Setting the 16:9 squeeze mode

When the 16:9 squeeze mode is selected, a border width (wipe or PinP) is established that considers cases where SD format images are to be converted into the 16:9 aspect ratio and used.

This setting is possible when SD is selected as the system format setting.

On the Format sub menu, turn [F5] to select whether to support the squeeze mode using the 16:9SQ item.

On: The squeeze mode is supported.

Off: The squeeze mode is not supported.

Border width (graphical representation) when the squeeze mode is supported

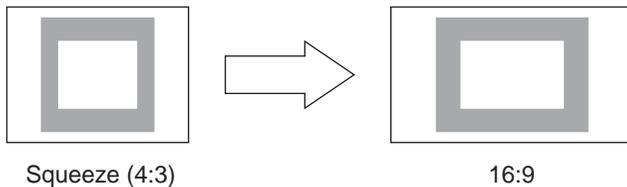

5. System settings

5-2. Setting the crosspoints

5-2-1. Assigning signals to the crosspoints

External video input signals and internally generated signals can be assigned to crosspoint buttons 1 to 10.

■Displaying the assignment statuses

- ① Press the [FUNC] button to light its indicator, and then press the [XPT] button to display the XPT menu.
- ② Turn [F1] to display the XPTStats sub menu.
The status of the assignment is displayed. The names of the assigned signals are abbreviated on the display.

<Menu display>

XPTStats	SIG:B	1	2	3	4	5	6	7	8	G
1/3	XPT:1	2	3	4	5	6	7	8	9	10

When one of the crosspoint buttons 1 to 10 is held down for a long time, the name of the signal assigned is displayed on the LCD while the button is held down.

Example: When crosspoint button 1 is pressed (when the INPUT1 signal has been assigned to this button)

XPTStats	SIG:IN1
	XTP:1

■Assigning signals to the crosspoints

- ① Press the [FUNC] button to light its indicator, and press the [XPT] button to display the XPT menu.
- ② Turn [F1] to display the XPTAssign sub menu.
- ③ Turn [F2], select the crosspoint button using the XPT item, turn [F3] and select the input signal using the Signal item.

Changing the current assignment of the signals selected by the crosspoint buttons will cause the positions of the lit crosspoint buttons to change to correspond with the assignment change. The images output at this time will remain unchanged.

<Menu display>

XPTAssign	XPT	Signal		
2/3	1	IN1		

1-10	IN1-8
	Black
	CBGD
	CBAR
	FMEM1
	FMEM2
	None

The table below lists the materials which can be assigned.

Button	Signal	Abbreviation		Description
XP1 to 10	INPUT1 to 8	IN1 to 8	1 to 8	SDI, analogue component, analogue composite and DVI
	BLACK	Black	B	Internally generated signal, black
	COLOR BACKGROUND	CBGD	G	Internally generated signal, colour background
	COLOR BAR	CBAR	C	Internally generated signal, colour bar
	FRAME MEMORY1, 2	FMEM1, 2	F1, F2	Frame memory image
	None	None	—	No assignment

* The image will not be changed by pressing any button to which "None" is assigned.

5. System settings

The table below lists the default settings.

Button	Signal	Description
XP1	BLACK	Internally generated signal, black
XP2	INPUT1	External video input 1: SDI
XP3	INPUT2	External video input 2: SDI
XP4	INPUT3	External video input 3: SDI
XP5	INPUT4	External video input 4: SDI
XP6	INPUT5	External video input 5: SDI, analogue component, analogue composite and DVI
XP7	INPUT6	External video input 6: SDI, analogue component, analogue composite and DVI
XP8	INPUT7	External video input 7: SDI, analogue component, analogue composite and DVI
XP9	INPUT8	External video input 8: SDI, analogue component, analogue composite and DVI
XP10	CBGD	Internally generated signal, colour background

If the optional board has not been connected, black images are input for INPUT5 to 8.

5-2-2. Setting the crosspoint switching

The timing at which the crosspoints are to be switched can be set.

- ① Press the [FUNC] button to light its indicator, and press the [XPT] button to display the XPT menu.
- ② Turn [F1] to display the XPTSwch sub menu.
- ③ Turn [F2], and select the switching timing using the Timing item.

<Menu display>

XPTSwch	Timing			
3/3	Any			
	Field1			
	Field2			

Any: The crosspoints are switched in the nearest field. This is suited to live applications.

Field1: The crosspoints are switched in field 1. This is suited to editing applications.

Field2: The crosspoints are switched in field 2. This is suited to editing applications.

5. System settings

5-3. Button assignments

5-3-1. Setting the user buttons

The user can assign several functions which can be set using the menu items into two user buttons (USER 1 and USER 2).

The user buttons light in amber when the assigned function is ON and are off when the assigned function is OFF. Each time the user button is pressed, the function setting alternates between ON and OFF.

The table below lists the functions which can be assigned to the user buttons.

Function	Description	Menu
PinPPVW	ON or OFF for preview of picture-in-picture (PinP) effect	PinP menu → PinP sub menu → PVW
DSKPVW	ON or OFF for preview of downstream key (DSK)	DSK menu → DSK sub menu → PVW
EditEN	ON or OFF for enabling control from RS-422 connector	SYSTEM menu → System sub menu → EDITEN
GPIEN	ON or OFF for enabling control from GPI port	SYSTEM menu → GPI sub menu → GPIEN
OSD	ON or OFF for OSD display	IN/OUT menu → OSD sub menu → OSD
StrFM1, StrFM2	Execution of image import from AUX bus to frame memory (FMEM1) or (FMEM2)	MEMORY menu → FMEM sub menu → Store

<Setting method>

- ① Press the [FUNC] button to light its indicator, and press the [SYSTEM] button to display the SYSTEM menu.
- ② Turn [F1] to display the Button sub menu.
- ③ Turn [F2] to select the function to be assigned to the USER 1 button using the USER1 item.
- ④ Turn [F3] to select the function to be assigned to the USER 2 button using the USER2 item.

<Menu display>

Button	USER1	USER2	FTB	
5/16	PinPPVW	DSKPVW	FTB	
	DSKPVW	PinPPVW	KEYAuto	
	EditEN	EditEN	Disable	
	GPIEN	GPIEN		
	OSD	OSD		
	StrFM1	StrFM1		
	StrFM2	StrFM2		

5-3-2. Setting the FTB button

A function can be assigned to the FTB button or the button's function can be disabled.

On the Button sub menu, turn [F4] to set assignment to the FTB button using the FTB item.

FTB: The fade to black (FTB) effect is executed.

KEYAuto: The auto transition of the key is executed.

Disable: The FTB button's function is disabled.

5. System settings

5-4. Setting the date and time

The user can set the date and time to be used as the SD memory card's time stamp.
Be absolutely sure to set them when an SD memory card is to be used.

■ Setting the date

- ① Press the [FUNC] button to light its indicator, and press the [SYSTEM] button to display the SYSTEM menu.
- ② Turn [F1] to display the Date sub menu.
- ③ Turn [F2] to set the year using the Year item.
- ④ Turn [F3] to set the month using the Month item.
- ⑤ Turn [F4] to set the day using the Date item.
- ⑥ Press the [F5] switch to enter the year/month/day.

<Menu display>

Date	Year	Month	Date	Set↓
13/16	2007	11	1	
	2000	1-12	1-31	
	2099			

■ Setting the time

- ① Press the [FUNC] button to light its indicator, and press the [SYSTEM] button to display the SYSTEM menu.
- ② Turn [F1] to display the Time sub menu.
- ③ Turn [F2] to set the hour using the Hour item.
- ④ Turn [F3] to set the minutes using the Minute item.
- ⑤ Turn [F4] to set the seconds using the Second item.
- ⑥ Press the [F5] switch to enter the hour/minutes/seconds.

<Menu display>

Time	Hour	Minute	Second	Set↓
14/16	0	0	0	
	0-23	0-59	0-59	

5. System settings

5-5. Network settings

Proceed with the network settings to perform such tasks as updating the software version via LAN. The network initial setup is: IP address: 192.168.0.10, subnet mask: 255.255.255.0 and gateway: 0.0.0.0 (unused). When using the host computer with settings matching the network setup, it is not necessary to setup via the menu.

For the setting to take effect, the system must be rebooted. Turn the system's power off and then back on.

■Setting the IP address

- ① Press the [FUNC] button to light its indicator, and press the [SYSTEM] button to display the SYSTEM menu.
- ② Turn [F1] to display the Network1 sub menu.
- ③ Turn [F2] to [F5] to set the IP address, and press the [F5] switch (Save) to enter the address.

<Menu display>

NetWork1	IP Address			Save↓
9/16	192	168	0	1
	0-255	0-255	0-255	0-255

■Setting the subnet mask

- ① Press the [FUNC] button to light its indicator, and press the [SYSTEM] button to display the SYSTEM menu.
- ② Turn [F1] to display the Network2 sub menu.
- ③ Turn [F2] to [F5] to set the subnet mask, and press the [F5] switch (Save) to enter the mask.

<Menu display>

NetWork2	Subnet Mask			Save↓
10/16	255	255	255	0
	0-255	0-255	0-255	0-255

■Setting the gateway

- ① Press the [FUNC] button to light its indicator, and press the [SYSTEM] button to display the SYSTEM menu.
- ② Turn [F1] to display the Network3 sub menu.
- ③ Turn [F2] to [F5] to set the gateway, and press the [F5] switch (Save) to enter the gateway.

<Menu display>

NetWork3	Gateway			Save↓
11/16	0	0	0	0
	0-255	0-255	0-255	0-255

■Display the MAC address

- ① On the SYSTEM menu, turn [F1] to display the Network4 sub menu. The MAC address now appears.

<Menu display> (When the MAC address is "008045448000".)

NetWork4	MAC Address
12/16	008045448000

5. System settings

5-6. Other settings

5-6-1. Setting the LCD backlight

The LCD backlight can be set to ON or OFF.

- ① Press the [FUNC] button to light its indicator, and press the [SYSTEM] button to display the SYSTEM menu.
- ② Turn [F1] to display the System sub menu.
- ③ Turn [F3], and select On or Off for the backlight using the LCD-BL item.

<Menu display>

System	BusMode	LCD-BL	EditEN	Protcol
2/16	PGM/PST	On	On	GVG-A
	A/B	Off	Off	GVG-B
				P/TCont
				P/TDirt

5-6-2. Setting editor enable

The user can set whether to enable control from an external device (editor) connected to the RS-422 connector.

On the System sub menu, turn [F4] to set On or Off for control from the external device (editor) connected to the RS-422 connector using the EditEN item.

On: Control is enabled.

Off: Control is disabled.

EditEN item On and Off can be assigned to one of the user buttons. ☞ See 5-3-1.

5-6-3. Setting the protocol

Set the RS-422 protocol.

On the System sub menu, turn [F5] to set the protocol using the Protcol item.

GVG-A: The GVG protocol is complied with.
The wipe pattern number starts from 0. ☞ See 6-1.

GVG-B: The GVG protocol is complied with.
The wipe pattern number starts from 1. ☞ See 6-1.

P/TCont: The controller for the camera or controller for the pan-tilt head is controlled.
This setting is selected when the unit is connected to a controller and a multiple number of cameras or pan-tilt heads are to be controlled.

P/TDirt: This setting is selected when the unit is connected directly to a pan-tilt head, and a camera or pan-tilt head is to be controlled.

* If "P/TCont" or "P/TDirt" is selected as the Protcol item setting, "—" is displayed for the EditEN item.
At this time, the user buttons will not work.

5. System settings

5-6-4. Setting the GPI

The user can set the functions that are to be controlled from the GPI ports and set whether to enable the control.

- ① Press the [FUNC] button to light its indicator, and press the [SYSTEM] button to display the SYSTEM menu.
- ② Turn [F1] to display the GPI sub menu, and turn [F2] to set the function to be controlled by the GPI port 1 using the GPI1 item.

<Menu display>

GPI	GPI1	GPI2	GPIEN
6/16	AUTO	DSK	On
	CUT	AUTO	Off
	DSK	CUT	
	PinP	PinP	
	FTB	FTB	
BGDAUTO	BGDAUTO		
BGDCUT	BGDCUT		
KEYAUTO	KEYAUTO		
KEYCUT	KEYCUT		

- ③ Turn [F3] to set the function to be controlled by the GPI port 2 using the GPI2 item.
- ④ Turn [F4] to set On or Off for the control from the GPI port using the GPIEN item.

On: Control is enabled.

Off: Control is disabled.

GPIEN item On and Off can be assigned to one of the user buttons.  See 5-3-1.

5. System settings

5-7. Camera control

A camera and pan-tilt head can be controlled from this unit.

Up to five cameras can be controlled via a controller (AW-RP655L or AW-RP555L) connected to the unit's RS-422 interface connector.

The unit can also be connected directly to a pan-tilt head, and the camera and pan-tilt head can be controlled.

To control a camera in this way, select "P/TCont" or "P/TDirt" as the Protocol item setting.  See 5-6-3.

Be absolutely sure that the power of the equipment is turned off before proceeding to connect the cables.

Functions that can be controlled from the unit

- Switching of the cameras to be controlled in line with the selection of the crosspoint buttons (PGM/A 1 to 10 and PST/B 1 to 10).
- The camera and pan-tilt head's pan-tilt operations and zooming and focusing operations are controlled.
- When the unit is connected directly to a pan-tilt head, the red tally signal and power on/off are controlled from the RS-422 interface connector.

5. System settings

Example of connections (when the unit and a controller are connected)

Controllers that can be connected: AW-RP655L, AW-RP555L

For details on connecting the pan-tilt heads and controller or connecting the pan-tilt heads and cameras, refer to the operating instructions of each device.

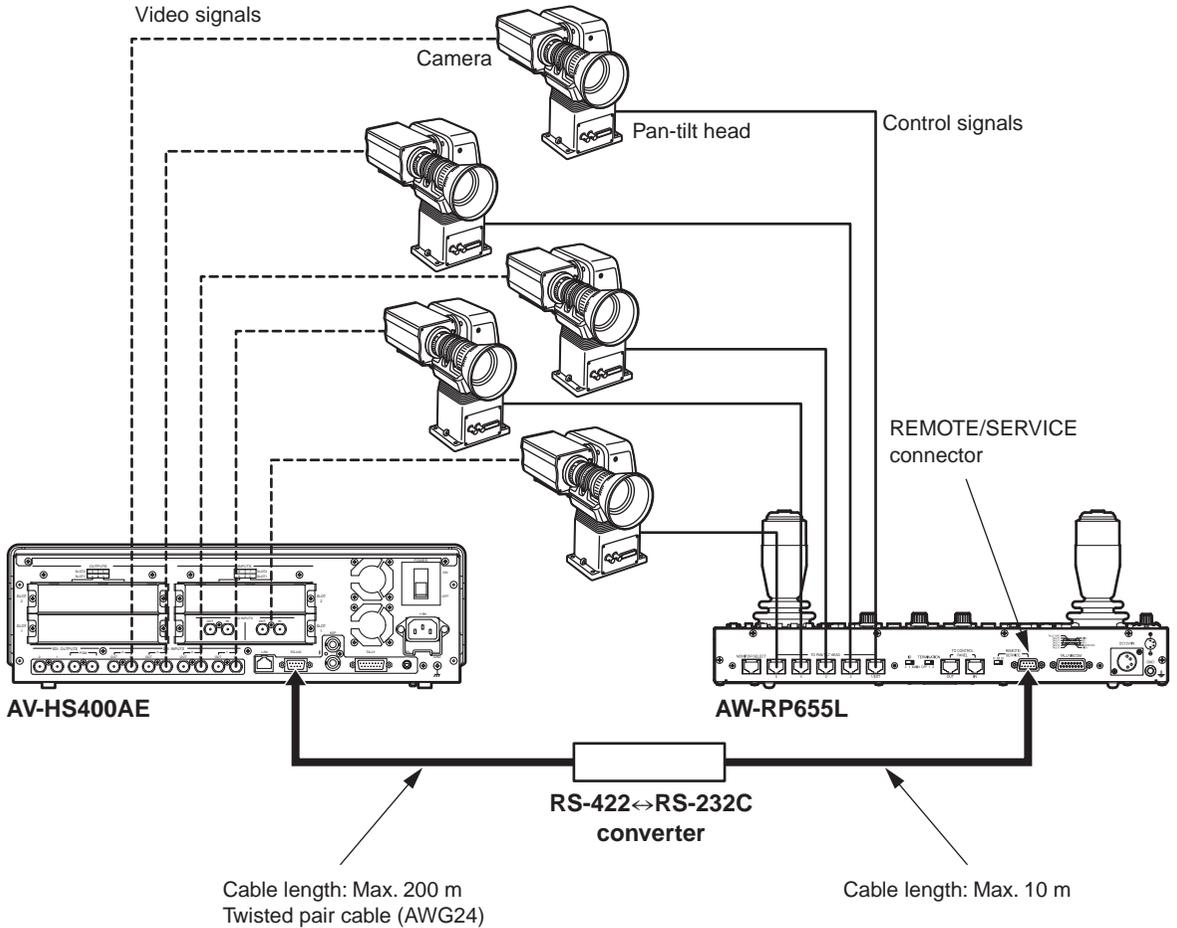

<Connection specifications>

AV-HS400AE

Pin No.	Signal
1	FRAME GND
2	TXD -
3	RXD +
4	GND
5	NC
6	GND
7	TXD +
8	RXD -
9	FRAME GND

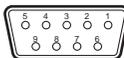

RS-422

*: Twisted pair cable

RS-422 to RS-232C converter

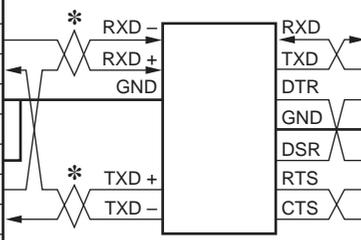

AW-RP655L

Pin No.	Signal
1	—
2	RXD IN
3	TXD OUT
4	DTR
5	GND
6	DSR
7	RTS
8	CTS
9	—

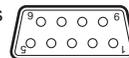

REMOTE/SERVICE

For pin assignments and specifications of the RS-422 to RS-232C converter, refer to the operating instructions of the converter used.

5. System settings

Example of connections (when the unit and a pan-tilt head are connected)

Pan-tilt heads that can be connected: AW-HE100N/E, AW-PH400E, AW-PH405E, AW-PH360L

■ Connections for AW-HE100N/E, AW-PH405E or AW-PH360L

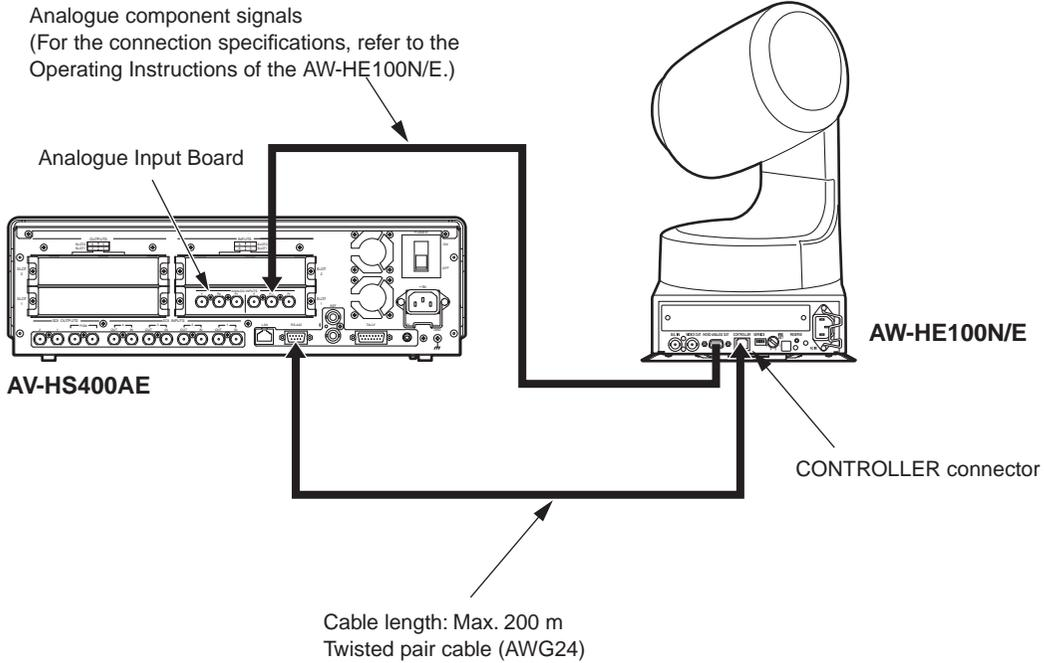

<Connection specifications>

AV-HS400AE

AW-HE100N/E, AW-PH405E, AW-PH360L

Pin No.	Signal
1	FRAME GND
2	TXD -
3	RXD +
4	GND
5	NC
6	GND
7	TXD +
8	RXD -
9	FRAME GND

Pin No.	Signal
1	GND
2	—
3	RXD -
4	TXD -
5	TXD +
6	RXD +
7	—
8	—

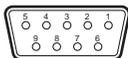

RS-422

*: Twisted pair cable



CONTROLLER
(CONTROL IN IP/RP)

1.....8

When the AW-HE100N/E is to be connected to the unit, select a setting which will enable operations to be controlled by the controller in the "Controller" item of the AW-HE100N/E's pan-tilt head unit setting menu (** Pan Tilt Head Setting **).

For further details, refer to the Operating Instructions of the AW-HE100N/E.

5. System settings

■ Connections for AW-PH400E

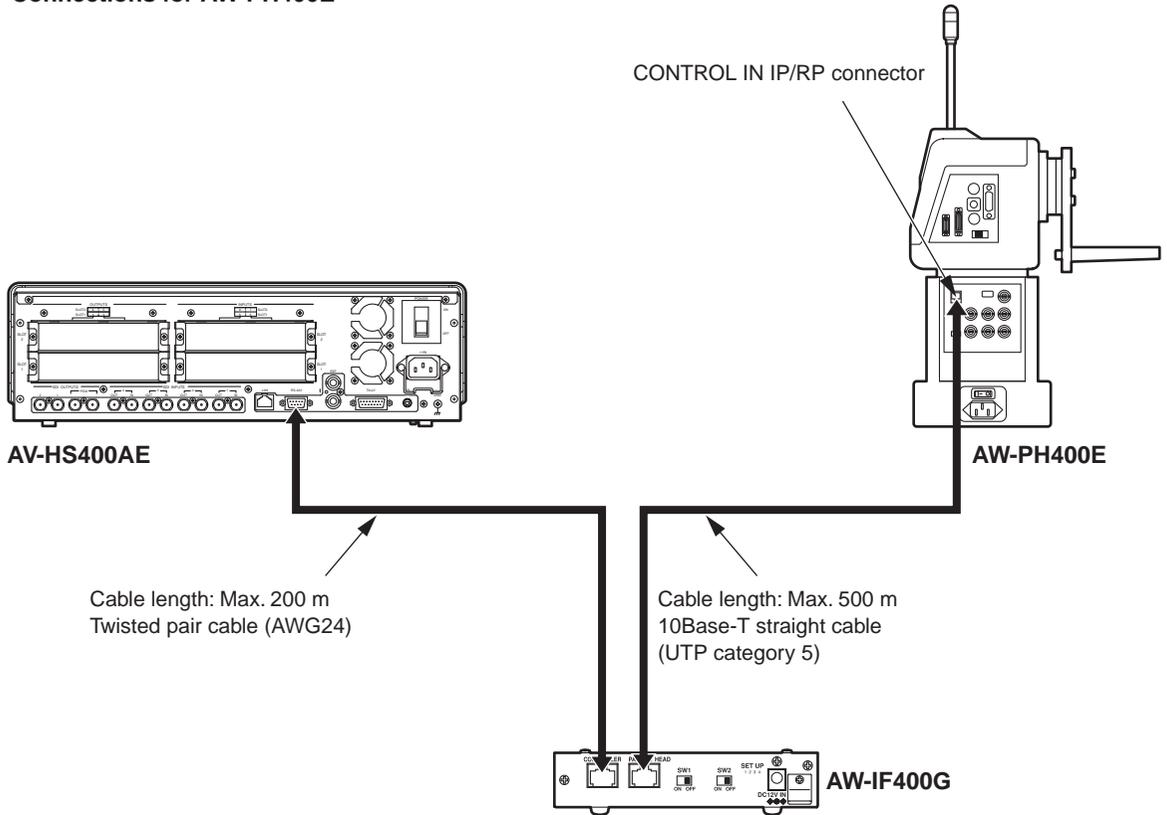

Switch settings

SW1	SW2	SET UP			
		1	2	3	4
OFF	OFF	ON	OFF	ON (300 deg)	OFF (190 deg)

<Connection specifications>

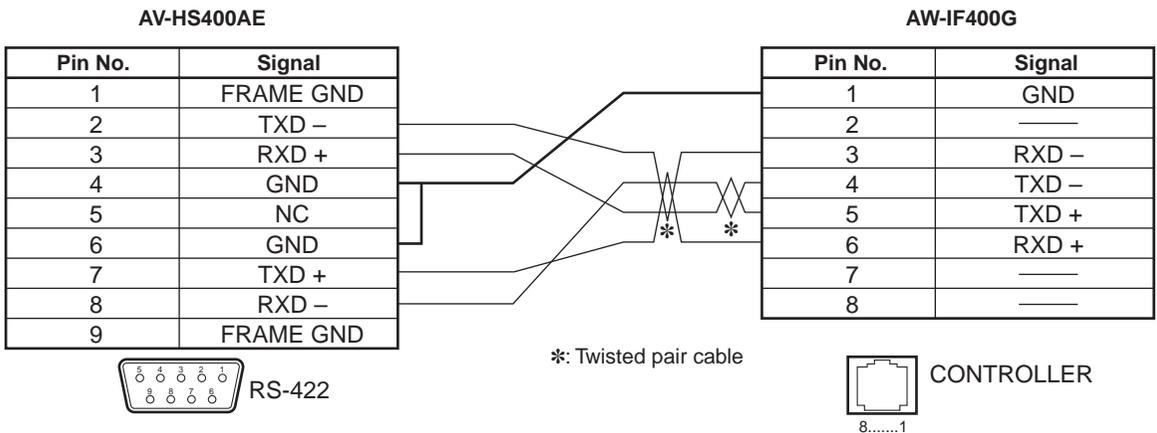

5. System settings

■ Camera control settings

- ① Press the [FUNC] button to light its indicator, and press the [SYSTEM] button to display the SYSTEM menu.
- ② Turn [F1] to display the CamCTL1 sub menu.

<Menu display>

CamCTL1	Signal	CTL	Tally
3/16	IN1	1	Disable
	IN1-8	1-5	Enable
		None	

- ③ Turn [F2] to select the input signal using the Signal item.
- ④ Turn [F3] to set the control signal (for the camera) that supports the input signal using the CTL item. Establish the associations between the switching of the cameras linked to the selection of the crosspoint buttons (PGM/A 1 to 10 and PST/B 1 to 10) and the tally control.
 - When camera control is enabled, the “c” mark appears on the multi view display in front of the names of the materials in the cameras targeted for control.
 - When “P/TDirt” has been selected as the protocol setting, only “1” appears. See 5-6-3.
- ⑤ Turn [F4] to enable or disable tally control using the Tally item. This setting can be selected when “P/TDirt” has been selected as the protocol setting. See 5-6-3.

Enable: Tally control is enabled.

Red tally signal On/Off control is exercised from the RS-422 interface connector.

Disable: Tally control is disabled.

- ⑥ Turn [F1] to display the CamCTL2 sub menu.

<Menu display>

CamCTL2	Signal	PosCont	Speed	Power↓
4/16	IN1	PanTilt	Fast	On
	IN1-8	Zm/Focs	Middle	Off
			Slow	

- ⑦ Turn [F2] to select the input signal using the Signal item.
- ⑧ Turn [F3] to select the control to be exercised by operating the positioner using the PosCont item.

PanTilt: Panning is controlled by left/right (X) operation; tilting is controlled by up/down (Y) operation.

Zm/Focs: Lens focusing is controlled by left/right (X) operation; lens zooming is controlled by up/down (Y) operation.

Each time the rotary encoder [Z] is pressed, the PanTilt or Zm/Focs setting is selected alternately.

- Control of lens focusing is possible when the lens focus of the camera is set to manual operation.
- Control using the positioner is possible when the CamCTL1 sub menu or CamCTL2 sub menu is displayed.
- If the crosspoint buttons (PGM/A 1 to 10 and PST/B 1 to 10) are held down when “P/TCont” or “P/TDirt” is selected as the Protocol item setting, delegation to the CamCTL2 menu is initiated.

- For controlling the tilting
- For controlling the lens zooming

For switching between PanTilt and Zm/Focs

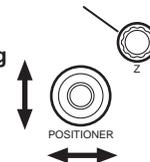

- For controlling the panning
- For controlling the lens focusing

5. System settings

⑨ Turn [F4] to set the control (panning, tilting, lens focusing and lens zooming) speed using the Speed Item.

Fast: Control is exercised at the fastest speed.

Middle: Control is exercised at the medium speed.

(This cannot be selected for the control of lens focusing or lens zooming.)

Slow: Control is exercised at the slowest speed.

⑩ When controlling the pan-tilt head's power to On, turn [F5] to select On, and press the [F5] switch.

When controlling it to Off, turn [F5] to select Off, and press the [F5] switch.

After turning the pan-tilt head's power to On, make sure to use this operation to turn the selection On.

This setting can be selected when "P/TDirt" has been selected as the protocol setting.  See 5-6-3.

The menu display (On or Off) does not indicate the status of the camera.

5. System settings

5-8. Status displays

5-8-1. Alarm status displays

These displays indicate a trouble status (alarm) in the power supply or fan.

- ① Press the [FUNC] button to light its indicator, and press the [SYSTEM] button to display the SYSTEM menu.
- ② Turn [F1] to display the Alarm sub menu.

<Menu display>

Alarm	Power	Fan		
8/16	NoAlarm	NoAlarm		
Alarm	Alarm			

Power: This indicates a trouble status (alarm) in the power supply.

Alarm: Trouble

NoAlarm: No trouble

Fan: This indicates a trouble status (alarm) in the fan.

Alarm: Trouble

NoAlarm: No trouble

5. System settings

5-8-2. Displaying the version information and option information

Information on the unit's software and hardware versions and the statuses of the options are displayed.

- ① Press the [FUNC] button to light its indicator, and press the [SYSTEM] button to display the SYSTEM menu.
- ② Turn [F1] to display the MainVer sub menu.
- ③ Turn [F2] to select the item whose version is to be displayed using the Select item.
- ④ The version information is displayed in the Version item.
The system version information is displayed in the SysVer item.

<Menu display>

MainVer	Select	Version	SysVer
15/16	Soft	1.00	1.00.00

Control Panel Input M/E

Soft: The software version information is displayed.

Control, Panel, Input, M/E:

The hardware version information is displayed.

- ⑤ Turn [F1] to display the OptVer sub menu.

<Menu display>

OptVer	Select	Board	Version
16/16	IN-SL1	SDI	0001

IN-SL2 OUT-SL1 OUT-SL2

- ⑥ Turn [F2] to select the option slot using the Select item.
- ⑦ The types of the optional boards connected are displayed in the Board item.

IN-SL1, 2 (option input slots 1, 2)

- SDI: SDI input board
- Analog: Analogue input board
- DVI: DVI input board
- Cmpsit: Analogue composite input board
- None: No optional board

OUT-SL1, 2 (option output slots 1, 2)

- Analog: Analogue output board
- DVI/Ana: DVI/analogue output board
- SDI: SDI output board
- None: No optional board

- ⑧ The optional board version information is displayed in the Version item.

5. System settings

5-9. Initialization

Initialization returns the set data to the factory shipment status.

(The network settings and the date and time settings are not initialized.)

- ① Press the [FUNC] button to light its indicator, and press the [SYSTEM] button to display the SYSTEM menu.
- ② Turn [F1] to display the Initial sub menu.

<Menu display>

Initial	Init↓			
7/16				

- ③ Press [F2] to initialize the settings. The "Init?" message appears.
- ④ To initialize the settings, turn [F2] to select YES, and then press the [F2] switch.
To cancel the initialization, turn [F2] to select No, and then press the [F2] switch.

<Menu display>

Initial	Init?			
7/16	No			

YES

6. External interfaces

This unit comes with RS-422, GPI and tally connectors to serve as external interfaces.

6-1. RS-422 connector

This enables the unit to be controlled by an external device.
Use it with the settings below. (D-sub 9-pin, female, inch screw)

Baud rate: 38400 bps
Parity: ODD
Stop bit: 1 bit

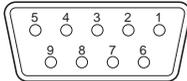

Pin assignment

Pin No.	Signal name	Description of signal
1	FRAME GROUND	Frame ground
2	TXD -	Send data (-)
3	RXD +	Receive data (+)
4	GROUND	Ground
5	NC	Not used
6	GROUND	Ground
7	TXD +	Send data (+)
8	RXD -	Receive data (-)
9	FRAME GROUND	Frame ground

The following lists the functions which can be controlled by editing controller AG-A850.
(Compliant with the GVG protocol)

- Crosspoint switch
- Wipe pattern selection (BKGD)
- Transition mode (MIX/WIPE) selection
- Auto transition time setting
- Auto transition execution

<Table of wipe patterns supported>

GVG protocol		AV-HS400AE	GVG protocol		AV-HS400AE	GVG protocol		AV-HS400AE	GVG protocol		AV-HS400AE
A	B		A	B		A	B		A	B	
0*	1	WIPE #1	12	13	SQ #1	24	25	SL #1	36	37	3D #1
1	2	WIPE #2	13	14	SQ #2	25	26	SL #2	37	38	3D #2
2	3	WIPE #3	14	15	SQ #3	26	27	SL #3	38	39	3D #3
3	4	WIPE #4	15	16	SQ #4	27	28	SL #4	39	40	3D #4
4	5	WIPE #5	16	17	SQ #5	28	29	SL #5	40	41	3D #5
5	6	WIPE #6	17	18	SQ #6	29	30	SL #6	41	42	3D #6
6	7	WIPE #7	18	19	SQ #7	30	31	SL #7	42	43	3D #7
7	8	WIPE #8	19	20	SQ #8	31	32	SL #8	43	44	3D #8
8	9	WIPE #9	20	21	SQ #9	32	33	SL #9	44	45	3D #9
9	10	WIPE #10	21	22	SQ #10	33	34	—	45	46	3D #10
10	11	WIPE #11	22	23	—	34	35	—	46	47	3D #11
11	12	WIPE #12	23	24	SQ #12	35	36	—	47	48	3D #12

*: Set "No. 256" when control is to be exercised from the AG-A850.

On the System sub menu of the SYSTEM menu, set On or Off for control from the external device (editor) connected to the RS-422 connector.

For details on the settings, see 5-6-2.

6. External interfaces

6-2. GPI connector

These connectors enable the unit to be controlled from an external source. Signals are input using contacts. The following types of control are exercised using the contacts as triggers. Use stereo mini plugs with a 3.5 mm diameter for connection to the unit.

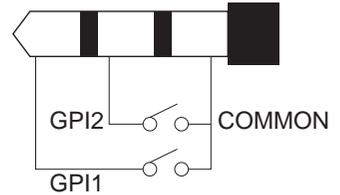

<Control functions that can be assigned>

Function assigned	Description of control	Remarks
AUTO	Control exercised using AUTO button on unit's panel	
CUT	Control exercised using CUT button on unit's panel	
DSK	Control exercised using DSK button on unit's panel	
PinP	Control exercised using PinP button on unit's panel	
FTB	Control exercised using FTB button on unit's panel	
BGDAUTO	Auto transition control for background	Control is exercised regardless of the selection statuses of the switches and buttons on the unit's panel.
BGDCUT	Cut transition control for background	
KEYAUTO	Auto transition control for key	
KEYCUT	Cut transition control for key	

<Initial setting>

Port	Function assigned	Description of control
GPI1	AUTO	Control exercised using AUTO button on unit's panel
GPI2	DSK	Control exercised using DSK button on unit's panel

Use the GPI sub menu under the SYSTEM menu to set the functions to be controlled using the external switches connected to the GPI ports and to enable or disable the control using the external switches. For details on the settings, see 5-6-4.

6. External interfaces

6-3. Tally connector

The tally connector comes with tally output, output enable, power supply or fan alarm output pins. The output signals from the tally output pins are for lighting the tally lamps, and these outputs are open collector outputs.

(D-sub 15-pin, male, inch screw)

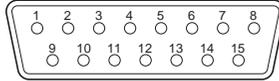

Pin assignment

Pin No.	Signal name	Input/output	Description of signal
1	IN1	Open collector output	Tally output of input video 1
2	IN2	Open collector output	Tally output of input video 2
3	IN3	Open collector output	Tally output of input video 3
4	IN4	Open collector output	Tally output of input video 4
5	IN5	Open collector output	Tally output of input video 5
6	IN6	Open collector output	Tally output of input video 6
7	IN7	Open collector output	Tally output of input video 7
8	IN8	Open collector output	Tally output of input video 8
9	ALARM	Open collector output	Fan alarm or power supply alarm output
10, 11, 12	RESERVED		Keep these pins unconnected.
13	ENABLE	Input	Enable signal of tally output and alarm output Open: Output; GND: no output
14, 15	GROUND	GROUND	Ground

Pins 1 to 9 must satisfy the following conditions:

Dielectric strength: Max. DC 24 V

Current: Max. 50 mA

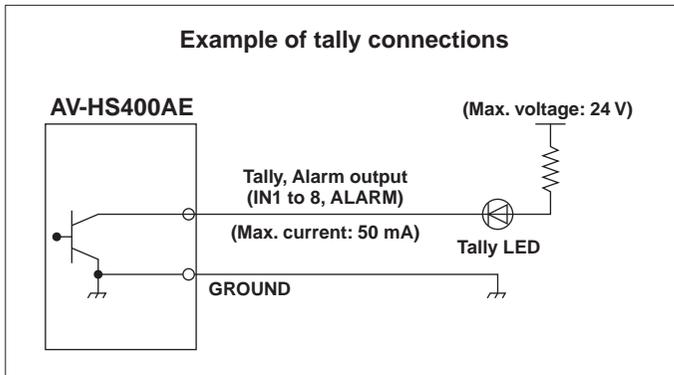

7. Image transmission functions

This unit comes with a function for transmitting still images from the host computer to the unit via LAN and a function for importing still images from the unit into the host computer. The image transmission software must be installed in the host computer from the CD-ROM supplied in order to use these functions. For details on installation, refer to "How to install the software".

■ Specifications

Run the image transmission software (HS400 Tool) in a host computer which satisfies the following conditions.

- Operating system: Windows 2000 or Windows XP
- Processor: Pentium III, 1 GHz or better recommended
- RAM: 256 MB or more recommended
- Hard disk drive: At least 50 MB of free memory
- LAN: 10BASE-T
- Display: TrueColor (24 bit, 32 bit colour), 800 × 600 dots or more

The image formats supported include bitmap (bmp), JPEG (jpg), TIFF (tif), GIF (gif) and PNG (png).

The image transmission software is equipped with a function for automatically converting images into the specified video format size.

■ Connections

Connect this unit to LAN using a twisted pair cable. Use a LAN crossover cable to connect the unit with the host computer directly. Use a LAN straight cable to connect to LAN using a hub or other equipment.

For details on network setup such as IP addresses, refer to "5-5. Network settings".

Transmitting images uses network capacity which may result in other connected devices possibly being affected when connecting to LAN through a hub and other equipment.

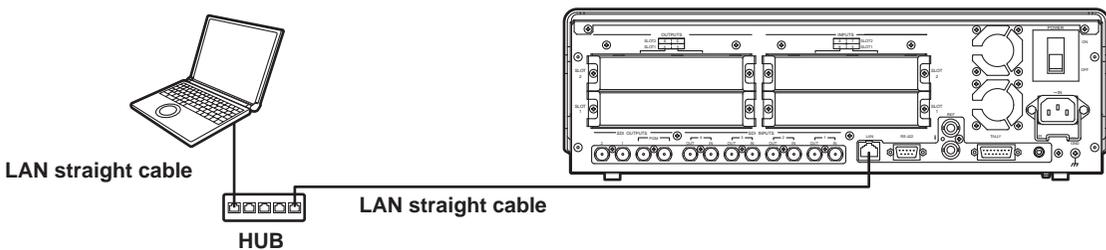
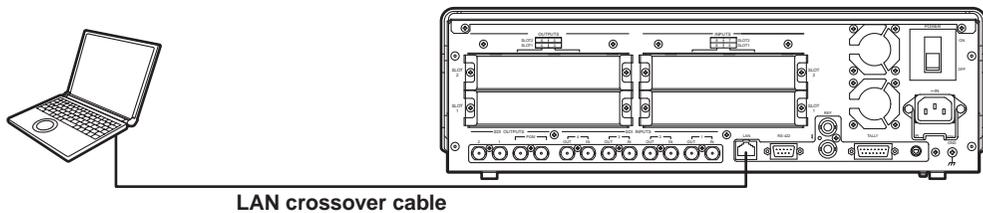

7. Image transmission functions

■How to install the software

This section describes how to install the image transmission software (HS400 Tool). Windows XP is used as the host computer's operating system in the example given here.

1. Insert the CD-ROM supplied with the unit into the CD-ROM drive of the host computer in which the programme will be installed. (Here, E: will serve as the name of this drive for example.)
2. Execute the setup programme (E:\HS400TOOL\ENG\SETUP.EXE).
3. The installer now starts up so follow its instructions to proceed.

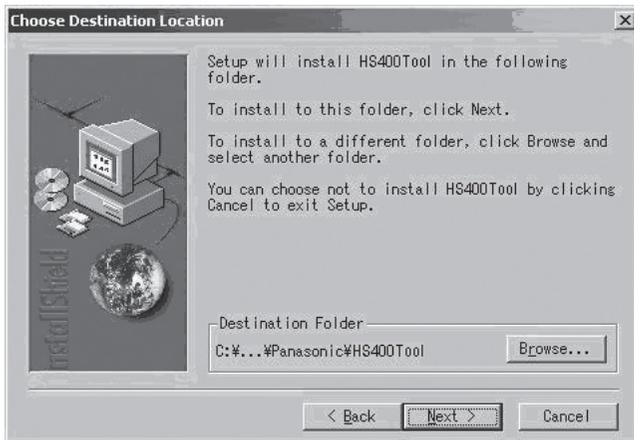

4. The Setup Complete screen appears to indicate that installation is complete. Click [Finish] to close the window.



7. Image transmission functions

■ Operation

This section describes how to operate the image transmission software (HS400 Tool).

<Startup>

On the Start menu of Windows, select [Programs] → [Panasonic] → [AV-HS400Tool] → [HS400Tool].
The main screen now appears.



<Exit>

Click the [CLOSE] button.

<Setting the IP address>

Set the unit's IP address in the IP Address setting box.

7. Image transmission functions

<Transmitting images to the unit>

1. Select the mode.
Check that "To HS400" appears in the [Mode] field.
If "From HS400" appears instead, click the [From HS400] button so that "To HS400" appears.
2. Select the transmission destination of the images in the [Target] field.
FMEM1: Unit's frame memory 1
FMEM2: Unit's frame memory 2
3. When the [Select Image] button is clicked, the file selection dialogue box appears on the screen.
Select the image file to be transmitted, and click [OK].
The image is now displayed in the image display area, and its horizontal and vertical dimensions appear in the [Width] and [Height] fields at the bottom right.
4. In the [Size] field, select the size of the image to be transmitted to the unit.
HD1080 (1920×1080), HD720 (1280×720), SD480 (720×487) or SD576 (720×576) can be selected as the size. If the image is in a different video format from the ones supported by the unit, the output will not be displayed properly.
5. In the [Aspect] field, select the scaling method.
If the size of the image to be transmitted and the selected image differ, the image will be automatically scaled according to one of the following methods.
Full: The size of the image is increased or reduced so that it fits the size selected in the [Size] field. If the aspect ratio of the image to be transmitted differs from that of the selected image, the ratio between the horizontal and vertical dimensions will be changed.
Keep: The image is expanded or reduced while its original aspect ratio is kept unchanged.
Any empty spaces in the image will appear black.
6. The [RGBA (FMEM1&2)] button can be selected when images containing the alpha channel are to be transmitted.
When the [RGBA (FMEM1&2)] button is clicked, the RGB images are transferred to frame memory 1 (FMEM1), and the alpha channel images are transferred to frame memory 2 (FMEM2).
When the [Display Alpha] button is clicked, the alpha channel images appear as a preview display.
7. Click the [Send] button to transmit the image to the unit.

7. Image transmission functions

<Transmitting images from the unit>

1. Select the mode.

Check that "From HS400" appears in the [Mode] field.

If "To HS400" appears instead, click the [To HS400] button so that "From HS400" appears.

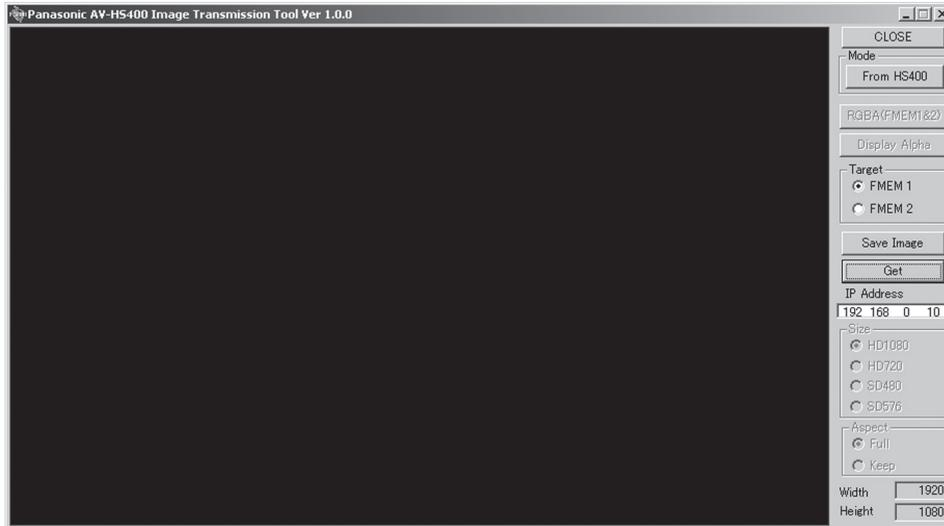

2. Select the images to be imported to the host computer in the [Target] field.

FMEM1: Images in unit's frame memory 1

FMEM2: Images in unit's frame memory 2

3. When the [Get] button is clicked, the image is imported from the unit.

The image is now displayed in the image display area, and its horizontal and vertical dimensions appear in the Width and Height fields at the bottom right.

4. When the [Save Image] button is clicked, the file save dialogue box appears on the screen. Select the image file to be transmitted, and click [Save].

8. Setting menu table

A setting is entered when an item displayed (↓) is selected and then the [F1], [F2], [F3], [F4] or [F5] switch is pressed.

(It will not be entered unless the switch is pressed.)

Menu	Sub menu		Parameter 1	Parameter 2	Parameter 3	Parameter 4
	Turn F1 to select.		Turn F2 to select.	Turn F3 to select.	Turn F4 to select.	Turn F5 to select.
TIME	BKGD	Parameter	TransTime		Unit	—
	1/5	Setting range	0 to 13s	0 to 999f	Frame, Sec	—
		Default value	1s	0f	Sec	—
	KEY	Parameter	TransTime		Unit	—
	2/5	Setting range	0 to 13s	0 to 999f	Frame, Sec	—
		Default value	1s	0f	Sec	—
	DSK	Parameter	TransTime		Unit	—
	3/5	Setting range	0 to 13s	0 to 999f	Frame, Sec	—
		Default value	1s	0f	Sec	—
	PinP	Parameter	TransTime		Unit	—
	4/5	Setting range	0 to 13s	0 to 999f	Frame, Sec	—
		Default value	1s	0f	Sec	—
FTB	Parameter	TransTime		Unit	—	
5/5	Setting range	0 to 13s	0 to 999f	Frame, Sec	—	
	Default value	1s	0f	Sec	—	
WIPE	Border	Parameter	Border	Width	Soft	
	1/5	Setting range	On, Off	0.1 to 100.0	0.0 to 100.0	
		Default value	Off	5.0	0.0	
	BodrCol	Parameter	Hue	Sat	Lum	Load ↓
	2/5	Setting range	0.0 to 359.9	0.0 to 100.0	0.0 to 108.0	White, Yellow, Cyan, Green, Magenta, Red, Blue, Black
		Default value	0.0	0.0	100.0	White
	WIPEPos	Parameter	Select	X-Pos	Y-Pos	CopyTo ↓
	3/5	Setting range	BKGD, KEY	-100.00 to +100.00	-100.00 to +100.00	Display only
		Default value	BKGD	0.00	0.00	
	SQPos	Parameter	Select	X-Pos	Y-Pos	CopyTo ↓
4/5	Setting range	BKGD, KEY	-100.00 to +100.00	-100.00 to +100.00	Display only	
	Default value	BKGD	0.00	0.00		
Modify	Parameter	Light-B	Light-K	Trim	4:3Auto	
5/5	Setting range	On, Off	On, Off	Off, 16:9 (On), 4:3, 4:3Smth	On, Off (Selection enabled when HD format is used)	
	Default value	Off	Off	16:9 (On)	Off	
COLOR	CBGD	Parameter	Hue	Sat	Lum	Load ↓
	1/1	Setting range	0.0 to 359.9	0.0 to 100.0	0.0 to 108.0	White, Yellow, Cyan, Green, Magenta, Red, Blue, Black
		Default value	0.0	0.0	100.0	White

8. Setting menu table

Menu	Sub menu		Parameter 1	Parameter 2	Parameter 3	Parameter 4
	Turn F1 to select.		Turn F2 to select.	Turn F3 to select.	Turn F4 to select.	Turn F5 to select.
KEY	KEY	Parameter	Type	LumKey	Fill	PVW
	1/9	Setting range	Lum, Linear, Chroma, Full	ChrmOn, ChrmOff	Bus, Matte	Auto, On, Off
		Default value	Linear	ChrmOff	Bus	Auto
	Adjust	Parameter	Clip	Gain	Density	Invert
	2/9	Setting range	0.0 to 108.0	0.0 to 200.0	0.0 to 100.0	On, Off
		Default value	0.0	100.0	100.0	Off
	FillMatt	Parameter	Hue	Sat	Lum	Load ↓
	3/9	Setting range	0.0 to 359.9	0.0 to 100.0	0.0 to 108.0	White, Yellow, Cyan, Green, Magenta, Red, Blue, Black
		Default value	0.0	0.0	100.0	White
	Edge	Parameter	Type	Width	Direc	
	4/9	Setting range	Off, Border, Drop, Shadow, Outline	0 to 4	0, 45, 90, 135, 180, 225, 270, 315	
		Default value	Off	2	0	
	EdgeCol	Parameter	Hue	Sat	Lum	Load ↓
	5/9	Setting range	0.0 to 359.9	0.0 to 100.0	0.0 to 108.0	White, Yellow, Cyan, Green, Magenta, Red, Blue, Black
		Default value	0.0	0.0	0.0	Black
	Mask	Parameter	Mask	Invert		
	6/9	Setting range	Manual, Off, 4:3	On, Off		
		Default value	Off	Off		
MaskAdj	Parameter	Left	Top	Bottom	Right	
7/9	Setting range	-50.00 to +50.00	-50.00 to +50.00	-50.00 to +50.00	-50.00 to +50.00	
	Default value	-25.00	+25.00	-25.00	+25.00	
Trans	Parameter	OutPatt				
8/9	Setting range	Nor, Rev				
	Default value	Nor				
FlyKEY	Parameter	X-Pos	Y-Pos	Size		
9/9	Setting range	-100.00 to 100.00	-100.00 to 100.00	0.0 to 400.0		
	Default value	0.00	0.00	100.0		
CHR KEY	Auto	Parameter	Marker	Aspect		Sample ↓
	1/3	Setting range	On, Off	-50.00 to +50.00		Start
		Default value	Off	0.0		
	Adjust1	Parameter	Hue	Sat	Lum	Y-Infl
	2/3	Setting range	0.0 to 359.9	0.0 to 100.0	0.0 to 108.0	0.0 to 100.0
	Default value	354.0	100.0	7.0	0.0	
Adjust2	Parameter	Hue-Rad	Sat-Rad	Soft	Cancel	
3/3	Setting range	0.0 to 100.0	0.0 to 100.0	0.0 to 100.0	0.0 to 100.0	
	Default value	100.0	50.0	0.0	0.0	
FREEZE	Status	Display only	FRZ:***** XPT:1 2 3 4 5 6 7 8 9 10			
	1/2					
	Freeze	Parameter	Signal	Select		Freeze ↓
2/2	Setting range	IN1 to 8	Frame, Field		Toggleing between On and Off	
	Default value	—	Frame		Off	

8. Setting menu table

Menu	Sub menu		Parameter 1	Parameter 2	Parameter 3	Parameter 4
	Turn F1 to select.		Turn F2 to select.	Turn F3 to select.	Turn F4 to select.	Turn F5 to select.
DSK	DSK	Parameter	Type		Fill	PVW
	1/7	Setting range Default value	Lum, Linear Linear		Bus, Matte Bus	On, Off Off
	Adjust	Parameter	Clip	Gain	Density	Invert
	2/7	Setting range Default value	0.0 to 108.0 0.0	0.0 to 200.0 100.0	0.0 to 100.0 100.0	On, Off Off
	FillMatt	Parameter	Hue	Sat	Lum	Load ↓
	3/7	Setting range Default value	0.0 to 359.9 0.0	0.0 to 100.0 0.0	0.0 to 108.0 100.0	White, Yellow, Cyan, Green, Magenta, Red, Blue, Black White
	Edge	Parameter	Type	Width	Direc	
	4/7	Setting range Default value	Off, Border, Drop, Shadow, Outline Off	0 to 4 2	0, 45, 90, 135, 180, 225, 270, 315 0	
	EdgeCol	Parameter	Hue	Sat	Lum	Load ↓
	5/7	Setting range Default value	0.0 to 359.9 0.0	0.0 to 100.0 0.0	0.0 to 108.0 0.0	White, Yellow, Cyan, Green, Magenta, Red, Blue, Black Black
	Mask	Parameter	Mask	Invert		
	6/7	Setting range Default value	Manual, Off, 4:3 Off	On, Off Off		
	MaskAdj	Parameter	Left	Top	Bottom	Right
	7/7	Setting range Default value	-50.00 to +50.00 -25.00	-50.00 to +50.00 +25.00	-50.00 to +50.00 -25.00	-50.00 to +50.00 +25.00
PinP	PinP	Parameter	Density			PVW
	1/6	Setting range Default value	0.0 to 100.0 100.0			On, Off Off
	Border	Parameter	Border	Width	Soft	Mode
	2/6	Setting range Default value	Off, On Off	0.1 to 100.0 5.0	0.0 to 100.0 0.0	Fix, Var Fix
	BodrCol	Parameter	Hue	Sat	Lum	Load ↓
	3/6	Setting range Default value	0.0 to 359.9 0.0	0.0 to 100.0 0.0	0.0 to 108.0 100.0	White, Yellow, Cyan, Green, Magenta, Red, Blue, Black White
	Position	Parameter	X-Pos	Y-Pos	Size	
	4/6	Setting range Default value	-50.00 to +50.00 0.00	-50.00 to +50.00 0.00	0.00 to 100.00 25.00	
	Trim	Parameter	Trim	Manual		
5/6	Setting range Default value	Off, 4:3, Manual Off	Free, Pair Free			
TrimAdj	Parameter	Left	Top	Bottom	Right	
6/6	Setting range Default value	-50.00 to +50.00 -40.00	-50.00 to +50.00 +40.00	-50.00 to +50.00 -40.00	-50.00 to +50.00 +40.00	

8. Setting menu table

Menu	Sub menu		Parameter 1	Parameter 2	Parameter 3	Parameter 4
	Turn F1 to select.		Turn F2 to select.	Turn F3 to select.	Turn F4 to select.	Turn F5 to select.
IN/OUT	Input	Parameter	Signal	FS	Mode ↓	AnaGain
	1/15	Setting range	IN1 to 8	On, Off	*Normal, UC, Auto, D by D	-30 to +30
		Default value	—	On	Normal	0
	Output	Parameter	Signal	Output	Mode ↓	
	2/15	Setting range	OUT1 to 6	PGM, PVW, AUX, Multi, KEYOut	*Normal, DC	
		Default value	—	—	Normal	
	Ref	Parameter	Sync ↓	BBSetup	GenLock	
	3/15	Setting range	*BBST, BBAD, TRI, INT	0IRE, 7.5IRE	Locked, UnLock	
		Default value	BBST	7.5IRE	—	
	OutPhs	Parameter	System	H-Phase	V-Phase	
	4/15	Setting range	0H, 1H	-1320 to +1319	-100 to +100	
		Default value	1H	0	0	
	OSD	Parameter	OSD	Select		
	5/15	Setting range	On, Off	PVW, Multi		
		Default value	On	PVW		
	Multi1	Parameter	Split		Pos	Signal
	6/15	Setting range	10Split, 4Split, 8Split		1 to 8 (1 to 4) (1 to 6)	IN1 to 8, FMEM1, FMEM2, CBGD
		Default value	10Split		Upper-L, Upper-R	PGM, PVW, AUX, KeyOut
					—	—
	Multi2	Parameter	Frame	Char	Label	Tally
7/15	Setting range	LUM 0%, LUM 25%, LUM 50%, LUM 75%, LUM100%, Off	LUM 0%, LUM 25%, LUM 50%, LUM 75%, LUM100%, Off	On, Off	Red, Red+GRN, Off	
	Default value	LUM 50%	LUM 75%	On	Red+GRN	
Multi3	Parameter	Signal	Type ↓	Name		
8/15	Setting range	IN1 to 8	*Default, Preset, User			
	Default value		Default			
Anci	Parameter	VAnci	E.Audio			
9/15	Setting range	On, Off	On, Off			
	Default value	Off	Off			
DVIn	Parameter	Signal	Mode	Scale	Auto ↓	
10/15	Setting range	IN5 to 8	Dig, Ana	Fit-V, Fit-H, Full	Black, White, Init	
	Default value	—	Dig	Fit-V	Black	
DVIPhs	Parameter	Signal	ClkPhs	H-Pos	V-Pos	
11/15	Setting range	IN5 to 8	-16 to 15	-100 to 100	-100 to 100	
	Default value	—	0	0	0	

8. Setting menu table

Menu	Sub menu		Parameter 1	Parameter 2	Parameter 3	Parameter 4
	Turn F1 to select.		Turn F2 to select.	Turn F3 to select.	Turn F4 to select.	Turn F5 to select.
IN/OUT	DVIOut	Parameter	Signal	Mode ↓	Size ↓	Scale ↓
	12/15	Setting range	OUT3, OUT5	*Dig, Ana	*Auto, XGA, WXGA, SXGA, WSXGA+, UXGA, WUXGA	*Fit-V, Fit-H, Full, 5:4 ("5:4" can be selected when SXGA has been selected as the Size item setting.)
		Default value	—	Dig	Auto	Fit-V
	UpConvnt	Parameter	Signal	Scale ↓	MovDet ↓	Sharp ↓
	13/15	Setting range	IN5 to 8	*SQ, EC, LB	*1 to 5	*1 to 5
		Default value	—	SQ	3	3
	CmpsitIn	Parameter	Signal	Chroma	Ped	Hue
	14/15	Setting range	IN5 to 8	-8 to +7	-100 to +100	-30 to +30 (Enabled when the system format is set to 1080/59.94i, 720/59.94p and 480/59.94i.)
		Default value	—	0	0	0
	DownConv	Parameter	Signal	Scale ↓	Delay ↓	Sharp ↓
	15/15	Setting range	OUT3 to 6	*SQ, EC, LB	*90H (75H), 1F	*1 to 5
		Default value	—	SQ	90H	1
MEMORY	PSMEM	Parameter	Mode	NO.Sel	XPT	Exec ↓
	1/4	Setting range	Store, Recall, Clear	■1 to 10	Disable, Enable	
		Default value	—	—	—	—
	FMEM	Parameter	Signal	Store	Review	Exec ↓
	2/4	Setting range	AUX	FMEM1, FMEM2	On, Off	
		Default value	—	—	Off	—
	SDCard	Parameter	Mode ↓	Select	SaveFile	Exec ↓
	3/4	Setting range	*Load, Save, Init, Delete, No Card	FMEM1, FMEM2, System	HS070531100000	
		Default value	—	—	—	
	CardInfo	Parameter	Images	FreeSpace		GetInf ↓
	4/4	Setting range		MB/ MB		
		Default value				
XPT	XPTStats	Display only	SIG:B 1 2 3 4 5 6 7 8 G XPT:1 2 3 4 5 6 7 8 9 10			
	1/3					
	XPTAsign	Parameter	XPT	Signal		
	2/3	Setting range	1 to 10	IN1 to 8, Black, CBGD, CBAR, FMEM1, FMEM2, None		
		Default value	—	—		
	XPTSwch	Parameter	Timing			
	3/3	Setting range	Any, Field1, Field2			
		Default value	Any			

8. Setting menu table

Menu	Sub menu		Parameter 1	Parameter 2	Parameter 3	Parameter 4
	Turn F1 to select.		Turn F2 to select.	Turn F3 to select.	Turn F4 to select.	Turn F5 to select.
SYSTEM	Format	Parameter	Mode ↓			16:9SQ
	1/16	Setting range Default value	*1080/59.94i, 1080/50i, 720/59.94p, 720/50p, 480/59.94i, 576/50i 1080/59.94i			On, Off Off
	System	Parameter	BusMode	LCD-BL	EditEN	Protocol
	2/16	Setting range Default value	A/B, PGM/PST PGM/PST	On, Off On	On, Off On	GVG-A, GVG-B, P/TCont, P/TDir GVG-A
	CamCTL1	Parameter	Signal	CTL	Tally	
	3/16	Setting range Default value	IN1 to 8	1 to 5, None	Enable, Disable Disable	
	CamCTL2	Parameter	Signal	PosCont	Speed	Power ↓
	4/16	Setting range Default value	IN1 to 8	PanTilt, Zm/Focs PanTilt	Fast, Middle, Slow Fast	On, Off On
	Button	Parameter	USER1	USER2	FTB	
	5/16	Setting range Default value	PinPPVW, DSKPVW, EditEN, GPIEN, OSD, StrFM1, StrFM2 PinPPVW	PinPPVW, DSKPVW, EditEN, GPIEN, OSD, StrFM1, StrFM2 DSKPVW	FTB, KEYAuto, Disable FTB	
	GPI	Parameter	GPI1	GPI2	GPIEN	
	6/16	Setting range Default value	AUTO, CUT, DSK, PinP, FTB, BGDAUTO, BGDCUT, KEYAUTO, KEYCUT AUTO	AUTO, CUT, DSK, PinP, FTB, BGDAUTO, BGDCUT, KEYAUTO, KEYCUT DSK	On, Off On	
	Initial	Parameter	Init ↓			
	7/16	Setting range				
	Alarm	Parameter	Power	Fan		
	8/16	Setting range Default value	Alarm, NoAlarm	Alarm, NoAlarm		
	NetWork1	Parameter	IP Address			Save ↓
	9/16	Setting range Default value	0 to 255 192	0 to 255 168	0 to 255 0	0 to 255 1
	NetWork2	Parameter	Subnet Mask			Save ↓
	10/16	Setting range Default value	0 to 255 255	0 to 255 255	0 to 255 255	0 to 255 0
NetWork3	Parameter	Gateway			Save ↓	
11/16	Setting range Default value	0 to 255 0	0 to 255 0	0 to 255 0	0 to 255 0	
NetWork4	Parameter	MAC Address				
12/16	Display only					

8. Setting menu table

Menu	Sub menu		Parameter 1	Parameter 2	Parameter 3	Parameter 4
	Turn F1 to select.		Turn F2 to select.	Turn F3 to select.	Turn F4 to select.	Turn F5 to select.
SYSTEM	Date	Parameter	Year	Month	Date	Set ↓
	13/16	Setting range	2000 to 2099	1 to 12	1 to 31	—
		Default value	—	—	—	—
	Time	Parameter	Hour	Minute	Second	Set ↓
	14/16	Setting range	0 to 23	0 to 59	0 to 59	—
		Default value	—	—	—	—
	MainVer	Parameter	Select	Version		SysVer
	15/16	Setting range	Soft, Control, Panel, Input, M/E	Version number		Version number
	OptVer	Parameter	Select	Board	Version	
	16/16	Setting range	IN-SL1, IN-SL2, OUT-SL1, OUT-SL2	SDI, Analog, DVI, DVI/Ana, Cmpsit, None	Version number	

9. Appearance

Unit: mm

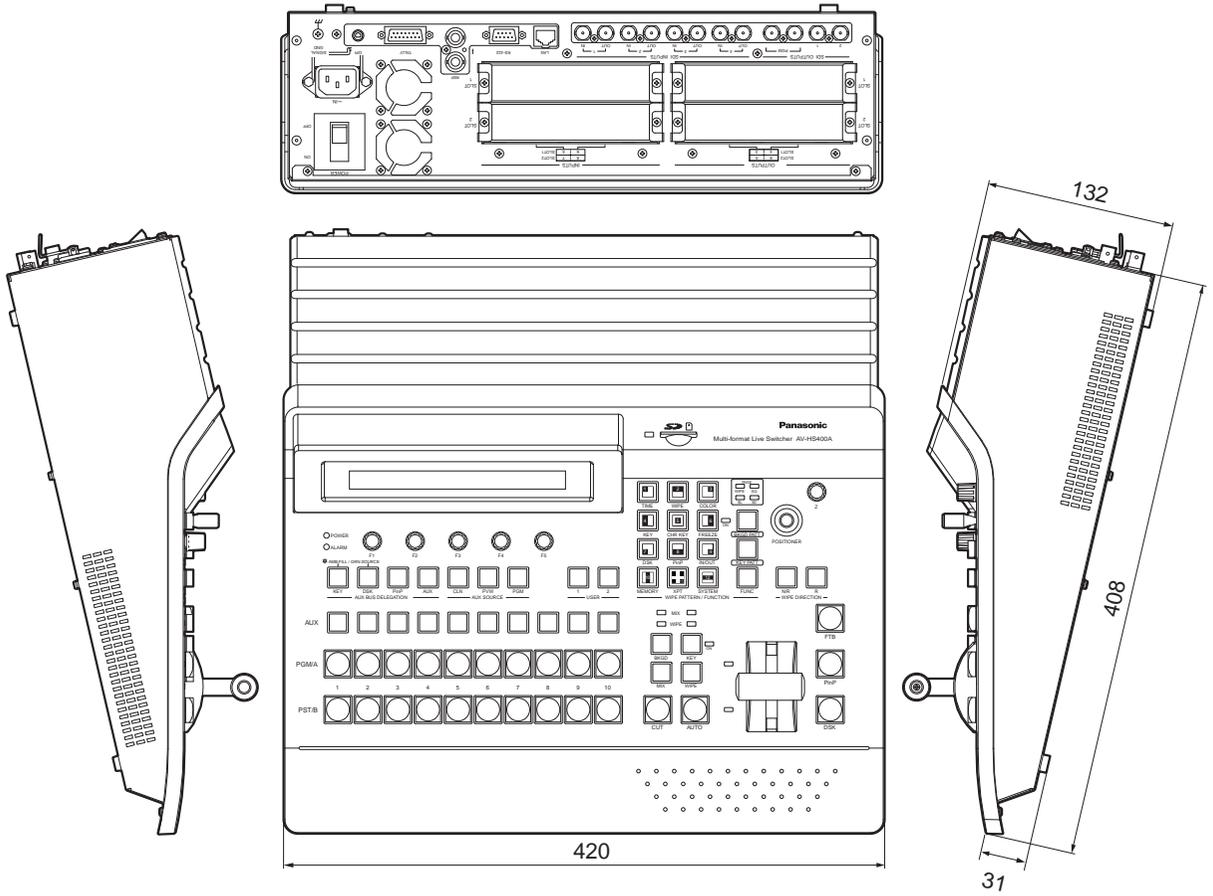

10. Specifications and standard accessories

■ Specifications

Inputs	<p>8 video input lines (maximum)</p> <p>4 standard video input lines: SDI inputs ×4</p> <p>Maximum of an additional 4 video input lines as options: SDI inputs ×2, analogue component (HD/SD) inputs ×2, DVI inputs ×2, analogue composite inputs ×2</p> <p>Up to two optional boards from among the various optional input boards (incorporating two up-converter lines) can be additionally connected.</p> <p>Reference ×1</p>
Outputs	<p>7 video signal lines (maximum)</p> <p>3 standard video output lines (SDI): PGM outputs ×2, OUTPUT1 output ×1, OUTPUT2 output ×1</p> <p>Maximum of an additional 4 video output lines as options: OUTPUT3 to 6 ×1 output</p> <p>Up to two optional boards from among the analogue component (HD/SD) ×2, DVI ×1/analogue component ×1, and SDI ×2 (incorporating two down-converter lines) output boards can be additionally connected.</p> <p>* PGM, PVW, AUX, MULTI and KEYOUT can be assigned to OUTPUT1 to 6.</p> <p>Reference ×1</p>
Signal formats	<p>HD: 1080/59.94i, 1080/50i, 720/59.94p, 720/50p</p> <p>SD: 480/59.94i, 576/50i</p>
Signal processing	<p>Y:Cb:Cr 4: 2: 2, 10 bit</p> <p>RGB 4:4:4, 8 bit</p>
ME number	1ME
SDI inputs	<p>HD: Serial digital (SMPTE 292M)</p> <p>SD: Component digital (SMPTE 259M)</p> <p>BNC connector, IN1 to 8 (with active through), up to 8 lines * IN5 to 8 are optional inputs.</p> <p>HD [SMPTE 292M (BTA S-004B) standard complied with]</p> <ul style="list-style-type: none"> • 0.8 Vp-p ±10 % (75 Ω) • Input return loss More than 15 dB (5 MHz to 750 MHz) More than 10 dB (750 MHz to 1.5 GHz) • Automatic equalizer 100 m (when 5C-FB cable is used) <p>SD [SMPTE 259M standard complied with]</p> <ul style="list-style-type: none"> • 0.8 Vp-p ±10 % (75 Ω) • Input return loss More than 15 dB (5 MHz to 270 MHz) • Automatic equalizer 200 m (when 5C-2V cable is used)

10. Specifications and standard accessories

SDI outputs	HD: Serial digital (SMPTE 292M) SD: Component digital (SMPTE 259M)	
	BNC connector, PGM ×1 (2 outputs), OUTPUT 1 to 6, up to 6 lines * OUTPUT 3 to 6 are optional outputs.	
	HD [SMPTE 292M (BTA S-004B) standard complied with] <ul style="list-style-type: none"> • Output return loss More than 15 dB (5 MHz to 750 MHz) More than 10 dB (750 MHz to 1.5 GHz) • Output level 0.8 Vp-p ±10 % (75 Ω) • Rise time Less than 270 ps • Fall time Less than 270 ps • Difference between rise time and fall time Less than 100 ps • Alignment jitter Less than 0.2 UI (130 ps) • Timing jitter Less than 1.0 UI • Eye aperture ratio More than 90 % • DC offset 0 ±0.5 V 	
SDI outputs	SD [SMPTE 259M standard complied with] <ul style="list-style-type: none"> • Output return loss More than 15 dB (5 MHz to 270 MHz) • Output level 0.8 Vp-p ±10 % (75 Ω) • Rise time Less than 1.5 ns • Fall time Less than 1.5 ns • Difference between rise time and fall time Less than 0.5 ns • Jitter Less than 0.2 UI 	
Analogue composite input (option)	Analogue composite (1.0 Vp-p, 75 Ω)	
	BNC connector, IN5 to 8 (with loop-through), up to 4 lines	
Analogue input (option)	SD/HD analogue component Y/Pb/Pr (1.0 Vp-p, 75 Ω)	
	BNC connector, IN5 to 8, up to 4 lines	
Analogue output (option)	SD/HD analogue component Y/Pb/Pr (1.0 Vp-p, 75 Ω)	
	BNC connector, OUTPUT3 to 6, up to 4 lines (which can be assigned)	
DVI-I input (option)	XGA (1024×768), WXGA (1280×768), SXGA (1280×1024) Vertical frequency: 60 Hz	
	DVI-I connector, IN5 to 8, up to 4 lines	
DVI-I output (option)	XGA (1024×768), WXGA (1280×768), SXGA (1280×1024), WSXGA+* (1680×1050), UXGA* (1600×1200), WUXGA* (1920×1200) (*: Selectable only when digital signals are output) Vertical frequency: 60 Hz	
	DVI-I connector, OUTPUT3, OUTPUT5, up to 2 lines (which can be assigned)	
Key input	1 input from video inputs	
Downstream Key input	1 input from video inputs	
Reference input	BNC connector, Black burst or Tri-level Sync (with loop-through) ×1	
Reference output	In gen-lock mode: BNC connector, loop-through output ×1, In internal sync mode: BNC connector, black burst ×2	
Video delay time	Frame synchronizer OFF	1H
	Frame synchronizer ON	1F

10. Specifications and standard accessories

Control I/O	LAN (10BASE-T)	10 Mbps ×1 (RJ-45)
	Serial communication interface	RS-422 ×1 (D-sub 9-pin, female, inch screw) • Pan-tilt head system (pan-tilt head and camera) control supported • GVG standard protocol subset supported
	Tally output	Open collector outputs (negative logic) 1 to 8 (D-sub 15-pin, male, inch screw)
	GPI	GPI ×2 (3.5 mm diameter stereo mini jack)
External media	SD memory cards	Memory size supported: Max. 2 GB Still image file transfer: 24-bit uncompressed bitmap, baseline JPEG (loading only)
Ambient operating temperature	0 °C to 40 °C	
Humidity	10 % to 90 % (no condensation)	
Power supply	AC 220 V - 240V, 50/60 Hz	
	Power consumption	98 W
Dimensions (W × H × D)	420×132×408 mm [Excluding protrusions]	
Weight	6.4 kg: when no options have been installed	
	7.2 kg: when all the possible options have been installed	

■ Standard accessories

Operating instructions	1
CD-ROM (Operating instructions/Image transmission software)	1
Power cord	2

■ Optional boards (sold separately)

SDI Input Board:	AV-HS04M1
Analogue Input Board:	AV-HS04M2
DVI Input Board:	AV-HS04M3
Analogue Output Board:	AV-HS04M4
DVI/Analogue Output Board:	AV-HS04M5
Analogue Composite Input Board:	AV-HS04M6
SDI Output Board:	AV-HS04M7

Refer to the operating instructions that come with the optional board for details about the installation method.

Appendix (glossary)

Defined below are the terms used in this manual.

Word	Explanation
AB Bus system	A bus control mode. By executing a transition, the A bus and B bus signals are output to the programme images alternately.
Ancillary Data	The auxiliary data other than the video signals which is transmitted inside the data stream of the video serial interface. The data superimposed on the vertical blanking period is referred to as the V ancillary data (VANC).
Aspect ratio	The ratio between the horizontal and vertical dimensions of an image or screen. It is 16:9 for the HD format and 4:3 for the SD format.
AUX [Auxiliary Bus]	A spare bus which can be switched by signals other than the main line output signals.
AVDL [Automatic Video Delayline]	A function to automatically adjust the input image signal phase to the horizontal synchronization reference signal phase.
BB [Black burst]	The black burst signal. A full-screen black level composite signal which is used as the reference signal for gen-lock.
Border	The area or margin that is added to the edge of a wipe or key. Its width and colour can be adjusted. The defocusing of the area around a border is referred to as the soft effect.
Chroma key	This refers to the function for creating the key signals based on the colour information of the video signals and combining the keys.
Clip	The threshold level of the luminance when key signals are created from a key source.
Colour Background	The signals which are output from the internal colour generator and used as the background image.
Cut	This refers to the effect where the display is instantly switched to the next image.
Density	A parameter which is used to adjust the density of the key signals.
Dot by Dot	This treats images as actual size (1×) images. With PinP, it allows SD images to be combined with HD images with no accompanying deterioration in the images themselves.
Down Converter	This is the function that converts material in the HD format into the SD format.
DSK [Downstream Key]	This refers to the key combination process which is performed at the end of the mix effect. The key is always combined with the foremost image.
DVE [Digital Video Effect]	This refers to the transition patterns accompanying size reductions or slide effects.
DVI [Digital Visual Interface]	A digital video interface standard. DVI-I can handle both digital signals and analogue signals.
Embedded Audio	This refers to the audio data packets which are transferred inside the data stream of the video serial interface.
Flip Flop system (PGM/PST system)	A bus control mode. The signals selected by the programme bus are always output as the programme images. By executing a transition, the programme bus and preset bus signals are switched over.
Flying Key	This function uses DVE effects to move, expand or reduce key signals.

Appendix (glossary)

Word	Explanation
Frame Memory	A memory which can hold the video signals equivalent to one frame.
Frame Synchronizer	A function which matches the synchronization of non-synchronized video input signals.
Freeze	A function which continues the display of the same image, creating the impression that the image has been "frozen".
FTB [Fade to Black]	This is the effect where the background image is faded out to the black screen.
Genlock	A function for synchronizing the video signals using an external sync signal as the reference.
GPI [General Purpose Interface]	Interface signals which control auto transition from an external source.
Hue	The colour tone of the video signals.
IRE	A unit used for video signal levels. The setup level (black level) of the signals is expressed as 0 IRE, 7.5 IRE, etc.
Key Edge	The border or shadow added to the edges of keys.
Key Fill	The signal that uses key combination processing to fill in the areas left blank by the key signals.
Key Gain	A parameter which is used to adjust the amplitude of the key signals.
Key Invert	A function which inverts the key signals.
Key Mask	This is the function that specifies the area for key combination using the box pattern, etc. When only part of the area of the key signals is used, key combination is executed with the unnecessary area masked.
Key Source	The video signals for creating the key signals.
Linear Key	The function which combines keys using monochrome key signals with gradations in its outlines as a reference.
Lum [Luminance]	The brightness portion of the video signals.
Luminance Key	The function which creates key signals based on the luminance (brightness) information of the video signals to combine keys.
ME [Mix Effect]	A video effect device which combines a number of video signals to create mix, wipe, key and other video signals.
Mix	The picture-changing effect produced by overlapping one image with the next. It is also referred to as "dissolve".
Multi View Display	This function combines multiple materials and displays them on one screen. PGM, PVW and the input material can be previewed at the same time on a single screen.
OSD [On Screen Display]	This function enables settings to be performed on the menu screens which are displayed in the monitor output.
PinP [Picture in Picture]	This function combines a sub screen image with the background image.

Appendix (glossary)

Word	Explanation
PVW [Preview]	The function for checking ahead of time the image which will be output after the next transition. The image is output from the PVW system.
PGM [Programme Bus]	The bus which always carries the programme output signals.
PST [Preset Bus]	The bus which carries the programme output signals after the next background transition.
Preset Memory	The memory in which the control panel statuses can be saved and recalled. The button selection statuses as well as the border, colour and other setting information can be saved in this memory.
RS-422	A serial interface standard. It is the interface used to control the switcher from an editor or other external device.
Sat [Saturation]	This refers to the intensity of the colour chrominance level of video signals.
SDI [Serial Digital Interface]	The standard by which video signals in various SD and HD formats are transmitted along a single coaxial cable.
Self Key	A function that creates key signals from key fill signals for combining keys.
Tally	The signal which outputs the programme output statuses of the input signals to an external device. The LED that indicates the programme output status on the control panel is also referred to as tally.
Transition	A function that switches from one image to another. Wipe, mix and other effects are available for the images during switching.
Tri-level Sync	The sync signal used for HD formats.
Trimming	This is the function that eliminates the unnecessary parts at the top, bottom, left and/or right of the images which are combined using the PinP function.
Up Converter	This is the function that converts material in the SD format into the HD format which yields a high resolution.
Wipe	A video effect in which one image is gradually replaced by another as the boundary between the two is moved using a preselected pattern.

Panasonic Corporation

Web Site: <http://panasonic.net>

Importer's name and address to follow EU rules:

Panasonic Testing Centre

Panasonic Marketing Europe GmbH

Winsbergring 15, 22525 Hamburg, F.R. Germany

© Panasonic Corporation 2008