

Panasonic[®]

Owner's Manual for advanced features Digital Camera

Model No. **DMC-LX7**

LUMIX

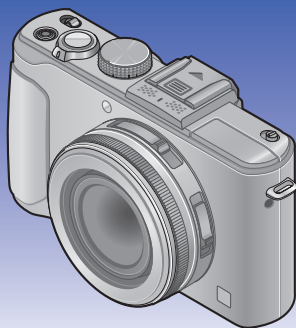

Before connecting, operating or adjusting this product,
please read the instructions completely.



Register online at
www.panasonic.com/register
(U.S. customers only)



VQT4J11
M0712KZ0

Contents

Preparations	
Before use	6
Standard Accessories	8
Names and Functions of Main Parts	9
Attaching the lens cap and shoulder strap	13
Charging battery	14
Remaining battery	15
Guidelines for number of recordable pictures and operating time	16
Inserting and removing the battery or SD memory card (optional)	18
Saving your pictures (cards and built-in memory)	20
Recording capacity guidelines (pictures/recording time)	21
Setting the clock	23
Changing time settings.....	24
Setting the menu	25
Using the [Setup] menu	27
[Clock Set]	27
[World Time]	27
[Travel Date]	28
[Beep]	29
[Volume]	30
[Cust.Set Mem.]	30
[Fn Button Set]	30
[LCD Display] / [Viewfinder]	31
[LCD Mode]	31
[LVF Disp.Style] / [LCD Disp.Style]	32
[Guide Line]	32
[Histogram]	33
[Video Rec Area]	34
[Remaining Disp.]	34
[Highlight]	34
[Expo.Meter]	35
[Lens Resume]	35
[MF Assist]	35
[Economy]	36
[Play on LCD]	37
[Auto Review]	37
[Start Mode]	38
[No.Reset]	38
[Reset]	39
[USB Mode]	39
[Output]	39
[VIERA Link]	40
[3D Playback]	40
[Rotate Disp.]	40
[Scene Menu]	41
[Menu Resume]	41
[User's Name Rec]	41
[Version Disp.]	42
[Format]	42
[Language]	43
[Demo Mode]	43
Entering Text	44

Application (Record)	
Sequence of operations	45
About recording modes	48
Taking pictures with automatic settings	
[Intelligent Auto] Mode	49
Automatic Scene Detection	49
Defocusing the background	50
About flash	52
[Color Mode]	53
[Motion Deblur]	53
[iHandheld Nite Shot]	53
[iHDR]	54
AF Tracking	55
[Intelligent Auto Plus] Mode	56
About setting items	57
Taking pictures with your own settings	
[Program AE] Mode	58
Program Shift	58
[Program Diagram]	59
Taking pictures by setting the aperture value	
[Aperture-Priority] Mode	60
Taking pictures by setting the shutter speed	
[Shutter-Priority] Mode	61
Taking pictures by setting the aperture value and shutter speed	
[Manual Exposure] Mode	62

Taking pictures by changing the picture effect

[Creative Control] Mode	64
[Expressive]	66
[Retro]	66
[High Key]	67
[Low Key]	67
[Sepia]	68
[Dynamic Monochrome]	68
[Impressive Art]	69
[High Dynamic]	69
[Cross Process]	70
[Toy Effect]	70
[Miniature Effect]	71
[Soft Focus]	72
[Star Filter]	72
[One Point Color]	73
[Smooth Defocus]	73
[Radial Defocus]	74

Taking pictures according to the scene

[Scene Mode]	75
[Portrait]	76
[Soft Skin]	76
[Scenery]	76
[Panorama Shot]	76
[Sports]	78
[Night Portrait]	78
[Night Scenery]	78
[Handheld Night Shot]	78
[HDR]	79
[Food]	79
[Baby]	79
[Pet]	79
[Sunset]	80
[Glass Through]	80
[3D Photo Mode]	81

Recording motion pictures

Taking still pictures while a motion picture is being recorded	86
--	----

Recording motion pictures with manual operation [Creative Video Mode]

[High Speed Video]	89
--------------------------	----

Registering your own settings and recording [Custom] Mode

[Cust.Set Mem.]	90
[Custom]	91

Using Zoom	92	Recording with the Face Recognition function [Face Recog.]	130
Optical Zoom.....	93	Registering face pictures	131
Extended optical zoom.....	93	Editing or deleting information about registered persons	133
[i.Zoom]	94	Using the [Rec] menu	134
[Digital Zoom].....	94	[Photo Style].....	134
[Step Zoom].....	95	[Picture Size].....	135
Taking pictures with Auto Focus	96	[Quality].....	136
Taking front-on pictures of people.....	97	[ISO Limit Set].....	137
Automatically locking the focus on a moving subject	98	[ISO Increments]	137
Subject not centered in picture.....	98	[Extended ISO].....	137
Determined position for focus	99	[Program Diagram].....	137
Using Manual Focus together with Auto Focus	101	[Face Recog.].....	137
Taking close-up pictures	102	[AF Mode].....	137
Taking pictures by locking the exposure and/or focus	103	[Quick AF].....	138
Taking pictures with Manual Focus ...	104	[AF/AE Lock]	138
Taking pictures with the built-in flash	106	[Metering Mode]	139
Changing the setting of the flash.....	107	[i.Dynamic]	139
Setting the ISO Sensitivity	109	[Multi Expo.]	140
Setting coloring (White Balance)	111	[Min. Shtr Speed]	141
Setting the White Balance manually	112	[i.Resolution]	141
Setting the White Balance using color temperature.....	113	[i.Zoom]	141
Performing White Balance fine adjustments.....	113	[Digital Zoom]	141
Bracket recording using White Balance	114	[Step Zoom].....	142
Taking pictures with self-timer	116	[Stabilizer]	142
Setting the burst function	118	[AF Assist Lamp]	143
Changing the aspect ratio of the still pictures	121	[Flash]	143
Automatically changing the aspect ratio while taking pictures [Aspect Bracket].....	122	[Flash Synchro].....	144
Using the built-in ND filter	123	[Flash Adjust.].....	145
Compensating the exposure	124	[Red-Eye Removal].....	145
[Auto Bracket].....	125	[Color Mode].....	146
Switching the display of recording information, etc.	127	[Motion Deblur].....	146
Using the level gauge	128	[iHandheld Nite Shot]	146
Using Quick menu	129	[iHDR].....	146
		[Opt. Viewfinder].....	146
		[Aspect Bracket]	146
		[Time Lapse Shot]	147
		[Date Stamp]	149
		[Clock Set].....	149
		Using the [Motion Picture] menu	150
		[Rec Mode].....	150
		[Rec Quality].....	150
		[Continuous AF].....	151
		[Wind Cut]	151

Application (View)

Viewing your pictures	
[Normal Play]	152
Zooming in and viewing	
“Playback zoom”	153
Viewing a list of pictures	
“Multi Playback”	154
Viewing pictures by their recording date	
“Calendar Playback”	155
Playing back pictures recorded in burst and interval recording	156
About panorama playback	158
Viewing motion pictures	159
Capturing still pictures from motion pictures	160
Splitting up motion pictures	161
Changing the picture information display, etc.	162
Deleting pictures	163
To delete multiple (up to 100)/	
To delete all pictures	164
Different playback methods	
[Playback Mode]	165
[2D/3D Settings]	165
[Slide Show]	166
[Filtering Play]	168
[Calendar]	168
Retouching pictures	169
[Auto Retouch]	169
[Creative Retouch]	170
Using the [Playback] menu	171
[Upload Set]	171
[Title Edit]	172
[Text Stamp]	173
[Video Divide]	174
[Resize]	175
[Cropping]	176
[Leveling]	177
[Favorite]	178
[Print Set]	179
[Protect]	180
[Face Rec Edit]	181
[Copy]	182

Others

Viewing on TV screen	183
VIERA Link (HDMI) (HDAVI Control™)	185
Viewing 3D still pictures	187
Storing recorded still pictures and motion pictures	189
Copying by inserting the SD card into the recorder	189
Dubbing playback pictures via AV cables (optional)	189
Using “PHOTOfunSTUDIO” to copy to your computer	190
Using with your PC	191
Copying still pictures and motion pictures recorded in [MP4] (except AVCHD motion pictures)	192
Uploading pictures to image-sharing websites	194
Printing	195
Printing multiple pictures	197
Printing with date and text	197
Making print settings on the camera	198
Digital Camera Accessory System ...	199
Using the Live View Finder (optional)	199
Using the External Viewfinder (optional)	200
Using the external flash (optional)	201
Using the filter (optional)	203
Using the AC adaptor (optional) and DC coupler (optional) instead of the battery	205
List of LCD monitor displays	206
Message displays	211
Q&A Troubleshooting	213
Usage cautions and notes	222

Before use

■ Camera handling

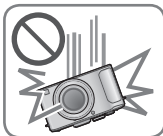

Keep the camera away from excessive vibration, force, or pressure.

- Avoid using the camera under the following conditions, which may damage the lens, LCD monitor, or camera body. This may also cause the camera to malfunction or prevent recording.
 - Dropping or hitting the camera against a hard surface
 - Sitting down with the camera in your pants pocket or forcing it into a full bag
 - Adding accessories to the camera strap
 - Pushing with excessive force on the lens or LCD monitor

The camera is not dust resistant, splash resistant, or waterproof.

Avoid using the camera in places with excessive dust or sand, or where water can come into contact with the camera.

- Avoid using the camera under the following conditions, which present a risk that sand, water, or foreign material may enter the camera through the lens or openings around buttons. Be especially careful because these conditions may damage the camera, and such damage may not be repairable.
 - In extremely dusty or sandy places
 - In the rain or by the shore, where the camera may be exposed to water

■ Condensation (When the lens or the LCD monitor is fogged up)



- Condensation may occur when the camera is exposed to sudden changes of temperature or humidity. Avoid these conditions, which may make the lens or LCD monitor dirty, cause mold, or damage the camera.
- If condensation does occur, turn off the camera and wait about two hours before using it. Once the camera adjusts to the surrounding temperature, the fogging will clear naturally.

■ Always take a test shot first

Before important events when you will use the camera (at weddings, for example), always take a test shot to make sure that pictures and sound record correctly.

■ No compensation for missed shots

We cannot compensate for missed shots if technical problems with the camera or card prevent recording.

■ Carefully observe copyright laws

Unauthorized use of recordings that contain works with copyright for purposes other than personal use is prohibited under copyright law. Recording of certain material may be restricted even for the purpose of personal use.

■ Also refer to “Usage cautions and notes” (→222)

- Please note that the actual controls and components, menu items, and other information for your digital camera may differ from those in the illustrations and screens provided in this manual.
- Recording mode icons
You can select and execute indicated menus and functions for the recording modes displayed in blue on mode dial illustrations next to section titles.



In the example shown on the left, the following recording modes are available: **P**, **A**, **S** and **M**.

* C1 and C2 will differ depending on the recording modes registered under custom settings.

Standard Accessories

Check that all the accessories are supplied before using the camera.

- The accessories and their shape will differ depending on the country or area where the camera was purchased.
For details on the accessories, refer to Basic Owner's Manual.
- Battery Pack is indicated as battery pack or battery in the text.
- Battery Charger is indicated as battery charger or charger in the text.
- SD Memory Card, SDHC Memory Card and SDXC Memory Card are indicated as card in the text.
- Please dispose of all packaging appropriately.
- Keep small parts in a safe place out of the reach of children.

■ Optional accessories

- **Cards are optional.** You can record or play back pictures on the built-in memory when you are not using a card. ([→20](#))
- If any accessories are lost, customers in the USA and Puerto Rico should contact Panasonic's parts department at 1-800-833-9626 and customers in Canada should contact 1-800-99-LUMIX (1-800-995-8649) for further information about obtaining replacement parts.

Names and Functions of Main Parts

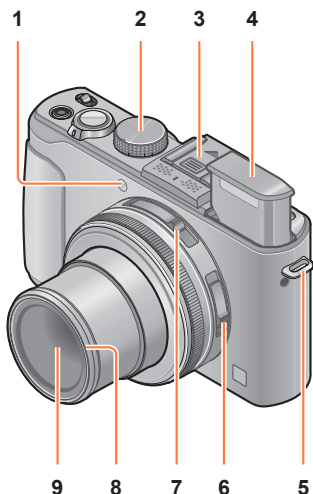

1 Self-timer indicator / AF Assist Lamp

Illuminates when the self-timer is set or when the Auto Focus is operated in dark locations. (→116, 143)

2 Mode dial

Switches the recording mode. (→48)

3 Hot shoe (Hot shoe cover)

The hot shoe cover is already attached to the hot shoe at the time of purchase.

4 Built-in flash (flash)

Use the flash open switch to open the flash. (→106)

5 Shoulder strap eyelet

Attach the supplied shoulder strap and lens cap string to this eyelet. (→13)

6 Focus selector switch

Switches the focus setting. (→96, 102, 104)

7 Aspect ratio selector switch

Switches the aspect ratio of a still picture. (→121)

8 Thread protector (→203)

9 Lens

The lens barrel extends forward when you take a picture.

■ About the hot shoe cover

Remove the hot shoe cover when using a Live View Finder (optional), External Viewfinder (optional) or External Flash (optional).

Removing the hot shoe cover

While pressing down on the hot shoe cover release button ①, pull the cover in the direction of the arrow ② to detach.

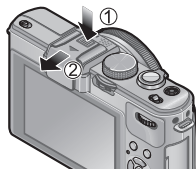

- Be sure to attach the hot shoe cover when the hot shoe is not in use.
- Keep the hot shoe cover safely after removing it so that you do not lose it.
- When the hot shoe cover is removed, make sure that foreign substances such as liquids or sand are not spilled on the dedicated connector.

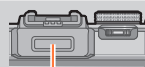

Dedicated connector

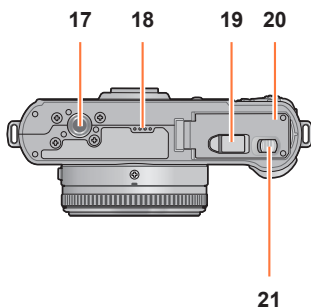
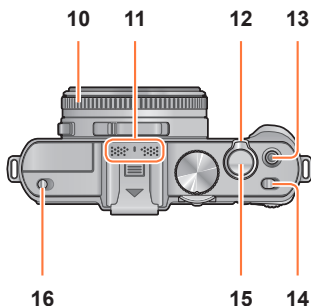

- 10 Aperture ring**
Adjusts the aperture value. (→60, 62)
- 11 Microphone**
Records sound when you record motion pictures. (→82)
- 12 Zoom lever**
Adjusts the recording range. (→92)
- 13 Motion picture button**
Press this button to start and stop motion picture recording. (→46)
- 14 Camera ON/OFF switch**
Turns the camera on or off.
- 15 Shutter button**
Press this button to record a still picture. (→46)
- 16 Flash open switch**
Operate this switch to open the flash. (→106)
- 17 Tripod mount**
Attach a tripod or other accessories to this receptacle.
Do not attach to a tripod with a 5.5 mm or longer screw. Doing so may damage this unit.
- 18 Speaker**
Do not cover the speaker with your fingers.
- 19 DC coupler cover**
Use the AC adaptor (optional) and DC coupler (optional) specifically for this camera. (→205)
- 20 Card/Battery door**
Open this door to insert and remove a card or battery. (→18)
- 21 Release lever**
Slide this lever to open the card/battery door. (→18)

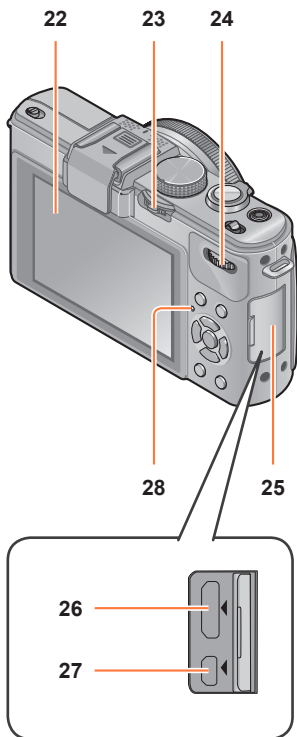

22 LCD monitor (→206)

23 [ND/FOCUS] lever

To operate the lever, move it left or right or push it in. Use this lever for Manual Focus adjustment or for turning the built-in ND filter on/off, etc. (→104, 123)

24 Rear dial

To operate the dial, rotate it left or right or push it in. Use this dial for operations such as adjusting the shutter speed or selecting an operation item. (→61, 62, 124)

25 Terminal cover

How to open the terminal cover

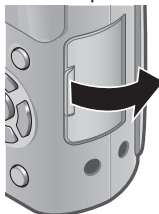

26 [HDMI] socket

Connect the HDMI mini cable (optional) to this socket. (→183)

27 [AV OUT/DIGITAL] socket

Connect the USB connection cable or AV cable (optional) to this socket. (→183, 192, 195)

28 Status indicator

This indicator lights up in accordance with the operating conditions of the camera.

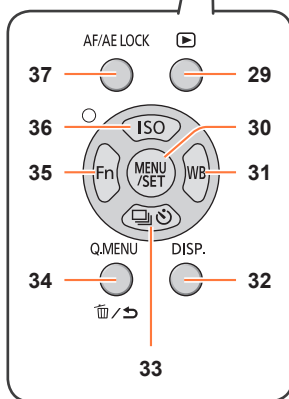
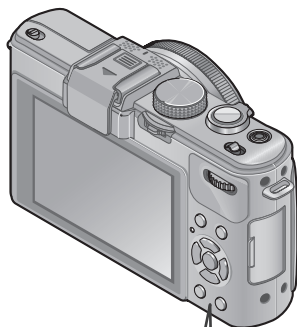
**29 Playback button**

Switches between recording mode and playback mode. (→152)

30 [MENU/SET]

Mainly used to display menu screens or to set menu items. (→25)

31 [WB] button / Right cursor button (▶)

Displays the White Balance setting screen. This button is also used to move the cursor on the menu screens and for other functions. (→25, 111)

32 [DISP.] button

Switches the displayed screens. (→127, 162)

33 [] button / Down cursor button (▼)

Displays the setting screens for burst, self-timer and other functions. This button is also used to move the cursor on the menu screens and for other functions. (→25, 116, 118, 125)

34 [Q.MENU] button / [] button

Displays the Quick menu in recording mode. Deletes pictures in playback mode. This button is also used to return to the previous screen on the menu screen. (→129, 163)

35 [Fn] button / Left cursor button (◀)

Displays the screen of the function registered to the corresponding [Fn] button. This button is also used to move the cursor on the menu screens and for other functions. (→25, 30)

36 [ISO] button / Up cursor button (▲)

Displays the setting screen for ISO Sensitivity. This button is also used to move the cursor on the menu screens and for other functions. (→25, 109)

37 [AF/AE LOCK] button

Locks the exposure and focus. (→103, 138)

Attaching the lens cap and shoulder strap

Cover the lens with the lens cap to protect it when you are not taking pictures. We recommend attaching the lens cap to the camera using the lens cap string to prevent loss of the lens cap. We also recommend attaching the shoulder strap to prevent the camera from being dropped.

1 Use the supplied string to attach the lens cap to the camera

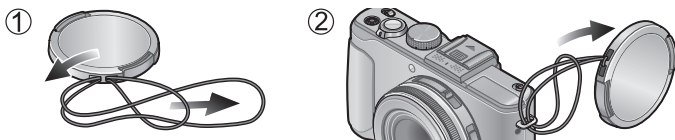

2 Attach the lens cap

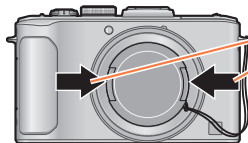

To attach and remove the lens cap, press the areas shown by arrows in the illustration.

3 Attach the shoulder strap

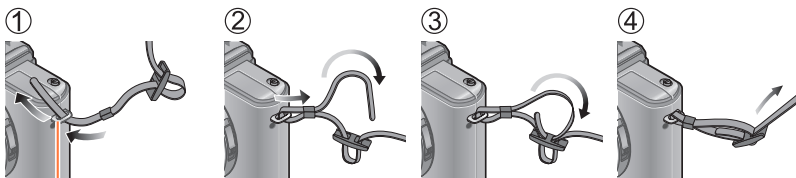

Shoulder strap eyelet

- Attach the other end of the shoulder strap.
- Make sure that the shoulder strap does not come loose.
- Attach the shoulder strap with the LUMIX logo on the strap facing out.
- Use the shoulder strap around your shoulder.
 - Do not wrap the strap around your neck. It may result in injury or accident.
- Do not leave the shoulder strap where an infant can reach it.
 - It may result in an accident by mistakenly wrapping around the neck.

Charging battery

Always charge before first use! (battery shipped uncharged)

■ About batteries that you can use with this unit

It has been found that counterfeit battery packs which look very similar to the genuine products are made available to purchase in some markets. Some of these battery packs are not adequately protected with internal protection to meet the requirements of appropriate safety standards. There is a possibility that these battery packs may lead to fire or explosion. Please be advised that we are not liable for any accident or failure occurring as a result of use of a counterfeit battery pack. To ensure that safe products are used we recommend that a genuine Panasonic battery pack is used.

- Use the dedicated charger and battery.

1 Position the battery contacts to meet the charger, then insert the battery into the charger



2 Plug the charger into the AC power

- Plug-in type
- Inlet type

Battery

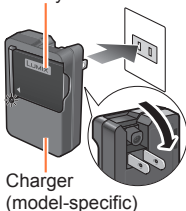

Charger
(model-specific)



- The AC cable does not fit entirely into the AC input terminal. A gap will remain.

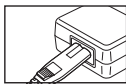

Charging light ([CHARGE])

- On:** Charging in progress
- Off:** Charging complete

If light is flashing:

- Charging may take longer than normal if battery temperature is too high or too low (charging may not be completed).
- Battery/charger connector is dirty. Clean with a dry cloth.

3 Detach the battery after charging is completed

- The battery charger is in the standby condition when the AC power is supplied. The primary circuit is always "live" as long as the battery charger is connected to an electrical outlet.

■ Notes on charging time

Charging time

Approx. 155 min

- The charging time indicated above is the time required for charging in case when the battery is completely used up. The time required for charging differs depending on conditions of battery usage. Charging takes longer in cases when temperatures are either high or low and when the battery has not been used for a long period of time.

- Always use genuine Panasonic batteries.
- If you use other batteries, we cannot guarantee the quality of this product.
- **Remove battery from camera after use.**
 - Keep the battery in a plastic bag, making sure that it is kept away from metallic objects (such as clips) when carrying or storing it.
- To remove the battery, turn the camera off and wait until the LUMIX indicator on the LCD monitor goes off. (Failure to wait may cause the camera to malfunction and may damage the card or recorded data.)
- The unusable battery should be discarded in accordance with battery recycling laws. Call the RBRC hotline at 1-800-822-8837 for information.

Remaining battery

When using the camera, the remaining battery capacity is displayed.

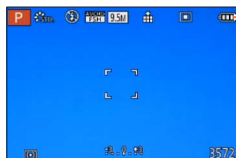

Remaining battery (only when using battery)



* While the LCD monitor is turned off, the status indicator will flash.

Guidelines for number of recordable pictures and operating time

The number of recordable pictures or available operating time may vary according to surrounding environment and usage conditions. Figures may be reduced if flash, zoom, or other functions are used frequently, or in colder climates.

■ Recording still pictures

Number of recordable pictures	Approx. 330 pictures	By CIPA standard
Recording time	Approx. 165 min	

● Recording conditions by CIPA standard

CIPA is an abbreviation of [Camera & Imaging Products Association].

- [Program AE] Mode
- Temperature: 23 °C (73.4 °F)/Humidity: 50%RH when LCD monitor is on.
- Using a Panasonic SD Memory Card (32 MB).
- Using the supplied battery.
- Starting recording 30 seconds after the camera is turned on (when the Optical Image Stabilizer function is set to [ON]).
- Recording once every 30 seconds with full flash every second recording.
- Rotating the zoom lever from Tele to Wide or vice versa in every recording.
- Turning the camera off every 10 recordings and leaving it until the temperature of the battery decreases.

Number reduced if intervals are longer (e.g. to approx. one quarter for 2-minute intervals under the above conditions).

■ Recording motion pictures

[Rec Mode]	[AVCHD]		[MP4]
[Rec Quality]	[PSH]	[FSH]	[FHD]
Available recording time	Approx. 90 min	Approx. 100 min	Approx. 110 min
Actual available recording time	Approx. 50 min	Approx. 55 min	Approx. 60 min

● Recording conditions

- Temperature 23 °C (73.4 °F), humidity 50%RH
- The time you can actually record when repeatedly turning the power on and off, starting and stopping recording and using zoom.

● Remaining time for continuous recording is displayed on the screen

- You can continuously record a motion picture in [MP4] for up to 29 minutes 59 seconds or approx. 4 GB. (Since recording in [MP4] with [FHD] creates larger files, the recording time for such motion pictures will be shorter than 29 minutes 59 seconds.)
- If [Rec Quality] of [AVCHD] motion pictures is set to [PSH] or [FSH], you can continuously record a motion picture for up to 29 minutes 59 seconds.

■ Viewing pictures

Playback time	Approx. 240 min
---------------	-----------------

- The number of recordable pictures or available operating time may vary according to surrounding environment and usage conditions.
- If available battery power is significantly reduced, battery is reaching end of lifespan. Please purchase a new battery.

Inserting and removing the battery or SD memory card (optional)

- Set the camera ON/OFF switch to [OFF].

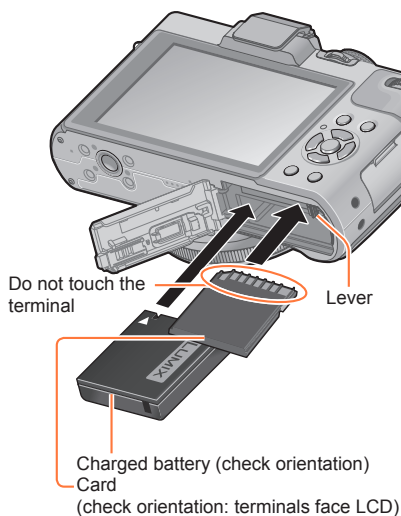

- 1** Slide the release lever to the [OPEN] position and open the card/battery door

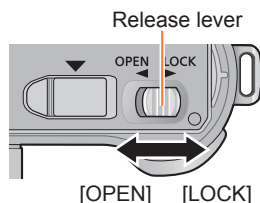

- 2** Insert the battery and card, making sure that their orientation is correct

- **Battery:** Insert the battery all the way firmly until a locking sound is heard, and check that the lever is hooked over the battery.
- **Card:** Insert the card all the way firmly until it clicks.

- 3** Close the door and slide the release lever to the [LOCK] position

■ To remove

- **To remove battery:**
Move lever in direction of arrow.

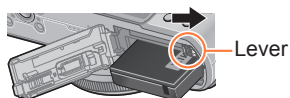

- **To remove card:**
Press down in center.

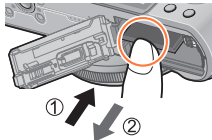

- Remove battery from camera after use.
- Keep the Memory Card out of reach of children to prevent swallowing.
- To remove the card or battery, turn the camera off and wait until the LUMIX logo display on the LCD monitor and the status indicator go out. (Failure to wait may cause the camera to malfunction and may damage the card or recorded data.)

Saving your pictures (cards and built-in memory)

Pictures will be saved to a card if one is inserted, or to the built-in memory  if not.

■ Built-in memory (approx. 70 MB)

- Pictures may be copied between cards and the built-in memory. (→182)
- The access time for the built-in memory may be longer than the access time for a card.

■ Compatible memory cards (optional)

The following SD standard-based cards (Panasonic brand recommended)

Type of Card	Capacity	Notes
SD Memory Cards	8 MB – 2 GB	<ul style="list-style-type: none"> • Can be used with devices compatible with the respective formats. • Before using SDXC Memory Cards, check that your computer and other devices support this type of card. http://panasonic.net/avc/sdcard/information/SDXC.html • Using a card of SD speed “Class 4”* or above is recommended for recording motion pictures. • Only the cards listed on the left with the given capacities are supported.
SDHC Memory Cards	4 GB – 32 GB	
SDXC Memory Cards	48 GB, 64 GB	

* SD speed class refers to a specification for sustained write speeds. Confirm the SD speed by checking the card label or other card related materials.



(Example)



- Latest information: <http://panasonic.jp/support/global/cs/dsc/>
(This site is available in English only.)

- While the camera is accessing the card or built-in memory (for an operation such as picture writing, reading, deletion, or formatting), do not turn off the camera or remove the battery, card, AC adaptor (optional) or DC coupler (optional). Do not subject the camera to vibrations, impact, or static electricity.

The card or the data on the card may be damaged, and this unit may no longer operate normally. If operation fails due to vibration, impact or static electricity, perform the operation again.

- Icons displayed while recording
 -  : When using a card
 -  : When using the built-in memory
- Please reformat the card with this camera if it has already been formatted with a computer or another device. (→42)
- If the write-protect switch is set to “LOCK”, the card cannot be used to record or delete pictures, and it cannot be formatted.
- It is recommended that you copy important pictures to your computer (as electromagnetic waves, static electricity, or faults may cause data to be damaged).



Switch

Recording capacity guidelines (pictures/recording time)



The number of pictures you can take and the recording time vary in proportion to card capacity (and depending on recording conditions and type of card).



Displayed when no card is inserted
(pictures will be saved to built-in memory)

Estimated remaining pictures or recording time capacity
(The display switches depending on the settings.)

■ Recording picture capacity (still pictures)

[Picture Size]	Built-in memory	2 GB	32 GB	64 GB
4:3  10M	16	440	7290	14530
4:3  5M	24	650	10620	21490
4:3  0.3M	380	10050	162960	247150

- When the number of recordable pictures exceeds 99,999, “+99999” is displayed.

■ Recording time capacity (motion pictures)

([h], [m] and [s] indicate “hour”, “minute” and “second”).

When the [AVCHD] recording mode is used

[Rec Quality]	Built-in memory	2 GB	32 GB	64 GB
[PSH]	–	8m00s	2h31m00s	5h07m00s
[FSH]/[SH]	–	14m00s	4h10m00s	8h26m00s

When the [MP4] recording mode is used

[Rec Quality]	Built-in memory	2 GB	32 GB	64 GB
[FHD]	–	12m02s	3h22m58s	6h50m54s
[HD]	–	22m59s	6h27m29s	13h04m28s
[VGA]	1m42s	50m36s	14h12m48s	28h46m30s

- The time displayed in the table is the total time.

● Remaining time for continuous recording is displayed on the screen

- You can continuously record a motion picture in [MP4] for up to 29 minutes 59 seconds or approx. 4 GB. (Since recording in [MP4] with [FHD] creates larger files, the recording time for such motion pictures will be shorter than 29 minutes 59 seconds.)
- If [Rec Quality] of [AVCHD] motion pictures is set to [PSH] or [FSH], you can continuously record a motion picture for up to 29 minutes 59 seconds.

- If you make Web upload settings, the recording picture capacity and the recording time capacity of the card may be reduced. ([→171](#))

Setting the clock

The clock is not set when the camera is shipped.

Preparation: Before using the camera, remove the lens cap.

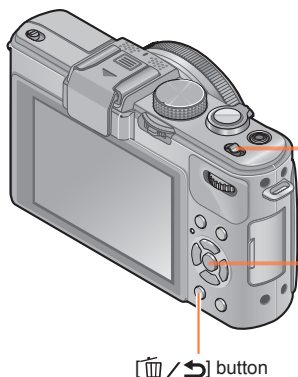

1 Turn on the power



The power is turned on.
If the language select screen is not displayed, proceed to step 4.

2 Press [MENU/SET] while the message is displayed

3 Press ▲▼ to select the language and press [MENU/SET]

4 The [Please set the clock] message appears. Press [MENU/SET]

5 Press ◀▶ to select the items (year, month, day, hour, minute, display order or time display format), and press ▲▼ to set

6 Press [MENU/SET]

7 Press [MENU/SET] to set

- To return to the previous screen, press [RECALL/SET] button.

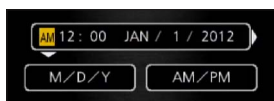

- If the clock is not set, the correct date cannot be printed when you order a photo studio to print the picture, or when you stamp the date on the pictures with [Date Stamp] or [Text Stamp].
- If the clock is set, the correct date can be printed even if the date is not displayed on the screen of the camera.

Changing time settings

Select [Clock Set] from the [Setup] menu or [Rec] menu to change the current time settings.

- Clock settings will be saved for approx. 3 months even after battery is removed, provided a fully-charged battery was installed in the camera for 24 hours beforehand.

1 Select [Clock Set] from the [Setup] menu or [Rec] menu

- For details about how to set the menu (→25)

2 Set the date and time (Perform steps **5** - **6**: (→23))

Setting the menu

You can use the menu to set camera and recording functions, operate playback functions, and perform other operations.

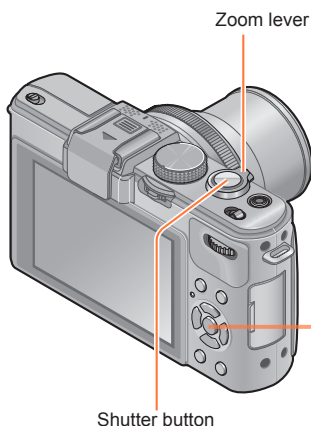

1 Press [MENU/SET] to bring up the menu



Each item's background color changes when it is selected

2 Select the menu type (→26)

3 Press ▲▼ to select the menu item and press ▶

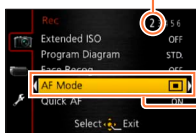

Page (Zoom lever can be used to switch to next page.)

Item

4 Press ▲▼ to select the setting and press [MENU/SET]

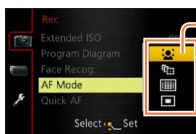

Selected setting

Settings

5 Press [MENU/SET] to close the menu



- You can also close the menu by pressing the shutter button halfway. (The camera switches to recording mode.)

■ Menu type

● In recording mode



● In playback mode

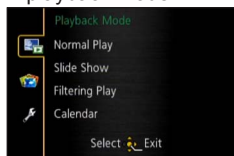

[Rec] menu	You can adjust settings such as number of pixels and flash.
[Motion Picture] menu	You can adjust settings such as recording method and picture quality.
[Playback Mode] menu	You can adjust settings for playback methods such as [Slide Show] and [Filtering Play].
[Playback] menu	You can adjust settings for recorded pictures, such as picture protection and cropping and print settings.
[Setup] menu	You can adjust settings to make operating the camera easier, such as setting the clock and changing the beep sounds.

■ Switching menu type

- ① Press ◀ to move the cursor from the menu item to the menu type (shown in left-hand frame).

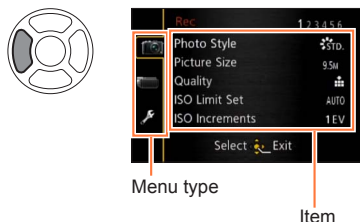

- ② Press ▲▼ to select the menu type to be displayed and press ▶ to return to the menu item

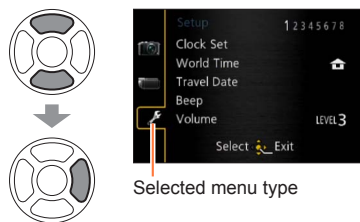

- The operation screen examples in this manual may differ from the actual screen display or some parts of the screen display are omitted.
- The menu types and items that are displayed vary according to the mode.
- The setting methods vary depending on the menu item.

Using the [Setup] menu

[Clock Set], [Economy] and [Auto Review] are important for clock setting and battery life. Please check these before use.

- For the setting procedures of the menu. (→25)

- In [Intelligent Auto] Mode, only [Clock Set], [World Time], [Beep] and [Stabilizer Demo.] are set.

[Clock Set]

Set time, date, and display format.

For details (→24).

[World Time]

Set the recording date and time with the local time at your destination.

- Message will be displayed when setting for the first time. In this case, press [MENU/SET] and skip to step 2.

1 Use cursor button to select [Destination] and press [MENU/SET]

2 Use cursor button to select area and press [MENU/SET]

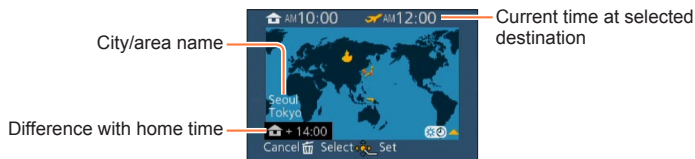

When [Destination] has been selected

■ To set summer time

Press ▲ in step **2**. (Press again to release the setting)

- When summer time is set, the current time is advanced by 1 hour. If the setting is canceled, the time automatically returns to the current time.

■ When you come back from your travel destination

Select [Home] in step **1** and press [MENU/SET].

- If you cannot find your destination in the area displayed on the screen, set based on difference with home time.
-  is displayed on the screen for pictures recorded at the destination when they are played back.

- For the setting procedures of the menu. ([→25](#))

[Travel Date]

If you set your travel schedule and record pictures, the day of your trip on which the picture was taken will be recorded.

- 1** Use cursor button to select [Travel Setup] and press ►
- 2** Use cursor button to select [SET] and press [MENU/SET]
- 3** Use cursor button to select the departure date and press [MENU/SET]
- 4** Use cursor button to select the return date and press [MENU/SET]

■ To record [Location]

Once the [Travel Setup] is set, you can set the location.

- ① Use cursor button in step **1** above to select [Location] and press ►
- ② Use cursor button to select [SET] and press [MENU/SET]
- ③ Enter your location (Entering text ([→44](#)))

- The travel date is calculated from the set departure date and the date set in the camera's clock. When destination is set in [World Time], days elapsed are calculated based on local destination time.
- When [Travel Setup] is set to [OFF], the number of days elapsed is not recorded. It is not displayed even if [Travel Setup] is set to [SET] after recording.
- If settings are made before departure date, number of days to departure are not recorded.
- To print [Location] or the number of days that have passed, either use [Text Stamp] or print using the "PHOTOfunSTUDIO" software on the supplied CD-ROM.
- [Travel Date] cannot be recorded for AVCHD motion pictures.
- [Destination] cannot be recorded for MP4 motion pictures.

- For the setting procedures of the menu. (→25)

[Beep]

Change or mute the beep/shutter sounds.

■ Settings

[Beep Level]

/ / : High / Low / Mute

[Beep Tone]

/ / : Change beep tone.

[Shutter Vol.]

/ / : High / Low / Mute

[Shutter Tone]

/ / : Change shutter tone.

- For the setting procedures of the menu. (→25)

[Volume]

Adjust volume of sound from speakers (7 levels).

■ Settings: [0] / [1] / [2] / [3] / [4] / [5] / [6]

- Cannot be used to adjust TV speaker volume when connected to TV.

[Cust.Set Mem.]

Register the current camera settings.

For details (→90).

[Fn Button Set]

Register frequently used functions from the [Rec] menu, [Setup] menu or other menus to the [Fn] button for faster operation.

■ Settings

[Photo Style] (→134)	[Level Gauge] (→128)
[Quality] (→136)	[Guide Line] (→32)
[Metering Mode] (→139)	[Video Rec Area] (→34)
[AF Mode] (→97)	[Remaining Disp.] (→34)
[Focus Area Set] (→100)	[Flash] (→107)
[1 Shot AF] (→105)	[Flash Adjust.] (→145)
[i.Dynamic] (→139)	[Aspect Bracket] (→122)

- For the setting procedures of the menu. (→25)

[LCD Display] / [Viewfinder]

Adjust the brightness and coloring of the LCD monitor. When the display is switched to Live View Finder (optional), the brightness and coloring of the viewfinder are adjusted.

1 Press ▲ ▼ to select the setting item, and press ◀ ▶ to make adjustments

2 Press [MENU/SET]

- Some subjects may look different from their actual appearance, but the recorded picture will not be affected.

[LCD Mode]

Make LCD monitor easier to see.

■ Settings

[A*]: The brightness is adjusted automatically depending on how bright it is around the camera.

[*]: Makes screen brighter than normal (for outdoor use).

[OFF]

- Cannot select [**A***] in playback mode.
- [*****] returns to ordinary brightness if there is no operation for 30 seconds when recording. (Press any button to make the screen brighter again.)
- Because the picture shown on the LCD monitor screen emphasizes brightness, some subjects may look different than their actual appearance, but this will not affect the recorded picture.
- Setting [LCD Mode] reduces the operating time.

- For the setting procedures of the menu. (→25)

[LVF Disp.Style] / [LCD Disp.Style]

[LVF Disp.Style]: Set the Live View Finder (optional) display.

[LCD Disp.Style]: Set the display of the LCD monitor.

■ Settings

: Live View Finder style display layout

: LCD monitor style display layout

- Display screen example (when using the LCD monitor)





 (Live View Finder style display layout)



 (LCD monitor style display layout)

[Guide Line]

Display the guide lines used as a reference for picture composition.

■ Settings:  /  /  / [OFF]

■ Setting the position of the guidelines

Select  to set the position of the guidelines.

- ① Select  under [Guide Line] in the [Setup] menu
- ② Use cursor button to move the position of the guidelines (point of intersection) and press [MENU/SET]
 - When you press [DISP.] button, the point of intersection will return to the center.

- For the setting procedures of the menu. (→25)

[Histogram]

Displays distribution of brightness in picture – e.g. if the graph peaks at the right, this means there are several bright areas in the picture (Guide). A peak in the center represents correct brightness (correct exposure). This can be used as a reference for exposure correction, etc.

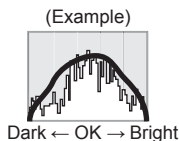

■ Settings: [ON] / [OFF]

- When the histogram is not the same as that of the recorded picture under the following conditions, histogram will be displayed in orange.
 - When manual exposure assist indicates settings other than 0 EV in [Manual Exposure] mode or during Exposure Compensation.
 - When the flash fires.
 - When the proper exposure is not achieved while the flash is closed or the brightness of a picture on the LCD monitor cannot be displayed correctly in dark locations.
- The histogram displayed during recording is only a reference.
- The histogram displayed during recording and that displayed during playback may be different.
- The histogram is different from those displayed using the image editing software of a computer.
- The histogram will not be displayed in the following cases.
 - [Intelligent Auto] Mode
 - During motion picture recording
 - Playback Zoom
 - Multi Playback
 - When the HDMI mini cable is connected

- For the setting procedures of the menu. (→25)

[Video Rec Area]

Enables verification of the recordable area for a motion picture before recording.

■ Settings: [ON] / [OFF]

- Recordable area displayed for motion pictures should be interpreted as a guideline.
- When using Extended optical zoom, the recordable area may not always be displayed for certain zoom ratios.

[Remaining Disp.]

Switch the display between the remaining number of still pictures you can take or the remaining recording time of a motion picture that you can record for the available card or built-in memory.

■ Settings

- ☐:☐ (Displays the number of pictures that can be recorded)
- ⌚:⌚ (Displays the remaining recording time)

[Highlight]

You can set overexposed areas (areas that are too bright and where there are no shades of gray) to flash on the screen when the [Auto Review] function is activated or during playback.

■ Settings: [ON] / [OFF]

- To reduce overexposed areas, record a picture by setting negative exposure compensation using the histogram display and so on as a reference. (The right edge of the histogram shows the overexposed portion.)
- This feature is disabled during Multi Playback, Calendar Playback, Playback Zoom or motion picture playback.
- If the subject is too close to the camera when recording using flash, overexposure may occur.

- For the setting procedures of the menu. (→25)

[Expo.Meter]

You can set whether to display the exposure meter when operations such as shutter speed and aperture value adjustments or Exposure Compensation are performed.

■ Settings: [ON] / [OFF]

- If the exposure meter is not displayed, press the [DISP.] button to switch the display of the LCD monitor.
- The exposure meter will turn off if no operation is performed for approximately 4 seconds.

[Lens Resume]

Save the zoom position and the Manual Focus position in the memory when the camera is turned off.

■ Settings

[Zoom Resume]

[ON]: Returns to the zoom position that was saved in the memory when the camera is turned on next time.

[OFF]

[MF Resume]

[ON]: Saves the Manual Focus position in the memory when the camera is turned [OFF] or when the focus selector switch is set to modes other than [MF]. This setting will return to the focus position saved in the memory when the camera is turned on or the focus selector switch is set to [MF] next time.

[OFF]

[MF Assist]

Set whether to enlarge the focus point when Manual Focus is used to adjust focus.

- About MF assist (→105)

■ Settings: [ON] / [OFF]

- For the setting procedures of the menu. (→25)

[Economy]

Turn off the power or make the LCD monitor go dark while not using the camera to minimize battery consumption.

[Sleep Mode]

■ Settings: [10MIN.] / [5MIN.] / [2MIN.] / [1 MIN.] / [OFF]

- Automatically shut off power when no operation is performed for a preset period of time.
- To restore → Press the shutter button halfway, or turn on the power again.

● Cannot be used in the following cases:

When the camera is using AC adaptor (optional) and DC coupler (optional), when the camera is connected to a computer or printer, when recording or playing back motion pictures or playing back pictures using Slide Show, or during interval recording or when in Automatic Demo Mode

- Settings fixed to [5MIN.] in [Intelligent Auto] Mode.

[Auto LCD Off]

■ Settings: [30 MIN.] / [5MIN.] / [2MIN.] / [1 MIN.]

Automatically turns off the LCD monitor when no operation is performed for a preset period of time.

- The status indicator lights up when the LCD monitor is turned off. To turn on the LCD monitor again, press any button.

[Live View Mode]

■ Settings: [NORMAL] / [ECO] (Reduces power consumption)

- Although the recording screen picture quality may deteriorate when [ECO] is set compared with when [NORMAL] is set, the recorded pictures will not be affected.
- When [Live View Mode] is set to [NORMAL], the operating time will be reduced.

- For the setting procedures of the menu. (→25)

[Play on LCD]

Set the LCD monitor to be displayed automatically when operation is switched to playback mode while the Live View Finder (optional) is attached.

- **Settings:** [ON] / [OFF]

[Auto Review]

Automatically display still pictures immediately after taking them.

- **Settings**

[HOLD]: Auto review screen remains until a button (other than the [DISP.] button) is pressed

[2SEC.] / [1SEC.]: Displays the playback screen for a preset time and then automatically returns to the recording screen

[OFF]

- The setting is fixed to [2SEC.] in [Intelligent Auto] Mode.
- Automatically displays still pictures immediately after they are taken during [Auto Bracket], [Aspect Bracket], [WB Bracket] and burst recording, regardless of the [Auto Review] setting.
- The Auto Review function is disabled during motion picture recording or interval recording.

- For the setting procedures of the menu. (→25)

[Start Mode]

Set whether the camera is activated in recording mode or playback mode when it is turned on.

■ Settings

: When the camera is turned on, recording mode is activated.

: When the camera is turned on, playback mode is activated.

- Even when [] is set, if the camera is turned on while pressing the playback button, the camera is activated in playback mode.

[No.Reset]

Set the file number for the next picture to be taken to 0001.

- The folder number is updated and the file number for the next picture to be taken is set to 0001.
- A folder number between 100 and 999 can be assigned.
Numbers cannot be reset once folder number reaches 999. In this case, save all necessary pictures to your computer, and format the built-in memory/card (→42).
- To reset folder number to 100:
First, format the built-in memory and card on the camera, and select [Yes] in [No. Reset]. Then select [Yes] on the folder number reset screen.

- For the setting procedures of the menu. (→25)

[Reset]

Return the [Rec] menu and [Setup] menu settings to the default settings.

■ Settings: [Reset Rec. settings?] / [Reset setup parameters?]

- Information registered in [Face Recog.] is reset if recording settings are reset.
- Resetting the setup parameters will also reset the following:
Age in years/months and names in [Baby] and [Pet] Scene Modes
- Folder numbers and clock settings will not be reset.
- Camera movement may be audible as the lens function is reset. This is not a fault.

[USB Mode]

Select communication method for when connecting camera to a computer or printer with USB connection cable.

■ Settings



[Select on connection]: Select communication method each time you connect to a computer or PictBridge-compatible printer.



[PictBridge(PTP)]: Select when connecting to a PictBridge-compatible printer.



[PC]: Select when connecting to a computer.

[Output]

Change the settings to be used when the camera is connected to a TV or other device.

■ Settings

[TV Aspect] (This setting performs when an AV cable (optional) is connected.)

16:9 / 4:3

- For the setting procedures of the menu. (→25)

[VIERA Link]

Enable automatic linking with other VIERA Link-compatible devices, and operability with a VIERA remote control when connecting via an HDMI mini cable (optional) (→185).

■ Settings

[ON]: Operations may be performed via the remote control of the VIERA Link-compatible device. (Not all operations will be available.)

Operability of the camera's own buttons will be limited.

[OFF]: Operations must be performed via the camera's own buttons.

[3D Playback]

Set how 3D still picture is output.



■ Settings: [3D] / [2D]

- If you want to play back a picture in 2D (conventional picture) on a 3D television, set to [2D].
- This item of the menu functions when an HDMI mini cable (optional) is connected.
- For the procedure for playing back a 3D still picture (→187).

[Rotate Disp.]

Automatically rotate portrait still pictures.

■ Settings

 : Rotate and display pictures displayed on a TV screen as well as those displayed on the LCD monitor of the camera in portrait orientation.

: Rotate and display only pictures displayed on a TV screen in portrait orientation.

[OFF]

- [Rotate Disp.] cannot be used with motion pictures.
- Still pictures taken with the lens surface facing up or down, or still pictures taken on other cameras may not rotate.
- Pictures cannot be rotated during Multi Playback.
- Will only be displayed rotated on computer if in Exif-compatible (→152) environment (OS, software).

- For the setting procedures of the menu. (→25)

[Scene Menu]

Set whether or not to display the selection screen for Scene Mode when the camera is switched to Scene Mode.

■ Settings

[AUTO]: Displays the selection screen.

[OFF]: Displays the currently selected Scene Mode recording screen.

[Menu Resume]

Save the last operated menu position.

■ Settings: [ON] / [OFF]

[User's Name Rec]

Record a user name on a picture while recording.

- Entering text (→44)

■ Settings: [ON] / [OFF] / [SET] (Register or change user name)

- You can check the user name recorded on a picture using the "PHOTOfunSTUDIO" software on the supplied CD-ROM.
- You cannot record a user name on the following pictures.
 - AVCHD motion pictures
 - RAW file pictures
 - Already recorded pictures

- For the setting procedures of the menu. (→25)

[Version Disp.]

Check the camera firmware version or display software information.

- When you press [MENU/SET] while the version is displayed, software information such as the license is displayed.

[Format]

Use when [Built-In Memory Error] or [Memory Card Error] appears, or when formatting the built-in memory or card.

When a card/built-in memory is formatted, the data cannot be restored. Check the content of the card/built-in memory carefully before formatting.

- When formatting the built-in memory, remove the cards.
(Only inserted card will be formatted if present; built-in memory will be formatted if no card is inserted.)
- Always format cards with this camera.
- **All protected pictures and other picture data will be deleted.**
- This requires a sufficiently charged battery, or an AC adaptor (optional) and DC coupler (optional). Do not turn off power or perform other operations during formatting.
- Formatting the built-in memory may take several minutes.
- If the card cannot be formatted, please try another card before contacting Panasonic.

For USA and Puerto Rico assistance, please call: 1-800-211-PANA(7262) or, contact us via the web at:
<http://www.panasonic.com/contactinfo>

For Canadian assistance, please call: 1-800-99-LUMIX (1-800-995-8649) or send e-mail to:
lumixconcierge@ca.panasonic.com

- For the setting procedures of the menu. (→25)

[Language]

Change display language.
Set the language displayed on the screen.

[Demo Mode]

[Stabilizer Demo.]: Extent of jitter is shown on graph (Guide)

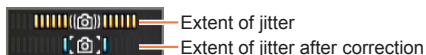

- During demo screen display, the Optical Image Stabilizer switches ON and OFF every time [MENU/SET] is pressed.
- Cannot display during playback mode.

[Auto Demo]: View introductory Slide Show

■ **Settings: [ON] / [OFF]**

- [Auto Demo] cannot be displayed on external devices such as TVs.

Entering Text

Use the cursor button to enter names with the Face Recognition function and in Scene Modes [Baby] and [Pet], or to register locations in [Travel Date] etc.

1 Use cursor button to select characters

2 Press [MENU/SET] until the desired character is displayed



Text is inserted at the cursor position.

- To change the character type
→ Select A^* , and press [MENU/SET].

Cursor position

■ Editing text

- ① Use cursor button to select ◀ ▶ and press [MENU/SET]. Then, move the cursor to the text to edit
 - You can also use the zoom lever to reposition the cursor.
- ② Use cursor button to select [Delete] and press [MENU/SET]
- ③ Use cursor button to select the correct text and press [MENU/SET]

3 When you are finished entering text, use cursor button to select [Set] and then press [MENU/SET]

- A maximum of 30 characters can be entered (max. of 9 characters for [Face Recog.] names).

Sequence of operations

Before using the camera, remove the lens cap.

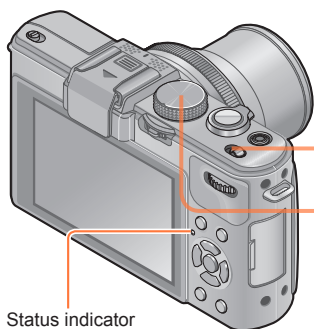
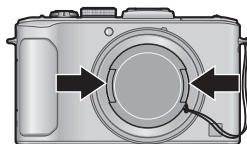

1 Turn on the power



Status indicator illuminated for approx. 1 second.

2 Rotate the mode dial to select the recording mode

Align the mode dial correctly to the mode that you want to use.



3 Use the zoom lever to adjust the range of the picture to be captured

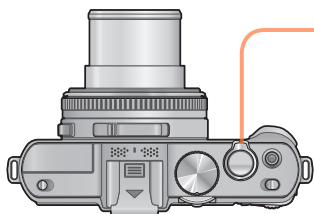

Capture a wider area (wide-angle)



Enlarge the subject (telephoto)

(Continued on the next page)

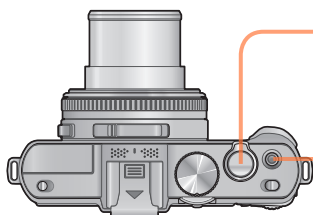

4 Take pictures

■ Taking still pictures (Shutter button)

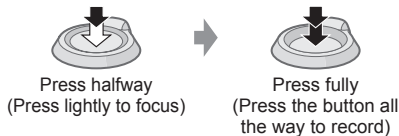

■ Recording motion pictures (Motion picture button)



Jitter alert display



- If a warning is displayed about jitter, use [Stabilizer], a tripod, or [Self Timer]. In some cases, jitter can be reduced by using a higher setting for [Sensitivity].

■ Holding the camera

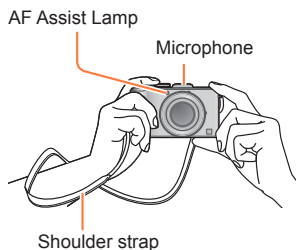

- To avoid camera shake, hold it with both hands keeping your arms close to your body while standing with your feet slightly apart.
- Do not touch the lens.
- Do not block the microphone when recording motion pictures.
- Do not block the flash or the lamp. Do not look at it from close range.
- Make sure that the camera does not move at the moment the shutter button is pressed.

- We recommend using the supplied shoulder strap to avoid dropping the camera.

■ About the direction detect function

Still pictures recorded with the camera held vertically can be automatically displayed in portrait orientation during playback. (Only when [Rotate Disp.] is set to .)

- The direction detect function may not operate correctly if pictures are taken with the camera pointing up or down.
- Motion pictures cannot be displayed in portrait orientation.

About recording modes

You can rotate the mode dial to switch recording modes.

Set to the desired recording mode

Align the mode dial correctly to the mode that you want to use. →

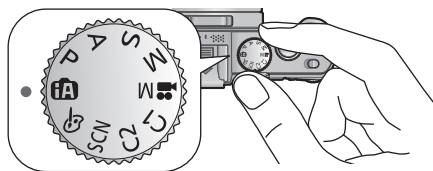

iA	[Intelligent Auto] Mode	Take pictures with automatic settings. (→49)
P	[Program AE] Mode	Take pictures with automatic shutter speed and aperture value settings. (→58)
A	[Aperture-Priority] Mode	The shutter speed is automatically determined for the aperture value you set. (→60)
S	[Shutter-Priority] Mode	The aperture value is automatically determined by the shutter speed you set. (→61)
M	[Manual Exposure] Mode	The user sets the shutter speed and aperture value manually. (→62)
M	[Creative Video Mode]	Record motion pictures with manual settings. (→87)
C1 C2	[Custom] Mode	Use this mode to access previously saved user configurations. (→90)
SCN	[Scene Mode]	Take pictures using Scene modes. (→75)
CC	[Creative Control] Mode	Take pictures using different picture effects such as [Dynamic Monochrome] or [Miniature Effect]. (→64)

Taking pictures with automatic settings

[Intelligent Auto] Mode



Optimum settings are made automatically from information such as “face”, “movement”, “brightness”, and “distance” just by pointing the camera at the subject, meaning that clear pictures can be taken without the need to make settings manually.

- About recording modes (→48)

Automatic Scene Detection

Camera reads scene when pointed at subject, and makes optimum settings automatically.

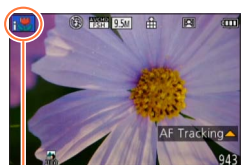

The icon of scene detected

	Recognizes people
	Recognizes babies*1
	Recognizes landscapes
	Recognizes night scenes and people in them*2
	Recognizes night scenes*2
	Recognizes night scenes without a tripod*3
	Recognizes close-ups
	Recognizes sunsets
	Reads subject movement to avoid blurring when scene does not correspond to any of the above.

*1 When babies (under 3 years) that are registered with the Face Recognition function are recognized.

*2 Only when using flash. We recommend using a tripod and the self-timer.

*3 When [iHandheld Nite Shot] is [ON].

- Depending on recording conditions, different scene types may be determined for the same subject.
- If desired scene type is not selected, we recommend manually selecting the appropriate Scene Mode.
- When , or is detected, Face Detection is activated, and the focus and exposure are adjusted for the recognized faces.

■ About Backlight Compensation ()

Backlight is a condition where a light shines from behind a subject. When there is a backlight, the subject appears darker and the camera will automatically attempt to correct it by increasing the brightness of the picture. Backlight compensation is automatically activated in [Intelligent Auto] Mode. When the camera detects backlight, is displayed on the LCD monitor (depending on the backlighting conditions, backlighting may not be detected correctly).

Defocusing the background

You can also use [Intelligent Auto] Mode to adjust background defocusing easily, as with in [Aperture-Priority] mode.

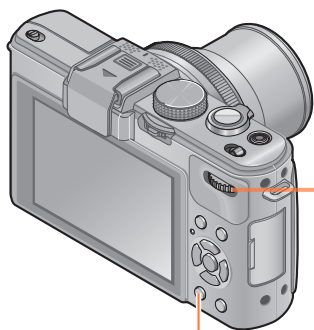

[/] button

1 Press the rear dial

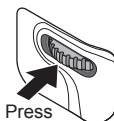

2 Rotate the rear dial to adjust the background defocusing condition



- You can also press ◀▶ to make adjustments.
- To return to automatic adjustment
→ Press [/] button

3 Press the rear dial to finalize the setting

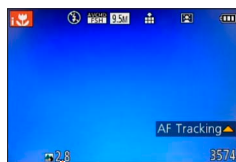
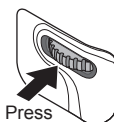

The aperture value is displayed.
([AUTO] is displayed in the icon during automatic adjustment)

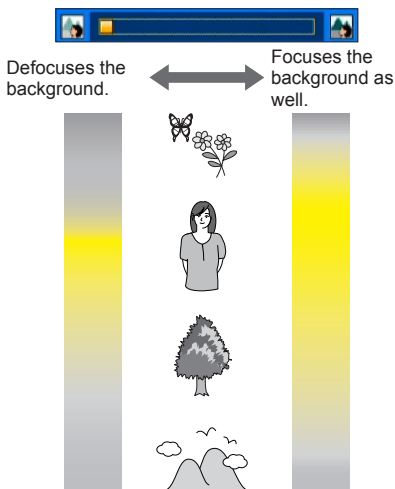

The yellow range shown in the left figure is the range for which the image is sharp.

- The range for which the image is sharp changes based on the distance to the focused subject and the zoom condition, etc.

- When you record motion pictures, the camera performs aperture control within the appropriate exposure range, and the background defocusing may not change for some subject brightness.
- You can use [Intelligent Auto Plus] Mode to adjust brightness and coloring. (→56)

About flash

Open the flash to use the built-in flash. (→106)

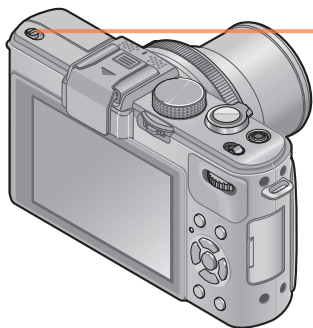

1 Open the built-in flash



■ Closing the built-in flash

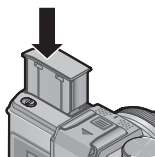

When you do not want to use the flash or after using the flash, press down to retract the flash until it clicks.

- Set to [i↖^], [i↖△], [i↖Ⓢ] or [i↖s] depending on the subject and brightness.
- When [i↖^] or [i↖Ⓢ] is selected, the red-eye reduction function is activated.
- When [i↖Ⓢ] or [i↖s] is selected, the shutter speed is reduced.

[Color Mode]

When you change the [Color Mode] setting in the [Rec] menu, you can change the color of still pictures and motion pictures to be recorded.

- For the setting procedures of the menu. (→25)

Setting	Description
[STANDARD]	Records pictures with colors close to the actual colors.
[Happy]	Records pictures with sharp and vivid colors.
[B&W]	Records pictures in black and white monotonies.
[SEPIA]	Records pictures with sepia tones to produce a nostalgic effect.

[Motion Deblur]

The camera automatically sets the optimum shutter speed in accordance with the movements of the subject to minimize the blur of the subject.

- For the setting procedures of the menu. (→25)

- When [Motion Deblur] is set to [ON], and the shutter button is pressed halfway,  appears on the screen.
- The subject may be recorded in a picture size smaller than the number of pixels that has been set.

[iHandheld Nite Shot]

If a night scene is detected automatically while the camera is handheld, the camera can record the still picture with less jitter and less noise by combining a burst of pictures.

- For the setting procedures of the menu. (→25)

- When the camera is fixed in place on a tripod or by other means, [iHandheld Nite Shot] will not be identified.

[iHDR]

When [iHDR] is set to [ON] and there is, for example, strong contrast between the background and the subject, multiple still pictures are recorded with differing exposures and combined to create a single still picture rich in gradation.

- For the setting procedures of the menu. (→25)

- This function is automatically activated only when  (→49) is displayed on the LCD monitor.
- In the case that a single picture is going to be composed from a burst, a message indicating that multiple pictures are to be recorded appears on the screen and burst recording is carried out. Note that burst recording will not take place if the camera determines that it can compensate for the difference in contrast without composing the picture from a burst.
- In the case of composition from a burst, afterimages may appear if the subject was moving.
- The camera does not combine pictures in the following cases:
 - When the zoom ratio exceeds 3.8x
 - [Burst Shooting] mode

AF Tracking

In [Intelligent Auto] Mode, you can select [AF Tracking] in [AF Mode] in a single operation. When [AF Tracking] mode is used, the camera can continuously focus on a subject and adjust the exposure of the subject even when the subject is moving.

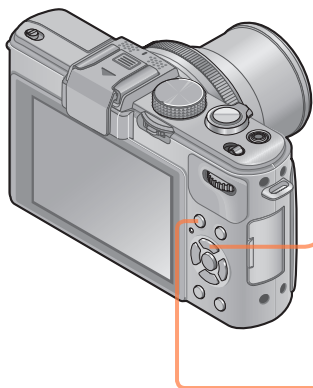
1 Press ▲ to set [AF Tracking]

• To cancel AF Tracking → Press ▲ again.

2 Align the AF Tracking frame with the subject

3 Press [AF/AE LOCK] button to lock

AF/AE LOCK



• To cancel AF Lock → Press ▲.



AF Tracking frame
 AF Lock successful:
 Yellow
 AF Lock failed:
 Red

- The optimal scene for the AF locked subject is automatically identified.
- Face Recognition will be inactive while using AF Tracking.
- Under certain recording conditions, such as when the subject is small or when it is dark, [AF Tracking] may not operate correctly.

[Intelligent Auto Plus] Mode

When [Intelligent Auto Plus] mode is selected, you can easily adjust the brightness and coloring, in addition to the background defocusing, without compromising the user-friendly operation of the [Intelligent Auto] Mode.

■ Switching to [Intelligent Auto Plus] Mode

Use the [Intelligent Auto] menu to switch the mode.

- For the setting procedures of the menu. (→25)

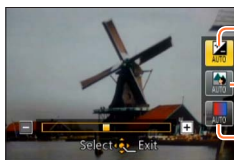

iA: [Intelligent Auto] Mode
iA+: [Intelligent Auto Plus] Mode

■ Adjusting brightness, coloring, and background defocusing**1 Press the rear dial****2 Press ▲ ▼ to select an item to adjust**

Adjusts brightness.

Adjusts background defocusing.

Adjusts coloring.

- [AUTO] is displayed in the icon during automatic adjustment.

3 Press ◀ ▶ to make adjustments

Brightness	Underexposure (dark) ◀ ▶ Overexposure (bright)
Defocus background condition	Defocus the background ◀ ▶ Focus the background
coloring	Warm colors ◀ ▶ Cool colors

- You can also rotate the rear dial to make adjustments.
- To return to automatic adjustment → Press [MENU/SET] button.

4 Press [MENU/SET]

- When you record motion pictures, the camera performs aperture control within the appropriate exposure range, and the background defocusing may not change for some subject brightness levels.

About setting items

Only the menu items which are displayed in the [Intelligent Auto] Mode can be set. The settings selected in the [Program AE] or other modes will reflect on the menu items in the [Setup] menu that are not displayed.

- Settings that can be made for the following items are different from the settings that can be made in other recording modes.
 - [Self Timer]
 - [Burst Shooting]
 - [Beep] in the [Setup] menu
- The settings for the following functions are fixed:
 - [Quality]:
 - [White Balance]: [AWB]
 - [AF Mode]:
 - [Quick AF]: [ON]
 - [Metering Mode]:
 - [i.Resolution]: [LOW]*
 - [i.Zoom]: [ON]
 - [Min. Shtr Speed]: [AUTO]
 - [Sensitivity]: ISO
 - [ISO Increments]: [1EV]
 - [AF Assist Lamp]: [ON]
 - [Flash Synchro]: [1ST]
 - [Stabilizer]: [ON]
 - [Continuous AF]: [ON]
 - [Wind Cut]: [AUTO]

* The function will turn [OFF] in the following cases.

-

Taking pictures with your own settings

[Program AE] Mode



You can take pictures with your own settings by changing the color tone, ISO Sensitivity and other settings under the [Rec] menu and other menus.

- About recording modes (→48)

- If aperture and shutter speed are shown in red, you do not have appropriate exposure. You should either use the flash, change [Sensitivity] settings or set [Min. Shtr Speed] to a slower speed.



Program Shift

The function for maintaining the same exposure (brightness) while changing the shutter speed and aperture value combination is called "Program Shift". You can use "Program Shift" to take pictures by adjusting the shutter speed and aperture value even in [Program AE] Mode.

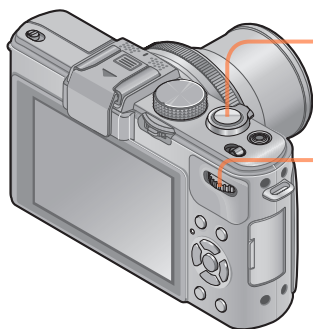

- 1 Press the shutter button halfway



- 2 Select a combination of shutter speed and aperture value



Program Shift indicator (P^{*})

Exposure meter

About the exposure meter

Shutter speed
(Automatic adjustment)

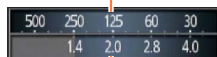

Aperture value
(Automatic adjustment)

- To cancel Program Shift
→ Rotate the rear dial until the Program Shift indicator goes off.

- When the camera is turned off, Program Shift is canceled.
- Program Shift may not function for some subject brightness levels.

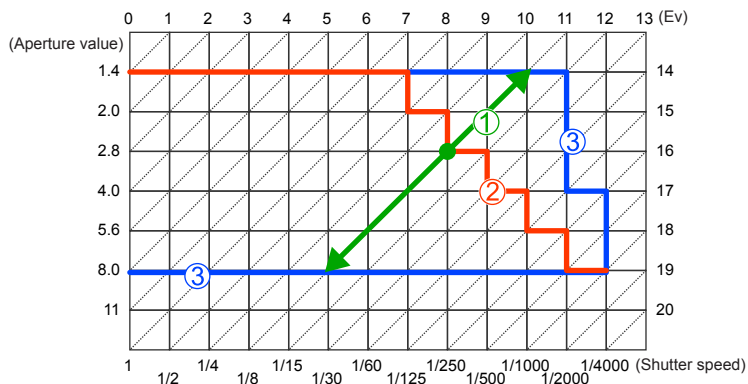
Example of Program Shift

- ① Program Shift amount
- ② Program Shift diagram
- ③ Program Shift limit

[Program Diagram]

You can change the Program diagram.

You can preset the camera to select the maximum aperture or an aperture value that achieves the best lens resolution as a combination of shutter speed and aperture value.

1 Select [Program Diagram] from the [Rec] menu

• For the setting procedures of the menu. (→25)

2 Use cursor button to select the setting and press [MENU/SET]

■ Setting: STD. ([Standard]) / MAX ([Max. Aperture]) /
MTF ([Optimum Accuracy])

- When the [MAX] or [MTF] mode is set, the built-in ND filter functions automatically. You cannot perform manual settings.
- Even if you change the [Program Diagram] setting, the shutter speed and aperture value combination can be changed using Program Shift. (→58)

Taking pictures by setting the aperture value

[Aperture-Priority] Mode



When recording, you can control the aperture value to meet your recording purposes. Shutter speed is automatically adjusted to be appropriate for the set aperture value.

- About recording modes (→48)

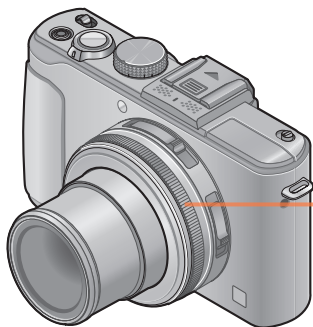

1 Rotate the aperture ring to select the aperture value

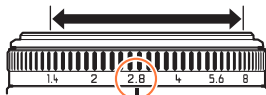

You can set the aperture values between [1.4] and [8] in 1/3-stop increments. (Set the aperture ring where it clicks.)

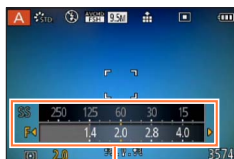

Exposure meter

About the exposure meter

Shutter speed
(Automatic adjustment)

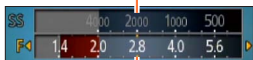

Set aperture value

- Proper exposure is not possible in the range indicated in red.

- When the aperture value is increased, the range of depth in focus expands, and the picture shows up clearly from the position of the camera to the background.
- When the aperture value is reduced, the range of depth in focus shrinks, and the background can get blurry.

- The aperture ring rotates only within the range of the printed indicators.
- Since the maximum aperture value changes in accordance with the zoom setting, the printed indication on the aperture ring and the actual aperture value may be different. Refer to the exposure meter for the aperture value when you take a picture.
- When the picture is too bright or too dark or there is incorrect exposure, the numbers for the aperture value and shutter speed are shown in red.
- LCD monitor brightness may vary from the actual still picture recorded.

Taking pictures by setting the shutter speed

[Shutter-Priority] Mode



When recording, you can control the shutter speed to meet your recording purposes. Aperture is automatically adjusted to be appropriate for the set shutter speed.

- About recording modes (→48)



1 Rotate the rear dial to select shutter speed

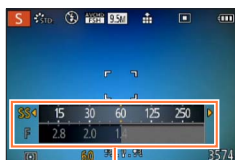

Exposure meter

- At faster shutter speeds, movements by the subject show as if they are still.
- At slower shutter speeds, subjects that are moving show as jittery.

About the exposure meter

Set shutter speed



Aperture value
(Automatic adjustment)

- Proper exposure is not possible in the range indicated in red.

- When the picture is too bright or too dark or there is incorrect exposure, the numbers for the aperture value and shutter speed are shown in red.
- LCD monitor brightness may vary from the actual still picture recorded.

Taking pictures by setting the aperture value and shutter speed

[Manual Exposure] Mode



You can use this recording mode to set the desired shutter speed and aperture value when you want to take pictures using the same exposure (same combination of shutter speed and aperture value) or when you cannot obtain pictures at the desired brightness even after compensating the exposure.

- About recording modes (→48)

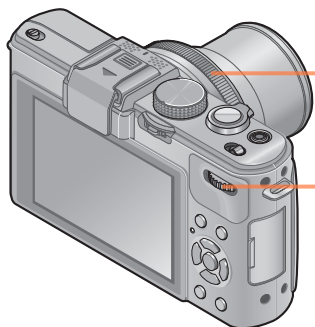

1 Select the shutter speed and aperture value

■ Setting the aperture value

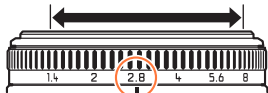

You can set the aperture values between [1.4] and [8] in 1/3-stop increments. (Set the aperture ring where it clicks.)

■ Setting the shutter speed



About the exposure meter

Set shutter speed

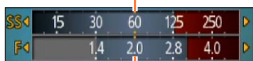

Set aperture value

- Proper exposure is not possible in the range indicated in red.





Exposure meter

Manual exposure assist

Taking pictures by setting the aperture value and shutter speed [Manual Exposure] Mode

■ Manual exposure assist (estimate)

	Shows pictures with standard brightness.
	Shows brighter pictures. For standard brightness, either use a faster shutter speed or increase aperture value.
	Shows darker pictures. For standard brightness, either use a slower shutter speed or reduce aperture value.

- The aperture ring rotates only within the range of the printed indicators.
- When the picture is too bright or too dark or there is incorrect exposure, the numbers for the aperture value and shutter speed are shown in red.
- LCD monitor brightness may vary from the actual still picture recorded.
- The shutter speed setting range changes depending on the [Sensitivity] setting.

[Sensitivity]	Shutter speed
80 - 1600	250 - 1/4000th
2000 - 3200	30 - 1/4000th
4000 - 12800	8 - 1/4000th

Taking pictures by changing the picture effect

[Creative Control] Mode



You can select your own settings from various effects and take pictures while confirming these effects on the LCD monitor.

- About recording modes (→48)

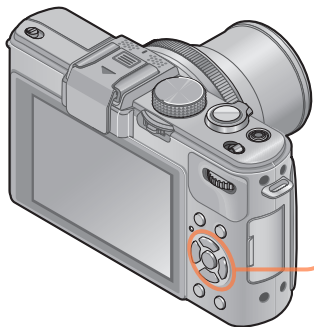

1 Press ▲▼ to select the effect and press [MENU/SET]

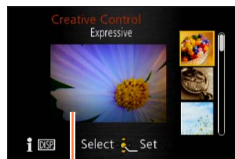
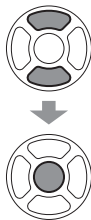

Preview screen

- When you press [DISP.] button, a description of the selected effect is displayed.
- When you select [Creative Control] by rotating the mode dial, the menu appears automatically.
- You can display the [Creative Control] menu by pressing [MENU/SET]. For the setting procedures of the menu. (→25)

- The display of a picture reflecting a selected effect in the preview screen or recording screen may differ from the actual recorded pictures.
- A setting that was selected in [Creative Control] Mode is retained even after the camera is turned off.
- The following recording menu and settings are automatically adjusted, and cannot be set manually.
[Sensitivity] [White Balance] [i.Dynamic] [Min. Shtr Speed] [Photo Style]

■ Adjusting the brightness, background defocusing condition, setting conditions of a selected effect, etc.

1 Press the rear dial

2 Press ▲▼ to select an item to adjust



Adjusts the brightness.

Adjusts background defocusing.

Adjusts the setting conditions of the selected effect, etc. (The settings to be adjusted vary depending on the selected effect.)

- [AUTO] is displayed in the icon during automatic adjustment.
- The items that can be adjusted differ depending on the selected effect.

3 Press ◀▶ to make adjustments

- You can also rotate the rear dial to make adjustments.
- To return to automatic adjustment → Press [⏏/↶] button.

4 Press [MENU/SET]

- When you record motion pictures, the camera performs aperture control within the appropriate exposure range, and the background defocusing may not change for some subject brightness levels.

For the [Creative Control] menu setting procedures. (→64)

[Expressive]

This picture effect creates a pop art style picture that enhances the color.

■ Items that can be set

Brightness	Underexposure (darker)	↔	Overexposure (brighter)
Degree of background defocusing	Defocuses the background	↔	The background is in focus as well
Vividness	Subdued coloring	↔	Gaudy coloring



[Retro]

This picture effect creates the soft appearance of a tarnished picture.

■ Items that can be set

Brightness	Underexposure (darker)	↔	Overexposure (brighter)
Degree of background defocusing	Defocuses the background	↔	The background is in focus as well
Coloring	Yellowish coloring	↔	Reddish coloring

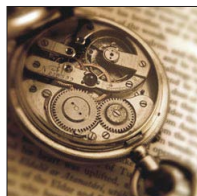

For the [Creative Control] menu setting procedures. (→64)

[High Key]

This picture effect creates a brighter and lighter toned appearance for the entire picture.

■ Items that can be set

Brightness	Underexposure (darker)	↔	Overexposure (brighter)
Degree of background defocusing	Defocuses the background	↔	The background is in focus as well
Coloring	Pinkish coloring	↔	Light-bluish coloring



[Low Key]

This picture effect creates a darker somber appearance for the entire picture to emphasize the bright portions.

■ Items that can be set

Brightness	Underexposure (darker)	↔	Overexposure (brighter)
Degree of background defocusing	Defocuses the background	↔	The background is in focus as well
Coloring	Reddish coloring	↔	Bluish coloring

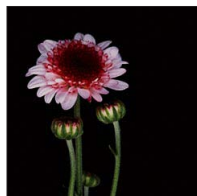

For the [Creative Control] menu setting procedures. (→64)

[Sepia]

This picture effect creates a picture with sepia tone.

■ Items that can be set

Brightness	Underexposure (darker)	↔	Overexposure (brighter)
Degree of background defocusing	Defocuses the background	↔	The background is in focus as well
Contrast	Low contrast	↔	High contrast



[Dynamic Monochrome]

This picture effect creates a monochromatic picture with a higher contrast and more dramatic atmosphere.

■ Items that can be set

Brightness	Underexposure (darker)	↔	Overexposure (brighter)
Degree of background defocusing	Defocuses the background	↔	The background is in focus as well
Contrast	Low contrast	↔	High contrast



For the [Creative Control] menu setting procedures. (→64)

[Impressive Art]

This picture effect creates a picture with a higher contrast and surreal appearance.

■ Items that can be set

Brightness	Underexposure (darker)	↔	Overexposure (brighter)
Degree of background defocusing	Defocuses the background	↔	The background is in focus as well
Coloring	Black & white	↔	Gaudy coloring



[High Dynamic]

This picture effect creates a picture with a well-balanced brightness for the entire picture (from dark areas to bright areas).

■ Items that can be set

Brightness	Underexposure (darker)	↔	Overexposure (brighter)
Degree of background defocusing	Defocuses the background	↔	The background is in focus as well
Coloring	Black & white	↔	Gaudy coloring



For the [Creative Control] menu setting procedures. (→64)

[Cross Process]

This picture effect allows you to play with color effects.

■ Items that can be set

Brightness	Underexposure (darker)	↔	Overexposure (brighter)
Degree of background defocusing	Defocuses the background	↔	The background is in focus as well
Coloring	Greenish coloring / Bluish coloring / Yellowish coloring / Reddish coloring		



[Toy Effect]

This picture effect creates a picture that resembles pictures taken by a toy camera with a reduced amount of peripheral light.

■ Items that can be set

Brightness	Underexposure (darker)	↔	Overexposure (brighter)
Degree of background defocusing	Defocuses the background	↔	The background is in focus as well
Coloring	Orangish color	↔	Bluish coloring



For the [Creative Control] menu setting procedures. (→64)

[Miniature Effect]

This picture effect creates a diorama-like picture by intentionally defocusing all but one section of the picture.

■ Items that can be set

Brightness	Underexposure (darker)	↔	Overexposure (brighter)
Vividness	Subdued coloring	↔	Gaudy coloring



■ Defocusing a picture

- ① Press ◀
- ② Press ▲ ▼ or ◀▶ to move the focusing area (frame)
- ③ Rotate the rear dial to select the size of the focusing area (frame)
- ④ Press [MENU/SET]
 - When you press [DISP.] button, the initial setting condition is restored.

- The recording screen is displayed like a frame dropping with a slight delay compared to normal recording.
- No audio is recorded for motion pictures.
- When a motion picture is recorded, the finished recording will be approximately 1/10th of the actual recorded time period. (If you record a motion picture for 10 minutes, the resulting motion picture recording time will be approximately 1 minute.) The recordable time displayed on the camera is approx. 10x longer than actual time needed for recording. When the recording mode is changed, be sure to check the recordable time.
- If you stop recording motion pictures too soon, the camera may continue recording until a certain time. Hold the camera until the camera stops recording.
- When you take a picture using a large picture size setting, the screen will become dark for a certain period of time after the picture is taken. However, this occurs due to signal processing and is not a defect.

For the [Creative Control] menu setting procedures. (→64)

[Soft Focus]

This picture effect creates a soft appearance by intentionally blurring the entire picture.

■ Items that can be set

Brightness	Underexposure (darker)	↔	Overexposure (brighter)
Degree of background defocusing	Defocuses the background	↔	The background is in focus as well
Degree of defocusing	Slight defocusing	↔	Strong defocusing



- The recording screen is displayed like a frame dropping with a slight delay compared to normal recording. (When this effect is set, the recorded motion picture is played back like a frame dropping.)
- When you take a picture using a large picture size setting, the screen will become dark for a certain period of time after the picture is taken. However, this occurs due to signal processing and is not a defect.
- Motion pictures cannot be recorded.

[Star Filter]

This picture effect creates a picture with point lights shining in the shape of a cross.

■ Items that can be set

Brightness	Underexposure (darker)	↔	Overexposure (brighter)
Degree of background defocusing	Defocuses the background	↔	The background is in focus as well
Length of the rays of light	Rays of light is short	↔	Rays of light is long



- Motion pictures cannot be recorded.

For the [Creative Control] menu setting procedures. (→64)

[One Point Color]

This picture effect creates a monochromatic picture by retaining the color you select only.

■ Items that can be set

Brightness	Underexposure (darker)	↔	Overexposure (brighter)
Degree of background defocusing	Defocuses the background	↔	The background is in focus as well
Amount of color retained	Leaves a small amount of color	↔	Leaves a large amount of color



■ Selecting the color to be retained

- ① Press ◀
- ② Select the color to be retained using the frame in the center of the screen and press [MENU/SET]

- The selected color may not be retained for some subjects.

[Smooth Defocus]

This picture effect creates a smooth defocused area that emphasizes the subject by operating the aperture when the shutter is opened (during exposure).

■ Items that can be set

Brightness	Underexposure (darker)	↔	Overexposure (brighter)
Vividness	Subdued coloring	↔	Gaudy coloring



- The result of this effect may be hard to see for some subjects.
- Motion pictures cannot be recorded.
- Use a tripod or other device since this effect slows the shutter speed.

For the [Creative Control] menu setting procedures. (→64)

[Radial Defocus]

This picture effect defocuses the entire picture by retaining a sharper focus on the main subjects than with [Soft Focus] by operating focus when the shutter is open (exposure time) during recording.

■ Items that can be set

Brightness	Underexposure (darker)	↔	Overexposure (brighter)
Degree of defocusing	Slight defocusing	↔	Strong defocusing



- Motion pictures cannot be recorded.
- Use a tripod or other device since this effect slows the shutter speed.

Taking pictures according to the scene

[Scene Mode]



Using [Scene Mode] enables you to take pictures with optimum settings (exposure, coloring, etc.) for given scenes.

- About recording modes (→48)

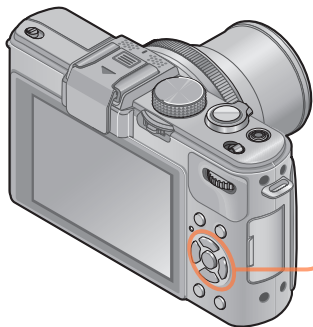





1 Use cursor button to select the scene and press [MENU/SET]



- When you select [SCN] by rotating the mode dial, the menu appears automatically. (When [Scene Menu] in the [Setup] menu is [AUTO])
- You can display the [Scene Mode] menu by pressing [MENU/SET]. For the setting procedures of the menu. (→25)

- Selecting a Scene Mode inappropriate for the actual scene may affect the coloring of your picture.
- The following recording menu and settings are automatically adjusted, and cannot be set manually.
[Sensitivity] [Metering Mode] [i.Dynamic] [Min. Shtr Speed] [i.Resolution] [Photo Style]

- How to select a scene (→75)

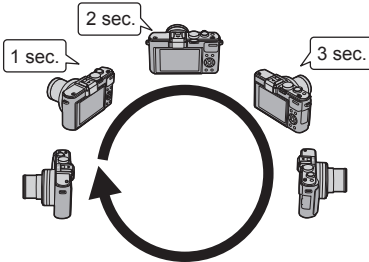
 [Portrait]	<p>Improves the skin tone of subjects for a healthier appearance in bright daylight conditions.</p> <p>Tips</p> <ul style="list-style-type: none"> • The more the zoom is drawn towards T side and the closer the camera is brought to the subject, the greater the effect will be.
 [Soft Skin]	<p>Smooths skin colors in bright, outdoor daylight conditions (portraits from chest upwards).</p> <p>Tips</p> <ul style="list-style-type: none"> • The more the zoom is drawn towards T side and the closer the camera is brought to the subject, the greater the effect will be.
 [Scenery]	<p>Takes clear pictures of wide, distant subjects.</p>
 [Panorama Shot]	<p>Creates a single panorama picture by stitching multiple still pictures taken in rapid succession.</p> <ol style="list-style-type: none"> ① Use cursor button to select the recording direction, and press [MENU/SET] to set. ② Check the recording direction and press [MENU/SET] <ul style="list-style-type: none"> • Special panorama guidelines will be displayed during recording. ③ Press the shutter button halfway to focus ④ Press the shutter button fully and pan the camera in a small circular motion in the selected direction to start recording <ul style="list-style-type: none"> • Taking pictures from left to right <div style="display: flex; align-items: center; justify-content: center;">  <div style="margin-left: 20px;">  </div> </div> <p>Recording direction and progress status (approximate)</p> <ul style="list-style-type: none"> • Pan the camera so that you make a complete circuit in approx. 8 seconds <ul style="list-style-type: none"> - Pan the camera at a constant speed. - You may not be able to take pictures successfully if you move the camera too quickly or too slowly. ⑤ Press the shutter button fully again to end recording <ul style="list-style-type: none"> • You can also end recording if you stop panning the camera while taking pictures.

- How to select a scene (→75)



[Panorama Shot]

(Continued)

Tips

- Pan the camera in the recording direction as steadily as possible.







If the camera shakes too much, it may not be able to take pictures or may end up creating a narrow (small) panorama picture.

Pan the camera to a point slightly ahead of the point that you want to take. (However, the last frame is not recorded to the end.)





Notes

- The zoom position is fixed to the W end.
- Motion pictures cannot be recorded.
- The focus, White Balance, and Exposure Compensation are all fixed to optimal values for the first picture. If the focusing or brightness of pictures recorded as part of a panorama picture after the first picture are significantly different from those of the first picture, the panorama picture as a whole (when all pictures are stitched together) may not have consistent focus and brightness.
- The following functions are fixed to the settings indicated below.
[Stabilizer]: [OFF] [Date Stamp]: [OFF]
- Since several pictures are stitched together to create a panorama picture, some subjects may be distorted or the joining portions of successively taken pictures that are stitched may be noticeable.
- The number of recording pixels per horizontal line and vertical line of a panorama picture varies depending on the recording direction and number of stitched pictures.
The maximum number of recording pixels is as follows:
 - Taking pictures in landscape orientation: Approx. 8000 x 1080
 - Taking pictures in portrait orientation: Approx. 1440 x 8000
- Panorama pictures may not be created or pictures may not be recorded properly when taking pictures of the following subjects or when taking pictures in the following recording conditions:
 - Subjects that have a continuous monotone or pattern (sky, beach, etc.)
 - Moving subjects (person, pet, vehicle, waves, or flowers swaying in the wind, etc.)
 - Subjects whose colors or patterns change quickly (such as an image appearing on a display)
 - Dark locations
 - Locations with a flickering light source (fluorescent lamp, candle light, etc.)



- How to select a scene (→75)

 [Sports]	<p>Takes pictures of scenes with fast movement, e.g. sports.</p> <p>Tips</p> <ul style="list-style-type: none"> • Stand at least 5 m (16 feet) away. <p>Notes</p> <ul style="list-style-type: none"> • Sports mode requires adequate lighting, to enable the higher shutter speed to be used. This mode may not produce acceptable results when shooting indoors, under limited lighting. • Shutter speed may slow down up to 1 second.
 [Night Portrait]	<p>Takes pictures of people and nightscapes with close to actual brightness.</p> <p>Tips</p> <ul style="list-style-type: none"> • Use flash. • Subject should not move. • Tripod, self-timer recommended. <p>Notes</p> <ul style="list-style-type: none"> • Shutter speed may slow down up to 8 seconds. • After recording, the shutter may stay closed (up to 8 seconds) to process the signal. This is not a malfunction.
 [Night Scenery]	<p>Takes clear pictures of night scenes.</p> <p>Tips</p> <ul style="list-style-type: none"> • Tripod, self-timer recommended. <p>Notes</p> <ul style="list-style-type: none"> • Shutter speed may slow down up to 8 seconds. • After recording, the shutter may stay closed (up to 8 seconds) to process the signal. This is not a malfunction.
 [Handheld Night Shot]	<p>Takes clear still pictures of night scenes with less jitter and less noise by combining a burst of still pictures.</p> <p>Tips</p> <ul style="list-style-type: none"> • After the shutter button has been pressed, do not move the camera during the burst operation. <p>Notes</p> <ul style="list-style-type: none"> • Since a burst of still pictures are combined after they have been recorded, it will be a few moments before you will be able to record another picture.

- How to select a scene (→75)

 [HDR]	<p>The camera can combine several still pictures taken with different exposures into a single properly exposed picture with rich gradation.</p> <p>Tips</p> <ul style="list-style-type: none"> • After the shutter button has been pressed, do not move the camera during the burst operation. <p>Notes</p> <ul style="list-style-type: none"> • Since a burst of still pictures are combined after they have been recorded, it will be a few moments before you will be able to record another picture. • A subject that was in motion when it was recorded may be recorded as an afterimage. • The camera may take a single still picture instead of several pictures under certain recording conditions.
 [Food]	<p>Takes natural-looking pictures of food.</p>
  [Baby]	<p>This takes pictures of a baby with a healthy complexion. When you use the flash, the light from it is weaker than usual.</p> <p>■ To record age and name [Baby1] and [Baby2] can be set separately.</p> <ol style="list-style-type: none"> ① Use cursor button to select [Age] or [Name] and press ► ② Select [SET] with cursor button, and press [MENU/SET] ③ Set the birthday and name Age: Set birthday with cursor button, and press [MENU/SET] Name: (Entering text (→44)) ④ Press [MENU/SET] <p>Tips</p> <ul style="list-style-type: none"> • Make sure [Age] and [Name] are [ON] before taking a picture. <p>Notes</p> <ul style="list-style-type: none"> • Age display format depends on [Language] setting. • Shutter speed may slow down up to 1 second. • [Age] and [Name] print setting can be made on your computer using "PHOTOfunSTUDIO" software on the supplied CD-ROM. Text may also be stamped onto the still picture using [Text Stamp].
 [Pet]	<p>Records pet's age and name when taking pictures.</p> <ul style="list-style-type: none"> • Refer to [Baby] for other tips and notes.

- How to select a scene (→75)

 [Sunset]	Takes clear pictures of scenes such as sunsets.
 [Glass Through]	Most suitable for taking pictures such as a landscapes through the transparent glass of a train/vehicle or building. Notes <ul style="list-style-type: none"> • If there are stains such as dust or a reflection on the glass, the camera may focus on the glass instead of a subject. • The color of pictures may appear unnatural due to the color of the glass. (You may be able to reproduce the appropriate color by adjusting the White Balance.)

- How to select a scene (→75)

Pictures are recorded continuously while moving the camera horizontally, and two pictures selected automatically are combined to make a single 3D picture.

To view 3D pictures, a television that supports 3D is required (This unit will play back in 2D).

■ Recording procedure

Press the shutter button fully to start recording, and then move the camera horizontally from left to right in a straight line.

- A guide is displayed while recording.
- Move the camera approximately 10 cm (0.33 feet) within approximately 4 seconds using the guide.

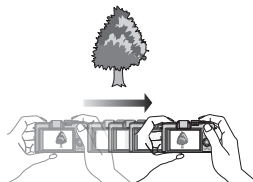

Tips for recording pictures

- Record a stationary subject.
- Record a picture outdoors or in other bright locations.
- Press the shutter button halfway to fix the focus and the exposure, press the shutter button fully, and then pan the camera.
- Hold the camera so that the subject is slightly to the right of the center on the display at the start of the recording. This makes it easier to position the subject in the center of the recorded picture.

3D

[3D Photo Mode]

Notes

- **3D still pictures cannot be recorded by holding this camera vertically.**
- 3D still pictures are recorded in MPO format (3D).
- The zoom position is fixed to the W end.
- The picture size is fixed to 2M [16:9].
- ISO Sensitivity is automatically adjusted. However, ISO Sensitivity is increased to make the shutter speed faster.
- Motion pictures cannot be recorded.
- It may be impossible to record pictures under any of the conditions below. Even if pictures are recorded, they may not have a 3D effect or may appear distorted.
 - When the subject is too dark or too bright
 - When the subject's brightness changes
 - When the subject is moving
 - When the subject lacks contrast

Recording motion pictures



You can record motion pictures with audio (stereo).

Do not block the microphone when recording motion pictures.

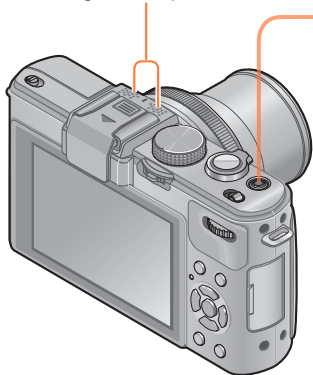

1 Press the motion picture button to start recording

[Rec Mode] (→150)/[Rec Quality] (→150)



Elapsed recording time

Remaining recording time (approx.)

- Immediately release the motion picture button after pressing it.

2 Press the motion picture button again to end recording

■ About zoom operation

You can also use zoom while recording motion pictures.

- The zoom speed will be slower than normal.
- When using zoom while recording motion pictures, it may take some time to focus.

- You can record motion pictures to the built-in memory only in [VGA] mode. (→150)
- Use a sufficiently charged battery.
- The available recording time displayed on the screen may not decrease regularly.
- [Sensitivity] is set automatically while a motion picture is being recorded. Also [ISO Limit Set] is disabled.
- The following functions are not available:
Extended optical zoom, flash, [Face Recog.], [Rotate Disp.] for pictures taken vertically.
- For certain memory cards, recording may end while in progress.
- The recording range may become narrower in motion pictures compared to still pictures. Also, if the aspect ratio is different for still pictures and motion pictures, the angle of view will change when starting to record a motion picture. The recordable area is displayed by setting [Video Rec Area] (→34) to [ON].
- If Extended optical zoom is used before pressing the motion picture button, these settings will be cleared, and the recordable area will be changed significantly.

■ About the recording format for recording motion pictures

This unit can record motion pictures in either AVCHD or MP4 formats.

AVCHD:

You can record high definition quality images with this format. It is suitable for viewing motion pictures on a high-resolution TV or for saving them to a disc.

AVCHD Progressive:

The [PSH] in [AVCHD] is a mode that allows motion pictures to be recorded at 1920 x 1080/60p, the highest quality* that complies with the AVCHD standard. Recorded motion pictures can be saved and played back using this unit or "PHOTOfunSTUDIO".

* This means the highest quality for this unit.

MP4:

This is a simpler video format best used when extensive editing is needed, or when uploading videos to the Internet.

■ About the compatibility of the recorded motion pictures





















Motion pictures recorded in [AVCHD] or [MP4] may be played back with poor picture or sound quality or playback may not be possible even when played back with equipment compatible with these formats. Also, the recording information may not be displayed properly. In this case, use this unit.

- Motion pictures recorded with [PSH] in [AVCHD] can be played back on equipment that is compatible with AVCHD Progressive.
- For details on AVCHD Progressive and MP4 compatible devices, refer to the support site below.

<http://panasonic.jp/support/global/cs/dsc/>

(This site is available in English only.)

■ About recording modes

	<p>The camera automatically detects the scene to record motion pictures with optimal settings.</p> <table border="1" data-bbox="184 297 847 361"> <tr> <td data-bbox="184 297 684 331">  <p>When scene does not correspond to any on the right.</p> </td> <td data-bbox="684 297 785 331">  </td> <td data-bbox="785 297 847 331">  </td> </tr> <tr> <td data-bbox="184 331 684 361"></td> <td data-bbox="684 331 785 361">  </td> <td data-bbox="785 331 847 361">  </td> </tr> </table> <ul style="list-style-type: none"> • In  mode, focus and exposure will be set according to the face detected. •  will be selected for nightscapes and other dark scenes. • If the camera does not select your desired Scene Mode, choosing an appropriate mode manually is recommended. 	 <p>When scene does not correspond to any on the right.</p>							
 <p>When scene does not correspond to any on the right.</p>									
									
<p>P A S M</p>	<p>Records a motion picture at your preferred settings.</p> <ul style="list-style-type: none"> • Aperture and shutter speed are automatically set. 								
	<p>Records a motion picture with manual operations. For details (→87).</p>								
<p>C1 C2</p>	<p>See the description about the registered recording mode.</p>								
<p>SCN</p>	<p>Records a motion picture at the optimum settings for the selected scene.</p> <ul style="list-style-type: none"> • Some scenes are switched to the following scenes: <table border="1" data-bbox="184 908 959 1030"> <thead> <tr> <th data-bbox="184 908 692 937">Selected scene</th> <th data-bbox="692 908 959 937">Scenes for motion picture</th> </tr> </thead> <tbody> <tr> <td data-bbox="184 937 692 972">[Baby]</td> <td data-bbox="692 937 959 972">Portrait motion picture</td> </tr> <tr> <td data-bbox="184 972 692 1001">[Night Portrait], [Night Scenery], [Handheld Night Shot]</td> <td data-bbox="692 972 959 1001">Low light motion picture</td> </tr> <tr> <td data-bbox="184 1001 692 1030">[Sports], [HDR], [Pet]</td> <td data-bbox="692 1001 959 1030">Normal motion picture</td> </tr> </tbody> </table> <ul style="list-style-type: none"> • A motion picture cannot be recorded in [Panorama Shot] or [3D Photo Mode] Scene Mode. 	Selected scene	Scenes for motion picture	[Baby]	Portrait motion picture	[Night Portrait], [Night Scenery], [Handheld Night Shot]	Low light motion picture	[Sports], [HDR], [Pet]	Normal motion picture
Selected scene	Scenes for motion picture								
[Baby]	Portrait motion picture								
[Night Portrait], [Night Scenery], [Handheld Night Shot]	Low light motion picture								
[Sports], [HDR], [Pet]	Normal motion picture								
	<p>Records a motion picture at the optimum settings for the selected effects.</p> <ul style="list-style-type: none"> • A motion picture cannot be recorded using [Star Filter], [Soft Focus], [Smooth Defocus] and [Radial Defocus] in [Creative Control] Mode. 								

- The aperture value cannot be changed even when the aperture ring is rotated. (Except [Creative Video Mode])
- Built-in ND filter cannot be manually set even when the [ND/FOCUS] lever is pressed.

Taking still pictures while a motion picture is being recorded

Still pictures can be recorded even while a motion picture is being recorded.

1 Press the shutter button fully during the motion picture recording

Still pictures are recorded with aspect ratio setting of [16:9] and [Picture Size] setting of 3.5 M. (Max. 20 pictures)

Motion picture recording continues unchanged.

- The clicking sound made when the shutter button is operated may be recorded.
- When still pictures are recorded during zooming, the zooming may stop.
- Using [Miniature Effect] in [Creative Control] Mode, a still picture may be taken with a slight delay from the time when the shutter button is pressed fully.

■ Burst function

When the burst function has been set in advance, a burst of still pictures can be recorded during motion picture recording.

- When the burst setting is set to [40], [60] or [80], still pictures are automatically recorded using the [10] setting.
 - Even at the [∞] or [∞] setting, the focus is fixed at the first picture.
- The camera will refocus if the shutter button is pressed halfway during motion picture recording. This refocus movement is recorded even during motion picture recording. When priority is to be given to the motion picture videos, press the shutter button fully, and record the still pictures. Still pictures can also be created after motion picture recording. (→160)
 - When the shutter button is pressed halfway, the picture size and the number of recordable pictures are displayed.
 - Still pictures cannot be recorded when [Rec Quality] is set to [VGA].
 - The flash is set to [☒] (Forced flash off).
 - Since the electronic shutter is used for recording, the pictures recorded may be distorted.

Recording motion pictures with manual operation

[Creative Video Mode]



You can set the desired shutter speed and aperture value to record motion pictures.

- About recording modes (→48)

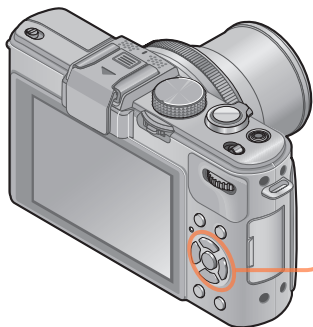

1 Press ▲▼ to select the setting and press [MENU/SET]



- When you select [M] by rotating the mode dial, the menu appears automatically.
- You can display the [Creative Video] menu by pressing [MENU/SET]. For the setting procedures of the menu. (→25)

Setting	Description
P [Program AE]	Automatically sets the shutter speed and aperture value.
A [Aperture-Priority]	Records motion pictures at a set aperture value. (The shutter speed is automatically adjusted.)
S [Shutter-Priority]	Records motion pictures at a set shutter speed. (The aperture value is automatically adjusted.)
M [Manual Exposure]	Records motion pictures at a set shutter speed and a set aperture value.
HS [High Speed Video]	For details (→89).

Recording motion pictures with manual operation [Creative Video Mode]

- About aperture value
To record motion pictures with a sharp focus on both subject and background, set the aperture value to a higher number. To record motion pictures with a defocused background, set a lower number.
- About the shutter speed
To record a sharp motion picture of a fast-moving subject, set a faster shutter speed. To record a motion picture with a trailing effect for a subject's movements, set a slower shutter speed.

- Press the shutter button to start and stop recording motion pictures.
- Still pictures cannot be recorded while motion pictures are being recorded.
- The shutter speed that can be set using [Creative Video Mode] is different from the values that can be set using [Program AE], [Aperture-Priority], [Shutter-Priority], and [Manual Exposure] Modes.
- Although you can change camera settings such as shutter speed and aperture value even when a motion picture recording is in progress, the beeps and camera operation sounds may be recorded in some cases.
- When you set a faster shutter speed, the screen noise may increase due to the higher sensitivity.
- When you take a picture under a fluorescent lamp, LED, mercury arc lamp or sodium lamp, for example, the coloring and the brightness of the screen may change.

[High Speed Video]

You can record at high speed moving subjects during sporting events or other active scenes to record movements that cannot be seen with the naked eye.

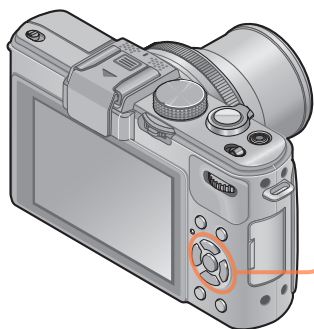

- 1** Press ▲▼ to select [HS] and press [MENU/SET]

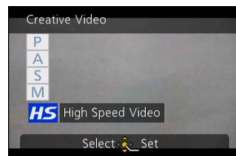

- When you select [M] by rotating the mode dial, the menu appears automatically.
- You can display the [Creative Video] menu by pressing [MENU/SET]. For the setting procedures of the menu. (→25)

■ Picture quality of high-speed motion pictures

1280×720 pixels (Aspect ratio of 16:9)

120 pictures/sec.

Recording format: MP4 (without audio)

- You can record a motion picture of up to 4 GB per recording session.
- When converted into playback time, motion pictures can be recorded for up to 29 minutes and 59 seconds.
- The shutter speed and aperture value are automatically adjusted.
- Press the shutter button to start and stop recording motion pictures.
- Still pictures cannot be recorded while motion pictures are being recorded.
- The settings for the focus, zoom, exposure and White Balance are fixed to the settings specified when recording was started.
- The Optical Image Stabilizer does not work.
- The [AF Mode] is set to  (1-area-focusing).
- Flickering or horizontal stripes may appear while recording under fluorescent lighting.

Registering your own settings and recording

[Custom] Mode

Registering your preferred recording mode, [Rec] menu settings, etc. to [Cust.Set Mem.] and setting the mode dial to C1/ C2 allows you to switch quickly to those settings.

[Cust.Set Mem.]

Up to 4 current camera settings can be registered.



1 Select the recording mode you wish to register and set the [Rec] menu, [Motion Picture] menu, [Setup] menu, etc.

2 Select [Cust.Set Mem.] from the [Setup] menu

- For the setting procedures of the menu. (→25)

3 Use cursor button to select custom set for registration and press [MENU/SET]

- A confirmation screen is displayed. Select [Yes] with cursor button, and press [MENU/SET].
- The custom settings registered in [C1] can be used with the C1 of the mode dial. It will be convenient if the custom setting used often is registered, since it can be used by just setting the mode dial.
- The custom settings registered in [Custom Set 2-1], [Custom Set 2-2] or [Custom Set 2-3] can be selected in the C2 of the mode dial. Up to 3 custom settings can be registered, so select the one matching the needs.

- Since certain menu items would be reflected in other recording modes, they are not saved.

[Custom]

Settings registered in [Cust.Set Mem.] can be quickly called up by setting the mode dial to C1/ C2.



1 Set mode dial to C1 / C2 ([Custom] mode)

- When set to C1
 - The camera switches to the recording mode and settings registered in C1.
- When set to C2
 - Use cursor button to select custom set and press [MENU/SET] to switch to the recording mode and settings registered in C2.

■ When changing the menu settings

Even if the menu settings are changed temporarily when [C1], [Custom Set 2-1], [Custom Set 2-2] or [Custom Set 2-3] is selected for using the custom set, the currently registered settings will remain unchanged.

To change the currently registered settings, overwrite the registered data using [Cust. Set Mem.] (→90) on the [Setup] menu.

Using Zoom

You can adjust the area of a picture to be taken using zoom.

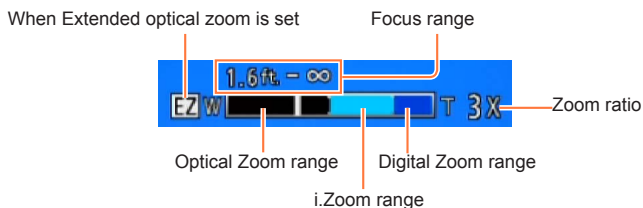
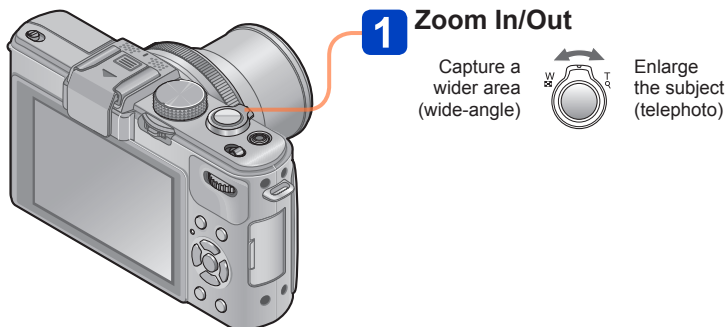

- Adjust the focus after adjusting the zoom.
- Do not touch the lens barrel during zooming.
- The zoom ratio and the zoom bar displayed on the screen are estimates.
- The camera may make a rattling noise and vibrate when the zoom lever is operated - this is not a malfunction.





Optical Zoom

Zooming in up to 3.8x is possible if pictures without  have been selected by [Picture Size] on the [Rec] menu. (→135)

- Optical Zoom cannot be used in the following cases:
 - Scene Modes ([Panorama Shot] [3D Photo Mode])

Extended optical zoom

Zooming in up to 6.7x is possible when pictures with  have been selected by [Picture Size] on the [Rec] menu (→135). EZ is short for “Extended optical zoom”.

- Extended optical zoom cannot be used in the following cases:
 - [Intelligent Auto] Mode (when [Motion Deblur] is [ON])
 - Motion picture
 - When the [Burst Shooting] setting is set to ,  or 
 - When the [Sensitivity] setting is set to [H.8000], [H.10000] or [H.12800]
 - Scene Modes ([Panorama Shot] [HDR] [3D Photo Mode])
 - [Creative Control] Mode ([Toy Effect])
 - When the [Quality] setting is set to ,  or [RAW]
 - When [Multi Expo.] is set in the [Rec] menu

[i.Zoom]

You can use the camera's Intelligent Resolution technology to increase the zoom ratio up to 2x higher than the original zoom ratio with limited deterioration of picture quality.

Set the [i.Zoom] in the [Rec] menu to [ON]. (→141)

- The camera's Intelligent Resolution technology is applied to a picture in the zoom range of [i.Zoom].
- [i.Zoom] does not function in the following cases.
 - [Intelligent Auto] Mode (when [Motion Deblur] is [ON])
 - When the [Burst Shooting] setting is set to [☐], [☐] or [☐]
 - When the [Sensitivity] setting is set to [H.8000], [H.10000] or [H.12800]
 - Scene Modes ([Panorama Shot] [Handheld Night Shot] [HDR] [3D Photo Mode])
 - [Creative Control] Mode ([Toy Effect] [Smooth Defocus] [Radial Defocus])
 - When [Multi Expo.] is set in the [Rec] menu

[Digital Zoom]

Zoom 4x further than Optical/Extended optical zoom. Note that, with Digital Zoom, enlarging will decrease picture quality. Set the [Digital Zoom] in the [Rec] menu to [ON].

(→141)

- [Digital Zoom] cannot be used in the following cases:
 - [Intelligent Auto] Mode
 - When the [Burst Shooting] setting is set to [☐], [☐] or [☐]
 - When the [Sensitivity] setting is set to [H.8000], [H.10000] or [H.12800]
 - Scene Modes ([Panorama Shot] [Handheld Night Shot] [HDR] [3D Photo Mode])
 - [Creative Control] Mode ([Miniature Effect] [Toy Effect])
 - When the [Quality] setting is set to [RAW], [RAW] or [RAW]
 - [High Speed Video] in [Creative Video Mode]
 - When [Multi Expo.] is set in the [Rec] menu
- When [Digital Zoom] is used simultaneously with [i.Zoom], you can only increase the zoom ratio up to 2x.

[Step Zoom]

You can set the zoom operation to allow easy visualization of the angle of view (picture angle) for the focal length of a regular fixed focal length lens (as with a 35 mm film camera). When using the Step Zoom, you can operate the zoom ratio as easily as changing the camera lens.

Preparation:

Set [Step Zoom] for the [Rec] menu to [ON].

- For the setting procedures of the menu. (→25)

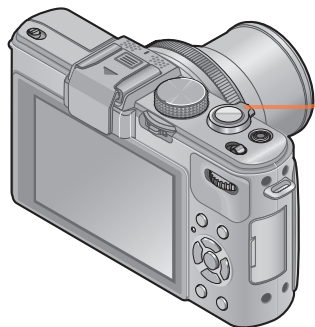
**1 Select the focal length**

Every time you rotate the zoom lever, zooming will stop at the following focal lengths (as with a 35 mm film camera).

Capture a wider area (wide-angle)



Enlarge the subject (telephoto)

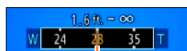

Current zoom position
(Focal lengths the same as those of a 35 mm film camera)

■ [Step Zoom] stop position

24 mm, 28 mm, 35 mm, 50 mm, 70 mm, and 90 mm

- In addition to the above focal lengths, the zoom will stop at the following positions when a setting other than Optical Zoom is set.
 - 135 mm, 200 mm, 300 mm, 400 mm, 500 mm, 600 mm, the focal length at max. Tele, and so on.

- The focal length values are for reference only.
- The focal length will change in the following cases:
 - When the aspect ratio is 1:1
 - When [Burst Shooting] is set to [OFF]
 - When [Handheld Night Shot] is set in Scene mode
- [Step Zoom] cannot be used in the following cases:
 - [Intelligent Auto] Mode
 - When recording motion pictures
- The focal length is displayed during playback for pictures recorded using the [Step Zoom].

Taking pictures with Auto Focus

When Auto Focus is enabled, press the shutter button halfway to focus. Focusing methods differ depending on [Rec] mode and [AF Mode] setting.

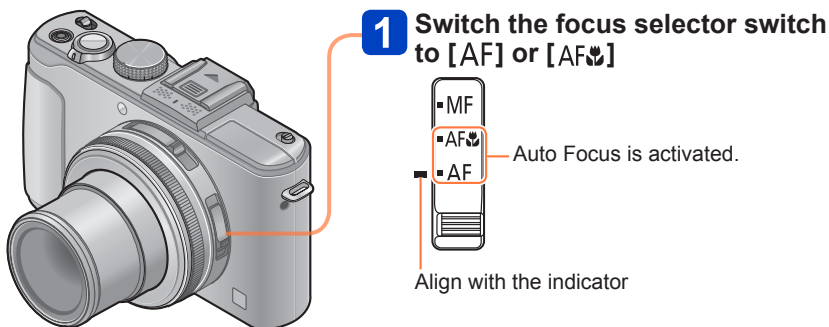

- Subjects/environments which may make focusing difficult:
 - Fast-moving or extremely bright objects, or objects with no color contrast.
 - Taking pictures through glass or near objects emitting light. In dark, or with significant jitter.
 - When too close to object or when taking pictures of both distant and close objects together in the same picture.
- The focus display flashes and beep sounds when focus is not aligned. Use the focus range displayed in red as a reference. Even if the focus display is lit, the camera may be unable to bring the subject into focus if it is out of range.

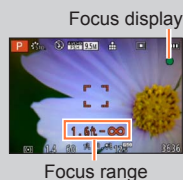





■ Switching [AF Mode]

1 Select [AF Mode] from the [Rec] menu

• For the setting procedures of the menu. (→25)

2 Press ▲▼ to select Auto Focus mode items and press [MENU/SET]

 (Face Detection)	Taking front-on pictures of people
 (AF Tracking)	Automatically locking the focus on a moving subject (→98)
 (23-area-focusing)	Subject not centered in picture (→98)
 (1-area-focusing)	Determined position for focus (→99)

Taking front-on pictures of people

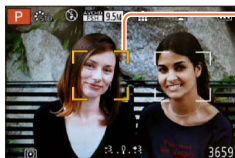

Recognizes faces (up to 15 people) and adjusts exposure and focus accordingly.



AF area

Yellow: When the shutter button is pressed halfway, the frame turns green when the camera is focused.

White: Displayed when more than one face is detected. Other faces that are the same distance away as faces within the yellow AF area are also focused.

- Cannot set to  (Face Detection) in the following cases:
 - Scene Modes ([Panorama Shot] [Night Scenery] [Handheld Night Shot] [Food])
 - [Creative Control] Mode ([Soft Focus] [Miniature Effect])
- If the camera misinterprets a non-human subject as a face in  (Face Detection) setting, switch to another setting.
- If conditions prevent the face from being recognized, such as when the movement of the subject is too rapid, the [AF Mode] setting switches to  (23-area-focusing).

Automatically locking the focus on a moving subject

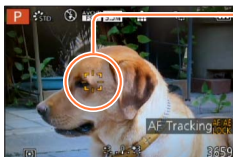



1 Align the subject with the AF Tracking frame and press [AF/AE LOCK] button

AF Tracking frame

When the subject is recognized, the AF Tracking frame changes from white to yellow, and the subject is automatically kept in focus.

If AF Lock fails, a red frame flashes.

- To release AF Tracking → Press [AF/AE LOCK] button.
- Focus range (same as macro recording)

- Under certain recording conditions, such as when the subject is small or dark,  (AF Tracking) may not operate correctly. When  (AF Tracking) does not work, focus will be on  (1-area-focusing).
- Cannot set to  (AF Tracking) in the following cases.
 - [Panorama Shot] Scene Mode
 - [Creative Control] Mode ([Sepia] [Dynamic Monochrome] [High Dynamic] [Toy Effect] [Soft Focus] [Miniature Effect] [Radial Defocus])
 - [Monochrome] in [Photo Style]

Subject not centered in picture

Focus on the subject in the forefront of a wide range area (up to 23-area-focusing) on the recording screen.



Determined position for focus

Focuses on AF area in center of picture. (Recommended when focus is difficult to align)



- You can adjust the position of the AF area. (→100)

- Focus is fixed to  (1-area-focusing) in the following cases:
 - [Miniature Effect] in [Creative Control] Mode
 - [High Speed Video] in [Creative Video Mode]
 - During Interval Recording
- The AF area display may be larger depending on recording conditions such as dark locations or zoom ratio.

■ Locking the focus

When a subject you want to capture is not at the center of the screen, use the following procedure to take the picture.

1 Adjust focus according to subject

Align the AF area with the subject



Hold down halfway

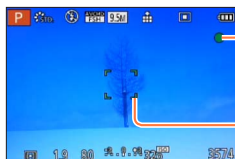

Focus display

When focus is aligned: illuminated
When focus is not aligned: flashing

AF area

When focus is aligned: green
When focus is not aligned: red

2 Return to desired composition



Press fully



AF area

■ Changing the position and size of the AF area

When [AF Mode] is set to  (1-area-focusing), you can move the position or size of the AF area at the center.

1 Select [AF Mode] from the [Rec] menu

- For the setting procedures of the menu. (→25)

2 Use cursor button to select [] from the [AF Mode] items and press

3 To change the AF area

To move the AF area: Press    

To change the size of the AF area: Rotate the rear dial

- To restore the AF area to its initial state (position and size) → Press [DISP.] button

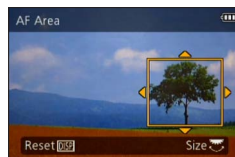

4 Press [MENU/SET]

- While a motion picture is being recorded, you cannot move the AF area or change its size.
- When the AF area is small, it may be difficult to adjust the focus.
- When [Metering Mode] is set to , the new position of the AF area will be measured.
- The AF area display may be larger depending on recording conditions such as dark locations or zoom ratio.

Using Manual Focus together with Auto Focus



After adjusting the focus using Auto Focus, you can make fine adjustments for the focus position using the Manual Focus.

1 Press [AF/AE LOCK] button to lock the focus

AF/AE LOCK

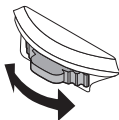
**2** Operate the [ND/FOCUS] lever to adjust the focus

Setting procedures for Manual Focus ([→104](#))

Taking close-up pictures



When you want to enlarge the subject, setting to [AF \downarrow] enables you to take pictures at an even closer distance than the normal focus range (up to 1 cm (0.033 feet) for max. Wide).

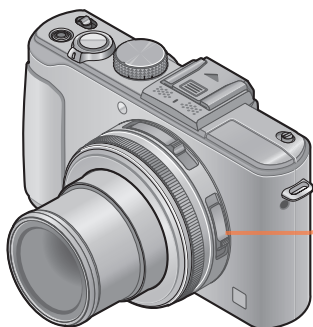

1 Switch the focus selector switch to [AF \downarrow]



Enables close-up focusing on a subject. (Auto Focus functions.)

Align with the indicator

■ Shortest recording distance

The shortest recording distance is the distance from the lens front to the subject. This distance changes gradually depending on the zoom position.

Focus selector switch	Zoom	
	Max. Wide	Max. Tele
AF	50 cm (1.6 feet)	50 cm (1.6 feet)
AF \downarrow	1 cm (0.033 feet)	30 cm (0.98 feet)
MF	1 cm (0.033 feet)	30 cm (0.98 feet)

- Focus range is displayed when operating the zoom, etc.

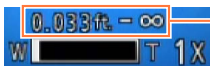

Focus range

- In [Intelligent Auto] Mode, the shortest recording distance will be the same as that for [AF \downarrow], regardless of the focus selector switch setting.
- It may take some time until distant subjects come into focus.
- Using a tripod and [Self Timer] is recommended. Also, when recording a subject that is close to the camera, we recommend that you close the flash to set to [\downarrow] (Forced flash off).
- Moving the camera after aligning the focus is likely to result in poorly focused pictures if subject is close to the camera, due to the margin for focus alignment being severely reduced.
- It is not possible to set AF Macro Mode in the following cases.
 - In all Scene Modes except [3D Photo Mode]

Taking pictures by locking the exposure and/or focus



It is convenient to use the [AF/AE LOCK] button when you want to adjust the composition after the subject has been focused and the exposure is set.

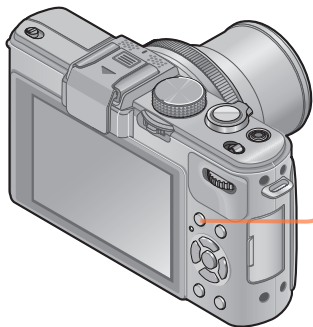

1 Point the camera at the subject

2 Press [AF/AE LOCK] button

AF/AE LOCK



Focus is locked (AF Lock)



Exposure is locked (AE lock)

3 Adjust the composition and then take a picture

- To cancel the focus or exposure
→ Press [AF/AE LOCK] button again

- You can use [AF/AE Lock] from the [Rec] menu to switch between the AE Lock (lock exposure only) setting and the AF Lock (lock focus only) setting. (→138)
- The subject can be focused again by pressing the shutter button halfway, even when AE is locked.
- Program Shift can be set even when AE is locked.
- When you record motion pictures after locking the exposure and/or focus, you can continue to record pictures in the locked state in [Creative Video Mode]. Lock will be canceled in modes other than [Creative Video Mode].
- Lock is canceled when a zoom operation is performed after locking the exposure and/or focus. Perform the locking operation again.
- AE Lock will be disabled in [Manual Exposure] Mode and [Scene Mode].

Taking pictures with Manual Focus

Manual Focus is convenient when you want to lock the focus to take pictures or when it is difficult to adjust focus using Auto Focus.

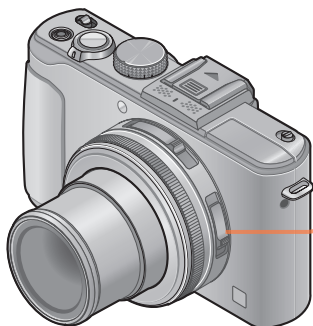

1 Switch the focus selector switch to [MF]

Align with the indicator



Focus manually on a subject.

2 Adjust focus using the [ND/ FOCUS] lever

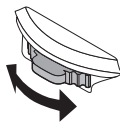
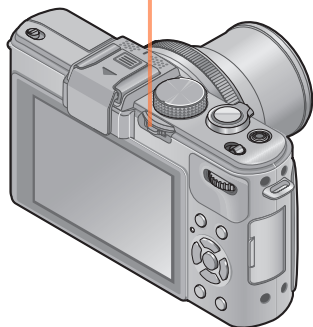

Focusing on a nearby subject

Focusing on a distant subject

Focus range indication

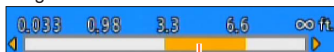

Reference of focus range (depth of field)

- You can adjust the focus using the [ND/FOCUS] lever even during motion picture recording. Note, however, that indications such as MF assist and focus range are not displayed.
- After zoom operation, readjust the focus.
- The focus range displayed by Manual Focus is a reference value. Confirm the focus on the screen ([MF Assist] screen).
- After canceling [Sleep Mode], be sure to readjust the focus.
- When Manual Focus is used together with AE Lock, it is easier to confirm the focus.

■ Enlarged display (MF assist)

When [MF Assist] in the [Setup] menu is [ON] and you perform the Manual Focus operation, an enlarged display appears. (MF assist)

- By pushing the [ND/FOCUS] lever during an enlarged display, you can set the magnification to approx. 5x, 10x or 4x (only at the center of the screen).
- Approximately 2 seconds after the Manual Focus operation, the display switches to normal.
- To change the position of an enlarged display
 - ① Press [MENU/SET] during the Manual Focus operation (while the enlarged display is displayed)
 - ② Use cursor button to move the enlarged display
 - To return the enlarged display to the center → Press [DISP.] button
 - ③ Press [MENU/SET]

- MF assist is not displayed in the Digital Zoom area.

■ 1 Shot AF

When [1 Shot AF] is registered to [Fn Button Set], you can press ◀ once to activate Auto Focus temporarily and focus on the subject.

Taking pictures with the built-in flash



You can use the built-in flash to take pictures in dark locations or light up a subject to adjust the contrast of an entire picture when the background is bright.

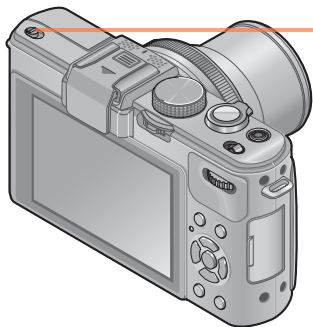

1 Open the built-in flash



■ Closing the built-in flash

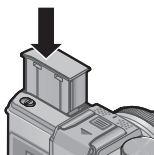

When you do not want to use the flash or after using the flash, press down to retract the flash until it clicks.





- Be careful not to catch a finger or any other part of your body or any object when you close the flash.
- Do not put your hands over the light-emitting area of the flash or look at it from close range. Do not use the flash at close distances to other subjects (heat/light may damage subject).
- Do not close the flash immediately after the preliminary flash is operated prior to taking pictures for Auto/Red-Eye Reduction and other flash settings. If you close the flash immediately, it will cause a malfunction.
- When the flash is being charged, the flash icon flashes red, and you cannot take a picture even when you fully press the shutter button.
- The flash effect may not be sufficient in the following cases:
 - Slow shutter speed
 - When [Burst Shooting] is set to []
- Flash charging may take time if battery is low or if using flash repeatedly.
- When an External Flash is attached, it will have priority over the built-in flash. (→201)

Changing the setting of the flash



1 Select [Flash] in the [Rec] menu



- For the setting procedures of the menu. (→25)

2 Press ▲ ▼ to select a type and press [MENU/SET]

Type, operations		Uses
 [Auto]	<ul style="list-style-type: none"> • Automatically judges when to use flash 	Normal use
 [Auto/Red-Eye]*	<ul style="list-style-type: none"> • Automatically judges when to use flash (reduces red-eye) 	Taking pictures of subjects in dark places
 [Forced Flash On]	<ul style="list-style-type: none"> • Always uses flash 	Taking pictures with backlight or under bright lighting (e.g. fluorescent)
 [Slow Sync./Red-Eye]*	<ul style="list-style-type: none"> • Automatically judges when to use flash (reduces red-eye; slow shutter speed to take brighter pictures) 	Taking pictures of subjects against a nightscape (tripod recommended)

* Two flashes will be emitted. Do not move until after the second flash. Interval between flashes varies according to brightness of subject.

When [Red-Eye Removal] in the [Rec] menu is set to [ON], the icon changes to /, red-eye is automatically detected and the picture data is corrected. (Only when [AF Mode] is  (Face Detection))

- When the built-in flash is closed,  (Forced flash off) is set regardless of the flash setting.
- In [Intelligent Auto] mode,  is set and light is emitted according to the subject and the brightness if you open the built-in flash.
- You can adjust the intensity of the flash using [Flash Adjust.] in the [Rec] menu. (→145)
- You can use [Flash Synchro] in the [Rec] menu to set whether the first curtain sync or the second curtain sync will be used. (→144)
- The effect of red-eye reduction varies depending on the subject and is affected by factors such as distance to the subject, whether the subject is looking at the camera during preliminary flash, and so on. In some cases, the effect of red-eye reduction may be negligible.
- Flash settings may be changed when changing recording mode.
- Scene Mode flash settings are restored to default when Scene Mode is changed.
- If light from the flash on a subject is insufficient, neither the proper exposure nor White Balance is achieved.

Available types in each mode (○: Available, —: Not available, □: Default setting)

	iA	P A	S M	🌀*1	[Scene Mode]						
					🌙	🌅	🌃	👤	📷	👁️	🐕
⚡A	○*2	○	○	—	○	○	○	—	○	○	○
⚡A👁️	—	○	○	—	○	○	—	—	—	○	—
⚡	—	○	○	—	○	○	○	—	○	○	○
⚡S👁️	—	○	—	○	—	—	—	○	—	—	—

*1 [Smooth Defocus] and [Radial Defocus] only

*2 Set to [iA], [iA👁️], [iA📷], [iA👁️📷] or [iA📷] depending on the subject and brightness.

● The flash cannot be used in the following cases.

- Recording motion pictures
- The following Scene Modes:
[Scenery] [Panorama Shot] [Night Scenery] [Handheld Night Shot] [HDR] [Sunset]
[Glass Through] [3D Photo Mode]

The available flash range when [Sensitivity] setting is [AUTO]

Max. Wide	Approx. 0.8 m - 8.5 m*3 (2.6 feet - 28 feet)
Max. Tele	Approx. 0.3 m - 5.2 m*3 (0.98 feet - 17 feet)

*3 When [ISO Limit Set] is [AUTO].

Shutter speeds for each flash mode

⚡A ⚡A👁️ ⚡	1/60*4 - 1/4000th
⚡S👁️	1*4*5 - 1/4000th

*4 Varies according to [Min. Shtr Speed] setting.

*5 When [Min. Shtr Speed] is set to [AUTO], and a jitter is detected when [Stabilizer] is turned to [ON], the maximum speed is 1/4 second. Also varies according to [Intelligent Auto] Mode and Scene Modes, etc.

Setting the ISO Sensitivity



Set ISO Sensitivity (sensitivity to lighting) manually.
We recommend higher settings to take clear pictures in darker locations.

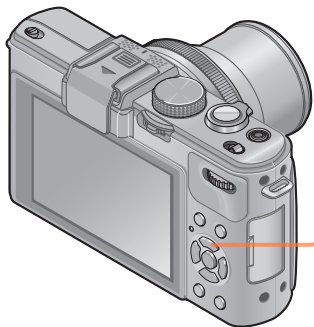

1 Press [ISO] button



2 Press ▲▼ to select ISO Sensitivity and press [MENU/SET]

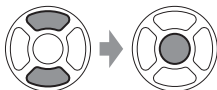

■ Settings

[AUTO]	ISO Sensitivity is automatically set in a range up to 1600 depending on the brightness of a subject.
ISO	ISO Sensitivity is automatically set in a range up to 1600 depending on the movement and brightness of a subject.
[80] / [100] / [200] / [400] / [800] / [1600] / [3200] / [6400] / [H.12800]	ISO Sensitivity is fixed at the selected setting. <ul style="list-style-type: none"> When [ISO Increments] is set to [1/3 EV], more ISO Sensitivity settings can be selected. (→137) When [Extended ISO] is set to [ON], you can set the ISO Sensitivity to a value exceeding 6400. (→110)

Setting guide

[Sensitivity]	[80]	↔	[H.12800]
Location (recommended)	Bright (outdoors)		Dark
Shutter speed	Slow		Fast
Interference	Low		High
Subject blur	High		Low

- The [Sensitivity] is automatically set in the following cases:
 - When recording motion pictures (Except [Creative Video Mode])
 - When recording [High Speed Video] in [Creative Video Mode]
 - When [Burst Shooting] is set to []

■ About extended ISO

When [Extended ISO] in the [Rec] menu is set to [ON], you can also set the following ISO Sensitivity values.

H.8000* / H.10000* / H.12800

* When [ISO Increments] is [1/3EV]

- When you record a picture using [Extended ISO], the maximum number of recorded pixels is reduced.

Aspect ratio	Maximum number of recordable pixels
1:1	2.5 M
4:3	3 M
3:2	3 M
16:9	2.5 M

- You cannot record pictures using [RAW , [RAW , and [RAW] under [Quality] when [Extended ISO] is set.

Setting coloring (White Balance)



Adjust the color depending on the light source to ensure natural color.

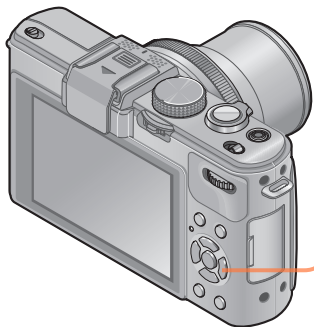

1 Press [WB] button



2 Press ▲ ▼ to select the white balance and press [MENU/SET]

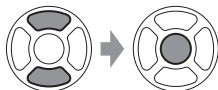

■ Settings: [AWB] ([Auto White Balance]) / ☀ ([Daylight]) / ☁ ([Cloudy]) /
 🏠 ([Shade]) / ⚡ ([Flash]) / ☹ ([Incandescent]) /
 📷 1 📷 2 ([White Set 1] [White Set 2]) / 🌡 ([Color Temperature])

- When [AWB] (Automatic White Balance) is set, the coloring is adjusted in accordance with the light source. However, if the scene is too bright or too dark or if other extreme conditions apply, the pictures may appear reddish or bluish. The White Balance may not operate correctly if there is a multiple number of light sources.
- We recommend setting [AWB], [📷 1] or [📷 2] under fluorescent, LED, or other types of lighting.
- [White Balance] setting is fixed to [AWB] in the following cases:
 Scene Modes ([Scenery], [Night Portrait], [Night Scenery], [Handheld Night Shot], [Food], [Sunset])
- Even if the camera's power is OFF, the set White Balance is remembered. (If the Scene Mode is changed, the white balance setting returns automatically to [AWB].)

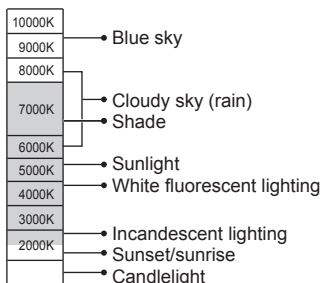

■ [AWB] operational range:



K=Kelvin Color Temperature

Setting the White Balance manually

Take a picture of a white object under the target light source to adjust colors.

- 1** Press [WB] button
- 2** Press ▲ ▼ to select either [,] or [,] and press ►
- 3** Point the camera at a white object such as a piece of paper, ensuring that it is inside the frame at the center of the screen, and press [MENU/SET]

- Even if the camera's power is OFF, the set White Balance is remembered.
- It may not be possible to set the correct White Balance if subjects are too bright or too dark. In this case, adjust the brightness and try to set the White Balance again.

Setting the White Balance using color temperature

You can set the White Balance using color temperature. Color temperature is a numeric value that expresses the color of light (unit: K*). A picture becomes bluish when the color temperature value is higher, and reddish when the temperature value is lower.

* Kelvin

- 1** Press [WB] button
- 2** Press ▲ ▼ to select [K] and then press ►
- 3** Press ▲ ▼ to select the color temperature value and press [MENU/SET]

● You can set the color temperature from 2,500 K to 10,000 K.

Performing White Balance fine adjustments

White Balance settings can be individually fine-tuned if colors still do not appear as anticipated.

- 1** Press [WB] button
- 2** Press ▲ ▼ to select the White Balance fine adjustment setting, and press ►
 - When you select [A], [G+] or [K], press ► again.
- 3** Use ▲ ▼ ◀ ▶ to perform fine adjustments and press [MENU/SET]

◀: A (amber: orangish colors)
▲: G+ (green: greenish colors)

▶: B (blue: bluish colors)
▼: M- (magenta: reddish colors)

- When you perform fine adjustments of the White Balance toward the A (amber) or B (blue) side, the color of the White Balance icon displayed on the screen will change to the fine-tuned color.
- When you perform fine adjustments of the White Balance toward the G+ (green) or M- (magenta) side, [+] (green) or [-] (magenta) will be displayed in the White Balance icon on the screen.
- When fine adjustments of the White Balance are not performed, select the center point.
- Settings remain applied when using flash.
- You can perform fine adjustments of the White Balance independently for each White Balance setting item.
- Settings are remembered even if the camera is turned off.
- When you reset the White Balance in [1] or [2], or reset the color temperature in [K], the White Balance fine adjustment level will return to the standard setting (center point).

Bracket recording using White Balance

Bracket settings are performed based on the fine adjustment values for White Balance, and three pictures with different coloring are automatically recorded when the shutter button is pressed once.



1 Using the White Balance Fine Adjustment screen, set the White Balance, which is the reference for the bracket

- How to display the White Balance fine adjustment screen (→113)

2 Press [DISP.] button

3 Use cursor button to set the bracket and press [MENU/SET]

- ▲▼: G+ (green: greenish colors) to M- (magenta: reddish colors)
- ◀▶: A (amber: orangish colors) to B (blue: bluish colors)
- If the bracket width is not set, [WB Bracket] is disabled.

- When [WB Bracket] is set, [BKT] appears on the White Balance icon.
- The position of the bracket cannot exceed the edge (limit value) of the White Balance fine adjustments.
- When White Balance fine adjustments are performed after the bracket is set, the bracket is used to take pictures with the changed adjustment value as the center value.
- When the camera is turned off, the White Balance Bracket setting is canceled.
- The shutter sound will be emitted only once.
- When the White Balance Bracket is set, [Auto Bracket], [Aspect Bracket] and [Burst Shooting] will be canceled.
- The White Balance Bracket does not function in the following cases.
 - During motion picture recording
 - When the [Quality] setting is set to [RAW , [RAW , or [RAW]

Taking pictures with self-timer



We recommend using a tripod. This is also effective for correcting jitter when pressing the shutter button, by setting the self-timer to 2 seconds.



1 Press button



2 Press to select [Self Timer] and press

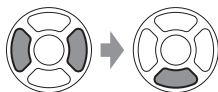

3 Press to select the self-timer operation setting and press [MENU/SET]

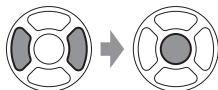

	The shutter is activated after 10 seconds.
	The shutter is activated after 10 seconds and three pictures are taken at intervals of approximately 2 seconds.
	The shutter is activated after 2 seconds.

(Continued on the next page)

Self-timer indicator
(Flashes for set duration)

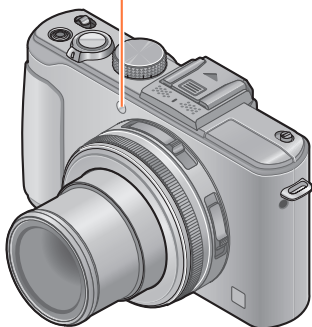

4 Take a picture

Press the shutter button fully to start recording after the preset time.



- To cancel while in operation
→ Press [MENU/SET]

■ To cancel

Select [□] ([Single]) in step 2.

- Focus will be automatically adjusted immediately before recording if the shutter button is pressed fully.
- After Self-timer indicator stops flashing, it may then be lit for AF Assist Lamp.
- You cannot use the self-timer for motion picture recording or interval recording.

Setting the burst function



A burst of still pictures can be recorded while the shutter button is pressed fully.

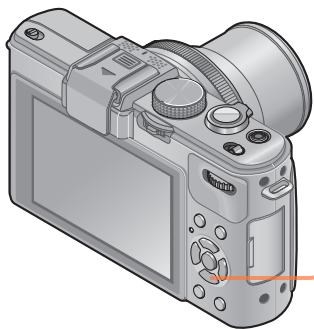

1 Press [] button











2 Press ◀▶ to select [Burst Shooting] and press ▼



3 Press ◀▶ to select the burst setting and press [MENU/SET]





Setting	Speed	No. of pictures	Focus, exposure, White Balance
	Approx. 2 pictures/sec.	100* ¹	Only the focus is fixed to the settings of the first picture taken.* ²
	Approx. 2 pictures/sec.	100* ¹	Adjusted within the possible range.
	Approx. 5 pictures/sec.	100* ¹	Only the focus is fixed to the settings of the first picture taken.* ²
	Approx. 5 pictures/sec.	100* ¹	Adjusted within the possible range.
	Approx. 11 pictures/sec.	12	Fixed to the settings of the first picture taken.
	Approx. 40 pictures/sec.	40	Fixed to the settings of the first picture taken.
	Approx. 60 pictures/sec.	60	Fixed to the settings of the first picture taken.
 * ³	Complies with recording conditions (Flash burst)	5	Fixed to the settings of the first picture taken.



*¹ The number of burst pictures is limited by the picture-taking conditions and the type and/or status of the card used.

*² The exposure and White Balance are adjusted within the possible range.

*³ Carry out burst recording using the flash. Only in the **P**, **A**, **S** mode

■ Note on the picture size setting

When ,  or  is set, the picture size will be smaller.

Aspect ratio			
4:3	5 M, 3 M, 2 M, 0.3 M	2.5 M, 0.3 M	3 M
3:2	4.5 M, 2.5 M, 0.3 M	3 M, 0.3 M	2.5 M
16:9	3.5 M, 2 M, 0.2 M	3.5 M, 0.2 M	2 M
1:1	3.5 M, 2.5 M, 0.2 M	2 M, 0.2 M	2.5 M

■ To cancel

Select  ((Single)) in step **2**.

- When [60] is set, the recording range will be narrower.
- Pictures taken with the [40] or [60] setting are recorded together as a group (group display). (→156)
- Depending on changes in the brightness of the subject, the second and subsequent pictures may be recorded brighter or darker when using the burst function at the [40], [40], [60] or [60] setting.
- Even if [AF] or [AF] is set, the focus is fixed on the first picture when the burst function is used during motion picture recording.
- Burst speed may be reduced if shutter speed is reduced in darker locations.
- The pictures taken using the burst function at the [40] or [60] setting may be distorted if the subjects were moving or the camera was moved.
- The flash is set to [⊕] (Forced flash off). (Excluding [60])
- Settings will be stored even if power is turned off.
- The burst function cannot be used in the following cases:
 - [Creative Control] Mode ([Toy Effect] [Miniature Effect] [Soft Focus] [Star Filter] [Smooth Defocus] [Radial Defocus])
 - Scene Modes ([Panorama Shot] [Handheld Night Shot] [HDR] [3D Photo Mode])
 - During Interval Recording
- When [Intelligent Auto] mode is set or Scene Mode is set to [Night Portrait] or [Night Scenery], [40], [60] and [60] cannot be selected.
- With repeated recordings, it may take a while between recordings, depending on the usage conditions.
- It may take a while to store still pictures that were taken using the burst function. If you continue to record while storing, the number of burst pictures that can be taken will be reduced. A high-speed card is recommended when recording using the burst function.
- You cannot use zoom during burst recording.

Changing the aspect ratio of the still pictures



You can easily switch the aspect ratio of still pictures using the aspect ratio selector switch.

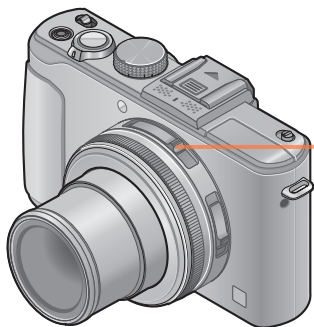

1 Switching the aspect ratio selector switch



● Edges may be cut off when printing - be sure to check in advance.

Automatically changing the aspect ratio while taking pictures [Aspect Bracket]



When you press the shutter button once, the camera automatically takes four pictures with four types of aspect ratios (4:3, 3:2, 16:9, and 1:1). (The shutter sounds only once.)

1 Select [Aspect Bracket] from [Rec] menu

- For the setting procedures of the menu. (→25)

2 Use cursor button to select [ON] and press [MENU/SET]



The range that can be recorded for each aspect ratio is displayed.

- The same shutter speed, aperture value, focus, and the same [Exposure], [White Balance] and [Sensitivity] settings are used for the four pictures.
- Aspect Bracket is disabled when the recordable number of pictures is three or less.
- When Aspect Bracket is set, [Auto Bracket] and [Burst Shooting] are canceled.
- [Aspect Bracket] cannot be used in the following cases:
 - [Creative Control] Mode ([Toy Effect] [Miniature Effect] [Soft Focus] [Star Filter] [Smooth Defocus] [Radial Defocus])
 - Scene Modes ([Panorama Shot] [Handheld Night Shot] [HDR] [3D Photo Mode])
- Cannot be used in the following cases:
 - During motion picture recording
 - When the [Quality] setting is set to [RAW], [RAW] or [RAW]

Using the built-in ND filter



When you want to take pictures using the maximum aperture in a bright outdoor location or at a slow shutter speed, you can use the built-in ND filter to reduce the amount of light that passes through the lens.

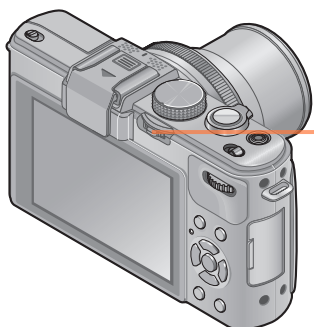

1 Press the [ND/FOCUS] lever to activate the ND filter

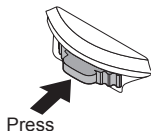

When using the built-in ND filter

- To deactivate the built-in ND filter
→ Press the lever again.

- The built-in ND filter makes a light amount adjustment that is equivalent to approximately 3 EV stops.
- The built-in ND filter is automatically activated when [Program Diagram] is set to modes other than [STD.] in [Program AE] Mode.
- Activated automatically during [Smooth Defocus] or [Radial Defocus] in [Creative Control] mode.
- You cannot switch the setting of the built-in ND filter when recording a motion picture.

Compensating the exposure



Corrects the exposure when there is a backlight or when the subject is too dark or too bright.

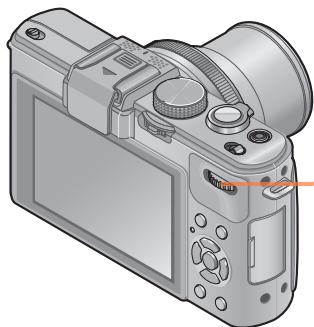

1 Press the rear dial to select the Exposure Compensation display



Selected (yellow)

2 Select the Exposure Compensation value



Exposure Compensation value (+3 - -3)

Exposure meter

About the exposure meter

Shutter speed

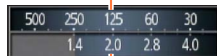

Aperture value

- If the picture is too dark, adjust the exposure to the “+” direction.
- If the picture is too bright, adjust the exposure to the “-” direction.

- Depending on the brightness, this may not be possible in some cases.
- The Exposure Compensation value you set is retained even after the camera is turned off.

[Auto Bracket]



The Auto Bracket function takes a burst of still pictures while automatically changing the exposure. When Exposure Compensation is set, the camera takes pictures automatically based on the Exposure Compensation value, using one-stop lower and one-stop higher exposures.

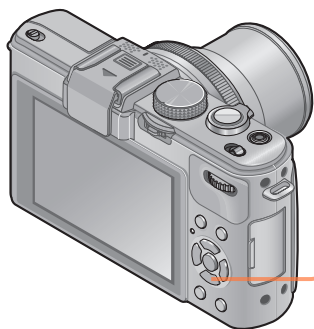

1 Press button



2 Press to select [Auto Bracket] and press

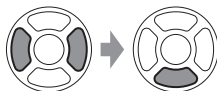

3 Press to select the compensation range and press [MENU/SET]

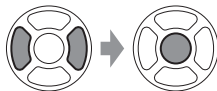

- The camera takes the first picture without compensation, the second picture with minus compensation and the third picture with plus compensation.

■ **To cancel**

Select ([Single]) in step **2**.

- Cannot be used with flash.
- [Auto Bracket] cannot be used in the following cases:
 - [Creative Control] Mode ([Miniature Effect] [Soft Focus] [Star Filter] [Smooth Defocus] [Radial Defocus])
 - Scene Modes ([Panorama Shot] [Handheld Night Shot] [HDR] [3D Photo Mode])
 - Recording motion pictures
 - During Interval Recording

Switching the display of recording information, etc.



You can also turn off the recording information (such as icons for various settings) and the level gauge (→128).

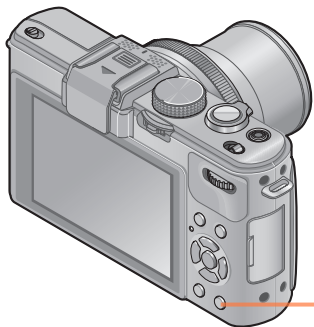

1 Press [DISP.] button to switch the display

DISP. Every time you press the button, the display will be switched.

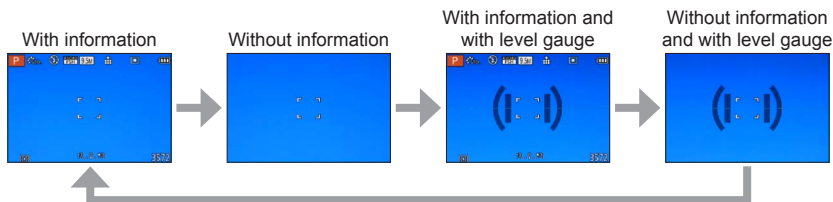

- When you set [Guide Line] of the [Setup] menu to a setting other than [OFF], the guidelines will be displayed.
- You can use [LCD Disp.Style] and [LVF Disp.Style] to change the layout of the display itself.

Using the level gauge



If you want to make sure that the camera is not slanted or tilted, for example, when you take a picture of a landscape, use the level gauge indication as a reference.

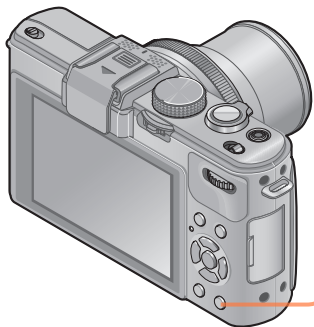

1 Press [DISP.] button to switch the display

DISP.  Press the button to switch the display. Press the button until the level gauge is displayed.

2 Correct camera angle

■ Using the level gauge

The yellow line indicates the current angle (horizontal line). Correct the angle of the camera so that it matches the white line.

Tilting up or down

- In this case, it is facing upward.

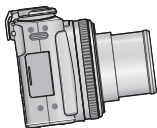

Tilting left or right

- In this case, the right side has dropped.

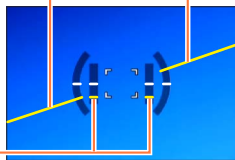

- When the camera's angle is minimal, the level gauge will turn green.
- When pictures are taken in portrait orientation, the level gauge is automatically switched to one for portrait orientation.

- Even when angle is more or less corrected, there may be an error of about ± 1 degree.
- Every time you press ◀ when [Fn Button Set] of the [Setup] menu is set to [Level Gauge], you can turn the level gauge indication on and off.
- When the camera is being moved, the level gauge may not be displayed correctly.
- The level gauge may not be displayed correctly or the direction detect function may not operate correctly if the pictures are taken with the camera pointing sharply up or down.

Using Quick menu

In recording mode, you can quickly change the main settings of a still picture or a motion picture.

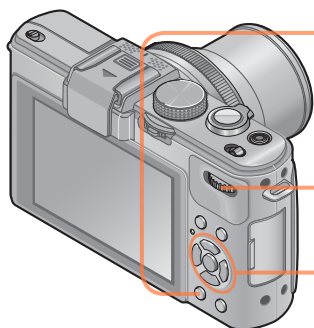

1 Press [Q.MENU] button to display the Quick menu

Q.MENU



2 Select a menu item

■ Using the rear dial

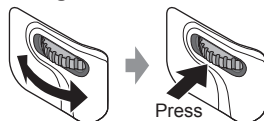

■ Using the cursor button



3 Change the setting

■ Using the rear dial

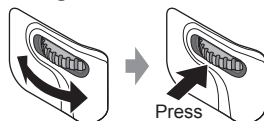

■ Using the cursor button



4 Press [Q.MENU] button to close the Quick menu

Q.MENU

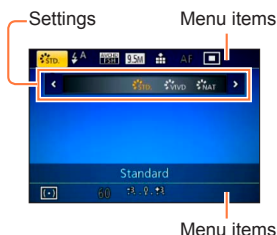

● The menu items and setting items that are displayed differ depending on the recording mode.

Recording with the Face Recognition function

[Face Recog.]



Default [Face Recog.] setting is [OFF].

When the face pictures are registered, the setting will be [ON] automatically.

■ How the Face Recognition function works

During recording

(When [AF Mode] is  (Face Detection))

- The camera recognizes a registered face and adjusts focus and exposure.
- When registered faces that have set names are recognized, the names are displayed (max. 3 people).



During playback

- The name and age are displayed (if information is registered).
- The names that have been set for the recognized faces are displayed (max. 3 people).
- Only pictures of the selected registered people are played back ([Category Selection]).

- Only the first picture of the burst recording will contain Face Recognition information.
- If you press the shutter button halfway, then point the camera at a different subject and record, recording information for a different person may be put on the picture.
- Face Recognition does not work in the following cases:
 - Motion picture
 - Scene Modes ([Panorama Shot] [Night Scenery] [Handheld Night Shot] [Food] [3D Photo Mode])
 - [Creative Control] Mode ([Miniature Effect] [Soft Focus])
- Face Recognition searches for faces similar to those registered, but there is no guarantee it will always recognize these faces. In some cases, the camera cannot recognize or incorrectly recognizes even registered people depending on their expression or the environment.
- Even if Face Recognition information is registered, pictures recorded when the name is [OFF] are not categorized for Face Recognition in [Category Selection].
- **Even if Face Recognition information is changed, Face Recognition information for previously recorded pictures is not changed.**
For example, if a name is changed, pictures recorded before the change are not categorized for Face Recognition in [Category Selection].
- To change name information for pictures already recorded, perform a [REPLACE] (→181) in [Face Rec Edit].

Registering face pictures

Up to 6 people's face pictures can be registered along with such information as name and birthdate.

You can facilitate Face Recognition by the way you register faces: for example, register multiple face pictures of the same person (up to 3 pictures in one registration).

1 Select [Face Recog.] from the [Rec] menu

- For the setting procedures of the menu. (→25)

2 Select [MEMORY] with cursor button, and press [MENU/SET]

3 Select [New] with cursor button, and press [MENU/SET]

- If 6 people are already registered, first delete a registered person. (→133)

4 Record the face picture

- ① Align the face with the guide and record
- ② Select [Yes] with cursor button, and press [MENU/SET]
 - If re-recording, select [No]
 - Faces of subjects other than people (e.g. pets) cannot be registered.
 - When [DISP.] button is pressed, an explanation is displayed.



(Continued on the next page)

5 Press ▲ ▼ to select the item for editing and press ►

[Name]	① Select [SET] with cursor button, and press [MENU/SET] ② Enter the name (Entering text (→44))
[Age]	Set the birthdate. ① Select [SET] with cursor button, and press [MENU/SET] ② Press ◀▶ to select year, month and day, set with ▲▼, and press [MENU/SET]
[Focus Icon]	Change the icon that is displayed when the subject is in focus. ① Select the focus icon with cursor button, and press [MENU/SET]
[Add Images]	Up to 3 face pictures of the person can be registered. ① Select an unregistered frame, and press [MENU/SET] • When a registered face picture is selected with cursor button, a screen to confirm deletion is displayed. Select [Yes] to delete the face picture. (If only one picture is registered, it cannot be deleted.) ② Record the picture (Perform step 4 (→131)) ③ Press [⏏/▶] button

■ Recording tips when registering face pictures

- Make sure the subject's eyes are open and mouth closed; have the subject face the camera directly, and make sure the outline of the face, the eyes and eyebrows are not hidden by hair.
- Make sure there are no heavy shadows on the face. (During registration, the flash is not used.)

■ If the camera seems to have difficulty recognizing faces when recording

- Register additional pictures of the same person's face, indoors and outdoors or with different expressions or angles.
- Register additional pictures at the place you are recording.
- If a registered person is no longer recognized, re-register that person.

Editing or deleting information about registered persons

Information about registered people can be edited or deleted.

- 1** Select **[Face Recog.]** from the **[Rec]** menu
 - For the setting procedures of the menu. (→25)
- 2** Select **[MEMORY]** with cursor button, and press **[MENU/SET]**
- 3** Use cursor button to select people to be edited or deleted and press **[MENU/SET]**
- 4** Use cursor button to select the item and press **[MENU/SET]**

[Info Edit]	Edit name or other registered information.
[Priority]	Set priority order for focus and exposure. ① Select the registration order with cursor button, and press [MENU/SET]
[Delete]	Delete information and face pictures of registered persons.

Using the [Rec] menu

You can perform settings such as Picture size and flash.

- For the setting procedures of the menu. (→25)

[Photo Style]

You can adjust the colors and picture quality according to the concept of the picture that you want to create.



■ Settings

🌟 STD. [Standard]	Standard setting.
🌟 VIVID [Vivid]	Setting with slightly high contrast and saturation.
🌟 NAT [Natural]	Setting with slightly low contrast.
🌟 MONO [Monochrome]	Setting that creates a picture using monochrome shades of gray only, such as black and white.
🌟 SCNY [Scenery]	Setting that creates a picture using vivid colors for the blue sky and green.
🌟 PORT [Portrait]	Setting that produces the look of a healthy complexion.
🌟 CUST [Custom]	Setting for using colors and picture quality that were registered in advance.

■ Adjusting the picture quality and registering a custom setting

- ① Press ◀▶ to select the photo style to be adjusted, and press ▼
- ② Press ▲▼ to select an item and press ◀▶ to adjust.
- ③ Press [MENU/SET]

Settings	Settings and results	-	+
🌐 [Contrast]	Difference between light and dark in a picture	Low	High
🌐 [Sharpness]	Picture contour	Soft	Sharp
🌐 [Saturation]*	Color change	Quiet impression	Vivid impression
NR [Noise Reduction]	Noise reduction	Priority on resolution	Priority on noise reduction
[Custom setting]	You can register the setting for the adjusted picture quality to [Custom]. ① Select [Custom setting] and press [MENU/SET] ② Select [Yes] and press [MENU/SET]		

* When [Monochrome] is selected, the color tone is changed.

- The settings of the adjusted picture quality will be stored in memory even when the camera is turned off.
- When the picture quality is adjusted, [+] will be displayed in the icon.

- For the setting procedures of the menu. (→25)

[Picture Size]



Set the size (number of pixels) of still pictures. Number of pictures which can be recorded depends on this setting and on [Quality].

■ Settings

Aspect ratio	4:3	3:2	16:9	1:1
Setting and picture size	10M 3648×2736	9.5M 3776×2520	9M 3968×2232	7.5M 2736×2736
	7M * 3072×2304	6.5M * 3168×2112	6M * 3328×1872	5.5M * 2304×2304
	5M 2560×1920	4.5M 2656×1768	4.5M 2784×1568	3.5M 1920×1920
	3M 2048×1536	3M * 2112×1408	2.5M 2208×1248	2.5M * 1536×1536
	2M * 1600×1200	2.5M 2048×1360	2M * 1920×1080	0.2M 480×480
	0.3M 640×480	0.3M 640×424	0.2M 640×360	

* This setting is not available in ([Intelligent Auto] Mode).

- Mosaic effect may appear depending on subject and recording conditions.

Setting guide

Larger picture size	← →	Smaller picture size
Sharper		Less detailed
Lower recording capacity		Higher recording capacity

- For the setting procedures of the menu. (→25)

[Quality]



Set the compression rate for still picture data.

■ Settings

[Fine]	Gives priority to picture quality and saves pictures in JPEG file format.
[Standard]	Saves pictures in JPEG file format using standard picture quality.
RAW [RAW+Fine]	Saves pictures in JPEG file format in addition to the RAW file format.*1
RAW [RAW+Standard]	
RAW [RAW]	Saves pictures in the RAW file format.*2
[3D+Fine]	Simultaneously saves 3D still picture data (MPO) and pictures in JPEG file format. (Only when [3D Photo Mode] Scene Mode is set.)
[3D+Standard]	

*1 If you delete a RAW file from the camera, the corresponding JPEG file is also deleted.

*2 You cannot set the picture size. (The pictures are saved using the maximum recordable pixels for each image aspect ratio.)

■ About RAW file

You can perform advanced editing of RAW pictures using the software ("SILKYPPIX Developer Studio" developed by Ichikawa Soft Laboratory) on the CD-ROM (supplied). (The edited pictures can be saved in a file format such as JPEG that can be displayed on your computer.)

- For the setting procedures of the menu. (→25)

[ISO Limit Set]

You can set the upper limit of ISO Sensitivity when [Sensitivity] is set to [AUTO] or [iISO].



■ **Settings:** [AUTO] / [200] / [400] / [800] / [1600] / [3200]

- This function is disabled during motion picture recording. (Except [Creative Video Mode])

[ISO Increments]

You can change the setting to increase ISO Sensitivity by 1 EV or 1/3 EV.



■ **Settings:** [1/3EV] / [1EV]

- When this setting is changed from [1/3EV] to [1EV], the setting for [Sensitivity] may be changed. (The closest ISO Sensitivity that can be set for [1EV] will be used.)

[Extended ISO]

For details (→110).



[Program Diagram]

For details (→59).



[Face Recog.]

For details (→130).



[AF Mode]

For details (→96).



- For the setting procedures of the menu. (→25)

[Quick AF]



The focus is automatically adjusted when camera blurring is small even when the shutter button is not pressed. (Increases battery consumption)

■ Settings: [ON] / [OFF]

- Focus alignment may take time if zoom is suddenly changed from max. Wide to max. Tele, or if suddenly moving closer to subject.
- Press shutter button halfway if focus is difficult to align.
- The function will turn [OFF] in the following cases.
 - [Soft Focus] under [Creative Control] Mode
 - [Night Portrait], [Night Scenery] and [Handheld Night Shot] Scene Modes
- [Quick AF] will not work while AF Tracking is operating.

[AF/AE Lock]



You can change the operation of the [AF/AE LOCK] button to either lock focus (AF) only or lock exposure (AE) only when this button is pressed. For details on the setting operation (→103)

■ Settings

[AF]	Only the focus is locked. ([AFL] is displayed on the screen.)
[AE]	Only the exposure is locked. ([AEL] is displayed on the screen.)
[AF/AE]	Both the focus and exposure are locked. ([AFL] and [AEL] are displayed on the screen.)

- For the setting procedures of the menu. (→25)

[Metering Mode]

You can change the position for measuring brightness when correcting exposure.



■ Settings

[Metering Mode]	Brightness measurement position	Conditions
[<input type="radio"/>] [Multi Metering]	Whole screen	Normal usage (produces balanced pictures)
[<input type="checkbox"/>] [Center Weighted]	Center and surrounding area	Subject in center
[<input type="radio"/>] [Spot]	Center and close surrounding area	Great difference between brightness of subject and background (e.g. person in spotlight on stage, backlighting)

[i.Dynamic]

This function automatically adjusts contrast and exposure to produce pictures with closer-to-actual colors when there is a significant difference between light and dark in the background and the subject.



■ Settings: [HIGH] / [STANDARD] / [LOW] / [OFF]

- [LOW], [STANDARD] and [HIGH] indicate the maximum range provided by the effect of this control.
- If [i.Dynamic] is activated even when [Sensitivity] is set to [80] or [100], pictures may be recorded with higher sensitivity than the ISO Sensitivity setting.

- For the setting procedures of the menu. (→25)

[Multi Expo.]



You can combine two or three still pictures into a single picture.

■ Settings

[Start]	<p>Start taking pictures.</p> <p>① Decide on your composition and take the first picture</p> <p>② Press ▲▼ to select [Next] and then press [MENU/SET]</p> <ul style="list-style-type: none"> • [Retake]: Delete the result of the last shot and take another picture. • [Exit]: Exit Multi Exposure and save the picture that was taken. <p>③ Take the second and third pictures</p> <ul style="list-style-type: none"> • When you press [MENU/SET] while taking pictures, the pictures that you took are saved and Multi Exposure is closed. <p>④ Use cursor button to select [Exit] and press [MENU/SET]</p>
[Auto Gain]	<p>[ON]: Combines several pictures into one by automatically adjusting the brightness in accordance with the number of pictures taken.</p> <p>[OFF]: Combines several pictures into one by simply overlapping the exposure results of all pictures, as is.</p> <p>Since this setting may create a combined picture that is too bright for some subject brightness level, perform Exposure Compensation if required.</p>

- Still pictures are not saved in memory until Multi Exposure is ended.
- Information for the picture taken last will be used as recording information of pictures taken using Multi Exposure.
- The picture size setting will be fixed at the point at which you select [Start].
- The zoom position and White Balance are fixed at the point at which you take the first picture.
- There are some restrictions on the functions, for example, you will not be able to use the following functions.
 - [Burst Shooting]
 - [i.Dynamic]
 - [Auto Bracket]
 - [Aspect Bracket]
 - [WB Bracket]

- For the setting procedures of the menu. (→25)

[Min. Shtr Speed]

Sets the minimum value for the shutter speed. We recommend using slower shutter speeds to take brighter pictures in dark locations.



■ **Settings:** [AUTO] [1/250] [1/125] [1/60] [1/30] [1/15] [1/8] [1/4] [1/2] [1]

- Slower shutter speeds allow for brighter pictures but increase risk of jitter, so we recommend using a tripod and the self-timer.
- As still pictures may become dark when using faster values such as [1/250], we recommend that still pictures are taken in bright locations ([MIN] flashes red when shutter button is pressed halfway if still picture will be dark).
- [MIN] is displayed on screen for settings other than [AUTO].

[i.Resolution]

You can use the camera's Intelligent Resolution technology to record still pictures with sharper outlines and clearer resolution.



■ **Settings:** [HIGH] / [STANDARD] / [LOW] / [OFF]

[i.Zoom]

For details (→94).



[Digital Zoom]

For details (→94).



- For the setting procedures of the menu. (→25)

[Step Zoom]

For details (→95).



[Stabilizer]

Automatically detects and prevents jitter.

■ Settings: [ON] / [OFF]

- This setting is fixed to [ON] in [Handheld Night Shot] in [Scene Mode].
- The setting is fixed to [OFF] in [Panorama Shot] and [3D Photo Mode] Scene Mode and [High Speed Video] in [Creative Video Mode].
- Cases where Optical Image Stabilizer may be ineffective:
Heavy jitter, high zoom ratio (also in the Digital Zoom range), fast-moving objects, indoors or in dark locations (due to low shutter speed)



- For the setting procedures of the menu. (→25)

[AF Assist Lamp]

You can set the camera to automatically turn on the AF Assist Lamp in dark locations to make focusing easier.

■ Settings

[ON]: Lamp illuminated with halfway press of shutter button
(AF* appears)

[OFF]: Lamp off (taking pictures of animals in the dark, etc.)

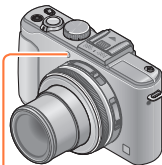

AF Assist Lamp

- The AF Assist Lamp has an effective distance of 1.5 m (4.9 feet).
 - Do not block the lamp with your fingers or look at it from close range.
- The function will turn [OFF] in the following cases.
 - Scene Modes ([Scenery] [Night Scenery] [Handheld Night Shot] [Sunset] [Glass Through])
 - [High Speed Video] in [Creative Video Mode]

[Flash]

For details (→107).



- For the setting procedures of the menu. (→25)

[Flash Synchro]

You can set the timing for firing the flash depending on the picture that you want to create.



■ Settings: [1ST] / [2ND]

Flash firing timing chart

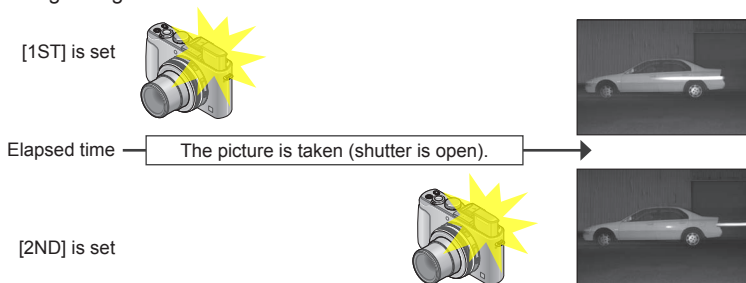

- Normally, set to [1ST].
- If you set to [2ND], [2nd] will be displayed in the flash icon on the screen.
- When a fast shutter speed is set, the Flash Synchro effect may not be sufficiently achieved.
- Flash Synchro can be used even when you use an external flash.

- For the setting procedures of the menu. (→25)

[Flash Adjust.]

You can adjust the intensity of the flash when you take a picture of a small subject, or when the flash reflectance is extremely high or low.



■ Settings: -2 EV to +2 EV (unit: 1/3 EV)

When you do not want to adjust the intensity of the flash, select [0 EV].



- When the intensity of the flash is adjusted, [+] or [-] is displayed on the flash icon.
- The flash intensity setting will be stored in memory even when the camera is turned off.

[Red-Eye Removal]

Automatically detects red-eye and corrects still picture data when recording with flash red-eye reduction (⚡A⊗ ⚡S⊗).



■ Settings: [ON] / [OFF]

- This setting will work only when [AF Mode] is  (Face Detection).
- Depending on the circumstance, it may not be possible to correct red-eye.
- When this function is set to [ON], the flash icon changes to /[.

- For the setting procedures of the menu. (→25)

[Color Mode]

For details (→53).

**[Motion Deblur]**

For details (→53).

**[iHandheld Nite Shot]**

For details (→53).

**[iHDR]**

For details (→54).

**[Opt. Viewfinder]**

You can set the LCD monitor display when the optional External Viewfinder is attached.

- **Settings: [ON] / [OFF]**

**[Aspect Bracket]**

For details (→122).



- For the setting procedures of the menu. (→25)

[Time Lapse Shot]



You can preset data such as recording start time and time lapse to take still pictures automatically. This setting is convenient for taking pictures at constant intervals for landscape scenes, observation of the gradual changes in animals/plants, and other applications.

■ Settings

[Start Time]:
Set the time to start recording. You can set the time in advance to start recording after a waiting period of up to 12 hours.

[Alert]:
: The camera notifies you of the start of recording by emitting a warning beep sound and flashing the AF Assist Lamp.
: The camera starts recording without notifying you of the start of recording.

[Shooting Interval]:
Set the time lapse. (Up to 30 minutes in 1-minute intervals)
 • There are cases where intervals of 5 minutes or more are required for some shutter speeds.

[Image Count]:
10 pictures, 20 pictures, 30 pictures, 40 pictures, 50 pictures and 60 pictures

■ About interval recording

When the shutter button is pressed fully, interval recording will start and the camera automatically takes pictures.

- During recording standby, the camera turns off automatically when no operation is performed for a preset interval. At the time to start recording or after the interval of recording time, the camera turns on automatically and the lens moves to the zoom position (focal length) to take a picture. (Do not attach the lens cap during recording standby.)
- When the camera ON/OFF switch is set to [OFF], interval recording will end. To continue interval recording, leave the camera ON/OFF switch to [ON].

- Pictures taken using interval recording cannot be stored in the built-in memory.
- The interval recording function is not intended for application-specific systems (monitoring cameras).
- If you leave the camera unattended during interval recording, make sure that the camera is not stolen.
- Exercise caution when you perform interval recording for a long period of time in cold regions or in a low-temperature or high-temperature/high-humidity environment, since such use could cause malfunctions.
- There is a possibility of the camera moving when it automatically turns on or off, for example, when the lens is retracting into the camera housing. We recommend fixing the camera to a tripod or using other methods on a stable surface when you take pictures using interval recording. Make sure that the camera does not topple over because of wind or other causes.
- This function cannot be used for recording motion pictures.
- Use a fully charged battery.
- Interval recording will be interrupted and the setting will be canceled in the following cases.
 - When the remaining battery power runs out
 - When the maximum number of pictures that can be recorded has been reached
- Do not connect the AV cable (optional), HDMI mini cable (optional), and USB connection cable during interval recording.

- For the setting procedures of the menu. (→25)

[Date Stamp]

Still pictures can be taken with the recording date and time stamped on the still picture.



■ Settings: [W/O TIME] / [WITH TIME] / [OFF]

- Date stamps on still pictures cannot be erased.
- The date cannot be stamped when [Auto Bracket], [WB Bracket], [Aspect Bracket] or [Burst Shooting] is set, or when the [Panorama Shot] or [3D Photo Mode] Scene Mode is set.
- Do not request date printing in store or make date printing on printer for still pictures with date stamps. (Date printing may be overlapped.)
- Cannot change the setting in [Intelligent Auto] Mode. The setting in other Recording Mode is applied.

[Clock Set]

Set the clock. Same function as that in [Setup] menu. (→24)



Using the [Motion Picture] menu

Items on the [Rec] menu and [Motion Picture] menu with the same names have the same functions. If a setting in one menu is changed, the setting with the same name in other menu will also be changed automatically.

- See the corresponding [Rec] menu item for details.
- For the setting procedures of the menu. (→25)

[Rec Mode]

Sets the data format of the motion picture that is recorded.



■ Settings

[AVCHD]	This is a data format suitable for playback on high-definition TVs.
[MP4]	This data format is suited for playing back motion pictures on a computer and other such devices.

- For details (→84)

[Rec Quality]

Sets the picture quality of the motion picture that is recorded.



■ Settings

[AVCHD] in [Rec Mode]

Item	Picture size/Bit rate	fps	Aspect ratio
[PSH]	1920×1080 pixels/Approx. 28 Mbps	60p	16:9
[FSH]	1920×1080 pixels/Approx. 17 Mbps	60i	
[SH]	1280×720 pixels/Approx. 17 Mbps	60p	

[MP4] in [Rec Mode]

Item	Picture size/Bit rate	fps	Aspect ratio
[FHD]	1920×1080 pixels/Approx. 20 Mbps	30	16:9
[HD]	1280×720 pixels/Approx. 10 Mbps		4:3
[VGA]	640×480 pixels/Approx. 4 Mbps		

- Bit rate is the data volume for a given period of time. The bigger the volume, the higher the picture quality. This unit uses the “VBR” recording method. “VBR” is an abbreviation of “Variable Bit Rate”, and the bit rate (volume of data for definite period of time) is changed automatically depending on the subject to record. Therefore, the recording time is shortened when a subject with fast movement is recorded.
- The aspect ratio of motion pictures is set using [Rec Quality]. The aspect ratio of motion pictures will not be changed even if you operate the aspect ratio selector switch.
- You can record motion pictures to the built-in memory only in [VGA] mode.

- For the setting procedures of the menu. (→25)

[Continuous AF]

Either allow the focus to be constantly adjusted during motion picture recording, or fix the focus position at the start of recording.



■ Settings

[ON]

[OFF]: Fix focus position at the start of motion picture recording.

[Wind Cut]

Automatically detects wind sounds (wind noise) captured by the microphone and suppresses the sound if the wind is blowing too strongly.



■ Settings: [AUTO] / [OFF]

- When [Wind Cut] is set to [AUTO], the sound quality may differ from that of normal recordings.

Viewing your pictures [Normal Play]

When a card is in the camera, pictures are played back from the card. Without a card, pictures are played back from the built-in memory.

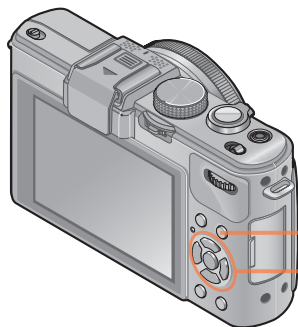

1 Press the playback button



The camera switches to the playback mode.

2 Press ◀▶ to select a picture to be displayed



- When you press and hold the button, the pictures are displayed one after another.
- You can also rotate the rear dial to select a picture.



File number

Picture number/Total pictures

■ To end playback

Press the playback button again.

- If [Start Mode] in the [Setup] menu is set to [▶], the camera is activated in playback mode when the camera is turned on. You can also activate the camera in playback mode if the camera is turned on while pressing the playback button, even when the menu is set to [📷].
- It may not be possible to view pictures on this camera that were previously edited on a computer.
- When the camera is switched to playback mode, the lens barrel will be retracted into the camera housing after approx. 15 seconds.
- This camera is compliant with the unified DCF (Design rule for Camera File system) standard formulated by the Japan Electronics and Information Technology Industries Association (JEITA), and with Exif (Exchangeable image file format). Files that are not DCF-compliant cannot be played back.

Zooming in and viewing “Playback zoom”

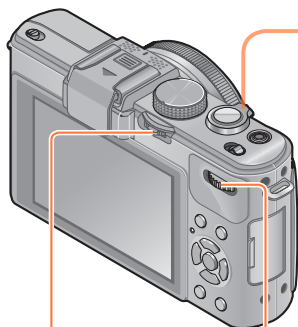

[ND/FOCUS] lever

Rear dial

1 Turn the zoom lever toward the T side to enlarge the picture

Current zoom position
(Appears for 1 second)

Each time you turn the zoom lever toward the T side, the camera magnifies the selected area by 2x, 4x, 8x, and 16x in succession. (The picture quality displayed becomes successively lower.)

- Move zoom position → Press ▲ ▼ ◀ ▶
- To reduce zoom
→ Turn lever towards W side

● Playback zoom cannot be used during motion picture playback.

■ Switching the displayed picture without changing the zoom ratio and position of Playback zoom

Rotate the rear dial during Playback zoom.

- When you display pictures with different picture sizes and aspect ratios or pictures that are rotated when they are displayed, the zoom position returns to the center.

■ Enlarging the focus point

Press the [ND/FOCUS] lever.

- Pictures recorded without adjusting focus or recorded with Manual Focus are not enlarged on the screen.

Viewing a list of pictures “Multi Playback”

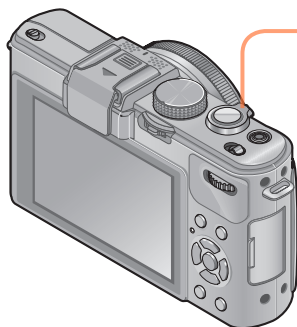

1 Turn the zoom lever toward the **W** side to display pictures in a list



Picture no./Total no.

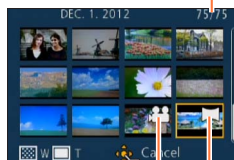

Motion pictures

Panorama pictures (→76)

- Move the zoom lever further toward the W side and you can switch the display methods in the following order: 12-picture screen → 30-picture screen → Calendar playback. (Turn the lever to the T side to return.)
- When you select a picture using the cursor button and press [MENU/SET] on the 12-picture or 30-picture screen, the selected picture is displayed on the 1-picture screen (full-screen).

● Pictures displayed with [!] cannot be played back.

Viewing pictures by their recording date “Calendar Playback”

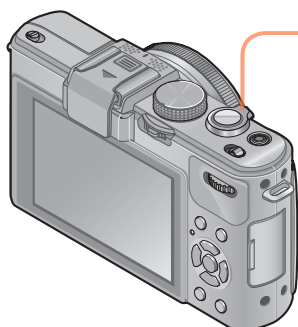

- 1** Turn the zoom lever toward the W side to display the calendar screen while displaying a 30-picture screen

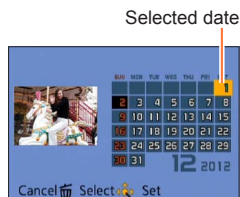

- When you select a recording date using the cursor button and press [MENU/SET], the display method changes to the 12-picture screen.

- Only months when pictures were taken are shown on the calendar screen. If the clock was not set, pictures will be displayed as January 1st, 2012. If the date / time was set incorrectly, pictures will be displayed with the incorrect settings.
- Pictures taken with destination settings made in [World Time] are displayed in the calendar screen using the appropriate date for the destination's time zone.

Playing back pictures recorded in burst and interval recording

Still pictures taken in a sequence using the [40] or [60] burst setting or pictures taken using interval recording are grouped together when they are displayed. (Group display)

■ Representative picture display

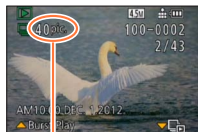

Number of burst pictures

When these pictures are displayed together with other still pictures or motion pictures, a representative picture (the first picture recorded using burst or interval recording) is displayed.

- You can delete or edit all the still pictures in a group at once.

: Burst pictures

: Pictures recorded in interval recording

■ Displaying pictures in a group



When you press ▼ while a representative picture is being displayed, only a series of still pictures recorded using burst or interval recording will be displayed.

- Only pictures grouped together are displayed.
- To return to the representative screen display → Press ▼.

■ Playback for burst pictures/Continuous playback

Press ▲ to play back a series of pictures one after another.

- Regarding playback for burst pictures/continuous playback, refer to the operations during motion picture playback. (→159)

■ About retrieving group information

When the power is turned on, the (acquiring information icon) may appear.

While is displayed, pictures cannot be deleted and the [Playback] menu cannot be used. Only [Normal Play] or [Calendar] is available as the [Playback Mode].

- When pictures set to [Favorite] are played back using [Slide Show] or [Filtering Play], the pictures cannot be displayed in a group.
- The following operation cannot be performed while a representative first burst picture is being displayed.
 - [Auto Retouch]
 - [Creative Retouch]
 - [Cropping] of [Playback] menu
 - [Leveling] of [Playback] menu
- Still pictures taken subsequently using burst or interval recording are not combined together to form a group after the total number of still pictures exceeds 50,000. Also, if there is only one picture left in a group because the other pictures were deleted or for some other reason, no group is formed.
- Pictures recorded using other cameras may not be recognized as a group picture.
- Pictures recorded without setting the clock are not combined together to form a group.

About panorama playback

Still pictures recorded with [Panorama Shot] Scene Mode are displayed in small size on a normal playback screen because the entire picture is displayed on the screen.

■ Enlarged display

You can use the Playback zoom function to enlarge a picture. (→153)

■ Automatic scrolling display of panorama pictures

When you press ▲, the camera automatically scrolls a panorama picture from edge to edge in enlarged display mode just like playing back a motion picture.

- Operations during panorama picture scrolling playback

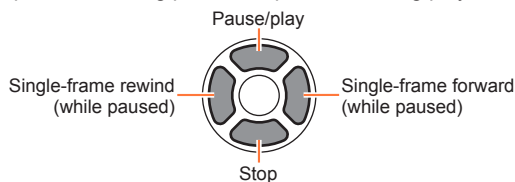

Viewing motion pictures

This unit was designed to play motion pictures using the AVCHD, MP4 and QuickTime Motion JPEG formats.

1 Select a picture with the motion picture icon ([AVCHD PSH], [MP4 FHD] etc.), and press ▲

Playback now starts.



Motion picture icon

Motion picture recording time

When playback starts, the elapsed playback time is displayed in the top right of the screen.

Example: After 3 minutes and 30 seconds: [3m30s]

■ Operations during motion picture playback

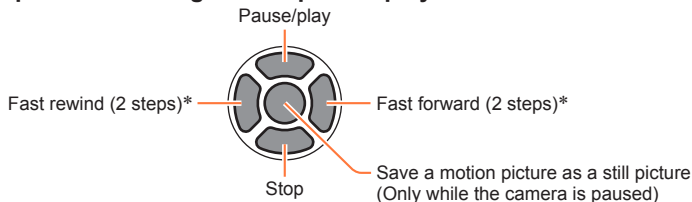

* Single-frame forward/single-frame rewind can be performed while paused.

● Volume can be adjusted with the zoom lever.

- It may not be possible to properly play back motion pictures recorded using other cameras.
- Some information will not be displayed for motion pictures recorded in [AVCHD].
- Motion pictures can be viewed on your computer using "PHOTOfunSTUDIO" on the supplied CD-ROM.
- Motion pictures recorded with [Miniature Effect] in [Creative Control] Mode play back at approximately 10x speed.

Capturing still pictures from motion pictures

Save a scene from a motion picture as a still picture.

1 Display the picture that you want to capture as a still picture by pausing a motion picture during playback

2 Press [MENU/SET]



- A confirmation screen is displayed.
Use cursor button to select [Yes] to save a still picture.

[Rec Quality] of the original motion picture	[Picture Size]	Aspect ratio
[PSH] [FSH] [SH] [FHD] [HD]	2M	16:9
[VGA]	0.3M	4:3

- The picture quality becomes slightly lower depending on the [Rec Quality] setting of the original motion picture.
- It may not be possible to capture still pictures from motion pictures that were recorded with a different camera.

Splitting up motion pictures

A single motion picture can be split into 2 parts. This is convenient when you want to keep just the necessary scenes, or if you wish to delete unnecessary scenes to increase free space on your card, such as when traveling.

1 Select [Video Divide] from [Playback] menu

- For the setting procedures of the menu. (→25)

2 Select the motion picture to split with cursor button and then press [MENU/SET]

3 Press ▲ at where you want to split a motion picture to pause it

4 Press ▼



- A confirmation screen is displayed. Select [Yes] with cursor button, and press [MENU/SET].
- **The original motion picture that was split does not remain.**
(There will only be the 2 motion pictures that were created after the split.)

- During splitting, do not turn off the camera or remove the card or battery. If you do so, the motion picture may be deleted.
- Splitting a motion picture recorded in [MP4] changes the order of the pictures. It is recommended to display with [Calendar] (Calendar Playback) or [Filtering Play].
- It may not be possible to split motion pictures that were recorded with a different camera.
- Motion pictures with a short recording time cannot be divided.

Changing the picture information display, etc.

You can disable the display of picture information (file number, etc.) and recording information (settings used for recording, etc.) when a picture is played back.

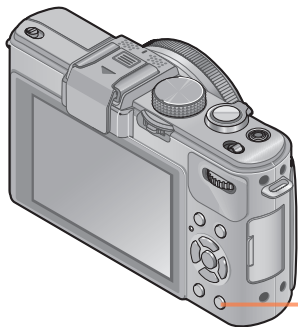

1 Press [DISP.] button to switch the display

DISP. Every time you press the button, the display will be switched.

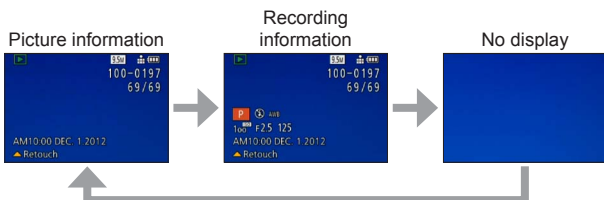

Deleting pictures

Pictures will be deleted from the card if the card is inserted, or from the built-in memory if the card is not inserted. (Deleted pictures cannot be recovered.)

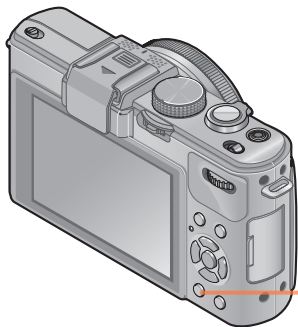

1 Press [🗑️/↩️] button to delete displayed picture

Q.MENU



- A confirmation screen is displayed. Select [Yes] with cursor button, and press [MENU/SET].

- Do not turn off the power during deletion.
- Use a sufficiently charged battery or an AC adaptor (optional) and DC coupler (optional).
- Pictures cannot be deleted in the following cases:
 - Protected pictures
 - Card switch is in "LOCK" position.
 - Pictures not of DCF standard (→152)

To delete multiple (up to 100)/To delete all pictures

When you select a representative picture of a still picture group recorded using burst or interval recording, the group is deleted as a single picture. (All the pictures in the selected group are deleted.)

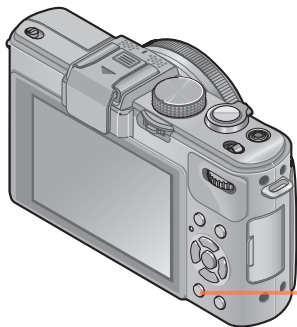

1 Press [🗑️/↶] button to delete displayed picture

Q.MENU



2 Press ▼ to select [Delete Multi]/[Delete All] and press [MENU/SET]



● [Delete Multi]

- ① Use cursor button to select picture and press [DISP.] button

 Picture selected

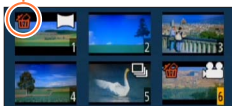

- To cancel → Press [DISP.] button again.
- ② Press [MENU/SET]
- You can select [All Delete Except Favorite] in [Delete All] if there are pictures that have been set as [Favorite] (→178).
- A confirmation screen is displayed. Select [Yes] with cursor button and then press [MENU/SET].
- May take time depending on number of pictures deleted.

Different playback methods [Playback Mode]

Recorded pictures can be played back in a variety of ways.

- For the setting procedures of the menu. ([→25](#))

[2D/3D Settings]	Switches the output format between 2D and 3D pictures. (Only available during HDMI output.)
[Normal Play]	Plays back all pictures.
[Slide Show]	Automatically plays back recorded pictures, one after another.
[Filtering Play]	Plays back the pictures after narrowing them down according to various conditions.
[Calendar]	Displays the pictures according to the date on which they were taken.

[2D/3D Settings]

The playback method for the 3D pictures can be switched. This menu is only displayed during HDMI output. For the procedure for playing back a 3D still picture ([→187](#)).

- For the setting procedures of the menu. (→25)

[Slide Show]

Automatically play pictures in order and to music. Recommended when viewing on TV screen.

1 Use cursor button to select the playback method and press [MENU/SET]

[All]	Play all.
[Picture Only]	Plays back still pictures.
[Video Only]	Plays back motion pictures.
[3D Play]	Plays back 3D still pictures recorded using [3D Photo Mode] Scene Mode only.
[Category Selection]	Select category and play back motion or still pictures. (Select category with cursor button and press [MENU/SET].) (→168)
[Favorite]	Play back pictures set as [Favorite]. (→178)

2 Use cursor button to set playback effects and press [MENU/SET]

[Effect] (Select music and effects according to picture atmosphere)	
[AUTO] (only available with [Category Selection] setting) / [NATURAL] / [SLOW] / [SWING] / [URBAN] / [OFF]	
[Setup]	
[Duration]*	[1 SEC.] / [2 SEC.] / [3 SEC.] / [5 SEC.]
[Repeat]	[ON] / [OFF]
[Sound]	[AUTO]: With still pictures, music will play back, and with motion pictures, audio will play back. [Music]: Music effect will play back. [Audio]: Audio is played back from motion pictures. [OFF]: Music and audio will not play back.

* This effect can be set only when [Effect] is set to [OFF]. Note, however, that the [Duration] setting will not be effective in the following cases.

- Motion pictures
- Panorama pictures
- Group of still pictures taken sequentially with a [40] or [60] burst setting or pictures taken using interval recording

(Continued on the next page)

3 Use cursor button to select [Start] and press [MENU/SET]

■ Operations during Slide Show

The operation guide appears on the bottom right of the LCD monitor.



* Only while the camera is paused when playing back still pictures

- When [URBAN] has been selected, the picture may appear in black and white as a screen effect.
- Part of [Effect] cannot be used when displaying pictures on television using an HDMI mini cable (optional) or when displaying pictures recorded in portrait position.
- Screen effects do not operate during a [3D Play] slide show.
- Music effects cannot be added.

- For the setting procedures of the menu. (→25)

[Filtering Play]

You can select and display pictures that you want to play back, for example, pictures in any category or your favorite pictures.

1 Press ▲▼ to select the playback method and press [MENU/SET]

[Picture Only]	Play back still pictures.																						
[Video Only]	Play back motion pictures.																						
[3D Play]	Play back only pictures that were recorded using [3D Photo Mode] Scene Mode.																						
[Category Selection]	Use cursor button to select a category of pictures to be played back and press [MENU/SET]. <table border="1" data-bbox="336 589 966 953"> <tr> <td></td> <td>Pictures taken using Face Recognition</td> </tr> <tr> <td></td> <td>[Portrait] / / [Soft Skin] / [Night Portrait] / / [Baby] / </td> </tr> <tr> <td></td> <td>[Scenery] / / [Panorama Shot] / [Sunset] / / [Glass Through]</td> </tr> <tr> <td></td> <td>[Night Portrait] / / [Night Scenery] / / [Handheld Night Shot] / </td> </tr> <tr> <td></td> <td>[Sports]</td> </tr> <tr> <td></td> <td>[Baby] / </td> </tr> <tr> <td></td> <td>[Pet]</td> </tr> <tr> <td></td> <td>[Food]</td> </tr> <tr> <td></td> <td>[Travel Date]</td> </tr> <tr> <td></td> <td>[Burst Shooting] ([60] or [60]) only</td> </tr> <tr> <td></td> <td>Interval recording</td> </tr> </table>		Pictures taken using Face Recognition		[Portrait] / / [Soft Skin] / [Night Portrait] / / [Baby] /		[Scenery] / / [Panorama Shot] / [Sunset] / / [Glass Through]		[Night Portrait] / / [Night Scenery] / / [Handheld Night Shot] /		[Sports]		[Baby] /		[Pet]		[Food]		[Travel Date]		[Burst Shooting] ([60] or [60]) only		Interval recording
	Pictures taken using Face Recognition																						
	[Portrait] / / [Soft Skin] / [Night Portrait] / / [Baby] /																						
	[Scenery] / / [Panorama Shot] / [Sunset] / / [Glass Through]																						
	[Night Portrait] / / [Night Scenery] / / [Handheld Night Shot] /																						
	[Sports]																						
	[Baby] /																						
	[Pet]																						
	[Food]																						
	[Travel Date]																						
	[Burst Shooting] ([60] or [60]) only																						
	Interval recording																						
[Favorite]	Play back pictures set as [Favorite].																						

- When the camera is turned off or when the camera is switched to a recording mode, normal playback is resumed.

[Calendar]

Select the date from the calendar screen to view only the pictures taken on that day. (→155)

Retouching pictures

[Auto Retouch]

You can adjust the color and brightness of a still picture to bring them into balance.

- New pictures are created after editing pictures with [Auto Retouch]. Before starting to edit, make sure that there is enough free space in the built-in memory or on the memory card.



• Example picture

1 Select a still picture to retouch during playback and press **▲**

2 Use cursor button to select [Auto Retouch] and press [MENU/SET]

3 Use cursor button to select [ON] and press [MENU/SET]

- A confirmation screen is displayed. If you select [Yes], the new retouched still picture is saved.
- When [OFF] is selected, you can restore a picture to its original condition (before retouching).

- The retouch effect may be less apparent in some still pictures.
- Some still pictures may have higher noise levels after retouching.
- It may not be possible to use [Auto Retouch] with still pictures that have already been retouched.
- It may not be possible to retouch still pictures recorded with other cameras.
- [Auto Retouch] is unable to perform in the following cases:
 - Motion pictures
 - Still pictures recorded in [Panorama Shot] Scene Mode
 - 3D still pictures

[Creative Retouch]

You can retouch recorded still pictures by selecting the effect that you want to apply.

- New pictures are created after editing pictures with [Creative Retouch]. Before starting to edit, make sure that there is enough free space in the built-in memory or memory card.

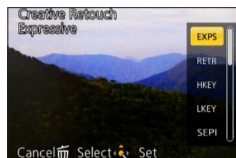
1 Select a still picture to retouch during playback and press ▲**2 Use cursor button to select [Creative Retouch] and press [MENU/SET]****3 Press ▲ ▼ to select a setting**

- The picture retouched with the selected effect is displayed.

See the corresponding picture effects of [Creative Control] Mode. You cannot adjust effects other than brightness under [Toy Effect] and [Cross Process].

- [Expressive] / [Retro] (→66)
- [High Key] / [Low Key] (→67)
- [Sepia] / [Dynamic Monochrome] (→68)
- [Impressive Art] / [High Dynamic] (→69)
- [Cross Process] / [Toy Effect] (→70)
- [Miniature Effect] (→71)
- [Soft Focus] / [Star Filter] (→72)
- [One Point Color] (→73)
- When [OFF] is selected, you can restore a picture to its original condition (before retouching).

4 Press [MENU/SET]

- A confirmation screen is displayed. If you select [Yes], the new retouched still picture is saved.

- The retouch effect may be less apparent in some still pictures.
- The image effect may appear weak compared to the effect given by the [Creative Control] Mode.
- It may not be possible to retouch still pictures recorded with other cameras.
- [Creative Retouch] is unable to be performed in the following cases:
 - Motion pictures
 - Still pictures recorded in [Panorama Shot] Scene Mode
 - 3D still pictures

Using the [Playback] menu

You can set the recorded picture to upload to the image-sharing websites, edit the picture (for example, trimming), and set a protection setting in the picture.

- For the setting procedures of the menu. (→25)

- New pictures are created after editing pictures with tools such as [Text Stamp] and [Resize]. Before starting to edit, make sure that there is enough free space in the built-in memory or memory card.
- It may not be possible to set or edit pictures taken with other cameras.

[Upload Set]

You can select pictures on the camera for uploading to image-sharing websites (Facebook or YouTube).

- You can only upload motion pictures to YouTube, while you may upload both motion pictures and still pictures to Facebook.
- Pictures on the built-in memory cannot be set. Copy pictures to a card (→182) before making [Upload Set] settings.

1 Use cursor button to select [Single] or [Multi] and press [MENU/SET]

2 Select picture and make setting

• [Single]

- ① Use cursor button to select picture and press [MENU/SET]



Web upload setting

- To cancel
→ Press [MENU/SET] again.

• [Multi]

- ① Use cursor button to select picture and press [DISP.] button

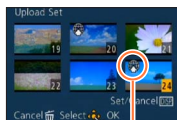

Web upload setting

- To cancel
→ Press [DISP.] button again.

② Press [MENU/SET]

- Confirmation screen is displayed. If you select [Yes], the operation is executed.

■ Uploading to image-sharing websites

When setting [Upload Set], the built-in uploading tool automatically makes copies on the card inside the camera. Connect the camera to your computer (→191) before performing uploading operations. For more details, refer to (→194).

■ To clear all

Select [Cancel] in step **1** and select [Yes].

- Not available on cards with less than 512 MB.

- For the setting procedures of the menu. (→25)

[Title Edit]

You can give titles, etc. to your favorite still pictures.

1 Use cursor button to select [Single] or [Multi] and press [MENU/SET]

2 Select a still picture

- [Single]

- ① Use cursor button to select a still picture and press [MENU/SET]



- [Multi]

(up to 100 pictures with the same text)

- ① Use cursor button to select a still picture and press [DISP.] button

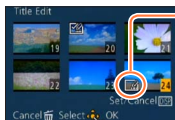

- [Title Edit] setting
- [Title Edit] already set
- To cancel
 - Press [DISP.] button again.

- ② Press [MENU/SET]

3 Enter characters (Entering text (→44))

- To delete a title, delete all the characters in the character input screen.

- Cannot be used in the following cases:

- Motion pictures
- 3D still pictures

- To print text, use [Text Stamp] or "PHOTOfunSTUDIO" software on the supplied CD-ROM.

- For the setting procedures of the menu. (→25)

[Text Stamp]

The recording date and time and the text registered in the [Baby], [Pet] Scene Modes, [Travel Date] and [Title Edit] are stamped on the still picture.

1 Use cursor button to select [Single] or [Multi] and press [MENU/SET]

2 Select a still picture

● [Single]

- ① Use cursor button to select a still picture and press [MENU/SET]



● [Multi] (up to 100 pictures)

- ① Use cursor button to select a still picture and press [DISP.] button



- ② Press [MENU/SET]



3 Use cursor button to select items and press ► (→174)

4 Use cursor button to select settings and press [MENU/SET] (→174)

5 Press [MENU/SET]

- Confirmation screen is displayed. If you select [Yes], the operation is executed.

■ Items that can be stamped

[Shooting Date]	[W/O TIME]: Stamp recording date [WITH TIME]: Stamp recording date and time
[Name]	 Stamp name registered in Face Recognition  Stamp name registered in [Baby] or [Pet]
[Location]	Stamp location registered in [Setup] menu's [Travel Date]
[Travel Date]	Stamp Travel Date set in [Setup] menu's [Travel Date]
[Title]	Stamp text registered in [Title Edit]

- Items set to [OFF] are not stamped.

- Cannot stamp texts on the following pictures.
 - Motion pictures
 - 3D still pictures
 - Still pictures recorded in [Panorama Shot] Scene Mode
 - Still pictures that date or other texts had already been stamped
 - Still pictures taken without setting clock
- Characters may be cut off on certain printers.
- Text is difficult to read when stamped on pictures of 0.3 M or less.
- **Do not request date printing in store or make date printing on printer for still pictures with date stamps. (Date printing may be overlapped.)**

- For the setting procedures of the menu. (→25)

[Video Divide]

For details (→161).

- For the setting procedures of the menu. (→25)

[Resize]

Picture size can be reduced to facilitate e-mail attachment and use in web pages, etc. (Still pictures recorded at the smallest recording pixel level of each picture aspect ratio such as [0.3M] cannot be reduced further.)

1 Use cursor button to select [Single] or [Multi] and press [MENU/SET]

2 Select picture and make setting

● [Single]

- ① Use cursor button to select a still picture and press [MENU/SET]
- ② Use cursor button to select size and press [MENU/SET]

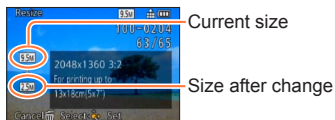

Confirmation screen is displayed. If you select [Yes], the operation is executed.

● [Multi]

- ① Use cursor button to select size and press [MENU/SET]
- ② Use cursor button to select a still picture and press [DISP.] button (up to 100 pictures)
- ③ Press [MENU/SET]

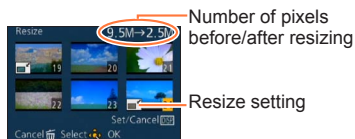

Confirmation screen is displayed. If you select [Yes], the operation is executed.

● Picture quality is reduced after resizing.

● Cannot resize the following pictures.

- Motion pictures
- 3D still pictures
- Still pictures recorded in [Panorama Shot] Scene Mode
- Still pictures that date or other texts had already been stamped

- For the setting procedures of the menu. (→25)

[Cropping]

Enlarge your still pictures and crop unwanted areas.

1 Use cursor button to select a still picture and press [MENU/SET]

2 Use the zoom lever to enlarge the portion of a still picture to be cropped and press [MENU/SET]



Expand



Change position

- Confirmation screen is displayed. If you select [Yes], the operation is executed.

- Picture quality is reduced after cropping.
- Cannot crop the following pictures.
 - Motion pictures
 - 3D still pictures
 - Still pictures recorded in [Panorama Shot] Scene Mode
 - Still pictures that date or other texts had already been stamped
- Original Face Recognition information will not be copied when still pictures are cropped.

- For the setting procedures of the menu. (→25)

[Leveling]

Slight slanting in the still picture can be corrected.

1 Use cursor button to select a still picture and press [MENU/SET]

2 Press ◀▶ to adjust the skewed angle of view and then press [MENU/SET]

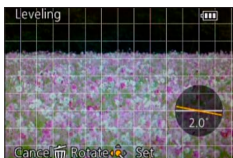

- Confirmation screen is displayed. If you select [Yes], the operation is executed.

- Picture quality is reduced when leveling is performed.
- The resulting still picture may have fewer recording pixels than the original still picture when leveling is performed.
- May not be compatible with still pictures taken on other devices.
- A skewed angle of view for the following pictures cannot be corrected.
 - Motion pictures
 - 3D still pictures
 - Still pictures recorded in [Panorama Shot] Scene Mode
 - Still pictures that date or other texts had already been stamped
- The personal information related to Face Recognition recorded in an original still picture will not be copied to the pictures after their skewed angle of view is corrected.

- For the setting procedures of the menu. (→25)

[Favorite]

By labeling your favorite pictures with a star (★), you can play back your favorite pictures only, or you can delete all pictures except your favorites.

1 Use cursor button to select [Single] or [Multi] and press [MENU/SET]

2 Use cursor button to select picture and press [MENU/SET]

- [Single]



Favorite picture setting

- [Multi]

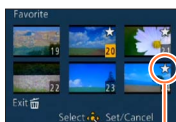

Favorite picture setting

- To cancel → Press [MENU/SET] again.

■ To clear all

Select [Cancel] in step **1** and select [Yes].

- For the setting procedures of the menu. (→25)

[Print Set]

Picture/picture no./date printing settings can be made for when printing with DPOF print-compatible shops or printers. (Ask at the shop to check for compatibility.)

For more information visit:

http://panasonic.jp/dc/dpof_110/white_e.htm

1 Use cursor button to select [Single] or [Multi] and press [MENU/SET]

2 Use cursor button to select picture and press [MENU/SET]

3 Use cursor button to set number of pictures and press [MENU/SET]

(repeat steps **2** and **3** when using [Multi] (up to 999 pictures))

● [Single]

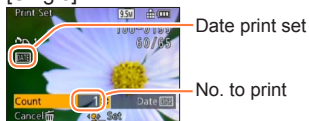

● [Multi]

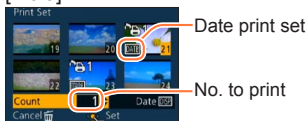

- Date print setting/release → Press [DISP.] button.

■ To clear all

Select [Cancel] in step **1** and select [Yes].

- Depending on the type of printer, the printer settings may take priority over camera settings.
- Cannot be set for files that are not compliant with the DCF standard.
- Some DPOF information set by other equipment cannot be used. In such cases, delete all of the DPOF information and then set it again with this camera.
- Date print setting cannot be made for still pictures that have been taken with [Date Stamp] and pictures with a [Text Stamp] applied.
- Print setting cannot be made for motion pictures.

- For the setting procedures of the menu. (→25)

[Protect]

Set protection to disable picture deletion. Prevents deletion of important pictures.

1 Use cursor button to select [Single] or [Multi] and press [MENU/SET]

2 Use cursor button to select picture and press [MENU/SET]

● [Single]



Picture protected

● [Multi]

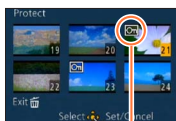

Picture protected

- To cancel → Press [MENU/SET] again.

■ To clear all

Select [Cancel] in step **1** and select [Yes].

- May not be effective when using other devices.
- The picture is erased when formatting, even if it is protected.
- When you set the write-protect switch on the card to the "LOCK" position, the picture is not erased.

- For the setting procedures of the menu. (→25)

[Face Rec Edit]

Edit or delete the recognition information for pictures with mistaken Face Recognition.

- 1 Use cursor button to select [REPLACE] or [DELETE] and press [MENU/SET]**
- 2 Use cursor button to select the picture and press [MENU/SET]**
- 3 Use cursor button to select a person and press [MENU/SET]**
 - If [DELETE], go to step **5**.
 - People whose Face Recognition information has not been registered cannot be selected.
- 4 Use cursor button to select the person to replace for another and press [MENU/SET]**
- 5 Use cursor button to select [Yes] and press [MENU/SET]**

- When Face Recognition information is deleted, it cannot be restored.
- Pictures for which all Face Recognition information has been deleted are not categorized in Face Recognition during [Category Selection].
- Recognition information cannot be edited in protected pictures.

- For the setting procedures of the menu. (→25)

[Copy]

You can copy pictures between built-in memory and memory card.

■ Copy all pictures from built-in memory to card

1 Use cursor button to select [IN→SD] and press [MENU/SET]

- Confirmation screen is displayed. If you select [Yes], the operation is executed.

■ Copy 1 picture at a time from card to built-in memory

1 Use cursor button to select [SD→IN] and press [MENU/SET]

2 Use cursor button to select picture and press [MENU/SET]

- Confirmation screen is displayed. If you select [Yes], the operation is executed.

- Copying pictures may take several minutes. Do not turn off power or perform other operations during copying.
- If identical names (folder/file numbers) are present in the copy destination, a new folder for copying will be created when copying from built-in memory to card (IN→SD). Identically-named files will not be copied from card to built-in memory (SD→IN).
- The following settings are not copied. Set them again after copying.
 - [Print Set] - [Protect] - [Favorite]
- Only pictures from Panasonic digital cameras (LUMIX) may be copied.
- Motion pictures recorded in [AVCHD] format cannot be set.

Viewing on TV screen

You can view pictures on a TV screen by connecting your camera to your TV with the HDMI mini cable (optional) or AV cable (optional).

- Also consult TV operating manual.

Preparation:

- Set [TV Aspect] to connect your camera to a TV using the AV cable (optional) (→39)
- Turn off both camera and TV.

1 Connect camera to TV

■ To connect with an HDMI mini cable (optional)

An HDMI mini cable (optional) can be used to enable viewing of still and motion pictures in high resolution.

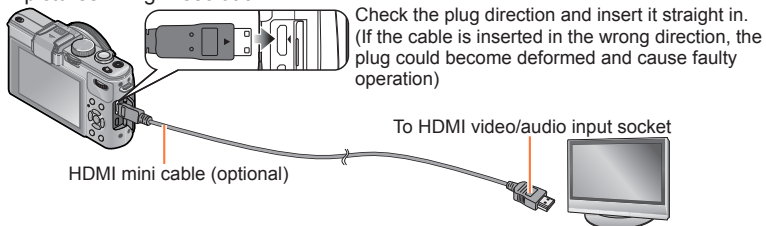

■ To connect with an AV cable (optional)

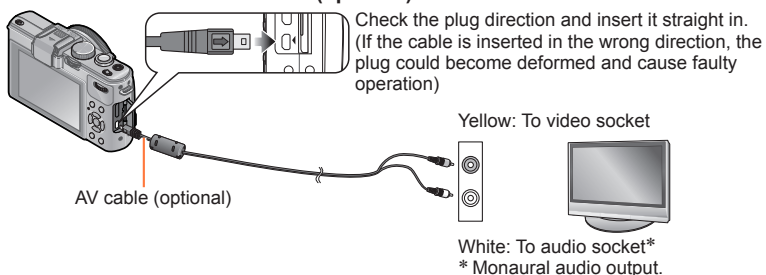

2 Turn on TV

- Set to auxiliary input.

3 Turn on the camera and press the playback button

■ To connect with an HDMI mini cable (optional)

- Always use a genuine Panasonic HDMI mini cable (optional).
- There are restrictions on some playback functions.
- Bars may appear at the sides or at the top and bottom of the screen, depending on the aspect ratio setting.
- When an HDMI mini cable is connected, pictures are not displayed on the LCD monitor.
- HDMI output will be canceled if a USB connection cable is connected simultaneously.
- When the AV cable (optional) and HDMI mini cable (optional) are connected at the same time, no picture is output from the AV cable.
- Pictures may be momentarily distorted immediately after commencing playback or pausing on certain televisions.
- Audio output is stereo.

■ To connect with an AV cable (optional)

- Always use a genuine Panasonic AV cable (optional).
- Pictures rotated to portrait may be blurred slightly.
- Change picture mode settings on TV if aspect ratios are not displayed correctly on widescreen or high-definition televisions.

When you insert a card into the SD card slot in a television or a DVD recorder, you can play back recorded still pictures.

- For details, read the operating instructions for the television or other devices.
- AVCHD motion pictures can be played back on Panasonic televisions (VIERA) displaying the AVCHD logo.
- You may not be able to play back panorama pictures. Also you cannot perform automatic scrolling playback of panorama pictures.
- When using both SDHC and SDXC Memory Cards, be sure to play each type of card in equipment compatible with the particular format.

VIERA Link (HDMI) (HDAVI Control™)**What is VIERA Link (HDMI)?**

- VIERA Link™ is a new name for EZ Sync™.
- VIERA Link is a function that automatically links this camera to VIERA Link-compatible devices by connecting HDMI mini cables (optional) for enabling easy operation with the VIERA remote control. (Some operations are not available.)
- VIERA Link (HDMI) is an exclusive Panasonic function added to the industry-standard HDMI control functions known as HDMI CEC (Consumer Electronics Control). Operation is not guaranteed when connecting with non-Panasonic HDMI CEC-compatible devices. Refer to your product manual to verify compatibility with VIERA Link (HDMI).
- This camera supports VIERA Link (HDMI) Version 5. This is the latest Panasonic standard that also supports previous Panasonic VIERA Link devices. (As of November 2011)

- Always use a genuine Panasonic HDMI mini cable (optional).
- If you are unsure whether the TV you are using is compatible with VIERA Link, read the operating instructions for the TV.
- Cables that do not comply with HDMI standards will not work.
- If the [VIERA Link] setting on the camera is [ON], operations via the camera buttons will be limited.
- Ensure that the television you are connecting to has been set up to enable VIERA Link (HDMI) (consult your television operating instructions for details).

Preparation: Set [VIERA Link] to [ON] (→40).

- 1 Connect the camera to a VIERA Link (HDMI)-compatible Panasonic television (VIERA) with an HDMI mini cable (optional) (→183)**
- 2 Turn on the camera**
- 3 Press the playback button**
- 4 Proceed with the operation while referring to what is displayed on the TV screen**
 - When operating, refer to the VIERA Link operating panel.

■ Other related operations

- Power OFF

The camera's power can also be switched off when switching the television's power off with the remote control.

- Automatic input select

- This function automatically switches the television input to the camera screen whenever the camera's power is switched on while it is connected via the HDMI mini cable. The television can also be switched on via the camera from Standby Mode (if "Power on link" on the television is set to "on").
- If VIERA Link (HDMI) does not function correctly (→219)

Viewing 3D still pictures

If you connect this camera to a 3D-capable TV, and play back still pictures that you recorded in 3D, you can enjoy impressive 3D still pictures on the TV. If a 3D-capable TV has an SD card slot, you can play back 3D still pictures that you recorded by inserting the card into the slot.

For the latest information about devices that can play back 3D still pictures recorded with this camera, please refer to the following support website.

<http://panasonic.jp/support/global/cs/dsc/>

(This site is available in English only.)

Preparation: Set [3D Playback] to [3D] (→40).

1 **Connect the camera to a 3D-capable TV by use of an HDMI mini cable (optional) to display the playback screen** (→183)

2 **Display still pictures recorded in 3D**

- When the [VIERA Link] setting on the camera is set to [ON] and the camera is connected to a VIERA Link (HDMI)-compatible Panasonic television (VIERA), the television automatically switches its input and the playback screen is displayed.
- [3D] appears on the thumbnail of the 3D still pictures.

■ **To perform Slide Show playback of only still pictures recorded in 3D**

Select [3D Play] in [Slide Show] of the [Playback Mode] menu (→166)

■ **To select and play back only still pictures recorded in 3D**

Select [3D Play] in [Filtering Play] of the [Playback Mode] menu (→168)

■ **To switch the playback method for the still pictures recorded in 3D**

① Select the picture recorded in 3D

② Select [2D/3D Settings] on the [Playback Mode] menu and press [MENU/SET] (→165)

- Playback method will switch to 3D if it is playing back in 2D (conventional image), or it will switch to 2D if it is playing back in 3D.
- If you feel tired, uncomfortable or otherwise strange when playing back pictures recorded in 3D, set to 2D.

- When an image is not suitable for 3D viewing (due to excessive parallax, etc.)
 - During Slide Show playback: The image is displayed in 2D.
 - During [Filtering Play]: A message appears confirming whether to display the image in 3D or not.
- When a 3D image is played back on a TV that is not 3D-capable, 2 pictures may appear side-by-side on the screen.
- On the LCD monitor of this camera, 3D still pictures will be played back in 2D (conventional pictures).
- If you switch between 3D still pictures and normal still pictures while playing back pictures, a black screen will be displayed for a few seconds.
- If you select a thumbnail of 3D still pictures or display a thumbnail after playing back 3D still pictures, it may take a few seconds to start playing back or displaying the pictures.
- Viewing 3D still pictures too close to a TV may cause eyestrain.
- When a TV has not been converted for viewing 3D still pictures, do necessary preparation on the TV. (For details about the necessary preparation of the TV, read the manual for the TV.)
- The functions that are not operational or available for 3D still pictures:
 - [Setup] menu
 - [Playback] menu
 - Playback Zoom
 - Delete
- You can store 3D still pictures on a computer or Panasonic recorder. (→189)

Storing recorded still pictures and motion pictures

The methods for copying still and motion pictures recorded with this camera to other devices vary according to the file format (JPEG, RAW, MPO, AVCHD, MP4). Follow the correct method for your device.

Copying by inserting the SD card into the recorder

You can copy pictures using Panasonic equipment (such as Blu-ray disc recorders) with support for each file format.

Check the latest information about equipment that is compatible with this camera on the following website.

• **Note that the equipment described may not be available in certain countries and regions.**

<http://panasonic.jp/support/global/cs/dsc/>
(This site is available in English only.)

- See the instruction manual for the recorder for details for copying and playing back.

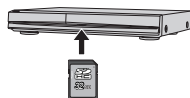

Dubbing playback pictures via AV cables (optional)

Videos that are played on this camera can be dubbed on media such as a disc, hard disk or videotape using a device such as a video recorder. This method is useful as it allows dubbing to be performed even with devices that are not compatible with high definition images. Picture quality will be reduced from high definition to standard definition. Audio will be monaural.

1 Connect camera to recorder

2 Start playback on camera

3 Start recording on recorder

- To stop recording (dubbing), stop the recording on your recorder first before stopping the playback on the camera.

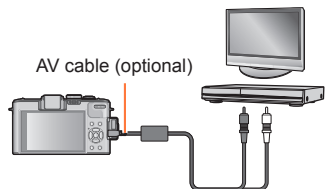

To recorder's input socket

- Always use a genuine Panasonic AV cable (optional).
- When using a TV with a 4:3 aspect ratio, always change the camera's [TV Aspect] setting (→39) to [4:3] before dubbing. Motion pictures copied in the 16:9 setting will appear vertically stretched when viewed on a 4:3 TV screen.
- For details on dubbing and playback methods, refer to your recorder's operating instructions.

Using “PHOTOfunSTUDIO” to copy to your computer

Using the “PHOTOfunSTUDIO” software on the supplied CD-ROM, you can save still pictures and motion pictures recorded with this camera in all file formats to a computer.

1 Install “PHOTOfunSTUDIO” on your computer

- For details about the software on the supplied CD-ROM, operation environment and installation, refer to Basic Owner’s Manual.

2 Connect the camera to your computer

- For connection procedures ([→191](#))

3 Use “PHOTOfunSTUDIO” to copy pictures to your computer

- For details on how to use “PHOTOfunSTUDIO”, see the “PHOTOfunSTUDIO” manual (PDF).

- Files and folders containing copied AVCHD motion pictures cannot be played back or edited if they have been deleted, modified, or moved using Windows Explorer or similar methods. Always use “PHOTOfunSTUDIO” when handling AVCHD motion pictures.

Using with your PC

Still/motion pictures can be copied from the camera to your computer by connecting the two together.

- Some computers can read directly from the camera's memory card.
For details, see the manual for your computer.
- If your computer does not support SDXC Memory Cards a message will be displayed requesting you to format the card. (Do not format the card. This will erase recorded pictures.) If the card is not recognized, refer to the following support website.
<http://panasonic.net/avc/sdcard/information/SDXC.html>

■ Computer specifications

You can connect the camera to a computer that can detect a mass storage device (device that stores a large volume of data).

- Windows: Windows 7 / Windows Vista / Windows XP
- Mac: OS X v10.1 - v10.7

Some motion pictures recorded in [AVCHD] may not be scanned correctly by copying a file or folder.

- When using Windows, be sure to use the "PHOTOfunSTUDIO" software on the supplied CD-ROM to copy motion pictures recorded in [AVCHD].
- When using Mac, you can copy motion pictures recorded in [AVCHD] using "iMovie '11". Note, however, that you cannot copy motion pictures (AVCHD Progressive) recorded when [Rec Quality] is set to [PSH]. (For details about iMovie '11, please contact Apple Inc.)

Copying still pictures and motion pictures recorded in [MP4] (except AVCHD motion pictures)

Preparation:

- Charge the battery sufficiently.
Or, connect the AC adaptor (optional) and DC coupler (optional).
- When importing pictures from the built-in memory, remove any memory cards.
- Turn on the camera and computer.

Check the plug direction and insert it straight in.
(If the cable is inserted in the wrong direction, the plug could become deformed and cause faulty operation)

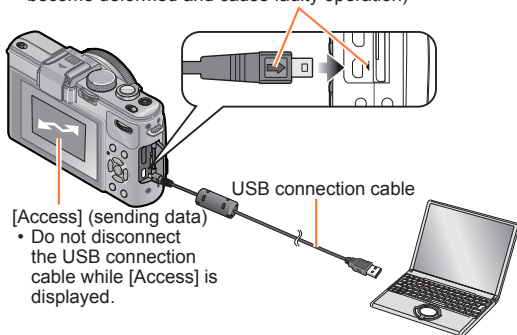

- [Access] (sending data)
- Do not disconnect the USB connection cable while [Access] is displayed.

1 Connect camera to computer

- Do not use cables other than the supplied USB connection cable or a genuine Panasonic USB connection cable (optional). Using cables other than the above may cause a malfunction.

2 Use cursor button on the camera to select [PC], and press [MENU/SET]

- A message may be displayed on screen if [USB Mode] (→39) is set to [PictBridge(PTP)]. Select [CANCEL] to close the screen, and set [USB Mode] to [PC].

3 Operate with your computer

You can save pictures to use on your computer by dragging and dropping folders and files into separate folders on your computer.

■ To cancel connection

- Windows: Execute "Safely Remove Hardware" on the taskbar
- Mac: Open the Finder and click the eject icon that appears on the sidebar

■ Folder and file names on computer

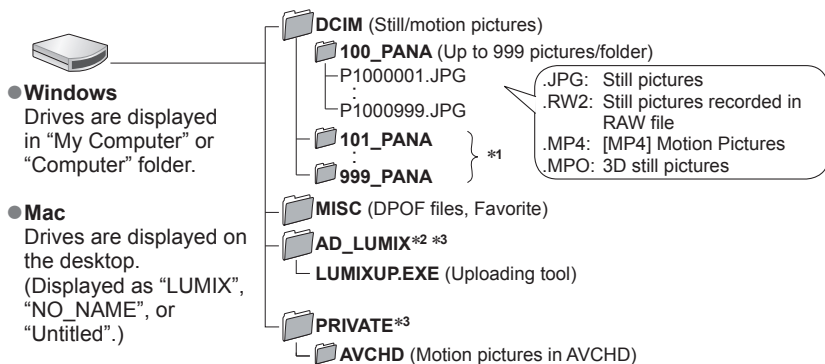

*1 New folders are created in the following cases:

- When the number of files in a folder exceeds 999.
- When using cards already containing the same folder number (for example, pictures taken with other cameras, etc.).
- When recording after performing [No.Reset].

*2 Note that pictures cannot be uploaded to image-sharing websites if the files in the AD_LUMIX folder are deleted.

*3 This folder is not created in the built-in memory.

■ When using Windows XP, Windows Vista, Windows 7, or Mac OS X

The camera can be connected to your computer even if [USB Mode] (→39) is set to [PictBridge(PTP)].

- Only picture output can be performed.
- It may not be possible to import if there are 1000 or more pictures on the card.
- Motion pictures, 3D still pictures or RAW pictures cannot be read.

- Do not use any other USB connection cables except the supplied one or a genuine Panasonic USB connection cable (optional).
- Turn off power before inserting or removing memory cards.
- Use a sufficiently charged battery or an AC adaptor (optional) and DC coupler (optional). When the battery begins to run out during communication, the status indicator flashes and a warning beep sounds. Cancel communication via your computer immediately.
- Setting the [USB Mode] to [PC] removes the need to make the setting each time the camera is connected to the computer.
- For more details, consult your computer operating manual.

Uploading pictures to image-sharing websites

Using the uploading tool ([LUMIX Image Uploader]), you can upload still pictures and motion pictures to image-sharing websites (Facebook or YouTube).

There is no need to copy pictures to your computer or install specialized software.

Uploading pictures from the camera is easy with a computer connected to a network, even when you are away from your regular computing environment.

- This tool supports only computers that run on Windows XP, Windows Vista, and Windows 7.
- For more information, read the operating instructions (PDF) for the [LUMIX Image Uploader].

Preparation:

- Use [Upload Set] to select the pictures for uploading (→171)
- Connect your computer to the Internet
- Create an account for the applicable image-sharing website and prepare your login information

1 Double-click “LUMIXUP.EXE” to start it (→193)

- If you have installed “PHOTOfunSTUDIO” software from the CD-ROM (supplied), “Uploading tool ([LUMIX Image Uploader])” may start automatically.

2 Select the upload destination

- Do the further steps in accordance with the instructions displayed on the computer screen.

- Because YouTube and Facebook services and specifications are subject to change, operation of online services cannot be guaranteed in the future. Available services and screens are subject to change without notice.
(This service is available as of June 1st, 2012)
- Do not upload pictures protected by copyright except when you are the copyright holder or permission has been obtained from the corresponding copyright holder.
- **Images may contain personal information that can be used to identify the user, such as a title, the time and date when the images were taken, and the location where the image was taken if the camera includes a GPS function. Check this information before uploading images to image sharing sites.**

Printing

You can connect directly to a PictBridge-compatible printer for printing.

Preparation:

- Charge the battery sufficiently. Or, connect the AC adaptor (optional) and DC coupler (optional).
- When printing pictures from the built-in memory, remove any memory cards.
- Adjust the print quality or other settings on your printer, as needed.
- Turn on the camera and printer.

Check the plug direction and insert it straight in. (If the cable is inserted in the wrong direction, the plug could become deformed and cause faulty operation)

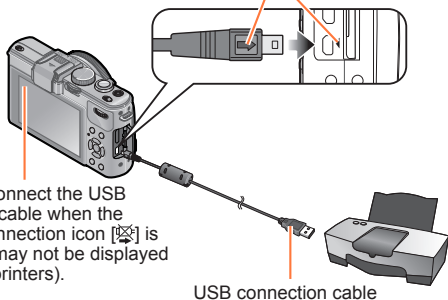

1 Connect camera to printer

- Do not use cables other than the supplied USB connection cable or a genuine Panasonic USB connection cable (optional). Using cables other than the above may cause a malfunction.

2 Use cursor button on the camera to select [PictBridge(PTP)] and press [MENU/SET]

3 Use cursor button to select a picture to print and press [MENU/SET]

4 Use cursor button to select [Print start] and press [MENU/SET] (Print settings (→198))

■ To cancel print

Press [MENU/SET].

- Do not use any other USB connection cables except the supplied one or a genuine Panasonic USB connection cable (optional).
- Disconnect USB connection cable after printing.
- Turn off power before inserting or removing memory cards.
- Use a sufficiently charged battery or an AC adaptor (optional) and DC coupler (optional). When the battery begins to run out while the camera is connected to the printer, the status indicator flashes and a warning beep sounds. Cancel printing and disconnect USB connection cable.
- Still pictures recorded in a RAW file cannot be printed. (The still pictures recorded in JPEG file format at the same time as the RAW file can be printed.)
- Motion pictures cannot be printed.
- Some printers can print directly from the camera's memory card.
For details, see the manual for your printer.

Printing multiple pictures

1 Press **▲** to select **[Multi Print]** in step **3** (→195)

2 Use cursor button to select item and press **[MENU/SET]**

- **[Multi Select]:**
 - ① Scroll between pictures with cursor button, select pictures to print with the **[DISP.]** button. (Press **[DISP.]** button again to release selection.)
 - ② Press **[MENU/SET]** when selection is complete.
- **[Select All]:** Print all pictures.
- **[Print Set (DPOF)]:** Print pictures selected in **[Print Set]**. (→179)
- **[Favorite]:** Print pictures selected as **[Favorite]**. (→178)

3 Use cursor button to select **[Print start]** and press **[MENU/SET]**

(Print settings (→198))

- Select **[Yes]** if print confirmation screen is displayed.

- An orange “●” displayed during printing indicates an error message.
- Print may be divided into several pictures if printing a large amount of pictures. (Remaining sheets display may differ from the number of pictures set for printing.)

Printing with date and text







■ Printing date without **[Text Stamp]**

- Printing in store: Only recording date can be printed. Request date printing in store.
 - Making **[Print Set]** (→179) settings on the camera in advance allows settings for numbers of copies and date printing to be designated before giving the card to the store.
 - When printing still pictures with a 16:9 aspect ratio, check in advance that the store can accept this size.
 - Using computer: Print settings for recording date and text information can be made using “PHOTOfunSTUDIO” software on the supplied CD-ROM.
 - Using printer: Recording date can be printed by setting **[Print Set]** on the camera, or by setting **[Print with Date]** (→198) to **[ON]** when connecting to a printer compatible with date printing.
- Time and date can be set to be printed on the picture when taking the picture by activating the **[Date Stamp]** function in the **[Rec]** menu. (→149)



Making print settings on the camera

Setting options include the number of printed pictures and their size. Make settings before selecting [Print start].

1 Use cursor button to select the item and press [MENU/SET]

Item	Settings
[Print with Date]	[ON] / [OFF]
[Num.of prints]	Set number of pictures (up to 999 pictures)
[Paper Size]	When  is selected, the printer settings take priority.
[Page Layout]	 (printer takes priority) /  (1 picture, no border) /  (1 picture, with border) /  (2 pictures) /  (4 pictures)

2 Use cursor button to select setting and press [MENU/SET]

- Items may not be displayed if incompatible with printer.
- To arrange  "2 pictures" or  "4 pictures" in the same still picture, set the number of prints for the still picture to 2 or 4.
- To print to paper sizes/layouts not supported by this camera, set to  and make settings on the printer. (Consult your printer's operating manual.)
- Even with completed [Print Set] settings, dates may not be printed, depending on the shop or printer used.
- When setting [Print with Date] to [ON], check the date printing settings on the printer (printer settings may be prioritized).
- To print a picture on which text or a date has been stamped, set [Print with Date] to [OFF]. (The still picture is printed with the date superimposed on it.)

Digital Camera Accessory System

Using the Live View Finder (optional)

When the Live View Finder (DMW-LVF2: optional) is used, you can view the recording screen even when taking pictures at a low camera angle, for example.

Preparation:

- Turn the camera ON/OFF switch to [OFF].
- Remove the hot shoe cover attached to the camera. (→9)

1 Firmly insert the Live View Finder into the hot shoe, as far as it will go

2 Turn the camera ON/OFF switch to [ON]

3 Press the [LVF/LCD] button of the Live View Finder to switch the display

- You can switch between the LCD (LCD monitor) display and LVF (Live View Finder) display.
- The display selected by pressing the [LVF/LCD] button will be stored in memory even when the camera ON/OFF switch is set to [OFF].

■To automatically display the playback screen on the LCD monitor

When [Play on LCD] (→37) of the [Setup] menu is set to [ON], the LCD monitor will turn on when the camera is switched from recording mode to playback mode. This operation eliminates the time needed to switch between LCD monitor and Live View Finder when recording pictures using Live View Finder.

- Attach and detach the Live View Finder carefully and correctly.
- The Live View Finder cannot be used together with an external flash.
- When the shoulder strap is attached, make sure that the strap does not get snagged on the Live View Finder.
- Be sure to hold both the camera and the Live View Finder when the Live View Finder is attached to the camera. If you hold only the Live View Finder, it could become detached from the camera.
- Refer to the operating instructions for the Live View Finder for further details.

Using the External Viewfinder (optional)

When the External Viewfinder (DMW-VF1: optional) is attached, you can use it to view the recording screen when taking wide-angle pictures.

Preparation:

- Turn the camera ON/OFF switch to [OFF].
- Remove the hot shoe cover attached to the camera. (→9)

1 Firmly insert the External Viewfinder into the hot shoe, as far as it will go

2 Turn the camera ON/OFF switch to [ON]

■ If the LCD monitor is too bright when you look through the viewfinder eyepiece

You can turn off the LCD monitor during recording by setting [Opt. Viewfinder] (→146) of [Rec] menu to [ON].

- The status indicator lights up.
- Press [DISP.] button to switch the display.

- The field-of-view frame of the External Viewfinder indicates the area that can be used for a 24 mm lens (35 mm film camera equivalent, aspect ratio 3:2, Wide).
- The frame lines are a reference for the recording range. Check the LCD monitor for a more accurate view.
- If the lens surface gets dirty, wipe it with a dry soft cloth.
- Attach and detach the External Viewfinder carefully and correctly.
- The External Viewfinder cannot be used together with an external flash.
- When the shoulder strap is attached, make sure that the strap does not get snagged on the External Viewfinder.
- Be sure to hold both the camera and the External Viewfinder when the External Viewfinder is attached to the camera. If you hold only the External Viewfinder, it could become detached from the camera.
- Refer to the operating instructions for the External Viewfinder for further details.

Using the external flash (optional)

When you use an external flash (DMW-FL220, DMW-FL360, DMW-FL500; optional), it provides a wider effective flash range than the built-in flash.

Preparation:

- Set the camera ON/OFF switch to [OFF] and close the built-in flash.
- Remove the hot shoe cover attached to the camera. (→9)

- 1 Attach the flash to the hot shoe and turn on the camera and flash**
- 2 Select [Flash] from the [Rec] menu**
 - For the setting procedures of the menu. (→25)
- 3 Use cursor button to select the flash mode setting and press [MENU/SET]**
 - While the external flash is connected, the following icons are displayed.
 - ♂A : AUTO
 - ♂A⊙: AUTO/Red-Eye Reduction
 - ♂ : Forced flash on
 - ♂S⊙: Slow sync./Red-Eye Reduction
 - ♂⊙ : Forced flash off

■When using other commercially available external flashes that don't offer direct communication with the camera (DMC-LX7)

- It is necessary to set the exposure on the external flash when it is used. When you use an external flash in Auto Mode, use an external flash that allows you to set the aperture value and ISO Sensitivity to match the same settings on the camera.
- Set the camera to [Aperture-Priority] Mode or [Manual Exposure] Mode and then set the same aperture value and ISO Sensitivity on the external flash. (The proper exposure cannot be achieved because the aperture value changes in [Shutter-Priority] Mode. The light of the external flash cannot be properly adjusted since the aperture value cannot be fixed in [Program AE] Mode.)

- The external flash cannot be used together with the Live View Finder (optional) or External Viewfinder (optional).
- You can set the aperture value, shutter speed and ISO Sensitivity on the camera even when the external flash is attached.
- Some commercially available external flashes have synchro terminals with high-voltage or reversed polarity. If such flashes are used, they could cause a malfunction or hinder normal operation of the camera.
- Do not use an external flash with communication functions other than a flash (optional) for this camera. If you use other flashes, they may fail to operate properly and may also cause the camera to malfunction.
- Some external flashes put the camera into external flash mode as soon as they are mounted on the camera, even if the external flash is turned off. If you are not using the external flash, detach it from the camera.
- When the external flash is attached, do not open the built-in flash.
- When the external flash is attached, the camera will become unstable, and therefore we recommend using a tripod to take pictures.
- Detach the external flash when you carry the camera.
- Be sure to hold both the camera and the external flash when it is attached to the camera. If you hold only the external flash, it could become detached from the camera.
- If the White Balance is set to [WB] when the external flash is used, perform fine adjustment of the White Balance if the recording results are not satisfactory. (→113)
- If you take pictures close to the subject while taking wide-angle pictures, the light of the flash is obstructed by the lens and the bottom of the screen may be dark.
- Refer to the operating instructions of the external flash for further details.

Using the filter (optional)

When you use a filter adaptor kit (optional: DMW-FA1), you can use the following filters. (As of July 2012)

PL filter DMW-LPLA37*	The PL filter helps suppress light reflected from a metal or non-spherical surface (flat non-metallic surfaces, water vapor or invisible fine particles in the air) and enables you to take still pictures with enhanced contrast.
MC protector DMW-LMCH37	The MC protector is a transparent filter that causes little change in colors or light intensity and can be used to protect the camera lens.
ND filter DMW-LND37	The ND filter does not cause any change in colors but it can reduce only the light intensity by 1/8th (equivalent to adjusting the aperture value by 3 stops).

* You cannot use the camera with a PL filter (DMW-LPL37) installed on it. (The DMW-LPL37 is thicker than the DMW-LPLA37, so the surrounding parts of the screen may sometimes darken (when vignetting, for example).)

■ How to install a filter adaptor

Preparation:

- Set [Sleep Mode] in the [Setup] menu to [OFF] (→36).
- Remove the lens cap, and turn the camera ON/OFF switch to [ON].

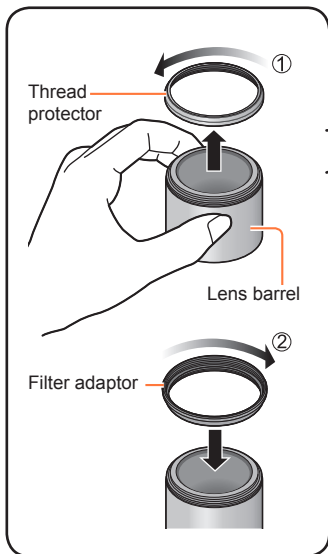

- 1** Spread a soft cloth on a flat desk, and place the unit on it, with the LCD facing down

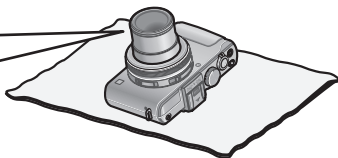

- 2** Remove the thread protector from the end part of the lens by turning it in the direction of arrow ①
 - Gently hold the lens barrel with your fingers, and turn the thread protector with the opposite hand.
- 3** Install the filter adaptor by turning it in the direction of arrow ②
 - Gently hold the lens barrel with your fingers, and turn the filter adaptor with the opposite hand.

- When you take pictures using the built-in flash with the filter adaptor installed, the light from the flash is sometimes blocked by the filter adaptor.
- When installing or removing the filter adaptor, take care not to damage the lens or get it dirty.
- When installing or removing the thread protector or filter adaptor etc., turn it slowly and carefully. (If you tighten it too firmly, you may be unable to remove it.)
- When you use the lens cap supplied with the filter adaptor kit, you can install it with the filter installed.
- Do not attach multiple filters at the same time.
- You can only use filters and cannot attach and use conversion lens, etc. If you attach a conversion lens, it could cause a camera malfunction. (As of July 2012)
- Refer to the operating instructions of the relevant filters for further details.

Using the AC adaptor (optional) and DC coupler (optional) instead of the battery

By using the AC adaptor (optional) and DC coupler (optional), you can record and play back without worrying about the remaining battery charge.

The optional DC coupler can only be used with the designated Panasonic AC adaptor.

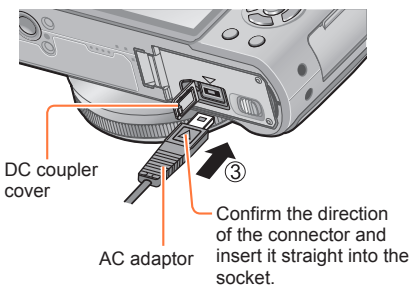
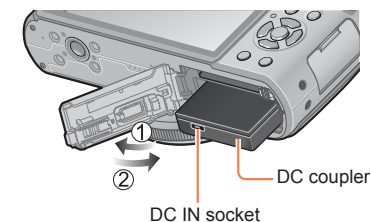

- 1** Insert DC coupler instead of battery
- 2** Open DC coupler cover
 - If difficult to open, with the card/battery door open, press the DC coupler cover from the inside to open it.
- 3** Close the door and slide the release lever to the [LOCK] position
- 4** Plug AC adaptor into power outlet
- 5** Connect AC adaptor to DC IN socket of DC coupler

- Always use a genuine Panasonic AC adaptor (optional).
- Use the AC adaptor and DC coupler specifically for this camera. Using other adaptors or couplers could cause camera failure.
- It may not be possible to install camera on a tripod or unipod when the DC coupler is connected, depending on the type of tripod or unipod.
- The camera cannot be stood up when the AC adaptor is connected. If you are leaving the camera on a surface as you work, it is recommended to set it on a soft cloth.
- When the AC adaptor is connected, always remove the AC adaptor when opening the card/battery door.
- Remove the AC adaptor and DC coupler when not in use and close the DC coupler cover.
- Also read the AC adaptor and DC coupler operating instructions.



List of LCD monitor displays

Screens shown here are only examples. The actual display may vary.

- Press the [DISP.] button to change display.

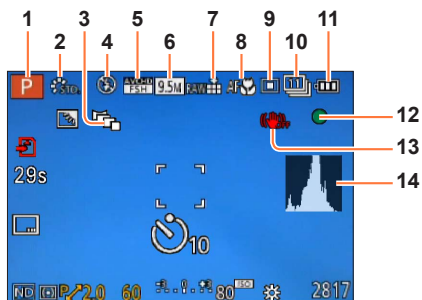
■ In recording



- | | |
|--|---|
| 1 Recording Mode (→48)
Custom Set (→91) | 9 Auto Focus mode (→97) |
| 2 Color Mode (→53)
Photo style (→134) | 10 Self-timer (→116)
Burst (→118)
Auto Bracket (→125)  |
| 3 Aspect Bracket (→122) | 11 Battery capacity (→15) |
| 4 Flash (→106) | 12 Focus display (→96) |
| 5 Recording Mode (→150) | 13 Optical Image Stabilizer OFF (→142)
Jitter alert (→46)  |
| 6 Picture Size (→135) | 14 Histogram (→33) |
| 7 Quality (→136) | |
| 8 AF macro (→102)
Manual Focus (→104)
AF Lock (→103) | |

Screens shown here are only examples. The actual display may vary.

- Press the [DISP.] button to change display.

■ In recording



- | | |
|--|--|
| 15 Self-timer (→116) | 24 Built-in ND filter (→123) |
| 16 Estimated remaining pictures or recording time capacity*1 (→34) | 25 Current date/time
World time (→27)
Name*2 (→79)
Age in years/months*2 (→79)
Destination settings*2 (→28)
Travel elapsed days*2 (→28) |
| 17 White Balance (→111) | 26 Date Stamp (→149) |
| 18 ISO Sensitivity (→109) | 27 AF area (→97) |
| 19 Manual exposure assist (→62)
Exposure Compensation (→124) | 28 Elapsed recording time*1 (→82) |
| 20 Shutter speed (→58) | 29 Recording operation (→20) |
| 21 Aperture value (→58) | 30 Backlight Compensation (→49) |
| 22 Program Shift (→58) | |
| 23 Metering Mode (→139)
AE Lock (→103) | |

*1 [h], [m] and [s] indicate "hour", "minute" and "second".

*2 The displaying is performed in the following priority order: travel destination, name ([Baby]/[Pet]), and name ([Face Recog.])

■ In recording (During a zoom operation, for example)

When Extended optical zoom is set

Focus range

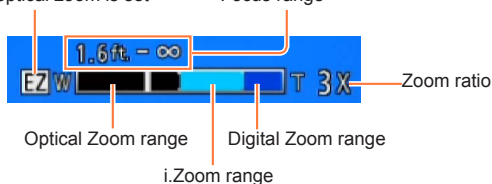

- When Step Zoom has been set (→95)

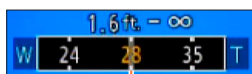

Current zoom position

(Focal lengths the same as those of a 35 mm film camera)

- Focus range indication (During Manual Focus) (→104)

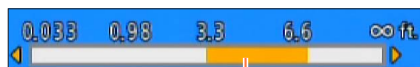

Reference of focus range (depth of field)

Screens shown here are only examples. The actual display may vary.

- Press the [DISP.] button to change display.

■ In playback

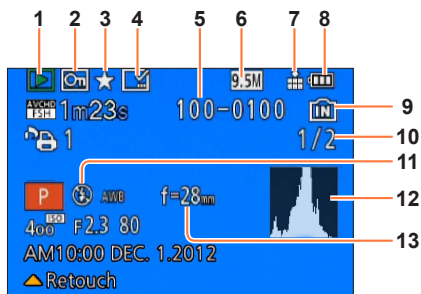

- | | |
|---|---|
| 1 Playback Mode (→165) | 8 Battery capacity (→15) |
| 2 Protected picture (→180) | 9 Built-in memory (→20) |
| 3 Favorites (→178) | 10 Picture No./Total number of pictures |
| 4 Date/text stamped display (→149, 173) | 11 Flash (→106) |
| 5 Folder/File No. | 12 Histogram (→33) |
| 6 Picture Size (→135) | 13 Zoom position during Step Zoom (→95) |
| 7 Quality (→136) | |

Screens shown here are only examples. The actual display may vary.

- Press the [DISP.] button to change display.

■ In playback

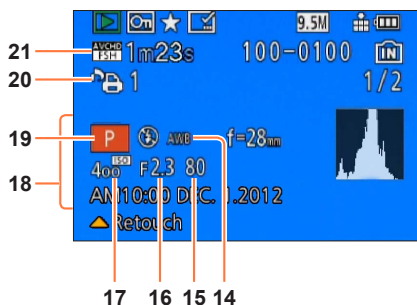

- | | | | |
|----|---|----|---|
| 14 | White Balance (→111) | 19 | Recording Mode (→48) |
| 15 | Shutter speed (→58) | 20 | Print settings (→179) |
| 16 | Aperture value (→58) | 21 | Recording Mode (→150)
Motion picture recording time*2 (→159) |
| 17 | ISO Sensitivity (→109) | | |
| 18 | Recording date/time
World time (→27)
Name*1 (→79)
Age in years/months*1 (→79)
Destination settings*1 (→28)
Travel elapsed days*1 (→28)
Title*1 (→172) | | |

*1 The displaying is performed in the following priority order: title, travel destination, name ((Baby)/[Pet]), and name ((Face Recog.)).

*2 [h], [m] and [s] indicate "hour", "minute" and "second".

Message displays

Meanings of and required responses to major messages displayed on LCD monitor.

[This memory card cannot be used]

- A MultiMediaCard was inserted.
→ Not compatible with the camera. Use a compatible card.

[Some pictures cannot be deleted] [This picture cannot be deleted]

- Non-DCF pictures (→152) cannot be deleted.
→ Save needed data on a computer or other device, and then use [Format] on the camera. (→42)

[No additional selections can be made]

- The number of pictures that can be deleted at once has been exceeded.
- More than 999 pictures have been set as [Favorite].
- The number of pictures allowing [Title Edit], [Text Stamp] or [Resize] (multiple settings) at once has been exceeded.

[Cannot be set on this picture]

- [Print Set], [Title Edit], or [Text Stamp] cannot be made for non-DCF pictures (→152).

[Please turn camera off and then on again] [System Error]

- The lens is not working correctly.
→ Turn on power again.
(Consult the dealer or your nearest Service Center if display still remains)

[Some pictures cannot be copied] [Copy could not be completed]

- Pictures cannot be copied in following cases.
→ Picture of same name already exists in built-in memory when copying from card.
→ File is not of DCF standard (→152).
→ Picture taken or edited on a different device.

[Not enough space on built-in memory] [Not enough memory on the card]

- There is no space left on the built-in memory or the card. When you copy pictures from the built-in memory to the card (batch copy), the pictures are copied until the capacity of the card becomes full.

[Built-In Memory Error] [Format built-in memory?]

- Displayed when formatting built-in memory via computer, etc.
→ Reformat directly using camera. Data will be deleted.

[Memory card error. This card cannot be used in this camera. Format this card?]

- The card format cannot be used with this camera.
→ Save needed data on a computer or other device, and then use [Format] on the camera. (→42)

[Insert SD card again] [Try another card]

- Access to card has failed.
→ Insert card again.
- Try with a different card.

[Memory card parameter error]

- Card is not of SD standard.
→ Check whether card has been inserted correctly (→18).
- When cards in capacities of 4 GB or more are used, only SDHC or SDXC Memory Cards are supported.

[Read Error] / [Write Error] [Please check the card]

- Data read has failed.
→ Check whether card has been inserted correctly (→18).
- Data write has failed.
→ Turn off the camera and remove the card. Reinsert the card and turn the camera on again.
- Card may possibly be damaged.
- Try with a different card.

[Cannot record due to incompatible format(NTSC/PAL) data on this card.]

- Format the card after saving necessary data on a PC etc. (→42)
- Insert a different card.

[Motion recording was cancelled due to the limitation of the writing speed of the card]

- If recording stops even when using a card of the recommended speed class (→20), the data writing speed has dropped. If this happens, we recommend backing up the data on the memory card and formatting it (→42).
- Motion picture recording may be automatically terminated with certain cards.

[A folder cannot be created]

- Folder numbers in use have reached 999.
→ Save needed data on a computer or other device, and then use [Format] on the camera (→42).
Folder number is reset to 100 when performing [No.Reset] (→38).

[Picture is displayed for 16:9 TV] [Picture is displayed for 4:3 TV]

- AV cable (optional) is connected to camera.
→ To remove message immediately → Press [MENU/SET].
→ To change aspect ratio → Change [TV Aspect] (→39).
- USB connection cable is only connected to camera.
→ Message disappears when cable is also connected to another device.

[This battery cannot be used]

- Use a genuine Panasonic battery.
- Battery cannot be recognized as terminal is dirty.
→ Wipe any dirt away from the battery terminal.

[Recording failed.]

- Recording may be impossible if the recording location for a 3D image is too dark/too bright, or if the subject lacks contrast.

Q&A Troubleshooting

Before asking for repairs, check and try the following procedures.



A message is displayed on the camera (→211)

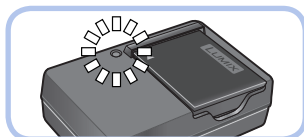

Battery-and power supply-related problems (→214)

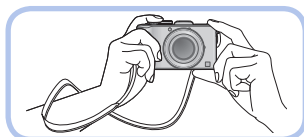

Recording-related problems (→214)

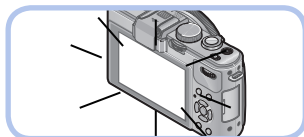

LCD monitor-related problems (→217)



Playback-related problems (→218)



Other problems (→219)

If the problem persists, performing [Reset] in the [Setup] menu may resolve the issue (→39). Note that except for some items such as [Clock Set], all settings are returned to their values at the time of purchase.

Battery, power

Camera does not work even if power is turned on.

- Battery is not inserted correctly ([→18](#)), or needs recharging.

LCD monitor shuts off even if power is turned on.

Camera switches off as soon as power is turned on.

- [Opt. Viewfinder] is set to [ON].
→ Press [DISP.] button to switch to the LCD monitor display.
- The Live View Finder (optional) display is selected.
→ Press the [LVF/LCD] button of the Live View Finder (optional) to switch to the LCD monitor display.
- [Economy] ([Sleep Mode] or [Auto LCD Off]) is activated. ([→36](#))
→ Press shutter button halfway to release.
- Battery needs recharging.

This unit is turned off automatically.

- If you connect to a TV compatible with VIERA Link (HDMI) with an HDMI mini cable (optional) and turn off the power on the TV with the remote control for the TV, the power on this unit also turns off.
→ If you are not using VIERA Link (HDMI), set [VIERA Link] to [OFF]. ([→40](#))

Recording

Cannot record pictures.

- Built-in memory/card is full.
→ Free space by deleting unwanted pictures ([→163](#)).

Recorded pictures look white.

- Lens is dirty (fingerprints, etc.).
→ Turn on power to extract lens barrel, and clean lens surface with a soft, dry cloth.
- Lens is foggy ([→6](#)).

Recorded pictures are too bright/too dark.

- **Adjust the exposure** ([→124](#)).
- **[Min. Shtr Speed] is set to fast speed. Check the setting** ([→141](#)).

Some pictures are taken when I press the shutter button just once.

- The following functions are set.
[Burst Shooting] ([→118](#)) [WB Bracket] ([→114](#)) [Aspect Bracket] ([→122](#)) [Auto Bracket] ([→125](#))

Focus not aligned correctly.

- Not set to mode appropriate for distance to subject. (Focus range varies according to recording mode.)
- Subject outside of focus range. ([→96](#), [102](#))
- Caused by jitter or subject movement. ([→142](#))

Recorded pictures are blurred. Optical Image Stabilizer ineffective.

- Shutter speed is slower in dark locations and Optical Image Stabilizer is less effective.
→ Hold camera firmly with both hands, keeping arms close to body.
- Use a tripod and the self-timer ([→116](#)) when using slower shutter speed with [Min. Shtr Speed].

Recording (continued)

Cannot use [WB Bracket].

- Built-in memory/card is full.
→ Free space by deleting unwanted pictures (→163).

Recorded pictures appear coarse, or there is interference.

- ISO Sensitivity is high, or shutter speed is low.
(Default [Sensitivity] setting is [AUTO] – interference may appear with indoor pictures.)
→ Lower [Sensitivity] (→109).
→ Take pictures in brighter locations.

Striping or flicker may appear under lighting such as fluorescent lighting and LED lighting fixture.

- This is characteristic of MOS sensors which serve as the camera's pickup sensors.
This is not a malfunction.



Brightness or coloring of recorded picture different from real life.

- When recording under fluorescent or LED lighting fixture etc., increasing the shutter speed may introduce slight changes to brightness and color. These are a result of the characteristics of the light source and do not indicate a malfunction.
- When recording subjects in extremely bright locations or recording under fluorescent lighting, LED lighting fixture, mercury lamp, sodium lighting etc., the colors and screen brightness may change or horizontal striping may appear on the screen.

The zoom does not function normally.

- The zoom operates in steps.
→ Set [Step Zoom] to [OFF] (→95).

Reddish horizontal streaks appear on the LCD monitor during recording.

- This is characteristic of the MOS sensors, which serve as the camera's pickup sensors. The streaks appear when the subject has a bright part. Some unevenness may occur in the surrounding areas, but this is not a malfunction. It is recorded in motion pictures but is not recorded on still pictures.
- It is recommended that you take pictures while taking care not to expose the screen to sunlight or any other source of strong light.

Motion picture recording stops midway.

- With some cards, access display may appear briefly after recording, and recording may end midway.
- If recording stops even when using a card of the recommended speed class (→20), the data writing speed has dropped. If this happens, we recommend backing up the data on the memory card and formatting it (→42).
- You can continuously record a motion picture in [MP4] for up to 29 minutes 59 seconds or approx. 4 GB. (Since recording in [MP4] with [FHD] creates larger files, the recording time for such motion pictures will be shorter than 29 minutes 59 seconds.)
- If [Rec Quality] of [AVCHD] motion pictures is set to [PSH] or [FSH], you can continuously record a motion picture for up to 29 minutes 59 seconds.

Recording (continued)

The subject appears distorted.

- An MOS is used as the imaging device for this unit, so if the subject passes quickly in front of the lens, it will appear slightly distorted. Note, however, that this does not indicate a malfunction.

An unusual noise, such as a clicking or buzzing noise, is recorded on a motion picture.

The audio level is extremely low.

- When recording a motion picture in a quiet environment, noise due to the motion of the aperture and focusing mechanism may be recorded on the motion picture. Note that this is not a fault. You can set the focus operation during motion picture recording to [OFF] using [Continuous AF] (→151).
- Note that if you perform operations such as zoom, using buttons or dials, while recording a motion picture, operation noise may be recorded.
- If you block off the microphone opening while recording a motion picture, the audio level may be low, or the audio may not be recorded. Note that in this case, noise due to the motion of the lens is more likely to be recorded.

Panorama picture recording stops before finishing.

- If the pan motion of the camera is too slow, the camera assumes that the operation has been aborted and stops recording.
- If the pan motion of the camera is too shaky when it is moved toward the recording direction, the camera stops recording.
→ To record panorama pictures, pan the camera in a small circular motion parallel to the recording direction at a speed of approx. 8 seconds per revolution (guideline).

The subject cannot be locked. (AF track fails)

- If the color of the subject is similar to that of its background, AF Tracking may not function. Set the AF lock to the colors specific to the subject.

Flash

No flash emitted.

- The flash is retracted into the camera housing.
→ Operate the flash open switch to open the flash.
- The flash becomes unavailable in the following cases :
 - [Burst Shooting] (Excluding [E3])
 - [WB Bracket] [Aspect Bracket] [Auto Bracket]
 - Scene Modes ([Scenery] [Panorama Shot] [Night Scenery] [Handheld Night Shot] [HDR] [Sunset] [Glass Through] [3D Photo Mode])
 - [Creative Control] mode (excluding [Smooth Defocus] and [Radial Defocus])

Multiple flashes are emitted.

- Red-eye reduction is active (→107). (Flashes twice to prevent eyes appearing red.)
- [Burst Shooting] is set to [E3].

LCD monitor

No picture is displayed on the LCD monitor.

- [Opt. Viewfinder] is set to [ON].
→ Press [DISP.] button to switch to the LCD monitor display.
- The Live View Finder (optional) display is selected.
→ Press the [LVF/LCD] button of the Live View Finder (optional) to switch to the LCD monitor display.

Brightness is unstable.

- Aperture value is set while shutter button is pressed halfway. (Does not affect recorded picture.)
This symptom may also occur when the brightness changes because the zoom is operated or the camera is moved. This is the automatic aperture operation of the camera and is not a malfunction.

Monitor flickers indoors.

- The LCD monitor may flicker for a few seconds after turning on. This is an operation to correct flicker caused by lighting such as fluorescent lights, LED lights etc. and is not a malfunction.

Monitor is too bright/too dark.

- [LCD Mode] is activated (→31)
- Use [LCD Display] to adjust the brightness of the LCD monitor. (→31)

Black/blue/red/green dots or interference appears. Monitor looks distorted when touched.

- This is not a fault, and will not be recorded on the actual pictures.

Even when you press the [LVF/LCD] button of the Live View Finder (optional), the display does not switch between the LCD monitor and Live View Finder.

- When it is connected to a computer or printer, the camera can display pictures on the LCD monitor only.

Playback

Pictures have been rotated.

- [Rotate Disp.] is activated (→40)

Cannot view pictures. There are no recorded pictures.

- No pictures in built-in memory or card (pictures played from card if inserted, from built-in memory if not).
- Has the file name of the picture been changed on a computer? If so, it cannot be played back on the camera.
- The [Playback Mode] has been changed.
→ Set [Playback Mode] to [Normal Play] (→152).

Folder/file number displayed as [-]. Picture is black.

- Picture edited on computer or taken with different device.
- Battery removed immediately after picture taken, or picture taken with low battery.
→ Use [Format] to delete (→42).

Incorrect date displayed in Calendar Playback.

- Picture edited on computer or taken on different device.
- [Clock Set] is incorrect (→27).
(Incorrect date may be displayed in Calendar Playback on pictures copied to computer and then back to camera, if computer and camera dates differ.)

White round spots like soap bubbles appear on the recorded picture.

- If you take a picture with the flash in a dark place or indoors, white round spots may appear on the picture caused by the flash reflecting particles of dust in the air. This is not a fault. A characteristic of this is that the number of round spots and their position differ in every picture.



Part of a picture flashes in black and white.

- [Highlight] is set to [ON].

[Thumbnail is displayed] is shown on the screen.

- The pictures may have been recorded on another device. If so, they may be displayed with poor picture quality.

Red areas in pictures appear blackened.

- When digital red-eye correction (⚡A, ⚡S) is operating, if a subject is recorded that has skin-colored areas with red areas inside, the digital red-eye correction function may blacken the red areas.
→ We recommend setting the flash to [⚡A], [⚡] or [⚡], or [Red-Eye Removal] to [OFF] before recording. (When the built-in flash is closed, [⚡] (Forced flash off) is set regardless of the flash setting.)

Sounds of camera operations such as zoom will be recorded in motion pictures.

- Camera operation sounds may be recorded as camera automatically adjusts lens aperture during motion picture recording; this is not a fault.

Motion pictures taken with this camera cannot be played in other cameras.

- When motion pictures recorded in AVCHD or MP4 using this camera are played back, they may be displayed with poor picture and sound quality or may not be played back at all even if an AVCHD or MP4 compatible device is used. Also, the recording information may not be displayed correctly.

TV, computer, printer**No image appears on TV. Image blurred or not colored.**

- Not connected correctly (→183).
- The television has not been switched to auxiliary input.

TV screen display different to LCD monitor.

- Aspect ratio may be incorrect or edges may be cut off with certain televisions.

Cannot play motion pictures on TV.

- Card is inserted into TV.
→ Connect with AV cable (optional) or HDMI mini cable (optional) and play on camera (→183).

Picture is not displayed on full TV screen.

- Check [TV Aspect] settings (→39).

No sound is output from the camera speaker.

- When the AV cable (optional) or HDMI mini cable (optional) is connected to the camera, no sound is output from the camera.

VIERA Link (HDMI) is not working.

- Is the HDMI mini cable (optional) connected correctly? (→183)
→ Check that the HDMI mini cable (optional) is fully inserted.
- Is the camera's [VIERA Link] setting set to [ON]? (→40)
→ The input setting may not be able to be changed automatically with certain television HDMI sockets. In this case, please change the input setting with your television's remote control (consult your television's operating instructions for details).
→ Check the VIERA Link (HDMI) settings on the device you are connecting to.
→ Turn the camera's power off and on again.
→ Turn the "VIERA Link control (HDMI device control)" setting on your television (VIERA) to off and then to on again. (Consult your VIERA's operating instructions for details.)

TV, computer, printer (continued)**Cannot communicate with the computer.**

- Not connected correctly (→191).
- Check whether your computer has recognized camera.
 - Set [USB Mode] to [PC] (→39).
 - Turn the camera off and then on again.

Computer does not recognize card (only reads built-in memory).

- Disconnect USB connection cable and reconnect with card in place.

Computer does not recognize card. (When using an SDXC Memory Cards)

- Check whether your computer is compatible with SDXC Memory Cards.
<http://panasonic.net/avc/sdcard/information/SDXC.html>
- A message prompting you to format the card may appear when you connect it. Do not format the card.
- If the [Access] indicator on the LCD monitor does not go off, turn off the camera's power before disconnecting the USB connection cable.

Uploading to YouTube or Facebook cannot be performed properly.

- Confirm that the login information (login ID, user name, e-mail address and password) is correct.
- Confirm that the computer is connected to the Internet.
- Confirm that the resident software (such as anti-virus software and the firewall, etc.) is not blocking access to YouTube or Facebook.
- Check the YouTube or Facebook site.

Cannot print when connecting to printer.

- Printer not compatible with PictBridge.
- Set [USB Mode] to [PictBridge(PTP)] (→39).

The edges of pictures are cut off when printing.

- Release any trimming or edgeless printing settings on printer before printing.
(Consult printer operating manual.)
- The aspect ratio of pictures is different from that of paper used for printing.
 - If printing in shop, check if 16:9 sizes can be printed.

Cannot print panorama pictures properly.

- The aspect ratio of panorama pictures is different from that of regular still pictures, and some panorama pictures may not be printed correctly.
 - Use a printer with support for panorama pictures. (Refer to the instruction manual for the printer.)
 - We recommend adjusting the size of a picture in accordance with print paper using the "PHOTOfunSTUDIO" software on the CD-ROM (supplied).

Others**Menu not displayed in desired language.**

- Change [Language] setting (→43).

Camera rattles if shaken.

- This sound is made by the lens movement and is not a fault.

Red lamp illuminated when pressing shutter button halfway in dark locations.

- [AF Assist Lamp] is set to [ON] (→143).

AF Assist Lamp is not illuminated.

- [AF Assist Lamp] is set to [OFF].
- Not illuminated in bright locations.

Camera is hot.

- Camera may become a little warm during use, but this does not affect performance or quality.

Lens makes a clicking noise.

- When brightness changes, the lens may make a clicking noise and the monitor brightness may also change, but this is due to aperture settings being made.
(Does not affect recording.)

Clock is incorrect.

- Camera has been left for a long period.
→ Reset the clock (→24).
- A long time was taken to set the clock (clock will be behind by the same lapse of time).

When using zoom, picture becomes slightly warped and the edges of the subject become colored.

- Pictures may be slightly warped or colored around the edges, depending on the zoom ratio, but this is not a fault.

Zoom movement stops momentarily.

- The zoom movement stops momentarily during Extended Optical Zoom operation, but this is not a malfunction.

File numbers are not recorded in sequence.

- File numbers are reset when new folders are created (→38).

File numbers have jumped backwards.

- Battery was removed/inserted with power on.
(Numbers may jump backwards if folder/file numbers are not correctly recorded.)

When no operation is performed for a while, the demo is suddenly displayed.

- This is the Automatic Demo Mode that introduces the features of this camera.
Press [MENU/SET] to return to the previous screen.

Usage cautions and notes

When in use

- Camera may become warm if used for long periods of time, but this is not a fault.
- **Keep this unit as far away as possible from electromagnetic equipment (such as microwave ovens, TVs, video games etc.).**
 - If you use this unit on top of or near a TV, the pictures and/or sound on this unit may be disrupted by electromagnetic wave radiation.
 - Do not use this unit near cell phones because doing so may result in noise adversely affecting the pictures and/or sound.
 - Recorded data may be damaged, or pictures may be distorted, by strong magnetic fields created by speakers or large motors.
 - Electromagnetic wave radiation generated by microprocessors may adversely affect this unit, disturbing the pictures and/or sound.
 - If this unit is adversely affected by electromagnetic equipment and stops functioning properly, turn this unit off and remove the battery or disconnect AC adaptor (optional). Then reinsert the battery or reconnect AC adaptor and turn this unit on.
- **Do not use this unit near radio transmitters or high-voltage lines.**
 - If you record near radio transmitters or high-voltage lines, the recorded pictures and/or sound may be adversely affected.
- Do not keep objects that may be influenced magnetically close to the speaker.
 - Magnetized objects such as bank cards, commuter passes, watches, may be adversely affected by the magnetic influence of the speaker.
- Do not extend the supplied cord or cable.
- Do not allow camera to come into contact with pesticides or volatile substances (can cause surface damage or coating to peel).
- Never leave the camera and the battery in a car or on a car hood in the summer. Doing so may cause leakage of the battery electrolyte overheating, fire or a battery explosion due to the high temperature.

Caring for your camera

To clean your camera, remove the battery or disconnect the power plug from the outlet, and wipe with a soft, dry cloth.

- Use a damp cloth to remove stubborn stains, before wiping with a dry cloth.
- Do not use benzine, thinners, alcohol, or kitchen detergent, as these may damage the outer casing and finish of the camera.
- If using a chemically-treated cloth, read the supplied instructions carefully.

When not using for a while

- Turn off camera power before removing battery and card (ensure that battery is removed to prevent damage through over-discharge).
- Do not leave in contact with rubber or plastic bags.
- Store together with a drying agent (silica gel) if leaving in drawer, etc. Store batteries in cool (15 °C to 25 °C (59 °F to 77 °F)) places with low humidity (40%RH to 60%RH) and no major temperature changes.
- Charge battery once per year and use completely before storing again.

Memory cards

- To prevent damage to cards and data
 - Avoid high temperatures, direct sunlight, electromagnetic waves, and static electricity.
 - Do not bend, drop, or expose to strong impacts.
 - Do not touch terminals on reverse of card or allow them to become dirty or wet.
- When disposing of/transferring memory cards
 - If using the “format” or “delete” functions on your camera or computer, this only changes the file management information, and does not completely delete the data from within the memory card. When disposing of or transferring your memory cards, we recommend physically destroying them, or using commercially available computer data erasing software to completely delete the data from the card. Data within memory cards should be managed responsibly.

LCD Monitor

- Do not press hard on the LCD monitor. This may cause uneven display and damage the monitor.
- In cold climates or other situations when the camera becomes cold, the LCD monitor may appear slightly darker than normal immediately after the camera is turned on. Normal brightness will return once the internal components have warmed up.

Extremely high precision technology is employed to produce the LCD monitor screen. However there may be some dark or bright spots (red, blue or green) on the screen. This is not a malfunction. The LCD monitor screen has more than 99.99% effective pixels with fewer than 0.01% of the pixels inactive or always lit. The spots will not be recorded on pictures in the built-in memory or a card.

Charging the battery

- The time required for charging varies depending on conditions of battery usage. Charging takes longer at high or low temperatures and when the battery has not been used in some time.
- Battery will be warm during charging and for some time thereafter.
- Battery will run out if not used for long periods of time, even after being charged.
- Do not leave any metal items (such as clips) near the contact areas of the power plug. Otherwise, a fire and/or electric shocks may be caused by short-circuiting or the resulting heat generated.
- Frequently charging up battery is not recommended. (Frequently charging battery reduces maximum usage time and can cause battery to expand.)
- If available battery power is significantly reduced, battery is reaching end of lifespan. Please purchase a new battery.
- When charging:
 - Wipe dirt from the battery terminal with a dry cloth.
 - Keep at least 1 m (3.3 feet) away from AM radio (may cause radio interference).
- Do not use a damaged or dented battery (especially connectors), e.g. by dropping (can cause faults).

Charger

- Depending on the environment while charging, the charging light may flicker due to static electricity or electromagnetic radiation, etc. This has no effect on charging.
- Keep at least 1 m (3.3 feet) away from AM radio (may cause radio interference).
- The charger may generate whirring sounds when it is being used. This is not a malfunction.
- After use, be sure to disconnect the power supply device from the electrical outlet. (A very small amount of current is consumed if it is left connected.)

Lens

- Images may appear slightly white if lens is dirty (fingerprints, etc.). Turn the power on, hold the extracted lens barrel with your fingers, and gently wipe the lens surface with a soft, dry cloth.
- Do not leave the lens exposed to direct sunlight.

When using a tripod or unipod

- Do not apply excessive force or tighten screws when they are crooked. (This may damage the camera, screw hole, or label.)
- Ensure that the tripod is stable. (Refer to the tripod instructions.)
- You may not be able to remove the card or the battery when using a tripod or unipod.

3D viewing

- Anyone who is hypersensitive to light, suffers from heart disease or is otherwise unwell should avoid viewing 3D pictures.
 - Viewing 3D pictures may have an adverse effect to the individual.
- If you feel tired, uncomfortable or otherwise strange when viewing 3D pictures, stop viewing at once.
 - Continuing to view may cause illness.
 - After stopping viewing, please rest appropriately.
- When viewing 3D pictures, we recommend taking a break every 30 to 60 minutes.
 - Viewing for extended periods may cause eye-fatigue.
- Short-sighted or long-sighted persons, those with differences in the sight of their right and left eyes, and those with astigmatism are advised to correct their vision by wearing glasses etc.
Stop viewing if you can clearly see a double image while watching 3D pictures.
 - There are differences in the way that different people experience 3D pictures. Please correct your sight appropriately before viewing 3D pictures.
 - You can change the 3D setting of your television or 3D output setting of the unit to 2D.

Personal Information

If names or birthdays are set in [Baby] Mode or in the [Face Recog.] function, keep in mind that the camera and recorded pictures will contain personal information.

- Disclaimer
 - Data containing personal information can be altered or lost due to malfunction, static electricity, accidents, breakdowns, repairs, or other operations.
Panasonic will not be liable for any damage that occurs, direct or indirect, as a result of the alteration or loss of data containing personal information.
- When ordering repairs or transferring/disposing of the camera
 - To protect your personal information, please reset the settings. (→39)
 - If any pictures are contained in the built-in memory, copy (→182) them to a memory card if necessary, and then format (→42) the built-in memory.
 - Remove the memory card from the camera.
 - When ordering repairs, the built-in memory and other settings may be returned to the initial purchase state.
 - If the above operations cannot be performed because of a camera malfunction, consult with the dealer or nearest Service Center.

When transferring or disposing of your memory card, see “When disposing of/transferring memory cards” in the previous section (→223).

HDMI

- HDMI, the HDMI Logo, and High-Definition Multimedia Interface are trademarks or registered trademarks of HDMI Licensing LLC in the United States and other countries.

AVCHD™
Progressive

- HDAVI Control™ is a trademark of Panasonic Corporation.
- “AVCHD Progressive”, “AVCHD”, the “AVCHD Progressive” Logo and the “AVCHD” Logo are trademarks of Panasonic Corporation and Sony Corporation.

DOLBY
DIGITAL

- Manufactured under license from Dolby Laboratories. Dolby and the double-D symbol are trademarks of Dolby Laboratories.



- SDXC Logo is a trademark of SD-3C, LLC.
- QuickTime and the QuickTime logo are trademarks or registered trademarks of Apple Inc., used under license therefrom.
- Windows and Windows Vista are either registered trademarks or trademarks of Microsoft Corporation in the United States and/or other countries.
- iMovie, Mac and Mac OS are trademarks of Apple Inc., registered in the U.S. and other countries.
- YouTube is a trademark of Google Inc.
- Facebook® is a registered trademark of Facebook, Inc.
- This product uses “DynaFont” from DynaComware Corporation. DynaFont is a registered trademark of DynaComware Taiwan Inc.
- Other names, company names, and product names mentioned in these instructions are trademarks or registered trademarks of the companies concerned.

This product is licensed under the AVC patent portfolio license for the personal and non-commercial use of a consumer to (i) encode video in compliance with the AVC Standard (“AVC Video”) and/or (ii) decode AVC Video that was encoded by a consumer engaged in a personal and non-commercial activity and/or was obtained from a video provider licensed to provide AVC Video. No license is granted or shall be implied for any other use. Additional information may be obtained from MPEG LA, LLC.

See <http://www.mpegla.com>.