

Panasonic®

■ This product is eligible for the AVCCAM
3 Year Warranty Repair Program. For
details, see page 5.

Operating Instructions **Vol.1**

Memory Card Camera-Recorder

Model No. **AG-AF100P**

Volume **1**

Note that Operation Instructions Vol.1 describes basic operations of the Memory Card Camera-Recorder.
For instructions on advanced operations of the Memory Card Camera-Recorder, refer to Operating Instructions Vol.2 (pdf file) contained in the supplied CD-ROM.

AVCCAM

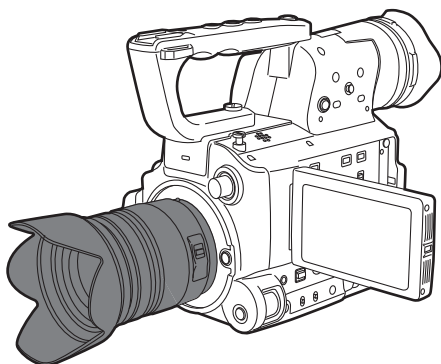

WV™
MICRO

AVCHD™

DOLBY
DIGITAL
STEREO CREATOR

HDMI™
HIGH DEFINITION MULTIMEDIA INTERFACE

SD™
XC

Before operating this product, please read the instructions carefully and save this manual for future use.



CAUTION
RISK OF ELECTRIC SHOCK
DO NOT OPEN



CAUTION: TO REDUCE THE RISK OF ELECTRIC SHOCK, DO NOT REMOVE COVER (OR BACK). NO USER-SERVICEABLE PARTS INSIDE. REFER TO SERVICING TO QUALIFIED SERVICE PERSONNEL.



The lightning flash with arrowhead symbol, within an equilateral triangle, is intended to alert the user to the presence of uninsulated "dangerous voltage" within the product's enclosure that may be of sufficient magnitude to constitute a risk of electric shock to persons.



The exclamation point within an equilateral triangle is intended to alert the user to the presence of important operating and maintenance (servicing) instructions in the literature accompanying the appliance.

WARNING:

- To reduce the risk of fire or electric shock, do not expose this equipment to rain or moisture.
- To reduce the risk of fire or electric shock hazard, keep this equipment away from all liquids. Use and store only in locations which are not exposed to the risk of dripping or splashing liquids, and do not place any liquid containers on top of the equipment.

WARNING:

Always keep memory cards or accessories (coin battery, microphone holder screws, microphone holder adaptor, cable clamper, screws for cable clamper, INPUT terminal covers, major hook) out of the reach of babies and small children.

CAUTION:

To reduce the risk of fire or electric shock and annoying interference, use the recommended accessories only.

CAUTION:

Do not jar, swing, or shake the unit by its handle while the conversion lens or another accessory is attached. Due to the added weight of the conversion lens, any strong jolt to the handle may damage the unit or result in personal injury.

CAUTION:

The mains plug of the power supply cord shall remain readily operable. The AC receptacle (mains socket outlet) shall be installed near the equipment and shall be easily accessible. To completely disconnect this equipment from the AC mains, disconnect the power cord plug from the AC receptacle.

CAUTION:

Danger of explosion or fire if battery is incorrectly replaced or mistreated.

- Do not disassemble the battery or dispose of it in fire.
- Do not store in temperatures over 60°C (140°F).
- Do not expose the battery to excessive heat such as sunshine, fire or the like.

For Battery Pack

- Use specified charger.
- Replace only with same or specified type.

For Battery of Remote Controller

- Replace battery with part No. CR2025 only.
- Do not recharge the battery.

CAUTION:

This apparatus can be operated at a voltage in the range of 110-240 V AC. Voltages other than 120 V are not intended for U.S.A. and Canada. Operation at a voltage other than 120 V AC may require the use of a different AC plug. Please contact either a local or foreign Panasonic authorized service center for assistance in selecting an alternate AC plug.

CAUTION:

In order to maintain adequate ventilation, do not install or place this unit in a bookcase, built-in cabinet or any other confined space. To prevent risk of electric shock or fire hazard due to overheating, ensure that curtains and any other materials do not obstruct the ventilation.

CAUTION:

Do not lift the unit by its handle while the tripod is attached. When the tripod is attached, its weight will also affect the unit's handle, possibly causing the handle to break and hurting the user. To carry the unit while the tripod is attached, take hold of the tripod.

CAUTION:

Excessive sound pressure from earphones and headphones can cause hearing loss.

CAUTION:

Do not leave the unit in direct contact with the skin for long periods of time when in use. Low temperature burn injuries may be suffered if the high temperature parts of this unit are in direct contact with the skin for long periods of time. When using the equipment for long periods of time, make use of the tripod.

FCC NOTICE (USA)

Declaration of Conformity

Model Number: AG-AF100P

Trade Name: Panasonic

Responsible Party: Panasonic Corporation of North America One Panasonic Way, Secaucus, NJ 07094

Support contact: 1-800-524-1448

This device complies with Part 15 of the FCC Rules.

Operation is subject to the following two conditions:

(1) This device may not cause harmful interference, and (2) this device must accept any interference received, including interference that may cause undesired operation.

To assure continued compliance, follow the attached installation instructions and do not make any unauthorized modifications.

CAUTION:

This equipment has been tested and found to comply with the limits for a Class B digital device, pursuant to Part 15 of the FCC Rules. These limits are designed to provide reasonable protection against harmful interference in a residential installation. This equipment generates, uses and can radiate radio frequency energy and, if not installed and used in accordance with the instructions, may cause harmful interference to radio communications. However, there is no guarantee that interference will not occur in a particular installation. If this equipment does cause harmful interference to radio or television reception, which can be determined by turning the equipment off and on, the user is encouraged to try to correct the interference by one of the following measures:

- Reorient or relocate the receiving antenna.
- Increase the separation between the equipment and receiver.
- Connect the equipment into an outlet on a circuit different from that to which the receiver is connected.
- Consult the dealer or an experienced radio/TV technician for help.

The user may find the booklet "Something About Interference" available from FCC local regional offices helpful.

FCC Warning:

To assure continued FCC emission limit compliance, follow the attached installation instructions and the user must use only shielded interface cables when connecting to host computer or peripheral devices. Also any unauthorized changes or modifications to this equipment could void the user's authority to operate this device.

NOTIFICATION (Canada)

This class B digital apparatus complies with Canadian ICES-003.

Cet appareil numérique de la classe B est conforme à la norme NMB-003 du Canada.

IMPORTANT

"Unauthorized recording of copyrighted television programs, video tapes and other materials may infringe the right of copyright owners and be contrary to copyright laws."



A lithium ion/polymer battery that is recyclable powers the product you have purchased. Please call 1-800-8-BATTERY for information on how to recycle this battery.

For USA-California Only

This product contains a CR Coin Cell Lithium Battery which contains Perchlorate Material – special handling may apply.

See www.dtsc.ca.gov/hazardouswaste/perchlorate.

IMPORTANT SAFETY INSTRUCTIONS

- 1) Read these instructions.
- 2) Keep these instructions.
- 3) Heed all warnings.
- 4) Follow all instructions.
- 5) Do not use this apparatus near water.
- 6) Clean only with dry cloth.
- 7) Do not block any ventilation openings. Install in accordance with the manufacturer's instructions.
- 8) Do not install near any heat sources such as radiators, heat registers, stoves, or other apparatus (including amplifiers) that produce heat.
- 9) Do not defeat the safety purpose of the polarized or grounding-type plug. A polarized plug has two blades with one wider than the other. A grounding-type plug has two blades and a third grounding prong. The wide blade or the third prong are provided for your safety. If the provided plug does not fit into your outlet, consult an electrician for replacement of the obsolete outlet.
- 10) Protect the power cord from being walked on or pinched particularly at plugs, convenience receptacles, and the point where they exit from the apparatus.
- 11) Only use attachments/accessories specified by the manufacturer.
- 12) Use only with the cart, stand, tripod, bracket, or table specified by the manufacturer, or sold with the apparatus. When a cart is used, use caution when moving the cart/apparatus combination to avoid injury from tip-over.
- 13) Unplug this apparatus during lightning storms or when unused for long periods of time.
- 14) Refer all servicing to qualified service personnel. Servicing is required when the apparatus has been damaged in any way, such as power-supply cord or plug is damaged, liquid has been spilled or objects have fallen into the apparatus, the apparatus has been exposed to rain or moisture, does not operate normally, or has been dropped.



Camera-Recorder

The rating plate is on the underside of the viewfinder.

AC Adaptor

The rating plate is on the underside of the AC Adaptor. Disconnect the AC mains plug from the AC mains socket when not in use.

■ **Batteries that may be used with this product (Correct as of December 2010)**

Panasonic VW-VBG260 and VW-VBG6 batteries may be used with this product.

The VW-VBG260 and VW-VBG6 batteries contain a function to enable verification as to whether they may be safely used with this product.

Recommendation for Use of Genuine Panasonic Battery (Rechargeable Battery)

Thank you for using a Panasonic product.

It has been found that counterfeit battery packs which look very similar to the genuine product are made available to purchase in some markets. Some of these battery packs are not adequately protected with internal protection to meet the requirements of appropriate safety standards. There is a possibility that these battery packs may lead to fire or explosion. Please be advised that we are not liable for any accident or failure occurring as a result of use of a counterfeit battery pack. To ensure that safe products are used we would recommend that a genuine Panasonic battery pack is used.

- Be aware that many batteries sold at extremely cheap prices or in situations where it is difficult to verify the actual products before purchase have proven to be counterfeit.

AVCCAM 3 Year Warranty Repair Program *1

Thank you for purchasing this Panasonic AVCCAM device.

Register as a user for this device to receive a special service warranty up to three years of free warranty repairs.

Customers who register as users on the website will receive an extended warranty repair valid for up to three years.



	1 st year	2 nd year	3 rd year
AVCCAM device*2	Basic warranty*3	Extended warranty repair*4	

*1: Please note that this extended warranty is not available in some countries/regions. *2: Not all models eligible for extended warranty coverage. *3: The basic warranty period may vary depending on the country/region. *4: Not all repair work is covered by this extended warranty.



Details about user registration and the extended warranty: http://panasonic.biz/sav/pass_e
 Please note, this is a site that is not maintained by Panasonic Canada Inc. The Panasonic Canada Inc. privacy policy does not apply and is not applicable in relation to any information submitted. This link is provided to you for convenience.

Contents

Volume 1 (This Book)

Read this first!	2
IMPORTANT SAFETY INSTRUCTIONS	4
Recommendation for Use of Genuine	
Panasonic Battery	
(Rechargeable Battery)	5
Outline of operations	8
Please read before use	9
Lenses compatible with this camera	9
Lens attachment and detachment	10
SD Memory Cards compatible with this product... ..	12
CLASS 4 (SD speed class 4)	13
CLASS 6 (SD speed class 6)	13
Operating precautions	14

Before use

Precaution for use	16
Accessories	19
Optional accessories	19

Description of parts

Description of parts	20
Left side	20
Right side and rear side	21
Left side and front side	22
Remote control	23

Preparation

Recharging the battery	23
Recharging	23
Power sources	25
Using the battery	25
Using the AC adaptor	25
Adjusting the hand strap	26
Attaching/detaching the handle	26
Attaching/detaching the grip	26
The remote control	27
Insert the battery	27
Remote control usable range	27
Turn on/off the camera	27
Tally lamp	28
Viewfinder	29
Using the viewfinder	29
Using the LCD	30
Emphasizing outlines	30
Adjusting the screen display	31
Changing backlight brightness	32
Setting the calendar	33

Shooting

Basic shooting operations	35
Preparing for recording	35
Checking photos taken (REC CHECK)	35
SD Memory Card access lamp	36
Selecting a slot	36
Formatting SD Memory Cards	36
SD Memory Card recording times	37
Removing SD Memory Card	38
Protecting SD Memory Cards	38
Repairing SD Memory Cards	38
Basic operations of the camera	39
Manual focusing	39
Using focus assist	40
Iris adjustments	40
Adjusting the gain	41
Light intensity adjustments	41
Adjusting the white balance	41

Menu

Using the setup menus	44
Using the menus	44
Initializing the menu settings	45
Setup menu structure	46
Menu	46

Reference

Specifications	48
-----------------------------	----

Shooting

Shooting in progressive mode
Shooting techniques for different targets
Adjusting the shutter speed
Switching Audio Input
Using scene files
Saving scene files and other settings on
 SD Memory Cards
Clip metadata
Using the Counter
Charging the built-in battery/
 Setting the time code

Playback

Basic playback operations
Thumbnail screen
Playback settings (PLAY SETUP)
Thumbnail operations
Useful playback functions

Editing

Connecting external units
Nonlinear editing

Displays

Screen displays

Menu

Setup menu list

Reference

Before calling for service
Updating the firmware incorporated into
 the unit
Cleaning
Storage Precautions
How to handle data recorded on
 SD Memory Card

Outline of operations

This camera-recorder is compatible with the AVCHD standard, and uses low-cost and easily-available SD/SDHC/SDXC Memory Cards as recording media. The unit enables high-quality picture recording of close to broadcasting standard, as well as highly creative video production.

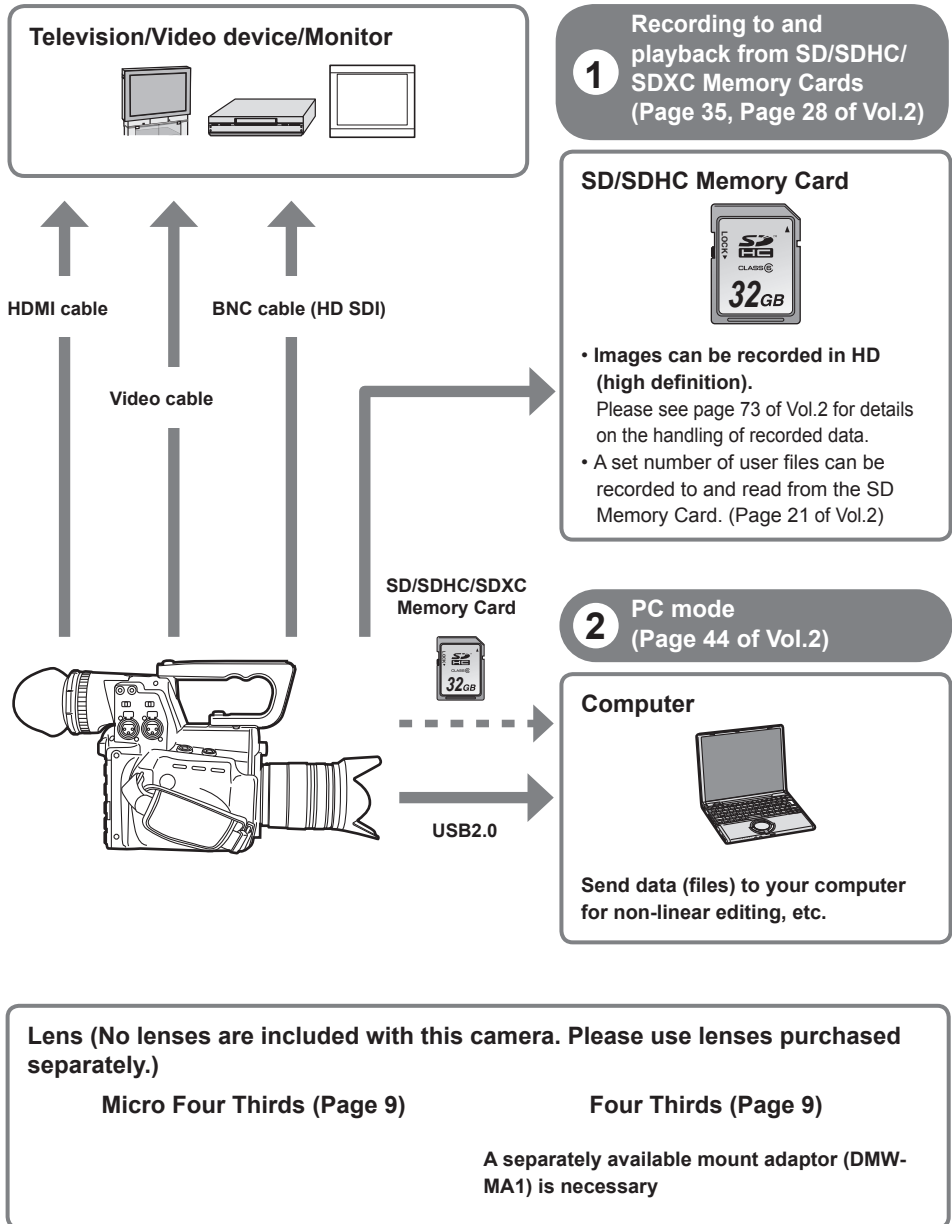

Please read before use

Lenses compatible with this camera

No lenses are included with this camera. Please use lenses purchased separately.

This camera includes a Micro Four Thirds™ system lens mount. However, the successful operation of all Micro Four Thirds and Four Thirds™ standard lenses cannot be guaranteed.

Also, some functions such as optical image stabilization (OIS) and auto focus (AF) cannot be used depending on the lens.

Panasonic has confirmed the compatibility of the following lenses (as of December 2010).

Please use a lens support when using large lenses weighing more than 1kg (2.2 lb). Not using a lens support may result in damage to the lens mount.

* **Micro Four Thirds™ and Four Thirds are trademarks or registered trademarks of Olympus Imaging Corporation in Japan, USA, the EU, and other countries.**

(○: Usable, ●: Some functions/features limited, —: Not usable)

Lens Type	AF *1		OnePush AF	MF	Camera Focus by Remote Control
	60i/60p/30p/50i/50p/25p	24p			
Micro Four Thirds Lens					
H-FS014045 (Panasonic) *2	● *3	● *4	○	○	○
H-FS045200 (Panasonic) *2	● *3	● *4	○	○	○
H-F007014 (Panasonic) *2	● *3	● *4	○	○	○
H-VS014140 (Panasonic)	○	○	○	○	○
H-H020 (Panasonic) *2	-	-	○	○	○
H-ES045 (Panasonic) *2	● *3	● *4	○	○	○
H-F008 (Panasonic) *2	● *3	● *4	○	○	○
H-FS014042 (Panasonic) *2	● *3	● *4	○	○	○
Four Thirds Lens (a mount adaptor (DMW-MA1), available separately, is necessary when using a Four Thirds lens)					
L-ES014050 (Panasonic) *2	-	-	-	○	-
L-RS014050 (Panasonic) *2	-	-	● *5	○	● *5
L-RS014150 (Panasonic) *2	-	-	● *5	○	● *5
L-X025 (Panasonic) *2	-	-	● *5	○	● *5
ZUIKO DIGITAL ED 14-35mm F2.0 SWD (OLYMPUS) *2	-	-	● *5	○	● *5

*1 Tracking becomes extremely slow in slow shutter mode.

*2 Sounds from focus and iris operation may be recorded.

*3 Tracking performance is inferior compared to H-VS014140 (lens for movie recording, Micro Four Thirds mount).

*4 AF tracking becomes slow in 24p mode.

*5 Limitations apply to the simultaneous operation of FOCUS and IRIS.

Note: use of H-VS014140 (lens for movie recording, Micro Four Thirds mount) is assumed throughout this operating instructions document.

For the latest information regarding supported lenses, please refer to Panasonic catalogs/web site etc.
<http://pro-av.panasonic.net/>

Precaution for use (continued)

Lens attachment and detachment

- Check that the power switch is set to OFF.

■ Attaching a lens to the camera

1 Turn the lens rear cap and body cap in the direction indicated by the arrows and remove.

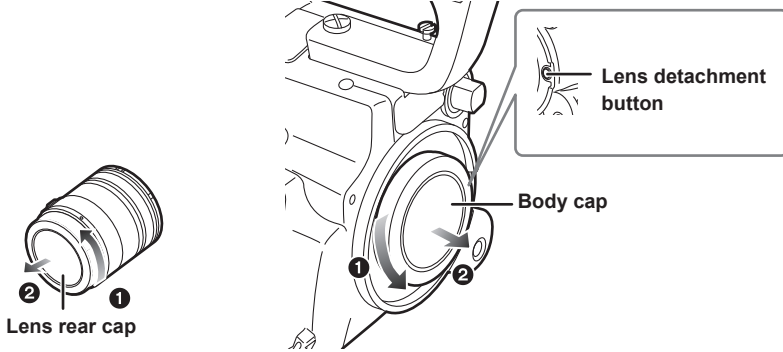

- Do not insert fingers into the mount.

2 Line up the lens attachment marks (red) on the camera and lens, and then turn the lens in the direction indicated by the arrows until it audibly clicks into place.

- Do not press the lens detachment button while attaching the lens.
- Damage may occur to the lens attachment if the lens is not at right angles to the camera during attachment.
- Ensure that the lens is attached properly.

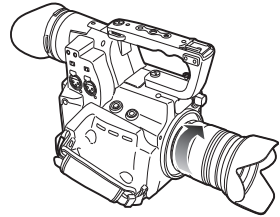

3 Remove lens cap.

- Remove lens cap prior to recording.

■ Detaching a lens from the camera

- 1 Attach the lens cap.**
- 2 While pressing the lens detachment button, turn the lens in the direction indicated by the arrows until it stops, and detach.**
- 3 Attach the body cap.**
 - Ensure that the body cap is attached to prevent dust or dirt from entering the camera.
 - To prevent damage to the lens connection, be sure to attach the lens rear cap.

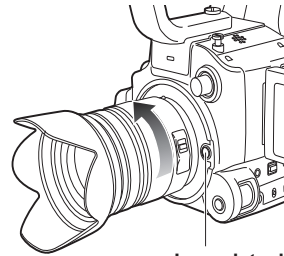

**Lens detachment
button**

-
- When using lenses other than those conforming to the Micro Four Thirds and Four Thirds standard, see the LENS CHECK item in the OTHER FUNCTIONS screen of MENU settings.
 - Change lenses in a place that is relatively free of dust and dirt.
 - When the power switch is [OFF] or when carrying the camera, attach the lens cap to prevent damage to the surface of the lens.
 - Be careful not to misplace the body cap, lens cap, or lens rear cap.
-

■ Enabling Image Stabilization

Image Stabilization can be enabled with lenses equipped with OIS.

Set the OIS switch of the lens to [ON]

Setting the OIS switch to [OFF] is recommended when using a tripod.

- Use the OIS switch on the camera if a lens has an Image Stabilization function but does not have an OIS switch. If the lens has an OIS switch, the OIS switch on the camera is disabled.

Please read before use (continued)

SD Memory Cards compatible with this product

Speed class 4 or above is required for recording in the PH mode or HA mode. Speed class 6 or above is required when using the VFR function. It is recommended that you use the following Panasonic SD memory cards, SDHC memory cards, or SDXC memory cards. (As of December, 2010)

Card type	Recording capacity	Recording/playback	Saving/reading of scene files and user files, reading of metadata
SD Memory Card	8 MB	Cannot be used.	Can be used.
	16 MB		
	32 MB	Successful operation cannot be guaranteed. Recording may be suddenly terminated with certain SD Memory Cards.	
	64 MB		
	128 MB		
	256 MB	Can be used.	
512 MB			
1 GB			
2 GB			
SDHC Memory Card	4 GB		
	6 GB		
	8 GB		
	12 GB		
	16 GB		
SDXC Memory Card	32 GB	Can be used.	
	48 GB		
	64 GB		

- Please see our support page at the following website for the latest information not included in these operating instructions.
<http://pro-av.panasonic.net/>
- This camera supports FAT12 & FAT16 formatted SD memory cards, FAT32 formatted SDHC memory cards, and exFAT formatted SDXC memory cards that are compliant with the SD standard.
- 4 GB (or greater) memory cards without the SDHC logo and 48 GB (or greater) memory cards without the SDXC logo are not based on the SD standard.
- Use this product to format the SD Memory Cards to be used. Formatting memory cards on computers or other devices may cause recording to take longer than normal, or may cause cards to become incompatible with this product. (Page 36) (Use this product to reformat any cards that have already been formatted on computers, etc.)
- MultiMediaCards cannot be used with this product.

(Continued on the next page)

CLASS 4 (SD speed class 4)

This refers to a class 4 speed standard (SD speed class) for the continuous writing of data between SD-compatible devices and SD Memory Cards, as designated by the SD standards.

When the use of an SD speed class 4 card is recommended for SD-compatible products, this indicates that stable recording operation can be achieved when using SD Memory Cards of class 4 and above.

CLASS 6 (SD speed class 6)

This refers to a class 6 speed standard (SD speed class) for the continuous writing of data between SD-compatible devices and SD Memory Cards, as designated by the SD standards.

When the use of an SD speed class 6 card is recommended for SD-compatible products, this indicates that stable recording operation can be achieved when using SD Memory Cards of class 6 and above.

Cautions for usage

- Do not allow dirt, water, or other substances to come into contact with the connector part on the reverse of the card.
 - Do not leave the card in the following places:
 - In direct sunlight or in places of high humidity, e.g. close to heating equipment
 - In highly humid or dusty locations
 - In locations with high variations in temperature (condensation may appear on card)
 - In places subject to static electricity or electromagnetic waves
 - Store cards in bags or cases after use.
-
-

Operating precautions

Do not allow any water to get into the camera-recorder when using it in the rain or snow or at the beach.

- Failure to heed this caution will cause the camera-recorder or a card to malfunction (and may result in irreparable damage).

Keep the camera-recorder away from equipment (such as TV sets and video game machines) that generate magnetic fields.

- Using the camera-recorder on top of or near a TV set may cause distortion in the images and/or sound due to the electromagnetic waves that the set emits.
- The powerful magnetic fields generated by speakers or large motors may damage your recordings or distort the images.
- The electromagnetic waves emitted from a microcomputer will adversely affect the camera-recorder, causing the images and/or sound to be distorted.
- If the camera-recorder is so adversely affected by products that generate magnetic fields that it no longer operates properly, turn it off and remove the battery or unplug the AC adaptor from the power outlet. Then install the battery again or reconnect the AC adaptor. After this, turn the camera-recorder back on.

Do not use the camera-recorder near radio transmitters or high-voltage equipment.

- Using the camera-recorder near a radio transmitter or high-voltage equipment may adversely affect the recorded images and/or sound.

Do not allow any sand or dust to get into the camera-recorder when using it at the beach and other similar places.

- Sand and dust can damage the camera-recorder or a card. (Be especially careful when inserting or removing a card.)

AC adaptor (battery charger) and battery

- If the CHARGE lamp continues to blink even when the battery temperature is normal, there may be something wrong with the battery or AC adaptor (battery charger). Contact your dealer.
- The battery takes longer to charge when it is warm.
- The AC adaptor (battery charger) can interfere with radio reception so keep radios at least 1

meter away from it.

- The AC adaptor (battery charger) may make some noise when you are using it, but this is normal.

Take precautions not to drop the camera when moving it.

- Strong impacts may damage the camera and cause it to stop working.
- Handle the camera with care, using the hand strap or shoulder strap to carry it.

Do not spray the camera with insect sprays or other volatile substances.

- These can warp the camera or cause the finish to come off.
- Do not leave the camera-recorder in contact with rubber or PVC products for extended periods of time.

After use, remove the battery and disconnect the AC power supply cord.

Battery characteristics

This camera-recorder uses a rechargeable lithiumion battery that uses its internal chemical reaction to generate electrical energy. This reaction is easily influenced by the ambient temperature and humidity, and the battery's effective operating time is reduced as the temperature rises or falls. If you use this camera at locations with extremely low temperatures, its operating time will be reduced.

Protective circuitry functions if you use the battery where it is very hot and you will have to wait before you can use it again.

Remove the battery after use.

Completely remove the battery. (The battery continues to be used even if you have turned the camera off.) The battery can over discharge if you leave it in the camera and it may become impossible to recharge it.

Disposing of spent batteries

The battery will become unchargeable. Rather than throwing the battery into the garbage, take it to a store that can assist in recycling it.

Do not remove the battery when the POWER switch is ON.

Disconnect the power supply after turning OFF the POWER switch and making sure the mode lamp is completely OFF.

What to remember when throwing memory cards away or transferring them to others

Formatting memory cards or deleting data using the functions of the unit or a computer will merely change the file management information: it will not completely erase the data on the cards. When throwing these cards away or transferring them to others, either physically destroy them or use a data deletion program for computers (commercially available) to completely erase the data. Users are responsible for managing the data on their memory cards.

Liquid crystal displays

- Images or letters can get burned onto the screen of the LCD or viewfinder if they are displayed for a long time, but you can fix this by leaving the camera off for several hours.
- The liquid crystal parts are highly precise with 99.99% of the pixels effective. This leaves less than 0.01% of pixels that may not light or may remain on all the time. These phenomena are normal and will have no effect on the images you shoot.
- Condensation may form if you use the camera where temperatures fluctuate. Wipe dry with a soft, dry cloth.
- The LCD may appear dim after immediately turning on a cold camera, but will brighten as the camera warms up.

Do not point the lens or viewfinder at the sun.

Doing so may damage the parts inside.

Protective caps for the connectors

Keep the protective caps fitted over any connectors that are not being used.

Precaution for use

Always take some trial shots before actual shooting.

- When shooting important events (such as weddings), always take some trial shots and check that the sound and images have been recorded properly before actual shooting.

Be sure to check and set the calendar and time zone.

- These settings affect the control and playback sequence of the recorded contents. Before making a recording, set and check the calendar and time zone. (Page 33)

Panasonic makes no guarantees for your recordings.

- In the unlikely event that content that was not recorded due to a fault related to this camera or SD/SDHC/SDXC memory card during use, please understand that no compensation can be provided.

Respect copyrights

- Copyright laws forbid the use of video and audio material you have recorded for any purpose other than your own personal enjoyment. Remember that restrictions apply to the shooting of certain material even if it is intended for private use.

Caution regarding laser beams

- Lenses may suffer damage if it is struck by a laser beam. Ensure that laser beams do not strike the lens when shooting in an environment where laser devices are used.

Media that can be used in this unit

- SD/SDHC/SDXC memory cards can be used. See page 12 for details.

Mounting the camera-recorder on a tripod

- The tripod mounting hole supports 1/4-20UNC and 3/8-16UNC screws. Please use this in according to the fixing screw on the tripod.
- The depth of the tripod mounting hole is 5.5mm. Avoid applying excessive force to the tripod screws when mounting the camera onto a tripod.

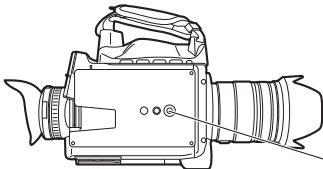

Attach the tripod to the tripod hole on the bottom side.

About this manual

Note concerning illustrations in these instructions

- Illustrations (camera-recorder, menu screens, etc.) in these operating instructions differ slightly from the actual camera-recorder.

References

- References are shown as (Page 00).

SD/SDHC/SDXC Memory Cards

- SD/SDHC/SDXC memory cards are noted as SD memory cards.

- The SDHC logo and SDXC logo are trademarks of SD-3C, LLC.
- “AVCHD” and the “AVCHD” logo are trademarks of Panasonic Corporation and Sony Corporation.
- This product has been manufactured under license from Dolby Laboratories. Dolby and the double-D symbol are trademarks of Dolby Laboratories.
- HDMI, the HDMI logo, and High-Definition Multimedia Interface are trademarks or registered trademarks of HDMI Licensing LLC.
- LEICA is a registered trademark of Leica Microsystems IR GmbH.
- DICOMAR is a registered trademark of Leica Camera AG.
- Microsoft®, Windows®, and Windows Vista® are either registered trademarks or trademarks of Microsoft Corporation in the United States and/or other countries.
- Screenshots are used in accordance with Microsoft Corporation guidelines.
- IBM and PC/AT are registered trademarks of International Business Machines Corporation.
- Intel® is a registered trademark or a trademark of Intel Corporation in the United States and/or other countries.
- Apple®, Macintosh®, and Mac OS® are trademarks or registered trademarks of Apple Inc. in the United States and/or other countries.
- Other model names, company names, and product names listed in these operating instructions are trademarks or registered trademarks of their respective companies.
- This product is licensed under the AVC Patent Portfolio License for the personal and non-commercial use of a consumer, and no license is granted or shall be implied for any use other than the personal uses detailed below.
 - To encode video in compliance with the AVC standard (“AVC Video”)
 - To decode AVC Video that was encoded by a consumer engaged in a personal and non-commercial activity
 - To decode AVC Video that was obtained from a video provider licensed to provide AVC Video
 - Additional information may be obtained from MPEG LA, LLC (<http://www.mpegla.com>).
 - Separate license contracts must be obtained from MPEG LA where SD Memory Cards containing information recorded with this product are to be distributed to end users for commercial purposes. “End user” refers to persons or organizations handling such contents for personal use.

■ What is AVCHD?

AVCHD is a standard for the recording and playback of highly detailed, high-definition video.

Video is compressed in the MPEG-4 AVC/H.264 formats, and audio is recorded in Dolby Digital or linear PCM.

Information regarding compatibility of SDHC Memory Cards and recorded video

SDHC/SDXC Memory Cards









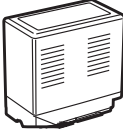
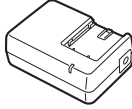
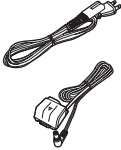
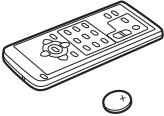

- SDHC/SDXC Memory Cards cannot be used with non-SDHC-compatible equipment.
- Ensure that all equipment is SDHC/SDXC-compatible when using card with other devices.

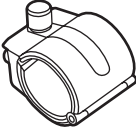
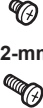

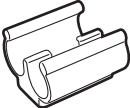
Compatibility of recorded video

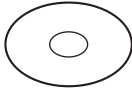
- Recorded video cannot be used with non-AVCHD-compatible equipment. For details, please see your product's operating instructions.
- Recorded video cannot be played back on non-compatible (non-AVCHD-compatible) equipment.
- Playback may not always be possible on all AVCHD-compatible equipment. Please use this product for playback in such instances.

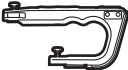
Accessories

<p>Battery</p> 	<p>AC Adaptor (Battery charger)</p> 	<p>AC power supply cords/ DC cord</p> 	<p>Wireless remote control and battery (CR2025) (Page 27)</p> 	<p>Before use</p>
<p>Eye cup (Page 29)</p> 	<p>Microphone holder (Page 41 of Vol.2)</p> 	<p>Microphone holder screws M4) (Page 41 of Vol.2) Length 6-mm (M4) (2) Length 12-mm (M4) (2)</p> 	<p>Microphone holder adaptor (Page 41 of Vol.2)</p> 	
<p>Cable clamper (Page 41 of Vol.2)</p> 	<p>Screws for cable clamper Length 4-mm (M2) (1) (Page 41 of Vol.2)</p> 	<p>CD-ROM</p> 		
<p>The following accessories are attached to the unit.</p>				
<p>Bodycap</p> 	<p>Handle</p> 	<p>Grip</p> 	<p>INPUT 1/2 terminal cover (2)</p> 	

• Please consult a retailer when purchasing additional accessories.

Optional accessories

- **XLR microphone**
AG-MC200G
- **Battery**
VW-VBG6 (7.2 V, 5800 mAh (typ.))

Description of parts

Left side

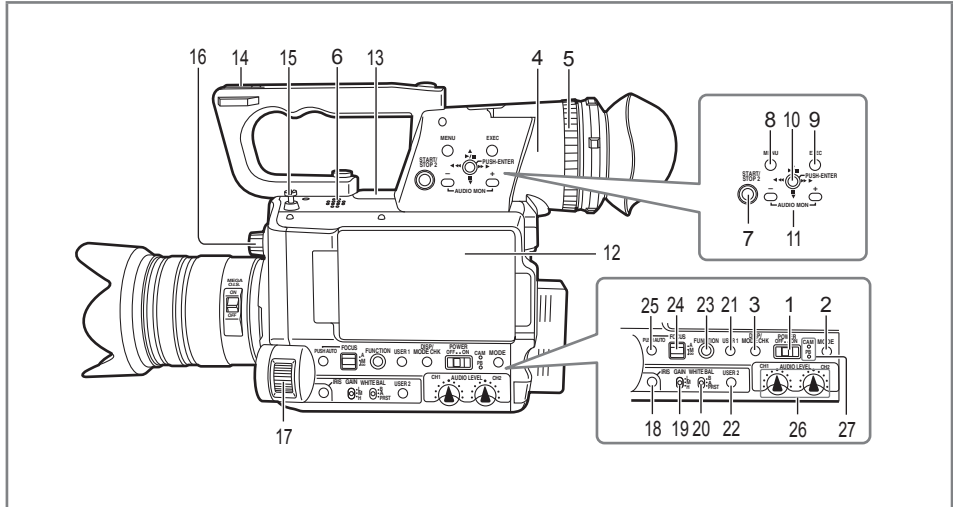

- | | |
|---|--|
| 1 POWER switch (Page 27) | 19 GAIN switch (Page 41) |
| 2 MODE button (Page 28 of Vol.2) | 20 WHITE BAL switch (Page 41) |
| 3 DISP/MODE CHK button (Page 6 of Vol.2) | 21 USER1 button (Page 11 of Vol.2) |
| 4 Viewfinder (Page 29) | 22 USER2 button (Page 11 of Vol.2) |
| 5 Diopter adjustment dial (Page 29) | 23 FUNCTION knob (Page 10 of Vol.2) |
| 6 Built-in speaker (Page 40 of Vol.2) | 24 FOCUS switch (Page 39) |
| 7 START/STOP2 button (Page 35) | 25 PUSH AUTO button (Page 39) |
| 8 MENU button (Page 44) | 26 AUDIO LEVEL dial (CH1, CH2)
(Page 18 of Vol.2) |
| 9 EXEC button (Page 35 of Vol.2) | 27 Mode lamp (Page 27) |
| 10 OPERATION lever | |
| 11 AUDIO MON/ADV button
(Pages 12 and 40 of Vol.2) | |
| 12 LCD monitor (Page 30, Page 45 of Vol.2) | |
| 13 Built-in microphone (Page 17 of Vol.2) | |
| 14 Light shoe | |
| 15 Major hook | |
| 16 ND dial (Page 41) | |
| 17 IRIS dial (Page 40) | |
| 18 IRIS button (Page 40) | |

Right side and rear side

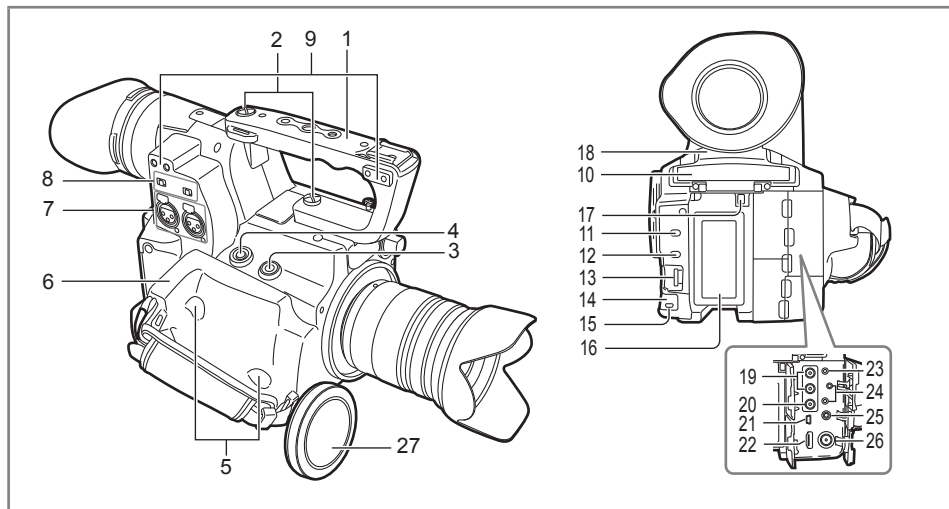

Description of parts

- | | |
|---|---|
| <ul style="list-style-type: none"> 1 Handle (Page 26) 2 Handle attachment screw (x2) (Page 26) 3 USER3 button (Page 11 of Vol.2) 4 START/STOP1 button (Page 35) 5 Grip attachment screw (x2) (Page 26) 6 Grip (Page 26) 7 INPUT 1/2 terminal (XLR3 pin) (Page 17 of Vol.2) 8 INPUT 1/2 (audio input switching) switch (Page 17 of Vol.2) 9 Microphone holder attachment (x2) (Page 41 of Vol.2) 10 SD memory card slot and SD memory card access lamp (Pages 36 and 38) 11 SLOT SELECT button (Page 36, Page 31 of Vol.2) 12 DIAL SELECT button (Page 14 of Vol.2) 13 SHUTR/F.RATE dial (Page 14 of Vol.2) 14 Remote control sensor (rear) (Page 27) 15 Tally lamp (rear) (Page 28) 16 Battery compartment (Page 25) 17 Battery release button (Page 25) | <ul style="list-style-type: none"> 18 Card slot cover and OPEN lever (Page 38) 19 AUDIO OUT CH1/CH2 terminal (Page 42 of Vol.2) 20 VIDEO OUT terminal (Page 42 of Vol.2) 21 USB terminal (Page 42 of Vol.2) 22 HDMI OUT terminal (Page 42 of Vol.2) 23 INDEX REMOTE jack (2.5mm stereo mini jack) 24 CAM REMOTE jack *
FOCUS/IRIS (3.5mm mini jack)
S/S (2.5mm mini jack)
You can connect a remote control unit (optional) to control the FOCUS and IRIS (aperture), as well as REC start / stop operation.
* Do not connect any equipment except the remote control to the CAM REMOTE jack. Connecting any equipment other than the remote control may cause the image brightness to change and/or the images to appear out of focus. 25 Headphone jack (3.5mm stereo mini jack) (Page 41 of Vol.2) 26 SDI OUT terminal (Page 42 of Vol.2) 27 Body cap (Page 10) |
|---|---|

Left side and front side

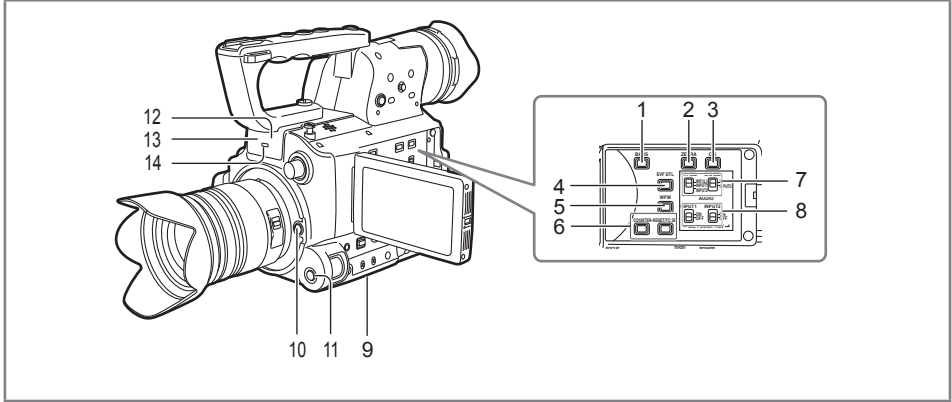

- 1 BARS button (Page 11 of Vol.2)
- 2 ZEBRA button (Page 5 of Vol.2)
- 3 OIS button (Page 11 of Vol.2)
- 4 EVF DTL button (Page 30)
- 5 WFM button (Page 12 of Vol.2)
- 6 COUNTER – RESET/TC SET button (Page 24 of Vol.2)
- 7 CH1/CH2 SELECT switch (Page 17 of Vol.2)
- 8 INPUT 1/2 switch (MIC POWER +48V) (Page 17 of Vol.2)
- 9 Tripod hole (bottom side) (Page 16)
- 10 Lens detachment button (Page 11)
- 11 AWB button (Page 41)
- 12 White balance sensor (Page 43)
- 13 Remote control sensor (front) (Page 27)
- 14 Tally lamp (front) (Page 28)

Remote control

To use the remote control, set the IR REMOTE item on the OTHER FUNCTIONS menu to ON. The default setting for this item is OFF. (Page 62 of Vol.2)

The following buttons are for functions that cannot be executed on this camera-recorder.

-  button

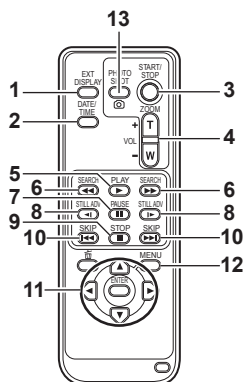

Remote control usable range (Page 27)

1 EXT. DISPLAY button (Page 40 of Vol.2)

2 DATE/TIME button (Page 40 of Vol.2)

3 START/STOP button

Same function as the START/STOP button on the camera.

4 ZOOM/VOL buttons (Page 40 of Vol.2)

5 PLAY button (Page 28 of Vol.2)

6 SEARCH buttons (Pages 28 and 39 of Vol.2)

7 PAUSE button (Page 28 of Vol.2)

8 STILL ADV buttons (Page 40 of Vol.2)

9 STOP button (Page 28 of Vol.2)

10 SKIP buttons (Pages 28 and 39 of Vol.2)

11 OPERATION buttons

Same function as the Operation lever on the camera.

12 MENU button

Same function as the MENU button on the camera.

13 PHOTO SHOT button (Page 13 of Vol.2)

Same function as the CAPTURE feature assigned to a USER SW function on the camera.

Description of parts

Preparation

Recharging the battery

Recharging

The battery does not come ready charged when the camera is purchased. Charge the battery before use. It is recommended that you keep one extra battery as a spare.

1 Connect the power cord to the AC adaptor.

Disconnect the DC cord.
(Battery cannot be charged if DC cord is connected.)

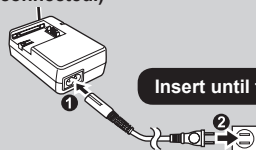

2 Insert the battery.

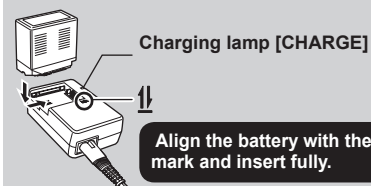

Description of parts (continued)

■ Charging lamp

On: Charging in progress

Off: Charging complete

Flashing: See below

■ If charging lamp is flashing

Check that there is no dirt, dust, or other substances attached to the connectors on the battery or AC adaptor, and ensure that the adaptor has been connected correctly.

- If there is dirt or dust on the connectors, disconnect the power plug from the socket before cleaning.
- If the charging lamp continues to flash, there may be a fault with the battery or the AC adaptor. Please consult with the place of purchase.

■ Charging time and available recording time (Approx.)

Battery model	Voltage/capacity	Charging time	Maximum continuous recording time
CGA-E/625 (included)	7.2 V/ 5800 mAh (typ.) 5400 mAh (min.)	Approx. 350 minutes	Approx. 230 minutes
VW-VBG6 (optional)	7.2 V/ 5800 mAh (typ.)	Approx. 350 minutes	Approx. 230 minutes

- The figures in the table above are guidelines for use in normal temperature conditions (temperature 25 °C (77 °F), humidity 60%). Charging may take longer in higher or lower temperatures.
- Charging may take longer if the battery has not been in use for a long period of time.
- Given here are the approximate continuous recording times when recording using the viewfinder with no connections to any external devices and with the LCD monitor closed.
- Available recording time may vary according to usage conditions.
- Charging times are based on charging batteries from an empty state.

■ Remaining battery capacity displays

When using Panasonic-manufactured batteries compatible with this product, the remaining battery capacity is displayed in minutes.



 90min

Time remaining will be displayed after a brief

pause.

- The battery display will change

 →  →  →  → 

as battery capacity decreases.  will be displayed in red when less than 3 minutes are remaining, and  will flash when the battery is empty.

- Remaining battery capacity may not be displayed correctly when using in high or low temperatures, or when the battery has not been used for a long period of time. To ensure that remaining battery capacity is displayed correctly, use the battery completely from a fully-charged state, and charge the battery again. (Remaining battery capacity may still not be displayed correctly if the battery has been used for long periods in high or low temperatures, or if the battery has been recharged a large number of times.)
- The remaining battery capacity display is a guideline and may change according to usage conditions.
- The remaining battery capacity display will momentarily disappear when switching between modes, when conducting REC CHECK operations or when changing the LCD brightness since the capacity is recalculated at these times.
- Not displayed when using AC adaptor.

• Keep metal objects (such as necklaces and hairpins) away from the battery.

Short-circuiting may occur across the terminals, causing the battery to heat up, and you may seriously burn yourself if you touch the battery in this state.

- The battery becomes hot while it is being used or charged. The camera-recorder itself also becomes hot during use.
 - The recordable time reduces if you repeatedly start and stop recording.
 - The battery takes longer to charge when it is warm.
 - The AC adaptor can interfere with radio reception so keep radios at least 1 meter away from it.
 - The AC adaptor may make some noise when you are using it, but this is normal.
 - Battery cannot be recharged when the DC cord is connected to the AC adaptor.
-

Power sources

Using the battery

Installation

Insert the battery until it clicks into place.

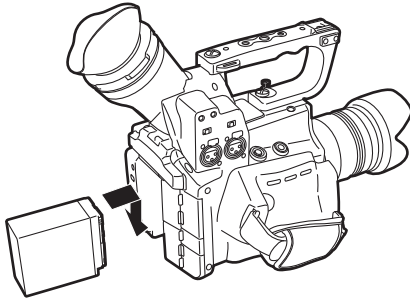

Removal

- 1 Set the POWER switch to OFF, and check that the mode lamp is off.

- 2 Remove the battery while pressing the battery release button.

- Support the battery with your hand to ensure that it will not fall.

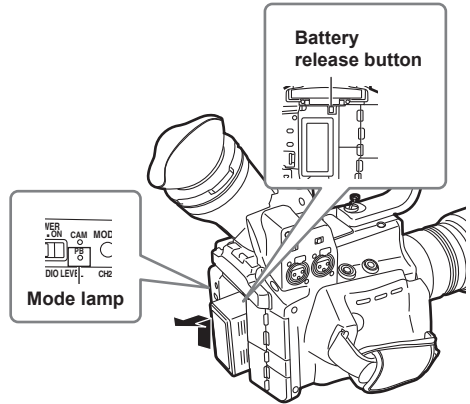

Using the AC adaptor

Installation

- 1 Connect the DC cord to the AC adaptor.
- 2 Plug the AC power supply cord into the power outlet.
- 3 Insert the DC cord's battery connector until it clicks into place.

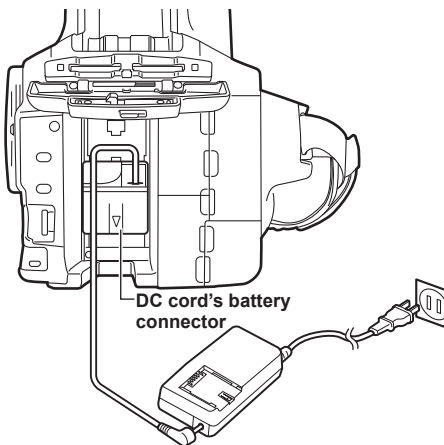

Removal

- 1 Set the POWER switch to OFF, and check that the mode lamp is off.
- 2 Remove the DC cord's battery connector while pressing the battery release button.
- 3 Disconnect the AC power supply cord from the power outlet.

- Battery cannot be recharged when the DC cord is connected to the AC adaptor.
- Disconnect the AC power supply cord from the power outlet when the unit is not going to be used.

CAUTION:

- This apparatus can be operated at a voltage in the range of 110 – 240 V AC. Voltages other than 120 V are not intended for U.S.A. and Canada. Operation at a voltage other than 120 V AC may require the use of a different AC plug. Please contact either a local or foreign Panasonic authorized service center for assistance in selecting an alternate AC plug.

Adjusting the hand strap

Adjust the hand strap to suit your hand.

- 1** Open the cover and adjust the length.
- 2** Close the cover.
 - Make sure the cover is fully closed.

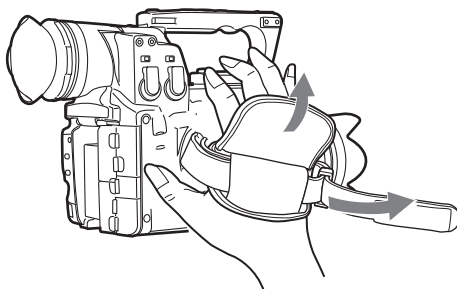

Attaching/detaching the handle

Detaching the handle

- 1** Use a Philips-head screwdriver and remove the two screws.
- 2** Slide in the direction of the arrow.
The handle will detach.

Attaching the handle

Carry out the reverse of the detaching procedure to attach the handle.

- Ensure both screws are firmly fixed in place.
- When holding the handle, make sure the screws are not loose.

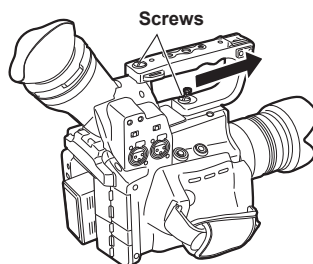

Attaching/detaching the grip

Detaching the grip

- 1** Use a Philips-head screwdriver and remove the two screws.
- 2** Slide in the direction of the arrow.
The grip will detach.

Attaching the grip

Carry out the reverse of the detaching procedure to attach the grip.

- When attaching, ensure both screws are firmly fixed in place.

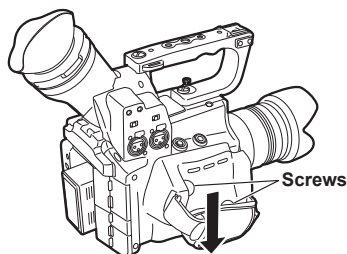

The remote control

Insert the battery

- 1 Push the catch in the direction shown by arrow ① to remove the holder.

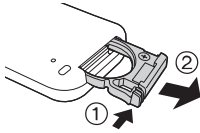

- 2 Insert the battery with the “+” marked side facing up.

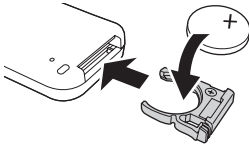

- 3 Return the holder to its original position.

- When the battery (CR2025) has run out, replace it with a new one. (The battery lasts about one year, depending on the frequency of use.) If the remote control unit fails to work even when it is operated near the camera-recorder's remote control sensor, the battery has run out.
- **Keep the battery out of the reach of children.**

Remote control usable range

The distance between the remote control and the unit's remote control sensor: Within approx. 5 m
Angle: Approximately 10° upward,
approximately 15° downward,
approximately 15° leftward, or
approximately 15° rightward
(when the accessory battery is used)

Remote control sensor (Rear)

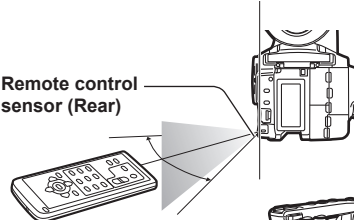

Remote control sensor (Front)

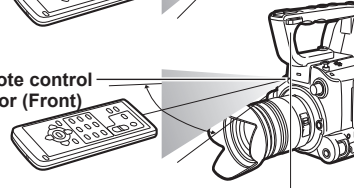

- The remote control is intended for indoor operation. Outdoors or under strong light, the unit may not operate properly even within the usable ranges.
- The remote control is set to OFF in the factory settings. When using the remote control, set the REMOTE CONTROL item in the OTHER FUNCTIONS screen to ON. (Page 62 of Vol.2)

Preparation

Turn on/off the camera

Set the POWER switch to ON.

Turn on the camera:

The mode lamp (CAM) lights red (CAMERA mode) and the camera is now in the recording pause mode.

Turn off the camera:

The mode lamp (CAM/PB) goes out.

• Energy-saving mode

According to the settings made in the POWER SAVE item of the OTHER FUNCTIONS screen in the settings menu, the following will apply if no designated operations* are performed for approximately five minutes while recording is paused (when an SD Memory Card has been inserted).

ON: The camera recorder turns off automatically.

OFF: Does not switch OFF the camera.

* See the setup menus, POWER SAVE (Page 63 of Vol.2) for details.

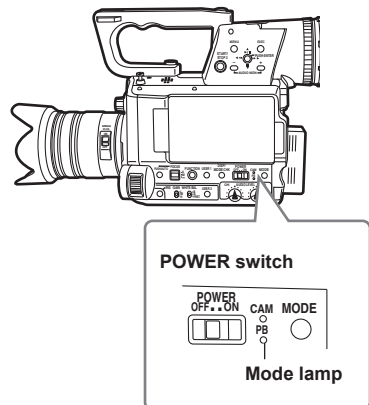

Tally lamp

The tally lamp can be illuminated during recording by setting the TALLY LAMP item of the OTHER FUNCTIONS screen (Page 62 of Vol.2) to any setting other than OFF.

The tally lamp will flash in any of the following circumstances.

- Receiving remote control operation (flashes 8 times per second)
- Recording error has occurred (flashes 4 times per second)
- Battery is low (flashes 4 times per second)
- Available SD Memory Card capacity is low (flashes 4 times per second)
- Remaining battery capacity is low (flashes once per second)
- Remaining memory of the SD Memory Card is low (flashes once per second)

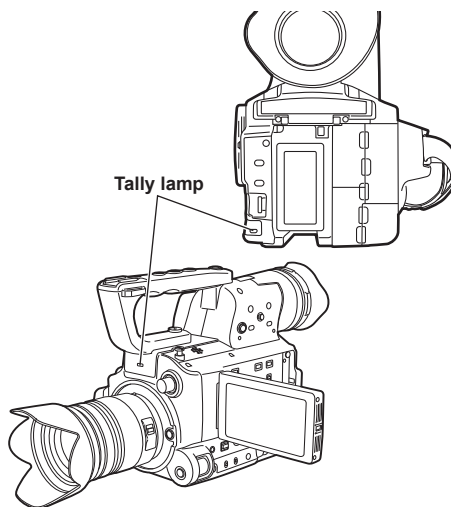

Viewfinder

This camera has two viewfinders; one is a miniature LCD in the viewfinder and the other is a retractable 3.5-inch LCD.

Use the viewfinder that best suits the application and shooting conditions.

- The brightness and hue may differ between the images appearing on the viewfinder and LCD monitor and those displayed on a TV monitor. To see how the final images will appear, check them on a TV monitor.

Using the viewfinder

- 1 Set the POWER switch to ON and check that images appear in the viewfinder.**
- 2 Adjust the viewfinder's angle so that the screen is positioned where it is easiest to see.**
 - You can move the viewfinder out to about 90° perpendicular to the camera.
- 3 Adjust the diopter adjustment dial so that you can see the characters on the viewfinder screen clearly.**

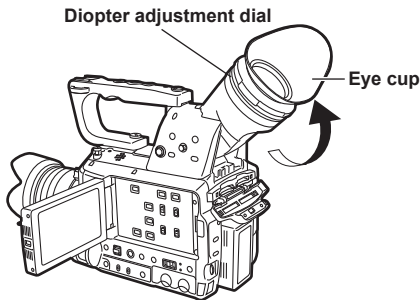

Do not allow the eyepiece of the viewfinder to remain in direct contact with sunlight or other strong light sources.

- Internal components may be damaged and fire may be caused if light accumulates through the lens.
- When the LCD monitor is open, the viewfinder may not display anything. Close the LCD monitor.

Fitting the eye cup

Attach the eye cup by aligning the projections on the eye cup holder and eye cup and fitting them together.

- Turning the eye cup after attaching it may cause the eye cup holder to come off. If the eyecup holder does come off, see "Cleaning the Viewfinder" (Page 71 of Vol.2) for details on how to refit it.

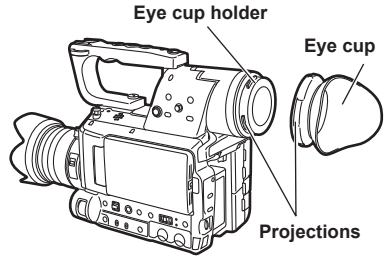

Preparation

- The pixels of the LCD monitor are controlled to obtain high precision with 99.99 % of the effective pixels. This leaves less than 0.01 % of pixels that may not light or may remain on all the time. These phenomena are normal and will have no effect on the images you shoot.
- Screen burn-in may occur in the LCD monitor. However, this is not a defect.

Using the LCD

- 1 Set the POWER switch to ON.
(Page 27)
- 2 Open the LCD monitor.
 - The monitor opens to an angle of 90 degrees. The camera may be damaged by attempting to open it further than this.

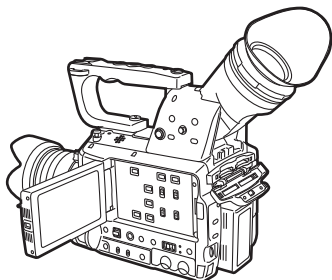

- 3 Position the LCD monitor where it is easiest to see.

- The monitor can be rotated 180° toward the lens and 90° toward you.
- Do not apply unnecessary force to the open LCD. This can damage the camera.

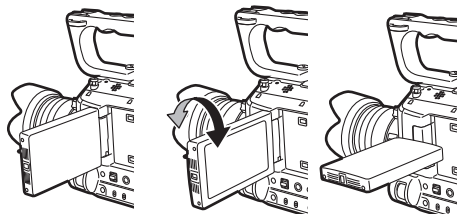

- Ensure the LCD is fully closed.
- Operation status displays during self-portrait recording

No display: Cannot record (no card, etc.)

○: Recording in progress, during transition to the recording pause mode

□□: Recording paused (recording standby)

! : Warning display

Emphasizing outlines

Emphasizing the outlines of the images you see in the viewfinder or on the LCD makes it easier to focus.

Emphasizing the outlines does not effect the images you shoot.

- 1 In CAM mode, press EVF DTL button.
“EVF DTL ON” appears on the screen for about 2 seconds.

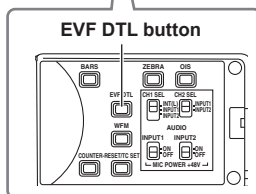
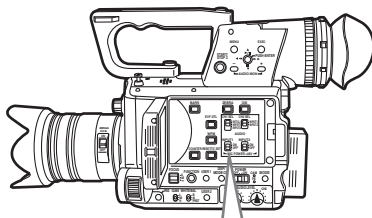

Press EVF DTL button again to return to the original display. “EVF DTL OFF” appears on the screen for about 2 seconds.

Adjusting the screen display

1 Set the POWER switch to ON. (Page 27)

2 Press the MENU button.

- For menu operation (Page 44)
- Operations may also be performed using buttons on the remote control that correspond to those on the camera. For details, see “Description of parts (Remote control)”. (Page 23)

3 Viewfinder adjustments

Set YES under EVF SET on the setting menu DISPLAY SETUP screen.

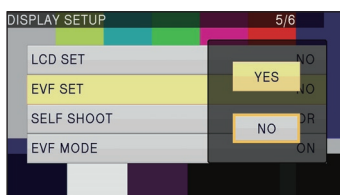

LCD monitor adjustments

Set YES under LCD SET on the setting menu DISPLAY SETUP screen.

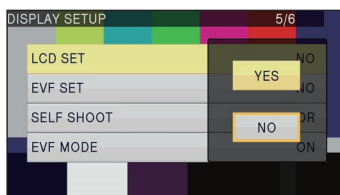

4 Select the desired item by tilting the Operation lever in the ▲▼ directions, and push the Operation lever.

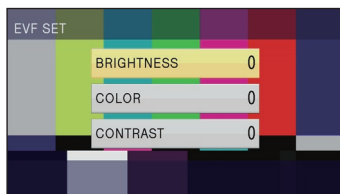

5 Adjust the selected item by tilting the Operation lever in the ◀▶ directions.



6 Press MENU button to exit the menus.

- The viewfinder display can be in color or black and white. (See the setup menus, DISPLAY SETUP screen, EVF COLOR.) The resolution is the same for both of them.

Changing backlight brightness

The brightness of the LCD monitor backlight can be adjusted between five different settings.

- 1 Select LCD BACKLIGHT from the setup menu DISPLAY SETUP screen.**
- 2 Select and set a value in the range of +1 to -3.**
The greater the value the brighter the screen.

-
- This setting will remain saved even if the camera's power is switched off.
-

Setting the calendar

The CLOCK SET value is recorded in the contents (clip), and affects the sequence of playback of the thumbnails. Before carrying out recording, be sure to check and set TIME_ZONE and CLOCK SET. This shows you how to adjust the calendar to 17:20 on December 25, 2010.

1 Set the camera's power switch to ON. (Page 27)

2 Press the MENU button.

- Menu operation (Page 44)
- Operations may also be performed using buttons on the remote control that correspond to those on the camera. For details, see "Description of parts (Remote control)". (Page 23)

3 Select the TIME_ZONE item on the settings menu OTHER FUNCTIONS screen, and push the Operation lever (or tilt lever in ► direction).

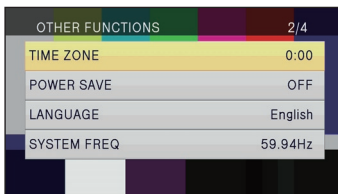

4 Pushing the Operation lever twice brings up the setting screen. Tilt the Operation lever in the ◀► directions to set the time difference from Greenwich Mean Time, and push the Operation lever again.

Factory default setting is +00:00.

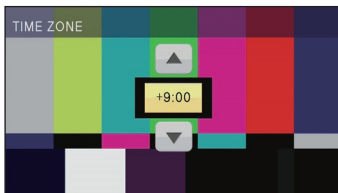

5 Tilt the Operation lever in the ◀ direction and select YES in the CLOCK SET item on the settings menu OTHER FUNCTIONS screen.

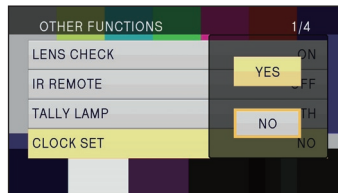

6 Tilt the Operation lever in the ▲▼ directions and set to DEC.



7 Tilt the Operation lever to the ► direction to change to the next item, and set to 25 by tilting in the ▲▼ directions.



8 Repeat steps 6 and 7 to set the remaining items.



- The date can be set to any date between January 1, 2000 and December 31, 2039.
- For any date after December 31, 2039, "- -" will appear on screen.
- Time is displayed in 24-hour format.

9 When settings are complete, push the Operation lever, select YES on the confirmation screen, and push the Operation lever again.

-
- The clock can vary in accuracy so check that the time is correct before shooting.
 - When using the camera overseas, do not set the CLOCK SET option to the local time, but instead enter the time difference from Greenwich mean time according to TIME ZONE. (Page 63 of Vol.2)
-

Basic shooting operations

Preparing for recording

- 1 Turn the POWER switch to ON.** (Page 27)
 - Make sure the mode lamp is lit up.
- 2 Lift the viewfinder up, and slide the card slot cover OPEN lever right to open.**
- 3 Fully insert an SD Memory Card into the card slot.**
- 4 Close the SD Memory Card slot cover.**
 - Ensure that the cover firmly clicks into place.

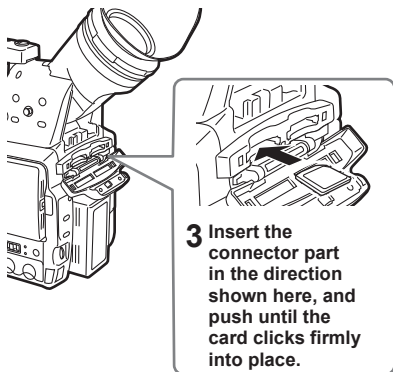

- Do not perform any of the following operations while the SD Memory Card access lamp is flashing.
Performing these operations may damage the SD Memory Card or its contents, or cause the camera to fail to operate correctly.
 - Opening the card door and removing the SD Memory Card
 - Switching off the power
 - Connecting or disconnecting the USB connection cable
 - Shaking or striking the camera
- Always format SD Memory Cards that have been used in other devices when first using them with this camera. (Page 36)
- If “CHECK CARD” is displayed on the viewfinder or the LCD monitor, please remove the SD Memory Card and insert it again.

- The images shot from when shooting starts until it is stopped are recorded as one clip.
- When recording is paused after a short period, a small amount of time may be required after pressing the START/STOP button to stop recording before writing to the SD Memory Card is terminated.
This means that operations cannot be accepted if the START/STOP button is pressed immediately.
- The camera will read information from the SD Memory Card immediately after the card is inserted. Press the START/STOP button to begin recording after PAUSE is displayed in the operation status display. (Page 47 of Vol.2)
- The camera’s factory default setting is PH mode 1080/60i recording.
(To view current setting status: Page 6 of Vol.2)
- The upper limit for the number of clips which can be recorded on a single SD Memory Card is 900. (However, this number may exceed 900 clips at times such as when shooting immediately after the POWER switch has been set to ON.)

Checking photos taken (REC CHECK)

- When recording is paused, the REC CHECK function can be used to review the video and audio recorded 2 seconds immediately prior. You can assign the REC CHECK function to USER switch 1/2/3 via the menu.
- The REC CHECK images are also recorded when a device is connected to the camera and backup images have been recorded.
 - The REC CHECK function does not work when PC has been selected as the operation mode.
 - This function does not work if the REC format is changed, if the camera is set to the CAM mode after having been switched to the PB mode, if the SD memory card slot cover is opened, or if the slot is switched after shooting.

SD Memory Card access lamp

CAM mode/PB mode

Illuminated orange: Reading/writing possible

Flashing orange (fast): Verifying card/inspecting card for possible defects

Flashing orange (slow): Accessing card

Flashing green (slow): Card write-protected/
no space left on card

Illuminated green: Card not selected for recording

Off: No card inserted/unformatted or incompatible card inserted

When the USB is connected

Flashing orange: Accessing card

Off: A status other than access underway.

SD Memory Card access lamp

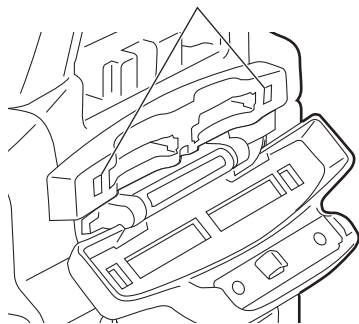

Selecting a slot

Of the two SD memory card slots, the slot to be used for recording can be switched.

1 Press the SLOT SELECT button while recording is paused.

The access lamp of the slot for recording lights up orange.

- This function works when a recordable SD card is inserted in both slots.
- The slot cannot be switched during recording.

Formatting SD Memory Cards

1 Set the camera's power switch to ON. (Page 27)

2 Press the MENU button.

3 Select CARD FUNCTIONS → CARD FORMAT from the menu, and then push the OPERATION lever to confirm.

- Select the slot number of the card to format when the following screen is displayed. Select NO if you do not wish to format the card.
- Press the MENU button to close the menu display.

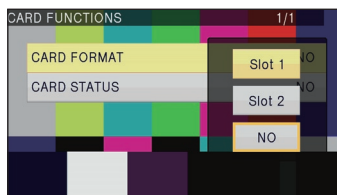

4 Select YES on the conformation screen.

- The SD Memory Card will be formatted.

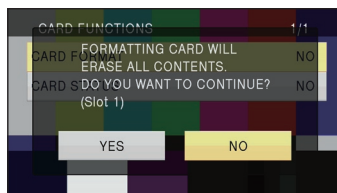

5 Press the MENU button to finish.

- When an SD Memory Card is formatted, all data including video data and still images recorded on the card will be erased and will not be restorable.

Save all important data to your computer.

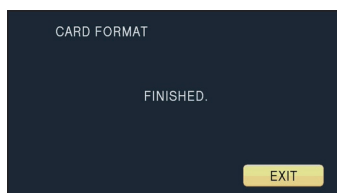

SD Memory Card recording times

Total available recording times (approx.) when using SD/SDHC/SDXC Memory Cards manufactured by Panasonic

SD Memory Card capacity	Recording mode		
	PH*1 (Highest quality mode*3/ 1920 × 1080 pixels or 1280 × 720 pixels)	HA*1 (High quality mode/ 1920 × 1080 pixels)	HE*2 (Long duration mode/ 1440 × 1080 pixels)
512 MB	Approx. 2 min	Approx. 3 min	Approx. 10 min
1 GB	Approx. 5 min	Approx. 7 min	Approx. 21 min
2 GB	Approx. 10 min	Approx. 15 min	Approx. 45 min
4 GB	Approx. 21 min	Approx. 30 min	Approx. 90 min
6 GB	Approx. 33 min	Approx. 45 min	Approx. 135 min
8 GB	Approx. 45 min	Approx. 60 min	Approx. 180 min
12 GB	Approx. 65 min	Approx. 90 min	Approx. 270 min
16 GB	Approx. 90 min	Approx. 120 min	Approx. 360 min
32 GB	Approx. 180 min	Approx. 240 min	Approx. 720 min
48 GB	Approx. 270 min	Approx. 360 min	Approx. 1080 min
64 GB	Approx. 360 min	Approx. 480 min	Approx. 1440 min

*1 Use an SD memory class of SD speed class 4 or above when recording on PH mode or HA mode.

Recording cannot be completed on SD Memory Cards of lower speed classes.

*2 Use an SD memory class of SD speed class 2 or above when recording in HG mode or HE mode.

Recording cannot be completed on SD Memory Cards of lower speed classes.

*3 This is the highest quality mode of this camera.

- This camera uses the VBR recording system. "VBR" stands for Variable Bit Rate, and it refers to a system in which the bit rate (volume of data per given time period) varies automatically depending on the subject which is being shot. This means that the recording times will be shorter when fast-moving subjects have been recorded.
- Times displayed include time needed for processing, etc. – actual available recording times will be slightly shorter.
- The camera is capable of continuous recording for a maximum of 12 hours.
- Recording can be restarted even if it was paused due to shortage of space.
- Even for the same card, the recording time differs depending on conditions such as the recording format and recorded images.
- Mosaic-like noise may appear on the playback screen under the following shooting conditions:
 - When there are complex patterns in the background
 - When the camera is moved in large motions or when it is moved very quickly
 - When a fast-moving subject has been recorded (and especially when HE has been set as the recording mode)
- When an SD memory card is formatted, the entire data including still images recorded on the card is erased and cannot be restored. Save any valuable data on your personal computer before formatting.
- Please use an SD memory card class of SD speed class 6 or above when using the VFR function. Recording cannot be performed with less than SD speed class 6.

Removing SD Memory Card

- 1 Lift the viewfinder up, and slide the card slot cover OPEN lever right to open.**
 - Ensure that the SD Memory Card access lamp is not flashing orange before opening the cover.
- 2 Press the center of the SD Memory Card so that it pops out slightly, and pull the card straight outwards.**

SD Memory Card access lamp

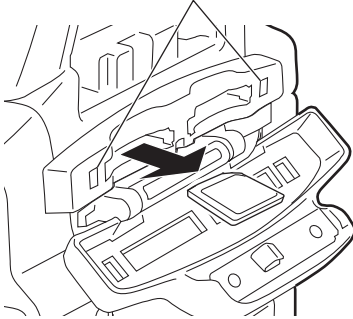

- Do not remove the SD Memory Card or switch off the power in the following circumstances. Doing so may damage your SD Memory Card.
 - 1) While the SD Memory Card access lamp is still flashing orange after an SD Memory Card has been inserted.
 - 2) While the SD Memory Card access lamp is flashing such as during recording or during recording finalization.

Protecting SD Memory Cards

Move the write-protect switch on the SD Memory Card to the "LOCK" position to prevent recorded contents being accidentally erased from the card.

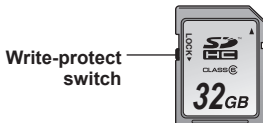

Repairing SD Memory Cards

Never remove the SD Memory Card or disconnect the battery or DC cord while the SD Memory Card access lamp is flashing, as doing so may damage the SD Memory Card. In the event that the SD Memory Card has been removed while the SD Memory Card access lamp was flashing, or that the battery or DC cord has been disconnected during recording or the recording finalization process, a repair verification screen will be displayed the next time the power is switched on in order to allow errors to be repaired.



Select YES to begin repairing. When repairing is complete, "REPAIR FINISHED" will be displayed, and the camera will switch to the recording paused screen. Select NO to switch directly to the recording paused screen without repairing.

- Memory cards cannot be repaired with the camera if NO is selected, but can still be repaired by using the AVCCAM Restorer* contents repair software.
 - An SD Memory Card on which an error occurred can be repaired by using either the camera that was used for the shooting, or the AVCCAM Restorer contents repair software.
 - A repair confirmation message may be displayed after inserting an SD Memory Card which has no error, but repair will not be performed even when YES or NO is selected.
 - Repair may take up to 20 minutes or so depending on the places where the errors occurred on the card.
 - Use a battery with an adequate charge or the AC adaptor.
 - If the repair operation has failed, "SYSTEM ERROR TURN POWER OFF" will be displayed. In this case, please use the AVCCAM Restorer contents repair software.
- Depending on the status of the data, it may not be possible to restore all data completely. In this case, it will no longer be possible to play back the clips that were recorded before the power was turned off.
- Clips with a total recording time of less than 10 seconds may not be able to be repaired.
 - Indexes attached during recording cannot be repaired.
- * AVCCAM Restorer is included on the supplied CD-ROM.

For details on how to install it, refer to install.txt. For details on how to use it, read the operating instructions (PDF file).

The AVCCAM Viewer can also be downloaded from the following website.
<http://pro-av.panasonic.net/>

Basic operations of the camera

Manual focusing

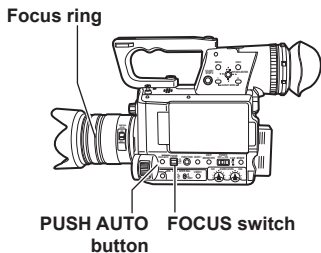

1 Use the FOCUS switch to choose how to control focusing.

A (AUTO):

Auto focus mode

M (MANUAL):

Manual focus mode

Turn the focus ring by hand.

∞ :

The camera first focuses on infinity, then it switches to manual focus.

The FOCUS switch automatically moves back to M (MANUAL) after you move it to ∞.

Temporarily switching to auto focus

Even if you have switched FOCUS to M (MANUAL) the camera will focus automatically while you press down PUSH AUTO.

- Auto focus may not work properly if there is flickering. Select a shutter speed suited to the ambient light. (Page 14 of Vol.2)
- If the auto focus mode is set with any format except 60i, 60P, 50i and 50p, controlling the focus will take slightly longer than in the normal focus mode.
- Auto focus is not available for some models of lens.
- Auto focus is not available when using the VFR function.
- The focus position display does not move linearly.

Using focus assist

- 1 Assign FA to any of the USER 1 – 3 buttons in the menu SW MODE screen.**
- 2 Press the button assigned FA.**

The contours of the image is taken in the red outline. Adjust the focus so that the subject to focus is surrounded by the red outline.

Irises adjustments

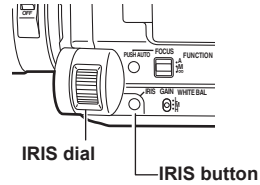

- 1 Press the IRIS button to switch how to adjust the aperture of lens.**

AUTO IRIS: Adjust the iris automatically.
MANUAL IRIS: Adjust the iris manually.
- 2 Turn the IRIS dial to adjust the aperture of lens when in the manual iris mode.**
 - In the auto iris mode, the lens iris can be corrected using this dial.

-
- Set the direction of the IRIS DIAL and aperture control in the setup menus, SW MODE screen, IRIS DIAL. (Page 54 of Vol.2)
 - Depending on your lens, AUTO IRIS may not operate.
 - Depending on your lens, the CLOSE function may not work during the IRIS operation.
 - Depending on your lens, for example if you are using a mount adaptor, the IRIS dial may not operate. Operate the IRIS ring of the lens.
 - See the display on the iris meter for the status of the light intensity. For details on the iris meter display, see page 47 of Vol. 2.
-

Adjusting the gain

When the display is dark, increase the gain to brighten the display.

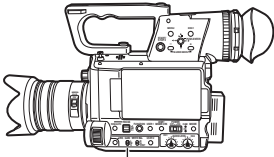

GAIN switch

1 Switch the gain with the GAIN switch.

L:

Set here under normal conditions. (The default value is ISO400/0 dB)

M:

Increase the gain of the image amplifier. (The default value is ISO800/6 dB.)

H:

Increase the gain of the image amplifier. (The default value is ISO1600/12 dB.)

-
- You can change the L, M, and H gain values using the LOW GAIN, MID GAIN and HIGH GAIN on the setting menu SW MODE screen. (Page 54 of Vol.2)
-

Light intensity adjustments

Use the ND dial to change the ND Filter used (filter to change light intensity).

- 1: ND filter is not used.
- 2: Cuts light intensity by up to about 1/4.
- 3: Cuts light intensity by up to about 1/16.
- 4: Cuts light intensity by up to about 1/64.

ND dial

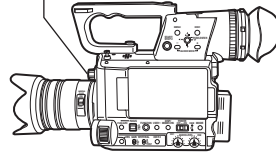

Adjusting the white balance

In order to reproduce the white accurately, adjust the ratio between the three RGB primary colors. If the white balance is not adjusted properly, not only will the white be reproduced poorly but the color tones of the entire screen will also be downgraded. When you are shooting in manual mode, readjust the white balance whenever lighting conditions change.

You can save adjustments and reselect them by setting the WHITE BAL switch to A or B.

You can also use the preset values.

Use the settings to suit the shooting conditions.

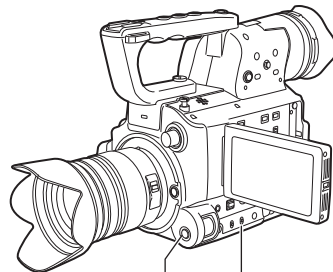

WHITE BAL switch
AWB button

White balance adjustments

- 1 Set the shutter speed. (Page 14 of Vol.2)**
- 2 Place a white pattern in a location with the same lighting conditions and light source as the subject, then zoom in and fill the whole screen with white.**
 Something white (a white cloth or wall) near the subject can be used instead.
 - Do not include bright spotlights in your shot.
- 3 Set the WHITE BAL switch to A or B (whichever one you want to save the adjustment in).**
- 4 Press the AWB button.**

- Adjustment takes a few seconds. (The following messages appear on the screen.)

Message during adjustment

AWB Ach ACTIVE

Message after adjustment

AWB Ach OK

- An error message appears on the screen when white balance adjustment is not possible.

Message when adjustment cannot be done

AWB Ach NG

-
- White balance cannot be adjusted if the ATW (Auto Tracking White) function is working.
 - Make the necessary adjustments if one of the following error messages appears, then try adjusting the white balance again.

Error messages	Adjustments
LOW LIGHT	Increase light or increase the gain.
LEVEL OVER	Reduce light or decrease the gain.

- If the messages repeatedly appear even after trying a number of times, consult your dealer.
-

Using presets

Use this feature when you have no time to make white balance adjustments.

- 1 Set the WHITE BAL switch to PRST.**
 The current white balance value appears.
 - White balance values 3200 K and 5600 K are preset in the PRST position.
 Guide to the preset values
 P3.2K (3200 K): halogen light
 P5.6K (5600 K): outdoors

- 2 Press the AWB button.**
 The white balance value switches in the following order: 3200K, 5600K, VARIABLE.
-

- Selecting VARIABLE enables the white balance to be set to an arbitrary value between 2.4 K and 9.9 K by moving the FUNCTION knob up and down.
 - The VARIABLE white balance value displayed is not guaranteed to be an absolute value. Please use it as a reference value.
 - The VARIABLE white balance value can be checked by pressing the AWB button
 - The value of VARIABLE cannot be changed when the AREA function of the FUNCTION KNOB is operating and a frame is displayed.
-

Black balance adjustments

In order to reproduce the black accurately, adjust the zero level of all three RGB primary colors. If the black balance is not adjusted properly, not only will the black be reproduced poorly but the color tones of the entire screen will also be downgraded.

It is not normally necessary to adjust the black balance. Adjust it when:

- You use the camera for the first time.
- You use the camera after not using it for a long time.
- The ambient temperature changes greatly.
- You change the gain and shutter speed.
- You switch to the CAM mode from the PB mode.
- You change the SYSTEM FREQ.

White balance can be adjusted automatically by pressing the AWB button, while black balance can be adjusted by holding the button down. Set the conditions for white balance adjustment before proceeding.

Message during adjustment

ABB ACTIVE

Message after adjustment

ABB END

- Black balance can be adjusted by holding the AWB button down even when the ATW function is in use.
- You cannot adjust the black balance while you are shooting.
- Black balance adjustment takes around 30 seconds when the shutter speed is 1/8 or less.

Auto Tracking White (ATW)

Using the ATW function enables the recording environment to be automatically analyzed and an optimum white balance to be constantly maintained during recording.

You can allocate the ATW feature to one of the positions on the WHITE BAL switch (A, B, or PRST). Allocate it by going to the setup menus, SW MODE screen, ATW. (Page 54 of Vol.2)

White balance sensor

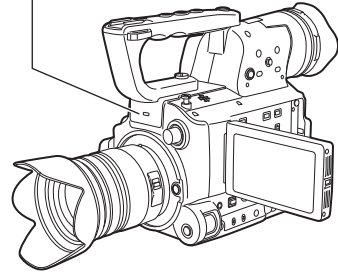

- Depending on the environment, there may be some error in the adjustment.
- Use the procedure described on the previous page whenever you need more precise white balance.
- Do not block the white balance sensor when using the ATW feature. ATW will not work if you do.

Using the setup menus

Use the setup menus to change the settings to suit the scenes you are shooting or what you are recording.

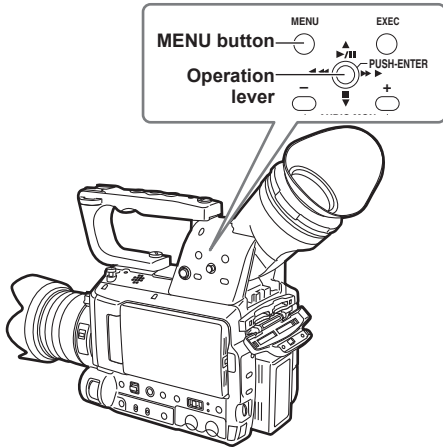

Using the menus

- The menu items indicated in the gray characters cannot be changed its settings.

1 When the unit is in other than playback or recording mode, press the MENU button. The following is displayed on the viewfinder and LCD monitor.

CAM mode (Example)

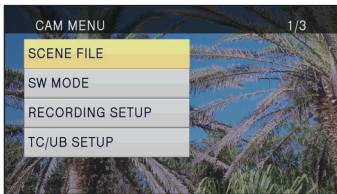

PB mode (Example)

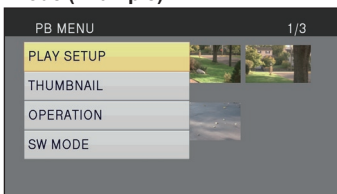

2 Tilt the Operation lever in the \blacktriangle \blacktriangledown directions to move the yellow cursor to the function you wish to set.

3 Push the Operation lever (or tilt in the \blacktriangleright direction) to display the setting items.

Example:

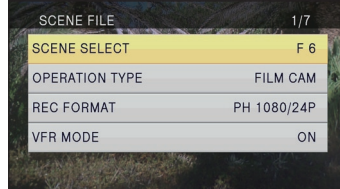

4 Tilt the Operation lever in the \blacktriangle \blacktriangledown directions to move the yellow cursor to the item you wish to set.

Example:

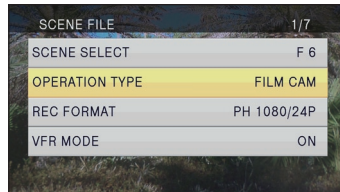

5 Push the Operation lever (or tilt in the \blacktriangleright direction) to set the item.

To change values or other parameters, tilt the Operation lever in the \blacktriangle \blacktriangledown directions. Select the item to be set, and then push the OPERATION lever to confirm.

Example:

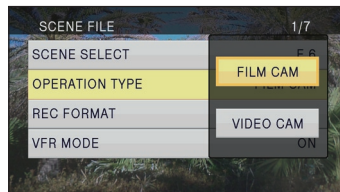

- Tilt the Operation lever in the \blacktriangleleft direction to return to the previous menu.

6 Repeat steps 4 - 5 to change any other items.

Press the MENU button to complete settings and return to the normal screen.

- Tilt the OPERATION lever in the ◀ direction, or push the OPERATION lever to change the set value and return to the previous menu (in some cases).

7 Repeat steps 2 - 5 to change any other settings.

Press the MENU button to complete settings and return to the normal screen.

Initializing the menu settings

The menu settings contain both the user file settings and the scene file settings. You can initialize them separately.

To initialize the user file (i.e. all the settings other than the scene file settings)

Select INIT in LOAD/SAVE/INIT of the USER FILE screen. The current menu settings of user file will return to the factory settings.

To initialize the scene file

Of the six scene files, select the file you want to initialize from the SCENE SELECT item in the SCENE FILE screen. Then in the SCENE FILE screen, LOAD/SAVE/INIT, select INIT.

The settings for only the selected scene file are returned to the factory settings.

If you wish to initialize the user file and scene files at the same time, the user file and all six scene files can be restored to their factory default settings by selecting YES for the MENU INIT item on the OTHER FUNCTIONS screen.

Setup menu structure

Menu

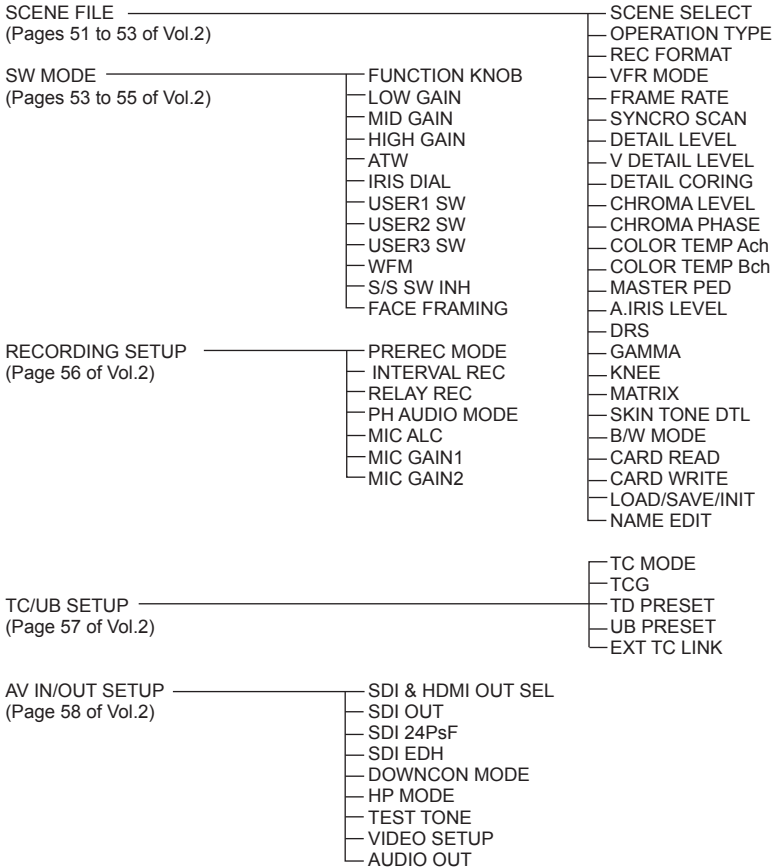

Menu (continued)

DISPLAY SETUP (Pages 59 to 60 of Vol.2)		ZEBRA DETECT1
		ZEBRA DETECT2
		Y GET MARKER
CARD FUNCTIONS (Page 61 of Vol.2)	CARD FORMAT	SAFETY ZONE
	CARD STATUS	CENTER MARKER
	CLIP PROPERTY (only PB MENU)	FOCUS BAR
		REC COUNTER
USER FILE (Page 61 of Vol.2)	CARD READ	VIDEO OUT OSD
	CARD WRITE	IRIS METER
	LOAD/SAVE/INT	DATE/TIME
		DATE FORMAT
META DATA (Page 62 of Vol.2)	CARD READ	LEVEL METER
	RECORD	ZOOM & FOCUS
	USER CLIP NAME	CARD & BATTERY
	META DATA PROP	OTHER DISPLAY
	CLIP COUNTER RST	LCD BACKLIGHT
	META INIT SET	LCD SET
		EVF SET
		SELF SHOOT
		EVF MODE
		EVF COLOR
		LENS CHECK
OTHER FUNCTIONS (Pages 62 to 64 of Vol.2)		IR REMOTE
		TALLY LAMP
		CLOCK SET
		TIME ZONE
		POWER SAVE
		LANGUAGE
PLAY SETUP (Page 64 of Vol.2)	PB FORMAT	SYSTEM FREQ
	REPEAT PLAY	SYSTEM INFO
	RESUME PLAY	LENS INFO
	SKIP MODE	MENU INT
		OPERATION TIME
		UPDATE
		LENS UPDATE
THUMBNAIL (Page 65 of Vol.2)		THUMBNAIL MODE
		INDICATOR
		DATA DISPLAY
OPERATION (Page 65 of Vol.2)	DELETE	DATA FORMAT
	INDEX	
	CLIP PROTECT	
	COPY	

Specifications

[General]

Supply voltage: DC 7.2 V

(when the battery is used)

7.3 V

(when the AC adaptor is used)

Power consumption: Recording: 12.4 W

indicates safety information.

Ambient operating temperature

0 °C to 40 °C (32 °F to 104 °F)

Ambient operating humidity

10% to 80% (no condensation)

Weight

Approx. 1.3 kg (2.9 lb)

(Excluding the handle, grip, battery and accessories)

Dimensions (W x H x D)

163.4 mm × 195 mm × 290.4 mm

(6-7/16 inches × 7-11/16 inches × 11-7/16 inches)

(Including the handle and grip)

[Camera]

Pickup devices

4/3 MOS fixed pickup device

Single panel (primary color filter)

Number of pixels

Effective pixels: 12.4 million approx.

Single panel (16:9)

Image size

Valid image range

Approx. 17.8 mm (H) × Approx. 10.0 mm (V)

Lens

Not included

Lens mount

Micro Four Thirds system

Lens mount

ND filter

1/4, 1/16, 1/64

Gain settings

-6 - +18dB (3dB increments)

(VIDEO CAM mode)

ISO200 – ISO3200

(FILM CAM mode)

Color temperature settings

ATW, ATW LOCK, preset 3200K, preset 5600K,

preset VAR, Ach, Bch

Shutter speed settings

Preset

when SYSTEM FREQ is 59.94 Hz

60i/60P mode:

1/60, 1/100, 1/120, 1/250, 1/500, 1/1000,
1/2000 seconds

30P mode:

1/30, 1/50, 1/60, 1/120, 1/250, 1/500,
1/1000, 1/2000 seconds

24P mode:

1/24, 1/50, 1/60, 1/120, 1/250, 1/500,
1/1000, 1/2000 seconds

when SYSTEM FREQ is 50 Hz

50i/50P mode:

1/50, 1/60, 1/120, 1/250, 1/500, 1/1000,
1/2000 seconds

25P mode:

1/25, 1/50, 1/60, 1/120, 1/250, 1/500,
1/1000, 1/2000 seconds

* Underline indicates when shutter is OFF

Syncro scan

(when SYSTEM FREQ is 59.94 Hz, and
OPERATION TYPE is VIDEO CAM)

60i/60P mode:

1/60.0 seconds – 1/250.6 seconds

30P mode: 1/30.0 seconds – 1/250.6 seconds

24P mode: 1/24.0 seconds – 1/250.6 seconds

(when SYSTEM FREQ is 50 Hz, and
OPERATION TYPE is VIDEO CAM)

50i/50P mode:

1/50.0 seconds – 1/250.0 seconds

25P mode: 1/25.0 seconds to 1/250.0 seconds
(OPERATION TYPE is FILM CAM)

10.0 d – 180.0 d – 360.0d

(0.5d increments, angle display)

* Underline indicates default

Slow shutter speed settings

when SYSTEM FREQ is 59.94 Hz

60i/60P mode:

1/2, 1/4, 1/8, 1/15, 1/30 seconds

30P mode:

1/2, 1/4, 1/8, 1/15 seconds

24P mode:

1/2, 1/3, 1/6, 1/12 seconds

when SYSTEM FREQ is 50 Hz

50i/50P mode:

1/2, 1/3, 1/6, 1/12, 1/25 seconds

25P mode:

1/2, 1/3, 1/6, 1/12 seconds

* Only when OPERATION TYPE is set to VIDEO
CAM

Normal sensitivity

F8.0 normal
(2000lx, 3200K, 89.9% reflex, 1080-59.94i)

Horizontal resolution

800 TV lines (standard)
(in the center of the screen)

[Image/recording/playback]

Recording Format

AVCHD compliant

Compression formats

MPEG-4 AVC/H.264

Recording media

SD Memory Card:

Up to 512 MB, 1 GB, 2 GB
(FAT12, FAT16 format supported)

SDHC Memory Card:

4 GB, 6 GB, 8 GB, 12 GB, 16 GB, 32 GB
(FAT32 format supported)

SDXC memory cards:

48 GB, 64GB (exFAT format supported)

However, above Class4 is supported in PH and HA modes, and above Class6 is supported during VFR recording.

Recording format (Recording mode, resolution)

(when SYSTEM FREQ is 59.94 Hz)

PH 1080/59.94i
PH 1080/29.97p
PH 1080/23.98p
PH 720/59.94p
PH 720/29.97p
PH 720/23.98p
HA 1080/59.94i
HE 1080/59.94i

(when SYSTEM FREQ is 50 Hz)

PH 1080/50i
PH 1080/25p
PH 720/50p
PH 720/25p
HA 1080/50i
HE 1080/50i

Transmission rate

PH mode: 21 Mbps approx. (VBR)
HA mode: 17 Mbps approx. (VBR)
HE mode: 6 Mbps approx. (VBR)

Interval recording

Start/1 second/10 seconds/30 seconds
/1min/2min

* Recording mode is fixed to PH 1080/24P (when SYSTEM FREQ is 59.94 Hz), PH 1080/25P (when SYSTEM FREQ is 50 Hz) and the maximum shooting time is 24 hours

VFR recording

When REC FORMAT is 1080 24p/30p:
12/15/18/20/21/22/24/25/26/27/28/30/32/34/
36/40/44/48/54/60 frame/sec

When REC FORMAT is 1080 25p:
12/15/18/20/21/22/23/24/25/26/27/28/30/32/
34/37/42/45/48/50 frame/sec

[Image output]

SDI output

BNC, 0.8V [p-p], 75 Ω

HD HDI

1080/60i, 1080/24psF, 720/60p
(when SYSTEM FREQ is 59.94 Hz)

1080/50i, 720/50p

(when SYSTEM FREQ is 50 Hz)

SD SDI

480/60i

(when SYSTEM FREQ is 59.94 Hz)

576/50i

(when SYSTEM FREQ is 50 Hz)

HDMI terminal

HDMI (HDMI TypeA terminal)

1080/60i, 720/60p, 480/60p

(when SYSTEM FREQ is 59.94 Hz)

1080/50i, 720/50p, 576/50p

(when SYSTEM FREQ is 50 Hz)

(VIERA Link not supported)

VIDEO terminal

Pin jack, 1.0 V[p-p], 75 Ω

480/60i

(when SYSTEM FREQ is 59.94 Hz)

576/50i

(when SYSTEM FREQ is 50 Hz)

[Audio recording playback]

Recording format

Dolby Digital/2ch (in HA/HE mode)

Dolby Digital/2ch, linear PCM digital/2ch switch
(only in PH mode)

Sampling frequency

48 kHz

Encoding

16 bit

Compressed bit rate

Dolby Digital

PH mode: 384 kbps

HA, HE mode: 256 kbps

Specifications (continued)

[Audio input]

Built-in microphone

Stereo microphone

XLR input

XLR (3 pin) x 2 (INPUT 1, INPUT 2),
LINE/MIC selectable, high impedance

LINE: 0 dBu

MIC: -50 dBu/-60 dBu (menu selectable)

MIC POWER + 48 V ON/OFF selectable

[AUDIO output]

AUDIO output

Output: 600 Ω , 316 mV

Pin jack x 2 (CH1, CH2)

SDI

2ch (linear PCM)

HDMI

2ch (linear PCM)/5.1ch (Dolby Digital)

Headphone

3.5mm diameter, stereo mini jack x 1

Speaker

Round, 20mm diameter

[Other terminals]

Camera remote terminal

Super mini jack x 1 (2.5 mm diameter) (S/S)

Mini jack x 1 (3.5 mm diameter) (FOCUS, IRIS)

INDEX remote terminal

Super mini jack x 1 (2.5mm diameter)

TC PRESET IN/OUT terminal

VIDEO terminal dual purpose

IN: 1.0 V – 4.0 V [p-p], 10 k Ω

OUT: 2.0 V \pm 0.5 V [p-p]

Low impedance

USB terminal

Card reader/writer function

(no copyright protection support)

Type mini B connector

(compliant with USB ver. 2.0)

[Monitor]

LCD

3.45 type, wide LCD color monitor
(920,000 dots approx.)

Viewfinder wide

0.45 type LCD color monitor

(1,220,000 dots equivalent approx.)

[AC adaptor]

Power Source: 110 V - 240 V AC, 50 Hz/60 Hz
22 W

Power Output: 7.3 V DC, 1.75 A
(Camera-recorder)
8.4 V DC, 1.3 A (Charge)

 indicates safety information.

Weight

140 g (0.31 lb)

Dimensions (W x H x D)

103 mm x 36 mm x 62 mm

(4-1/16 inches x 1-13/32 inches x 2-7/16 inches)

Weight and dimensions are approximate.
Specifications are subject to change without notice.

Information on Disposal in other Countries outside the European Union



These symbols are only valid in the European Union.
If you wish to discard this product, please contact your local authorities or dealer and ask for the correct method of disposal.



Panasonic Solutions Company

3 Panasonic Way, Secaucus, NJ 07094 Tel: 877-803-8492
www.panasonic.com/broadcast e-mail: MediaProServices.PSC@us.panasonic.com

Panasonic Canada Inc.

5770 Ambler Drive, Mississauga, Ontario L4W 2T3 Tel: 905-624-5010

Panasonic de México S.A. De C.V.

Casa Matriz: Felix Cuevas No.6 Piso 2 y 3 Col. Tlacoquemecatl Del Valle Del.Benito Juárez, México, D.F., C.P.03200
Tel: 55-5488-1000 Fax: 55-5575-6783

Panasonic Latin America, S.A.

P.O.Box 0816-03164 Panama, Republic of Panama Tel: +507-229-2955 Fax: 507-229-5352

Panasonic do Brasil Ltda.

Rua Cubatão, 320-6º andar-Paráíso CEP 04013-001- São Paulo -SP Tel: 11-3889-4000 Fax: 11-3889-4004

Panasonic®

■ This product is eligible for the AVCCAM
3 Year Warranty Repair Program. For
details, see page 5 of vol.1.

Operating Instructions **Vol.2**

Memory Card Camera-Recorder

Model No. **AG-AF100P**

Volume **2**

Note that Operation Instructions Vol.2 describes advanced operations of the Memory Card Camera-Recorder. For instructions on basic operations of the Memory Card Camera-Recorder, refer to Operating Instructions Vol.1 (printed documents) contained in the supplied CD-ROM.

AVCCAM

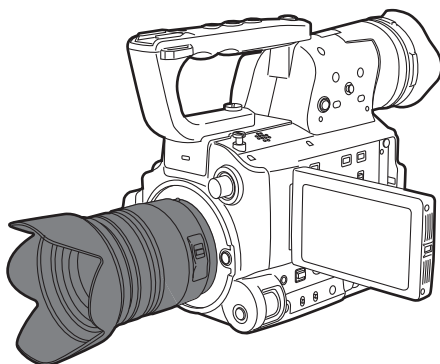

AVCHD™

DOLBY
DIGITAL
STEREO CREATOR

HDMI™
HIGH DEFINITION MULTIMEDIA INTERFACE

WV™
MICRO

SD™
XC

Before operating this product, please read the instructions carefully and save this manual for future use.

M1210AT0 -FJ **D**
Printed in Japan

ENGLISH

VQT3M18A (E)

Read this first!
IMPORTANT SAFETY INSTRUCTIONS
Recommendation for Use of Genuine
Panasonic Battery
Outline of operations
Please read before use
Operating precautions

Before use

Precaution for use
Accessories
Optional accessories

Description of parts

Description of parts

Preparation

Recharging the battery
Power sources
Adjusting the hand strap
Attaching/detaching the handle

Attaching/detaching the grip
The remote control
Turn on/off the camera
Tally lamp
Viewfinder
Setting the calendar

Shooting

Basic shooting operations
Basic operations of the camera

Menu

Using the setup menus
Setup menu structure

Reference

Specifications

Shooting

Shooting in progressive mode.....	4
Shooting techniques for different targets....	5
Self-portrait shooting	5
Zebra pattern	5
Marker	6
Checking and displaying shooting status	6
PRE REC	6
Relay function.....	6
Variable frame rate (VFR).....	7
Shooting using the FUNCTION knob	10
Optical Image Stabilizer	11
Adding effects to images	11
Using the USER buttons	11
Backlight compensation	11
Color bars.....	11
Wave form monitor function.....	12
Adjusting the volume while shooting	12
Shot mark function	13
Index recording.....	13
LAST CLIP function	13
CAPTURE function.....	13

Adjusting the shutter speed.....	14
Using the SHUTR/F.RATE dial	14
Setting the SHUTTER	14
Setting the SYNCRO SCAN.....	14
FRAME RATE setting.....	14
Synchro scan.....	16
Switching Audio Input.....	17
Using the built-in microphone.....	17
Using an external microphone and audio equipment.....	17
Adjusting the recording level	18
Using scene files	19
Changing scene file settings	19
Saving scene files and other settings on SD Memory Cards	21
Clip metadata	22
Uploading the metadata (META DATA)	23
Selecting the USER CLIP NAME recording method	23
Using the Counter	24
Counter display	24
TC preset mode.....	24

Charging the built-in battery/	
Setting the time code	25
Recharging the built-in battery	25
Setting the time code	25
Specifying the time code (TC PRESET).....	25
Setting user information	27

Playback

Basic playback operations	28
Thumbnail screen	29
Basic thumbnail screen operations	29
Adding shot marks to clips	31
Select the card slot for playback	31
Playback settings (PLAY SETUP)	32
Set playback format (PB FORMAT).....	32
Repeat playback (REPEAT PLAY)	32
Resume playback (RESUME PLAY).....	33
Set skip method (SKIP MODE)	33
Thumbnail operations	34
Selecting the thumbnail display method	
(THUMBNAIL)	34
Deleting and protecting clips (OPERATION) ..	35
Copying clips (COPY)	36
Format card and check clip and	
card information (CARD FUNCTIONS)	37
Useful playback functions	39
Fast forward/rewind	39
Next/previous clip	39
Frame-by-frame playback	40
Adjust volume	40
Viewing images on a television	40
Checking the date and time.....	40

Editing

Connecting external units	41
Headphones	41
External microphone	41
Computer (non-linear editing/file transfer).....	42
TV/Monitor	42
Nonlinear editing	44

Displays

Screen displays	45
Regular displays	45
Main warning displays	48
Setting the DISPLAY items	50

Menu

Setup menu list	51
SCENE FILE screen.....	51
SW MODE screen	53
RECORDING SETUP screen.....	56
TC/UB SETUP screen	57
AV IN/OUT SETUP screen	58
DISPLAY SETUP screen	59
CARD FUNCTIONS screen	61
USER FILE screen	61
META DATA screen	62
OTHER FUNCTIONS screen	62
PLAY SETUP screen	64
THUMBNAIL screen	65
OPERATION screen.....	65

Reference

Before calling for service	66
Updating the firmware	
incorporated into the unit	70
Cleaning	71
Storage Precautions	72
How to handle data recorded on	
SD Memory Card	73

Shooting in progressive mode

Selecting 1080/30P or 1080/24P in the REC FORMAT option (Page 51) of the setting menu SCENE FILE screen enables shooting in progressive mode.

30P mode:

Shoot 30 frames a second in the progressive mode.

For output and recording, the 30-frame-per-second signal is converted to 60-field-per-second interlace.

This mode gives you high quality images.



24P mode:

Shoot 24 frames a second in the progressive mode.

The video signal will be recorded natively.

However, the external output signal is converted to a 2:3 format, 60 fps interlaced signal.

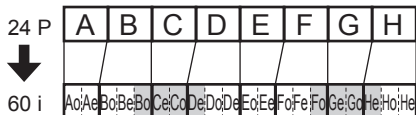

25P mode:

Shoots 25 frames a second in the progressive mode.

For output and recording of video signal, the 25-frame-per-second image is converted to 50-field-per-second interlace signal.

This mode gives high quality images.



Note the following when shooting in progressive mode.

- Set the shutter speed to 1/50 (OFF) for best results.
 - There may be a slight delay to the start of recording when you use the 24P mode because 4 frames are recorded at a time.
-

Shooting techniques for different targets

Self-portrait shooting

Images in the LCD monitor when it is turned 180° for self-portrait shooting may appear unusual. You can make them appear better by reversing left and right. Go to the setup menus, DISPLAY SETUP screen, SELF SHOOT, and select MIRROR. Shooting in mirror mode has no effect on what you actually shoot and record.

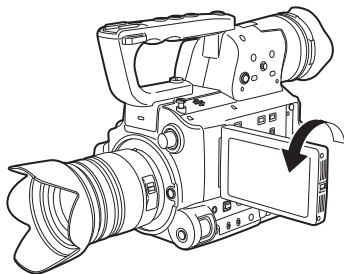

- Images played back by pressing the REC CHECK button cannot be inverted horizontally.
- Operation status displays during self-portrait recording
 - No display: Cannot record (no card, etc.)
 - : Recording in progress, during transition to the recording pause mode
 - ⏸: Recording paused (recording standby)
 - ⚠: Warning display
- Only part of the screen display appears. When [⚠] is displayed, turn the LCD monitor back in the direction of normal recording, and check what the message says.
- To confirm screen display information on the viewfinder, turn the LCD monitor to the normal shooting position.

Zebra pattern

Press the ZEBRA button in the CAM mode to show the zebra pattern or marker on the viewfinder and the LCD monitor so you can check the brightness of the subject.

Parts that may be whited out through over exposure are shown as a zebra pattern.

- Very bright
- Reflecting parts

ZEBRA button

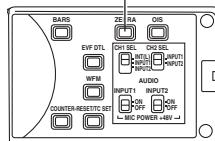

You can remove most overexposed parts by adjusting the iris and shutter speed in the manual mode to remove the areas with zebra patterns. The display changes as follows each time you press the ZEBRA button.



In the setup menus, DISPLAY SETUP screen, ZEBRA DETECT1 and ZEBRA DETECT2, set the brightness for the zebra patterns. (Page 59) If the ZEBRA DETECT2 item is set to OFF, ZEBRA2 will not be displayed even if the ZEBRA button is pressed. The zebra pattern you have set appears as a percentage on the display for about 2 seconds.

The zebra pattern is displayed in the color bar as well.

Shooting techniques for different targets (continued)

Marker

If you press the ZEBRA button while the zebra pattern is being displayed, a marker appears in the center of the display (if you have set the setup menu, DISPLAY SETUP, MARKER to ON). The brightness of the areas near the screen center can be checked as a percentage (0% to 99%). "99%†" appears if the percentage is over 99.

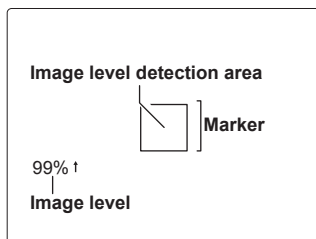

The normal display reappears if you press the ZEBRA button again.

Checking and displaying shooting status

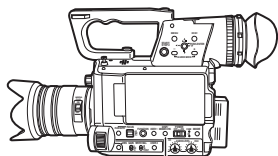

DISP/MODE CHK button

Pressing the DISP/MODE CHK button during recording or while recording is paused will remove all displays from the screen except the operation status display, frame display (such as area), counter, marker, and safety zone display.

Pressing the DISP/MODE CHK button during recording or while recording is paused will remove all displays from the screen except for the operation status, frame display area etc., counter, marker, and safety zone display. Press the button again to return to the normal display. (Page 50) This setting will be maintained even if the camera's power is turned off by moving the POWER switch to the OFF position or if the operating mode is changed.

Pressing the DISP/MODE CHK button while the thumbnail screen is displayed in PB mode will display the properties of the selected clip. (Clips can be selected by moving the cursor with the Operation lever.)

PRE REC

Record video and audio from three seconds before the time of the operation to begin recording.

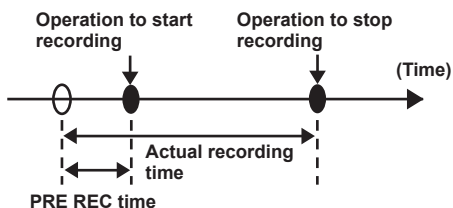

1 Set the PREREC MODE item on the RECORDING SETUP screen to ON.

PRE-REC will be displayed on the screen.

- When the TCG item on the TC/UB SETUP screen has been set to REC RUN, the setting will be automatically changed to FREE RUN.

2 Press the START/STOP button.

Video and audio from approximately 3 seconds previously will be recorded.

- Recording of the previous 3 seconds of video and audio may not be possible if recording is started immediately in the following cases.
 - Immediately after switching from PB mode to CAM mode
 - Immediately after turning power on
 - Immediately after changing to PREREC MODE item
- The thumbnail for clips recorded using the PREREC function will display the image from when the START/STOP button was pressed.

Relay function

When the remaining space on an SD card is insufficient during recording, recording can be continued using the other SD card slot.

Select ON in the RELAY REC item on the settings menu RECORDING SETUP screen.

- When the remaining space on an SD card is insufficient during recording, recording will automatically be continued using the SD card in the other slot.
- The relay function is not available when an SD card that cannot be recorded to is inserted in the SD card slot.
- The longest possible recording time with this camera is 12 hours. This cannot be extended even if the relay function is used.

Variable frame rate (VFR)

This camera can perform low speed (undercrank) and high speed (overcrank) recording without the need for a frame rate converter (the camera must be set to 1080_24p or 1080_30p).

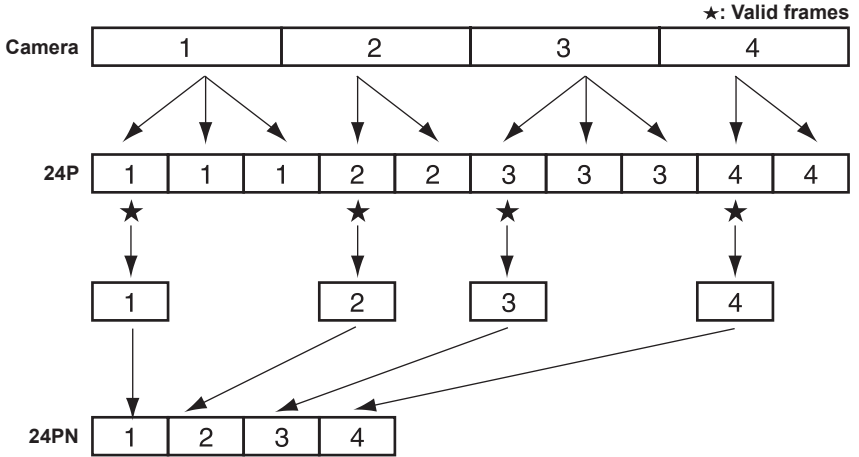

24P mode:

Shoots 24 frames a second in native mode. The images (shot at 24 frames a second) are recorded into 24 frames as the video signal.

- When VFR is set, the INTERVAL REC function, relay recording function, and PRE REC function are automatically set to OFF, and TCG is automatically set to REC RUN.
- The frame rate cannot be changed during recording.
- VFR shooting is only possible when shooting with REC FORMAT set to 1080_24p, 1080_30p or 1080_25p. VFR shooting does not work in the 720p mode.

The recording frame rate can be set to any one from the 20 frame rates given in the following table.

There is a slight difference between the displayed recording frame rate and the actual recording frame rate. Please refer to the table below.

When SYSTEM FREQ is set to 59.94 Hz

Indicated recording frame rate	60	54	48	44	40	36	34	32	30	28	27	26	25	24	22	21	20	18	15	12
Actual recording frame rate	59.94	53.74	47.54	43.96	39.96	35.97	33.88	31.73	29.97	27.83	27.25	25.97	24.98	23.98	21.98	20.75	19.98	17.63	14.99	11.99

When SYSTEM FREQ is set to 50 Hz

Indicated recording frame rate	50	48	45	42	37	34	32	30	28	27	26	25	24	23	22	21	20	18	15	12
Actual recording frame rate	50.00	48.08	45.45	41.67	36.76	34.09	31.82	30.00	27.78	26.79	26.04	25.00	24.00	23.08	22.06	20.83	20.00	17.86	15.00	12.50

Shooting techniques for different targets (continued)

Native recording

- 1** Select 1080/24P recording format from the REC FORMAT option (page 51) on the settings menu SCENE FILE screen.
 - 2** From the OPERATION TYPE option (page 51) on the settings menu SCENE FILE screen, select FILM CAM, and set the FRAME RATE (page 51) to an arbitrary recording frame rate.
 - 3** Press the START/STOP button
Start native recording in VFR mode.
- Although the audio is not recorded, the sound is output from the AUDIO OUT terminal, HDMI terminal, and SDI OUT terminal during setup and during recording.
 - During the VFR mode, the camera is set to manual focus mode.

Standard recording

- 1** Select 1080/30P recording format from the REC FORMAT option (page 51) on the settings menu SCENE FILE screen.
- 2** From the OPERATION TYPE option (page 51) on the settings menu SCENE FILE screen, select FILM CAM, and set the FRAME RATE (page 51) to an arbitrary recording frame rate.
- 3** Press the START/STOP button.
Start standard recording in VFR mode.
 - Although the audio is not recorded, the sound is output from the AUDIO OUT terminal, HDMI terminal, and SDI OUT terminal during setup and during recording.
 - During the VFR mode, the camera is set to manual focus mode.
 - 2:2 pull down recording will be applied for a recording frame rate of 30P.

Use of Variable Frame Rate (VFR)

Normal speed shooting for movie production

When producing videos for screening, a frame rate of 24fps as used in film projection is standard (x1). By using the settings below, playback with the same quality as the film projection is possible. Film like high quality video can be produced through 1080p progressive and CINELIKE Gamma.

Recording format (REC FORMAT)	Recording frame rate (FRAME RATE)
1080P/24P (native recording)	24 fps*

Normal speed shooting for commercial/drama production

When producing videos for display on television screen such as HDTV/SDTV broadcast, a frame rate of 30fps is standard (x1). By using the settings below, playback with the same quality as broadcast is possible. Commercials and music videos can be recorded at film-like high quality, and at a frame rate suitable for television broadcast.

Recording format (REC FORMAT)	Recording frame rate (FRAME RATE)
1080/30P (2:2 Pull down)	30 fps*
1080/25P	25 fps*

Undercrank shooting

This is a quick motion effect that can be applied to scenes showing the flow of clouds, people standing in the middle of crowds, and kung fu, etc. For example, a quick motion effect of x2 can be gained if the VFR recording frame rate is set to 12fps when recording with the 24P recording format that specifies the playback frame rate.

Recording format (REC FORMAT)	Recording frame rate (FRAME RATE)
1080/24P	Less than 22fps*
1080/30P	Less than 28fps*
1080/25P	Less than 24fps*

Overcrank shooting

This is a slow motion effect that can be applied to scenes such as car chases, action, climaxes, etc. For example, a slow motion effect of 1/2 can be gained if the VFR recording frame rate is set to 60fps when recording with the 30P recording format that specifies the playback frame rate. 1080P progressive movies produce smooth, high quality slow motion.

Recording format (REC FORMAT)	Recording frame rate (FRAME RATE)
1080/24P	Less than 25fps*
1080/30P	Less than 32fps*
1080/25P	Less than 26fps*

* The recording frame rate (FRAME RATE) can be set to one of 20 values. (page 14)

Shooting using the FUNCTION knob

The following types of recording can be carried out using the FUNCTION knob.

- Area auto focus function
Operates auto focus within an area frame selected using the FUNCTION knob.
- Area auto iris function
Automatically adjusts the iris value within an area frame selected using the FUNCTION knob. This function cannot be set when the FACE DETECT function has been set.
- Area luminance display
Displays an averaged luminance level within an area frame selected using the FUNCTION knob.

1 Select the function from the FUNCTION KNOB option (page 53) on the settings menu SW MODE screen.

FOCUS: Area focus function and area focus bar function (during MENU setting)

IRIS: Area iris function and area iris meter function (during MENU setting)

YGET: Area luminance display

FOCUS/IRIS:
Simultaneous operation of the area focus function and area iris function, simultaneous operation of the area focus bar function/area iris meter function (during MENU setting)

FOCUS/YGET:
Simultaneous operation of area focus function and area luminance display, simultaneous operation of area focus bar function (during MENU setting)

2 Press the FUNCTION knob.

- A white frame is displayed.
- There is no change in the operation of the camera other than the display of the frame.

3 Press the FUNCTION knob again.

- The white frame turns yellow.
- When the frame is yellow, the FUNCTION knob function set via the MENU operates in the area inside the frame.
- Pressing the FUNCTION knob once more returns the yellow frame to the white frame.
- Switching AUTO/MANUAL for FOCUS/IRIS is normally carried out in the same way.
- The central luminance function does not operate when the area luminance display is operating.
- If the FUNCTION knob is held down for more than 2 seconds, the frame disappears and the area function is switched off.

4 Move the FUNCTION knob up and down, and right and left.

- The white frame changes position. Move the frame to the area you wish to select.

-
- The area function does not operate during face detection.
 - The area function exits when the power switch is set to OFF or when the camera is switched to playback mode.
 - Auto focus and auto iris may not be available depending on lens used.
 - The area luminance, FOCUS BAR, and IRIS METER functions are available regardless of the lens used.
-

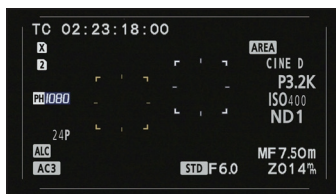

Optical Image Stabilizer

Use the Optical Image Stabilizer (OIS) to reduce the effects of camera shake when shooting by hand.

Press the OIS button to turn the function on and off.  appears on the viewfinder and the LCD monitor when this function is on. Turn the function off when using a tripod for more natural images.

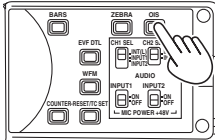

- For lenses that have an OIS button, only the lens button is active and the button on the camera is deactivated. Also, some lenses do not have an OIS function.
- This function will not be as effective when the vibration is severe or when tracking a moving subject.

Adding effects to images

Press the USER button you have allocated to the BLACKFADE or WHITEFADE feature to add fading effects to your images. The button's function is forcibly canceled during playback or REC CHECK and also when thumbnails are displayed.

BLACKFADE:

Press the button to fade out to black. Audio also fades out. Fade-in starts after fade-out, when the button is released.

WHITEFADE:

Press the button to fade out to white. Audio also fades out. Fade-in starts after fade-out, when the button is released.

Using the USER buttons

You can allocate one of thirteen features to each of the three USER buttons.

Use these buttons to change shooting settings quickly or add effects to the images you are shooting.

The following features are allocated to the buttons at the time of shipping.

USER1: FA

USER2: ATW LOCK

USER3: REC CHECK

For details, see the setup menus, SW MODE screen, USER1 SW to USER3 SW. (Page 55)

If you press a USER button to which one of the functions has been assigned, and then turn OFF the power or change the mode during operation of the USER button function, the effect added to the image will not be retained.

Backlight compensation

Press the USER button you have allocated to the BACKLIGHT feature when shooting subjects lit from the back.

BACK appears on the screen.

Backlight compensation adjusts the iris so the subject doesn't come out dark.

Press the same USER button to turn the feature off. (In the manual iris mode, the iris status is retained at the corresponding point even when backlight compensation is canceled.)

- The backlight compensation function does not operate with lenses in which AUTO IRIS is not functioning.

Color bars

Press the BARS button in the CAM mode to output a color bar screen to a television or monitor so you can adjust them. Press the button again to turn the feature off.

- While the color bar is displayed, a test tone of 1 kHz will be output from the headphone terminal or the AUDIO OUT terminal. There will be no speaker output.
- The color bar can be recorded by pressing the START/STOP button.
- The color bar display is canceled when the power is turned off.

Wave form monitor function

An image wave form can be displayed on the LCD monitor by pressing the WFM button while in CAM mode.

Press the button again to return to the normal display.

- Switching the wave form display, vector display, and wave/vector display is possible from the WFM item (page 55) in the SW MODE screen of the settings menu.
- Wave forms will not be displayed in the viewfinder.
- Wave forms cannot be recorded.
- While wave forms are displayed, use the viewfinder as well because a part of the recording screen and screen display will be hidden by wave forms.

Adjusting the volume while shooting

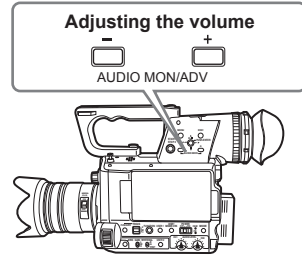

If you are monitoring the sound through headphones while shooting, you can adjust the volume with the AUDIO MON/ADV buttons.

- To adjust the recording level. (Page 18)
- Volume adjustments will be memorized if the power is turned off by moving the POWER switch to the OFF position.

Shot mark function

The marks attached to the thumbnails of clips are called shot marks. On the thumbnail screen monitor you can select only those clips with a shot mark and display them or play them back. During recording, when you press the USER button to which the SHOT MARK function has been allocated, MARK ON appears in the LCD monitor or the viewfinder, and a shot mark is set for the thumbnail of the clip being recorded. If you press the button again, the shot mark is released. You can also set or release the shot marks by performing the thumbnail operations for clips. (Page 31)

However, note that you cannot set or release shot marks during playback.

- INVALID appears when you cannot set or release shot marks.

Index recording

This function allows you to add an index at a certain point of a clip during the recording or playback.

Press the USER button allocated to the INDEX function during recording to record an index signal at this point of the clip. (Pages 11, 55)

Indexes may also be added during playback, and it is also possible to select only clips with indexes for display or playback. (Pages 34, 35)

-
- Up to 100 indexes can be recorded for one clip.
 - When the number of indexes exceeds 100, INVALID is displayed, and no further indexes can be added even when the steps for adding indexes are taken.
 - When repeatedly adding indexes, leave a gap of at least one second between adding one index and the next. If indexes are added with a gap of less than one second between them, only the first operation will be valid.
-

LAST CLIP function

The most recently recorded clip can be deleted at the touch of a button by allocating the LAST CLIP function to any of the USER 1 - 3 buttons.

Press the USER button allocated for the LAST CLIP function to display YES/NO on the screen. Select YES to delete the most recently recorded clip.

- Select NO not to delete the clip.
- If the camera has been switched to PB mode or the recording format has been changed since recording was completed, clips cannot be deleted even if the button is pressed. Clips also cannot be deleted if the power has been switched off and back on again.
- Clips cannot be deleted even if the button is pressed if the memory card has been removed and reinserted since recording was completed.

CAPTURE function

If the CAPTURE feature is assigned to any of the USER 1 - 3 buttons, still images can be shot.

-
- The number of recorded pixels and quality of the still images cannot be changed.
 - This function does not operate when a movie is being recorded, or when the PRE REC mode is in use.
 - The SD memory card used for recording is the same as that used for video recording.
-

Adjusting the shutter speed

Using the SHUTR/F.RATE dial

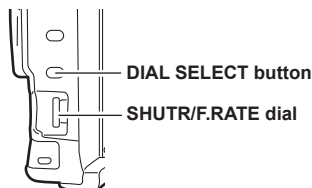

Press the DIAL SELECT button.

- The role of the SHUTR/F.RATE dial changes in the following order.
SHUTTER → SYNCRO SCAN → FRAME RATE
→ DIAL LOCK → SHUTTER →
- SYNCRO SCAN can be selected when the SHUTTER is set to SYNCRO SCAN. FRAME RATE can be selected in the FILM CAM mode when the REC FORMAT is 1080/24P, 30P, and 25P.

To prevent incorrect operation, it is recommended that you selecting DIAL LOCK using the DIAL SELECT button after setting.

Setting the SHUTTER

- 1 Select the SHUTTER function with the DIAL SELECT button.**
- 2 Press the SHUTR/F.RATE dial.**
 - The shutter will turn ON/OFF.
 - The shutter speed is changed in the order shown on the following page by turning the SHUTR/F.RATE dial when the shutter is ON.

- Remember that the faster the shutter speed, the lower the sensitivity.
- Focusing on the subject would take longer if the shutter speed is reduced. It is therefore recommended that the unit be secured to a tripod, etc. during shooting.
- Under the lighting of electric discharge tubes such as fluorescent lamps, horizontal bands may appear on the screen. Adjusting the shutter speed may improve this condition.
- A subject that quickly crosses the camera may appear distorted when shot. This is caused due to the signal reading system of the imaging element (MOS sensor), and is not a defect.
- At slow shutter speeds (1/2 to 1/15), white, red, green, or blue dots may appear on the screen. However, this is not a defect.

Setting the SYNCRO SCAN

- 1 Select SYNCRO SCAN from the SHUTTER settings.**
- 2 Select the SYNCRO SCAN function with the DIAL SELECT button.**
- 3 Turn the SHUTR/F.RATE dial.**
 - The SYNCRO SCAN shutter speed can be set.
 - The speed of change increases when turning the SHUTR/F.RATE while holding it down.
 - SYNCRO SCAN can also be set from the SYNCRO SCAN item in the SCENE FILE screen of MENU settings.

Setting format differs depending on the MENU-SCENE FILE-OPERATION TYPE.

FILM CAM: angle display (180.0d etc.)

VIDEO CAM: speed display (1/48.0 etc.)

FRAME RATE setting

- 1 Select the FRAME RATE function with the DIAL SELECT button.**
- 2 Press the SHUTR/F.RATE dial.**

The camera is in VFR mode.

 - The FRAME RATE can be set by turning the SHUTR/F.RATE dial.
 - FRAME RATE can also be set from the FRAME RATE item in the SCENE FILE screen of MENU settings.

- Before using the FRAME_RATE function, it is necessary for the MENU-SCENE FILE-OPERATION TYPE to be set to FILM CAM, and the MENU-SCENE FILE-REC FORMAT to be set to PH1080/24P or PH1080/30P (or PH1080/25P).
- The FRAME RATE function cannot be set when SDI 24PsF is set to ON in the AV IN/OUT SETUP screen of MENU settings.
- When the FRAME RATE function is set to ON, the camera is automatically set to manual focus.

When SYSTEM FREQ = 59.94Hz /OPERATION TYPE = FILM CAM

1080/60i, 720/60P	
Normal (OFF) 1/60	SYNCRO SCAN ↔ 1/100 ↔ 1/120 ↓ 1/2000 ↔ 1/1000 ↔ 1/500 ↔ 1/250 ↑
1080/30P, 720/30P	
Normal (OFF) 1/50	SYNCRO SCAN ↔ 1/30 ↔ 1/60 ↔ 1/120 ↓ 1/2000 ↔ 1/1000 ↔ 1/500 ↔ 1/250 ↑
1080/24P, 720/24P	
Normal (OFF) 1/50	SYNCRO SCAN ↔ 1/24 ↔ 1/60 ↔ 1/120 ↓ 1/2000 ↔ 1/1000 ↔ 1/500 ↔ 1/250 ↑

SYSTEM FREQ = 50Hz /OPERATION TYPE = FILM CAM

1080/50i, 720/50P	
Normal (OFF) 1/50	SYNCRO SCAN ↔ 1/60 ↔ 1/120 ↓ 1/2000 ↔ 1/1000 ↔ 1/500 ↔ 1/250 ↑
1080/25P, 720/25P	
Normal (OFF) 1/50	SYNCRO SCAN ↔ 1/25 ↔ 1/60 ↔ 1/120 ↓ 1/2000 ↔ 1/1000 ↔ 1/500 ↔ 1/250 ↑

SYSTEM FREQ = 59.94Hz /OPERATION TYPE = VIDEO CAM

1080/60i, 720/60P	
Normal (OFF) 1/60	SYNCRO SCAN ↔ 1/2 ↔ 1/4 ↔ 1/8 ↔ 1/15 ↔ 1/30 ↓ 1/2000 ↔ 1/1000 ↔ 1/500 ↔ 1/250 ↔ 1/120 ↔ 1/100 ↑
1080/30P, 720/30P	
Normal (OFF) 1/50	SYNCRO SCAN ↔ 1/2 ↔ 1/4 ↔ 1/8 ↔ 1/15 ↔ 1/30 ↓ 1/2000 ↔ 1/1000 ↔ 1/500 ↔ 1/250 ↔ 1/120 ↔ 1/60 ↑
1080/24P, 720/24P	
Normal (OFF) 1/50	SYNCRO SCAN ↔ 1/2 ↔ 1/3 ↔ 1/6 ↔ 1/12 ↔ 1/24 ↓ 1/2000 ↔ 1/1000 ↔ 1/500 ↔ 1/250 ↔ 1/120 ↔ 1/60 ↑

SYSTEM FREQ = 50Hz /OPERATION TYPE = VIDEO CAM

1080/50i, 1080/25P, 720/50P, 720/25P	
Normal (OFF) 1/50	SYNCRO SCAN ↔ 1/2 ↔ 1/3 ↔ 1/6 ↔ 1/12 ↔ 1/25 ↓ 1/2000 ↔ 1/1000 ↔ 1/500 ↔ 1/250 ↔ 1/120 ↔ 1/60 ↑

Synchro scan

The synchro scan shutter speed used when shooting screens such as a TV screen or computer monitor is set using the SHUTTR/F RATE dial (page 14) or the SYNCRO SCAN option on the settings menu SCENE FILE screen. (page 51)

- Adjust the shutter speed to match the frequency of the television or computer monitor to minimize the horizontal noise that appears when shooting such subjects.
- By switching to progressive mode you can also shoot PAL system television screens.
- If the set value of the SYNCRO SCAN item of settings menu is displayed in gray, it cannot be used with the current recording format. This function will only operate for preset values for each recording format, as listed below.

60i/60P mode: 1/60

30P mode: 1/30

You can change the progressive mode in the setup menu with REC FORMAT in the SCENE FILE screen. (Page 51)

Switching Audio Input

During shooting, you can record up to two channels of sound. You can also switch the input sound to be recorded on each of the channels to the built-in microphones, external microphones or audio equipment connected to camera.

CH1 SELECT switch

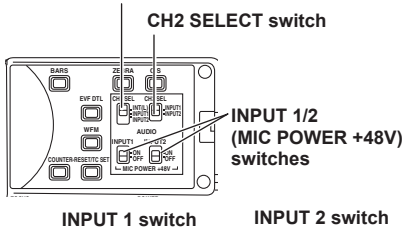

INPUT 1 switch

INPUT 2 switch

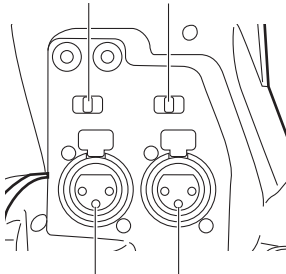

INPUT 1 terminal

INPUT 2 terminal

Using the built-in microphone

- 1 **Switch the CH1 SELECT switch to INT (L).**
 - Audio from the built-in microphone Lch is recorded to audio channel 1.
- 2 **Switch the CH2 SELECT switch to INT (R).**
 - Audio from the built-in microphone Rch is recorded to audio channel 2.

Using an external microphone and audio equipment

- 1 **Connect an external microphone or audio equipment to the INPUT 1/2 (XLR 3-pin) terminals. (Page 41)**
- 2 **Use the INPUT 1/2 switches to switch the audio input.**

LINE: (audio equipment is connected)
Input level is 0 dBu.

MIC: (an external microphone is connected)
Input level is -50 dBu.

You can change the input level to -60 dBu in the setup menus, RECORDING SETUP screen MIC GAIN1 and MIC GAIN2. (Page 56)
Be aware that sensitivity will be higher if you choose -60 dBu so you will record more noise.
- 3 **When using the phantom microphone (which requires + 48V power supply), set the INPUT 1/2 (MIC POWER +48V) switches to ON.**

ON: (When using the phantom microphone)
+48V power supply to INPUT 1/2 terminals.

OFF: (When a phantom microphone is not connected)
No power supply for INPUT 1/2 terminals.

 - The battery will discharge faster if you use a phantom microphone.
 - Set to OFF if you connect equipment not compatible with +48V. You can damage such equipment if you leave the setting at ON.
 - When using the AG-MC200G (optional), set the MIC GAIN item to -50 dBu.

4 Use the CH1 SELECT switch to select the input signal to be recorded to audio channel 1. INT (L):

Audio from the built-in microphone Lch is recorded to audio channel 1.

INPUT 1:

Audio from a device connected to INPUT 1 terminal is recorded to channel 1.

INPUT 2:

Audio from a device connected to INPUT 2 terminal is recorded to channel 1.

5 Use the CH2 SELECT switch to select the input signal to be recorded to audio channel 2. INT (R):

Audio from the built-in microphone Rch is recorded to audio channel 2.

INPUT 2:

Audio from a device connected to INPUT 2 terminal is recorded to channel 2.

-
- When inputting the microphone signal to channels 1 and 2, connect the microphone to INPUT 2 and switch both CH1 SELECT and CH2 SELECT to INPUT 2.
-

Adjusting the recording level

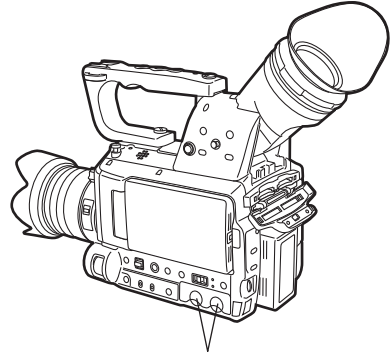

AUDIO control knobs

Use the AUDIO control knobs to adjust the recording level of the built-in microphone or of audio signals input through the INPUT 1/2 (XLR 3-pin) terminals.

To adjust the volume of the sound for monitoring. (Page 12)

To adjust the recording level of the audio signals, turn the AUDIO control knobs while referring to the audio level meter at the bottom left of the viewfinder and LCD monitor, regardless of the MIC ALC option setting (Page 56) on the RECORDING SETUP screen of the setting menu.



-
- Check the recording volume level prior to shooting.
 - The recording level of this camera is set approximately 8 dB higher than Panasonic broadcasting camera recorders (AJ series products).
-

Using scene files

The settings according to the variety of shooting circumstances are stored SCENE FILE MENU. They are selected via the SCENE SELECT on the settings menu SCENE FILE screen.

When the camera-recorder is shipped from the factory, the following files are stored.

F1:

File suitable for normal shooting.

F2: FLUO.

File suitable for shooting under fluorescent lights, ie. indoors.

F3: SPARK

File suitable for shooting with fuller variations of resolution, coloring and contrast.

F4: B-STR

File for broadening the contrast of dark parts, such as when shooting sunsets.

F5: CINE V

File suitable for shooting movie-like scenes where the contrast is to be emphasized. (The recording format remains unchanged even when the scene file is changed. It must be set using the REC FORMAT item on the SCENE FILE screen. (Page 51))

F6: CINE D

File suitable for shooting movie-like scenes where the dynamic range is to be emphasized. (The recording format remains unchanged even when the scene file is changed. It must be set using the REC FORMAT item on the SCENE FILE screen. (Page 51))

Changing scene file settings

The setting value of the scene file can be changed. Also you can save the changed scene file to each position of the SCENE FILE dial.

Example: Change the name of the scene file.

- 1 Set the POWER switch to ON.**
- 2 Select the scene file to be changed in the SCENE FILE MENU.**
- 3 In the setup menus, select the SCENE FILE screen.**
 - For menu operation (Page 44 of Vol.1)
 - Operations may also be performed using buttons on the remote control that correspond to those on the camera. For details, see "Description of parts (Remote control)". (Page 23 of Vol.1)
- 4 Tilt the Operation lever in the ▲ ▼ directions and select the NAME EDIT item.**
- 5 Push the Operation lever (or tilt in the ► direction), tilt in the ▲ direction to select YES, and push the Operation lever again.**

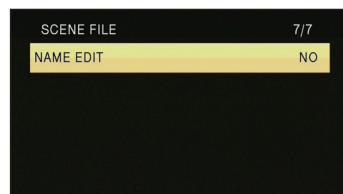

6 Set a 6-character filename with the Operation lever when the following screen is displayed.

Set the same as user information. (Page 27)

- Characters that can be set
Space, A to Z, 0 to 9, ; ; < = > ? @ [¥] ^ _ - /
If the RESET/TC SET button is pressed when the filename has been set, the characters are cleared.

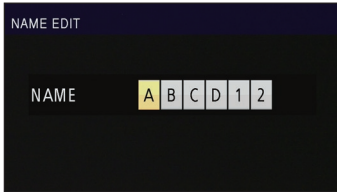

7 After you finish setting the filename, push the Operation lever.

- 8 Select YES on the confirmation screen.**
- Selecting YES will close the NAME EDIT screen and confirm all changes.
 - Once confirmed, all changed names and values will be saved even if the power is switched off or the scene dial is moved.

Saving scene files and other settings on SD Memory Cards

You can save up to four scene file settings or other settings as files on an SD Memory Card, and you can also load them from the card.

- In the case of the scene files, the current settings are automatically saved in the unit, and the saved data is written on an SD Memory Card. When data has been read from an SD Memory Card, the current settings are rewritten at the same time as the data saved inside the unit.
- The data in all the scene files, F1 to F6, is rewritten.

If you have saved a scene file

- 1 Set the unit's POWER switch to ON.**
- 2 Select the slot number for the SD memory card onto which you wish to save from the CARD WRITE option on the settings menu SCENE FILE screen, and press the OPERATION lever.**

For all other settings, select USER FILE.

- For menu operations (Page 44 of Vol.1)
- Operations may also be performed using buttons on the remote control that correspond to those on the camera. For details, see "Description of parts (Remote control)". (Page 23 of Vol.1)

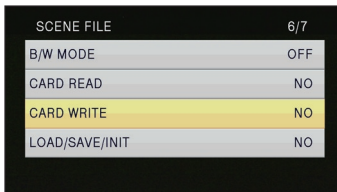

- 3 Tilt the Operation lever in the ▲ ▼ directions, select the file number (1 - 4), and push the Operation lever.**

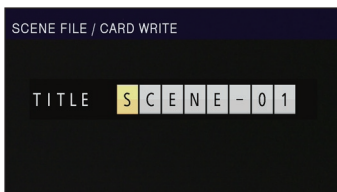
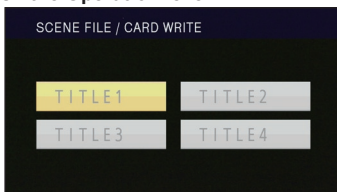

- 4 Push the Operation lever again, select YES when the following screen is displayed, and push the Operation lever.**

- In the following example, SCENE-01 is the TITLE name. To change the TITLE name, see the description below.

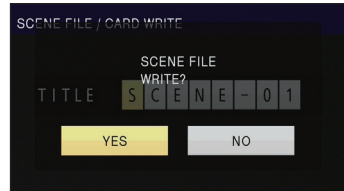

- 5 Press the MENU button to exit the menu mode.**

To read files

- 1) Select READ in step 2 and push the Operation lever.
- 2) Select the file number and push the Operation lever.
- 3) Select YES on the confirmation screen. READ COMPLETED will be displayed when reading is complete.

To add titles to files

- 1) Go through steps 1 - 3.
- 2) Tilt the Operation lever in the ▲ ▼ directions to select characters, and tilt in the ► direction to move to the next character.
The following characters may be inputted.
(Space), A-Z, 0-9, ; < = > ? @ [¥] ^ _ - . /
- 3) Push the Operation lever when all characters have been inputted.
- 4) Select YES on the confirmation screen.

-
- If WRITE PROTECT appears, release the protected status of the SD Memory Card.
 - If WRITE NG CANNOT ACCESS appears, quit all other operations (such as playback) before proceeding.
-

Clip metadata

You can add the video and audio systems, name of the videographer, shooting location, text memos and other information to the video data you have recorded on the SD Memory Card. This data is called the clip metadata.

(Display method: Page 38)

There are two kinds of clip metadata: the data that is recorded automatically during shooting, and the data in the metadata upload file created on the SD Memory Card which is loaded in the unit.

(Loading method: Next page)

What the clip metadata consists of

You can set the items underlined below by loading the metadata upload file on the SD Memory Card. All other items are set automatically during shooting.

GLOBAL CLIP ID:

This indicates the global clip ID that shows the shooting status of the clip.

USER CLIP NAME :

This indicates the name of the clip that the user has set.*1

VIDEO & AUDIO:

This indicates the recorded image's FRAME RATE, RESOLUTION, PULL DOWN system and AUDIO.

LENS:

This indicates the MAKER, MODEL, and SERIAL No. of your lens.

ACCESS:

This indicates the CREATOR (name of the person recording), CREATION DATE (recording date), LAST UPDATE DATE (date on which the data was last updated) and LAST UPDATE PERSON (the person who last updated the data).

DEVICE:

This indicates the MANUFACTURER (manufacturer of the equipment), SERIAL NO. (serial number of the equipment) and MODEL NAME (Equipment model name: AG-AF100 for this camera-recorder).

SHOOT:

This indicates the SHOOTER (name of the videographer) and the PLACE NAME (name of location).

LOCATION:

This indicates ALTITUDE, LONGITUDE, LATITUDE, and SOURCE (altitude, longitude, latitude, information source). Not recorded in this camera-recorder.

SCENARIO:*2

This indicates the PROGRAM NAME, SCENE NO. and TAKE NO.

NEWS 1:

This indicates the REPORTER (name of the reporter) and PURPOSE (purpose of data collection).

NEWS 2:

This indicates the OBJECT (target of data collection).

MEMO:*3

This indicates the PERSON (name of the person who recorded the text memo) and TEXT (contents of memo).

*1 If there is no information in the metadata upload file, consecutive five-digit numbers will be applied to the clips in the order that they were recorded, with the first clip to be recorded being given the number 0. The USER CLIP NAME recording method is selectable. Please refer to the page 23.

*2 When SCENARIO is to be input, you must input the PROGRAM NAME. You cannot input the SCENE NO. and TAKE NO. only.

*3 When MEMO is to be input, you must input TEXT. You cannot input PERSON only.

-
- Only printable ASCII characters can be displayed by this unit.
 - Due to the limitations imposed by this unit on the number of characters which can be displayed, not all the data can be displayed. (This does not mean that the data which is not displayed has been deleted.) Use an AVCCAM viewer or other program to check all the data.
 - Metadata can be produced with AVCCAM Viewer. (Page 73)
-

Uploading the metadata (META DATA)

You can perform any of the following operations. If necessary, make preparations prior to undertaking the operations.

Loading the metadata

- Insert the SD Memory Card on which the metadata is recorded into the unit. (For details on contents of the metadata, see the previous page.)

Selecting whether to record the metadata on the SD Memory Card

Initializing the metadata inside the unit Displaying the metadata inside the unit

- 1 Press the mode button and select CAM mode.**
- 2 Press the MENU button.**
Menu operation (Page 44 of Vol.1)
- 3 Tilt the lever in the ▲ ▼ directions to select META DATA, and push the Operation lever (or tilt in the ► direction).**

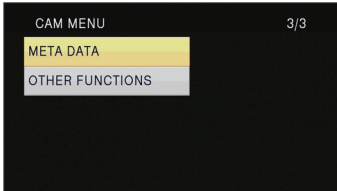

- 4 Tilt the Operation lever in the ▲ ▼ directions to select item, and push the Operation lever.**

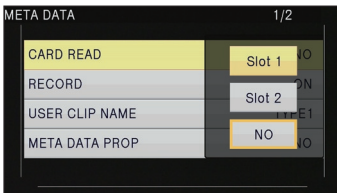

CARD READ:

Read metadata set to the SD Memory Card with the camera.
Move to LOAD, push the Operation lever, select whether or not to read the metadata (YES/NO), and push the Operation lever again.

- Up to 10 items of metadata on the SD Memory Card can be displayed, starting from the most recent date of production.
- If characters other than single-byte alphanumeric characters are used in the metadata file name to be loaded, they are displayed as “*”.

RECORD:

Select this to set whether to record the metadata to be loaded into the unit simultaneously on the SD Memory Card. Select ON to record the metadata or OFF to cancel the recording, and push the Operation lever. The factory setting for this mode is OFF.

USER CLIP NAME:

The USER CLIP NAME recording method is selectable. Please refer to the next column below.

META DATA PROP:

Select this to display the metadata which has been recorded in the unit.

CLIP COUNT RESET:

Reset the counter value to 1.
Select whether or not to reset (YES/NO), and push the Operation lever.

META INIT SET:

Select this to initialize the metadata which has been recorded in the unit.
Select YES to initialize the metadata or NO to cancel the initialization, and push the Operation lever.

- 5 Press the MENU button to release the menu mode.**

Selecting the USER CLIP NAME recording method

Press the MENU button and select META DATA → USER CLIP NAME to select the recording method. Two options are available: TYPE1 and TYPE2.

USER CLIP NAME to be recorded

	TYPE1	TYPE2
If clip metadata has been read in	Uploaded data	Uploaded data + COUNT value*
If no clip metadata has been read in or if the setting for recording clip metadata has been turned off	Sequential 5-digit number, in order of recording	Sequential 5-digit number, in order of recording

Clip metadata (continued)

* The COUNT value is indicated as a four-digit number. The COUNT value is incremented each time a new clip is captured if clip metadata has been read in and TYPE2 has been selected as the recording method.

The COUNT value can be reset using the following procedure.

Press the MENU button, select META DATA→CLIP COUNT RESET→YES, and push the Operation lever to reset the counter value to 1.

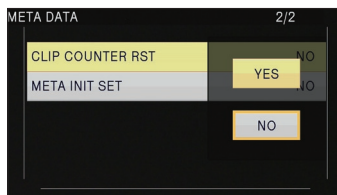

Using the Counter

Counter display

You can display a counter that indicates how much time has elapsed during shooting or playback.

1 Press the COUNTER button.

Each time you press the button, the display changes as follows. (Page 45)

0 : 00. 00 (CAM mode only)

Counter value

Displayed when TOTAL is selected from the REC COUNTER item in the DISPLAY SETUP screen of MENU settings.

CLIP 0 : 00 . 00

Displayed when CLIP is selected in the REC COUNTER item on the settings menu DISPLAY SETUP screen.

Values are automatically reset when recording is started, and counter values are displayed for each individual clip.

TC 12 : 34 : 56 . 01

Time code value (Display time code frame digits in 24 frames when 24P is set, and in 30 frames when any other format is set.)

UB 12 34 56 78

User information

No display:

Data is not displayed.

TC preset mode

When shooting using a multi-camera, you can synchronously set the initial values of time code. The camera used for synchronization is the MASTER and the camera being synchronized is the SLAVE.

1 Connect the TC PRESET IN/OUT terminals (VIDEO OUT terminals) on the two devices with a pin cable, and turn on the power.

■ MASTER settings

2 Check that the MASTER camera is set to the CAM mode, and set the EXT TC LINK item on the setting menu TC/UB SETUP screen to MASTER.

OUTPUTTING LTC SIGNAL is displayed on the screen, and the time code is output from the TC PRESET IN/OUT terminal (VIDEO OUT terminal).

- Select the same REC FORMAT setting for both the MASTER and SLAVE cameras, and set the TCG item on the TC/UB SETUP screen to FREE RUN.
- To cancel the time code output, press the MENU button.

■ SLAVE settings

3 Set the EXT TC LINK item on the setting menu TC/UB SETUP screen to SLAVE.

4 Press the COUNTER - RESET/TC SET button. TCG values will be reset to the TC values inputted from the MASTER.

- TC LINK OK will be displayed for approximately 2 seconds when the menu screen is closed.
- If the TC values cannot be set correctly, LINK NG will be displayed.
- If the SLAVE device is set to 24P, please set the TC MODE item on the MASTER device to NDF.
- To cancel the SLAVE mode, press the MENU button.

Charging the built-in battery/Setting the time code

Recharging the built-in battery

The camera's internal battery saves the date and time.

When LOW INTERNAL BATTERY (indicating that the internal battery has no remaining charge) is displayed even when the date and time are set, it means that the charge of the internal battery is depleted. Do the following to recharge it. Reset the date and time when fully recharged.

1 Connect the AC adaptor. (Page 25 of Vol.1)

- Leave the POWER switch at OFF.

2 Leave the camera-recorder like this for about 4 hours.

- The internal battery charges during this time.
- Check the time code and menu operations after recharging.

If the date and time are not memorized after recharging, the internal battery requires changing. Please consult the place of purchase.

Setting the time code

In the setup menus, TC/UB SETUP screen, set the following time code related items. (Page 57)

- TC MODE
- TCG
- TC PRESET

Specifying the time code (TC PRESET)

Set TC PRESET so you can record a value of your choice as the initial setting for the time code to be used at the start of recording.

1 Set the POWER switch to ON.

2 Select the TC PRESET item in the settings menu TC/UB SETUP screen.

- For menu operation (Page 44 of Vol.1)
- Operations may also be performed using buttons on the remote control that correspond to those on the camera. For details, see "Description of parts (Remote control)". (Page 23 of Vol.1)

3 Tilt the Operation lever in the ▲ direction to move to YES, and push the Operation lever.

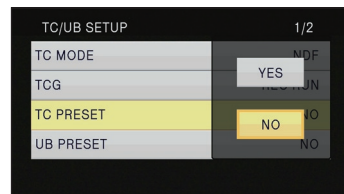

Charging the built-in battery/Setting the time code (continued)

4 When the screen below appears, set the time code value.

Tilt the Operation lever in the ▲ ▼ directions and select time code value.



Tilt in the ► direction to move to the next digit, and tilt in the ▲ ▼ directions again to select value.



You can reset the time code to zero by pressing RESET/TC SET button.

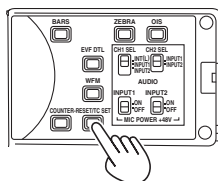

Camera

5 Push the Operation lever when you have finished setting the time code.

6 Tilt the Operation lever in the ◀ direction to move to YES, and push the Operation lever.



With this unit, the time code value is adjusted in accordance with the format and frame rate. For this reason, bear in mind that making a change in the format or frame rate may result in discontinuity from the last time code value of the previous recording.

Adjustments are made in 4-frame increments when the recording format is 24P.

Recording format	Time code adjustment
1080/24P 720/24P	Adjustable in 4-frame increments

Setting user information

Setting user information allows you to store 8-digit information in the hexadecimal format.

User information is automatically saved in the memory and retained after you turn off the power.

- 1 Set the POWER switch to ON.
- 2 In the setup menus, TC/UB SETUP screen, select UB PRESET.
 - For menu operation (Page 44 of Vol.1)
 - Operations may also be performed using buttons on the remote control that correspond to those on the camera. For details, see “Description of parts (Remote control)”. (Page 23 of Vol.1)
- 3 Tilt the Operation lever in the ▲ direction to move to YES, and push the Operation lever.

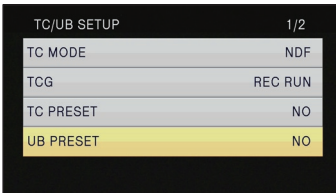

4 Set the user information.

Tilt the Operation lever in the ▲▼ directions and select user information characters.

- You can use numbers from 0 to 9 and letters from A to F.

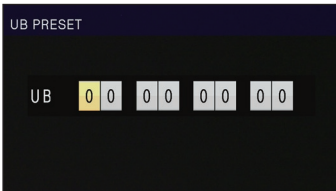

Tilt in the ► direction to move to the next digit, and tilt in the ▲▼ directions again to select character.

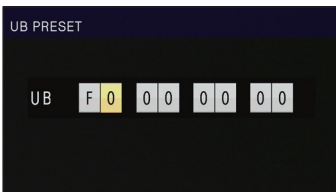

You can reset the user information to nothing by pressing RESET/TC SET button.

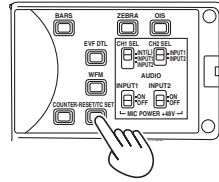

Camera

- 5 Push the Operation lever when you have finished setting the user information.
- 6 Tilt the Operation lever in the ◀ direction to move to YES, and push the Operation lever.



Basic playback operations

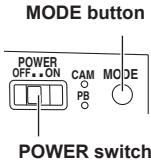

- 1** Turn the **POWER** switch to **ON**.
 - 2** Press the mode button so the **PB lamp** turns on.
 - The camera is now in the PB mode.
 - Each time you press the button, the mode changes as below.
- PB ↔ CAM

For details on playing back clips using thumbnails, see page 29.

Operations using the Operation lever		Remote control
	<p>Play (▶)</p> <p>Press to play the clip currently indicated by the cursor.</p>	
	<p>Fast forward (▶▶)</p> <p>Press during playback to scroll quickly through the clip at approximately 10 times the speed.</p> <p>Repeat the operation to scroll quickly at approximately 20 times the speed.</p> <p>Press <u>while paused</u> to move to the next clip.</p>	
	<p>Rewind (◀◀)</p> <p>Press during playback to scroll quickly backwards through the clip at approximately 10 times the speed.</p> <p>Repeat the operation to scroll quickly backwards at approximately 20 times the speed.</p> <p>Press <u>while paused</u> to move to the previous clip.</p>	
	<p>Stop (■)</p>	
	<p>Pause ()</p> <p>Press during playback to pause the clip.</p> <p>Press again to return to normal playback.</p>	

Thumbnail screen

Video data created in one shooting session is called a clip. When the PB mode has been established, the clips will be displayed on the LCD monitor and the viewfinder as thumbnails. (When there is a large number of clips, it will take some time for them to be displayed on the screen.)

You can perform the following operations using the thumbnail screen.

- Play and delete clips
- Format SD Memory Card
- Add or delete index
- Add or delete shot mark

Basic thumbnail screen operations

To select thumbnail:

Tilt the Operation lever in the ▲▼◀▶ directions to select thumbnail (Orange frame moves).

To play back clips:

Select the thumbnail, and push the Operation lever. (For details on playback, see page 28.)

To change the slot for playback:

Press the SLOT SELECT button to select the slot.

To play back still images:

Press the SLOT SELECT button to select the slot.

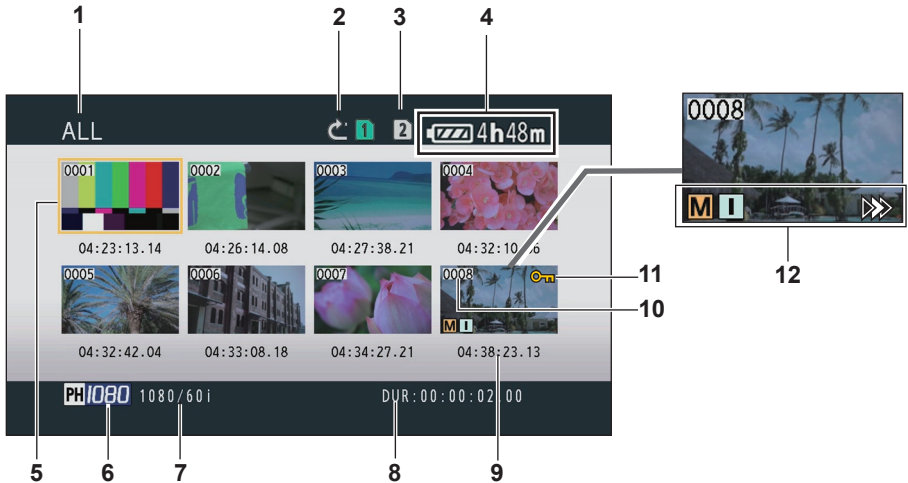
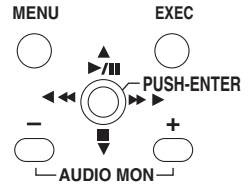

Thumbnail screen (continued)

- 1 Thumbnail display status (Page 34)**

The types of clips displayed as thumbnails appear in this area.
- 2 Repeat playback indicator (Page 32)**

Displayed during repeat playback.
- 3 Card status display**

Displays status of SD Memory Card.
- 4 Battery remaining display (Page 24 of Vol.1)**

Displays remaining battery capacity.
- 5 Cursor (Orange frame)**

Displayed on currently selected thumbnail.
- 6 Recording mode display**

Displays recording mode if clip currently highlighted by cursor has been recorded in PH mode.
- 7 Recording format display**

Displays recording format of currently selected clip.
- 8 Duration display**

Displays duration of currently selected clip.
- 9 Time display (Page 34)**

Displays time code at start of clip recording/ user information at start of clip recording/time of recording/date of recording/date and time of recording – according to settings.
- 10 Clip number**

Displayed in order of recording (up to 1000 clips). Numbers of clips that cannot be played back (e.g. clips of different recording formats) are displayed in red. To play clips displayed in red, set the PB format in the settings menu PLAY SETUP screen to the appropriate recording format (Page 64).
- 11  : Clip protect display**

Displayed on protected clips.
- 12 Indicators**
 -  : Shot mark**

This indicates that a clip has a shot mark.
(Next page)
 -  : Index**

Displayed when indexes have been attached
(Page 35).
 -  : Resume playback display**

Displayed on clips on which resume playback setting has been applied.

Adding shot marks to clips

Adding shot marks (**[M]**) will make it easier to find the clips you are looking for.

- 1 Tilt the Operation lever in the ▲▼◀▶ directions to move the yellow frame to the clip for which a shot mark is to be added.
 - 2 Press the USER button to which the shot mark function has been allocated. (Page 55)
- To release a shot mark, repeat the above steps.
- It is not possible to add shot marks to clips recorded using a consumer camcorder model.

Select the card slot for playback

You can switch the SD memory card slot for playback.

- 1 Press the SLOT SELECT button when the THUMBNAIL screen is displayed in the PB mode.

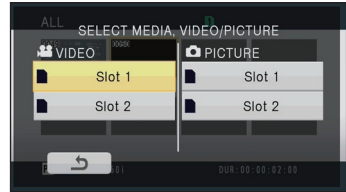

- 2 Tilt the OPERATION lever in the up, down, left, and right directions to select the SD memory card slot for playback. You can play back still images as well.
 - VIDEO:
 - Movie playback
 - PICTURE:
 - Still picture playback
- 3 Push the OPERATION lever.

Playback settings (PLAY SETUP)

Make settings for playback format and method.

Set playback format (PB FORMAT)

Set format for playback.

- 1 Press the MENU button.**
Menu operation (Page 44 of Vol.1)
- 2 Select the PB FORMAT item in the PLAY SETUP screen, and push the Operation lever (or tilt in the ► direction).**

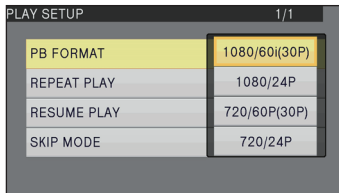

- 3 Tilt the Operation lever in the ▲ ▼ directions to select the format for playback, and push the Operation lever.**

- The setting for the REC FORMAT item on the setting menu SCENE FILE screen is reflected as the initial setting.
- Clip numbers will be displayed in black where playback is possible, and in red where playback is not possible.

-
- Even if the playback format is changed, the format set in the REC FORMAT item on the settings menu SCENE FILE screen will be restored when the camera is switched to CAM mode.
 - If the playback format does not conform to the clips created at the relay destination using the relay recording function, thumbnail images will not be displayed (! will be displayed). Thumbnail images will be displayed when the playback format is matched to the clips.
-

Repeat playback (REPEAT PLAY)

Use this setting to repeatedly play back all available clips.

- 1 Press the MENU button.**
Menu operation (Page 44 of Vol.1)
- 2 Set the REPEAT PLAY item in the PLAY SETUP screen to ON.**
- 3 Press the MENU button to return to the thumbnail screen.**
The repeat playback indicator will be displayed. When the playback operation is performed, the playable clips are played back repeatedly.
 - Repeat playback will continue until playback is paused.
 - To turn the repeat playback setting off, select OFF in step 2.

Resume playback (RESUME PLAY)

Use this setting to play back from where clip had previously been paused.

- 1 Press the MENU button.**
Menu operation (Page 44 of Vol.1)
- 2 Set the RESUME PLAY item in the PLAY SETUP screen to ON.**
- 3 Press the MENU button to return to the thumbnail screen.**
- 4 Select a clip for playback.**
If playback has previously been paused, the resume playback indicator will be displayed on the clip thumbnail, and the remainder of the clip will be played next time the clip is selected for playback.
 - To turn the resume playback setting off, select OFF in step 2.

Set skip method (SKIP MODE)

Select which skip (cue) operation is to be performed when playback is paused.

- 1 Press the MENU button.**
Menu operation (Page 44 of Vol.1)
- 2 Select the SKIP MODE item in the PLAY SETUP screen.**
- 3 Select skip method.**
CLIP:
Move to the beginning of the previous or next clip by tilting the Operation lever in the ◀ or ▶ direction while playback is paused.
CLIP & INDEX:
Move to the beginning of the previous or next clip, or to the previous or next INDEX position, by tilting the Operation lever in the ◀ or ▶ direction while playback is paused.
- 4 Press the MENU button to return to the thumbnail screen.**

Thumbnail operations

Selecting the thumbnail display method (THUMBNAIL)

You can display the kind of clips you want to see as thumbnails.

You can also set more precisely how you want the thumbnails to appear on the screen.

- 1 Press the MENU button.**
Menu operation (Page 44 of Vol.1)
- 2 Select the THUMBNAIL screen, and push the Operation lever (or tilt in the ► direction).**
- 3 Tilt the Operation lever in the ▲ ▼ directions to select item, and push the Operation lever.**

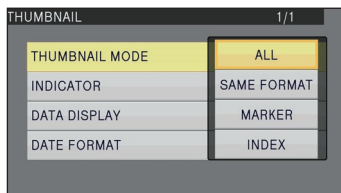

THUMBNAIL MODE:

Select the clips to be displayed.

ALL:

Display all clips.

SAME FORMAT:

Display all clips of the same format as the current PB format.

MARKER:

Display all clips with shot marks.

INDEX:

Display all clips with indexes.

INDICATOR:

Set whether or not to display indicator (ON/OFF). (Factory default setting is ON.)

Clip protect display and resume playback display will still appear even if this setting is set to OFF.

DATA DISPLAY:

Select format of clip time display – time code (TC)/user information (UB)/recording time (TIME)/recording date (DATE)/ recording date and time (DATE & TIME). If recording time (TIME) is selected, the display will be in the format "Month-Day Time".

DATE FORMAT:

Select display order for recording date - year-month-date (Y-M-D)/month-date-year (M-D-Y)/date-month-year (D-M-Y).

This setting will not be reflected in CLIP PROPERTY.

- 4 Press the MENU button to return to the thumbnail screen.**

Deleting and protecting clips (OPERATION)

Clips may be deleted or protected.

1 Press the MENU button.

Menu operation (Page 44 of Vol.1)

2 Select the OPERATION screen, and push the Operation lever (or tilt in the ► direction).

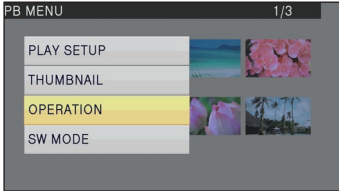

3 Tilt the Operation lever in the ▲ ▼ directions to select item, and push the Operation lever.

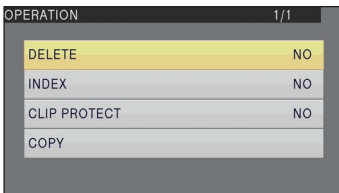

DELETE:

ALL CLIPS:

Delete all clips.

Select whether or not to delete (YES/NO), and push the Operation lever.

SELECT:

Delete selected clips.

Select clips with the Operation lever. If clips are selected with the OPERATION lever, the selected clips appear within a red frame. (Repeat this operation to select multiple clips.)

Press the EXEC button to confirm, tilt the Operation lever in the ▲ ▼ directions to select whether or not to delete (YES/NO), and push the Operation lever.

NO:

Return to the previous screen.

- Protected clips cannot be deleted.
- If selecting ALL CLIPS to delete all clips from the memory, this operation may take some time to complete, depending on the volume of clips to be deleted.
- Deletion cannot be performed via the remote control.
- To abort deletion, press the CANCEL button. The already deleted clips cannot be restored even if the deletion process is aborted.

INDEX:

YES:

Attach indexes to selected clips.

- 1) Select clip to play, and push the Operation lever at the point for an index to be added.



- 2) Select YES on the confirmation screen to attach index.

- The point in the clip at which the index will actually be attached will be accurate to within an error of 0.5 seconds.
- To delete index, select INDEX→YES in step 3 before performing the following.
 - 1) Select clip to play, tilt the Operation lever in the ▲ direction, and pause the clip.
 - 2) Tilt the Operation lever in the ◀▶ directions to move the pointer between the points where indexes are attached. Move the pointer to the index to be deleted, and push the Operation lever.
 - 3) Select YES on the confirmation screen.

NO:

Return to the previous screen.

- It is not possible to add indexes to clips recorded using a consumer camcorder model.
- It is not possible to adjust the volume during index playback.

CLIP PROTECT:

YES:

Protect selected clips.

(**On** mark will be displayed.)

- Cancel protection when the protected clip is selected.

(**On** mark will disappear.)

Executing a format of the memory card (see below) will delete all clips even if they are protected.

NO:

Return to the previous screen.

4 Press the MENU button to return to the thumbnail screen.

Copying clips (COPY)

Clips recorded onto SD cards can be copied onto other SD cards.

1 Insert the SD card containing the clip you wish to copy into one of the SD card slots.

2 Insert the card you wish to copy the clip onto into the other SD card slot.

- Clips cannot be copied if there is not enough space available on the target card.

3 Select COPY from OPERATION of the PB MENU.

4 Select the type of data to be copied.

VIDEO&PICTURE:

Video images and photograph data

VIDEO:

Video images only

PICTURE:

Photograph data only

5 Select copy method.

Copying VIDEO

ALL CLIPS:

All scenes

SELECT CLIPS:

Select scenes.

SAME FORMAT:

Scenes of the same format as the current PB format

INDEX:

Scenes with INDEX input

MARK:

Scenes with scene MARK input

Copying PICTURE

ALL SCENES:

All scenes

SELECT CLIPS:

Select scenes.

6 Select start copy.

Do not open the SD card slot covers or switch the camera off during copy operations.

- The copy function will not operate if the remaining battery capacity is insufficient. Exchange the battery for a charged one, or use the AC adaptor.

Clips recorded with AG-3DA1 cannot be selected for copying in this camera. Clips that cannot be played back in this camera cannot be selected as well. However, pictures that cannot be played back in this camera can be selected and copied.

Format card and check clip and card information (CARD FUNCTIONS)

SD Memory Cards can be formatted, and clip and SD Memory Card information can be checked.

1 Press the MENU button.

Menu operation (Page 44 of Vol.1)

2 Select CARD FUNCTIONS, and push the Operation lever (or tilt in the ► direction).

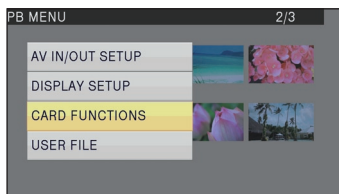

3 Tilt the Operation lever in the ▲▼ directions to select item, and push the Operation lever.

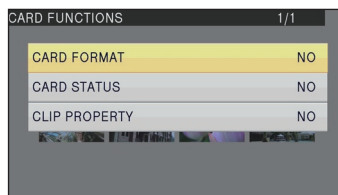

CARD FORMAT:

- Insert card to be formatted into the camera.
- SD Memory Card will be formatted. Proceeding will delete the entire data, including videos and picture data, from the card. Select whether or not to format (YES/NO), and push the Operation lever.

CARD STATUS:

Display SD Memory Card information.
(Next page)

CLIP PROPERTY:

Display information of selected clip.
(Next page)

- Tilt the Operation lever in the ◀▶ directions to display information from previous or subsequent clips.

4 Press the MENU button to return to the thumbnail screen.

Thumbnail operations (continued)

SD Memory Card information screen

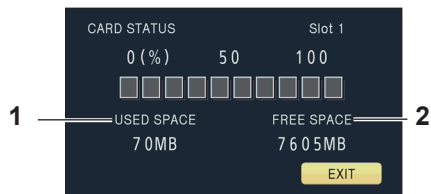

1 USED SPACE :

Used space

2 FREE SPACE :

Available space

Clip information screen

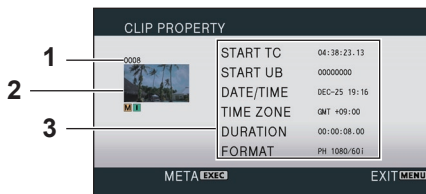

1 Clip number

2 Thumbnail (Thumbnail screen: Page 29)

3 Clip information

Displays data attached to the clip.

START TC: Time code value at start of recording

START UB: User information value at start of recording

DATE/TIME: Date of recording at time at start of recording

TIME ZONE: Displays time zone.

DURATION: Clip length

FORMAT: Recording format

• Clip meta data

Press the EXEC button while the clip information screen is being displayed to display more detailed information, including video and audio formats, and information about the videographer, etc.

Tilt the Operation lever in the ▲ ▼ directions to verify the desired information. (Please see page 22 for more information on clip metadata.)

Useful playback functions

Fast forward/rewind

- 1 Tilt the Operation lever in the ◀◀ (rewind) or ▶▶ (fast forward) direction during playback (or press the SEARCH buttons on the remote control).

Clip will play forwards/backwards at approximately 10 times the normal speed. Repeat the operation to play the clip forwards/backwards at approximately 20 times the normal speed.

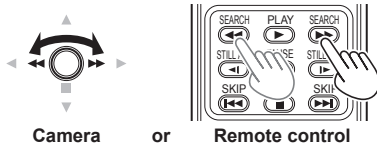

Next/previous clip

- 1 Tilt the Operation lever in the ▲ direction during playback to pause the clip (or press the PAUSE button on the remote control).
- 2 Tilt the Operation lever in the ◀◀ (rewind) or ▶▶ (fast forward) direction during playback (or press the SKIP buttons on the remote control).

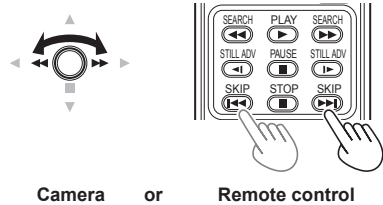

To return to normal playback, tilt the Operation lever in the ▲ direction (play) (or press the PLAY button on the remote control).

- The screen will return to the thumbnail display after the playback of the last clip is completed during fast forward playback.
- The screen will pause at the first clip after the fast rewind playback of the first clip is completed.
- No audio will be played during fast forward or rewind playback.

Frame-by-frame playback

- 1 Tilt the Operation lever in the ▲ direction during playback to pause the clip (or press the PAUSE button on the remote control).
- 2 Press the AUDIO MON/ADV buttons (or press the STILL ADV buttons on the remote control).
 - Hold down to continuously advance frame by frame until the button is released.
 - Hold down the STILL ADV button on the remote control to continuously advance frame by frame. Press the PAUSE button to cancel.

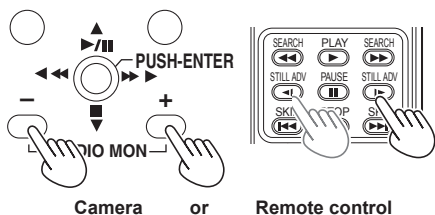

When the + button is pressed, the images are advanced in the forward direction, and when the - button is pressed, they are advanced in the reverse direction at half-second intervals.

To return to normal playback, tilt the Operation lever in the ▲ direction (play) (or press the PLAY button on the remote control).

Adjust volume

- 1 The volume of audio output from the internal speaker and headphone jack can be adjusted with the AUDIO MON/ADV buttons during playback. Press the ZOOM/VOL buttons if using the remote control.

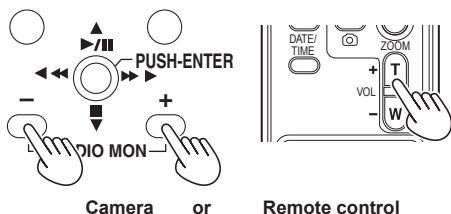

Viewing images on a television

You can view the images on a television if you connect the unit to a television set using an AV cable (not included) or HDMI cable (not included).

- 1 Connect the camera-recorder to the TV set. (Page 42)
- 2 Start playback.
 - To show the information that appears on the viewfinder and LCD on a television, press the EXT. DISPLAY button on the remote control. Press the EXT. DISPLAY button again to clear the display.

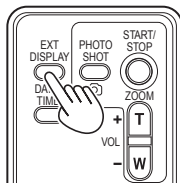

Checking the date and time

Press the DATE/TIME button on the remote control to show the date and time of shooting on the viewfinder and the LCD monitor. The display changes as follows each time you press the button.

Time
↓
Date
↓
Time and Date
↓
No display

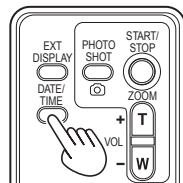

Connecting external units

Headphones

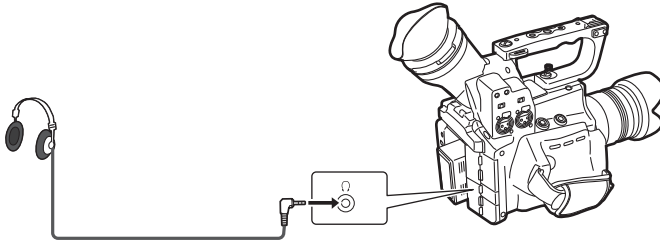

3.5-mm stereo mini jack

- Sound is no longer heard from the speaker when the headphones (optional) are connected.

External microphone

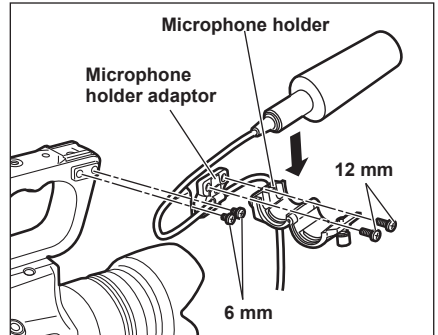
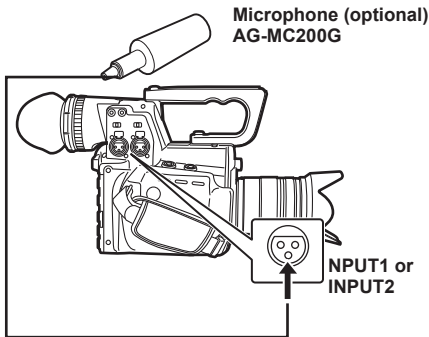

- When attaching an external microphone to the microphone shoe, use the supplied microphone holder and microphone holder adaptor.
- When attaching the microphone holder and the microphone holder adaptor, be sure to tighten the screws firmly even though you might hear a squeaking sound.
- The microphone holder mounting position is provided at two locations, namely in the handle and on top of the INPUT 1 and INPUT 2 terminals. If the microphone holder is mounted on the handle, the microphone may be captured if a wide-angle lens is used. Select the mounting location after checking the images.
- When wiring the microphone cable, use either the cable clammer of the microphone holder adaptor, or the included cable clammer.

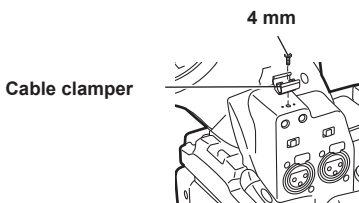

Connecting external units (continued)

Computer (non-linear editing/file transfer)

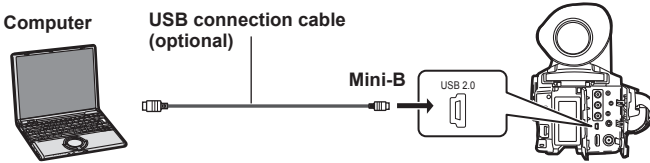

- For details on the computer's conditions and other factors, see page 44.
- Use a double-shielded USB connection cable with a maximum length of three meters.

TV/Monitor

Only the output signals from the camera are shown.

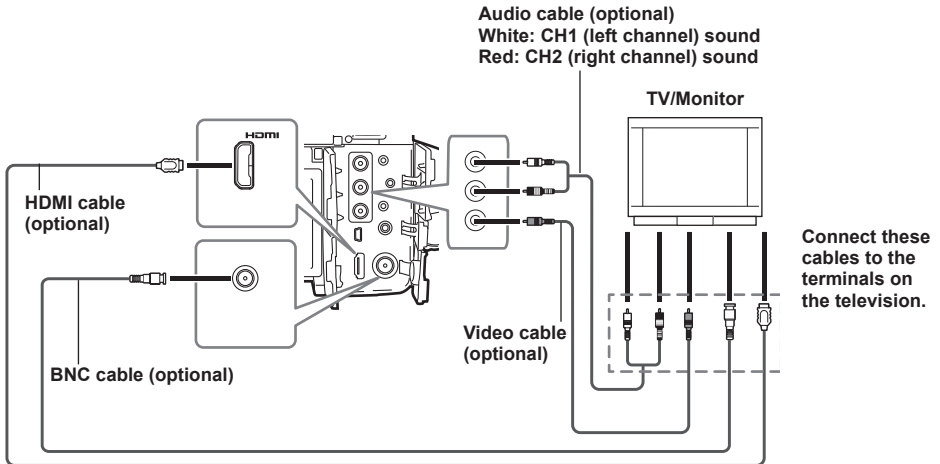

■ **When outputting video and audio signals from the camera to an external device, connect to the input terminals of the external device.**

- Use a double-shielded HDMI cable (not included).
- It is recommended that you use Panasonic's HDMI cable.
- This product is not compatible with VIERA Link.

■ **Limitations of image output**

- When using SDIOUT output, side LCD and EVF cannot be operated simultaneously. In order to perform simultaneous operation, set the SDI OUT on the settings menu AV IN/OUT SETUP to OFF. When the EVF MODE on the settings menu DISPLAY SETUP is set to AUTO, EVF disappears upon opening/closing of the LCD.
- No HDMI output is performed when REC FORMAT is set to 1080/24p and SDI 24Ps is set to ON.
- When SDI&HDMI OUT SEL is set to DOWNCONV, SIDE CROP is disabled in the DOWNCON MODE settings, and SQUEEZE is enabled automatically.
- Some displays, such as time code display and audio level meter display may not be visible on the videos output from the VIDEO OUT terminal.

Nonlinear editing

Non-linear editing of video data on SD Memory Cards can be performed by connecting the camera via the USB connection cable to a computer for editing. (As for connection, refer to page 42) Use a sufficiently charged battery or the AC adaptor.

The following conditions are necessary for USB connection.

- PC with Windows XP, Windows Vista, or Windows 7; or Macintosh with Intel CPU (Intel Mac)
- USB 2.0 (High Speed, Mass Storage Class) compatibility (not compatible with USB 1.1)
- Only connect to one computer at a time.
- Camera cannot be operated if a hub or other device is connected between the camera and computer.

1 Insert the SD Memory Card, and move the POWER switch to ON.

2 Connect the camera to the computer with the USB connection cable.

Turn the computer's power on before connecting.

3 Select 'PC'

Dubbing can be performed to a Blu-ray Disc Recorder, etc. by selecting 'RECORDER'.

4 Perform non-linear editing on the computer.

The contents of the SD Memory Card will appear as a removable disk icon within My Computer or the desktop on the computer screen. (Page 73)
(Example) Windows



Removable disk (E:)

(Example) Macintosh



NO NAME

- When copying files from the camera to a computer, be careful to ensure that files are not accidentally overwritten.
- For more details, please refer to your computer editing software's operating instructions.
- When changing cards, always ensure that the access lamp is not flashing and that the card is not currently being accessed.
- Camera functions cannot be used when the camera is connected to a computer.
- Always perform "safe hardware removal" when disconnecting the cable.
- The data on the SD Memory Card cannot be accessed when the SD Memory Card slot cover is open.

5 Turn the camera's power off.

- If the camera cannot be correctly recognized by the computer, this may be able to be remedied by one of the following methods.
 - Turn the power of the camera and the computer off and back on again.
 - Remove the SD Memory Card from the camera and reinsert it.
 - Connect to a different USB terminal on the computer.
 - If you are using an SDXC memory card, some personal computers may not recognize the data. Make sure your personal computer supports SDXC cards.
-

Screen displays

Regular displays

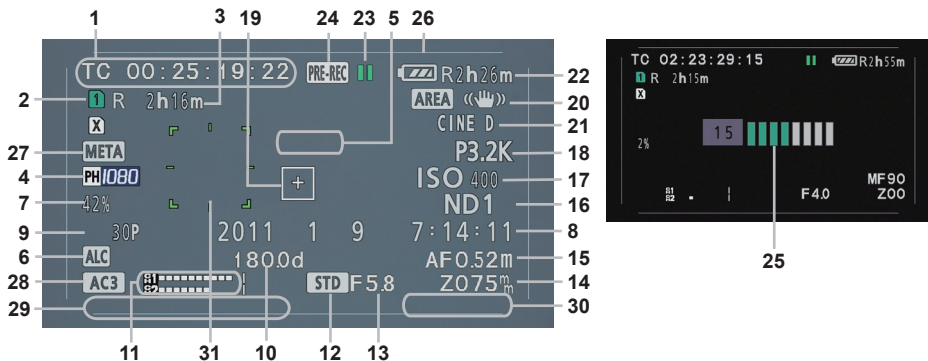

1 Time code display

Each time you press the COUNTER button, the display switches over to the following data (or no indication).

COUNTER:

Counter value

Displayed when TOTAL is selected from the REC COUNTER item in the DISPLAY SETUP screen of MENU settings.

CLIP:

CLIP counter value for respective clip

Displayed when REC COUNTER item on settings menu DISPLAY SETUP screen is set to CLIP.

- During playback, the time code display is automatically set to CLIP, and the time code is counted from a value of 0:00:00 for each clip.

TC:

Time code value.

When the time code value could not be read correctly from the SD Memory Card, [TC*] is displayed.

UB:

User information

When user information could not be read correctly from the SD Memory Card, [UB*] is displayed.

2 Media information display

Displays basic information about inserted SD memory cards. Information regarding slot 1 is displayed above, and information regarding slot 2 is displayed below.

: Recording possible (White)

- Displayed in green if used for recording.

: Card is write-protected

: Recording not possible

: Card is full

- Recording may be possible in some cases even when this icon is displayed.

- Depending on the memory size and type of the SD Memory Card used, the icon may not be displayed even when the card's memory becomes full during shooting, and the shooting is stopped.

: Playback-only

SD Memory Cards already containing 1,000 or more clips may be used for playback only.

: Accessing card

: No card inserted

- Flashes red.

3 Media capacity display

Displays remaining capacity for recording frame rate set in the REC FORMAT item on the settings menu SCENE FILE screen.

Not displayed during PB mode.

- Time displayed is a guideline only.
- The remaining capacity of the slot 2 is also displayed here.

4 Recording format display (Page 51)

5 Information display

Following information is displayed depending on the situation.

- Performance of the auto white balance or the auto black balance
- Warning (Page 48)
- The ND filter recommended under the prevailing shooting conditions is displayed.

Screen displays (continued)

- The AWB error message (LOW LIGHT / LEVEL OVER) is displayed. (Page 42 of Vol.1)
- The functions allocated to the USER buttons are displayed while you hold down the DISP/MODE CHK button.

6 Microphone level automatic control display

Appears when in the setup menus, RECORDING SETUP screen, MIC ALC, you have selected "ON".

7 Marker luminance display

When markers are displayed, the brightness level around the center of the screen is indicated as 0% to 99%. "99%↑" appears if the percentage is over 99.

- When the AREA Y-GET function is operating, the brightness level around the center of the AREA frame is displayed.

8 Date and time display

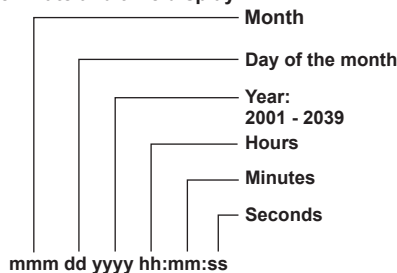

9 Frame rate display

Displays recording frame rate.
Not displayed when set to 1080/60i.

10 Shutter speed display

The shutter speed is displayed here.

11 Audio level meter display (Page 18)

12 Auto iris control display

STD: Standard auto-iris control
SPOT: Auto iris control for spotlight
BACK: Auto iris control for backlight compensation

13 Iris display

Displays F value. The STEP of the display value differs depending on the lens.

14 Zoom position display

The zoom position is displayed with Z00 (maximum wide-angle) - Z99 (maximum zoom).
The unit can be switched to mm in the ZOOM & FOCUS item of the setting menu DISPLAY SETUP screen.
The focus position display does not move linearly.

15 Focus control information display

Displays the focus control information with 99 - 00.
In the auto focus mode, AF appears. In the manual focus mode, MF appears.
The units can be switched between feet and m in the ZOOM & FOCUS item of the setting menu DISPLAY SETUP screen.
The focus position display does not move linearly.

16 ND filter display

ND filter selected is displayed.

17 Gain display

Displays the gain value of the image amplifier configured. (During the auto mode, AGC is displayed.)

18 AWB information display

Displays the information of white balance.
ATW: When ATW is set
P3.2K/P5.6K/VAR: In the case of preset
Ach/Bch: In the case of A/B
LOCK: When ATW is locked

19 Marker display

During shooting, pressing the ZEBRA button once or twice will display the marker.

20 Optical Image Stabilizer (OIS) display

Displayed when Optical Image Stabilizer is ON.

21 Scene filename display (Page 19)

22 Remaining battery capacity display

When using Panasonic-manufactured batteries compatible with this product, the remaining battery capacity is displayed in minutes.
Time remaining will be displayed after a brief pause.

- The battery display will change



as battery capacity decreases. The battery indicator will be displayed in red when less than 3 minutes are remaining, and the battery indicator will flash when the battery is empty.

(Continued on the next page)

- Remaining battery capacity may not be displayed correctly when using in high or low temperatures, or when the battery has not been used for a long period of time. To ensure that remaining battery capacity is displayed correctly, use the battery completely from a fully-charged state, and charge the battery again. (Remaining battery capacity may still not be displayed correctly if the battery has been used for long periods in high or low temperatures, or if the battery has been recharged a large number of times.)
- The remaining battery capacity display is a guideline and may change according to usage conditions.
- The remaining battery capacity display will momentarily disappear when switching between modes, when conducting REC CHECK operations or when changing the LCD brightness since the capacity is recalculated at these times.
- Not displayed when using AC adaptor.

23 Operation status display

- (Red) : Recording
- (Green): Playback paused
- ▷ : Playback
- (White): Playback paused
- INDEX [□□]: Playback paused at INDEX position
- ▷ (◁□□): Frame-by-frame playback (Frame-by-frame reverse playback)
- ▷▷ (◁◁): Skip (reverse skip)
- ▷▷ (◁◁): Fast forward/fast playback (Rewind/fast reverse playback)
- ▷ (◁): Paused in final scene (paused in initial scene)

Self-portrait recording display

- No display: Cannot record (no card, etc.)
- : Recording in progress, during transition to the recording pause mode
- : Recording paused (recording standby)
- ! : Warning display

24 Recording function display

- PRE-REC :When pre-rec mode is ON
- ◀▶ :In interval REC mode

25 Monitor audio level meter

When you press the AUDIO MON/ADV button, the sound volume output from the built-in speaker and headphone jack is displayed.

26 Safety zone

The range of the zone is indicated by the SAFETY ZONE item (Page 59) on the DISPLAY SETUP screen.

- 90%: Range that can be displayed on an ordinary home-use TV set.
- 4:3: Range cropped to 4:3
- 14:9: Range in between 16:9 and 4:3
- 2.35:1: Cinema scope range
- 2:1 : 2:1: Scope range
- 1.85:1: American visa range
- GRID: Horizontal/vertical grid lines

27 Metadata recording information

- META: When metadata recording is ON
- No display: When metadata recording is OFF

28 Recording audio type display

- LPCM: When audio LPCM recording
- AC3 : When audio AC3 recording

29 FOCUS_BAR display

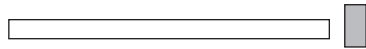

Displays the above items in the bottom left of the LCD/EVF. Digitizes and displays high-frequency component volumes for videos.

White bar: focus bar display
Green line: peak display

30 IRIS METER display



Displays the above items in the bottom right of the LCD/EVF.

- Center: Indicates the normal light intensity.
- Right: Indicates high-light intensity.
- Left: Indicates low-light intensity.
- Green dots on display: Indicate the compensation amount during AUTO IRIS.

31 AREA frame display

Displays the range of the AREA function.

Main warning displays

The main warning displays appearing on the LCD monitor or viewfinder are listed below. If a warning display is not listed, check carefully the message displayed.

■ C

CANNOT BE USED DUE TO INCOMPATIBLE DATA.

No use is possible because the standard for the data is different.

CANNOT DELETE.

Clip cannot be deleted.

CANNOT DELETE WITH THIS BUTTON

Clip cannot be deleted.

CANNOT PLAY.

No playback is possible.

CANNOT PLAY WITH THIS BUTTON

No playback is possible.

CANNOT RECORD PH MODE AND HA MODE INTO THIS CARD.

This card cannot be recorded to in PH mode or HA mode.

CANNOT RECORD. THE NUMBER OF CLIPS HAS EXCEEDED THE MAXIMUM LIMIT.

The maximum number of clips has been reached and no further clips can be recorded.

CANNOT SET THE NUMBER OF INDEXES HAS EXCEEDED THE MAXIMUM LIMIT.

No further indexes can be set because the number of indexes will exceed the maximum limit.

CANNOT SET PRE-REC, CARD CAPACITY TOO LOW.

PRE-REC cannot be set as the remaining card capacity is low.

CARD DOOR OPENED.

The card door is open.

CARD ERROR. PLEASE REFORMAT.

Formatting has failed. The card needs to be reformatted.

CARD FULL.

The card is full.

CHECK CARD.

Please check the card.

If an SD memory card that has been used before in another device or personal computer is used for the first time in this camera-recorder, CHECK CARD is displayed, and all operations may be disabled. In such a case, perform the following:

- ① Remove the SD memory card from the unit and insert it again. (Page 38 of Vol.1)
The unit recognizes the SD memory card and cancels the CHECK CARD display.
- ② If the CHECK CARD display is not canceled even after removing and inserting the SD memory card several times, check the contents of the card on a personal computer, and erase the entire data.
- ③ Format the SD memory card in the unit. (Page 36 of Vol.1)

If the data on the card cannot be either read or erased on a personal computer, the SD memory card may be corrupted. Use another SD memory card.

CHECK USB CABLE.

Please connect the camera-recorder to a PC.

CONTROL DATA ERROR HAS BEEN DETECTED.

An error has been detected in the control information.

■ D

DISCONNECT USB CABLE.

When switching from one mode to another, disconnect the USB connection cable.

■ I

INCOMPATIBLE CARD. PLEASE CHECK CARD.

This card may have been formatted in a format with different system frequency. Check the card.

(Continued on the next page)

■ N

NO CARD

No card is inserted.

NOW ACCESSING.**PLEASE DO NOT REMOVE CARD.**

Card is currently being accessed. Please do not remove the card.

■ R

REC STOPPED.**NOW WRITING.**

Video recording has been stopped. Data is now being written to the card.

REPAIR CLIP?

Do you wish to repair clips now?

■ S

SD CARD FORMAT?**YES NO**

Do you wish to format the SD Memory Card now? Yes/No

SET DATE AND TIME

Set the date and time.

■ T

THE CLIP IS PROTECTED.**PLEASE CANCEL PROTECTION.**

The clip is protected. Please cancel the protection.

**THE RECORDING IS STOPPED
(OVER THE LIMITATION)**

Recording will stop. (Continuous recording for 12 hours)

THE TC MODE IS CHANGED TO "NDF"

NDF is selected as the TC MODE setting.

THIS BATTERY CANNOT BE USED.

This battery cannot be used.

**THIS CARD CANNOT RECORD IN VIDEO
MODE.**

The card cannot be used for video recording.

THUMBNAIL DATA ERROR IS DETECTED.

An error has been detected in the thumbnail information.

■ U

UNABLE TO FORMAT.

The card cannot be formatted.

■ W

WRITE PROTECT

The card is write-protected.

Error displays

The following messages are displayed when an error has occurred in the camera or the SD Memory Card. If the problem is not solved by switching the power off and back on again, either change the card in accordance with the instructions displayed, or consult the place of purchase.

■ C

CANNOT RECORD

Displayed when an error has occurred during recording.

■ R

REC WARNING

Displayed when an error has occurred during recording. Start the recording again. If the message appears again, please consult the place of purchase.

- Please switch the power off if the message continues to appear.
 - Please try inserting a different card if the message appears again after restarting recording.
-

■ S

SYSTEM ERROR**TURN POWER OFF**

Displayed when an error has occurred in the system. Switch the power off and back on again.

- If this error is displayed when accessing the SD Memory Card, such as when deleting a clip, the SD Memory Card may be damaged. Please replace it with a new SD Memory Card.
 - If this error is displayed when repairing the SD Memory Card, please use the AVCCAM Restorer content repair software (Page 38 of Vol.1).
-

■ W

WARNING

Displayed when an error has occurred with the camera itself. Start the recording again.

FOCUS NG (error with focus operation)
PSD NG (error with jitter detection)

Screen displays (continued)

Setting the DISPLAY items

Display the following items on the viewfinder and LCD monitor by pressing the DISP/MODE CHK button or by configuring OTHER DISPLAY of the DISPLAY SETUP screen of the setup menus. (Page 60)

Displays	MODE CHK (Hold down DISP/ MODE CHK button)	DISPLAY	OTHER DISPLAY settings		
			ALL	PARTIAL	OFF
1 Time code display	✓	—	—	—	—
2 Media information display	✓	✓	—	—	—
3 Media capacity display	✓	✓	—	—	—
4 Recording format display	✓	✓	✓	x	x
5 Information display	—	—	—	—	—
6 Microphone level automatic control display	✓	✓	✓	x	x
7 Date and time display	✓	✓*4	—	—	—
8 Frame rate display	✓	✓	✓*1	x	x
9 Shutter speed display	✓	✓	✓	✓	x
10 Audio level meter display	✓	✓	—	—	—
11 Auto iris control display	✓	✓	✓	✓	x
12 Iris display	✓	✓	✓	✓	x
13 Zoom position display	✓	✓	—	—	—
14 Focus control information display	✓	✓	—	—	—
15 ND filter display	✓	✓	✓	x	x
16 Gain display	✓	✓	✓	✓*2	x
17 AWB information display	✓	✓	✓	✓*3	x
18 Marker display	—	—	—	—	—
19 Optical Image Stabilizer display	✓	✓	✓	✓	x
20 Scene filename display	✓	✓	✓	x	x
21 Remaining battery capacity display	✓	✓	—	—	—
22 Monitor audio level display	—	—	—	—	—

✓: Displayed

x: Not displayed

—: Displayed depending on other settings

The item in ✓ in the MODE CHECK space appears when you press and hold the DISP/MODE CHK button.

The item in ✓ in the DISPLAY space disappears when you press the DISP/MODE CHK button.

*1 Not displayed when frame rate is set to 60i/50i.

*2 0 dB is not displayed.

*3 Only preset 3.2K, 5.6K and VAR are displayed.

*4 If the date and time display appear simultaneously, they may not be removed even by pressing the DISP/MODE CHK button.

Setup menu list

SCENE FILE screen

Item	Display mode	Description of settings
SCENE SELECT	(Camera)	Selects the settings (SCENE FILES) according to the variety of shooting circumstances. You can read, save, and initialize these settings from MENU - SCENE FILE - LOAD / SAVE / INIT. F1, F2, F3, F4, F5, F6
OPERATION TYPE	(Camera)	Switches the shutter and frame rate operation to video type or film type. FILM CAM: VFR operation is enabled. SLOW shutter speeds are disabled. SYNCROSCAN is displayed as an angle. Gain is displayed as ISO. VIDEO CAM: VFR operation is disabled. SLOW shutter speeds are enabled. SYNCROSCAN is displayed as 1/n. Gain is displayed as dB.
REC FORMAT	(Camera)	Selects the recording format. When SYSTEM FREQ = 59.94 Hz PH 1080/24P and PH 720/24P represent native recording. PH 1080/60i, PH 1080/30P, PH 1080/24P, PH 720/60P, PH 720/30P, PH 720/24P, HA 1080/60i, HE 1080/60i When SYSTEM FREQ = 50 Hz PH 1080/50i, PH 1080/25P, PH 720/50P, PH 720/25P, HA 1080/50i, HE 1080/50i
VFR MODE	(Camera)	ON: Enables the VFR (Variable Frame Rate) mode. OFF: Disables the VFR mode. Functions only when REC FORMAT is set to 1080/24P, 1080/30P, or 1080/25P. Functions only when OPERATION TYPE = FILM CAM Does not function when SDI 24PsF is set to ON. Audio cannot be recorded when VFR MODE = ON.
FRAME RATE	(Camera)	Sets the FRAME RATE. Operates only when OPERATION TYPE = FILM CAM. You can make the settings from SHUTR/F.RATE on the rear side of the camera also. When SYSTEM FREQ = 59.94 Hz 12/15/18/20/21/22/24/25/26/27/28/30/32/34/36/40/44/48/54/60 When SYSTEM FREQ = 50 Hz 12/15/18/20/21/22/23/24/25/26/27/28/30/32/34/37/42/45/48/50
SYNCRO SCAN	(Camera)	Adjusts the synchro scan shutter speed used for shooting images on a TV screen, etc. Holding the OPERATION lever toward the ◀ or ▶ will cause the values to change at a faster rate. When OPERATION TYPE = VIDEO CAM and SYSTEM FREQ = 59.94 Hz • 60P/60i: 1/60.0...1/250.6 • 30P: 1/30.0...1/48.0...1/250.6 • 24P: 1/24.0...1/48.0...1/250.6 When OPERATION TYPE = VIDEO CAM and SYSTEM FREQ = 59.94 Hz • 50P/50i: 1/50.0...1/250.0 • 25P: 1/25.0...1/48.0...1/250.0 When OPERATION TYPE = FILM CAM, "deg (angle)" Display 10.0d...172.8d...180.0d...360.0d (0.5d/div)

___ indicates the factory setting.

Setup menu list (continued)

SCENE FILE screen (continued)

Item	Display mode	Description of settings
DETAIL LEVEL	(Camera)	Adjusts the level of the image outline correction (in the horizontal and vertical directions). -7...0...+7
V DETAIL LEVEL	(Camera)	Adjusts the level of outline correction in the vertical direction. -7...0...+7
DETAIL CORING	(Camera)	Adjusts the level of noise reduction of the detail signal. Set to – for a clearer image. Noise increases slightly. Set to + to reduce noise. -7...0...+7
CHROMA LEVEL	(Camera)	Adjusts the chroma level. -7...0...+7
CHROMA PHASE	(Camera)	Adjusts the chroma level. -7...0...+7
COLOR TEMP Ach	(Camera)	Make fine adjustments to the color temperature (after white balance Ach adjustment). -7...0...+7
COLOR TEMP Bch	(Camera)	Make fine adjustments to the color temperature (after white balance Bch adjustment). -7...0...+7
MASTER PED	(Camera)	Adjusts the master pedestal (black level of the image) as the basis for images. -15...0...+15
A.IRIS LEVEL	(Camera)	Sets the desired AUTO IRIS level. -6...0...+6
DRS	(Camera)	Selects the DRS (Dynamic Range Stretcher) function. It enables the dynamic range to be expanded by compressing the level of the video signals in the high-brightness areas where overexposure results during normal shooting. OFF, 1, 2, 3 <ul style="list-style-type: none"> • The higher the number of the setting, the higher the compression level of the high-brightness areas. • The higher the number of the setting, the greater the interference in darker areas.
GAMMA	(Camera)	Selects the gamma curves. HD NORM: This gamma setting is suitable for HD shooting. LOW: Makes a mellow image using the gamma curve that has a gentle incline in low-brightness curve. The contrast sharpens. SD NORM: This is the normal video setting carried over from the DVX100 series. HIGH: Expands the tone of dark parts and makes a brighter image using the gamma curve that has a sharp incline in low-brightness curve. The contrast softens. B.PRESS: Makes the contrast sharper than LOW. CINE-LIKE D: Uses a gamma curve designed to create cinema-like images. CINE-LIKE V: Uses a gamma curve designed to create cinema-like images with emphasized contrast. <ul style="list-style-type: none"> • When you select CINE-LIKE gamma, we recommend setting the lens aperture lower than normal image level (approximately 1/2) for optimal results.
KNEE	(Camera)	To avoid overexposure, select the compression level (knee point) of the high intensity video signals received through the image pickup device. AUTO: Sets the level automatically according to the received signals. LOW: Low setting (Compression starts at approx. 80%) MID: Medium setting (Compression starts at approx. 90%) HIGH: High setting (Compression starts at approx. 100%) <ul style="list-style-type: none"> • Not available when a DRS value is set, or when GAMMA is set to CINE-LIKE.

_____ indicates the factory setting.

SCENE FILE screen (continued)

Item	Display mode	Description of settings
MATRIX	(Camera)	Selects the MATRIX table suitable for the desired color expression during shooting. NORM1: Suitable for shooting in the open air or under a halogen lamp. NORM2: Suitable for brighter colors than the NORM1 mode. FLUO: Suitable for shooting under fluorescent lights indoors. CINE-LIKE: Suitable for cinema-like images.
SKIN TONE DTL	(Camera)	Switches skin tone details ON or OFF. Select ON to reduce the skin tone details and soften the skin tone. ON, OFF
B/W MODE	(Camera)	Selects the black and white shooting function. All recorded and output video signals are converted to black and white. Color temperature adjustment modes, such as AWB, operate even when the B/W MODE is ON and affect the black and white images. It is recommended that you set the B/W MODE to ON after adjusting and checking the white balance when the B/W MODE is OFF. ON, OFF
CARD READ	(Camera)	Reads scene files from the SD Memory Card. Slot1: Reads scene files (all scenes from F1 to F6) saved on the SD Memory Card of Slot 1 after selecting the setting values. Slot2: Reads scene files (all scenes from F1 to F6) saved on the SD Memory Card of Slot 2 after selecting the setting values. NO: Returns to the previous screen.
CARD WRITE	(Camera)	Saves scene files on the SD Memory Card. Slot1: Saves the setting values of scene files (all scenes from F1 to F6) on the SD Memory Card of Slot 1. Slot2: Saves the setting values of scene files (all scenes from F1 to F6) on the SD Memory Card of Slot 2. NO: Returns to the previous screen.
LOAD/SAVE/INIT	(Camera)	LOAD: Loads the scene file settings saved by this camera. SAVE: Saves the updated scene file settings. INITIALIZE: Returns the settings of the scene file selected from the SCENE FILE item to factory settings. NO: Returns to the previous screen.
NAME EDIT	(Camera)	Edits the name of the scene file selected from the MENU/SCENE FILE/SCENE SELECT. YES, NO

___ indicates the factory setting.

SW MODE screen

Item	Display mode	Description of settings
FUNCTION KNOB	(Camera)	Sets the function assigned to the AREA operation of the FUNCTION KNOB. INH: No function is assigned. FOCUS: AUTO FOCUS / FOCUS BAR function IRIS: AUTO IRIS / IRIS METER function YGET: YGET (Luminance measurement) function FOCUS/IRIS: Simultaneous operation of FOCUS and IRIS described above FOCUS/YGET: Simultaneous operation of FOCUS and YGET described above

___ indicates the factory setting.

Setup menu list (continued)

SW MODE screen (continued)

Item	Display mode	Description of settings
LOW GAIN	(Camera)	Sets the gain value assigned to the L position of the GAIN switch. When OPERATION TYPE = FILM CAM ISO200, ISO250, ISO320, <u>ISO400</u>, ISO500, ISO640, ISO800, ISO1000, ISO1250, ISO1600, ISO2000, ISO2500, ISO3200 When OPERATION TYPE = VIDEO CAM -6dB, -3dB, <u>0dB</u>, 3dB, 6dB, 9dB, 12dB, 15dB, 18dB
MID GAIN	(Camera)	Sets the gain value assigned to the M position of the GAIN switch. When OPERATION TYPE = FILM CAM ISO200, ISO250, ISO320, ISO400, ISO500, ISO640, <u>ISO800</u>, ISO1000, ISO1250, ISO1600, ISO2000, ISO2500, ISO3200 When OPERATION TYPE = VIDEO CAM -6dB, -3dB, 0dB, 3dB, <u>6dB</u>, 9dB, 12dB, 15dB, 18dB
HIGH GAIN	(Camera)	Sets the gain value assigned to the H position of the GAIN switch. When OPERATION TYPE = FILM CAM ISO200, ISO250, ISO320, ISO400, ISO500, ISO640, ISO800, ISO1000, ISO1250, <u>ISO1600</u>, ISO2000, ISO2500, ISO3200 When OPERATION TYPE = VIDEO CAM -6dB, -3dB, 0dB, 3dB, 6dB, 9dB, <u>12dB</u>, 15dB, 18dB
ATW	(Camera)	Sets the operation of the ATW (Auto Tracking White) function assigned to the WHITE BAL switch. When the ATW function is allocated to the USER button, the operation remains effective. Ach: Activates the ATW function when the WHITE BAL switch is set to A. Bch: Activates the ATW function when the WHITE BAL switch is set to B. PRST: Activates the ATW function when the WHITE BAL switch is set to PRST. OFF: Deactivates the ATW function.
IRIS DIAL	(Camera) (PB)	Sets the rotation direction and aperture control of the IRIS dial. (In MANUAL IRIS mode) DOWN OPEN: The aperture opens when the IRIS dial is turned downward. UP OPEN: The aperture opens when the IRIS dial is turned upward.

_____ indicates the factory setting.

SW MODE screen (continued)

Item	Display mode	Description of settings
USER1 SW	(Camera) (PB)	<p>Sets the function assigned to the USER1 button.</p> <p>INH: No function is assigned</p> <p>REC CHECK: Performs recording check.</p> <p>FACE DETECT: This is the face detection function. Performs the AUTO IRIS / AUTO FOCUS operation centering around the detected face. Enabled when both focus control and iris control are set to auto.</p> <p>FA: Displays the edges in red. (Only for LCD/EVF) During operation, the LCD/EVF borders are displayed in red.</p> <p>CAPTURE: Records still images. Does not operate during movie recording and when the PRE REC function is in use.</p> <p>ATW: Switches the ATW function ON or OFF.</p> <p>ATW LOCK: Fixes the white balance value when the button is pressed during ATW. Press again to perform ATW.</p> <p>SHOT MARK: Shot mark recording. (Page 13) Takes effect during recording, thumbnail display, and clip display.</p> <p>INDEX: Index recording (Page 13) Takes effect during recording.</p> <p>LAST CLIP: Deletes the last recorded clip. (Page 13)</p> <ul style="list-style-type: none"> • After recording, clips cannot be deleted by switching to PB or PC mode, by changing the recording format, or by turning off the camera. <p>BACKLIGHT: Auto iris control for the backlight compensation.</p> <p>SPOTLIGHT: Switches auto iris control ON or OFF for the spotlight.</p> <p>BLACKFADE: Blackfade (Page 11)</p> <p>WHITEFADE: Whitefade (Page 11)</p>
USER2 SW	(Camera) (PB)	<p>Assign a function to the USER2 button.</p> <p>The setting contents are the same as USER1.</p> <p>ATW LOCK</p>
USER3 SW	(Camera) (PB)	<p>Assign a function to the USER3 button.</p> <p>The setting contents are the same as USER1.</p> <p>REC CHECK</p>
WFM	(Camera)	<p>Switches the waveform display that appears when the WFM button is pressed.</p> <p>WAVE: Displays as a waveform.</p> <p>VECTOR: Displays as a vector.</p> <p>WAVE/VECTOR: Each time the button is pressed, the setting changes in the following order: OFF → WAVE → VECTOR → OFF.</p>
S/S SW INH	(Camera)	<p>1: Disables the START/STOP1 SW.</p> <p>2: Disables the START/STOP2 SW.</p> <p>NO: Does not disable any switch. Use to prevent erroneous operation of the unnecessary START/STOP SW.</p>
FACE FRAMING	(Camera)	<p>Frames the faces detected during operation of the FACE DETECT function with the USER SW.</p> <p>The maximum number of detected frames is 15, and faces bigger and closer to the center of the screen are given priority.</p> <p>OFF: Frames are not displayed.</p> <p>PRIMARY: Only the high-priority frames are displayed.</p> <p>ALL: Cannot be set when you are using INTERVAL REC.</p>

___ indicates the factory setting.

Setup menu list (continued)

RECORDING SETUP screen

Item	Display mode	Description of settings
PREREC MODE	(Camera)	Sets PRE RECORDING to ON or OFF. ON: Enables PRE REC function. OFF: Disables PRE REC function. <ul style="list-style-type: none"> • TCG is set to FREE RUN. • Cannot be set when you are using INTERVAL REC.
INTERVAL REC	(Camera)	Scenes moving slowly over a long period of time are recorded as short movies by providing a recording interval. One frame is recorded in each recording time period that has been set, and 24 frames (PAL 25 frames) form a one-second video. When you set INTERVAL REC, the following items are set automatically: PH Mode 1080/24P (When SYSTEM FREQ = 59.94) 1080/25P (When SYSTEM FREQ = 50) <ul style="list-style-type: none"> • TC RECRUN Fixed to NDF • Audio recording is not performed. OFF, 1SECOND, 10SECONDS, 30SECONDS, 1MINUTE, 2MINUTES
RELAY REC	(Camera)	ON: Relay recording performed. When the SD card used for recording has no remaining space, recording continues in another SD card if an SD card that can be used for recording is inserted in another SD card slot. OFF: Relay recording not performed. Recording stops when the target SD card has no remaining space.
PH AUDIO MODE	(Camera)	Selects the format of audio recording when REC FORMAT = PH. LPCM: Recording is performed in uncompressed LPCM. AC3: Recording is performed in Dolby AC3 format. <ul style="list-style-type: none"> • Fixed to AC3 for other than the PH mode. • If LPCM is set, playback is not possible in our previous models, such as AG-HMR10.
MIC ALC	(Camera)	ON: Enables mic level auto control. OFF: Disables mic level auto control. Audio distortion can be reduced at high input levels. To adjust the recording level of audio signals (regardless of this setting), use the AUDIO control knobs.
MIC GAIN1	(Camera)	Sets the input level of the external microphone connected to the INPUT 1 terminal. -50dB, -60dB
MIC GAIN2	(Camera)	Sets the input level of the external microphone connected to the INPUT 2 terminal. -50dB, -60dB

___ indicates the factory setting.

TC/UB SETUP screen

Item	Display mode	Description of settings
TC MODE	(Camera)	<p>Selects the correction mode of the internal time code when the time code of the internal time code generator is recorded.</p> <p>DF: Uses the drop frame mode.</p> <p>NDF: Uses the non-drop frame mode.</p> <ul style="list-style-type: none"> TC MODE is automatically set to NDF when you set recording frame rate of recording format to 24P. Takes effect only when SYSTEM FREQ = 59.94 Hz. PH 1080/24P and PH 720/24P represent native recording.
TCG	(Camera)	<p>Sets the mode in which you advance the internal time code generator.</p> <p>FREE RUN: The time code is advanced regardless of the operation mode. A slight time error may occur when switching to PB mode if the frame rate is set to 24P.</p> <p>REC RUN: The time code is advanced only when recording.</p>
TC PRESET	(Camera)	<p>Sets the initial time code.</p> <p>Set the frame value to 0 or a multiple of 4 when you set recording frame rate of recording format to 24P. If any other value is set, the recorded time code will mismatch.</p> <p>YES, NO</p>
UB PRESET	(Camera)	<p>Sets the user information.</p> <p>YES, NO</p>
EXT TC LINK	(Camera)	<p>Synchronizes the initial time code value during multi-camera shooting. (SLAVE camera time codes are synchronized to the master internal TCG value.</p> <p>MASTER: Sets the mode to master mode.</p> <p>SLAVE: Sets the mode to slave mode. When the COUNTER RESET/TC SET button is pressed, input time codes are synchronized to the internal TCG.</p> <p>NO: Returns to the previous screen.</p> <ul style="list-style-type: none"> MASTER and SLAVE mode settings are in effect only when this menu is open. When the menu is closed, EXT TC LINK is automatically canceled.

___ indicates the factory setting.

Setup menu list (continued)

AV IN/OUT SETUP screen

Item	Display mode	Description of settings
SDI & HDMI OUT SEL	(Camera) (PB)	Sets the output video format of the SDI&HDMI OUT terminal. 1080i/720P: Output at the resolution set in REC FORMAT. DOWNCONV: SDI is output at 480i, while HDMI is output at 480p. (When SYSTEM FREQ = 59.94) SDI is output at 576i, while HDMI is output at 576p. (When SYSTEM FREQ = 50)
SDI OUT	(Camera) (PB)	Sets the video output from the SDI terminal. ON: Video is output from SDI OUT. At this point, simultaneous LCD display and EVF display is not supported. Close the LCD monitor when using EVF. OFF: No video is output from SDI OUT.
SDI 24PsF	(Camera) (PB)	Sets the video format output from SDI OUT to 24PsF. ON: Operates only when REC FORMAT = 1080 24p. Does not operate during VFR operation (when the recording format is other than 24p). The HDMI output stops during 24PsF output. OFF: SDI output is in the 1080 60i format. • This item is not available when SYSTEM FREQ = 50Hz.
SDI EDH	(Camera) (PB)	Sets superimposition of EDH on to the SDI output during SD SDI output. ON: Superimposes EDH. OFF: Does not superimpose EDH.
DOWNCON MODE	(Camera) (PB)	Switches down-conversion output mode. SIDE CROP: Side-crop mode (Crops the left and right edges.) Images may extend beyond the boundaries of the screen and be partially unable to be seen when outputting from the +H227A/V terminal or SDI OUT terminal (during DOWNCONV), or the HDMI terminal (during DOWNCONV). LETTER BOX: Letterbox mode (Adds black bands at the top and bottom of the image). SQUEEZE: Squeeze mode (Squeezes images horizontally).
HP MODE	(Camera)	Selects the sound heard from the headphones. LIVE: The sound input from the microphone is output as is. This setting is selected when delays in the sound are annoying. RECORDING: The sound in the status to be recorded (the sound synchronized with the images) is output.
TEST TONE	(Camera)	Sets test tone output to channels 1, 2, 3, and 4 when BARS setting is ON. ON: Outputs the test tone. OFF: Does not output the test tone.
VIDEO SETUP	(Camera) (PB)	Sets the setup level of video signals. 0%: VIDEO OUT terminal output and recording setup levels will both be set to 0%. 7.5%A: VIDEO OUT terminal output setup level will be set to 7.5%, while recording setup level will be set to 0%. • This item is not available when SYSTEM FREQ = 50Hz.
AUDIO OUT	(Camera) (PB)	Sets the audio signals to output from the AUDIO OUT terminal (A/V OUT). CH1/CH2: CH1 terminal = CH1 signals, CH2 terminal = CH2 signals CH1: CH1 terminal = CH1 signals, CH2 terminal = CH1 signals CH2: CH1 terminal = CH2 signals, CH2 terminal = CH2 signals • When an SD Memory Card containing 5.1 channel content recorded on another equipment is played back on the camera, it is down-mixed to 2 channels when output through the AUDIO OUT and headphone terminals.

_____ indicates the factory setting.

DISPLAY SETUP screen

Item	Display mode	Description of settings
ZEBRA DETECT 1	(Camera)	Selects the brightness level of the right-leaning zebra patterns on the screen. 50%, 55%, 60%, 65%, 70%, 75%, 80%, 85%, 90%, 95%, 100%, 105%
ZEBRA DETECT 2	(Camera)	Selects the brightness level of the left-leaning zebra patterns on the screen. 50%, 55%, 60%, 65%, 70%, 75%, 80%, 85%, 90%, 95%, 100%, 105%
Y GET MARKER	(Camera)	Sets the display of the marker used for displaying the luminance level to ON or OFF. Select ON to display the marker by pressing the ZEBRA button. ON, OFF
SAFETY ZONE	(Camera)	Sets the SAFETY ZONE. 90%: 90% display at 16:9 4:3: 100% display at 4:3 14:9: 100% display at 14:9 1.85:1: 100% display t 1.85:1 2:1: 100% display at 2:1 2.35:1: 2.35:1 cinemascope display GRID: 16:9 angular field of view with nine grid lines OFF: The SAFETY ZONE is not displayed.
CENTER MARKER	(Camera)	Sets the CENTER MARKER. Select ON to display the CENTER MARKER. ON, OFF
FOCUS BAR	(Camera)	Sets the FOCUS ASSIST bar display to ON or OFF. Select ON to display the FOCUS ASSIST bar. ON, OFF
REC COUNTER	(Camera)	Selects counter operation during recording. TOTAL: The count continues to increase until the COUNTER RESET button is pressed to reset it. CLIP: Resets the counter at start of recording and counts the time of each recording session. • In the PB mode, the operation is always in CLIP mode.
VIDEO OUT OSD	(Camera) (PB)	Select ON to output the information displayed on the screen together with the signals from the VIDEO OUT jack. ON, OFF • Some items are not output from the A/V terminal.
IRIS METER	(Camera)	Sets the display of the IRIS METER. ON: As regards the brightness of the image, displays the difference with respect to the optimum value judged by the camera. The bar appears on the right: The image is too bright. The bar appears on the left:: The image is too dark. OFF: The IRIS METER is not displayed.
DATE/TIME	(Camera) (PB)	Sets whether to display the date and time on the screen and whether to output from the VIDEO OUT jack. OFF: The date and time are not displayed. TIME: The time is displayed. DATE: The date is displayed. TIME & DATE: The date and time are displayed.
DATE FORMAT	(Camera) (PB)	Changes the style of displaying the year, month, and day. Y-M-D: Year/Month/Day M-D-Y: Month/Day/Year D-M-Y: Day/Month/Year

___ indicates the factory setting.

Setup menu list (continued)

DISPLAY SETUP screen (continued)

Item	Display mode	Description of settings
LEVEL METER	(Camera) (PB)	Select ON to display the audio level meter. ON, OFF
ZOOM & FOCUS	(Camera)	Selects the unit of zoom and focus values. OFF, NUMBER, mm/m, mm/feet <ul style="list-style-type: none"> Use the mm/feet or mm/m display only as a general guideline because it is not entirely accurate. When you are using a lens that has no communication connection between the camera and lens through the use of a mount adaptor, the zoom and focus values are not displayed.
CARD & BATTERY	(Camera) (PB)	Select ON to display the remaining SD Memory Card recording capacity and remaining battery charge. ON, OFF
OTHER DISPLAY	(Camera)	Select how much information to display on the viewfinder and LCD monitor. OFF, PARTIAL, ALL
LCD BACKLIGHT	(Camera) (PB)	Adjusts the backlight of the LCD monitor. +1, 0, - 1, - 2, - 3 +1: The backlight becomes brighter. - 3: The backlight becomes the darkest.
LCD SET	(Camera) (PB)	Adjusts the display level of images on the LCD monitor. BRIGHTNESS COLOR CONTRAST
EVF SET	(Camera) (PB)	Adjusts the display level of images on the viewfinder. BRIGHTNESS COLOR CONTRAST
SELF SHOOT	(Camera)	Selects the LCD mirror mode for self-portrait shooting. Selecting MIRROR displays the left and right side of the LCD monitor image inverted during self-portrait shooting. NORMAL, MIRROR
EVF MODE	(Camera) (PB)	Switches the screen display of images. AUTO: If you open the LCD monitor, images on the viewfinder disappear. ON: Images are always displayed on the viewfinder. <ul style="list-style-type: none"> When SDI OUT = ON, regardless of this item, AUTO settings are operated forcibly.
EVF COLOR	(Camera)	EVF COLOR (Camera) Switches viewfinder images to color or black and white. ON: Color OFF: Black and white

_____ indicates the factory setting.

CARD FUNCTIONS screen

Item	Display mode	Description of settings
CARD FORMAT	(Camera) (PB)	Formats the SD Memory Card. Slot1: Formats the SD Card inserted in Slot 1. Slot2: Formats the SD Card inserted in Slot 2. NO: Returns to the previous screen.
CARD STATUS	(Camera) (PB)	Displays the SD Memory Card status. Slot1: Displays the information about the SD Card inserted in Slot 1. Slot2: Displays the information about the SD Card inserted in Slot 2. NO: Returns to the previous screen.
CLIP PROPERTY	(PB)	Displays information about the selected clip. YES: Displays clip information. NO: Returns to the previous screen.

USER FILE screen

Item	Display mode	Description of settings
CARD READ	(Camera) (PB)	Reads the user files saved on the SD Memory Card. Slot1: Reads the user files from the SD Card inserted in Slot 1. Slot2: Reads the user files from the SD Card inserted in Slot 2. NO: Returns to the previous screen.
CARD WRITE	(Camera) (PB)	Saves the user files on the SD Memory Card. You can also add a title to the saved files. Slot1: Saves the user files on the SD Card inserted in Slot 1. Slot2: Saves the user files on the SD Card inserted in Slot 2. NO: Returns to the previous screen.
LOAD/SAVE/INIT	(Camera) (PB)	LOAD: Loads the settings in a previously stored user file. SAVE: Saves the updated user file settings. INIT: Returns the settings in the user file to factory settings. NO: Returns to the previous screen. <ul style="list-style-type: none"> • After a LOAD or INITIALIZE operation, turn OFF the POWER switch of the camera and then turn it ON again to make the new settings available. • The INITIALIZE operation does not change the TIME ZONE settings (Page 63).

___ indicates the factory setting.

Setup menu list (continued)

META DATA screen

Item	Display mode	Description of settings
CARD READ	(Camera)	Loads the metadata recorded on the SD Memory Card on to the unit. SLOT1, SLOT2, NO • "NO FILE" is displayed when no metadata is recorded on the SD Memory Card.
RECORD	(Camera)	Sets whether to record the metadata to be loaded on the unit simultaneously on a SD Memory Card. ON: Records simultaneously OFF: Does not record simultaneously
USER CLIP NAME	(Camera)	Selects the method of recording the USER CLIP NAME. TYPE1: The user clip name is the same as the CLIP NAME if no uploaded metadata or data exists. TYPE2: The user clip name is the same as the CLIP NAME if no combination of data and COUNT value is uploaded, or if no uploaded data exists.
META DATA PROP	(Camera)	Displays the metadata recorded in the unit. YES, NO
CLIP COUNTER RST	(Camera)	Resets the COUNT value to 1. YES, NO
META INT SET	(Camera)	Initializes the metadata recorded in the unit. All settings, including the ON or OFF setting for RECORD are now cleared. YES, NO

OTHER FUNCTIONS screen

Item	Display mode	Description of settings
LENS CHECK	(Camera)	ON: Checks the communication status with the lens. Video shooting is not performed if checking is not proper. OFF: Does not check the communication status with the lens. • It is recommended to set LENS CHECK to ON when you are using lenses conforming to the Micro Four Thirds and Four Thirds standard. • When you are using a lens that has no communication connection between the camera and lens through the use of a mount adaptor, video shooting is enabled when you set this item to OFF.
IR REMOTE	(Camera) (PB)	Sets the operations of the supplied remote control unit. ON: Accepts commands from the remote control. • Note that if the same type of remote control is used near the unit, the unit may receive commands from the other remote control, during shooting for example, and suddenly operate in an unexpected manner. OFF: Does not accept commands from the remote control.
TALLY LAMP	(Camera)	Sets lighting of the tally lamp. FRONT: The front tally lamp (microphone side) lights. REAR: The rear tally lamp (viewfinder side) lights. BOTH: Both tally lamps light. OFF: No tally lamp lights.
CLOCK SET	(Camera) (PB)	Sets the built-in calendar of the camera.

___ indicates the factory setting.

OTHER FUNCTIONS screen (continued)

Item	Display mode	Description of settings																																																																																																										
TIME ZONE	(Camera) (PB)	Adds to or deducts from GMT the time value of -12:00 to +13:00 in 30-minute steps. (Refer to the table below.) +00:00																																																																																																										
		<table border="1"> <thead> <tr> <th>Time difference</th> <th>Area</th> <th>Time difference</th> <th>Area</th> </tr> </thead> <tbody> <tr> <td>+ 00:00</td> <td>Greenwich</td> <td>- 00:30</td> <td></td> </tr> <tr> <td>- 01:00</td> <td>Azores Islands</td> <td>- 01:30</td> <td></td> </tr> <tr> <td>- 02:00</td> <td>Mid-Atlantic</td> <td>- 02:30</td> <td></td> </tr> <tr> <td>- 03:00</td> <td>Buenos Aires</td> <td>- 03:30</td> <td>Newfoundland Island</td> </tr> <tr> <td>- 04:00</td> <td>Halifax</td> <td>- 04:30</td> <td></td> </tr> <tr> <td>- 05:00</td> <td>New York</td> <td>- 05:30</td> <td></td> </tr> <tr> <td>- 06:00</td> <td>Chicago</td> <td>- 06:30</td> <td></td> </tr> <tr> <td>- 07:00</td> <td>Denver</td> <td>- 07:30</td> <td></td> </tr> <tr> <td>- 08:00</td> <td>Los Angeles</td> <td>- 08:30</td> <td></td> </tr> <tr> <td>- 09:00</td> <td>Alaska</td> <td>- 09:30</td> <td>Marquesas Islands</td> </tr> <tr> <td>- 10:00</td> <td>Hawaii</td> <td>- 10:30</td> <td></td> </tr> <tr> <td>- 11:00</td> <td>Midway Island</td> <td>- 11:30</td> <td></td> </tr> <tr> <td>- 12:00</td> <td>Kwajalein</td> <td>+ 12:30</td> <td></td> </tr> <tr> <td>+ 13:00</td> <td></td> <td>+ 11:30</td> <td>Norfolk Island</td> </tr> <tr> <td>+ 12:00</td> <td>New Zealand</td> <td>+ 10:30</td> <td>Lord Howe Island</td> </tr> <tr> <td>+ 11:00</td> <td>Solomon Islands</td> <td>+ 09:30</td> <td>Darwin</td> </tr> <tr> <td>+ 10:00</td> <td>Guam</td> <td>+ 08:30</td> <td></td> </tr> <tr> <td>+ 09:00</td> <td>Tokyo</td> <td>+ 07:30</td> <td></td> </tr> <tr> <td>+ 08:00</td> <td>Beijing</td> <td>+ 06:30</td> <td>Yangon</td> </tr> <tr> <td>+ 07:00</td> <td>Bangkok</td> <td>+ 05:30</td> <td>Mumbai</td> </tr> <tr> <td>+ 06:00</td> <td>Dacca</td> <td>+ 04:30</td> <td>Kabul</td> </tr> <tr> <td>+ 05:00</td> <td>Islamabad</td> <td>+ 03:30</td> <td>Tehran</td> </tr> <tr> <td>+ 04:00</td> <td>Abu Dhabi</td> <td>+ 02:30</td> <td></td> </tr> <tr> <td>+ 03:00</td> <td>Moscow</td> <td>+ 01:30</td> <td></td> </tr> <tr> <td>+ 02:00</td> <td>Eastern Europe</td> <td>+ 00:30</td> <td></td> </tr> <tr> <td>+ 01:00</td> <td>Central Europe</td> <td></td> <td></td> </tr> </tbody> </table>	Time difference	Area	Time difference	Area	+ 00:00	Greenwich	- 00:30		- 01:00	Azores Islands	- 01:30		- 02:00	Mid-Atlantic	- 02:30		- 03:00	Buenos Aires	- 03:30	Newfoundland Island	- 04:00	Halifax	- 04:30		- 05:00	New York	- 05:30		- 06:00	Chicago	- 06:30		- 07:00	Denver	- 07:30		- 08:00	Los Angeles	- 08:30		- 09:00	Alaska	- 09:30	Marquesas Islands	- 10:00	Hawaii	- 10:30		- 11:00	Midway Island	- 11:30		- 12:00	Kwajalein	+ 12:30		+ 13:00		+ 11:30	Norfolk Island	+ 12:00	New Zealand	+ 10:30	Lord Howe Island	+ 11:00	Solomon Islands	+ 09:30	Darwin	+ 10:00	Guam	+ 08:30		+ 09:00	Tokyo	+ 07:30		+ 08:00	Beijing	+ 06:30	Yangon	+ 07:00	Bangkok	+ 05:30	Mumbai	+ 06:00	Dacca	+ 04:30	Kabul	+ 05:00	Islamabad	+ 03:30	Tehran	+ 04:00	Abu Dhabi	+ 02:30		+ 03:00	Moscow	+ 01:30		+ 02:00	Eastern Europe	+ 00:30		+ 01:00	Central Europe
Time difference	Area	Time difference	Area																																																																																																									
+ 00:00	Greenwich	- 00:30																																																																																																										
- 01:00	Azores Islands	- 01:30																																																																																																										
- 02:00	Mid-Atlantic	- 02:30																																																																																																										
- 03:00	Buenos Aires	- 03:30	Newfoundland Island																																																																																																									
- 04:00	Halifax	- 04:30																																																																																																										
- 05:00	New York	- 05:30																																																																																																										
- 06:00	Chicago	- 06:30																																																																																																										
- 07:00	Denver	- 07:30																																																																																																										
- 08:00	Los Angeles	- 08:30																																																																																																										
- 09:00	Alaska	- 09:30	Marquesas Islands																																																																																																									
- 10:00	Hawaii	- 10:30																																																																																																										
- 11:00	Midway Island	- 11:30																																																																																																										
- 12:00	Kwajalein	+ 12:30																																																																																																										
+ 13:00		+ 11:30	Norfolk Island																																																																																																									
+ 12:00	New Zealand	+ 10:30	Lord Howe Island																																																																																																									
+ 11:00	Solomon Islands	+ 09:30	Darwin																																																																																																									
+ 10:00	Guam	+ 08:30																																																																																																										
+ 09:00	Tokyo	+ 07:30																																																																																																										
+ 08:00	Beijing	+ 06:30	Yangon																																																																																																									
+ 07:00	Bangkok	+ 05:30	Mumbai																																																																																																									
+ 06:00	Dacca	+ 04:30	Kabul																																																																																																									
+ 05:00	Islamabad	+ 03:30	Tehran																																																																																																									
+ 04:00	Abu Dhabi	+ 02:30																																																																																																										
+ 03:00	Moscow	+ 01:30																																																																																																										
+ 02:00	Eastern Europe	+ 00:30																																																																																																										
+ 01:00	Central Europe																																																																																																											
POWER SAVE	(Camera)	<p>Selects the power-saving mode when no operation is performed from the Operation lever, MENU button, AUDIO MON/ADV button, USER button, or START/STOP button for about five minutes when an SD Memory Card has been inserted in the CAM mode.</p> <p>ON: Power supply to the camera is turned OFF. OFF: Power supply to the camera is not turned OFF.</p> <ul style="list-style-type: none"> • Even when POWER SAVE has been set to ON, the power supply does not turn OFF when an SD Memory Card has not been inserted, when the camera-recorder is in the PB or PC mode, or when the AC adaptor is connected. 																																																																																																										
LANGUAGE	(Camera) (PB)	<p>Sets the Menu language.</p> <p>ENGLISH, Français, Español</p>																																																																																																										
SYSTEM FREQ	(Camera) (PB)	<p>Sets the system frequency</p> <p>59.94Hz: NTSC region 50Hz: PAL region</p>																																																																																																										
SYSTEM INFO	(Camera)	Displays the version of the system in this camera.																																																																																																										
LENS INFO	(Camera) (PB)	Displays the version of the Micro Four Thirds and Four Thirds lenses that have been installed.																																																																																																										
MENU INIT	(Camera)	<p>Returns the menu settings (scene files and user files) to factory default settings.</p> <ul style="list-style-type: none"> • The TIME ZONE settings do not return to factory default settings. 																																																																																																										

___ indicates the factory setting.

Setup menu list (continued)

OTHER FUNCTIONS screen (continued)

Item	Display mode	Description of settings
OPERATION TIME	(Camera) (PB)	Displays the power-on time (a 5-digit figure).
UPDATE	(Camera)	Updates the system. For details on the update information, see our home page http://pro-av.panasonic.net/ .
LENS UPDATE	(Camera)	Updates the lens firmware. For details about the update information, see the home page of each lens manufacturer.

___ indicates the factory setting.

PLAY SETUP screen

Item	Display mode	Description of settings
PB FORMAT	(PB)	Sets the playback format. When SYSTEM FREQ = 59.94 Hz 1080/60i (30P), 1080/24P, 720/60P(30P), 720/24P When SYSTEM FREQ = 50 Hz 1080/50i(25P), 720/50P(25P) • The REC FORMAT setting in the CAM mode prior to migrating to the PB mode becomes the default value of the PB FORMAT.
REPEAT PLAY	(PB)	ON, OFF When ON is selected, supported clips are played repeatedly.
RESUME PLAY	(PB)	ON, OFF When ON is selected, playback resumes from the video position where clip playback had stopped.
SKIP MODE	(PB)	Selects the starting position for cued playback after pausing. CLIP: Stops playback at the beginning of the previous clip. CLIP & INDEX: Stops at the beginning of the clip and the INDEX.

___ indicates the factory setting.

THUMBNAIL screen

Item	Display mode	Description of settings
THUMBNAIL MODE	(PB)	Selects the thumbnail display method. ALL: Displays all clips. SAME FORMAT: Displays clips in the same recording format. MARKER: Displays clips with shot marks. INDEX: Displays clips with an INDEX.
INDICATOR	(PB)	Sets whether or not to display the indicator. ON: Displays the indicator OFF: Does not display the indicator
DATA DISPLAY	(PB)	Selects the information to be displayed in the time display area of the clips. TC: Time code UB: User information TIME: Shooting time DATE: Shooting date DATE & TIME: Shooting date and time
DATE FORMAT	(PB)	Selects the order for displaying the recording date/time when DATA DISPLAY is set to either DATE or DATE & TIME. Y-M-D: Year/Month/Day M-D-Y: Month/Day/Year D-M-Y: Day/Month/Year

___ indicates the factory setting.

OPERATION screen

Item	Display mode	Description of settings
DELETE	(PB)	Deletes clips. ALL CLIPS: Deletes all clips. SELECT: Deletes only the selected clips. NO: Returns to the previous screen. • Clips for which CLIP PROTECT is specified are not deleted.
INDEX	(PB)	Adds an INDEX to a clip, or deletes the INDEX. YES: Displays the INDEX NO: Does not display the INDEX
CLIP PROTECT	(PB)	Protects clips to prevent accidental deletion. YES: Enables clip protection or cancels protection. NO: Returns to the previous screen. • Formatting the memory card will delete all clips even if they are protected.
COPY	(PB)	Copies clips (Page 36).

___ indicates the factory setting.

Before calling for service

Power supply

There's no power.	<ul style="list-style-type: none"> • Make sure the battery and AC adaptor are connected properly. Check the connections again. 	P25 of Vol.1
Power shuts off for no apparent reason.	<ul style="list-style-type: none"> • To prevent the battery from running down needlessly, the camera-recorder automatically turns off when the camera-recorder has been left in the recording pause mode for more than 5 minutes. Check the settings in the OTHER FUNCTIONS screen, POWER SAVE. 	P63
Power goes off as soon as it is turned on.	<ul style="list-style-type: none"> • The battery may have run out. If the remaining battery charge display is blinking or  appears, the battery has run out. Either recharge the battery or replace the discharged battery with a fully charged one. 	P24 of Vol.1

Battery

The battery runs down quickly.	<ul style="list-style-type: none"> • Make sure the battery is fully charged. Keep charging until the AC adaptor's CHARGE lamp goes out. • Are you using the battery in a cold place? The battery is affected by the ambient temperature. Its operating time is reduced in low-temperatures. • The battery may have reached the end of its service life. The battery will become unchargeable. The battery has a certain service life which varies depending on how the battery is used. If the battery operates only for a short period even when it is charged adequately, it has reached the end of its service life. 	P23 of Vol.1
The battery cannot be charged.	<ul style="list-style-type: none"> • The battery cannot be charged if the DC cord is connected. Disconnect it. 	P23 of Vol.1
The remaining battery capacity is not displayed correctly.	<ul style="list-style-type: none"> • The remaining battery capacity display is merely a guideline. To ensure that remaining battery capacity is displayed correctly, use the battery completely from a fully-charged state, and charge the battery again. (Remaining battery capacity may still not be displayed correctly if the battery has been used for long periods in high or low temperatures, or if the battery has been recharged a large number of times.) 	—

Shooting

Cannot start shooting.	<ul style="list-style-type: none"> • Make sure the POWER switch is ON. 	P27 of Vol.1
Cannot focus automatically.	<ul style="list-style-type: none"> • Make sure the camera is in manual focus mode. You can focus automatically when the auto focus mode is selected. • Auto focus is not available when using the VFR function. • Auto focus is not available at slow shutter speed settings. • Depending on the lens, the auto focus function may not be available. • You may be shooting a scene where it is difficult to bring the subject into focus in the auto focus mode. If this is the case, focus in the manual focus mode. It may be hard to bring the subject into focus when <ul style="list-style-type: none"> · both close and distant objects are to be shot · shooting through a dirty window · shooting in a dark place · there are sparkling or shiny objects around the subject · the subject is moving fast · shooting a scene with minimal contrast 	P39 of Vol.1

Recording

<p>Cannot record even through the SD Memory Card is inserted correctly.</p>	<ul style="list-style-type: none"> • Is the write-protect switch on the SD Memory Card in the “LOCK” position? The card cannot be recorded to if the switch is in the “LOCK” position. • Is the remaining memory available on the SD Memory Card extremely low? Please save contents onto different media and delete unneeded data from the card, or use a new card instead. • Has the SD Memory Card been correctly formatted? Alternatively, is the card of a format that is incompatible with this camera? Reformat the card with the camera. • 8 MB to 16 MB SD Memory Cards cannot be used for shooting movies. 	<p>P38 of Vol.1</p> <p>P36 of Vol.1</p> <p>P13 of Vol.1</p>
<p>Recording stops by itself.</p>	<ul style="list-style-type: none"> • Is your SD Memory Card compatible with use for video recording? Always use an SD Memory Card compatible with use for video recording. 	<p>P12 of Vol.1</p>

Editing

<p>Cannot read the data on the SD Memory Card.</p>	<ul style="list-style-type: none"> • Make sure the SD Memory Card is formatted correctly. If it is not, format the card in the unit. 	<p>P36 of Vol.1</p>
<p>Cannot perform nonlinear editing.</p>	<ul style="list-style-type: none"> • Check the specifications of your computer and connecting cable. 	<p>P42</p>
<p>Cannot dub onto an external device.</p>	<ul style="list-style-type: none"> • Make sure the external device is connected correctly. 	<p>P42</p>

Displays

<p>Something is wrong with the time code display.</p>	<ul style="list-style-type: none"> • The time code display may not register a regular count if a clip is played in the reverse slow mode. This is normal. 	<p>—</p>
--	--	----------

Playback

<p>Cannot play even when I press the play button.</p>	<ul style="list-style-type: none"> • Make sure the PB lamp is on (press the mode button). No kind of playback operation can be performed unless this lamp is on. 	<p>P28</p>
<p>Mosaic-like noise appears when I cue or review a clip.</p>	<ul style="list-style-type: none"> • This noise is inherent to digital video technology. This is normal. 	<p>—</p>
<p>Images do not appear on the television even though I have connected the camera-recorder properly.</p>	<ul style="list-style-type: none"> • Make sure the input selector on your television is set to video input. Read the television’s instructions carefully and select the correct video input connector for the camera-recorder. 	<p>—</p>
<p>Cannot hear any sound from the camera-recorder’s speaker.</p>	<ul style="list-style-type: none"> • You may have turned down the camera-recorder’s volume control too far. Adjust the volume level using the AUDIO MON/ADV button +. 	<p>P40</p>

Before calling for service (continued)

PC connection

Computer does not recognize camera when USB connection cable is connected.	<ul style="list-style-type: none">• Check the operating environment.• If your computer has multiple USB terminals, please try connecting the camera to a different USB terminal.• Switch the camera's power off and back on again, and reconnect the USB connection cable.	P42
An error message appears on the computer when the USB connection cable is disconnected.	<ul style="list-style-type: none">• To disconnect the USB connection cable safely, double-click the icon in the task tray, and follow the instructions on the screen.	—

Other

The remote control does not work.	<ul style="list-style-type: none">• The battery in the remote control may have run out. If the remote control fails to work even if it is operated close to the remote control sensor of the camera-recorder, it means that the battery has run out. Replace it with new one.• Is the IR REMOTE item on the setting menu OTHER FUNCTIONS screen set to OFF?	P23 of Vol.1
There is a rattling sound when the camera-recorder is tilted back and forth.	<ul style="list-style-type: none">• This is the sound of the lens moving. This is not a fault. No sound should be heard when the camera's power is switched on.	—
A clicking sound is heard when the power is turned on or when the PB mode is switched to the CAM mode.	<ul style="list-style-type: none">• This initialization operation is performed when the camera starts up. It occurs due to the construction of the camera and is not indicative of any trouble.	—
The SD Memory Card screen appears strange.	<ul style="list-style-type: none">• The data on the card could be corrupted. Data can be corrupted by static electricity and electromagnetic waves. Please always save important data to a computer or other storage media.	—
The SD Memory Card cannot be used even after formatting.	<ul style="list-style-type: none">• There could be a fault with the camera or with the SD Memory Card. Please consult the place of purchase. Always use only SD Memory Cards of 512 MB - 32 GB with this camera.	—
The camera does not recognize the SD Memory Card even though it is inserted correctly.	<ul style="list-style-type: none">• Was the inserted SD Memory Card originally formatted with a computer? Always use this camera to format SD Memory Cards. Please be aware that, when an SD Memory Card is formatted, all data recorded on the card will be erased and will not be restorable.	P36 of Vol.1
The SD Memory Card is not recognized when inserted into other devices.	<ul style="list-style-type: none">• Please check that the device is compatible with the capacity or type (SD Memory Card/SDHC Memory Card/SDXC Memory Card) of the SD Memory Card that you are using. For details, please consult the device's own operating instructions.	P12 of Vol.1

The changeover between clips may not always be smooth when playing back multiple clips in succession. Video may momentarily pause when playing back multiple clips in succession in circumstances such as those detailed below.

■ **Mixture of different recording formats**

Recording mode = PH mode
 Playback format = 1080/60i(30P)

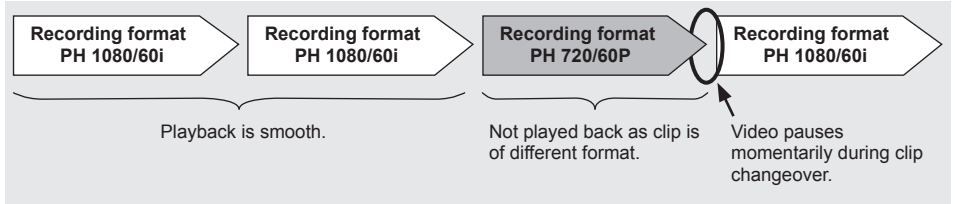

■ **Mixture of different recording modes**

Recording format = 1080/60i
 Playback format = 1080/60i(30P)

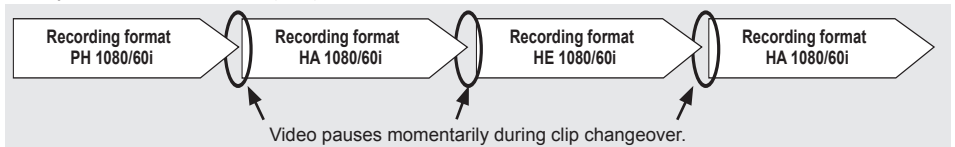

■ **Some clips have been recorded using PRE REC function or VFR function**

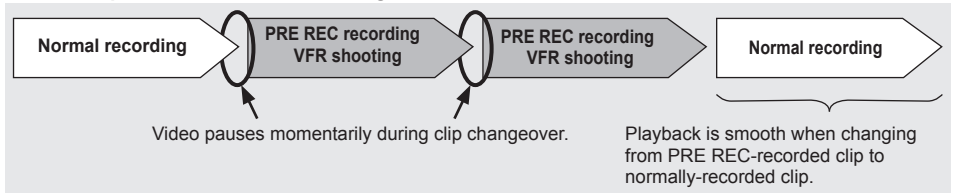

■ **Some clips have a recording time of less than 3 seconds**

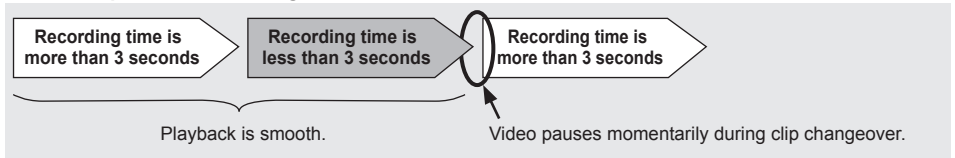

Updating the firmware incorporated into the unit

The firmware can be updated using either of the following two methods.

1 Checking the current version of firmware and performing the update using the dedicated tool (P2_Status_Logger)

PASS (P2 Asset Support System) is only available to customers who have completed customer registration with Panasonic.

Log in to PASS and use the dedicated tool (P2_Status_Logger) to check the version information of the firmware on the unit and download links to pages containing the necessary firmware.

For further information about downloading and using P2_Status_Logger, log in to PASS and refer to the relevant pages.

Besides access to PASS, completing customer registration has a number of other benefits. For further details, refer to the PASS (P2 Asset Support System) website (http://panasonic.biz/sav/pass_e/).

2 Checking the current version of the firmware using the unit and performing the update

From the OTHER FUNCTIONS menu page, check the current version of firmware on the unit using the SYSTEM INFO screen. Then, access the website listed below for the latest firmware-related information and download firmware as required.

- The update is completed by loading the downloaded file onto the unit via an SD memory card. For further details about the updating methods, refer to the following website.
<http://pro-av.panasonic.net/>
 - Be sure to use a compatible SD memory card. The unit is compatible with SD memory cards based on the SD, SDHC and SDXC standards. Also, be sure to format the memory card using the unit before use.
-

Cleaning

When cleaning, do not use benzene or thinner.

- Using benzene or paint thinners may deform the camera-recorder and/or cause the surface finish to peel off.
- Before proceeding with maintenance, remove the battery or disconnect the AC cord from the power outlet.
- Use a soft, clean cloth to wipe the camera-recorder. To remove stubborn dirt, wipe the camera-recorder with a cloth moistened with kitchen detergent that has been diluted with water and then use a dry cloth to take up the remaining moisture.

Cleaning the Viewfinder

If there is dust inside the viewfinder, remove the eye cup holder and get rid of the dust.

- The interior of the eye cup holder is specially finished, so do not ever wipe it. If there is dust on it, blow it off with an air blower.
- Remove the eye cup holder with the eye cup attached by rotating it counterclockwise. (It will be tightly screwed on.) When you do this, tilt the viewfinder slightly upward.
- To mount the eye cup holder, align the ridges and grooves of the eye cup holder and camera-recorder, and turn clockwise until the holder clicks into place.

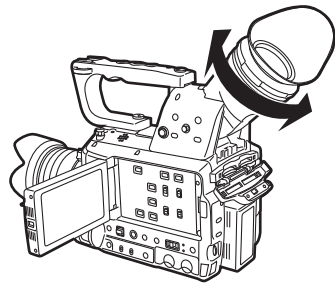
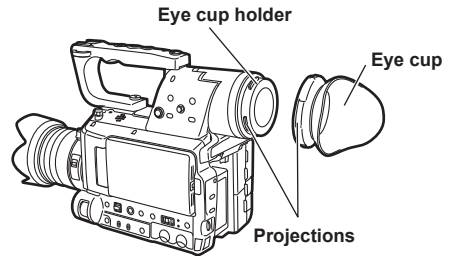

Storage Precautions

Before storing the camera-recorder, remove both the SD Memory Card and battery.

Store all of these items in a place with low humidity and relatively constant temperature.

[Recommended temperature range: 15°C to 25°C]

[Recommended relative humidity: 40% to 60%]

Camera-recorder

- Wrap the camera-recorder in a soft cloth to keep the dust off.

Battery

- The battery life is shortened in places with extreme temperatures.
- Storing the battery in a location with oily vapors or high dust concentrations may corrode the terminals or cause other damage, leading to malfunction.
- **Keep metal objects (such as necklaces and hairpins) away from the terminals. Short-circuiting may occur across the terminals, causing the battery to heat up, and you may seriously burn yourself if you touch the battery in this state.**

SD Memory Cards

- After ejecting an SD Memory Card from the unit, be absolutely sure to stow it in its own case.
- Do not leave SD Memory Cards in areas where corrosive gases, etc. are present.
- Do not leave the cards inside vehicles, in places exposed to direct sunlight or in other places where the temperature is high.
- Do not leave the cards where the humidity level is high or where there are high concentrations of dust.

How to handle data recorded on SD Memory Card

Data recorded in AVCHD format offers excellent compatibility with computers due to the file type, but since this format includes not only video and audio data, but also a variety of important information, the folder structure will consist of file associations as illustrated in the diagram on the right. If even part of this information is modified or deleted, the data may no longer be recognized as AVCHD data, or the memory card may not longer be able to be used with AVCHD devices.

To prevent the loss of any part of the information when transferring data on the SD Memory Card to a computer or when copying data stored on a

computer back onto the SD Memory Card, be sure to use the dedicated AVCCAM Viewer.

The AVCCAM Viewer can also be downloaded from the following website.

(Compatible OS: Windows XP/Windows Vista/Windows 7 or Mac OS 10.4 or later/Mac OS 10.5/Mac OS 10.6)

<http://pro-av.panasonic.net/>

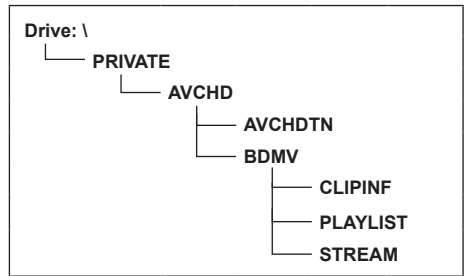

■ Concerning the handling of the camera's metadata

A special manufacturer area in the control file area under the AVCHD standard is employed for the metadata which is supported by this camera.

If files are deleted or copied, if clip protection is added or removed or if other such editing operations have been performed using editing software or a camera recorder which does not support this camera's metadata, the special area for the metadata will be erased, and the shot marks and indexes added by the camera as well as the PH mode information and other information will be lost. Therefore, before proceeding with these kinds of editing operations, check whether the camera's metadata is supported.

Panasonic Solutions Company

3 Panasonic Way, Secaucus, NJ 07094 Tel: 877-803-8492
www.panasonic.com/broadcast e-mail: MediaProServices.PSC@us.panasonic.com

Panasonic Canada Inc.

5770 Ambler Drive, Mississauga, Ontario L4W 2T3 Tel: 905-624-5010

Panasonic de México S.A. De C.V.

Casa Matriz: Felix Cuevas No.6 Piso 2 y 3 Col. Tlacoquemecatl Del Valle Del.Benito Juárez, México, D.F., C.P.03200
Tel: 55-5488-1000 Fax: 55-5575-6783

Panasonic Latin America, S.A.

P.O.Box 0816-03164 Panama, Republic of Panama Tel: +507-229-2955 Fax: 507-229-5352

Panasonic do Brasil Ltda.

Rua Cubatão, 320-6º andar-Paraíso CEP 04013-001- São Paulo -SP Tel: 11-3889-4000 Fax: 11-3889-4004

