

# Panasonic®

## Operating Instructions for advanced features

Digital Camera

Model No. **DMC-TZ60**  
**DMC-TZ61**

# LUMIX

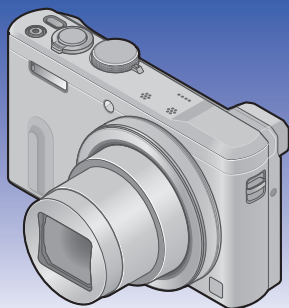

Please read these instructions carefully before using this product, and save this manual for future use.



# Contents

## Preparations

<b>Before use</b> .....	8
About GPS .....	10
<b>Standard Accessories</b> .....	11
<b>Names and Functions of Main Parts</b> .....	12
Viewfinder (LVF) .....	15
[MENU/SET] button / Cursor button / Control dial .....	16
Putting on the hand strap .....	16
<b>Charging battery</b> .....	17
Inserting the battery .....	18
Charging the battery .....	19
Remaining battery .....	22
Guidelines for number of recordable pictures and operating time .....	22
<b>Inserting and removing the card (optional)</b> .....	24
<b>Saving your pictures (cards and built-in memory)</b> .....	25
Recording capacity guidelines (pictures/recording time) .....	26
<b>Setting the clock</b> .....	28
Changing time settings .....	29

## Basics

<b>Sequence of operations</b> .....	30
<b>Using the control ring/control dial</b> .....	33
Using Quick menu .....	34
<b>Taking pictures with automatic settings [Intelligent Auto] Mode</b> .....	35
Using flash .....	35
Automatic Scene Detection .....	36
Defocusing the background .....	37
[Motion Deblur] .....	38
[iHandheld Night Shot] .....	39
[iHDR] .....	39
AF Tracking .....	40
[Intelligent Auto Plus] Mode .....	41
About [Intelligent Auto] setting items .....	43
<b>Taking pictures with your own settings [Program AE] Mode</b> .....	44
Programme Shift .....	45
<b>Adjusting focus</b> .....	47
<b>Recording motion pictures</b> .....	48
Taking still pictures while a motion picture is being recorded .....	51
<b>Viewing your pictures</b> .....	52
Zooming in and viewing "Playback Zoom" .....	53
Viewing a list of pictures "Multi Playback" .....	54
Searching and viewing pictures by their recording date [Calendar] .....	55
<b>Viewing motion pictures</b> .....	56
Capturing still pictures from motion pictures .....	57
<b>Deleting pictures</b> .....	58
To delete multiple (up to 100)/ To delete all pictures .....	59
<b>Setting the menu</b> .....	60
Menu type .....	61

<b>Using the [Setup] menu .....</b>	<b>62</b>
[Clock Set] .....	62
[Auto Clock Set] .....	62
[World Time] .....	62
[Travel Date] .....	62
[Airplane Mode] .....	62
[Beep] .....	63
[Cust.Set Mem.] .....	64
[Fn Button Set] .....	64
[Zoom Lever Set] .....	64
[Ring/Dial Set] .....	64
[Live View Mode] .....	65
[Monitor Display] / [Viewfinder] .....	65
[Monitor Luminance] .....	66
[Composition Guide] .....	66
[Guide Line] .....	66
[Histogram] .....	67
[Video Rec Area] .....	67
[Remaining Disp.] .....	68
[Lens Resume] .....	68
[MF Assist] .....	68
[Peaking] .....	68
[Economy] .....	69
[Auto Review] .....	70
[Exposure Comp. Reset] .....	70
[Self Timer Auto Off] .....	70
[No.Reset] .....	71
[Reset] .....	71
[Reset Wi-Fi Settings] .....	71
[USB Mode] .....	72
[TV Connection] .....	72
[Rotate Disp.] .....	73
[Version Disp.] .....	74
[Format] .....	74
[Language] .....	74
<b>Entering Text .....</b>	<b>75</b>

## Application (Record)

<b>Switching the display of recording information, etc.....</b>	<b>76</b>
<b>Taking pictures with the composition determined [Composition Guide] .....</b>	<b>77</b>
<b>Using the level gauge.....</b>	<b>79</b>
<b>Using Zoom.....</b>	<b>80</b>
Zoom types and use.....	81
[Step Zoom].....	83
<b>Taking pictures with flash.....</b>	<b>85</b>
<b>Taking pictures with Auto Focus .....</b>	<b>88</b>
Taking front-on pictures of people (Face Detection).....	89
Automatically locking the focus on a moving subject (AF Tracking).....	90
Subject not centred in picture (23-area-focusing).....	91
Determined position for focus (1-area-focusing).....	91
<b>Taking close-up pictures (Macro recording) .....</b>	<b>93</b>
Focus range .....	94
[Macro Zoom] .....	95
<b>Taking pictures with Manual Focus ...</b>	<b>96</b>
<b>Taking pictures by locking the focus and/or exposure [AF/AE Lock] .....</b>	<b>99</b>
<b>Taking pictures with Exposure Compensation.....</b>	<b>100</b>
Recording while exposure is changed automatically ([Auto Bracket]) .....	101
<b>Burst function .....</b>	<b>102</b>
<b>Taking pictures with self-timer .....</b>	<b>105</b>
<b>Taking pictures by setting the aperture value [Aperture-Priority] Mode .....</b>	<b>106</b>
<b>Taking pictures by setting the shutter speed [Shutter-Priority] Mode .....</b>	<b>107</b>
<b>Taking pictures by setting the aperture value and shutter speed [Manual Exposure] Mode .....</b>	<b>108</b>

## Taking Pictures with different picture effects

<b>[Creative Control] Mode</b> .....	<b>110</b>
[Expressive].....	112
[Retro].....	112
[Old Days].....	112
[High Key].....	113
[Low Key].....	113
[Sepia].....	113
[Dynamic Monochrome].....	114
[Impressive Art].....	114
[High Dynamic].....	114
[Cross Process].....	115
[Toy Effect].....	115
[Miniature Effect].....	116
[Soft Focus].....	117
[Star Filter].....	117
[One Point Color].....	118

## Recording panorama pictures

<b>[Panorama Shot] Mode</b> .....	<b>119</b>
-----------------------------------	------------

## Taking pictures according to the scene

<b>[Scene Mode]</b> .....	<b>123</b>
[Portrait].....	124
[Soft Skin].....	124
[Scenery].....	124
[Sports].....	125
[Night Portrait].....	125
[Night Scenery].....	125
[Handheld Night Shot].....	126
[HDR].....	126
[Food].....	126
[Baby].....	127
[Pet].....	127
[Sunset].....	127
[High Sens.].....	128
[Starry Sky].....	128
[Glass Through].....	128
[High Speed Video].....	129
[3D Photo Mode].....	130

## Registering your own settings and recording

<b>[Custom] Mode</b> .....	<b>131</b>
[Cust.Set Mem.].....	131
[Custom].....	132

## Registering preferred functions to

the [Fn] button.....	<b>133</b>
----------------------	------------

## Changing the settings assigned to

the control ring/control dial.....	<b>134</b>
------------------------------------	------------

## Recording with the Face

### Recognition function

<b>[Face Recog.]</b> .....	<b>135</b>
Registering face pictures.....	136
Editing or deleting information about registered persons.....	137

## Useful features for travel..... 138

[Travel Date].....	138
[World Time].....	139

## Using the [Rec] menu..... 140

[Aspect Ratio].....	140
[Picture Size].....	140
[Quality].....	141
[Sensitivity].....	142
[ISO Limit Set].....	143
[Extended ISO].....	143
[White Balance].....	144
[AF Mode].....	146
[Quick AF].....	146
[Face Recog.].....	146
[AF/AE Lock].....	146
[Metering Mode].....	147
[i.Exposure].....	147
[Min. Shtr Speed].....	148
[i.Resolution].....	148
[i.Zoom].....	148
[Digital Zoom].....	148
[AF Assist Lamp].....	149
[Red-Eye Removal].....	149
[Motion Deblur].....	150
[iHandheld Night Shot].....	150
[iHDR].....	150
[Stabilizer].....	150
[Date Stamp].....	151

## Using the [Motion Picture] menu..... 152

[Rec Format].....	152
[Rec Quality].....	152
[Still Picture Size].....	153
[Continuous AF].....	154
[Level Shot].....	154
[Wind Cut].....	155
[Zoom Mic].....	155



## Application (View)

<b>Changing the picture information display, etc.</b> .....	156
<b>Playing back still pictures recorded using the burst function</b> .....	157
<b>Different playback methods</b>	
<b>[Playback Mode]</b> .....	159
[2D/3D Settings] .....	159
<b>Selecting pictures to play back</b>	
<b>[Filtering Play]</b> .....	160
Narrowing down by selecting picture type .....	161
Narrowing down by selecting place name or landmark name of the location where the pictures were taken .....	161
Narrowing down by selecting pictures recorded at a destination .....	162
Narrowing down by selecting picture category or a person in the picture .....	162
Narrowing down by selecting recording date .....	163
Narrowing down by selecting favourite pictures .....	163
<b>Playing back pictures in order automatically</b>	
<b>[Slide Show]</b> .....	164
<b>Searching by recording date</b>	
<b>[Calendar]</b> .....	166
<b>Retouching pictures</b> .....	167
[Auto Retouch] .....	167
[Creative Retouch] .....	168

<b>Using the [Playback] menu</b> .....	170
[Location Logging] .....	170
[Title Edit] .....	172
[Place-Name Edit] .....	173
[Text Stamp] .....	174
[Retouch] .....	175
[Video Divide] .....	176
[Resize] .....	177
[Cropping] .....	179
[Favorite] .....	180
[Print Set] .....	181
[Protect] .....	182
[Face Rec Edit] .....	183
[Copy] .....	184

## Wi-Fi/NFC

<b>Wi-Fi® Function and NFC Function...</b>	<b>185</b>
[Airplane Mode].....	187
<b>What you can do with the Wi-Fi function.....</b>	<b>188</b>
<b>Operating the camera using a smartphone/tablet .....</b>	<b>189</b>
Installing the smartphone/tablet app	
“Panasonic Image App”.....	189
Connecting to a smartphone/tablet .....	190
Connecting to a smartphone/tablet using NFC function .....	194
Taking pictures via a smartphone/tablet (remote recording).....	196
Playing back pictures in the camera on a smartphone/tablet .....	197
Saving pictures in the camera to the smartphone/tablet .....	197
Sending pictures in the camera to social networking services.....	200
Sending location information to the camera from a smartphone/tablet .....	201
Operating the camera to send pictures to a smartphone or tablet .....	202
<b>Displaying still pictures on a TV .....</b>	<b>207</b>
<b>Wireless printing .....</b>	<b>209</b>
<b>Sending pictures to AV equipment .....</b>	<b>211</b>
<b>Sending pictures to a PC .....</b>	<b>216</b>
<b>Using WEB services.....</b>	<b>221</b>
When sending images to WEB service.....	222
When sending images to [Cloud Sync. Service].....	227

<b>Using “LUMIX CLUB” .....</b>	<b>231</b>
About the [LUMIX CLUB] .....	231
Configuring the external AV device settings.....	236
<b>Transferring pictures automatically [Smart Transfer].....</b>	<b>238</b>
Setting [Smart Transfer] .....	240
[Auto Transfer].....	241
[Transfer Now].....	242
[Set Destination].....	243
[Charge Priority] .....	244
[Display Log] .....	244
<b>About connections .....</b>	<b>245</b>
[Via Network]	
Connecting via a wireless access point ....	246
[Direct] Connecting directly .....	249
Connecting quickly with the same settings as used previously (History Connection)/ [Favorite Connection].....	250
Settings for sending pictures.....	253
<b>[Wi-Fi Setup] menu .....</b>	<b>255</b>

## GPS

<b>Using the GPS function to record the location of a picture</b> .....	<b>257</b>
[GPS Setting] .....	258
[Repositioning] .....	261
[GPS Area Select] .....	263
[Area Info. Set] .....	264
[Airplane Mode] .....	264
<b>Adjusting the time using GPS</b> .....	<b>265</b>
<b>Reducing the time required for positioning</b> .....	<b>266</b>
Using the "GPS Assist Tool" .....	266
Using the Wi-Fi function to update .....	270
Checking the expiration date of the GPS assist data .....	271
<b>Registering my landmark</b> .....	<b>272</b>
<b>Using the GPS log</b> .....	<b>273</b>
Recording the GPS log .....	273
Outputting the GPS log file.....	275
Deleting the GPS log.....	276

## Connecting with other devices

<b>Viewing on TV screen</b> .....	<b>277</b>
VIERA Link (HDMI) (HDAVI Control™) .....	279
Viewing 3D still pictures .....	281
<b>Storing recorded still pictures and motion pictures in the recorder</b> .....	<b>283</b>
Copying by inserting the card into the recorder.....	283
Dubbing playback pictures via AV cables (optional) .....	283
<b>Storing recorded still pictures and motion pictures on your PC</b> .....	<b>284</b>
About supplied software .....	285
Installing supplied software .....	286
Downloading SILKYPIX Developer Studio SE .....	287
Copying still pictures and motion pictures.....	288
<b>Printing</b> .....	<b>291</b>
Printing multiple pictures .....	293
Printing with date and text .....	293
Making print settings on the camera .....	294

## Others

<b>List of LCD monitor/Viewfinder displays</b> .....	<b>295</b>
In recording .....	295
In playback .....	298
<b>Message displays</b> .....	<b>300</b>
<b>Q&amp;A Troubleshooting</b> .....	<b>304</b>
<b>Usage cautions and notes</b> .....	<b>316</b>
User Licence Agreement for Location Name Data .....	320

## Before use

### ■ Camera handling

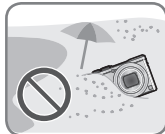
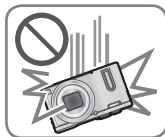

**Keep the camera away from excessive vibration, force, or pressure.**

- Avoid using the camera under the following conditions, which may damage the lens, LCD monitor, viewfinder, or camera body. This may also cause the camera to malfunction or prevent recording.
  - Dropping or hitting the camera against a hard surface
  - Sitting down with the camera in your pants pocket or forcing it into a full bag
  - Adding accessories to the camera strap
  - Pushing with excessive force on the lens or LCD monitor

**The camera is not dust resistant, splash resistant, or waterproof.**

**Avoid using the camera in places with excessive dust or sand, or where water can come into contact with the camera.**

- Avoid using the camera under the following conditions, which present a risk that sand, water, or foreign material may enter the camera through the lens or openings around buttons. Be especially careful because these conditions may damage the camera, and such damage may not be repairable.
  - In extremely dusty or sandy places
  - In the rain or by the shore, where the camera may be exposed to water

### ■ Condensation (When the lens, the LCD monitor, or viewfinder, is fogged up)

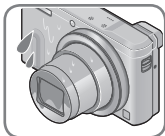

- Condensation may occur when the camera is exposed to sudden changes of temperature or humidity. Avoid these conditions, which may make the lens, LCD monitor, or viewfinder, dirty, cause mould, or damage the camera.
- If condensation does occur, turn off the camera and wait about two hours before using it. Once the camera adjusts to the surrounding temperature, the fogging will clear naturally.

## ■ Always take a test shot first

Before important events when you will use the camera (at weddings, for example), always take a test shot to make sure that pictures and sound record correctly.

## ■ No compensation for missed shots

We cannot compensate for missed shots if technical problems with the camera or card prevent recording.

## ■ Carefully observe copyright laws

Unauthorised use of recordings that contain works with copyright for purposes other than personal use is prohibited under copyright law. Recording of certain material may be restricted even for the purpose of personal use.

## ■ Also refer to “Usage cautions and notes” (→316)

● Please note that the actual controls and components, menu items, and other information for your digital camera may differ from those in the illustrations and screens provided in this manual.

### ● Recording mode icons

In Recording Modes that show icons in black, you can select and execute indicated menus and functions.

\*[C1] and [C2] will differ depending on the Recording Modes registered under custom settings.

## About GPS

■ **About the camera's location name information**

Before using the camera, read "User Licence Agreement for Location Name Data". (→320)

■ **About the GPS function**

- Information measured with this unit is simply a rough estimate. Please do not use for professional applications.
- When [GPS Setting] is [ON], the GPS function works even if the camera is turned off.
  - Electromagnetic waves from the camera can affect instruments and meters. In airplane cabins (during takeoff and landing) or in other restricted areas, set [Airplane Mode] to [ON], and then turn off the camera. (→62)
  - When [GPS Setting] is [ON] and [Airplane Mode] is [OFF], power will drain from the battery even if the camera is turned off.

■ **Recording location information**

- The names of recording locations and landmarks (such as buildings) are current as of October 2012. These will not be updated.
- Depending on the country or area, limited location name and landmark information may be available.

■ **Positioning**

- Positioning will take time in environments where it is difficult to receive the signals from the GPS satellites. (→257)
- **Even if GPS reception is good, it will take approx. 2 to 3 minutes to successfully execute positioning under the following conditions: when positioning is executed for the first time, or when positioning is executed after the camera is turned off with the [GPS Setting] set to [OFF] or [Airplane Mode] set to [ON], and then turned on again.**  
**Positioning can be executed faster using GPS assist data.** (→266)
- Because the positions of the GPS satellites are constantly changing, depending on the recording location and conditions, it may not be possible to position such satellites accurately, or positioning discrepancy may occur.

■ **When using in another country**

- The GPS function may not work in China or in the border regions of countries neighbouring China. (Current as of January 2014)
- Some countries or regions may regulate the use of GPS or related technology. Because this camera has a GPS function, before taking it into another country, check with the embassy or your travel agency whether there are any restrictions on bringing cameras with a GPS function.

## Standard Accessories

Check that all the accessories are supplied before using the camera.

- The accessories and their shape will differ depending on the country or area where the camera was purchased.  
For details on the accessories, refer to Basic Operating Instructions.
- Battery Pack is indicated as battery pack or battery in the text.
- SD Memory Card, SDHC Memory Card and SDXC Memory Card are indicated as card in the text.
- Please dispose of all packaging appropriately.
- Keep small parts in a safe place out of the reach of children.

### ■ Optional accessories

- **Cards are optional.** You can record or play back pictures on the built-in memory when you are not using a card. ([→25](#))

## Names and Functions of Main Parts

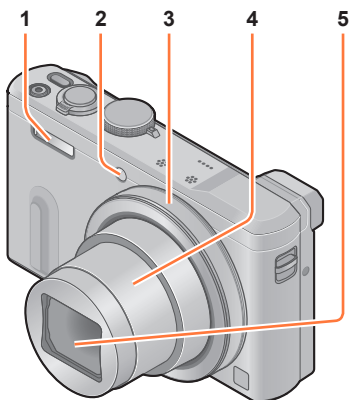

(Top)

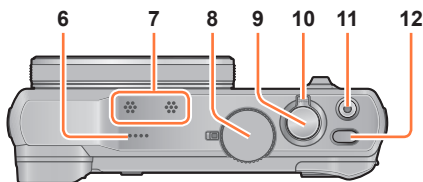

(Bottom)

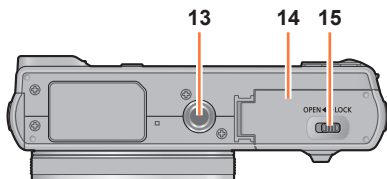

- 1 **Flash** (→31, 85)
- 2 **Self-timer indicator** (→105) / **AF Assist Lamp** (→149)  
Illuminates when the self-timer is set or when the Auto Focus is operated in dark locations.
- 3 **Control ring** (→33)  
Allows you to zoom and adjust settings when recording.
- 4 **Lens barrel**
- 5 **Lens**
- 6 **Speaker**
- 7 **Microphones** (→31, 48)
- 8 **Mode dial** (→30)  
Use this to select the Recording Mode.
- 9 **Shutter button**
- 10 **Zoom lever** (→80)  
Use the lever to zoom in and enlarge a distant subject.
- 11 **Motion picture button** (→48)  
Record motion pictures.
- 12 **Camera [ON/OFF] button**  
Use this to turn the camera on and off.
- 13 **Tripod mount** (→318)  
Do not attach to a tripod with a 5.5 mm (0.22 inch) or longer screw. Doing so may damage this unit.  
It may not be possible to attach certain types of tripods properly.
- 14 **Card/Battery door** (→18, 24)  
Open this door to insert and remove a card or battery.
- 15 **Release lever** (→18, 24)



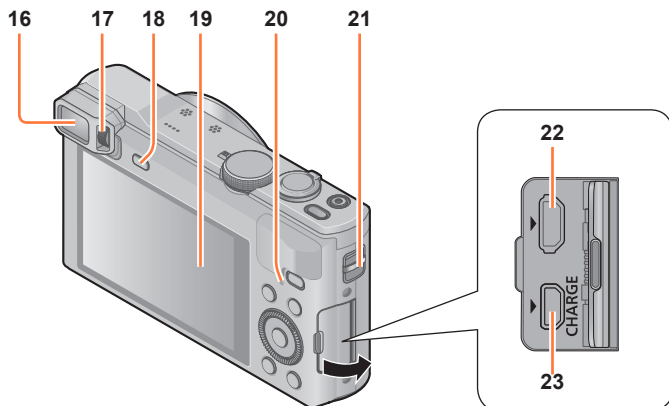

- 16 **Viewfinder (LVF)** (→15)  
In this manual, “viewfinder” is used to indicate the LVF.
- 17 **Diopter adjustment dial** (→15)  
Turn the dial to adjust the focus in the viewfinder.
- 18 **[LVF] button** (→15)  
Use this to switch display between viewfinder and LCD monitor.
- 19 **LCD monitor** (→65, 66, 295)
- 20 **Charging lamp (Red)** (→20)  
**Wi-Fi® connection lamp (Blue)** (→186)  
**GPS status indicator (Green)** (→258)  
The colour of the lamp differs depending on the function.
- 21 **Strap eyelet** (→16)
- 22 **[HDMI] socket** (→277, 279)  
Do not connect any other cables except the HDMI micro cable. Doing so may cause malfunction.
- 23 **[AV OUT/DIGITAL] socket** (→277, 283, 288, 291)  
This socket is also used when charging the battery. (→19)

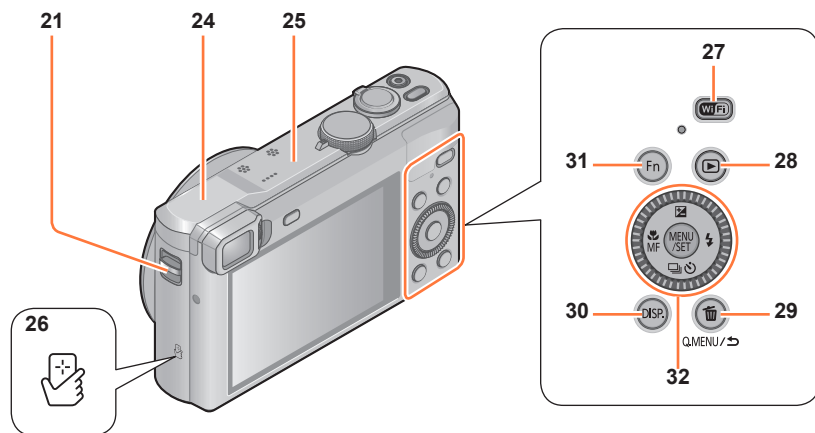

21 **Strap eyelet** (→16)

24 **[Wi-Fi] antenna**

25 **GPS antenna** (→258)

26 **NFC antenna** (→194)

27 **[Wi-Fi] button** (→186)

28 **Playback button**

Use this to select the Recording Mode or Playback Mode.

29 **[Q.MENU/ ] / [ ] button**

You can display the Quick Menu (→34) and erase pictures (→58).

You can also use this button to return to the previous screen while a menu is displayed (→60).

30 **[DISP.] button** (→76, 156)

Use this to change display.

31 **[Fn] button** (→133)

Use this to use registered functions.

32 **[MENU/SET] button / Cursor button / Control dial** (→16)

● The illustrations and screens in this manual may differ from the actual product.

### Viewfinder (LVF)

When you use the viewfinder, you can check the view of the subject even if you are in a bright area.

#### ■ Switching between the LCD monitor and viewfinder

##### 1 Press [LVF] button

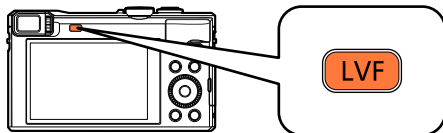

- For each of recording mode and playback mode, whether pictures were displayed on the LCD monitor or the viewfinder are memorised. It is possible to selectively use the viewfinder for recording pictures and the LCD monitor for playing back pictures. (Setting is memorised even if the camera is turned off).

#### ■ About diopter adjustment

Adjust the diopter to suit your vision so that you can see the Viewfinder clearly.

Turn the diopter adjustment dial to adjust until you are able to clearly see the characters displayed in the viewfinder.

Diopter adjustment dial

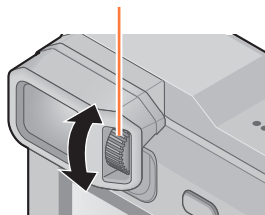

- When doing diopter adjustment, align the centre of the viewfinder with your eye.

## [MENU/SET] button / Cursor button / Control dial

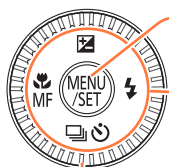
**[MENU/SET] button**

- Use this button to display the menus, enter the settings, etc. (→60)

**Cursor button**

This button is used to move the cursor on the menu screens and for other functions. (→60)

You can perform the following operations while recording.

**[☒] button (▲)**

Exposure Compensation (→100)

**[⚡] button (▶)**

Flash (→85)

**[📷🕒] button (▼)**

Burst (→102), Auto Bracket (→101), Self-timer (→105)

**[MF] button (◀)**

Macro recording (→93, 95), Manual Focus (→96)

**Control dial**

Turn the dial to select setting items and change setting values. (→33, 52, 60)

- In this manual, the button that is to be used is indicated by ▲ ▼ ◀ ▶.

## Putting on the hand strap

We recommend using the supplied hand strap to avoid dropping the camera.

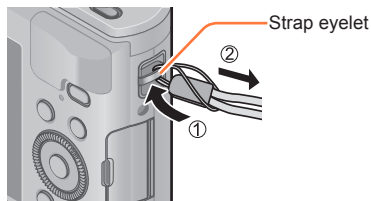

## Charging battery

Always use the dedicated AC adaptor (supplied), USB connection cable (supplied), and battery for this camera.

- **Always charge before first use!** (battery shipped uncharged)
- Charge the battery while it is in the camera.

Camera status	Charge
Turn off	Yes
Turn on	No

### ■ About batteries that you can use with this unit

It has been found that counterfeit battery packs which look very similar to the genuine products are made available to purchase in some markets. Some of these battery packs are not adequately provided with internal protection to meet the requirements of appropriate safety standards. There is a possibility that these battery packs may lead to fire or explosion. Please be advised that we are not liable for any accident or failure occurring as a result of use of a counterfeit battery pack. To ensure that safe products are used we recommend that a genuine Panasonic battery pack is used.

### ■ Power supply

By using the AC adaptor (supplied) when the battery is in the unit and turning on the unit, the unit can be powered from an electrical outlet through the USB connection cable (supplied).

- **The battery may become drained during recording. If the battery is drained, the unit will turn off.**
- The unit can be powered only if the battery is in it.
- Turn off the unit before inserting or removing the AC adaptor (supplied).

## Inserting the battery

To charge the battery, insert it into the camera.

- 1 Slide the release lever to the [OPEN] position and open the card/battery door**

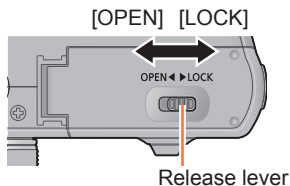

- 2 Insert the battery all the way**
  - Insert the battery all the way firmly and check that it is locked by lever.



- 3 Close the card/battery door and then slide the release lever to the [LOCK] position**



### ■ To remove battery

Move the lever in the card/battery compartment in the direction of the arrow.

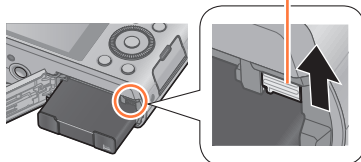

- Always use genuine Panasonic batteries.
- If you use other batteries, we cannot guarantee the quality of this product.
- **Remove battery from camera after use.**
  - Keep the battery in a plastic bag, making sure that it is kept away from metallic objects (such as clips) when carrying or storing it.
- To remove the battery, turn the camera off and wait until the LUMIX indicator on the screen goes off. (Failure to wait may cause the camera to malfunction and may damage the card or recorded data.)

## Charging the battery

We recommend charging in a location where the ambient temperature is between 10 °C and 30 °C (50 °F to 86 °F) (same for the battery temperature).

**Make sure that the camera is turned off.**

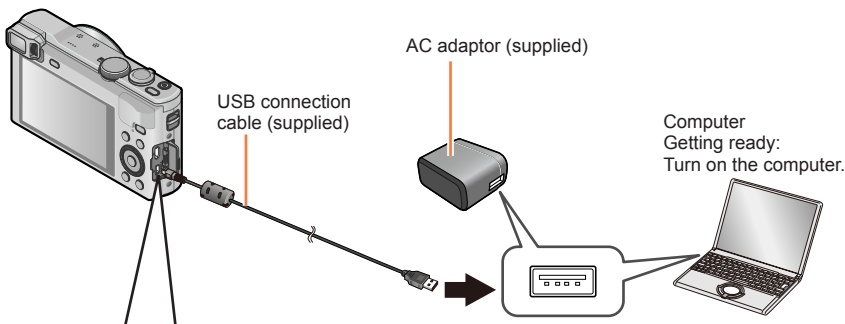

**When charging the camera, connect the USB connection cable (supplied) to the [AV OUT/DIGITAL] socket (gold terminal).**

[AV OUT/DIGITAL] socket

- Place the camera in an upright position, and find the gold terminal at the bottom.

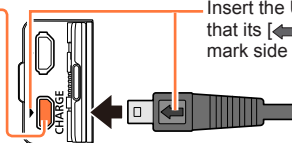

Insert the USB connection cable so that its [←] mark will face the [→] mark side of the camera.

- Always check the direction of the pins and hold the plug straight to insert or remove it. (If the cable is inserted in the wrong direction, the pins could become deformed and cause faulty operation.)
- Also, do not insert into the wrong socket. Doing so may cause damage to this unit.

### ■ Charging the battery by connecting the camera to the electrical outlet

Connect the AC adaptor (supplied) and the camera using the USB connection cable (supplied), and plug the AC adaptor into the electrical outlet.

- Be sure to only use the AC adaptor (supplied) indoors.

### ■ Charging the battery through the computer

Connect the camera to the USB connector of a computer using the USB connection cable (supplied).

- If the computer enters sleep mode during charging, charging may be stopped.
- If a notebook computer that is not connected to an electrical outlet is connected to the camera, the battery of the notebook computer will be depleted. Do not leave the camera and notebook connected for a long period of time.
- Always connect the USB connection cable to the USB connector on your computer. Do not connect the USB connection cable to the USB connector of the monitor, keyboard, printer, or USB hub.

### ■ Charging lamp indications

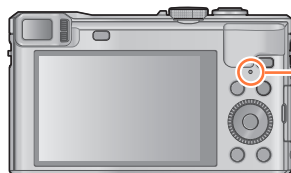

#### Charging lamp (Red)

On: Charging in progress

Off: Charging stops

(After charging stops, disconnect the camera from the electrical outlet or your computer.)

Flashing: Charging error

(For instructions on correcting the problem, refer to (→304).)

### ■ Notes on charging time

When using the AC adaptor (supplied)

Charging time	Approx. 170 min
<ul style="list-style-type: none"> <li>• The charging time indicated above is the time required for charging in case when the battery is completely used up. The time required for charging differs depending on conditions of battery usage. Charging takes longer in cases when temperatures are either high or low and when the battery has not been used for a long period of time.</li> <li>• The time required for charging through the computer varies depending on the power supply capacity of the computer.</li> </ul>	



- Do not use any other USB connection cables except the supplied one or a genuine Panasonic USB connection cable (optional). Doing so may cause malfunction of the camera.
- Do not use any other AC adaptors except the supplied one.
- Do not use a USB extension cable.
- The AC adaptor (supplied) and the USB connection cable (supplied) are dedicated accessories of this camera. Do not use them for other devices.
- If there is any trouble related to the electrical outlet (i.e. power failure), charging may not complete properly. Disconnect the USB connection cable (supplied) and reconnect it to the camera.
- If the charging lamp does not light even when the camera is connected to the AC adaptor (supplied) or a computer, check to make sure it is properly connected. (→19)
- If you try to recharge the battery when it is already fully charged, the charging lamp will light for approximately 15 seconds.

## Remaining battery

When using the camera, the remaining battery capacity is displayed.



### Remaining battery



If the battery mark flashes red, recharge or replace battery.

## Guidelines for number of recordable pictures and operating time

**The operating times and number of recordable pictures will differ according to the environment and the operating conditions.**

For example, in the following cases, the operating times shorten and the number of recordable pictures is reduced.

- In low-temperature environments, such as on ski slopes.
- When using [Monitor Luminance].
- When operations such as flash and zoom are used repeatedly.
- When the GPS function is operating.

## ■ Recording still pictures (When using LCD monitor)

Number of recordable pictures	Approx. 300 pictures	By CIPA standard
Recording time	Approx. 150 min	

### ● Recording conditions by CIPA standard

CIPA is an abbreviation of "Camera & Imaging Products Association".

- [Program AE] Mode
- Temperature: 23 °C (73.4 °F)/Humidity: 50%RH when LCD monitor is on.
- [GPS Setting] is set to [OFF]
- Using a Panasonic SDHC Memory Card.
- Using the supplied battery.
- Starting recording 30 seconds after the camera is turned on (when [Stabilizer] is set to [ON]).
- Recording once every 30 seconds with full flash every second recording.
- Rotating the zoom lever from Tele to Wide or vice versa in every recording.
- Turning the camera off every 10 recordings and leaving it until the temperature of the battery decreases.

Number reduced if intervals are longer (e.g. to approx. one quarter for 2-minute intervals under the above conditions).

## ■ Recording motion pictures (When using LCD monitor)

[Rec Format]	[AVCHD]		[MP4]
[Rec Quality]	[FHD/50p]	[FHD/50i]	[FHD/25p]
Available recording time	Approx. 75 min	Approx. 80 min	Approx. 90 min
Actual available recording time*	Approx. 30 min	Approx. 35 min	Approx. 40 min

\* The time you can actually record when repeatedly turning the camera on and off, starting and stopping recording and using zoom.

### ● Recording conditions

- Temperature 23 °C (73.4 °F), humidity 50%RH
- [GPS Setting] is set to [OFF]

#### ● Remaining time for continuous recording is displayed on the screen

- You can continuously record a motion picture in [MP4] for up to 29 minutes 59 seconds or approx. 4 GB. (Since recording in [MP4] with [FHD/25p] creates larger files, the recording time for such motion pictures will be shorter than 29 minutes 59 seconds.)
- You can continuously record [AVCHD] motion pictures for up to 29 minutes 59 seconds.

## ■ Viewing pictures (When using LCD monitor)

Playback time	Approx. 210 min
---------------	-----------------

- If available battery power is significantly reduced, battery is reaching end of lifespan. Please purchase a new battery.

## Inserting and removing the card (optional)

- Make sure that the camera is turned off.

**1** Slide the release lever to the [OPEN] position and open the card/battery door

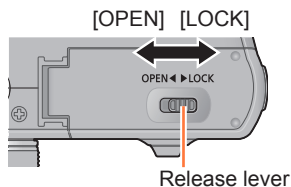

**2** Insert the card all the way  
• Push in until it clicks.



Card (Check orientation)

**3** Close the card/battery door and then slide the release lever to the [LOCK] position

### ■ To remove card

Press the centre of the card

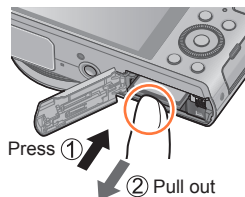

Do not touch the terminals on the back of the card.

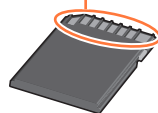

- Keep the Memory Card out of reach of children to prevent swallowing.
- To remove the card, turn the camera off and wait until the LUMIX indicator on the screen goes off. (Failure to wait may cause the camera to malfunction and may damage the card or recorded data.)

## Saving your pictures (cards and built-in memory)

Pictures will be saved to a card if one is inserted, or to the built-in memory [iM] if not.

### ■ Built-in memory (approx. 12 MB)

- You can store only still pictures.
- **Pictures may be copied between cards and the built-in memory.** (→184)
- The access time for the built-in memory may be longer than the access time for a card.

### ■ Compatible memory cards (optional)

The following SD standard-based cards (Panasonic brand recommended) can be used.

Type of Card	Capacity	Notes
SD Memory Cards	8 MB – 2 GB	<ul style="list-style-type: none"> <li>• Can be used with devices compatible with the respective formats.</li> <li>• Before using SDXC Memory Cards, check that your computer and other devices support this type of card. <a href="http://panasonic.net/avc/sdcard/information/SDXC.html">http://panasonic.net/avc/sdcard/information/SDXC.html</a></li> <li>• <b>Use a card of SD Speed “Class 4”* or higher for recording motion pictures.</b></li> <li>• Only the cards listed on the left with the given capacities are supported.</li> </ul>
SDHC Memory Cards	4 GB – 32 GB	
SDXC Memory Cards	48 GB, 64 GB	

\* SD speed class refers to a specification for sustained write speeds. Confirm the SD speed by checking the card label or other card related materials.

(Example)



- Latest information:  
<http://panasonic.jp/support/global/cs/dsc/>  
(This site is available in English only.)

- While the camera is accessing the card or built-in memory (for an operation such as picture writing, reading, deleting, or formatting), do not turn off the camera or remove the battery, card, AC adaptor (supplied). Do not subject the camera to vibrations, impact, or static electricity. The card or the data on the card may be damaged, and this unit may no longer operate normally. If operation fails due to vibration, impact or static electricity, perform the operation again.
- Please reformat the card with this camera if it has already been formatted with a computer or another device. (→74)
- If the write-protect switch is set to “LOCK”, the card cannot be used to record or delete pictures, and it cannot be formatted.
- It is recommended that you copy important pictures to your computer (as electromagnetic waves, static electricity, or faults may cause data to be damaged).



## Recording capacity guidelines (pictures/recording time)

The number of pictures you can take and the recording time vary in proportion to card capacity (and depending on recording conditions and type of card).

Estimated remaining pictures or recording time capacity  
(switch with [Remaining Disp.] (→68))

Displayed when no card is inserted  
(pictures will be saved to built-in memory)



## ■ Recording picture capacity (still pictures)

When [Aspect Ratio] is set to [4:3] and [Quality] is set to [S]

[Picture Size]	Built-in memory	2 GB	32 GB	64 GB
18M	1	270	4420	8820
5M	3	650	10620	21490
0.3M	69	10050	162960	247150

- When the number of recordable pictures exceeds 99,999, “+99999” is displayed.

### ■ Recording time capacity (motion pictures)

([h], [m] and [s] indicate “hour”, “minute” and “second”.)

#### When [Rec Format] is [AVCHD]

[Rec Quality]	2 GB	32 GB	64 GB
[FHD/50p]	8m00s	2h31m00s	5h07m00s
[FHD/50i] / [HD/50p]	14m00s	4h10m00s	8h26m00s

#### When [Rec Format] is [MP4]

[Rec Quality]	2 GB	32 GB	64 GB
[FHD/25p]	12m00s	3h22m00s	6h50m00s
[HD/25p]	22m00s	6h27m00s	13h04m00s
[VGA/25p]	50m00s	14h12m00s	28h46m00s

- The time displayed in the table is the total time.

### ● Remaining time for continuous recording is displayed on the screen

- You can continuously record a motion picture in [MP4] for up to 29 minutes 59 seconds or approx. 4 GB. (Since recording in [MP4] with [FHD/25p] creates larger files, the recording time for such motion pictures will be shorter than 29 minutes 59 seconds.)
- You can continuously record [AVCHD] motion pictures for up to 29 minutes 59 seconds.

## Setting the clock

The clock is not set when the camera is shipped.

- Disconnect the unit from the AC adaptor (supplied).

### 1 Press the Camera [ON/OFF] button

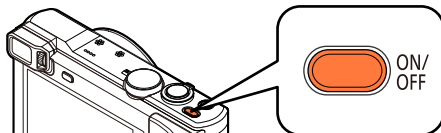

The camera is turned on.

If the language select screen is not displayed, proceed to step 4.

### 2 Press [MENU/SET] while the message is displayed

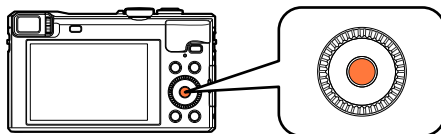

### 3 Press ▲ ▼ to select the language, and press [MENU/SET]

- The [Please set the clock] message appears.

### 4 Press [MENU/SET]

### 5 Press ◀ ▶ to select the items (year, month, day, hour, minute, display order or time display format), and press ▲ ▼ to set

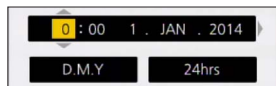

- To cancel → Press [Q.MENU/↵] button.

### 6 Press [MENU/SET] to set

### 7 Press [MENU/SET]

- To return to the previous screen, press [Q.MENU/↵] button.

(Continued on the next page)



## 8 Press ◀ to select [Yes] and press [MENU/SET] if automatically correcting time of day using the GPS function

- [GPS Setting] (→258) is set to [ON].
- To manually set date and time → Select [No], and press [MENU/SET].

## 9 When [Please set the home area] is displayed, press [MENU/SET]

## 10 Press ◀▶ to set your home area and press [MENU/SET]

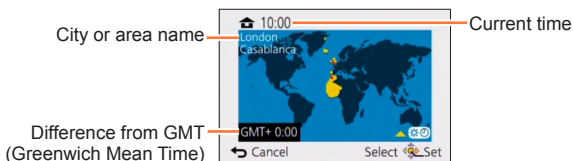

- If the time zone of your current location is different from that of [Home], [World Time] (→139) is set to [Destination]. ([✈]) will be displayed next to the time and date on the screen)

- If the clock is not set, the correct date cannot be printed when you order a photo studio to print the picture, or when you stamp the date on the pictures with [Date Stamp] or [Text Stamp].
- If the clock is set, the correct date can be printed even if the date is not displayed on the screen of the camera.

## Changing time settings

Select [Clock Set] from the [Setup] menu to change the current time settings.

- Clock settings will be saved for approx. 3 months even after the battery is removed, provided a fully charged battery was installed in the camera for 24 hours beforehand.

## 1 Select [Clock Set] from the [Setup] menu

- For details about how to set the menu (→60)

## 2 Set the date and time (Perform steps 5 - 6. (→28))

## Sequence of operations

1

Press the Camera [ON/OFF] button to turn on the camera

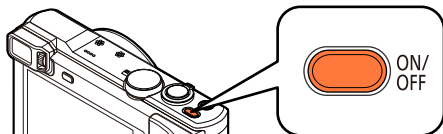

2

Set to the desired Recording Mode

Align the mode dial correctly to the mode that you want to use. →

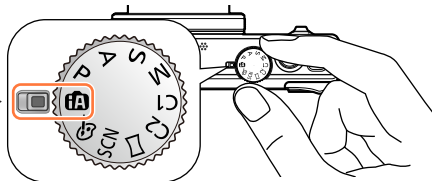

<b>iA</b>	<b>[Intelligent Auto] Mode</b>	Take pictures with automatic settings. (→35)
<b>P</b>	<b>[Program AE] Mode</b>	Take pictures with automatic shutter speed and aperture value settings. (→44)
<b>A</b>	<b>[Aperture-Priority] Mode</b>	Determine aperture, then record pictures. (→106)
<b>S</b>	<b>[Shutter-Priority] Mode</b>	Determine shutter speed, then record pictures. (→107)
<b>M</b>	<b>[Manual Exposure] Mode</b>	Determine aperture and shutter speed, then record pictures. (→108)
<b>C1</b> <b>C2</b>	<b>[Custom] Mode</b>	Record pictures using pre-registered settings. (→131)
	<b>[Panorama Shot] Mode</b>	Record panorama pictures. (→119)
<b>SCN</b>	<b>[Scene Mode]</b>	This allows you to take pictures that match the scene being recorded. (→123)
	<b>[Creative Control] Mode</b>	Take pictures by selecting your preferred picture effect. (→110)

(Continued on the next page)

## Aim the camera and shoot

### ■ Taking still pictures

- ① Press the shutter button halfway to focus
- ② Press the shutter button fully to take the picture

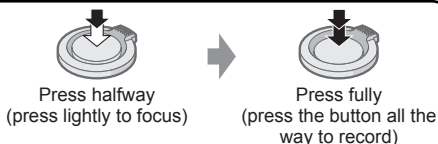
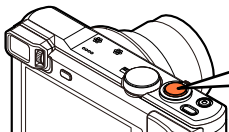

### ■ Recording motion pictures

- ① Press the motion picture button to start recording
- ② Press the motion picture button again to finish recording

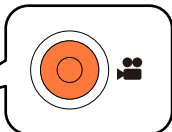
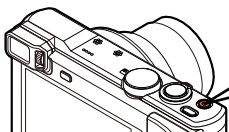

3

### ■ Holding the camera

Do not block the flash or the lamp.  
Do not look at it from close range.

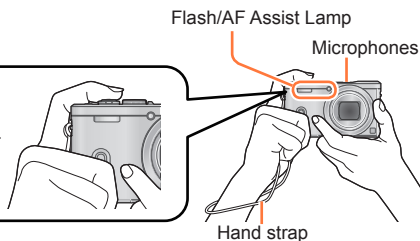

- To avoid camera shake, hold it with both hands keeping your arms close to your body while standing with your feet slightly apart.
  - Do not touch the lens.
  - Do not block the microphone when recording motion pictures.
  - Make sure that the camera does not move at the moment the shutter button is pressed.
- We recommend using the supplied hand strap to avoid dropping the camera.

(Continued on the next page)

## Play back pictures

① Press the Playback button

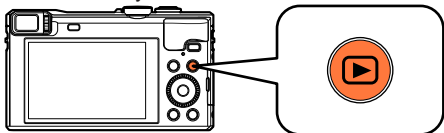

4 ② Press ◀▶ or turn the control dial to select the picture to be displayed

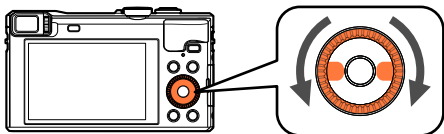

### ■ Viewing motion pictures

Select a picture with the motion picture icon, and press ▲.

## Press the Camera [ON/OFF] button to turn off the camera

5

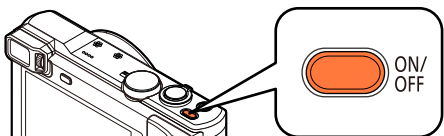

## Using the control ring/control dial

The “Control Ring/Control Dial” is an easy and convenient way to adjust several settings, depending on the camera mode selected. You can use the control ring (A)/control dial (B) to change the settings of the unit.

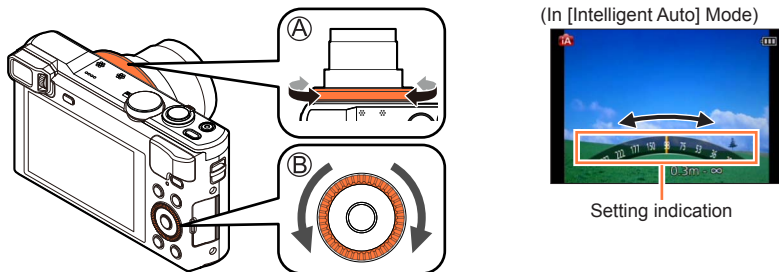

Items that can be set by the control ring/control dial vary depending on Recording Modes. Following are the pre-assigned settings.

Recording mode		Control ring*1	Control dial
iA	[Intelligent Auto] Mode	Q Step Zoom (→83)	
P	[Program AE] Mode	P/ Program Shift (→45)	
A	[Aperture-Priority] Mode	F Aperture adjustment (→106)	
S	[Shutter-Priority] Mode	SS Shutter speed adjustment (→107)	
M	[Manual Exposure] Mode	F Aperture adjustment (→108)	SS Shutter speed adjustment*2 (→108)
	[Panorama Shot] Mode	Picture effects change (→119)	
SCN	[Scene Mode]	SCN Scene change (→123)	
	[Creative Control] Mode	Picture effects change (→110)	

\*1 When Manual Focus is set, the control ring is assigned to focus adjustment. (→96)

\*2 Press ▲ to switch between aperture adjustment and shutter speed adjustment.

- The control ring/control dial can be used to change to your preferred settings. (→134)

Using Quick menu

During recording, you can easily call some of the menu items and set them.

**1** Press [Q.MENU/↵] button

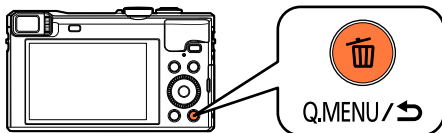

**2** Press ◀▶ to select menu items

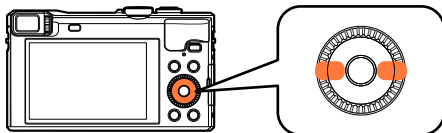

• The menu items and setting items that are displayed differ depending on the Recording Mode.

**3** Turn the control ring or control dial to change the setting

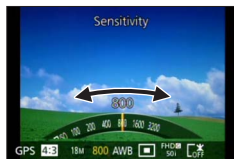
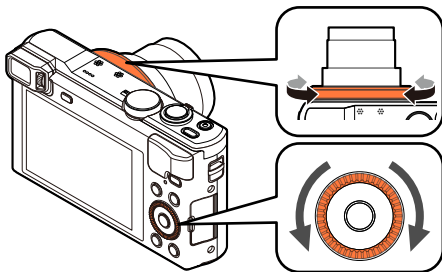

**4** Press [MENU/SET]

# Taking pictures with automatic settings

[Intelligent Auto] Mode

■ Recording mode: P A S M C1 C2 □ SCN

This mode is recommended for those who want to point and shoot or beginners as the camera optimises settings to match the subject and recording environment.

## 1 Set mode dial to ([Intelligent Auto] Mode)

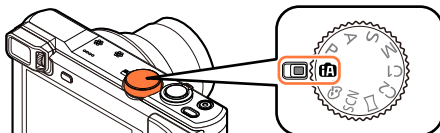

## 2 Take a picture

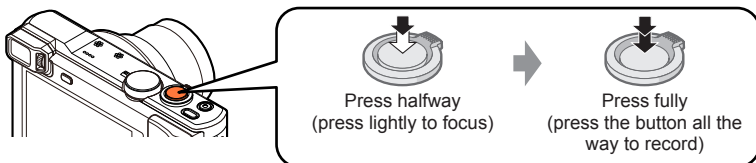

### Focus display

(When focus is aligned: illuminated  
When focus is not aligned: flashing)

### AF area

## Using flash

Press to select or .

- When is selected, the setting switches to , , , or according to the subject and brightness.
- When or is displayed, the [Red-Eye Removal] function is activated to automatically detect red-eye and correct the picture data.
- When or is selected, the shutter speed is reduced.

### Automatic Scene Detection

Camera reads scene when pointed at subject, and makes optimum settings automatically.

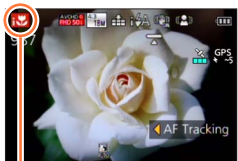

The icon of scene detected

When taking pictures

[i-Portrait]	[i-Night Portrait]*2 (Only when [i-IA] is selected)
[i-Baby]*1	
[i-Scenery]	[i-Night Scenery]*2
[i-Sunset]	[i-Handheld Night Shot]*3
[i-Food]	[i-Macro]
When scene does not correspond to any of the above	

When recording motion pictures (→48)

[i-Portrait]	[i-Low Light]*4
[i-Scenery]	[i-Macro]
When scene does not correspond to any of the above	

\*1 When children (that are registered in the camera with Face Recognition) under 3 years old are recognised.

\*2 We recommend using a tripod and the self-timer.

\*3 When [i-Handheld Night Shot] is [ON].

\*4 [i-Low Light] will be selected for nightscapes and other dark scenes.

- Depending on recording conditions, different scene types may be determined for the same subject.
- If desired scene type is not selected, we recommend manually selecting the appropriate Scene Mode.
- When [i-Portrait], [i-Baby] or [i-Night Portrait] is detected, Face Detection is activated, and the focus and exposure are adjusted for the recognised faces.

### ■ About Backlight Compensation

Backlight compensation is automatically activated in [Intelligent Auto] mode. Backlight is a condition where a light shines from behind a subject. When there is a backlight, the subject appears darker and the camera will automatically attempt to correct it by increasing the brightness of the picture. When the camera detects backlight, is displayed on the screen (depending on the backlighting conditions, backlighting may not be detected correctly).



### Defocusing the background

You can also use [Intelligent Auto] Mode to adjust background defocusing easily, as with in [Aperture-Priority] mode.

#### 1 Press ▲

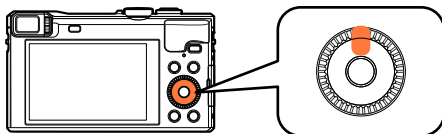

#### 2 Turn the control ring or control dial to adjust background defocusing

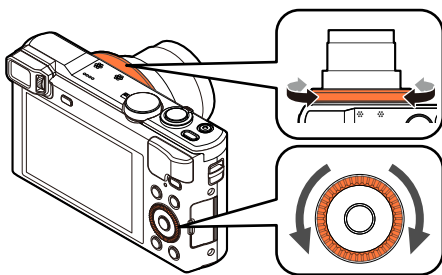

Defocus background condition	Defocus the background	↔	Focus the background
------------------------------	------------------------	---	----------------------

- [AUTO] is displayed in the icon during automatic adjustment.
- You can also make adjustments with ◀▶.
- To return to automatic adjustment → Press [Q.MENU/⏏] button.

#### 3 Press [MENU/SET]

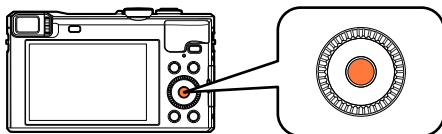

## Taking pictures with automatic settings [Intelligent Auto] Mode

- When you record motion pictures, the camera performs aperture control within the appropriate exposure range, and the background defocusing may not change for some subject brightness.
- You can use [Intelligent Auto Plus] Mode to adjust brightness and colouring. (→41)
- If the camera is turned off or the Recording Mode is changed, the background defocusing setting returns to [AUTO].

**[Motion Deblur]**

[Motion Deblur] automatically sets the optimum shutter speed in accordance with the movements of the subject to minimise the blur of the subject.

It is preset to [ON] with this unit.

**■ Settings**

- ① Press [MENU/SET]
- ② Press ▲▼◀▶ to select [Rec] menu and press [MENU/SET]
- ③ Press ▲▼ to select [Motion Deblur] and press [MENU/SET]
- ④ Press ▲▼ to select either [ON] or [OFF] and press [MENU/SET]

- When [Motion Deblur] is set to [ON], [👤] appears on the screen.
- The subject may be recorded in a picture size smaller than the number of pixels that has been set.

**[iHandheld Night Shot]**

If a night scene is detected automatically while the unit is being handheld, [iHandheld Night Shot] can record a still picture with less jitter and less noise without using a tripod by combining a burst of pictures.

It is preset to [ON] with this unit.

**■ Settings**

- ① Press [MENU/SET]
- ② Press ▲▼◀▶ to select [Rec] menu and press [MENU/SET]
- ③ Press ▲▼ to select [iHandheld Night Shot] and press [MENU/SET]
- ④ Press ▲▼ to select either [ON] or [OFF] and press [MENU/SET]

- When the camera is fixed in place on a tripod or by other means, [iHandheld Night Shot] will not be identified.
- The angle of view becomes narrow slightly.

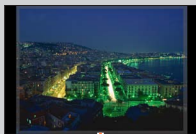

The portions displayed in grey are not recorded.

**[iHDR]**

When there is, for example, strong contrast between the background and the subject, [iHDR] records multiple still pictures with differing exposures and combines them to create a single still picture rich in gradation.

It is preset to [ON] with this unit.

**■ Settings**

- ① Press [MENU/SET]
- ② Press ▲▼◀▶ to select [Rec] menu and press [MENU/SET]
- ③ Press ▲▼ to select [iHDR] and press [MENU/SET]
- ④ Press ▲▼ to select either [ON] or [OFF] and press [MENU/SET]

- This function is automatically activated only when [📷] is displayed on the screen.
- In the case that a single picture is going to be composed from a burst, a message indicating that multiple pictures are to be recorded appears on the screen and burst recording is carried out. Note that burst recording will not take place if the camera determines that it can compensate for the difference in contrast without composing the picture from a burst.
- The camera does not combine pictures in the following cases:
  - When the zoom ratio exceeds the maximum optical zoom ratio
  - [Burst] mode
  - When the flash fires
- In the case of composition from a burst, afterimages may appear if the subject was moving.

## AF Tracking

This function enables the camera to continue to focus on the subject and adjust the exposure of the subject even when the subject is moving.

### 1 Press ◀ to set [AF Mode] to AF Tracking

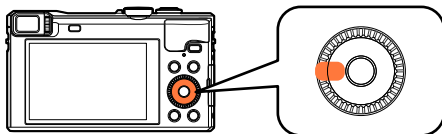

- To cancel AF Tracking → Press ◀.

### 2 Align the AF Tracking frame with the subject and press the shutter button halfway to lock

- To cancel AF Lock → Press [MENU/SET].

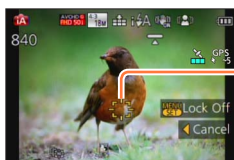

AF Tracking frame  
 (AF Lock successful: Yellow  
 AF Lock failed: Red)

- The optimal scene for the AF locked subject is automatically identified.
- Face Recognition will be inactive while using AF Tracking.
- Under certain recording conditions, such as when the subject is small or when it is dark, [AF Tracking] may not operate correctly.

## [Intelligent Auto Plus] Mode

When [Intelligent Auto Plus] (iA+) Mode is selected, you can easily adjust the brightness and colouring, in addition to the background defocusing, without compromising the user-friendly operation of the [Intelligent Auto] Mode.

### ■ Switching to [Intelligent Auto Plus] Mode

Use the [iA MODE] menu to switch the mode.

#### 1 Press [MENU/SET]

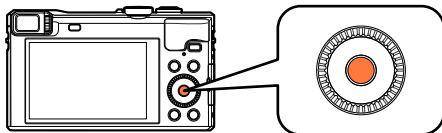

#### 2 Use ▲▼◀▶ to select [iA MODE] menu and press [MENU/SET]



#### 3 Use ◀▶ to select [Intelligent Auto Plus] and press [MENU/SET]

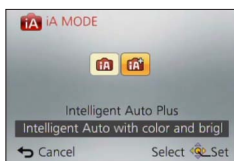

## ■ Adjusting brightness, colouring, and background defocusing

### 1 Press ▲

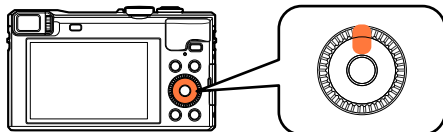

### 2 Press ▲ ▼ to select an item to adjust

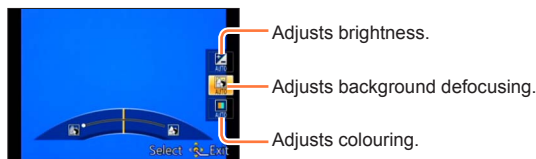

- [AUTO] is displayed in the icon during automatic adjustment.

### 3 Turn the control ring or control dial to adjust

Brightness	Underexposure (dark) ◀▶	Overexposure (bright)
Defocus background condition	Defocus the background ◀▶	Focus the background
Colouring	Warm colours ◀▶	Cool colours

- You can also make adjustments with ◀▶.
- To return to automatic adjustment → Press [Q.MENU/↵] button.

### 4 Press [MENU/SET]

- When you record motion pictures, the camera performs aperture control within the appropriate exposure range, and the background defocusing may not change for some subject brightness levels.
- If the camera is turned off or the Recording Mode is changed, the background defocusing and colouring settings return to [AUTO].
- When you set [Exposure Comp. Reset] to [ON] in the [Setup] menu, the brightness setting returns to [AUTO] if you turn off the camera or change the Recording Mode. (→70)

### About [Intelligent Auto] setting items

Only the menu items which are displayed in the [Intelligent Auto] Mode can be set. The settings selected in the [Program AE] or other modes will reflect on the menu items in the [Setup] menu that are not displayed.

- The settings for the following items are different from other Recording Modes:





- [Picture Size] on the [Rec] menu
- [Beep] on the [Setup] menu ([Beep Level] and [Shutter Vol.] only)

- The settings for the following functions are fixed:

[Setup] menu

- [Fn Button Set]: [Composition Guide]
- [Auto Power Off]: [5MIN.]
- [Auto Review]: [2SEC]

[Rec] menu

- [Quality]:  ([Fine])
- [White Balance]: [AWB]
- [Quick AF]: [ON]
- [i.Exposure]: [ON]
- [AF Assist Lamp]: [ON]
- [Stabilizer]: [ON]
- [Sensitivity]: [ Iso]
- [AF Mode]: [] ([Face Detection])  
 (23-area-focusing) when face cannot be recognised
- [Metering Mode]: [] ([Multi Metering])
- [i.Resolution]: [ON]
- [i.Zoom]: [ON]
- [Red-Eye Removal]: [ON]

[Motion Picture] menu

- [Continuous AF]: [ON]
- [Wind Cut]: [AUTO]

- The following functions cannot be used:

[Histogram], [Video Rec Area], [Exposure Comp.], [Auto Bracket], [WB Adjust.], [Min. Shtr Speed], [Digital Zoom]

# Taking pictures with your own settings

[Program AE] Mode

■ Recording mode: **P** A S M

Take pictures with automatic shutter speed and aperture value settings.  
Using the [Rec] menu to change settings and set up your own recording environment.

## 1 Set mode dial to [P] ([Program AE] Mode)

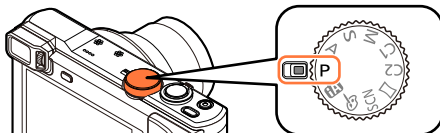

## 2 Take a picture

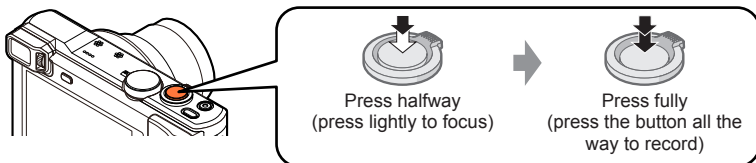

- If a warning is displayed about jitter, use [Stabilizer], a tripod, or [Self Timer].
- If aperture and shutter speed are shown in red, you do not have appropriate exposure. You should either use the flash, change [Sensitivity] settings or set [Min. Shtr Speed] to a slower speed.

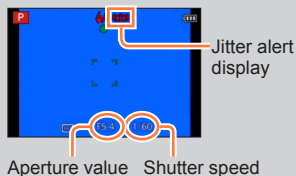



## Programme Shift

The function for maintaining the same exposure (brightness) while changing the shutter speed and aperture value combination is called "Programme Shift". You can use "Programme Shift" to take pictures by adjusting the shutter speed and aperture value even in [Program AE] Mode.

### 1 Press the shutter button halfway

- The shutter speed and aperture value are displayed in yellow on the screen.

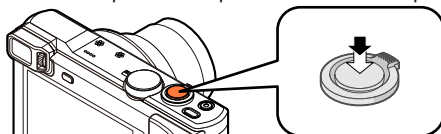

### 2 While the numeric values are being displayed in yellow (approximately 10 seconds), turn the control ring or control dial to select the combination of shutter speed and aperture value

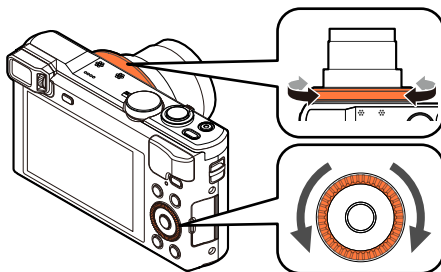

#### Exposure meter

Shutter speed (Automatic adjustment)



Aperture value (Automatic adjustment)

[P] is displayed during Programme Shift (while the combination of a shutter speed and aperture value is being changed).

- To cancel Programme Shift
  - Turn the control ring or control dial until [P] (Programme Shift indication) disappears.

- When the camera is turned off, Programme Shift is cancelled.
- Programme Shift is cancelled if more than 10 seconds pass after Programme Shift is activated. However, the Programme Shift setting is memorised.
- Depending on the brightness of the subject, Programme Shift may not be activated.
- Programme Shift cannot be used in the following cases:
  - When recording motion pictures
  - When [Sensitivity] is set to [ISO]

### ■ Example of Programme Shift

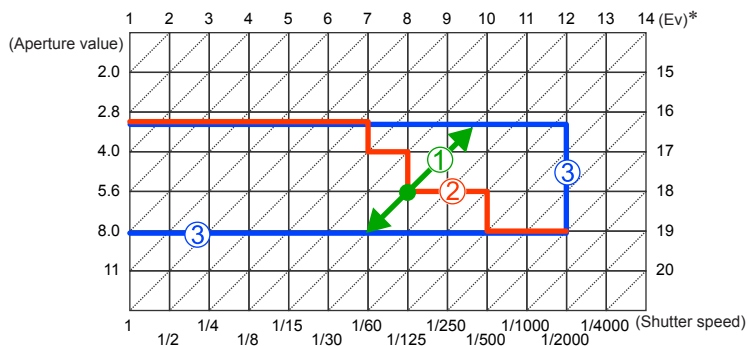

- ① Programme Shift amount
- ② Programme Shift diagram
- ③ Programme Shift limit

\* EV is an abbreviation of [Exposure Value], a unit indicating the amount of exposure. The EV changes with the aperture value or the shutter speed.

## Adjusting focus

When [AF Mode] is set to [□] (1-area-focusing), focus on the AF area in the centre of the picture. If a subject you want to record is not in the centre, follow the steps below.

### 1 Adjust focus according to subject

Align the AF area with the subject



Hold down halfway



**Focus display**

(When focus is aligned: illuminated  
When focus is not aligned: flashing)

**AF area**

(When focus is aligned: green  
When focus is not aligned: red)

### 2 Return to desired composition



Press fully



AF area

- Subjects/environments which may make focusing difficult:
  - Fast-moving or extremely bright objects, or objects with no colour contrast.
  - Taking pictures through glass or near objects emitting light.
  - In the dark, or with significant jitter.
  - When too close to object or when taking pictures of both distant and close objects together in the same picture.
- The focus display flashes and beep sounds when focus is not aligned.  
Use the focus range displayed in red as a reference.  
Even if the focus display is lit, the camera may be unable to bring the subject into focus if it is out of range.
- The AF area display may be larger depending on recording conditions such as dark locations or zoom ratio.
- The quality of the picture display may be lower during Auto Focus.

Focus display



Focus range

## Recording motion pictures

■ Recording mode:

You can record motion pictures with audio (stereo).

- Motion pictures cannot be recorded in the built-in memory.

### 1 Press the motion picture button to start recording

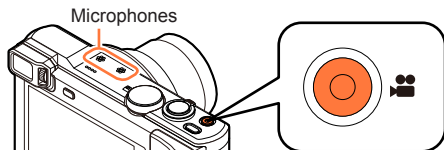

- Do not block the microphones when recording motion pictures.
- Immediately release the motion picture button after pressing it.
- You can record motion pictures fitting each Recording Mode.
- You can also use zoom while recording motion pictures.
  - The zoom speed will be slower than normal.
  - The operating sounds of the zoom lever or control ring/control dial may be recorded in some cases.
- Still pictures can be taken during motion picture recording. (→51)

[Rec Format] (→152)  
[Rec Quality] (→152)



Elapsed recording time

Remaining recording time (approx.)

### 2 Press the motion picture button again to end recording

**■ About the recording format for recording motion pictures**

This unit can record motion pictures in either AVCHD or MP4 formats.

**AVCHD:**

You can record high definition quality images with this format. It is suitable for viewing motion pictures on a high-resolution TV or for saving them to a disc.

**AVCHD Progressive:**

The [50p] in [FHD] is a mode that allows motion pictures to be recorded at 1920 x 1080/50p, the highest quality\* that complies with the AVCHD standard.

Recorded motion pictures can be saved and played back using this unit or "PHOTOfunSTUDIO".

\*This means the highest quality for this unit.

**MP4:**

This is a simpler video format best used when extensive editing is needed, or when uploading videos to WEB services.

**■ About the compatibility of the recorded motion pictures**

Motion pictures recorded in [AVCHD] or [MP4] may be played back with poor picture or sound quality or playback may not be possible even when played back with equipment compatible with these formats. Also, the recording information may not be displayed properly. In this case, use this unit.

- Motion pictures recorded with [50p] in [FHD] can be played back on equipment that is compatible with AVCHD Progressive.
- AVCHD motion pictures recorded with the picture quality that has the [G] icon may not play back even on compatible equipment. Record without the [G] motion picture quality setting to prioritise playback on other equipment.

- If the surrounding temperature is high, or a motion picture is recorded continuously, [△] is displayed and recording may be stopped halfway through to protect the camera.
- When using zoom while recording motion pictures, it may take some time to focus.
- Depending on the environment when recording motion pictures, the screen may turn black for an instant or noise may be recorded because of static electricity, electromagnetic waves, etc.
- The available recording time displayed on the screen may not decrease regularly.
- If data is repeatedly recorded and deleted, the total available recording time on the card may be reduced. To restore the original capacity, use the camera to format the card. Be sure to save all important data to your computer or other media before formatting, as all data saved to the card will be erased.
- [Stabilizer] functions regardless of the settings before a motion picture is recorded.
- The following functions are not available:  
Extra optical zoom, flash, [Face Recog.], [Rotate Disp.] for pictures taken vertically.
- For certain memory cards, recording may end while in progress.
- The recording range may become narrower in motion pictures compared to still pictures. Also, if the aspect ratio is different for still pictures and motion pictures, the angle of view will change when starting to record a motion picture. The recordable area is displayed by setting [Video Rec Area] (→67) to [ON].
- If Extra optical zoom is used before pressing the motion picture button, these settings will be cleared, and the recordable area will be changed significantly.
- [Sensitivity] is set automatically while a motion picture is being recorded. Also [ISO Limit Set] is disabled.
- Motion pictures cannot be recorded in the following cases:
  - [3D Photo Mode] Scene Mode
  - [Creative Control] Mode ([Soft Focus], [Star Filter])
- It will be recorded in the following categories for certain Recording Modes. A motion picture recording matching each Recording Mode will be performed for the ones not listed below.

Selected Recording Mode	Recording Mode while recording motion picture
<ul style="list-style-type: none"> <li>• [Program AE] Mode</li> <li>• [Aperture-Priority] Mode</li> <li>• [Shutter-Priority] Mode</li> <li>• [Manual Exposure] Mode</li> <li>• Scene Modes ([Sports], [HDR], [Pet])</li> </ul>	Normal motion picture
[Baby] Scene Mode	Portrait Mode
Scene Modes ([Night Portrait], [Night Scenery], [Handheld Night Shot], [Starry Sky])	Low Light Mode

### Taking still pictures while a motion picture is being recorded

Still pictures can be recorded even while a motion picture is being recorded.

## 1 Press the shutter button fully during the motion picture recording

Still pictures can be taken while a motion picture is being recorded.

[Still Picture Size] (→153)	Maximum number of pictures
13.5M	10 pictures
6M	
2M	

- The clicking sound made when the shutter button is operated may be recorded.
- When still pictures are recorded during zooming, the zooming may stop.
- Using [Miniature Effect] in [Creative Control] Mode, a still picture may be taken with a slight delay from the time when the shutter button is pressed fully.

## ■ Burst function

When the burst function has been set in advance, a burst of still pictures can be recorded during motion picture recording.

- When the burst setting is set to [40], [60] or [3], still pictures are automatically recorded using the [10] setting.
- Even at the [2AF] or [5AF] setting, the focus is fixed at the first picture.

- When you press the shutter button halfway during motion picture recording, the camera will automatically refocus on a subject. This refocus movement is recorded even during motion picture recording. When priority is to be given to the motion picture videos, press the shutter button fully, and record the still pictures. Still pictures can also be created after motion picture recording. (→57)
- When the shutter button is pressed halfway, the picture size and the number of recordable pictures are displayed.
- Still pictures cannot be recorded in the following cases:
  - When [Rec Quality] is set to [VGA/25p]
  - When recording [High Speed Video]
- The flash is set to [☹] ([Forced Flash Off]).
- Since the electronic shutter is used for recording, the pictures recorded may be distorted.
- Compared to normal still picture recording, the picture quality may be coarser.
- When [Quality] is set to [RAW], [RAW] or [RAW], still pictures are recorded with the [📷] setting in JPEG file format.

## Viewing your pictures

When a card is in the camera, pictures are played back from the card. Without a card, pictures are played back from the built-in memory.

### 1 Press the Playback button

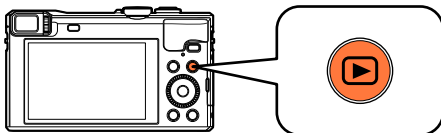

- By holding down the Playback button while the camera is off, you can turn the camera on in Playback Mode.

### 2 Press ◀▶ or turn the control dial to select the picture to be displayed

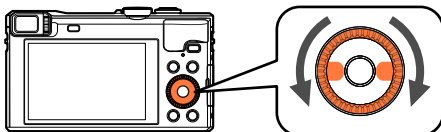

- When you press and hold ◀▶, the pictures are displayed one after another.

### 3 View pictures



Picture number/Total pictures

Location name information and latitude & longitude information are provided (→170, 260)

Folder/File number

### Ending Playback

Press the Playback button or the Motion picture button again, or press the shutter button halfway.

- It may not be possible to view pictures on this camera that were previously edited on a computer.
- When the camera is switched to Playback Mode, the lens barrel will be retracted after approx. 15 seconds.
- This camera is compliant with the unified DCF (Design rule for Camera File system) standard formulated by the Japan Electronics and Information Technology Industries Association (JEITA), and with Exif (Exchangeable image file format). Files that are not DCF-compliant cannot be played back.

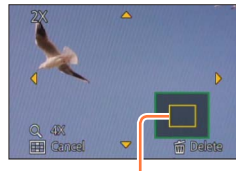
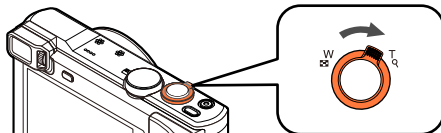

## Zooming in and viewing "Playback Zoom"

**1** Move the zoom lever toward T side

Current zoom position

- Each time you move the zoom lever toward the T side, the magnification increases through four levels: 2x, 4x, 8x, and 16x. (The picture quality displayed becomes successively lower.)
- To reduce zoom → Move the zoom lever toward W side.
- Move zoom position → Press ▲▼◀▶.

- Playback zoom cannot be used during motion picture playback, automatic scrolling playback of panorama pictures or burst playback.

## Viewing a list of pictures “Multi Playback”

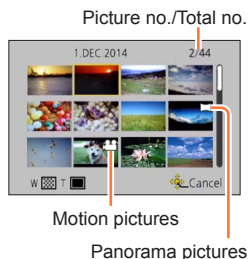
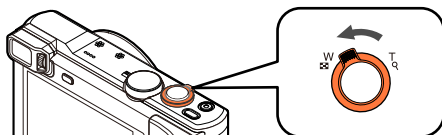
**1** Move the zoom lever toward W side

- Move the zoom lever toward the W side and you can switch the display methods in the following order: 1-picture screen (full-screen) → 12-picture screen → 30-picture screen → Calendar screen. (Move the lever to the T side to return.)
- When you select a picture using the cursor button and press [MENU/SET] on the 12-picture or 30-picture screen, the selected picture is displayed on the 1-picture screen (full-screen).
- Pictures can also be selected with the control dial.

● Pictures displayed with [!] cannot be played back.

## Searching and viewing pictures by their recording date [Calendar]

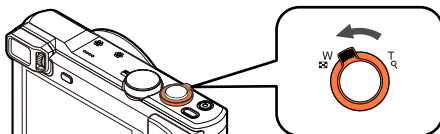
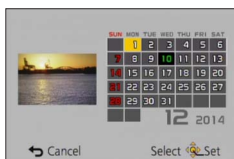
**1** Move the zoom lever toward W side several times**2** Use ▲ ▼ ◀ ▶ to select recording date and press [MENU/SET]

- Pictures are displayed in Multi Playback (30-picture screen). The cursor will appear on the first picture taken on the selected date.
- You can also select the date with the control dial.

- Only months when pictures were taken are shown on the calendar screen. Pictures taken without clock settings are displayed with the date 1st January, 2014.
- Pictures taken with destination settings made in [World Time] are displayed in the calendar screen using the appropriate date for the destination's time zone.

## Viewing motion pictures

This unit was designed to play motion pictures using the AVCHD, MP4 and QuickTime Motion JPEG formats.

### 1 Select a picture with the motion picture icon, and press ▲

Playback now starts.

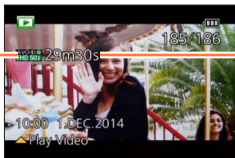

Motion picture recording time

Example: After 29 minutes and 30 seconds: [29m30s]

- When playback starts, the elapsed playback time is displayed in the top right of the screen.

Motion picture icon (differs by [Rec Format] and [Rec Quality])

### ■ Operations during motion picture playback

▲: Pause/play

▼: Stop

◀: Fast rewind (2 steps\*1)/Single-frame rewind (while paused)

▶: Fast forward (2 steps\*1)/Single-frame forward (while paused)

[MENU/SET]: Capturing still pictures from motion pictures (while paused) (→57)

\*1 The fast forward or rewind speed increases if you press ◀▶ again.

- You can also perform these operations with the control dial.

Fast rewind (2 steps\*2)/  
Single-frame rewind  
(while paused)

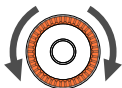

Fast forward (2 steps\*2)/  
Single-frame forward  
(while paused)

\*2 The fast forward or rewind speed increases if you turn the control dial again.

- If ▲ is pressed during fast forward or rewind, it will return to normal playback speed.
- Volume can be adjusted with the zoom lever.

- It may not be possible to properly play back the motion pictures recorded using other cameras.
- Some information will not be displayed for motion pictures recorded in [AVCHD].
- Motion pictures can be viewed on your computer using "PHOTOfunSTUDIO" on the supplied CD-ROM.
- Motion pictures recorded with [Miniature Effect] in [Creative Control] Mode play back at approximately 8x speed.

### Capturing still pictures from motion pictures

Save a scene from a motion picture as a still picture.

**1** Display the picture that you want to capture as a still picture by pausing a motion picture during playback

**2** Press [MENU/SET]



- A confirmation screen is displayed. Select [Yes] and press [MENU/SET].

- Still pictures are saved with [Aspect Ratio] setting of [16:9] and [Picture Size] at 2M\*.

\* In the following cases, saved pictures become [4:3], 0.3M.

- MP4 motion pictures with [Rec Quality] of [VGA/25p]
- High-speed motion pictures with [Recording Speed] of [200fps]

- The picture quality becomes slightly lower depending on the [Rec Quality] setting of the original motion picture.
- It may not be possible to capture still pictures from motion pictures that were recorded with a different camera.

## Deleting pictures

Pictures will be deleted from the card if the card is inserted, or from the built-in memory if the card is not inserted. (Deleted pictures cannot be recovered.)

However, pictures will not be deleted in the following cases:

- Protected pictures
- Card switch is in "LOCK" position.
- Pictures that are not based on the DCF standard (→52)

### 1 Press [🗑️] button to delete displayed picture

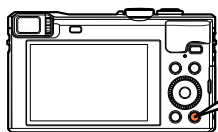

- A confirmation screen is displayed. Select [Yes] and press [MENU/SET].

- Do not turn off the camera while deleting.

### To delete multiple (up to 100)/To delete all pictures

A picture group (→157) is handled as 1 picture. (All the pictures in the selected picture group are deleted.)

#### 1 Press [🗑️] button while viewing a picture

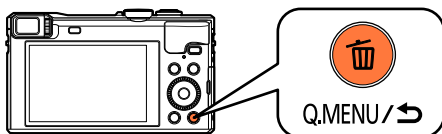

#### 2 Use ▲▼ to select [Delete Multi]/[Delete All] and press [MENU/SET]

- Items can also be selected by turning the control dial.



##### ● [Delete Multi]

Use ▲▼◀▶ to select picture and press [DISP.] button

 Picture selected

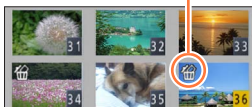

- To cancel → Press [DISP.] button again.
- To execute → Press [MENU/SET].
- Pictures can also be selected with the control dial.
- You can select [All Delete Except Favorite] in [Delete All] if there are pictures that have been set as [Favorite] (→180).
- A confirmation screen is displayed. Select [Yes] and press [MENU/SET].
- May take time depending on number of pictures deleted.

## Setting the menu

Refer to the procedure below for an example on how to operate the menus.

**Example: Changing [AF Mode] in the [Rec] menu in [Program AE] Mode**

### 1 Press [MENU/SET]

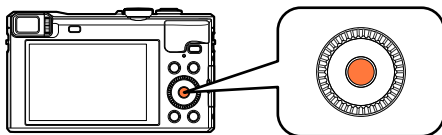

### 2 Press ▲▼◀▶ or turn the control dial to select the [Rec] menu, and press [MENU/SET]

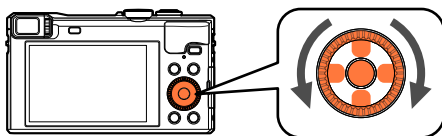

### 3 Press ▲▼ or turn the control dial to select [AF Mode], and press [MENU/SET]

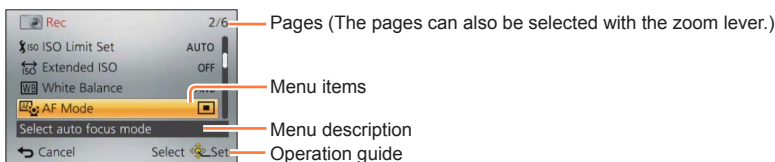

### 4 Press ▲▼ or turn the control dial to select a setting, and press [MENU/SET]

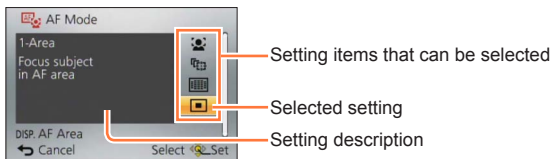

### 5 Press [Q.MENU/↵] button several times

The menu closes and the previous screen reappears.

- In Recording Mode, the menu screen can also be exited by pressing the shutter button halfway.



## Menu type

## ● In Recording Mode



## ● In Playback Mode



<b>[Rec]</b>	You can perform settings such as tones, Sensitivity, Aspect Ratio, and Picture Size.
<b>[Motion Picture]</b>	You can select the recording format and picture quality and other settings.
<b>[GPS]</b>	You can select the GPS setting, location name display and other settings.
<b>[Setup]</b>	You can perform settings for convenience of use such as the clock setting and changing of the beep sounds.
<b>[Wi-Fi]</b>	You can perform settings required to use a Wi-Fi connection and Wi-Fi functions.
<b>[Playback Mode]</b>	You can choose the playback method to see [Slide Show] or to narrow down the pictures for display, etc.
<b>[Playback]</b>	You can specify picture protection, resizing, print settings, and other settings for pictures you have taken.

- The menu types and items that are displayed vary according to the mode.
- The setting methods vary depending on the menu item.
- The following menus are also displayed depending on the Recording Mode.
  - In the [Intelligent Auto] mode: [iA MODE] menu (→41)
  - In the [Creative Control] mode: [Creative Control] menu (→110)
  - In the [Scene Mode]: [Scene Mode] menu (→123)
  - In the [Custom] mode: [Custom] menu (→132)

## Using the [Setup] menu

**[Clock Set], [Economy] and [Auto Review] are important for clock setting and battery life. Please check these before use.**

- For the setting procedures of the menu. ([→60](#))

- In [Intelligent Auto] Mode, only [Clock Set], [World Time], [Airplane Mode], [Beep], [Composition Guide] and [Language] are set.

### [Clock Set]

Set time, date, and display format. ([→29](#))

### [Auto Clock Set]

Setting the clock automatically using GPS. ([→265](#))

### [World Time]

Set the local time at travel destination. ([→139](#))

### [Travel Date]

Record the number of days elapsed in your travels. ([→138](#))

### [Airplane Mode]

Disable the Wi-Fi function. ([→187](#))

Disable the GPS function. ([→264](#))

- For the setting procedures of the menu. (→60)

## [Beep]

Change or mute the beep/shutter sounds.

### ● [Beep Level]

- Settings: ([Low]) / ([High]) / ([OFF])

### ● [Beep Tone]

- Settings: 1 / 2 / 3

### ● [Shutter Vol.]

- Settings: ([Low]) / ([High]) / ([OFF])

### ● [Shutter Tone]

- Settings: 1 / 2 / 3

## ■ Beep sounds when operating the control ring

Beep sounds are audible when turning the control ring.

Regardless of the [Beep Level] setting, no beep sounds are audible in the following cases:

- When recording motion pictures
- When Manual Focus is used to adjust focus
- During zoom operation (excluding [Step Zoom])

- Changing the [Beep Tone] setting does not change the beep tones produced by the control ring.

- For the setting procedures of the menu. (→60)

#### [Cust.Set Mem.]

Register the current camera settings. (→131)



#### [Fn Button Set]

Register frequently used functions from the [Rec] menu, [Setup] menu or other menus to the [Fn] button for faster operation. (→133)

#### [Zoom Lever Set]

Switches the zoom lever operation setting. (→83)

#### ■ Settings

 [Zoom]	The zoom operates in the normal way.
 [Step Zoom]	Each time zoom is operated, the zoom stops at the position for one of the preset focal lengths.

#### [Ring/Dial Set]

Changes the settings assigned to the control ring/control dial. (→134)

- For the setting procedures of the menu. (→60)

### [Live View Mode]

Sets the display speed and picture quality of the screen (Live View screen) when recording pictures using the LCD monitor or viewfinder.

#### ■ Settings

<b>[30fps]</b>	Picture quality has higher priority over display speed and pictures are displayed at 30 fps. For example, use when you want to record a comparatively slow-moving subject while confirming the focusing.
<b>[60fps]</b>	Display speed has higher priority over picture quality and pictures are displayed at 60 fps. The displayed pictures will appear slightly grainy. For example, use when you want to record a fast-moving subject.

- The [Live View Mode] setting will have no effect on the pictures being recorded.
- The display speed may slow down in dark locations.

### [Monitor Display] / [Viewfinder]

Adjust brightness and colour of the LCD monitor or Viewfinder. It is suggested to use the default settings.

These are intended to provide a preview of the actual picture, as accurately as possible.

- ① Press ▲▼ to select the setting item and press ◀▶ to make adjustments
- ② Press [MENU/SET]



- It will adjust the LCD monitor when the LCD monitor is in use, and the viewfinder when the viewfinder is in use.
- Some subjects may look different from their actual appearance, but the recorded picture will not be affected.

- For the setting procedures of the menu. (→60)

### [Monitor Luminance]

Make LCD monitor easier to see.

#### ■ Settings

 [Auto Power Monitor]	The brightness is adjusted automatically depending on how bright it is around the camera.
 [Power Monitor]	The brightness becomes higher than usual for easy viewing outdoors.
[OFF]	—

- Cannot select [Auto Power Monitor] in Playback Mode.
- [Power Monitor] returns to ordinary brightness if there is no operation for 30 seconds when recording. (Press any button to make the screen brighter again.)
- Because the picture shown on the LCD monitor screen emphasises brightness, some subjects may look different than their actual appearance, but this will not affect the recorded picture.
- Setting [Monitor Luminance] reduces the operating time.

### [Composition Guide]

Selects guideline display and type.

By setting the basic composition, you can take more impressive still pictures. (→77)

### [Guide Line]

Displays guidelines specifically for [Panorama Shot] Mode. (→119)

#### ■ Settings: [ON] / [OFF]

- For the setting procedures of the menu. (→60)

### [Histogram]

Displays distribution of brightness in picture – e.g. if the graph peaks at the right, this means there are several bright areas in the picture. A peak in the centre represents correct brightness (correct exposure). This can be used as a reference for exposure correction, etc.

(Example)

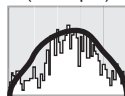

Dark ← OK → Bright

### ■ Settings: [ON] / [OFF]

- When the histogram is not the same as that of the recorded picture under the following conditions, histogram will be displayed in orange:
  - In dark places.
  - When manual exposure assist indicates settings other than 0 EV in [Manual Exposure] mode or during Exposure Compensation.
  - When the flash fires.
- The histogram displayed during recording is only a reference.
- The histogram displayed during recording and that displayed during playback may be different.
- The histogram is different from those displayed using the image editing software of a computer.
- The histogram will not be displayed in the following cases:
  - [Intelligent Auto] Mode
  - Playback Zoom
  - When recording motion pictures
  - Multi Playback
  - When the HDMI micro cable is connected

### [Video Rec Area]

Enables verification of the recordable area for a motion picture before recording.

### ■ Settings: [ON] / [OFF]



- Recordable area displayed for motion pictures should be interpreted as a guideline.
- When using Extra optical zoom, the recordable area may not always be displayed for certain zoom ratios.
- For [Intelligent Auto] Mode, the setting is fixed to [OFF].

- For the setting procedures of the menu. (→60)

### [Remaining Disp.]

Switch the display between the remaining number of still pictures you can take or the remaining recording time of a motion picture that you can record for the available card or built-in memory.

#### ■ Settings

	This will display the number of recordable pictures for still pictures.
	This will display the available recording time for motion pictures.

### [Lens Resume]

#### ● [Zoom Resume]

Remember the zoom position when turning the camera off.

■ Settings: [ON] / [OFF]

#### ● [MF Resume]

The camera will remember the Manual Focus focus position when the unit is turned off and when the focus mode is set to other than [MF]. The next time the unit is turned on or the focus mode is set to [MF], it will return to the remembered focus position.

■ Settings: [ON] / [OFF]

### [MF Assist]

Set whether to enlarge the focus point when Manual Focus is used to adjust focus. (→97)

### [Peaking]

When you perform Manual Focus operation, this function automatically adds colour to the portions of the image that are in focus. (→98)



- For the setting procedures of the menu. (→60)

### [Economy]

Turn off the camera or make the LCD monitor go dark while not using the camera to minimise battery consumption.

#### ● [Auto Power Off]

The camera is automatically turned off while not in use.

■ **Settings:** [2MIN.] / [5MIN.] / [10MIN.] / [OFF]

- When you want to use the camera again, turn the camera back on.
- Cannot be used in the following cases:
  - During motion picture recording/playback
  - During Slide Shows
  - When supplying power with the AC adaptor (during playback when connected to supplied AC adaptor)
  - When connected to computer/printer
- Settings fixed to [5MIN.] in [Intelligent Auto] Mode.

#### ● [Monitor Power Save]

The LCD monitor goes dark to minimise power consumption.

■ **Settings:** [ON] / [OFF]

- Reduces the picture quality of the LCD monitor display during recording to minimise battery consumption (except for the Digital Zoom area). Note, however, that there is no effect on the recorded picture.
- The setting in [Monitor Luminance] is prioritised over the setting in [Monitor Power Save] for the brightness of the LCD monitor.

- For the setting procedures of the menu. (→60)

### [Auto Review]

Automatically display still pictures immediately after taking them.

#### ■ Settings

[1SEC] / [2SEC]	Displays the playback screen for the set time before automatically returning to the recording screen.
[HOLD]	Keeps the automatic playback screen displayed until [MENU/SET] is pressed.
[OFF]	—

- For [Intelligent Auto] Mode, the setting is fixed to [2SEC].
- Motion pictures cannot be automatically reviewed. (also applies to high-speed motion pictures)

### [Exposure Comp. Reset]

If the Recording Mode is changed or the camera is turned off, the exposure compensation (brightness) setting is reset.

#### ■ Settings: [ON] / [OFF]

### [Self Timer Auto Off]

The self-timer is cancelled if the unit is turned off.

#### ■ Settings: [ON] / [OFF]

- For the setting procedures of the menu. (→60)

### [No.Reset]

Reset picture file numbers. (The folder number is updated and the file number starts from 0001.)

- To reset folder number to 100:  
First, format the built-in memory or card, and reset the file numbers using [No.Reset]. Then, select [Yes] on the folder number reset screen.
- A folder number between 100 and 999 can be assigned.  
Numbers cannot be reset once folder number reaches 999. In this case, save all necessary pictures to your computer, and format the built-in memory/card (→74).

### [Reset]

Reset to the default settings.

- **[Reset Rec. settings?]**
- **[Reset setup parameters?]**
  - Information registered in [Face Recog.] is reset if recording settings are reset.
  - Resetting the setup parameters will also reset the following:
    - Age in years/months and names in [Baby] and [Pet] Scene Modes
    - [GPS] menu
  - Folder numbers and clock settings will not be reset.
  - Camera movement may be audible as the lens function is reset. This is not a fault.

### [Reset Wi-Fi Settings]

Returns all [Wi-Fi] menu settings to default settings.





- If you want to dispose or give away your camera, always reset it to prevent your personal information from being mistakenly used.
- When you request your camera to be fixed, backup your personal information and always reset it as well.

- For the setting procedures of the menu. (→60)

### [USB Mode]

Select communication method for when connecting camera to a computer or printer with USB connection cable (supplied). Update the GPS assist data.

#### ■ Settings

 [Select on connection]	Select communication method each time you connect to a computer or PictBridge-compatible printer.
 [PictBridge(PTP)]	Select when connecting to a PictBridge-compatible printer.
 [PC]	Select when connecting to a computer.
 [GPS assist data]	Select when using this unit to update GPS assist data. (→266)

### [TV Connection]

Change the settings to be used when the camera is connected to a TV or other device.

#### ● [Video Out]

##### ■ Settings

[NTSC]	Video output is set to NTSC system.
[PAL]	Video output is set to PAL system.

#### ● [TV Aspect]

This setting performs when an AV cable (optional) is connected.

■ Settings: [16:9] / [4:3]

#### ● [3D Playback]

Set how 3D still picture is output.

■ Settings: [3D] / [2D]

- If you want to play back a picture in 2D (conventional picture) on a 3D television, set to [2D].
- This item of the menu functions when an HDMI micro cable is connected.
- For the procedure for playing back a 3D still picture. (→281)

- **[VIERA Link]**

Enable automatic linking with other VIERA Link-compatible devices, and operability with a VIERA remote control when connecting via an HDMI micro cable. (→279)

- **Settings**



[ON]	Operations may be performed via the remote control of the VIERA Link-compatible device. <ul style="list-style-type: none"> <li>• Not all operations will be available.</li> <li>• Operability of the camera's own buttons will be limited.</li> </ul>
[OFF]	Operations must be performed via the camera's own buttons.

- For the setting procedures of the menu. (→60)

### [Rotate Disp.]

Automatically rotate portrait still pictures.

- **Settings**

	Rotate pictures on a TV and the LCD monitor/viewfinder so that they are displayed vertically.
	Pictures are displayed vertically by rotating when played back on a TV.
[OFF]	—

- [Rotate Disp.] cannot be used with motion pictures.
- Still pictures taken with the lens surface facing up or down, or still pictures taken on other cameras may not rotate.
- Pictures cannot be rotated during Multi Playback.
- Will only be displayed rotated on computer if in Exif-compatible (→52) environment (OS, software).

- For the setting procedures of the menu. (→60)

### [Version Disp.]

Check the camera firmware version or display software information.

- When you press [MENU/SET] while the version is displayed, software information such as the licence is displayed.

### [Format]

Use when [Built-In Memory Error] or [Memory Card Error] appears, or when formatting the built-in memory or card.

**When a card/built-in memory is formatted, the data cannot be restored. Check the content of the card/built-in memory carefully before formatting.**

- When formatting the built-in memory, remove the cards.  
(Only inserted card will be formatted if present; built-in memory will be formatted if no card is inserted.)
- **All protected pictures and other picture data will be deleted.**
- Do not turn off the camera or perform other operations during formatting.
- Always format cards with this camera.
- Formatting the built-in memory may take several minutes.
- If the card cannot be formatted, please try another card before contacting Panasonic.

### [Language]

Change display language.

Set the language displayed on the screen.

## Entering Text

Use the cursor button to enter names with the Face Recognition function and in Scene Modes [Baby] and [Pet], or to register locations in [Travel Date] etc.

**1** Use ▲▼◀▶ to select characters

**2** Press [MENU/SET] several times until the desired character is displayed

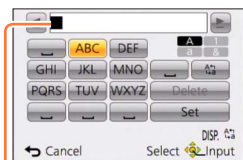

Text is inserted at the cursor position.

- To change the character type
  - Press [DISP.] button
  - Use ▲▼◀▶ to select [A<sub>α</sub>] and press [MENU/SET].

Cursor position

- To continue entering characters
  - Use ▲▼◀▶ to select [▶] and press [MENU/SET]
  - Move the zoom lever toward T side
  - Turn the control dial to the right
- Editing text
  - ① Use ▲▼◀▶ to select [◀] [▶] and press [MENU/SET]. Then, move the cursor to the text to edit
    - You can also use the zoom lever or control dial to reposition the cursor.
  - ② Use ▲▼◀▶ to select [Delete] and press [MENU/SET]
  - ③ Use ▲▼◀▶ to select the correct text, and then press [MENU/SET]

**3** When you are finished entering text, use ▲▼◀▶ to select [Set] and press [MENU/SET]

● A maximum of 30 characters can be entered (maximum of 9 characters when setting names in [Face Recog.]).

\*A maximum of 15 characters can be entered for [ \ ], [ [ ], [ ] ], [ • ] and [ — ] (maximum of 6 characters when setting names in [Face Recog.]).

## Switching the display of recording information, etc.

You can also turn off the recording information (such as icons for various settings) and the level gauge (→79).

You can switch the display, such as turning off the display of information for a simple display, for example when determining the composition.

### 1 Press [DISP.] button to change display

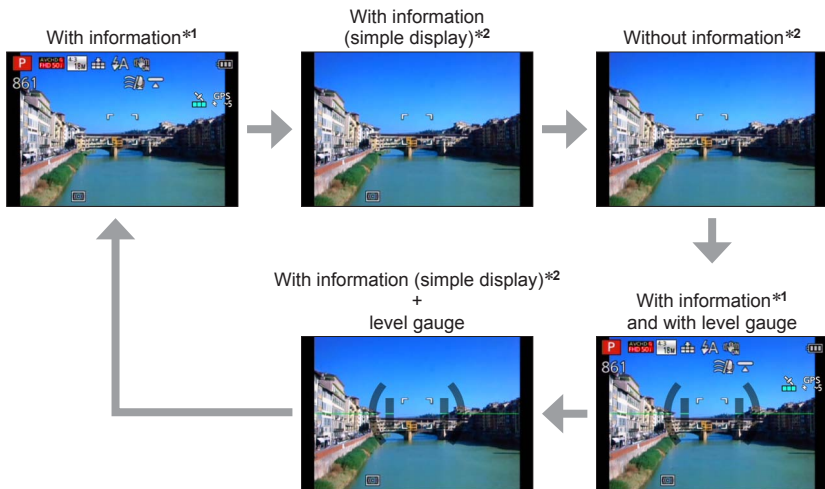
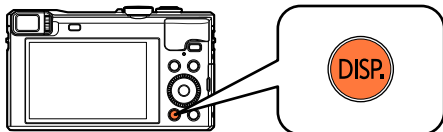

\*1 Set [Histogram] to display a histogram. (→67)

\*2 The setting information display does not appear even when you turn the control ring/control dial. (Except in the case of zoom, [Step Zoom], or Manual Focus operation)





## Taking pictures with the composition determined

[Composition Guide]

■ Recording mode:          

By using the viewfinder or LCD monitor to consider the placement of your subject (the composition), you can take more impressive still pictures.

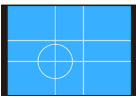
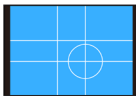
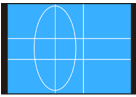
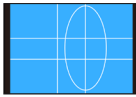
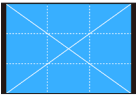
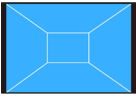
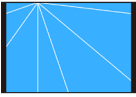
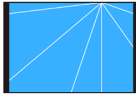
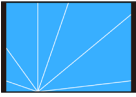
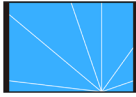
The following guidelines can be used.

Composition name	Guideline	Description
[Rule of Thirds Offset]		This composition creates a more interesting photo by offsetting the subject from the centre.
	 	This composition creates a more interesting photo by offsetting the flower from the centre.
	 	This composition creates a more interesting photo by offsetting the person from the centre.
[Diagonal lines]		This composition gives an alternate perspective by realigning the subject along the diagonal lines.
[Tunnel]		This composition is intended to emphasise the depth of long narrow scenes.
[Radiation 1]	 	This composition adds an expansive perspective to your photo by aligning the subject along the radial lines.
[Radiation 2]	 	
[S-shape]	 	This composition can enhance your photo by drawing attention to wandering elements of the scene.

## ■ How to select guidelines

**1** Press [Fn] button

**2** Use ▲ ▼ to select the guideline to display and press [MENU/SET]



- You can also select the guideline with the control dial.

- Explanations and examples of the composition will be displayed in turn when you press the [DISP.] button.
- If the guideline allows horizontal flipping, use ◀▶ to flip.
- To turn off guideline display, select [No Guide].
- When other functions are registered to the [Fn] button
  - ① Select [Composition Guide] from the [Setup] menu and press [MENU/SET]
  - ② Use ▲ ▼ to select the guideline to display and press [MENU/SET]
  - ③ Press [Q.MENU/↵] button several times

## ■ Taking still pictures with a guideline

**1** Referring to the guideline, align your subject and press the shutter button

- When pictures are taken in portrait orientation, the guidelines are automatically changed to the portrait orientation.
- The guidelines will not appear on the actual still picture.

## Using the level gauge

■ Recording mode: **[A]** **P** **A** **S** **M** **C1** **C2** **[M]** **[SCN]** **[G]**

If you want to make sure that the camera is not slanted or tilted, for example, when you take a picture of a landscape, use the level gauge indication as a reference.

### 1 Press [DISP.] button to switch the display

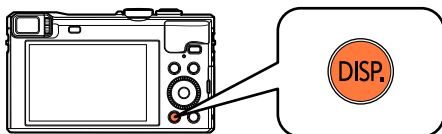

Press the button to switch the display. Press the button until the level gauge is displayed.

### 2 Correct camera angle

#### ■ Using the level gauge

The yellow line indicates the current angle. Correct the angle of the camera so that it matches the white line.

#### Tilting up or down

- In this case, it is facing upward.

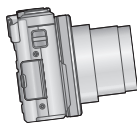

#### Tilting left or right

- In this case, the right side has dropped.

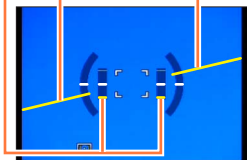

- When the camera is tilted very little or not at all, the level gauge will turn green.
- When pictures are taken in portrait orientation, the level gauge is automatically switched to one for portrait orientation.

- Even when angle is more or less corrected, there may be an error of about  $\pm 1$  degree.
- When the camera is being moved, the level gauge may not be displayed correctly.
- The level gauge may not be displayed correctly or the direction detect function may not operate correctly if the pictures are taken with the camera pointing sharply up or down.

## Using Zoom

■ Recording mode: **[A]** **[P]** **[A]** **[S]** **[M]** **[C1]** **[C2]** **[ ]** **[SCN]** **[ ]**

You can adjust the area of a picture to be taken using zoom.

### 1 Move the zoom lever

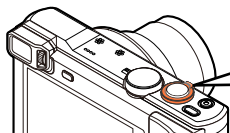

Capture a wider area (wide-angle)



Enlarge the subject (telephoto)

- The zoom speed can be set to one of 2 levels using the angle at which the zoom lever is moved.

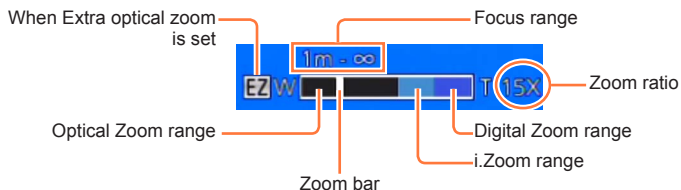

The illustration is an example of when using Extra optical zoom, [i.Zoom], and [Digital Zoom].

### ■ Using the control ring/control dial for zoom operation

You can perform zoom operation by assigning the [Zoom] setting to the control ring/control dial. (→134)

(In [Program AE] mode, the control ring is assigned to [Zoom].)

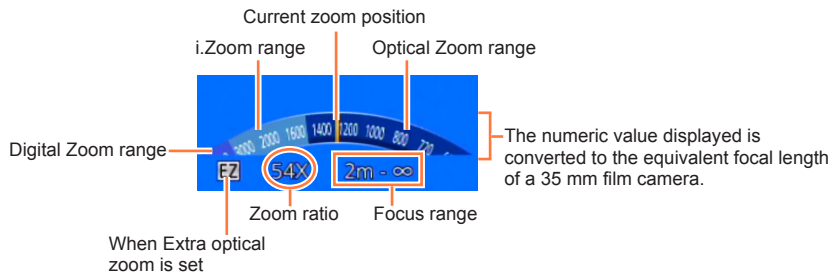

- If you are not holding the camera, for example when using self-timer recording (→105) or remote recording (→196), the camera could tilt when the lens barrel extends during zooming, so make sure to secure the camera in place with a tripod or by other means.
- Do not touch the lens barrel during zooming.
- Adjust the focus after adjusting the zoom.
- The zoom ratio and the zoom bar displayed on the screen are estimates.
- The camera may make a rattling noise and vibrate when the zoom lever is operated - this is not a malfunction.

### Zoom types and use

The zoom ratio changes when the picture size is changed.

#### ■ Optical Zoom

Zooming in up to 30x is possible if pictures without [EZ] have been selected by [Picture Size] on the [Rec] menu. (→140)

- Optical Zoom cannot be used in the following cases:
  - [Macro Zoom]
  - [3D Photo Mode] Scene Mode

#### ■ Extra optical zoom

Zooming in up to 71.7x is possible when pictures with [EZ] have been selected by [Picture Size] on the [Rec] menu (→140). EZ is short for “Extra optical zoom”.

- Extra optical zoom cannot be used in the following cases:
  - [Macro Zoom]
  - When recording motion pictures
  - When the [Burst] setting is set to [40] or [60]
  - Scene Modes ([HDR], [High Sens.], [High Speed Video], [3D Photo Mode])
  - [Creative Control] Mode ([Impressive Art], [Toy Effect])
  - When the [Quality] setting is set to [RAW], [RAW] or [RAW]

To increase the zoom ratio further, the following zoom can be used in combination.

### ■ [i.Zoom]

You can use the camera's Intelligent Resolution technology to increase the zoom ratio up to 2x higher than the original zoom ratio with limited deterioration of picture quality. Set the [i.Zoom] in the [Rec] menu to [ON]. (→148)

- The camera's Intelligent Resolution technology is applied to a picture in the zoom range of [i.Zoom].
- [i.Zoom] always functions in [Intelligent Auto] mode and [Scene Mode] (except [Handheld Night Shot], [HDR], [High Sens.], [3D Photo Mode]).
- [i.Zoom] does not function in the following cases:
  - [Macro Zoom]
  - When the [Burst] setting is set to [40] or [60]
  - When the [Quality] setting is set to [RAW], [RAW] or [RAW]
  - Scene Modes ([Handheld Night Shot], [HDR], [High Sens.], [3D Photo Mode])
  - [Creative Control] Mode ([Impressive Art], [Toy Effect])

### ■ [Digital Zoom]

Zoom 4x further than Optical/Extra optical zoom. Note that, with Digital Zoom, enlarging will decrease picture quality. Set the [Digital Zoom] in the [Rec] menu to [ON]. (→148)

- Digital Zoom cannot be used in the following modes:
  - [Intelligent Auto] Mode
  - When the [Burst] setting is set to [40] or [60]
  - When the [Quality] setting is set to [RAW], [RAW] or [RAW]
  - Scene Modes ([Handheld Night Shot], [HDR], [High Sens.], [High Speed Video], [3D Photo Mode])
  - [Creative Control] Mode ([Impressive Art], [Toy Effect], [Miniature Effect])
- This is fixed to [ON] when [Macro Zoom] is set.
- When [Digital Zoom] is used simultaneously with [i.Zoom], you can only increase the zoom ratio up to 2x.

**[Step Zoom]**

You can set the zoom operation to allow easy visualisation of the angle of view (picture angle) for the focal length of a regular fixed focal length lens (as with a 35 mm film camera). When using the Step Zoom, you can operate the zoom ratio as easily as changing the camera lens.

- If recording in [Intelligent Auto] Mode, you can adjust the [Step Zoom] with the control ring/control dial.

If the setting assigned to the control ring/control dial is [Step Zoom], [Step Zoom] will also be available for use in other modes. (→134)

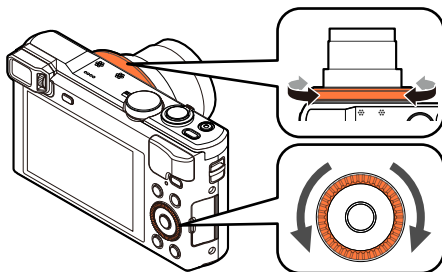
**1 Turn the control ring or control dial**

(In [Program AE] mode, the control ring is assigned to [Step Zoom].)



Current zoom position  
(Focal lengths the same as those of a 35 mm film camera)

The illustration is an example of when using Extra optical zoom, [i.Zoom], and [Digital Zoom]. The zoom ratio is not displayed. (→80)

**■ Using the zoom lever for [Step Zoom]**

You can use the zoom lever for [Step Zoom] by setting [Zoom Lever Set] to [Step Zoom] in the [Setup] menu. (→64)

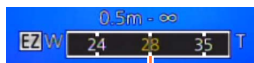

Current zoom position  
(Focal lengths the same as those of a 35 mm film camera)

- When using [Step Zoom], the focal length displayed is an estimate. It is based on the [Aspect Ratio] setting of 4:3.
- The focal length will change in the following cases:
  - When [iHandheld Night Shot] is set to [ON]
  - When [Burst] is set to [60]
  - When [Handheld Night Shot] is set in Scene Mode
- [Step Zoom] cannot be used in the following cases:
  - When recording motion pictures
  - [3D Photo Mode] Scene Mode



## Taking pictures with flash

■ Recording mode:

**1** Press [] button (▶)

**2** Use ▲ ▼ to select the desired type and press [MENU/SET]

Type, operations	Uses
<b>[Auto]</b> *1 • Automatically judges when to use flash	Normal use
<b>[Auto/Red-Eye]*2</b> • Automatically judges when to use flash (reduces red-eye)	Taking pictures of subjects in dark places
<b>[Forced Flash On]</b> • Always uses flash	Taking pictures with backlight or under bright lighting (e.g. fluorescent)
<b>[Slow Sync./Red-Eye]*2</b> • Automatically judges when to use flash (reduces red-eye; slow shutter speed to take brighter pictures)	Taking pictures of subjects against a nightscape (tripod recommended)
<b>[Forced Flash Off]</b> • Never uses flash	Places where flash use is prohibited

\*1 Only in the [Intelligent Auto] mode

\*2 Two flashes will be emitted. Do not move until after the second flash. Interval between flashes varies according to brightness of subject.

When [Red-Eye Removal] in the [Rec] menu is set to [ON], the icon changes to /, red-eye is automatically detected and the picture data is corrected. (Only if the camera has detected a face.)

- **Do not put your hands over the light-emitting area of the flash (→12) or look at it from close range.**  
**Do not use the flash at close distances to other subjects (heat/light may damage subject).**
- The effect of red-eye reduction varies depending on the subject and is affected by factors such as distance to the subject, whether the subject is looking at the camera during preliminary flash, and so on. In some cases, the effect of red-eye reduction may be negligible.
- Flash settings may be changed when changing Recording Mode.
- Scene Mode flash settings are restored to default when Scene Mode is changed.
- Edges of picture may become slightly dark if using flash at short distances without using zoom (close to max. W). This may be remedied by using a little zoom.
- No pictures may be taken if these marks (e.g. [⚡A] ([Auto])) are flashing (flash is charging).
- If light from the flash on a subject is insufficient, neither the proper exposure nor White Balance is achieved.
- The flash effect may not be sufficient in the following cases:
  - When the shutter speed is fast
  - When [Burst] is set to [📷] ([Flash Burst])
- Flash charging may take time if battery is low or if using flash repeatedly.

■ Available types in each mode (○: Available, —: Not available, □: Default setting)

	IA	P A	S M	[Scene Mode]					
A	○*1	○	○	○	○	—	○	○	○
A <sup>Ⓞ</sup>	—	○	○	○	—	—	—	○	—
↓	—	○	○	○	○	—	○	○	○
S <sup>Ⓞ</sup>	—	○	—	—	—	○	—	—	—
↓	○	○	○	○	○	○	○	○	○

\*1 Set to [A], [A<sup>Ⓞ</sup>], [S<sup>Ⓞ</sup>] or [S] depending on the subject and brightness.

- The flash cannot be used when recording motion pictures or in the [], [], [], [], [], [], and [3D] Scene Modes.

■ The available flash range when [Sensitivity] setting is [AUTO]

Max. Wide	Approx. 0.6 m - 6.4 m (2.0 feet - 21 feet)*2
Max. Tele	Approx. 2.0 m - 3.3 m (6.6 feet - 11 feet)*2

\*2 When [ISO Limit Set] is [AUTO].

■ Shutter speeds for each flash mode

Setting	Shutter speed (seconds)
A A <sup>Ⓞ</sup> ↓	1/60*3 - 1/2000
S <sup>Ⓞ</sup> ↓	1*3*4 - 1/2000

\*3 Varies according to [Min. Shtr Speed] setting.

\*4 When [Min. Shtr Speed] is set to [AUTO], and a jitter is detected when [Stabilizer] is turned to [ON], the maximum speed is 1/4 second.

- In Intelligent Auto Mode, shutter speed changes depending on the identified scene.
- In Scene Mode, the shutter speeds will differ from those described above.

## Taking pictures with Auto Focus

■ Recording mode:          

When Auto Focus is enabled, press the shutter button halfway to focus. Focusing methods differ depending on [Rec] mode and [AF Mode] setting.





**1** Press  button (◀)

**2** Use ▲ ▼ to select [AF] and press [MENU/SET]

■ Switching [AF Mode]

**1** Select [AF Mode] from the [Rec] menu  
• For the setting procedures of the menu. (→60)

**2** Use ▲ ▼ to select Auto Focus mode items and press [MENU/SET]

 (Face Detection)	Taking front-on pictures of people (→89)
 (AF Tracking)	Automatically locking the focus on a moving subject (→90)
 (23-area-focusing)	Subject not centred in picture (→91)
 (1-area-focusing)	Determined position for focus (→91)

### Taking front-on pictures of people (Face Detection)

Recognises faces (up to 15 people) and adjusts exposure and focus accordingly.



AF area

Yellow: When the shutter button is pressed halfway, the frame turns green when the camera is focused.

White: Displayed when more than one face is detected. Other faces that are the same distance away as faces within the yellow AF area are also focused.

- Cannot set to [👤] (Face Detection) in the following cases:
  - Scene Modes ([Night Scenery], [Handheld Night Shot], [Food], [Starry Sky], [High Speed Video])
  - [Creative Control] Mode ([Miniature Effect], [Soft Focus])
  - [Panorama Shot] Mode
- If the camera misinterprets a non-human subject as a face in [👤] (Face Detection) setting, switch to another setting.
- If conditions prevent the face from being recognised, such as when the movement of the subject is too rapid, the [AF Mode] setting switches to [📐] (23-area-focusing).

## Automatically locking the focus on a moving subject (AF Tracking)

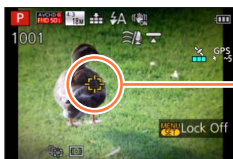
**1** Align the AF Tracking frame with the subject and press the shutter button halfway**AF Tracking frame**

When the subject is recognised, the AF Tracking frame changes from white to yellow, and the subject is automatically kept in focus.

If AF Lock fails, a red frame flashes.

- To release AF Tracking → Press [MENU/SET].
- Focus range: same as macro recording

- Under certain recording conditions, such as when the subject is small or dark, [AF Tracking] (AF Tracking) may not operate correctly.
- Cannot set to [AF Tracking] (AF Tracking) in the following cases:
  - Scene Modes ([Starry Sky], [High Speed Video])
  - [Creative Control] Mode ([Sepia], [Dynamic Monochrome], [High Dynamic], [Toy Effect], [Miniature Effect], [Soft Focus])
  - [Panorama Shot] Mode

### Subject not centred in picture (23-area-focusing)

Focuses on the subject in the wide range area (up to 23-area-focusing) on the recording screen.



- Focus is fixed to [■] (1-area-focusing) during motion picture recording.
- Cannot set to [■] (23-area-focusing) in the following cases:
  - Scene Modes ([Starry Sky], [High Speed Video])
  - [Miniature Effect] in [Creative Control] Mode

### Determined position for focus (1-area-focusing)

Focuses on AF area in centre of picture. (Recommended when focus is difficult to align)



- Focus is fixed to [■] (1-area-focusing) in the following cases:
  - Scene Modes ([Starry Sky], [High Speed Video])
  - [Miniature Effect] in [Creative Control] Mode

## ■ Changing the position and size of the AF area ([Focus Area Set])

When [AF Mode] is set to [□] (1-area-focusing), you can move the position or size of the AF area at the centre.

- ① Select [AF Mode] from the [Rec] menu and press [MENU/SET] (→60)
- ② Use ▲▼ to select [□] from the [AF Mode] items and press [DISP.] button
- ③ To change the AF area
  - To move the position of the AF area: Press ▲▼◀▶
  - To change the size of the AF area: Turn the control dial
  - To restore the AF area to its initial state (position and size) → Press [DISP.] button.
- ④ Press [MENU/SET]
  - If the [Fn] button is set to [Focus Area Set] (→133), press the [Fn] button and then perform steps ③ and after.

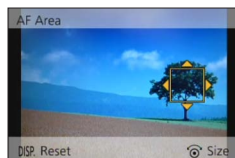
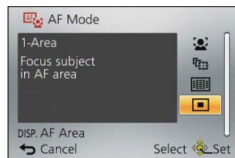

- Cannot be changed during motion picture recording.
- When the AF area is small, it may be difficult to adjust the focus.
- When [Metering Mode] is set to [□] (spot-focusing), the new position of the AF area will be measured.
- The position and size cannot be changed in [Miniature Effect] of [Creative Control] mode.



## Taking close-up pictures (Macro recording)

■ Recording mode: **iA** **P** **A** **S** **M** **C1** **C2** **□** **SCN** **🔗**

When you want to enlarge the subject, setting to [AF Macro] ([AF🌸]) enables you to take pictures at an even closer distance than the normal focus range (up to 3 cm (0.098 feet) for max. Wide).

**1** Press [**MF**] button (◀)

**2** Use ▲ ▼ to select [AF Macro] ([AF🌸]) and press [MENU/SET]



[AF🌸] display

- Cannot be set in the following case:
  - In all Scene Modes except [3D Photo Mode]

## Focus range

When a subject is too close to the camera, the picture may not be properly focused.

### ■ Shortest recording distance

The shortest recording distance is the distance from the lens front to the subject. This distance changes gradually depending on the zoom position.

Zoom	[Focus Mode]		
	[AF]	[AF Macro] (AF) (🌸) [MF] (→96)	[Macro Zoom] (👁) (→95)
Max. W	50 cm (1.6 feet)	3 cm (0.098 feet)	3 cm (0.098 feet)
Max. T	200 cm (6.6 feet)	200 cm (6.6 feet)	—

- Focus range is displayed when operating the zoom, etc.



- It may take some time until distant subjects come into focus.
- Using a tripod and [Self Timer] is recommended. Also, when recording a subject that is close to the camera, setting [Flash] to [🚫] ([Forced Flash Off]) is recommended.
- Moving the camera after aligning the focus is likely to result in poorly focused pictures if subject is close to the camera, due to the margin for focus alignment being severely reduced.
- Resolution may be reduced around the edges of the picture.

## [Macro Zoom]

■ Recording mode:

To take even larger images of the subject, setting to [Macro Zoom] () enables the subject to appear even larger than when using [AF Macro] ().

**1** Press [] button ()

**2** Use to select [Macro Zoom] () and press [MENU/SET]

**3** Adjust the magnification with the zoom lever

The zoom position is fixed at the Wide end. Focus range is 3 cm (0.098 feet) - ∞.



- In [Macro Zoom], higher magnification results in lower picture quality.
- When [Macro Zoom] is set, Extra optical zoom or [i.Zoom] does not work.
- When [AF Tracking] is set, zoom macro is cancelled.
- The [Macro Zoom] cannot be set in the following cases:
  - [Creative Control] Mode ([Impressive Art], [Toy Effect], [Miniature Effect])
  - When the [Burst] setting is set to [] or []
  - When the [Quality] setting is set to [], [] or [RAW]

## Taking pictures with Manual Focus

■ Recording mode: **iA** **P** **A** **S** **M** **C1** **C2** **☐** **SCN** **🔗**

Manual Focus is convenient when you want to lock the focus to take pictures or when it is difficult to adjust focus using Auto Focus.

**1** Press **[MF]** button (◀)

**2** Use ▲ ▼ to select **[MF]** and press **[MENU/SET]**

**3** Turn the control ring to adjust focus

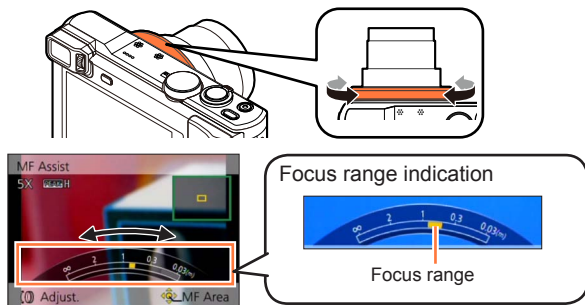

• If **[Peaking]** is set to **[ON]**, colour is added to the portions of the image that are in focus. (→98)

- After zoom operation, readjust the focus.
- The focus range displayed by Manual Focus is a reference value. Confirm the focus on the screen ([MF Assist] screen).
- Manual Focus can be performed from the Quick menu even if the control ring settings have been changed. (→34)

### ■ 1 Shot AF

When [1 Shot AF] is registered in the [Fn] button (→133), you can press the [Fn] button once to temporarily activate Auto Focus and focus on a subject.

- First use [1 Shot AF] to focus on an area close to the subject. This makes it easier to adjust the focus with the control ring.

### ■ MF Assist

When [MF Assist] is set to [ON] in the [Setup] menu and you perform the Manual Focus operation, an enlarged display of the MF area (the position to be focused on) appears.

- Shortly after you stop operating Manual Focus, the display switches to normal.

#### ● To change the position of the MF area

- ① Press [MENU/SET] while MF Assist is displayed
- ② Press ▲ ▼ ◀ ▶ to move the MF area
  - To restore the MF area to the initial position → Press [DISP.] button.
- ③ Press [MENU/SET]

- The MF Assist is disabled in the Digital Zoom range or when recording motion pictures.
- The MF area position is retained even after the unit is turned off.
- The magnification of the enlarged area can be changed by turning the control dial when MF Assist is activated or the MF area is moving.

## ■ [Peaking]

If [Peaking] is set to [ON] in the [Setup] menu, colour is added to the portions of the image that are in focus.

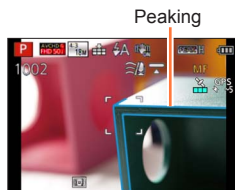

### ● To change the [Detect Level] or [Display Color] settings

- ① Select [Peaking] from the [Setup] menu (→60)
- ② Use ▲▼ to select [SET] and press [MENU/SET]
- ③ Use ▲▼ to select [Detect Level] or [Display Color] and press [MENU/SET]
- ④ Use ▲▼ to select the setting and press [MENU/SET]

<b>[Detect Level]</b>	<p>The detection level for in-focus portions is set. When [HIGH] is set, portions to be highlighted are reduced, allowing you to achieve a more precise focus.</p> <p>■ <b>Settings: [HIGH]/[LOW]</b></p> <ul style="list-style-type: none"> <li>• The detection level setting does not affect the focus range.</li> </ul>																
<b>[Display Color]</b>	<p>Sets the highlighting colour used for [Peaking].</p> <p>■ <b>Settings</b></p> <p>The available colour settings differ depending on the setting of [Detect Level]. Changing the [Detect Level] setting also changes the [Display Color] setting as follows.</p> <table border="1" data-bbox="311 831 910 959"> <tr> <td>[Detect Level]</td> <td>[HIGH]</td> <td>←→</td> <td>[LOW]</td> </tr> <tr> <td></td> <td>[Light blue]</td> <td>←→</td> <td>[Blue]</td> </tr> <tr> <td>[Display Color]</td> <td>[Yellow]</td> <td>←→</td> <td>[Orange]</td> </tr> <tr> <td></td> <td>[Green]</td> <td>←→</td> <td>[White]</td> </tr> </table>	[Detect Level]	[HIGH]	←→	[LOW]		[Light blue]	←→	[Blue]	[Display Color]	[Yellow]	←→	[Orange]		[Green]	←→	[White]
[Detect Level]	[HIGH]	←→	[LOW]														
	[Light blue]	←→	[Blue]														
[Display Color]	[Yellow]	←→	[Orange]														
	[Green]	←→	[White]														

- When [Peaking] is set to [ON], [PEAK H] ([Detect Level]: [HIGH]) or [PEAK L] ([Detect Level]: [LOW]) will be displayed.
- When [Fn Button Set] (→133) is set to [Peaking], you can switch the setting in the following order every time the [Fn] button is pressed: [ON] ([Detect Level]: [LOW]) → [ON] ([Detect Level]: [HIGH]) → [OFF].
- Since portions with clear outlines on the screen are highlighted as in-focus portions, portions to be highlighted vary depending on the recording conditions.
- The colour used for highlighting does not affect recorded pictures.

## Taking pictures by locking the focus and/or exposure [AF/AE Lock]

■ Recording mode:          

The AF/AE Lock function is convenient, for example, when there is too much contrast with the subject and you cannot get appropriate exposure (AE Lock) or when you want to take a still picture composed with the subject outside the AF area (AF Lock).

### Preparation:

To execute the AF/AE Lock function, it is necessary to register [AF/AE Lock] to the [Fn] button. (→133)

- 1** Align the AF area with the subject
- 2** Press [Fn] button to lock the focus and/or exposure
  - To cancel AF/AE Lock → Press [Fn] button.
- 3** Move the camera to compose the still picture you want to take, and press the shutter button fully
  - When [AE] is set, press the shutter button halfway to focus, then press it fully.

### ■ AF/AE Lock switching

By using [AF/AE Lock] in the recording menu, you can set whether to lock focus and/or exposure.

[AE]	Locks exposure only. ([AEL] is displayed on the screen.)
[AF]	Locks focus only. ([AFL] is displayed on the screen.)
[AF/AE]	Locks focus and exposure. ([AFL] and [AEL] are displayed on the screen.)

- AF Lock only is effective in the following case:
  - [Manual Exposure] Mode
- During Manual Focus, only AE Lock can be used.
- Lock is cancelled when a zoom operation is performed after locking the exposure and/or focus.

## Taking pictures with Exposure Compensation

■ Recording mode: **iA** **P** **A** **S** **M** **C1** **C2** **□** **SCN** **🔒**

Corrects the exposure when there is a backlight or when the subject is too dark or too bright.

**1** Press [**⬇️**] button (**▲**)

**2** Turn the control ring or control dial to select the compensation value and press [**MENU/SET**]

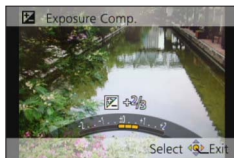

- If the picture is too dark, adjust the exposure to the “+” direction.
- If the picture is too bright, adjust the exposure to the “-” direction.
- After exposure adjustment, the adjustment value ([**⬇️**+1/3] for example) is displayed in the bottom-left corner of the screen.
- You can also press **◀▶** to make adjustments.

- Depending on the brightness, this may not be possible in some cases.
- If you set [Exposure Comp. Reset] to [ON] in the [Setup] menu, the exposure compensation setting is reset when the camera is turned off or the Recording Mode is changed. (→70)
- Cannot be set in the following case:
  - [Starry Sky] Scene Mode
- You can adjust the brightness in the following cases:
  - [Intelligent Auto Plus] Mode (→41)
  - [Creative Control] Mode (→110)
  - [Panorama Shot] Mode (→119)



## Recording while exposure is changed automatically ([Auto Bracket])

■ Recording mode: 

Records 3 pictures in continuous succession while exposure is changed automatically. After exposure adjustment, the adjustment value is set as the standard.

**1** Press [] button (▼)

**2** Use ▲ ▼ to select [Auto Bracket] and press [MENU/SET]

- To change the compensation margin, press the [DISP.] button and select a compensation margin with ◀▶.

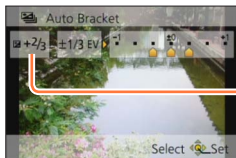

Value displayed after Exposure Compensation set

**3** Take a picture

Press the shutter button fully to record a burst of 3 pictures while exposure is changed automatically. The first still picture is recorded without compensation, the second still picture is recorded with exposure adjusted in the “-” direction, and the third still picture is recorded with exposure adjusted in the “+” direction.

■ To cancel [Auto Bracket]

In step **2**, select [] or [].

- Cannot be used with flash.
- [Auto Bracket] cannot be used in the following cases:
  - [Creative Control] Mode ([Toy Effect], [Miniature Effect], [Soft Focus], [Star Filter])
  - Scene Modes ([Handheld Night Shot], [HDR], [Starry Sky], [High Speed Video], [3D Photo Mode])
  - When recording motion pictures

## Burst function

■ Recording mode:

A burst of still pictures can be recorded while the shutter button is pressed fully.

**1** Press [] button (▼)

**2** Use ▲ ▼ to select [Burst] and press [MENU/SET]





- To change the burst setting, press the [DISP.] button and select a setting with ▲ ▼.

Setting	Speed	Description	No. of pictures*2
*1	Approx. 2 - 10 pictures/sec.	<ul style="list-style-type: none"> <li>• The burst speed is adjusted automatically in accordance with the movements of people, pets or other subjects. ([Intelligent Burst mode])</li> <li>• When a fast-moving subject is recorded, the frame rate becomes faster and the number of pictures that can be recorded in a series is restricted to about 10.</li> </ul>	100
 	Approx. 2 pictures/sec.	<ul style="list-style-type: none"> <li>• The subject is brought into focus as far as this is allowed by the burst speed (excluding [MF]). However, when the burst function is operating during motion picture recording, the focus is fixed to the first picture.</li> <li>• The pictures are taken with the burst function while the exposure and White Balance are being adjusted.</li> <li>• The burst speed may be reduced under certain recording conditions.</li> </ul>	100
 	Approx. 5 pictures/sec.		

\*1 [Intelligent Auto] Mode only

\*2 The number of burst pictures is limited by the picture-taking conditions and the type and/or status of the card used.

(Continued on the next page)

Setting	Speed	Description	No. of pictures*1
	Approx. 10 pictures/sec.	<ul style="list-style-type: none"> <li>Focus, exposure and White Balance are fixed in the first picture.</li> </ul>	6
	Approx. 40 pictures/sec.	<ul style="list-style-type: none"> <li>Focus, exposure and White Balance are fixed in the first picture.</li> <li>Note on the picture size setting.</li> </ul>	30
	Approx. 60 pictures/sec.	<ul style="list-style-type: none"> <li>Focus, exposure and White Balance are fixed in the first picture.</li> <li>The recordable range is reduced.</li> <li>Note on the picture size setting.</li> </ul>	60
 *2	Complies with recording conditions	<ul style="list-style-type: none"> <li>The burst of still pictures can be recorded even in low light conditions as the flash is used. ((Flash Burst!))</li> <li>The focus, exposure, and flash level are all fixed to the settings for the first picture.</li> </ul>	5



\*1 The number of burst pictures is limited by the picture-taking conditions and the type and/or status of the card used.

\*2 Only in [Program AE], [Aperture-Priority] and [Shutter-Priority] modes.

### 3 Take a picture

A burst of pictures can be recorded while the shutter button is pressed fully.

#### ■ Note on the picture size setting

[Aspect Ratio]		
<b>4:3</b>	5M, 3M, 0.3M	2.5M, 0.3M
<b>3:2</b>	4.5M, 2.5M, 0.3M	3M, 0.3M
<b>16:9</b>	3.5M, 2M, 0.2M	3.5M, 0.2M
<b>1:1</b>	3.5M, 2.5M, 0.2M	2M, 0.2M

#### ■ To cancel burst

In step 2, select [] or [OFF].

- Pictures taken with the [40] or [60] setting are recorded together as a group (picture group). (→157)
- Depending on changes in the brightness of the subject, the second and subsequent pictures may be recorded brighter or darker when using the burst function at the [10], [40], [60] or [5] setting.
- Burst speed may be reduced if shutter speed is reduced in darker locations.
- The pictures taken using the burst function at the [40] or [60] setting may be distorted if the subjects were moving or the camera was moved.
- The flash is set to [☺] ([Forced Flash Off]). (Excluding [☺] ([Flash Burst]))
- Settings will be stored even if the camera is turned off.
- The burst function cannot be used in the following cases:
  - Scene Modes ([Handheld Night Shot], [HDR], [Starry Sky], [High Speed Video], [3D Photo Mode])
  - [Creative Control] Mode ([Toy Effect], [Miniature Effect], [Soft Focus], [Star Filter])
- You cannot set to [40] or [60] in the following cases:
  - [Intelligent Auto] Mode
  - Scene Modes ([Night Portrait], [Night Scenery], [High Sens.])
  - When the [Quality] setting is set to [RAW], [RAW] or [RAW]
- It may take a while to store still pictures that were taken using the burst function. If you continue to record while storing, the number of burst pictures that can be taken will be reduced. A high-speed card is recommended when recording using the burst function.
- You cannot use zoom during burst recording.

## Taking pictures with self-timer

■ Recording mode: **[A]** **[P]** **[A]** **[S]** **[M]** **[C1]** **[C2]** **[ ]** **[SCN]** **[ ]**

We recommend using a tripod. This is also effective for preventing jitter when pressing the shutter button, by setting the self-timer to 2 seconds.

**1** Press **[ ]** **[ ]** button (▼)

**2** Use ▲ ▼ to select **[Self Timer]** and press **[MENU/SET]**

- To change the time setting, press the **[DISP.]** button and select a time setting with ▲▼.

**3** Take a picture

Press the shutter button fully to start recording after the preset time.

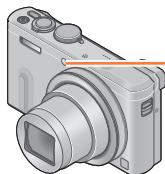

Self-timer indicator  
(Flashes for set duration)

- To cancel while in operation → Press **[MENU/SET]**.

### ■ To cancel self-timer

In step **2**, select **[ ]** or **[ ]**.

- When using zoom, the camera could tilt when the lens barrel extends. Make sure to secure the camera in place with a tripod or by other means.
- The self-timer is cancelled if the camera is turned off as **[Self Timer Auto Off]** is set to **[ON]** at the time of purchase. (→70)
- After Self-timer indicator stops flashing, it may then be lit for AF Assist Lamp.
- This function cannot be used in the following cases:
  - **[High Speed Video]** Scene Mode
  - When recording motion pictures

# Taking pictures by setting the aperture value

[Aperture-Priority] Mode

■ Recording mode: P A S M C1 C2 SCN

When recording, you can control the aperture value to meet your recording purposes. Shutter speed is automatically adjusted to be appropriate for the set aperture value.

**1** Set mode dial to [ A ]

**2** Turn the control ring or control dial to select the aperture value

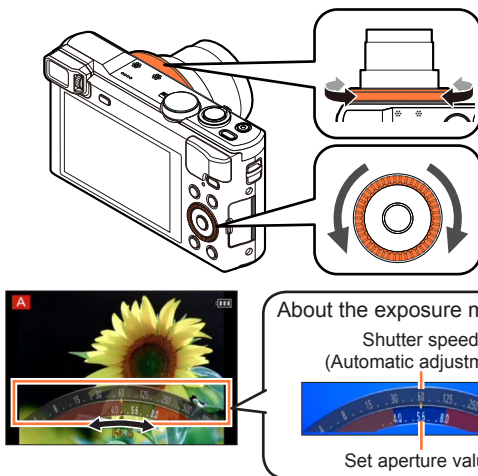

- When the aperture value is increased, the range of depth in focus expands, and the picture shows up clearly from the position of the camera to the background. When the aperture value is reduced, the range of depth in focus shrinks, and the background can get blurry.

Aperture values that can be set*1	Shutter speed set (seconds)
F3.3 - F8.0	4*2 - 1/2000

\*1 You may not be able to select some values depending on zoom position.

\*2 The lower limit of shutter speed differs depending on ISO Sensitivity. (→142)

- When the picture is too bright or too dark or there is incorrect exposure, the numbers for the aperture value and shutter speed are shown in red.
- LCD monitor or viewfinder brightness may vary from the actual still picture recorded.

# Taking pictures by setting the shutter speed

[Shutter-Priority] Mode

■ Recording mode: P A **S** M

When recording, you can control the shutter speed to meet your recording purposes. Aperture is automatically adjusted to be appropriate for the set shutter speed.

**1** Set mode dial to [ S ]

**2** Turn the control ring or control dial to select the shutter speed

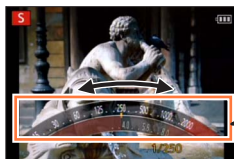
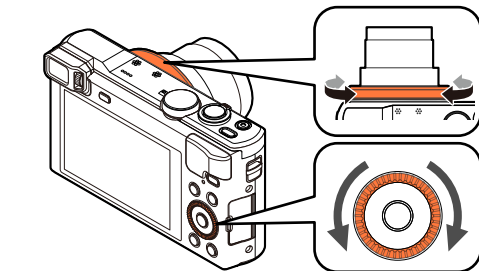

About the exposure meter

Set shutter speed



Aperture value  
(Automatic adjustment)

• Proper exposure is not possible in the range indicated in red.

- When you increase the shutter speed, you can reduce jitter when recording a subject.
- When you decrease the shutter speed, the subject's movement is shown.

Shutter speeds that can be set (seconds)	Aperture value set
4* - 1/2000	F3.3 - F8.0

\* ISO Sensitivity may be changed depending on the shutter speed that you set. ([→142](#))

- When the picture is too bright or too dark or there is incorrect exposure, the numbers for the aperture value and shutter speed are shown in red.
- LCD monitor or viewfinder brightness may vary from the actual still picture recorded.

# Taking pictures by setting the aperture value and shutter speed [Manual Exposure] Mode

■ Recording mode: P A S M C1 C2 □ SCN

Determine the exposure by manually setting the aperture value and the shutter speed. The Manual Exposure Assistance appears on the lower portion of the screen to indicate the exposure.

**1** Set mode dial to [M]

**2** Turn the control ring (A) to select the aperture value, and turn the control dial (B) to select the shutter speed

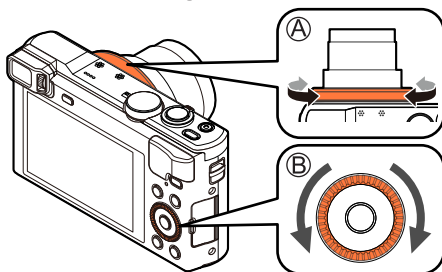

Manual exposure assist (→109)

About the exposure meter

Set shutter speed



Set aperture value

• Proper exposure is not possible in the range indicated in red.

Aperture values that can be set*1	Shutter speeds that can be set (seconds)
F3.3 - F8.0	4*2 - 1/2000



\*1 You may not be able to select some values depending on zoom position.

\*2 ISO Sensitivity may be changed depending on the shutter speed that you set. (→142)



Taking pictures by setting the aperture value and shutter speed [Manual Exposure] Mode

### ■ Manual exposure assist (estimate)

	Shows pictures with standard brightness (appropriate exposure).
	Shows brighter pictures. For the appropriate exposure, either use a faster shutter speed or increase aperture value.
	Shows darker pictures. For the appropriate exposure, either use a slower shutter speed or reduce aperture value.

- When the picture is too bright or too dark or there is incorrect exposure, the numbers for the aperture value and shutter speed are shown in red.
- LCD monitor or viewfinder brightness may vary from the actual still picture recorded.

# Taking Pictures with different picture effects

[Creative Control] Mode

■ Recording mode: P A S M

You can select your own settings from various effects and take pictures while confirming these effects on the screen.

## 1 Set mode dial to []

## 2 Use to select an effect, and then press [MENU/SET]



• If you press the [DISP.] button, an explanation of the effect appears.

## ■ Changing the selected picture effects

### ● [Creative Control] menu

- ① Press [MENU/SET]
- ② Use to select [Creative Control] menu and press [MENU/SET]
- ③ Use to select an effect, and then press [MENU/SET]

### ● Control ring/control dial

- ① Turn the control ring or control dial to select the effect



- The flash is set to [☹] ([Forced Flash Off]).
- The display of a picture reflecting a selected effect in the preview screen or recording screen may differ from the actual recorded pictures.
- A setting that was selected in [Creative Control] mode is retained even after the camera is turned off.
- Following [Rec] menu settings will be automatically adjusted and cannot be selected manually.  
[Sensitivity], [White Balance], [i.Exposure], [Min. Shtr Speed]

### ■ Adjusting the brightness, background defocusing condition, setting conditions of a selected effect, etc.

**1** Press ▲

**2** Press ▲ ▼ to select an item to adjust

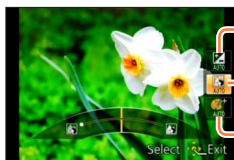

Adjusts the brightness.

Adjusts background defocusing.

Adjusts the setting conditions of the selected effect, etc. (The settings to be adjusted vary depending on the selected effect.)

- [AUTO] is displayed in the icon during automatic adjustment.
- The items that can be adjusted differ depending on the selected effect.

**3** Turn the control ring or control dial to make adjustments

- You can also make adjustments with ◀ ▶.
- To return to automatic adjustment → Press [Q.MENU/↶] button.

**4** Press [MENU/SET]

- When you record motion pictures, the camera performs aperture control within the appropriate exposure range, and the background defocusing may not change for some subject brightness levels.

For the [Creative Control] menu setting procedures. (→110)

### [Expressive]

This effect emphasises the colour to make a pop art picture.

#### ■ Items that can be set (→111)

Brightness	Underexposure (darker)	↔	Overexposure (brighter)
Degree of background defocusing	Defocuses the background	↔	The background is in focus as well
Vividness	Subdued colouring	↔	Gaudy colouring



### [Retro]

This effect gives a faded image.

#### ■ Items that can be set (→111)

Brightness	Underexposure (darker)	↔	Overexposure (brighter)
Degree of background defocusing	Defocuses the background	↔	The background is in focus as well
Colouring	Yellowish colouring	↔	Reddish colouring

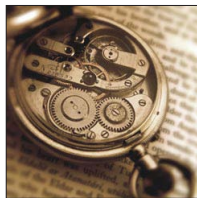

### [Old Days]

This effect adds a bright, soft and nostalgic feel to the overall image.

#### ■ Items that can be set (→111)

Brightness	Underexposure (darker)	↔	Overexposure (brighter)
Degree of background defocusing	Defocuses the background	↔	The background is in focus as well
Contrast	Low contrast	↔	High contrast



For the [Creative Control] menu setting procedures. (→110)

### [High Key]

This effect adds a bright, airy and soft feel to the overall image.

#### ■ Items that can be set (→111)

Brightness	Underexposure (darker)	↔	Overexposure (brighter)
Degree of background defocusing	Defocuses the background	↔	The background is in focus as well
Colouring	Pinkish colouring	↔	Light-bluish colouring

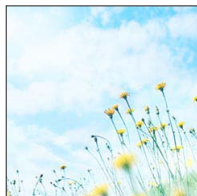

### [Low Key]

This effect adds a dark and relaxing feel to the overall image and enhances bright parts.

#### ■ Items that can be set (→111)

Brightness	Underexposure (darker)	↔	Overexposure (brighter)
Degree of background defocusing	Defocuses the background	↔	The background is in focus as well
Colouring	Reddish colouring	↔	Bluish colouring

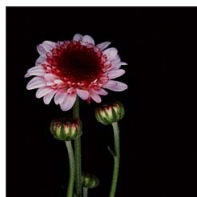

### [Sepia]

This effect creates a sepia image.

#### ■ Items that can be set (→111)

Brightness	Underexposure (darker)	↔	Overexposure (brighter)
Degree of background defocusing	Defocuses the background	↔	The background is in focus as well
Contrast	Low contrast	↔	High contrast



For the [Creative Control] menu setting procedures. (→110)

### [Dynamic Monochrome]

This effect gives a higher contrast to create an impressive black and white picture.

#### ■ Items that can be set (→111)

Brightness	Underexposure (darker)	↔	Overexposure (brighter)
Degree of background defocusing	Defocuses the background	↔	The background is in focus as well
Contrast	Low contrast	↔	High contrast



### [Impressive Art]

This effect gives your photo a dramatic contrast look.

#### ■ Items that can be set (→111)

Brightness	Underexposure (darker)	↔	Overexposure (brighter)
Degree of background defocusing	Defocuses the background	↔	The background is in focus as well
Vividness	Black & white	↔	Gaudy colouring



### [High Dynamic]

This effect produces the optimum brightness for both dark and bright parts.

#### ■ Items that can be set (→111)

Brightness	Underexposure (darker)	↔	Overexposure (brighter)
Degree of background defocusing	Defocuses the background	↔	The background is in focus as well
Vividness	Black & white	↔	Gaudy colouring



For the [Creative Control] menu setting procedures. (→110)

### [Cross Process]

This effect gives your photo a dramatic colour look.

#### ■ Items that can be set (→111)

Brightness	Underexposure (darker)	↔	Overexposure (brighter)
Degree of background defocusing	Defocuses the background	↔	The background is in focus as well
Colouring	Greenish colouring / Bluish colouring / Yellowish colouring / Reddish colouring		



### [Toy Effect]

This effect reduces peripheral brightness to give the impression of a toy camera.

#### ■ Items that can be set (→111)

Brightness	Underexposure (darker)	↔	Overexposure (brighter)
Degree of background defocusing	Defocuses the background	↔	The background is in focus as well
Colouring	Orangish colour	↔	Bluish colouring



For the [Creative Control] menu setting procedures. (→110)

### [Miniature Effect]

This effect blurs peripheral areas to give the impression of a diorama.

#### ■ Items that can be set (→111)

Brightness	Underexposure (darker)	↔	Overexposure (brighter)
Vividness	Subdued colouring	↔	Gaudy colouring



#### ■ Defocusing a picture

- ① Press [Fn] button
- ② Press ▲ ▼ or ◀ ▶ to move the focusing area (frame)
- ③ Turn the control dial to select the size of the focusing area (frame)
- ④ Press [MENU/SET]
  - When you press [DISP.] button, the initial setting condition is restored.

- The recording screen is displayed like a frame dropping with a slight delay compared to normal recording.
- No audio is recorded for motion pictures.
- When a motion picture is recorded, the finished recording will be approximately 1/8th of the actual recorded time period. (If you record a motion picture for 8 minutes, the resulting motion picture recording time will be approximately 1 minute.) The recordable time displayed on the camera is approx. 8x longer than actual time needed for recording. When the Recording Mode is changed, be sure to check the recordable time.
- If you stop recording motion pictures too soon, the camera may continue recording until a certain time. Hold the camera until the camera stops recording.
- When you take a picture using a large picture size setting, the screen will become dark for a certain period of time after the picture is taken. However, this occurs due to signal processing and is not a defect.



For the [Creative Control] menu setting procedures. (→110)

### [Soft Focus]

This effect blurs the overall image to produce a soft feel.

#### ■ Items that can be set (→111)

Brightness	Underexposure (darker)	↔	Overexposure (brighter)
Degree of background defocusing	Defocuses the background	↔	The background is in focus as well
Degree of defocusing	Slight defocusing	↔	Strong defocusing



- The recording screen is displayed like a frame dropping with a slight delay compared to normal recording.
- When you take a picture using a large picture size setting, the screen will become dark for a certain period of time after the picture is taken. However, this occurs due to signal processing and is not a defect.

### [Star Filter]

This effect transforms pin-points of light into a star effect.

#### ■ Items that can be set (→111)

Brightness	Underexposure (darker)	↔	Overexposure (brighter)
Degree of background defocusing	Defocuses the background	↔	The background is in focus as well
Length of the rays of light	Rays of light is short	↔	Rays of light is long



- The recording screen is displayed like a frame dropping with a slight delay compared to normal recording.
- When you take a picture using a large picture size setting, the screen will become dark for a certain period of time after the picture is taken. However, this occurs due to signal processing and is not a defect.

For the [Creative Control] menu setting procedures. (→110)

### [One Point Color]

This effect leaves one selected colour to emphasise impressiveness.

#### ■ Items that can be set (→111)

Brightness	Underexposure (darker)	↔	Overexposure (brighter)
Degree of background defocusing	Defocuses the background	↔	The background is in focus as well
Amount of colour retained	Leaves a small amount of colour	↔	Leaves a large amount of colour



#### ■ Selecting colour

- ① Press [Fn] button
- ② Fit the colour you want to leave in the frame at the centre of the screen, and then press [MENU/SET]

- The selected colour may not be retained for some subjects.

## Recording panorama pictures [Panorama Shot] Mode

■ Recording mode: P A S M

You can easily record a panorama picture by panning the camera towards the direction you want to record, and automatically combining the burst of pictures taken during that time.

- The recording direction is set as “left → right” and the picture effect is set to [No Effect] at the time of purchase.

### 1 Set mode dial to []

### 2 Check the recording direction and press [MENU/SET]

If you take pictures “left → right” or “right → left”, a horizontal guide line is displayed. If you take pictures “up → down” or “down → up”, a vertical guide line is displayed.

- Changing the recording direction ([→121](#))
- Changing picture effects
  - ① Turn control ring or control dial to select picture effect

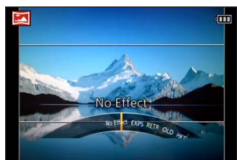

- If the settings assigned to both the control ring and control dial have been changed and the picture effect setting display does not appear ([→121](#))

- For more details about picture effects. ([→112 - 118](#))
- If you do not want to add picture effects, please select [No Effect].
- You cannot select [Toy Effect] or [Miniature Effect].
- You can adjust the brightness and setting condition of the selected effect. For details. ([→111](#))

### 3 Press the shutter button halfway to focus

(Continued on the next page)

#### 4 Press the shutter button fully and pan the camera in a small circular motion to the recording direction to start recording

- Taking pictures from left to right



Recording direction and progress status (approximate)

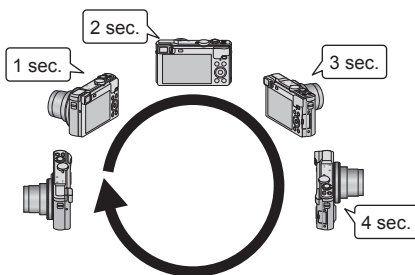

- Pan the camera so that you make a complete circuit in approx. 8 seconds
  - Pan the camera at a constant speed.
  - You may not be able to take pictures successfully if you move the camera too quickly or too slowly.
  - Pan the camera in a small circular motion.

#### 5 Press the shutter button fully again to end recording

- You can also end recording if you stop panning the camera while taking pictures.

## ■ Changing the recording direction or picture effects

- ① Press ►
- ② Use ▲▼ to select the recording direction and press [MENU/SET]
- ③ Use ▲▼ to select the picture effect and press [MENU/SET]



## ■ Tips

- Pan the camera in the recording direction as steadily as possible.

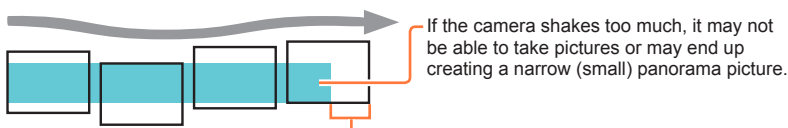

If the camera shakes too much, it may not be able to take pictures or may end up creating a narrow (small) panorama picture.

Pan the camera to a point slightly ahead of the point that you want to take.  
(However, the last frame is not recorded to the end.)

- The zoom position is fixed to the W end.
- The focus, exposure and White Balance are all fixed to optimal values for the first picture.  
If the focusing or brightness of pictures recorded as part of a Panorama picture after the first picture are significantly different from those of the first picture, the Panorama picture as a whole (when all pictures are stitched together) may not have consistent focus and brightness.
- The following functions are fixed to the settings indicated below.  
[Stabilizer]: [OFF] [Date Stamp]: [OFF]
- [White Balance] cannot be set when applying picture effects.
- Since several pictures are stitched together to create a Panorama picture, some subjects may be distorted or the joining portions of successively taken pictures that are stitched may be noticeable.
- The number of recording pixels per horizontal line and vertical line of a Panorama picture varies depending on the recording direction and number of stitched pictures. The maximum number of recording pixels is as follows:
  - Taking pictures in landscape orientation: Approx. 8000 x 1080
  - Taking pictures in portrait orientation: Approx. 1440 x 8000
- Panorama pictures may not be created or pictures may not be recorded properly when taking pictures of the following subjects or when taking pictures in the following recording conditions:
  - Subjects that have a continuous monotone or pattern (sky, beach, etc.)
  - Moving subjects (person, pet, vehicle, waves, or flowers swaying in the wind, etc.)
  - Subjects whose colours or patterns change quickly (such as an image appearing on a display)
  - Dark locations
  - Locations with a flickering light source (fluorescent lamp, candle light, etc.)
- When set to [High Key], the effect may be difficult to see, depending on the brightness of the subject.
- When set to [Impressive Art], stitches may stand out.
- While recording with [Soft Focus], [Star Filter], you cannot see the effects on the LCD monitor or viewfinder.
- Settings will be stored even if the camera is turned off.
- You can turn off display of guidelines by setting [Guide Line] to [OFF] in the [Setup] menu. (→66)

## ■ About panorama playback

Panorama pictures can be enlarged by operating the zoom lever the same way as with other still pictures. If you play back panorama pictures in the same way as playing back a motion picture, the panorama pictures are scrolled automatically. (→56)

- Unlike motion picture playback, you cannot perform fast forward or fast rewind while the panorama pictures are scrolling automatically. (You can perform single-frame forward or rewind while the automatic scrolling operation is paused.)

## Taking pictures according to the scene [Scene Mode]

■ **Recording mode:** P A S M

Using [Scene Mode] enables you to take pictures with optimum settings (exposure, colouring, etc.) for given scenes.

### 1 Set mode dial to [SCN]

### 2 Use to select the scene and press [MENU/SET]



### ■ Changing the selected Scene Mode

#### ● [Scene Mode] menu

- ① Press [MENU/SET]
- ② Use to select [Scene Mode] menu and press [MENU/SET]
- ③ Use to select the scene and press [MENU/SET]

#### ● Control ring/control dial

- ① Turn the control ring or control dial to select the scene

- Selecting a Scene Mode inappropriate for the actual scene may affect the colouring of your picture.
- Following [Rec] menu settings will be automatically adjusted and cannot be selected manually.  
[Sensitivity], [Metering Mode], [i.Exposure], [Min. Shtr Speed], [i.Resolution]

- How to select a scene (→123)

## [Portrait]

Improves the skin tone of subjects for a healthier appearance in bright daylight conditions.

### ■ Tips

- The more the zoom is drawn towards T side and a distant background is selected, the greater the effect will be.

## [Soft Skin]

Smooths skin colours in bright, outdoor daylight conditions (portraits from chest upwards).

### ■ Tips

- The more the zoom is drawn towards T side and a distant background is selected, the greater the effect will be.

## [Scenery]

Takes clear pictures of wide, distant subjects.



- How to select a scene (→123)

## [Sports]

Takes pictures of scenes with fast movement, e.g. sports.

### ■ Tips

- Stand at least 5 m (16 feet) away.
- Shutter speed may slow down up to 1 second.

## [Night Portrait]

Takes pictures of people and nightscapes with close to actual brightness.

### ■ Tips

- Use flash.
- Subject should not move.
- Tripod, self-timer recommended.
- Shutter speed may slow down up to 4 seconds.
- After recording, the shutter may stay closed (up to 4 seconds) to process the signal. This is not a malfunction.

## [Night Scenery]

Takes clear pictures of night scenes.

### ■ Tips

- Tripod, self-timer recommended.
- Shutter speed may slow down up to 4 seconds.
- After recording, the shutter may stay closed (up to 4 seconds) to process the signal. This is not a malfunction.

- How to select a scene (→123)

## [Handheld Night Shot]

Takes clear still pictures of night scenes with less jitter and less noise by combining a burst of still pictures.

### ■ Tips

- After the shutter button has been pressed, do not move the camera during the burst operation.
- Stand at least 5 m (16 feet) away.

- Since a burst of still pictures are combined after they have been recorded, it will be a few moments before you will be able to record another picture.

## [HDR]

The camera can combine several still pictures taken with different exposures into a single properly exposed picture with rich gradation. The individual pictures used to create the HDR picture are not saved. You can minimise the loss of gradations in bright areas and dark areas when, for example, the contrast between the background and the subject is large.

### ■ What is HDR?

HDR stands for High Dynamic Range and refers to a technique for expressing a wide contrast range.

### ■ Tips

- After the shutter button has been pressed, do not move the camera during the burst operation.

- Since a burst of still pictures are combined after they have been recorded, it will be a few moments before you will be able to record another picture.
- A subject that was in motion when it was recorded may be recorded as an afterimage.
- The camera may take a single still picture instead of several pictures under certain recording conditions.

## [Food]

Takes natural-looking pictures of food with the entire image appearing bright, regardless of the ambient light.

- How to select a scene (→123)

**[Baby]**

This takes pictures of a baby with a healthy complexion. When you use the flash, the light from it is weaker than usual.

**■To record age and name**

[Baby1] and [Baby2] can be set separately.

**1** Use ▲ ▼ to select [Age] or [Name] and press [MENU/SET]

**2** Use ▲ ▼ to select [SET] and press [MENU/SET]

**3** Set the birthday and name

Age: Set birthday with ▲ ▼ ◀ ▶, and press [MENU/SET]

Name: (See "Entering Text": (→75))

**4** Use ▲ ▼ to select [Exit] and press [MENU/SET]

**■Tips**

- Make sure [Age] and [Name] are [ON] before taking a picture.

- Age display format depends on [Language] setting.
- Shutter speed may slow down up to 1 second.
- [Age] and [Name] print setting can be made on your computer using "PHOTOfunSTUDIO" on the supplied CD-ROM. Text may also be stamped onto the still picture using [Text Stamp].

**[Pet]**

Records pet's age and name when taking pictures.

- Refer to [Baby] for other tips etc.

**[Sunset]**

Takes clear pictures of scenes such as sunsets.

Taking pictures according to the scene [Scene Mode]

- How to select a scene (→123)

## [High Sens.]

Prevents blurring of subject in dark, indoor conditions.

**1** Use ▲ ▼ to select the aspect ratio, and then press [MENU/SET]

- Settings: 4:3 [3M] / 3:2 [2.5M] / 16:9 [2M] / 1:1 [2.5M]

## [Starry Sky]

Gives starry skies and dark subjects a clear appearance.

**1** Use ▲ ▼ to select shutter speed, and then press [MENU/SET]

- Settings: [15 sec.] / [30 sec.]

### ■ Tips

- Tripod, self-timer recommended.
- Do not move the camera until the countdown is finished. After taking the picture, the countdown is displayed again while the signal is processed.
- [Stabilizer] does not work.

## [Glass Through]

The camera prioritises focusing on distant subjects. Most suitable for taking pictures such as a landscapes through the transparent glass of a train/vehicle or building.

- If there are stains such as dust or a reflection on the glass, the camera may focus on the glass instead of a subject.
- The colour of pictures may appear unnatural due to the colour of the glass.  
(You may be able to reproduce the appropriate colour by adjusting the White Balance.  
(→144))

- How to select a scene (→123)

### [High Speed Video]

Motion pictures are recorded by greatly increasing frames per second, so movement can be displayed in slow motion during playback.

## 1 Use ▲ ▼ to select motion picture quality (frame rate), then press [MENU/SET]

fps	Picture size	Rec Format
200fps	VGA 640×480	MP4
100fps	HD 1280×720	

## 2 Press the motion picture button to start recording

## 3 Press the motion picture button again to finish recording

- Motion picture recording can also be started or finished by pressing the shutter button.
- During playback, the movements of a subject that cannot be seen by the naked eye can be made recognisable by playing back the motion pictures using slow motion.

- High-speed motion pictures cannot be recorded in the built-in memory.
- No sound is recorded.
- Still pictures cannot be recorded while high-speed motion pictures are being recorded.
- The settings for the focus, zoom, exposure and White Balance are fixed to the settings specified when recording was started.
- [Stabilizer] does not work.
- The [AF Mode] is set to [□] (1-area-focusing).
- Flickering or horizontal stripes may appear while recording under fluorescent lighting.

- How to select a scene (→123)

### [3D Photo Mode]

Pictures are recorded continuously while moving the camera horizontally, and two pictures selected automatically are combined to make a single 3D picture.

To view 3D pictures, a television that supports 3D is required. (This unit will play back in 2D.) (→281)

- 3D still pictures are recorded in MPO format (3D).
- The picture size is fixed to 2M [16:9].

## 1 Start the recording and then pan the camera horizontally straight from left to right

- A guide is displayed while recording.
- Move the camera approximately 10 cm (0.33 feet) within approximately 4 seconds using the guide.

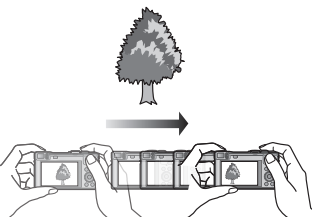

### Tips for recording pictures

- Record a stationary subject.
- Record a picture outdoors or in other bright locations.
- Press the shutter button halfway to fix the focus and the exposure, press the shutter button fully, and then pan the camera.
- Hold the camera so that the subject is slightly to the right of the centre on the display at the start of the recording. This makes it easier to position the subject in the centre of the recorded picture.

- **3D still pictures cannot be recorded by holding this camera vertically.**
- The zoom position is fixed to the W end.
- ISO Sensitivity is automatically adjusted. However, ISO Sensitivity is increased to make the shutter speed faster.
- Motion pictures cannot be recorded.
- [Stabilizer] does not work.
- It may be impossible to record pictures under any of the conditions below. Even if pictures are recorded, they may not have a 3D effect or may appear distorted.
  - When the subject is too dark or too bright
  - When the subject's brightness changes
  - When the subject is moving
  - When the subject lacks contrast

## Registering your own settings and recording

[Custom] Mode

Registering your preferred Recording Mode, [Rec] menu settings, etc. to [Cust.Set Mem.] and setting the mode dial to [C1] / [C2] allows you to switch quickly to those settings.

[Cust.Set Mem.]

■ Recording mode: 

Up to 4 current camera settings can be registered.

### 1 Select the Recording Mode you wish to register and set the [Rec] menu, [Motion Picture] menu, [Setup] menu, etc.

- For the setting procedures of the menu. (→60)

### 2 Select [Cust.Set Mem.] from the [Setup] menu

### 3 Use ▲ ▼ to select custom set for registration and press [MENU/SET]

- A confirmation screen is displayed. Select [Yes] and press [MENU/SET].
- The custom settings registered in [C1] can be used with the [C1] of the mode dial. It will be convenient if the custom setting used often is registered, since it can be used by just setting the mode dial.
- The custom settings registered in [C2-1], [C2-2] or [C2-3] can be selected in the [C2] of the mode dial. Up to 3 custom settings can be registered, so select the one matching the needs.

● Some menu items are not saved, such as [Clock Set] and [Beep].

## [Custom]

■ Recording mode:  P A S M **C1** **C2** SCN

Settings registered in [Cust.Set Mem.] can be quickly called up by setting the mode dial to [C1] / [C2].

## 1 Set mode dial to [C1] / [C2] ([Custom] mode)

- When set to [C1]  
→ The camera switches to the Recording Mode and settings registered in [C1].
- When set to [C2]  
→ Perform steps **2** - **3**.

## 2 Use ▲ ▼ to select custom set

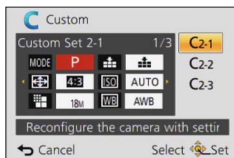

- Use ◀ and ▶ to confirm the registered settings.
- Only the main menu items are displayed.

## 3 Press [MENU/SET] to enter the settings

The camera switches to the Recording Mode and settings of the selected custom set.

### ■ When changing the menu settings

Even if the menu settings are changed temporarily when [C1], [C2-1], [C2-2] or [C2-3] is selected for using the custom set, the currently registered settings will remain unchanged.

To change the currently registered settings, overwrite the registered data using [Cust. Set Mem.] (→131) on the [Setup] menu.

### ■ Changing from one [C2] custom setting to another [C2] custom setting ([Custom] menu)

- ① Press [MENU/SET]
- ② Use ▲ ▼ ◀ ▶ to select [Custom] menu and press [MENU/SET]
- ③ Use ▲ ▼ to select custom set and press [MENU/SET]



## Registering preferred functions to the [Fn] button

■ Recording mode:

Register frequently used functions from the [Rec] menu, [Setup] menu or other menus to the [Fn] button for faster operation.

- It is set to [Composition Guide] at the time of purchase.

### ■ How to register

**1** Select [Fn Button Set] from [Setup] menu and press [MENU/SET] (→60)

**2** Use ▲ ▼ to select the function to register and press [MENU/SET]

[AF/AE Lock] (→99)	[1 Shot AF] (→97)
[Metering Mode] (→147)	[AF Mode] (→88)
[Focus Area Set] (→92)	[Quality] (→141)
[Composition Guide] (→77)	[Histogram] (→67)
[Peaking] (→98)	

### ■ Using registered functions

**1** Press [Fn] button

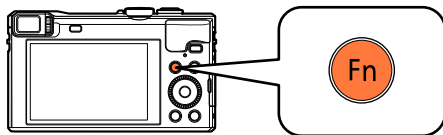

- The registered function is called.

● The function assigned to the [Fn] button will not work in the following cases:

- [Creative Control] Mode ([Miniature Effect], [One Point Color])

## Changing the settings assigned to the control ring/control dial

■ Recording mode:

Changes the settings assigned to the control ring/control dial.

- 1** Select [Ring/Dial Set] from [Setup] menu and press [MENU/SET] (→60)
- 2** Use ▲ ▼ to select [(0)] (control ring) or [(0)] (control dial) and press [MENU/SET]
- 3** Use ▲ ▼ to select the setting and press [MENU/SET]

Control ring	Control dial
[DEFLT] [Default Control]	
Q [Zoom] (→80)	
Q [Step Zoom] (→83)	
[Exposure Comp.] (→100)	
[Aspect Ratio] (→140)	
[Sensitivity] (→142)	
[White Balance] (→144)	
[OFF] [Not Set]	—

- To return to the default setting, select [Default Control]. (→33)
- If you do not use the control ring, select [Not Set].

### ■ When the settings assigned to both the control ring and control dial have been changed

- Programme Shift cannot be used in [Program AE] Mode.
- The following operations can be performed from the Quick menu (→34):
  - Aperture adjustment in [Aperture-Priority] mode
  - Shutter speed adjustment in [Shutter-Priority] mode
  - Aperture and shutter speed adjustment in [Manual Exposure] mode

- The assigned function setting applies to all the Recording Modes. However, the assigned function may not operate when combined with certain Recording Mode.
- Manual Focus can be performed from the Quick menu even if the control ring settings have been changed. (→34)

## Recording with the Face Recognition function

[Face Recog.]

■ Recording mode: **[A]** **[P]** **[A]** **[S]** **[M]** **[C1]** **[C2]** **[ ]** **[SCN]** **[ ]**

- Default [Face Recog.] setting is [OFF].
- When the face pictures are registered, the setting will be [ON] automatically.

### ■ How the Face Recognition function works

#### During recording

- The camera recognises a registered face and adjusts focus and exposure.
- When registered faces that have set names are recognised, the names are displayed (max. 3 people).

#### During playback

- The name and age are displayed (if information is registered).
- The names that have been set for the recognised faces are displayed (max. 3 people).
- Only pictures of the selected registered people are played back ([Category Selection] in [Filtering Play] or [Slide Show]).



- Face Recognition searches for faces similar to those registered, but there is no guarantee it will always recognise these faces. In some cases, the camera cannot recognise or incorrectly recognises even registered people depending on their expression or the environment.
- **Even if Face Recognition information is changed, Face Recognition information for previously recorded pictures is not changed.**  
For example, if a name is changed, pictures recorded before the change are not categorised for Face Recognition in [Category Selection].
- Only the first picture of the burst recording will contain Face Recognition information.
- If you press the shutter button halfway, then point the camera at a different subject and record, recording information for a different person may be added to the picture.
- Face Recognition does not work in the following cases:
  - [Creative Control] Mode ([Miniature Effect], [Soft Focus])
  - Scene Modes ([Night Scenery], [Handheld Night Shot], [Food], [Starry Sky], [High Speed Video], [3D Photo Mode])
  - When recording motion pictures
- Even if Face Recognition information is registered, pictures recorded when the name is [OFF] are not categorised for Face Recognition in [Category Selection].
- To change name information for pictures already recorded, perform a [REPLACE] (→183) in [Face Rec Edit].

## Registering face pictures

Up to 6 people's face pictures can be registered along with such information as name and birthdate.

You can facilitate Face Recognition by the way you register faces: for example, register multiple face pictures of the same person (up to 3 pictures in one registration).

**1** Select [Face Recog.] from the [Rec] menu (→60)

**2** Use ▲ ▼ to select [MEMORY] and then press [MENU/SET]

**3** Use ▲ ▼ ◀ ▶ to select [New] and then press [MENU/SET]  
 • If 6 people are already registered, first delete a registered person. (→137)

**4** Record the face picture

- ① Align the face with the guide and record
- ② Use ◀ to select [Yes] and press [MENU/SET]
  - If re-recording, select [No].
  - Faces of subjects other than people (e.g. pets) cannot be registered.
  - When [DISP.] button is pressed, an explanation is displayed.

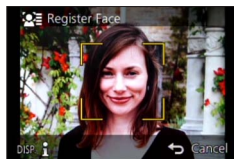

**5** Press ▲ ▼ to select the item for editing and press [MENU/SET]

[Name]	<ol style="list-style-type: none"> <li>① Use ▲ ▼ to select [SET] and then press [MENU/SET]</li> <li>② Enter the name (See "Entering Text": (→75))</li> </ol>
[Age]	Set the birthdate. <ol style="list-style-type: none"> <li>① Use ▲ ▼ to select [SET] and then press [MENU/SET]</li> <li>② Use ◀ ▶ to select year, month and day, set with ▲ ▼, and press [MENU/SET]</li> </ol>
[Focus Icon]	Change the icon that is displayed when the subject is in focus. <ol style="list-style-type: none"> <li>① Use ▲ ▼ to select the focus icon and press [MENU/SET]</li> </ol>
[Add Images]	Up to 3 face pictures of the person can be registered. <ol style="list-style-type: none"> <li>① Use ◀ ▶ to select [Add Images] and press [MENU/SET]               <ul style="list-style-type: none"> <li>• When a registered face picture is selected with cursor button, a screen to confirm deletion is displayed. Select [Yes] to delete the face picture. (If only one picture is registered, it cannot be deleted.)</li> </ul> </li> <li>② Record the picture (step 4 above)</li> <li>③ Press [Q.MENU/↶] button</li> </ol>

**■ Recording tips when registering face pictures**

- Make sure the subject's eyes are open and mouth closed; have the subject face the camera directly, and make sure the outline of the face, the eyes and eyebrows are not hidden by hair.
- Make sure there are no heavy shadows on the face. (During registration, the flash is not used.)

**■ If the camera seems to have difficulty recognising faces when recording**

- Register additional pictures of the same person's face, indoors and outdoors or with different expressions or angles.
- Register additional pictures at the place you are recording.
- If a registered person is no longer recognised, re-register that person.

**Editing or deleting information about registered persons**

Information about registered people can be edited or deleted.

- 1** Select [Face Recog.] from the [Rec] menu (→60)
- 2** Use ▲ ▼ to select [MEMORY] and then press [MENU/SET]
- 3** Use ▲ ▼ ◀ ▶ to select the picture of the person to be edited or deleted and press [MENU/SET]
- 4** Use ▲ ▼ to select the item and press [MENU/SET]

[Info Edit]	Edit name or other registered information. (→136)
[Priority]	Set priority order for focus and exposure. ① Use ▲ ▼ ◀ ▶ to select the registration order and press [MENU/SET]
[Delete]	Delete information and face pictures of registered persons.

## Useful features for travel

### [Travel Date]

If you set your travel schedule and record pictures, the day of your trip on which the picture was taken will be recorded.

- 1** Select [Travel Date] from the [Setup] menu (→60)
- 2** Use ▲ ▼ to select [Travel Setup] and press [MENU/SET]
- 3** Use ▲ ▼ to select [SET] and press [MENU/SET]
- 4** Use ▲ ▼ ◀ ▶ to select the departure date and press [MENU/SET]
- 5** Use ▲ ▼ ◀ ▶ to select the return date and press [MENU/SET]

### ■ To record [Location]

Once the [Travel Setup] is set, you can set the location.

- ① Select [Location] in step **2** above
- ② Use ▲ ▼ to select [SET] and press [MENU/SET]
- ③ Enter your location (Entering text (→75))

- The travel date is calculated from the set departure date and the date set in the camera's clock. When destination is set in [World Time], days elapsed are calculated based on local destination time.
- When [Travel Setup] is set to [OFF], the number of days elapsed is not recorded. It is not displayed even if [Travel Setup] is set to [SET] after recording.
- If settings are made before departure date, number of days to departure are not recorded.
- [Location] is recorded separately from the location name information which is recorded on the pictures by the GPS function.
- To print [Location] or the number of days that have passed, either use [Text Stamp] or print using the "PHOTOfunSTUDIO" software on the supplied CD-ROM.
- [Travel Date] cannot be recorded for AVCHD motion pictures. (Except [G])
- Cannot be set when using [Intelligent Auto] Mode. The settings in other Recording Mode are applied.

## [World Time]

Set the recording date and time with the local time at your destination.

**Preparation:** Set [Auto Clock Set] to [OFF]. (→265)

### 1 Select [World Time] from the [Setup] menu (→60)

- A message such as [Please set the home area] will be displayed when setting for the first time. In this case, press [MENU/SET] and skip to step 3.

### 2 Use ▲ ▼ to select [Destination] and press [MENU/SET]

### 3 Use ◀ ▶ to select area and press [MENU/SET]



When [Destination] has been selected

### ■ To set daylight savings

Press ▲ in step 3. (Press ▲ again to release the setting)

- When daylight savings is set, the current time is advanced by 1 hour. If the setting is cancelled, the time automatically returns to the current time.

### ■ When you come back from your travel destination

Select [Home] and press [MENU/SET] twice in step 2

- If you cannot find your destination in the area displayed on the screen, set based on difference with home time.
- [✈] is displayed on the screen for pictures recorded at the destination when they are played back.
- When [Auto Clock Set] is set to [ON], you cannot change the area of [Destination]. (You can only change the daylight savings setting of [Destination].)

## Using the [Rec] menu

You can perform settings such as tones, Sensitivity, Aspect Ratio, and Picture Size.

- For the setting procedures of the menu. (→60)

### [Aspect Ratio]

■ Recording mode:

Set the aspect ratio of still pictures.

■ Settings: [**4:3**] / [**3:2**] / [**16:9**] / [**1:1**]

- Edges may be cut off when printing – be sure to check in advance. (→314)
- Cannot be set in the following case:
  - [3D Photo Mode] Scene Mode

### [Picture Size]

■ Recording mode:

Set the size (number of pixels) of still pictures. Number of pictures which can be recorded depends on this setting and on [Quality].

#### ■ Settings

[Aspect Ratio]	4:3	3:2	16:9	1:1
[Picture Size]	<b>18M</b> 4896×3672	<b>16M</b> 4896×3264	<b>13.5M</b> 4896×2752	<b>13.5M</b> 3664×3664
	<b>12M</b> * 4000×3000	<b>10.5M</b> * 4000×2672	<b>9M</b> * 4000×2248	<b>9M</b> * 2992×2992
	<b>8M</b> * 3264×2448	<b>7M</b> * 3264×2176	<b>6M</b> * 3264×1840	<b>6M</b> * 2448×2448
	<b>5M</b> * 2560×1920	<b>4.5M</b> * 2560×1712	<b>3.5M</b> * 2560×1440	<b>3.5M</b> * 1920×1920
	<b>3M</b> * 2048×1536	<b>2.5M</b> * 2048×1360	<b>2M</b> * 1920×1080	<b>2.5M</b> * 1536×1536
	<b>0.3M</b> * 640×480	<b>0.3M</b> * 640×424	<b>0.2M</b> * 640×360	<b>0.2M</b> * 480×480

\*This setting is not available in ([Intelligent Auto] Mode).

#### Setting guide

Larger picture size	←→	Smaller picture size
Sharper		Less detailed
Lower recording capacity		Higher recording capacity



- Mosaic effect may appear depending on subject and recording conditions.
- Cannot be set in the following cases:
  - Scene Modes ([High Sens.], [3D Photo Mode])
  - When [Quality] is set to [RAW]

- For the setting procedures of the menu. (→60)

## [Quality]

■ Recording mode:

Set the picture quality.

### ■ Settings

[Fine]	Gives priority to picture quality and saves pictures in JPEG file format.
[Standard]	Saves pictures in JPEG file format using standard picture quality.
[RAW+Fine]	Saves pictures in JPEG file format in addition to the RAW file format.*1
[RAW+Standard]	
[RAW]	Saves pictures in the RAW file format.*2
[3D+Fine]	Simultaneously saves 3D still picture data (MPO) and pictures in JPEG file format. (Only when [3D Photo Mode] Scene Mode is set.)
[3D+Standard]	

\*1 If you delete a RAW file from the camera, the corresponding JPEG file is also deleted.

\*2 You cannot set the picture size. (The pictures are saved using the maximum recordable pixels for each image aspect ratio.)

### ■ About RAW file

In RAW file format the data is saved without any picture processing by the camera. It provides higher picture quality than the JPEG format, but the amount of data is larger. You can use Ichikawa Soft Laboratory's "SILKYPIX Developer Studio SE" to save RAW file format pictures in file formats (JPEG, TIFF, etc.) that can be displayed on a PC, etc., and to perform advanced editing such as correcting the white balance of pictures recorded previously.

Download "SILKYPIX Developer Studio SE" from website and install it on your computer to use. For details on how to download the software, etc., refer to (→287).

- [Quality] is fixed to ([Standard]) in [High Sens.] Scene Mode.
- You cannot set to , , or [RAW] in the following cases:
  - [Panorama Shot] Mode
  - Scene Modes ([Handheld Night Shot], [HDR])
  - When the [Burst] setting is set to or

- For the setting procedures of the menu. (→60)

## [Sensitivity]

■ Recording mode: **P** **A** **S** **M** **C1** **C2**

Set ISO Sensitivity (sensitivity to lighting) manually.

We recommend higher settings to take clear pictures in darker locations.

■ Settings: [AUTO] / [ISO] / [100] / [200] / [400] / [800] / [1600] / [3200] / [H.6400]\*

### Setting guide

[Sensitivity]	[100] ←→ [H.6400]*
Location (recommended)	Bright (outdoors) <span style="float:right">Dark</span>
Shutter speed	Slow <span style="float:right">Fast</span>
Interference	Low <span style="float:right">High</span>
Subject blur	High <span style="float:right">Low</span>

- [AUTO] is automatically set in a range up to 1600 based on subject brightness.
- [ISO] is automatically set in a range up to 1600 based on subject movement and brightness.
- The [Sensitivity] is automatically set in the following cases:
  - When recording motion pictures
  - When [Burst] is set to [ ]
- The shutter speed is restricted as follows based on the [Sensitivity] setting.

[Sensitivity]	Shutter speed (seconds)
AUTO / [ISO]	Automatically changes depending on the [Sensitivity] setting.
100/200/400	4 - 1/2000
800/1600	1 - 1/2000
3200/H.6400*	1/4 - 1/2000

- Cannot select [ISO] in [Shutter-Priority] Mode.
- Cannot select [AUTO] or [ISO] in [Manual Exposure] Mode.

\* Only when [Extended ISO] is [ON].

- For the setting procedures of the menu. (→60)

### [ISO Limit Set]

■ **Recording mode:**     M    

You can set the upper limit of ISO Sensitivity when [Sensitivity] is set to [AUTO] or [ISO].

■ **Settings:** [AUTO] / [200] / [400] / [800] / [1600] / [3200]

- This function is disabled during motion picture recording.

### [Extended ISO]

■ **Recording mode:**     M    

Extends the [Sensitivity] setting to [H.6400].

■ **Settings:** [ON] / [OFF]

- For the setting procedures of the menu. (→60)

## [White Balance]

- Recording mode:

Adjust the colour depending on the light source to ensure natural colour.

### ■ Settings

<b>AWB (automatic white balance)</b>	Automatic adjustment in accordance with the light source.
(clear sky)	Adjust to the colour under a clear sky.
(cloudy sky)	Adjust to the colour under a cloudy sky.
(shade)	Adjust to the colour in the shade.
(Incandescent lighting)	Adjust to the colour under incandescent lights.
(set mode)	Using the preset White Balance.
SET (set mode settings)	Adjust white balance manually.

- When [AWB] (Automatic White Balance) is set, the colouring is adjusted in accordance with the light source. However, if the scene is too bright or too dark or if other extreme conditions apply, the pictures may appear reddish or bluish. The White Balance may not operate correctly if there is a multiple number of light sources.
- Under fluorescent lighting, LED lighting fixture etc., the appropriate White Balance will vary depending on the lighting type, so use [AWB] or [ SET].
- [White Balance] setting is fixed to [AWB] in the following cases:
  - Scene Modes ([Scenery], [Night Portrait], [Night Scenery], [Handheld Night Shot], [Food], [Sunset], [Starry Sky])
  - Except when [Panorama Shot] Mode effect is [No Effect]
- Even if the camera is turned off, the previously set White Balance value is remembered. (If the Scene Mode is changed, the White Balance setting returns automatically to [AWB].)

### ■ White Balance fine adjustment (excluding [AWB])

White Balance settings can be individually fine-tuned if colours still do not appear as anticipated.

- ① Select the White Balance to be fine-tuned, and press the [DISP.] button to display the [WB Adjust.] screen
- ② Turn the control ring or the control dial to the right if red is strong and to the left if blue is strong
  - You can also press ◀▶ to make adjustments.
- ③ Press [MENU/SET]
  - Settings are remembered even if the camera is turned off.
  - Settings remain applied when using flash.

### ■ Setting White Balance manually ([WB,SET])

Take a picture of a white object under the target light source to adjust colours.

- ① Select [WB,SET] and press [MENU/SET]
- ② Point the camera towards a white object (e.g. paper) and press [MENU/SET]  
White Balance is set to [WB,SET].
  - Even if the camera is turned off, the previously set White Balance value is remembered.
  - It may not be possible to set the correct White Balance if subjects are too bright or too dark. In this case, adjust the brightness and try to set the White Balance again.

### ■ [AWB] operational range:

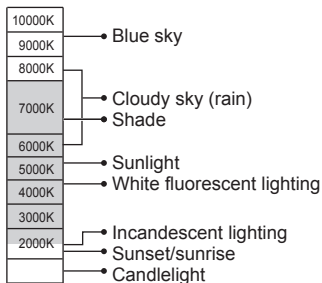

K=Kelvin Colour Temperature

- For the setting procedures of the menu. (→60)

## [AF Mode]

■ Recording mode:  **P** **A** **S** **M** **C1** **C2**  **SCN** 

For details (→88).

## [Quick AF]

■ Recording mode:  **P** **A** **S** **M** **C1** **C2**  **SCN** 

The focus is automatically adjusted when camera blurring is small even when the shutter button is not pressed. (Increases battery consumption)

■ Settings: [ON] / [OFF]

- Focus alignment may take time if zoom is suddenly changed from max. W to max. T, or if suddenly moving closer to subject.
- Press shutter button halfway if focus is difficult to align.
- The function will turn [OFF] in the following cases:  
Scene Modes ([Night Portrait], [Night Scenery], [Handheld Night Shot], [Starry Sky], [High Speed Video])
- [Quick AF] will not work while AF Tracking is operating.

## [Face Recog.]

■ Recording mode:  **P** **A** **S** **M** **C1** **C2**  **SCN** 

For details (→135).

## [AF/AE Lock]

■ Recording mode:  **P** **A** **S** **M** **C1** **C2**  **SCN** 

For details (→99).

- For the setting procedures of the menu. (→60)

### [Metering Mode]

- Recording mode:

You can change the position for measuring brightness when correcting exposure.

#### ■ Settings

[Metering Mode]	Brightness measurement position	Conditions
 [Multi Metering]	Whole screen	Normal usage (produces balanced pictures)
 [Center Weighted]	Centre and surrounding area	Subject in centre
 [Spot]	Centre and close surrounding area	Great difference between brightness of subject and background (e.g. person in spotlight on stage, backlighting)

### [i.Exposure]

- Recording mode:

Automatically adjusts contrast and exposure to give more lifelike colours when there is significant contrast between background and subject.

- When [i.Exposure] works, the colour of changes.

#### ■ Settings: [ON] / [OFF]

- Even if [Sensitivity] is set to [100], when [i.Exposure] is activated, pictures may be taken at a higher ISO Sensitivity than the setting.
- Cannot be set in the following case:
  - When the [Quality] setting is set to , or [RAW]

- For the setting procedures of the menu. (→60)

### [Min. Shtr Speed]

- Recording mode: **P** **A** **S** **M** **C1** **C2**

Sets the minimum value for the shutter speed. We recommend using slower shutter speeds to take brighter pictures in dark locations.

- Settings: [AUTO] [1/250] [1/125] [1/60] [1/30] [1/15] [1/8] [1/4] [1/2]\*1 [1]\*1

\*1 If the ISO Sensitivity setting is [3200] or [H.6400]\*2, the shutter speed becomes [1/4].

\*2 Only when [Extended ISO] is [ON]. (→143)

- Slower shutter speeds allow for brighter pictures but increase risk of jitter, so we recommend using a tripod and the self-timer.
- As still pictures may become dark when using faster values such as [1/250], we recommend that still pictures are taken in bright locations ([MIN] flashes red when shutter button is pressed halfway if still picture will be dark).
- [MIN] displayed on screen for settings other than [AUTO].

### [i.Resolution]

- Recording mode: **P** **A** **S** **M** **C1** **C2**

You can use the camera's Intelligent Resolution technology to record still pictures with sharper outlines and clearer resolution.

- Settings: [ON] / [OFF]

### [i.Zoom]

- Recording mode: **P** **A** **S** **M** **C1** **C2**

For details (→82).

- Settings: [ON] / [OFF]

### [Digital Zoom]

- Recording mode: **P** **A** **S** **M** **C1** **C2**

For details (→82).

- Settings: [ON] / [OFF]



- For the setting procedures of the menu. (→60)

### [AF Assist Lamp]

- **Recording mode:** **P** **A** **S** **M** **C1** **C2** **SCN**

Illuminates lamp when dark to facilitate focus alignment.

#### ■ Settings

<b>[ON]</b>	Lamp illuminated with halfway press of shutter button. ([AF*] appears.)
<b>[OFF]</b>	Lamp is not illuminated. (Taking pictures of animals in the dark, etc.)

- The AF Assist Lamp has an effective distance of 1.5 m (4.9 feet).
  - The AF Assist Lamp's effective distance becomes shorter when using the zoom and depending on subject conditions.
  - Do not block the lamp with your fingers or look at it from close range.
- The setting is fixed to [OFF] in the following Scene Modes:  
[Scenery], [Night Scenery], [Handheld Night Shot], [Sunset], [Glass Through], [High Speed Video]

### [Red-Eye Removal]

- **Recording mode:** **P** **A** **S** **M** **C1** **C2** **SCN**

Automatically detects red-eye and corrects still picture data when recording with flash red-eye reduction ([, []).

#### ■ Settings: [ON] / [OFF]

- Depending on the circumstance, it may not be possible to correct red-eye.
- When this function is set to [ON], the flash icon changes to [, [].
- This function only works when the camera detects a subject as a face.
- The setting is set to [OFF] except in the following Scene Modes:  
[Portrait], [Soft Skin], [Night Portrait], [Baby]

- For the setting procedures of the menu. (→60)

### [Motion Deblur]

■ Recording mode: P A S M C1 C2 □ SCN

For details (→38).

### [iHandheld Night Shot]

■ Recording mode: P A S M C1 C2 □ SCN

For details (→39).

### [iHDR]

■ Recording mode: P A S M C1 C2 □ SCN

For details (→39).

### [Stabilizer]

■ Recording mode: **P** **A** **S** **M** **C1** **C2** □ SCN

Automatically detects and prevents jitter.

■ Settings: [ON] / [OFF]

- The setting is fixed to [ON] in [Handheld Night Shot] Scene Mode.
- The setting is fixed to [OFF] in the following Scene Modes:  
[Starry Sky], [High Speed Video], [3D Photo Mode]
- The 5-axis Hybrid Image Stabiliser function automatically functions while recording motion pictures. This decreases the jitter of the image when recording motion pictures while zooming or walking, etc.
  - The recording range may become narrower.
  - If you record an [MP4] motion picture with the [Rec Quality] set to [VGA/25p], the stabiliser function may be weaker compared to other picture quality settings.
- Cases where the stabiliser function may be ineffective:
  - When there is a lot of jitter
  - When the zoom magnification is high (also in the Digital Zoom range)
  - When taking pictures while following a moving subject
  - When the shutter speed becomes slower to take pictures indoors or in dark places

- For the setting procedures of the menu. (→60)

### [Date Stamp]

■ **Recording mode:**          

Still pictures can be taken with the recording date and time stamped on the still picture.

■ **Settings:** [W/O TIME] / [WITH TIME] / [OFF]

- Do not request date printing in store or make date printing on printer for still pictures with date stamps. (Date printing may be overlapped.)
- Date stamps on still pictures cannot be erased.
- The setting is fixed to [OFF] in the following cases:
  - Scene Modes ([High Speed Video], [3D Photo Mode])
  - When recording motion pictures
  - When using Auto Bracket
  - When using [Burst]
- Cannot change the setting in [Intelligent Auto] Mode. The setting in other Recording Mode is applied.

## Using the [Motion Picture] menu

You can select the Recording Mode and picture quality and other settings.

- For the setting procedures of the menu. (→60)

### [Rec Format]

■ Recording mode: 

Sets the data format of the motion picture that is recorded.

#### ■ Settings

[AVCHD]	This is a data format suitable for playback on high-definition TVs.
[MP4]	This data format is suited for playing back motion pictures on a computer and other such devices.

- For details (→49)

### [Rec Quality]



■ Recording mode: 

Sets the picture quality of the motion picture that is recorded.

#### ■ Settings

[AVCHD] in [Rec Format]

\* AVCHD Progressive

Item	Picture size	fps	Bit rate
[FHD/50p]/  *	1920×1080	50p	Approx. 28 Mbps
[FHD/50p]*			
[FHD/50i]/ 	1920×1080	50i	Approx. 17 Mbps
[FHD/50i]			
[HD/50p]/ 	1280×720	50p	Approx. 17 Mbps
[HD/50p]			

- Select picture quality settings with the  to record location information and place name information.

[MP4] in [Rec Format]

Item	Picture size	fps	Bit rate
[FHD/25p]	1920×1080	25p	Approx. 20 Mbps
[HD/25p]	1280×720	25p	Approx. 10 Mbps
[VGA/25p]	640×480	25p	Approx. 4 Mbps

## ■ About motion picture icon

[Rec Format] — **AVCHD G** — Location information/Place name log  
 Picture size — **FHD 50i** — fps

### ● What is bit rate

Bit rate is the volume of data for a definite period of time, and the quality becomes higher when the number gets bigger. This unit uses the “VBR” recording method. “VBR” is an abbreviation of “Variable Bit Rate”, and the bit rate (volume of data for definite period of time) is changed automatically depending on the subject to record. Therefore, the recording time is shortened when a subject with fast movement is recorded.

- For the setting procedures of the menu. (→60)

## [Still Picture Size]

■ Recording mode: 

Set [Still Picture Size] for when you take still pictures while recording motion pictures.

### ■ Settings

[13.5M]	For printing up to A2 (16x20") size prints.
[6M]	For printing up to A3 (11x14") size prints.
[2M]	Suitable for display on a high-definition television.

- The aspect ratio becomes [16:9].

- For the setting procedures of the menu. (→60)

### [Continuous AF]

■ **Recording mode:**          

Either allow the focus to be constantly adjusted during motion picture recording, or fix the focus position at the start of recording.

■ **Settings**

[ON]

[OFF]: Fix focus position at the start of motion picture recording.

- The setting is fixed to [OFF] in the following case:
  - [Starry Sky] Scene Mode

### [Level Shot]

■ **Recording mode:**          

Level Shot function automatically detects the camera's tilt while recording motion pictures, and horizontally corrects the recording motion picture so it will not be tilted.

■ **Settings: [ON] / [OFF]**

- If you record while walking, or if the camera's tilt is large, it may not be possible to horizontally correct the motion pictures.
- When [Level Shot] is [ON], the recording range will become a little narrower when starting to record motion pictures.
- Still pictures taken while recording motion pictures will not be horizontally corrected.
- The setting is fixed to [OFF] in the following case:
  - [High Speed Video] Scene Mode

- For the setting procedures of the menu. (→60)

### [Wind Cut]

■ **Recording mode:**

Automatically detects wind sounds (wind noise) captured by the microphones and suppresses the sound if the wind is blowing too strongly.

#### ■ Settings

**[AUTO]:** Wind noise is automatically suppressed depending on volume.  
**[OFF]**

- When [Wind Cut] is set to [AUTO], the sound quality may differ from that of normal recordings.
- The setting is fixed to [OFF] in the following cases:
  - [Miniature Effect] in [Creative Control] Mode
  - [High Speed Video] Scene Mode
  - When the [Zoom Mic] is set to [ON]

### [Zoom Mic]

■ **Recording mode:**

This function links sound recording with the zoom operation.

During telephoto recording, you can clearly pick up sounds from the subject while suppressing surrounding sounds.

During wide-angle recording, you can pick up a wide range of surrounding sounds with a stereophonic effect.

#### ■ Settings: [ON] / [OFF]

- When set to [ON] and performing zoom, the operation sound may be recorded enhanced in accordance with the surrounding sounds. Also, the audio recording level will be lower with wide angle than when [OFF] is selected.
- The stereo effect of the audio is reduced during telephoto recording.
- The setting is fixed to [OFF] in the following cases:
  - [Miniature Effect] in [Creative Control] Mode
  - [High Speed Video] Scene Mode

## Changing the picture information display, etc.

You can disable the display of picture information (file number, etc.) and recording information (settings used for recording, etc.) when a picture is played back.

### 1 Press [DISP.] button to change display

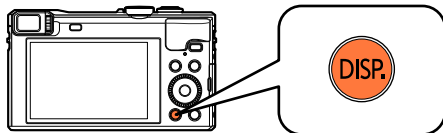

Has picture information  
(recording date and time, etc.)



Has recording information  
([Flash], [Sensitivity] etc.)



No display



- During Playback Zoom, Motion Picture Playback, Automatic Scrolling Playback of Panorama Pictures, Burst Playback or Slide Show: You can only turn the display on or off.
- During Multi Playback or calendar screen: Display cannot be changed.



## Playing back still pictures recorded using the burst function

Pictures taken with the [40] or [60] setting are recorded together as a group (picture group).

### ■ Representative picture display

A representative picture (first burst picture) is displayed when it is displayed together with other still pictures or with motion pictures.

Number of burst pictures

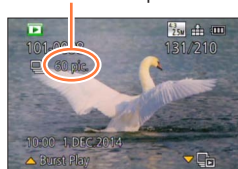

- All the still pictures in a picture group can be deleted or edited together.
- Press ▲ in the representative picture display to play back the still pictures in the picture group continuously. See the explanation of operations during motion picture playback (→56) for details of available operations during continuous playback. (Note that fast forward motion picture playback can be switched between two levels, but there is only one fast forward level for continuous playback of burst pictures.)

### ■ Display within each picture group ([ ])

Still pictures recorded in a single burst can be displayed one at a time.

1

#### Press ▼ while the representative picture displayed

The display within each picture group appears on the screen.



- You can use the same operations for still pictures in a picture group as in normal still picture playback. (Multi Playback, Playback Zoom, deleting pictures, etc.)
- On the display within each picture group, only the series of burst still pictures are displayed.
- To return to the representative picture display, press ▼.

### ■ Re-acquiring the picture group information

When the camera is turned on, the [ ] (acquiring information icon) may appear. While [ ] is displayed, pictures cannot be deleted and the [Playback] menu cannot be used.

### Playing back still pictures recorded using the burst function

- If only one still picture is left over in a picture group after deletion or other operations, it will not be formed into a group.
- Burst pictures will not be grouped if recorded without setting the clock.
- Burst pictures cannot be displayed as a picture group during [GPS Area Play] or [Favorite] playback with [Slide Show] or [Filtering Play].
- The following operation cannot be performed while a representative first burst picture is being displayed.
  - [Auto Retouch]
  - [Creative Retouch]
  - [Cropping] of [Playback] menu
- The burst pictures recorded by another device may not be recognised as picture group pictures.
- If the total number of still pictures exceeds 50,000, subsequently recorded pictures will not be grouped.

## Different playback methods [Playback Mode]

Recorded pictures can be played back in a variety of ways.  
To change the Playback Mode, refer to and perform the following steps.

### 1 Press [MENU/SET] in Playback Mode

The menu selection screen is displayed.

### 2 Use ▲▼◀▶ to select [Playback Mode] menu and press [MENU/SET]



### 3 Use ▲▼ to select the Playback Mode and press [MENU/SET]

[All]	Plays back all pictures. (→52)
[2D/3D Settings]	Switches the output format between 2D and 3D pictures. (Only available during HDMI output.) (→281)
[Slide Show]	Automatically plays back recorded pictures, one after another. (→164)
[Filtering Play]	Plays back the pictures after narrowing them down according to various conditions. (→160)
[Calendar]	Searches for and plays back pictures by recording date. (→166)

- If the pictures displayed with [Slide Show] or [Filtering Play] are narrowed down, selecting [All] will cancel the filtering.
- The playback method automatically becomes [All] when the camera is turned on, or when switching from [Rec] mode to [Playback Mode].

#### [2D/3D Settings]

The playback method for the 3D pictures can be switched. This menu is only displayed during HDMI output. For the procedure for playing back a 3D still picture (→281).

## Selecting pictures to play back [Filtering Play]

You can narrow down the pictures to be displayed with set filters, such as recording dates, categories, or favourite pictures.

**1** Select **[Filtering Play]** from the **[Playback Mode]** menu (→159)

**2** Use **▲ ▼** to select the filtering method and press **[MENU/SET]**

<b>[Picture Only]</b>	Play back still pictures. (→161)
<b>[Video Only]</b>	Play back motion pictures. (→161)
<b>[3D Play]</b>	Play back only 3D still pictures. (→161)
<b>[GPS Area Play]</b>	Select the location name of the place where the pictures were taken or the landmark name, and play the pictures back. (→161)
<b>[Travel]</b>	Play back pictures with [Travel Date] that have been set at the time of their recording. (→162)
<b>[Category Selection]</b>	Play back pictures that have been narrowed down by category, such as Scene Mode. (→162)
<b>[Select Date]</b>	Select the date when the pictures were taken, and play the pictures back. (→163)
<b>[Favorite]</b>	Play back pictures set as [Favorite]. (→163)

### ■ About operations during [Filtering Play]

During [Filtering Play], the operation when **▲** is pressed in the 1-picture Playback screen is different. Select the operation you want to perform and press [MENU/SET].

- [Retouch]: Retouching pictures (→167)
- [Burst Play]: Play back continuously recorded still pictures, one after another (→157)
- [Play Video]: Play back motion pictures (→56)
- [Play Panorama]: Play back panorama pictures (→122)
- [Change Date]: Change recording date to display (→163)
- [Filtering Off]: Switch Playback Mode to [All] (→159)

### ■ Cancel filtering

During [Filtering Play], only pictures under the set filters are displayed.

In the following cases, filtering will be cancelled.

- When **▲** is pressed in the 1-picture Playback screen and [Filtering Off] is selected
- When [All] is selected from the [Playback Mode] menu
- When switching to Recording Mode
- When the camera is turned off

**Narrowing down by selecting picture type**

Select picture type, such as still pictures only or motion pictures only, then play them back.

**1** Select **[Picture Only]** / **[Video Only]** / **[3D Play]** in **[Filtering Play]** and press **[MENU/SET]** (→160)

<b>[Picture Only]</b>	Play back still pictures. (Also applies to panorama pictures and continuously recorded pictures)
<b>[Video Only]</b>	Play back AVCHD motion pictures, MP4 motion pictures, and high-speed motion pictures.
<b>[3D Play]</b>	Plays back 3D still pictures recorded using [3D Photo Mode] Scene Mode.

**Narrowing down by selecting place name or landmark name of the location where the pictures were taken**

Select place name or landmark name from pictures which have recorded place name information, then play back the pictures.

**1** Select **[GPS Area Play]** in **[Filtering Play]** and press **[MENU/SET]** (→160)

**2** Use **▲ ▼** to select the item and press **[MENU/SET]**

**3** Use **▲ ▼ ◀ ▶** to select place name or landmark and press **[MENU/SET]**

- Place name information (place name and landmark name) may be different from the official names in some cases.
- The place name information may be different from the recorded location depending on the status of positioning.

## Narrowing down by selecting pictures recorded at a destination

Play back pictures with [Travel Date] (→138) that have been set at the time of their recording.

**1** Select [Travel] in [Filtering Play] and press [MENU/SET] (→160)

**2** Use ▲ ▼ to select the setting and press [MENU/SET]

[All]	Display all pictures that were recorded while [Travel Date] was set
[Travel Date]	Display only the pictures recorded on the selected travel date ① Use ▲ ▼ ◀ ▶ to select travel date and press [MENU/SET]
[Location]	Display only the pictures recorded at the selected travel destination ① Use ▲ ▼ ◀ ▶ to select travel destination and press [MENU/SET]

## Narrowing down by selecting picture category or a person in the picture

Play back pictures that have been narrowed down by category, such as Scene Mode. Also, from among the pictures recorded using the Face Recognition function (→135), select a person in the picture and play back.

**1** Select [Category Selection] in [Filtering Play] and press [MENU/SET] (→160)

**2** Use ▲ ▼ ◀ ▶ to select the setting and press [MENU/SET]

[Face Recog.]	Select a person registered to Face Recognition and display the pictures ① Use ▲ ▼ ◀ ▶ to select a person and press [MENU/SET]
[Portrait etc.]	Only display pictures recorded with [Portrait], [Soft Skin], [Night Portrait], [Baby] from Scene Mode*
[Scenery etc.]	Only display pictures recorded with Panorama Mode, and [Scenery], [Sunset], [Glass Through] from Scene Mode*
[Night Scenery etc.]	Only display pictures recorded with [Night Portrait], [Night Scenery], [Handheld Night Shot], [Starry Sky] from Scene Mode*
[Events]	Only display pictures recorded with [Sports] from Scene Mode
[Baby]	Only display pictures recorded with [Baby] from Scene Mode*
[Pet]	Only display pictures recorded with [Pet] from Scene Mode
[Food]	Only display pictures recorded with [Food] from Scene Mode*
[Burst Shooting]	Only display pictures recorded with [📷], [📷] in Burst

\* Even if the scene is auto-detected with [Intelligent Auto] Mode, it will be categorised in the same way.

Selecting pictures to play back [Filtering Play]

**Narrowing down by selecting recording date**

Select the recorded date, and play the pictures back.

**1** Select [Select Date] in [Filtering Play] and press [MENU/SET] (→160)

**2** Use ▲ ▼ ◀ ▶ to select recording date and press [MENU/SET]

**■ To change the date to display**

- ① Press ▲ in the 1-picture Playback screen
- ② Use ▲ ▼ to select [Change Date] and press [MENU/SET]

- Only months when pictures were taken are shown on the calendar screen. If the clock was not set, pictures will be displayed as 1st January, 2014.
- Pictures taken with destination settings made in [World Time] are displayed in the calendar screen using the appropriate date for the destination's time zone.

**Narrowing down by selecting favourite pictures**

Select pictures that were set in [Favorite] from the [Playback] menu, and play the pictures back.

**1** Select [Favorite] in [Filtering Play] and press [MENU/SET] (→160)

## Playing back pictures in order automatically

[Slide Show]

Automatically play pictures in order. Recommended when viewing on TV screen.

**1** Select [Slide Show] from the [Playback Mode] menu (→159)

**2** Use ▲ ▼ to select [Start] and press [MENU/SET]



### ■ To select pictures for automatic play back

If you have previously selected the pictures to display in [Filtering Play] of the [Playback Mode] menu, the Slide Show will play back the same pictures.

If you want to reselect pictures to play back, use cursor button to select [Filtering], then press [MENU/SET].

- For details on how to narrow down. (→160)
- The filtering will not be cancelled, even after the Slide Show finishes.
- If you select [All], the filtering will be cancelled.

### ■ To change settings such as music or display time

Select [Setup] and then press [MENU/SET].

[Effect]	[NATURAL] / [SLOW] / [SWING] / [URBAN] / [OFF]*
[Duration]*	[1SEC] / [2SEC] / [3SEC] / [5SEC]
[Repeat]	[ON] / [OFF]
[Sound]	[OFF]: Music and audio will not play back. [AUTO]: With still pictures, music will play back, and with motion pictures, audio will play back. [Music]: Music effect will play back. [Audio]: Audio is played back from motion pictures.

\* In the following case, [Effect] is fixed to [OFF]. The [Duration] setting is also disabled.

- [Motion Pic. Only]



## ■ Operations during Slide Show

### ● Cursor button

The operation guide appears on the bottom right on the screen.

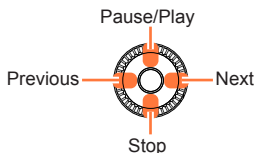

- If you do not perform any operation for approx. 2 seconds, the operation guide is turned off. To display the guide again, press the [DISP.] button.

### ● Control dial

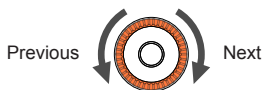

- When [URBAN] has been selected, the picture may appear in black and white as a screen effect.
- When panorama pictures, motion pictures, or burst pictures (picture group) are played back, the [Duration] setting is disabled.
- Part of [Effect] cannot be used when displaying pictures on television using an HDMI micro cable or when displaying pictures recorded in portrait position.
- Music effects cannot be added.

## Searching by recording date [Calendar]

You can search for pictures by the date they were recorded.

**1** Select [Calendar] from the [Playback Mode] menu (→159)

**2** Use ▲▼◀▶ to select recording date to display



- Only months when pictures were taken are shown on the calendar screen.

**3** Press [MENU/SET] to display a list of pictures from the selected date

**4** Use ▲▼◀▶ to select picture and press [MENU/SET]



- If there is more than one picture recorded on the same date, the first picture taken on that date will be selected.
- You can display the calendar between January 2000 to December 2099.
- Pictures recorded without configuring [Clock Set] will show the date 1st January, 2014.
- Pictures taken with destination settings made in [World Time] are displayed in the calendar screen using the appropriate date for the destination's time zone.

## Retouching pictures

### [Auto Retouch]

You can adjust the colour and brightness of a still picture to bring them into balance.

- New pictures are created after editing pictures with [Auto Retouch]. Before starting to edit, make sure that there is enough free space in the built-in memory or on the memory card.



• Example picture

**1** Select a still picture to retouch during playback and press **▲**

**2** Use **▲ ▼** to select [Auto Retouch] and press [MENU/SET]

**3** Use **▲ ▼** to select [ON] and press [MENU/SET]

- A confirmation screen is displayed. If you select [Yes], the new retouched still picture is saved.
- When [OFF] is selected, you can restore a picture to its original condition (before retouching).

### ■ Operation from the [Playback] menu

① Select [Retouch] in the [Playback] menu, and then press [MENU/SET]

② Use **▲ ▼** to select [Auto Retouch] and press [MENU/SET]

③ Use **◀ ▶** to select picture and press [MENU/SET]

Read Step **3** above to perform further steps.

- The retouch effect may be less apparent in some still pictures.
- Some still pictures may have higher noise levels after retouching.
- It may not be possible to use [Auto Retouch] with still pictures that have already been retouched.
- It may not be possible to retouch still pictures recorded with other cameras.
- You cannot retouch the pictures in a picture group as a group. Retouch each picture in a picture group after displaying it.
- [Auto Retouch] is unable to perform in the following cases:
  - Motion pictures
  - Panorama pictures
  - 3D still pictures
  - Still pictures recorded with the [Quality] setting [RAW], [RAW] or [RAW]

**[Creative Retouch]**

You can retouch recorded still pictures by selecting the effect that you want to apply.

- New pictures are created after editing pictures with [Creative Retouch]. Before starting to edit, make sure that there is enough free space in the built-in memory or memory card.

**1** Select a still picture to retouch during playback and press **▲**

**2** Use **▲ ▼** to select [Creative Retouch] and press **[MENU/SET]**

**3** Press **▲ ▼** to select effect

- The picture retouched with the selected effect is displayed.
- When [No Effect] is selected, you can restore a picture to its original condition (before retouching).

Setting	Effect
[Expressive]	This effect emphasises the colour to make a pop art picture.
[Retro]	This effect gives a faded image.
[Old Days]	This effect adds a bright, soft and nostalgic feel to the overall image.
[High Key]	This effect adds a bright, airy and soft feel to the overall image.
[Low Key]	This effect adds a dark and relaxing feel to the overall image and enhances bright parts.
[Sepia]	This effect creates a sepia image.
[Dynamic Monochrome]	This effect gives a higher contrast to create an impressive black and white picture.
[Impressive Art]	This effect gives your photo a dramatic contrast look.
[High Dynamic]	This effect produces the optimum brightness for both dark and bright parts.
[Cross Process]	This effect gives your photo a dramatic colour look.
[Toy Effect]	This effect reduces peripheral brightness to give the impression of a toy camera.

(Continued on the next page)

Setting	Effect
[Miniature Effect]	This effect blurs peripheral areas to give the impression of a diorama.
[Soft Focus]	This effect blurs the overall image to produce a soft feel.
[Star Filter]	This effect transforms pin-points of light into a star effect.
[One Point Color]	This effect leaves one selected colour to emphasise impressiveness.

- For more information about picture effects. (→112 - 118)
- When you press [DISP.] button, a description of the selected effect is displayed.

#### 4 Press [MENU/SET]

- A confirmation screen is displayed. If you select [Yes], the new retouched still picture is saved.
- Set the effect in the following cases:

[Cross Process]	Press ◀▶ to adjust colouring, then press [MENU/SET].
[Toy Effect]	
[Miniature Effect]	① Press ▲▼ or ◀▶ to move the focusing area (frame) ② Turn the control dial to select the size of the focusing area (frame) ③ Press [MENU/SET]
[One Point Color]	Select the colour to be retained with ▲▼◀▶ and press [MENU/SET].

#### ■ Operation from the [Playback] menu

- ① Select [Retouch] in the [Playback] menu, and then press [MENU/SET]
- ② Use ▲▼ to select [Creative Retouch] and press [MENU/SET]
- ③ Use ◀▶ to select picture and press [MENU/SET]  
Read steps ③ and after (→168) to perform further steps.

- The retouch effect may be less apparent in some still pictures.
- The image effect may appear weak compared to the effect given by the [Creative Control] Mode.
- It may not be possible to retouch still pictures recorded with other cameras.
- You cannot retouch the pictures in a picture group as a group. Retouch each picture in a picture group after displaying it.
- [Creative Retouch] is unable to be performed in the following cases:
  - Motion pictures
  - Panorama pictures
  - 3D still pictures
  - Still pictures recorded with the [Quality] setting [RAW], [RAW] or [RAW]

## Using the [Playback] menu

You can specify picture protection, resizing, print settings, and other settings for pictures you have taken.

- For the setting procedures of the menu. (→60)
- The setting methods vary depending on the menu item.

● In the following cases, new pictures are created after they have been edited. Before starting to edit, make sure that there is enough free space in the built-in memory or memory card.

- [Text Stamp]
- [Retouch]
- [Resize]
- [Cropping]

● It may not be possible to set or edit pictures taken with other cameras.

### [Location Logging]

You can send location information (latitude and longitude) obtained with your smartphone/tablet to this unit, and write the location information to the pictures.

- Location information cannot be written to still pictures in the built-in memory. If you want to record location information on them, copy the pictures in the built-in memory to a memory card, then perform [Location Logging].

#### Preparation:

Send location information to this unit from your smartphone/tablet. (→201)

**1** Use ▲ ▼ to select [Add Location Data] and press [MENU/SET]

**2** Use ▲ ▼ to select a period for writing location information, and then press [MENU/SET]

- Confirmation screen is displayed. If you select [Yes], the operation is executed.
- Location information is written to the picture.
- [GPS] is displayed for pictures that have location information written to it.

**■ Abort writing location information**

Press [MENU/SET] while location information is being written

- [○] is displayed for the period of the abort operation.

If selected again while [○] is displayed, writing location information will resume where it left off.

**■ Delete received location information**

① Use ▲ ▼ to select [Delete Location Data] and press [MENU/SET]

② Use ▲ ▼ to select a period for deleting location information, and then press [MENU/SET]

- Confirmation screen is displayed. If you select [Yes], the operation is executed.

- Location information may not be written if there is not enough free space on your card.
- If the card is locked, you cannot write location information to pictures or delete received location information.
- You can only write location information to pictures recorded with this unit.
- For pictures that already have location information recorded, due to the GPS function, etc., they will not be overwritten with location information obtained from your smartphone/tablet.
- Location information will not be written to pictures that were recorded after you selected [Send location data] (→201).
- Location information will not be written to AVCHD motion pictures.

- For the setting procedures of the menu. (→60)

## [Title Edit]

You can give titles, etc. to your favourite still pictures.

## 1 Use ▲ ▼ to select [SINGLE] or [MULTI] and press [MENU/SET]

### 2 Select a still picture

- [SINGLE]

Use ◀ ▶ to select a still picture and press [MENU/SET]



- [MULTI]

(up to 100 pictures with the same text)  
Use ▲ ▼ ◀ ▶ to select a still picture and press [DISP.] button

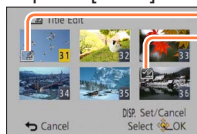

- [Title Edit] setting
- [Title Edit] already set
- To cancel  
→ Press [DISP.] button again.
- To execute  
→ Press [MENU/SET].

## 3 Enter characters (Entering text (→75))

- To delete a title, delete all the characters in the character input screen.

- Cannot be used in the following cases:

- Motion pictures (also applies to high-speed motion pictures)
- 3D still pictures
- Still pictures recorded with the [Quality] setting [RAW], [RAW] or [RAW]
- To print text, use [Text Stamp] or "PHOTOfunSTUDIO" on the supplied CD-ROM.



- For the setting procedures of the menu. (→60)

### [Place-Name Edit]

Place name information can be written in pictures.

#### 1 Use ◀▶ to select picture and press [MENU/SET]

#### 2 Use ▲▼ to select an editing method and press [MENU/SET]

[Candidate]	① Select an item to edit and press [MENU/SET] ② Select a place name or landmark name from the candidates and press [MENU/SET] • You can specify only pictures with the [GPS] icon.
[Direct]	① Select an item to edit and press [MENU/SET] ② Input characters (Entering text (→75))
[Repeat]	The previously selected or entered place name information is copied to the other pictures.

- A confirmation screen will appear. Select [Yes] to overwrite the place name information.
- [▶] appears on the pictures to which place name information has been written.

- Place names and landmarks subordinate to the edited place name will be deleted (for example, if you edit [County/Township], then [City/Town/Village] and [Landmark] will be deleted).
- If a landmark name is selected from My landmark (→272), the place name information other than landmark names will be deleted.
- You cannot edit pictures taken using a Panasonic digital camera (LUMIX) with GPS recording support released before 2010.

- For the setting procedures of the menu. (→60)

## [Text Stamp]

You can stamp the recording date and time, names, travel destination, travel dates, etc. on the recorded still pictures.

**1** Use ▲ ▼ to select [SINGLE] or [MULTI] and press [MENU/SET]

**2** Select a still picture

- [SINGLE]

Use ◀ ▶ to select a still picture and press [MENU/SET]



- [MULTI] (up to 100 pictures)

Use ▲ ▼ ◀ ▶ to select a still picture and press [DISP.] button



- [Text Stamp] setting
- [Text Stamp] already set

- To cancel  
→ Press [DISP.] button again.
- To execute  
→ Press [MENU/SET].

**3** Use ▲ ▼ to select [Set] and press [MENU/SET]

**4** Use ▲ ▼ to select the item and press [MENU/SET] (→175)

**5** Use ▲ ▼ to select the setting and press [MENU/SET] (→175)

**6** Press [Q.MENU/↵] button

**7** Use ▲ ▼ to select [OK] and press [MENU/SET]

- Confirmation screen is displayed. If you select [Yes], the operation is executed.

## ■ Items that can be stamped

[Shooting Date]	[W/O TIME]: Stamp recording date [WITH TIME]: Stamp recording date and time
[Name]	☺ : Stamp name registered in Face Recognition 🐶/🐱 : Stamp name registered in [Baby] or [Pet]
[Location]	Stamp location registered in [Setup] menu's [Travel Date]
[Travel Date]	Stamp number of days that have elapsed since the travel date set in [Setup] menu's [Travel Date]
[Title]	Stamp text registered in [Title Edit]
[Country/Region]	Stamp place name information recorded by GPS function • If text such as the location name or landmark name is long, it may not be possible to stamp all the text.
[State/Prov./County]	
[County/Township]	
[City/Town/Village]	
[Landmark]	
[Longitude/Latitude]	Stamp location information recorded by GPS function

- Items set to [OFF] are not stamped.

### ● Do not request date printing in store or make date printing on printer for still pictures with date stamps. (Date printing may be overlapped.)

- Cannot stamp texts on the following pictures.
  - Motion pictures
  - 3D still pictures
  - Panorama pictures
  - Still pictures that date or other texts had already been stamped
  - Still pictures taken without setting clock
  - Still pictures recorded with the [Quality] setting [RAW], [RAW] or [RAW]
- Characters may be cut off on certain printers.
- Text is difficult to read when stamped on pictures of 0.3M or less.

## [Retouch]

[Auto Retouch]: For details (→167)

[Creative Retouch]: For details (→168)

- For the setting procedures of the menu. (→60)

### [Video Divide]

A single motion picture can be split into 2 parts. This is convenient when you want to keep just the necessary scenes, or if you wish to delete unnecessary scenes to increase free space on your card, such as when travelling.

- 1 Use ◀▶ to select a motion picture to split and press [MENU/SET]**
- 2 Press ▲ at where you want to split a motion picture to pause it**
- 3 Press ▼**

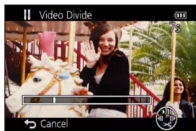

- A confirmation screen is displayed. Select [Yes] and press [MENU/SET].
- **The original motion picture that was split does not remain.**  
(There will only be the 2 motion pictures that were created after the split.)

- During dividing, do not turn off the camera or remove the card or battery. If you do so, the motion picture may be deleted.
- Dividing a motion picture recorded in [MP4] or [High Speed Video] changes the order of the pictures. It is recommended to display with [Calendar] (Calendar Playback) or [Filtering Play].
- Motion pictures with a short recording time cannot be divided.

- For the setting procedures of the menu. (→60)

### [Resize]

Picture size can be reduced to facilitate e-mail attachment and use in web pages, etc. (Still pictures recorded at the smallest recording pixel level cannot be further reduced.)

#### ■[SINGLE]

- 1** Use ▲ ▼ to select [SINGLE] and press [MENU/SET]
- 2** Use ◀ ▶ to select a still picture and press [MENU/SET]
- 3** Use ◀ ▶ to select size and press [MENU/SET]

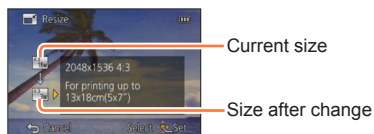

- Confirmation screen is displayed. If you select [Yes], the operation is executed.

(Continued on the next page)

## ■ [MULTI]

**1** Use ▲ ▼ to select [MULTI] and press [MENU/SET]

**2** Use ▲ ▼ to select size and press [MENU/SET]

**3** Use ▲ ▼ ◀ ▶ to select a still picture and press [DISP.] button  
(up to 100 pictures)

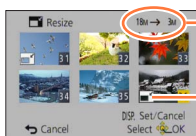

Number of pixels before/after resising

Resise setting

- To cancel  
→ Press [DISP.] button again.
- To execute  
→ Press [MENU/SET].

- Confirmation screen is displayed. If you select [Yes], the operation is executed.

● Picture quality is reduced after resising.

● Cannot resise the following pictures.

- Motion pictures
- 3D still pictures
- Panorama pictures
- Still pictures that date or other texts had already been stamped
- Still pictures recorded with the [Quality] setting [RAW], [RAW] or [RAW]

- For the setting procedures of the menu. (→60)

### [Cropping]

Enlarge your still pictures and crop unwanted areas.

**1** Use ◀▶ to select a still picture and press [MENU/SET]

**2** Select area to crop and press [MENU/SET]



Change position

- Confirmation screen is displayed. If you select [Yes], the operation is executed.
- You can also enlarge the still picture with the control dial.

- Original Face Recognition information will not be copied when still pictures are cropped.
- Picture quality is reduced after cropping.
- Cannot crop the following pictures.
  - Motion pictures
  - 3D still pictures
  - Panorama pictures
  - Still pictures that date or other texts had already been stamped
  - Still pictures recorded with the [Quality] setting [RAW], [RAW] or [RAW]

- For the setting procedures of the menu. (→60)

### [Favorite]

By labelling your favourite pictures with a star (★), you can play back your favourite pictures only, or you can delete all pictures except your favourites. Up to 999 pictures can be set as favourites.

**1** Use ▲ ▼ to select [SINGLE] or [MULTI] and press [MENU/SET]

**2** Use ▲ ▼ ◀ ▶ to select picture and press [MENU/SET]

● [SINGLE]



Favourite picture setting

● [MULTI]

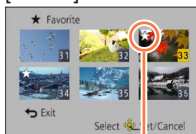

Favourite picture setting

- To cancel → Press [MENU/SET] again.

#### ■ To clear all

Select [CANCEL] in step **1** and select [Yes].

- You cannot select the [Favorite] setting for still pictures recorded with the [Quality] setting [RAW].



- For the setting procedures of the menu. (→60)

## [Print Set]

Picture/picture no./date printing settings can be made for when printing with DPOF print-compatible shops or printers. (Ask at the shop to check for compatibility.)

**1** Use **▲ ▼** to select [SINGLE] or [MULTI] and press [MENU/SET]

**2** Use **▲ ▼ ◀ ▶** to select picture and press [MENU/SET]

**3** Use **▲ ▼** to set number of pictures and press [MENU/SET]

(Repeat steps **2** and **3** when using [MULTI] (up to 999 pictures))

● [SINGLE]



Date print set

No. to print

● [MULTI]

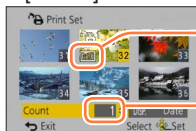

Date print set

No. to print

- Date print setting/release → Press [DISP.] button.

### ■ To clear all

Select [CANCEL] in step **1** and select [Yes].

- Date print setting cannot be made for still pictures that have been taken with [Date Stamp] and pictures with a [Text Stamp] applied.
- Depending on the type of printer, the printer settings may take priority over camera settings.
- Cannot be set for files that are not compliant with the DCF standard.
- Some DPOF information set by other equipment cannot be used. In such cases, delete all of the DPOF information and then set it again with this camera.
- Print setting cannot be made for motion pictures.
- You cannot select the [Print Set] setting for still pictures recorded with the [Quality] setting [RAW].

- For the setting procedures of the menu. (→60)

## [Protect]

Set protection to disable picture deletion. Prevents deletion of important pictures.

**1** Use ▲ ▼ to select [SINGLE] or [MULTI] and press [MENU/SET]

**2** Use ▲ ▼ ◀ ▶ to select picture and press [MENU/SET]

● [SINGLE]



Picture protected

● [MULTI]

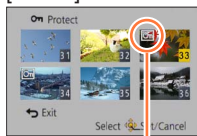

Picture protected

- To cancel → Press [MENU/SET] again.

■ To clear all

Select [CANCEL] in step **1** and select [Yes].

- The picture is erased when formatting, even if it is protected.
- May not be effective when using other devices.
- When you set the write-protect switch on the card to the "LOCK" position, the picture is not erased.

- For the setting procedures of the menu. (→60)

**[Face Rec Edit]**

Edit or delete the recognition information for pictures with mistaken Face Recognition.

- 1 Use ▲▼ to select [REPLACE] or [DELETE] and press [MENU/SET]**
- 2 Use ◀▶ to select picture and press [MENU/SET]**
- 3 Use ◀▶ to select a person and press [MENU/SET]**
  - If [DELETE], go to step **5**.
  - People whose Face Recognition information has not been registered cannot be selected.
- 4 Use ▲▼◀▶ to select the person to replace for another and press [MENU/SET]**
- 5 Use ◀ to select [Yes] and press [MENU/SET]**

- When Face Recognition information is deleted, it cannot be restored.
- Pictures for which all Face Recognition information has been deleted are not categorised in Face Recognition during [Category Selection].
- Recognition information cannot be edited in protected pictures.

- For the setting procedures of the menu. (→60)

## [Copy]

You can copy pictures between built-in memory and memory card.

### 1 Use ▲ ▼ to select the copy method (direction) and press [MENU/SET]



: Copy all pictures from built-in memory to card (go to step 3).

: Copy 1 picture at a time from card to built-in memory.

### 2 Use ◀ ▶ to select picture and press [MENU/SET]

### 3 Use ◀ to select [Yes] and press [MENU/SET]

- To cancel → Press [MENU/SET].

- Copying pictures may take several minutes. Do not turn off the camera or perform other operations during copying.
- If identical names (folder/file numbers) are present in the copy destination, a new folder for copying will be created when copying from built-in memory to card () . Identically-named files will not be copied from card to built-in memory () .
- The following settings are not copied. Set them again after copying.
  - [Print Set] • [Protect] • [Favorite]
- Only pictures from Panasonic digital cameras (LUMIX) may be copied.
- Motion pictures recorded in [AVCHD] format cannot be copied.

## Wi-Fi® Function and NFC Function

### ■ Use the camera as a wireless LAN device

When using equipment or computer systems that require more reliable security than wireless LAN devices, ensure that the appropriate measures are taken for safety designs and defects for the systems used. Panasonic will not take any responsibility for any damage that arises when using the camera for any purpose other than as a wireless LAN device.

### ■ Use of the Wi-Fi function of this camera is presumed to be in countries where this camera is sold

There is the risk that the camera violates the radiowave regulations if used in countries other than those where this camera is sold, and Panasonic takes no responsibility for any violations.

### ■ There is the risk that data sent and received via radio waves may be intercepted

Please note that there is the risk that data sent and received via radio waves may be intercepted by a third party.

We strongly recommend that you enable encryption in the settings of your wireless access point to ensure information security.

### ■ Do not use the camera in areas with magnetic fields, static electricity or interference

- Do not use the camera in areas with magnetic fields, static electricity or interference, such as near microwave ovens. Radio waves may not reach the camera.
- Using the camera near devices such as microwave ovens or cordless telephones that use the 2.4 GHz radio wave band may cause a decrease in performance in both devices.

### ■ Do not connect to the wireless network you are not authorised to use

When the camera utilises its Wi-Fi function, wireless networks will be searched automatically. When this happens, wireless networks that you are not authorised to use (SSID\*) may be displayed, however do not attempt to connect to the network as it may be considered as unauthorised access.

\*SSID refers to the name that is used to identify a network over a wireless LAN connection. If the SSID matches for both devices, transmission is possible.

### ■ Before Use

- To use the Wi-Fi function on this unit, a wireless access point or a destination device equipped with the wireless LAN function is required.

### ■ The camera is compatible with NFC

Using the NFC (Near Field Communication) function, the camera and a smartphone/tablet can easily exchange the information needed to establish a Wi-Fi connection.

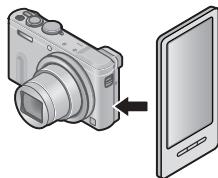

## ■ About the Wi-Fi connection lamp

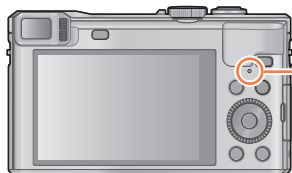

### Wi-Fi connection lamp

Lit blue: When the Wi-Fi function is ON

Blinking blue: When sending data

## ■ About the [Wi-Fi] button

- Before a Wi-Fi connection is established, press and hold the [Wi-Fi] button to display the information (QR Code, SSID, password) you will need to connect the smartphone/tablet directly to the camera. (→190)
- Before a Wi-Fi connection is established, press the [Wi-Fi] button to perform the following operations:

[New Connection] (→190)
[History Connection] (→250)
[Favorite Connection] (→250)
[Wi-Fi Setup] (→255)

- Pressing the [Wi-Fi] button during a Wi-Fi connection enables the following operation. When connected using [Remote Shooting & View], a guide explaining how to terminate the Wi-Fi connection is displayed.

[Terminate the Connection]	Terminates the Wi-Fi connection.
[Change the Destination]	Terminates the Wi-Fi connection, and allows you to select a different Wi-Fi connection.
[Change Settings for Sending Images]*	For details (→254).
[Register the Current Destination to Favorite]	Registering the current connection destination or the connection method, you can easily connect with the same connection method next time.
[Network Address]	Displays the MAC address and IP address of this unit. (→256)

\*This item will not be displayed if the destination for [Playback on TV] or [Send Images Stored in the Camera] is set to [Printer].

- The camera cannot be used to connect to a public wireless LAN connection.
- Use a IEEE802.11b, IEEE802.11g or IEEE802.11n compatible device when using a wireless access point.
- We recommend that you use a fully charged battery when you send pictures.
- When the battery indicator is flashing red, the connection with other equipment may not start or the connection may be disrupted. (A message such as [Communication error] is displayed.)
- When sending images on a mobile network, high packet communication fees may be incurred depending on the details of your contract.
- Pictures may not be completely sent depending on radio wave conditions. If the connection is terminated while sending pictures, pictures with missing sections may be sent.
- **Do not remove the memory card or battery or move to an area without any reception while sending images.**
- The LCD monitor display may become distorted for an instant while connected to the service, however this will not affect the image being sent.

### [Airplane Mode]

To disable Wi-Fi connection, set [Airplane Mode] to [ON].

**1** Select [Airplane Mode] from [Setup] menu and press [MENU/SET] (→60)

**2** Use cursor button to select [ON] and press [MENU/SET]

- Electromagnetic waves from the camera can affect instruments and meters. In airplane cabins or in other restricted areas, set [Airplane Mode] to [ON].

## What you can do with the Wi-Fi function

### Operating the camera using a smartphone/tablet

Taking pictures via a smartphone/tablet (remote recording) (→196)

Playing back pictures in the camera on a smartphone/tablet (→197)

Saving pictures in the camera to the smartphone/tablet (→197)

Sending pictures in the camera to social networking services (→200)

#### Connect easily, transfer pictures easily

You can easily use the Wi-Fi function by pressing and holding the [Wi-Fi] button or using the NFC function. (→194, 198)

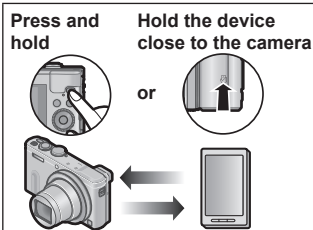

### Displaying still pictures on a TV (→207)

### Wireless printing (→209)

### Sending pictures to AV equipment (→211)

Still pictures and motion pictures can be sent to AV equipment in the home (home AV equipment). Through "LUMIX CLUB", you can also send your still pictures and motion pictures to AV equipment of family and friends far away (outside AV equipment).

### Sending pictures to a PC (→216)

### Using WEB services (→221)

Through "LUMIX CLUB", you can send still pictures and motion pictures to social networking services, etc. By selecting the setting to automatically transfer still pictures and motion pictures to [Cloud Sync. Service], you can receive the transferred still pictures and motion pictures on a PC or a smartphone/tablet.

### Transferring pictures automatically [Smart Transfer] (→238)

Transfer recorded images to a PC, an AV device or a Cloud Folder automatically.

- Hereafter, this manual uses the term "smartphone" for both smartphones and tablets unless it is necessary to distinguish between them.



## Operating the camera using a smartphone/tablet

You can remotely operate the camera using a smartphone.

The “Panasonic Image App” (hereafter “Image App”) must be installed on your smartphone.

### Installing the smartphone/tablet app “Panasonic Image App”

The “Image App” is an application provided by Panasonic that allows your smartphone to perform the following operations of a Wi-Fi-compatible LUMIX.

	For Android™ apps	For iOS apps
<b>Supported OS (Current as of January 2014)</b>	Android 2.3.3 or later*	iOS 5.0 or later
<b>Installation procedure</b>	① Connect your Android device to a network ② Select “Google Play™ Store” ③ Enter “Panasonic Image App” or “LUMIX” to search for the app ④ Select “Panasonic Image App” and install it • The icon will be added to the menu. 	① Connect the iOS device to the network ② Select “App Store™” ③ Enter “Panasonic Image App” or “LUMIX” to search for the app ④ Select “Panasonic Image App” and install it • The icon will be added to the menu. 

- Use the latest version.
- The screen differs depending on the operating system.
- The service may not be able to be used properly depending on the type of smartphone being used.
- For the latest information on the “Image App”, refer to the support site below.  
<http://panasonic.jp/support/global/cs/dsc/> (This site is available in English only.)
- When downloading the app on a mobile network, high packet communication fees may be incurred depending on the details of your contract.

\* To connect this unit with [Wi-Fi Direct], Android OS 4.0 or above is required and the device must be compatible with Wi-Fi Direct™.

## Connecting to a smartphone/tablet

You can easily establish a Wi-Fi connection on the camera by pressing and holding the [Wi-Fi] button or using the NFC function.

**Preparation:** Install "Image App" in advance. (→189)

## 1 Press and hold the [Wi-Fi] button

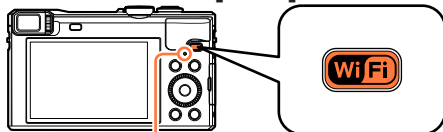

Wi-Fi connection lamp  
(Lit blue)



SSID and Password

QR Code

- The information (QR Code, SSID and Password) required for directly connecting your smartphone to this unit is displayed.
- To change the connection method, press the [DISP.] button and select the connection method. (→193)
- By holding down the [Wi-Fi] button while the camera is turned off, you can turn the camera on.

The same screen can be displayed by selecting items from the menu as follows.

- ① Press [Wi-Fi] button
- ② Use cursor button to select [New Connection] and press [MENU/SET]
- ③ Use cursor button to select [Remote Shooting & View] and press [MENU/SET]

(Continued on the next page)

## 2 Operate the smartphone

- When the connection is complete, live images being captured by the camera are displayed on the smartphone.  
(It may take some time after the operation for the connection to be established.)
- The connection method differs depending on the smartphone used.

### <Using an iOS device>

- When reading a QR Code to connect  
(Steps ① to ⑤ are not necessary when reconnecting.)

① Start “Image App” (→189)

② Select [QR Code] → [OK]

③ Read the QR Code displayed on this unit with “Image App”

④ Install the IMAGE APP profile



Select [Install]\*, then select [Install Now]\* → [Done]\*.  
The message is displayed in the Web browser.

- If a passcode is required to unlock the smartphone, you will have to input the passcode.

⑤ Press the home button to close the Web browser

⑥ Select [Wi-Fi]\* under [Settings]\* on the smartphone



⑦ Turn on [Wi-Fi]\* and select the SSID displayed on this unit

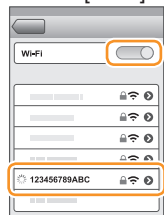

⑧ Return to the home screen and start “Image App” (→189)

\*The display may differ depending on the system language setting.

(Continued on the next page)

- When connecting with SSID and password
  - ① Select [Wi-Fi]\* under [Settings]\* on the smartphone
  - ② Turn on [Wi-Fi]\* and select the SSID displayed on this unit
  - ③ Enter the password displayed on this unit (First time connecting only)
  - ④ Return to the home screen and start “Image App” (→189)

\*The display may differ depending on the system language setting.

#### <Using an Android device>

- When reading a QR Code to connect
  - ① Start “Image App” (→189)
  - ② Select [QR Code]
  - ③ Read the QR Code displayed on this unit with “Image App”
  
- When connecting with SSID and password
  - ① Start “Image App” (→189)
  - ② Select [Wi-Fi]
  - ③ Select the SSID displayed on this unit
  - ④ Enter the password displayed on this unit (First time connecting only)
    - If you check the item to display the password, you can confirm the password as you enter it.

## ■ Changing the connection method

To change the connection method, press the [DISP.] button and select the connection method.



- When connecting with [Via Network]

(On the camera)

### 1 Select [Via Network] and press [MENU/SET]

- Connect the camera to a wireless access point by following the connection method (→246).

(On your smartphone)

### 2 Set Wi-Fi function to “ON”

### 3 Select the wireless access point you connected to the camera, and set

### 4 Start “Image App” (→189)

- When connecting with [Direct]

(On the camera)

### 1 Select [Direct] and press [MENU/SET]

- Select [Wi-Fi Direct] or [WPS Connection], and connect the camera to the smartphone by following the connection method (→249).

(On your smartphone)

### 2 Start “Image App” (→189)

## ■ Closing the connection

After use, close the connection with the smartphone. When the connection is cancelled, you will be able to record and play back pictures on the camera as normal.

(On the camera)

#### ① Press [Q.MENU/ ] button

- A confirmation screen is displayed. Select [Yes] and press [MENU/SET].

(On your smartphone)

#### ② Close “Image App”

<Using an iOS device>

From the “Image App” screen, press the home button on the smartphone to close the app

<Using an Android device>

From the “Image App” screen, press the back button on the smartphone twice to close the app

**Connecting to a smartphone/tablet using NFC function**

Using the NFC (Near Field Communication) function, the camera and a smartphone can easily exchange the information needed to establish a Wi-Fi connection.

**Compatible models:**

This function can be used with NFC compatible devices with Android (2.3.3 or above).  
(Not available in certain models)

- See the operating instructions of your NFC-compatible smartphone for more information about smartphone operation and settings.

**Preparations:**

(On the camera)

- Set [NFC Operation] to [ON] ([→256](#))

(On your smartphone)

- Check if your smartphone is a compatible model
- Set Wi-Fi function to "ON"
- Install "Image App" in advance ([→189](#))

**1 Start “Image App” on your smartphone****2 While the [📱] is displayed on the connection screen of the “Image App”, hold the smartphone close to the camera**

- It may take some time to complete the connection.
- When the connection is complete, live images captured by the camera will be displayed on your smartphone.
- If you connect during playback of one picture, it will be transferred to the smartphone. (→198)

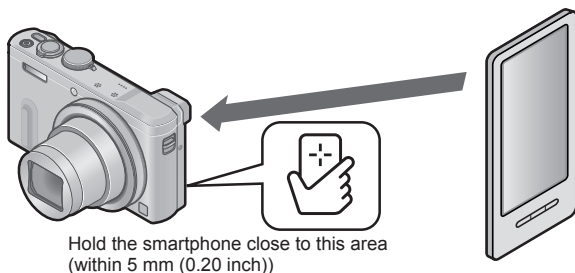
**3 Use ◀ to select [Yes] and press [MENU/SET]****4 Hold the smartphone close to this area of the unit again**

- When the connection is complete, live images captured by the camera will be displayed on your smartphone.
- Connected smartphones are registered to this unit.  
From the next time and on, you can connect by performing steps **1** and **2**.

- You can register up to 20 smartphones. If the number of registered smartphones exceeds 20, registrations will be deleted starting from the smartphone touched first.
- If you perform [Reset Wi-Fi Settings], smartphone registration will be deleted.
- If the communication environment is bad, the NFC function may not be usable.
- If there is not a response immediately, shift the position slightly.
- Do not bump your smartphone strongly against this unit.
- See the operating instructions of your NFC-compatible smartphone for more information about smartphone operation and settings.
- Metal objects between this unit and the smartphone may interfere with communication. Also, any stickers, etc., near the NFC area may affect communication performance.
- You can still connect to the smartphone even if the camera is turned off. The camera lens may come out when the power is turned on after making a connection. Be careful that the vibration does not cause the camera to drop.
- The NFC function cannot be used in the following cases:
  - When connected to a television, computer, or printer
  - When recording motion pictures
  - During motion picture playback, during slide shows, and during panorama playback (including pauses in each case)
  - While sending pictures by Wi-Fi
  - While recording still pictures (during self-timer countdown)
  - While editing
  - When the [Airplane Mode] is [ON]
- After "Image App" is forced to end or after the connection has been cancelled, it is necessary to hold the smartphone close to the camera again.

### Taking pictures via a smartphone/tablet (remote recording)

#### 1 Connect to a smartphone (→190)

#### 2 Select [] from "Image App"

- The recorded images are saved in the camera.
- Motion pictures can also be recorded.
- When using zoom, the camera could tilt when the lens barrel extends. Make sure to secure the camera in place with a tripod or by other means.
- Some settings are not available.



## Playing back pictures in the camera on a smartphone/tablet

**1** Connect to a smartphone (→190)**2** Select [📷] from “Image App”

- The images captured by the camera are displayed on the smartphone.
- When the picture is touched, it is played back at a larger size.

## Saving pictures in the camera to the smartphone/tablet

**1** Connect to a smartphone (→190)**2** Select [📷] from “Image App”**3** Press and hold the picture and drag it to save it on the smartphone

- The picture is saved on the smartphone.

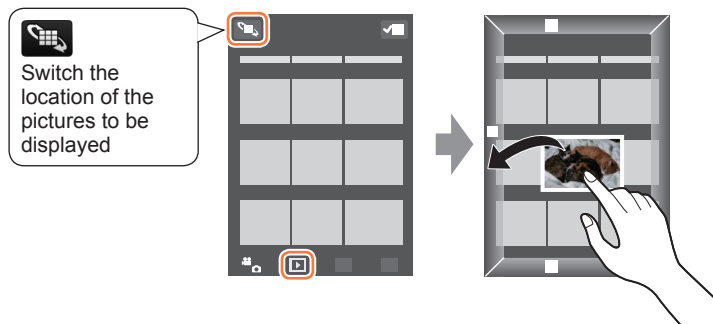

- When the picture is touched, it is played back at a larger size.
- Functions can be assigned to the top, bottom, left and right as you wish.
- It is not possible to save pictures in RAW file format or AVCHD motion pictures.
- 3D still pictures (MPO format) are saved as 2D still pictures (JPEG).

### ■ Easily transferring pictures in the camera

You can establish a Wi-Fi connection using the NFC function and easily transfer over Wi-Fi the picture on display simply by holding the smartphone close to the camera. Pictures can be transferred as soon as they are recorded, so you can easily transfer them to your friends' and family's smartphones.\*

\*"Image App" must be installed to use this function.

#### Preparations:

(On the camera)

- Set [NFC Operation] to [ON] (→256)

(On your smartphone)

- Check if your smartphone is a compatible model
- Set Wi-Fi function to "ON"
- Install "Image App" in advance (→189)

- 1** On the camera, play back the picture you wish to transfer to a smartphone
- 2** Start “Image App” on the smartphone you are transferring the picture to
- 3** While the [👉] is displayed on the connection screen of the “Image App”, hold the smartphone close to the camera
  - It may take some time to complete the connection.
  - If you are transferring multiple pictures, repeat steps **1** and **3**. (Multiple pictures cannot be transferred in one batch.)

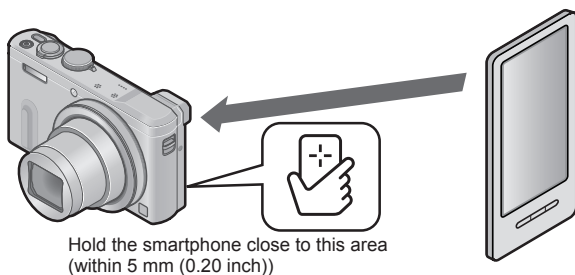

- It may take several minutes to complete the picture transfer depending on the environment used.

## Sending pictures in the camera to social networking services

- 1** Connect to a smartphone (→190)
- 2** Select [📷] from “Image App”
  - The images captured by the camera are displayed on the smartphone.
- 3** Press and hold the picture and drag it to send it to the social networking service, etc.

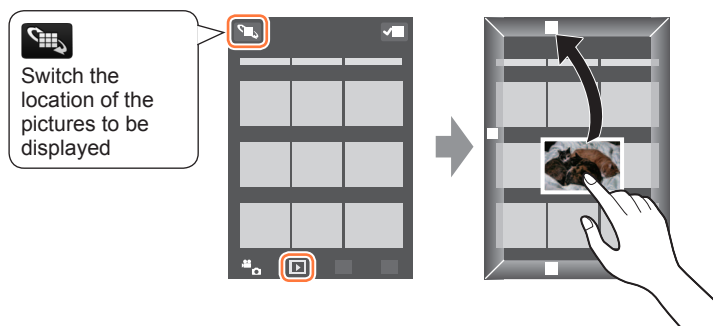

- The picture will be sent to the social networking service or other WEB services.
- Functions can be assigned to the top, bottom, left and right as you wish.

**Sending location information to the camera from a smartphone/tablet**

You can acquire location information from a smartphone, and write it on images afterwards. Refer to (→170) for how to write the location information on the images recorded by this unit.

**● Caution:**

**Be sure to pay special attention to the privacy, the likeness rights, etc. of the subject when you use this function. Use at your own risk.**

- Read the [Help] in the "Image App" menu for further details on how to operate.
- If you have changed the clock setting of this unit or the smartphone after [Time sync], perform [Time sync] again.
- On the smartphone, you can set the acquisition interval of location information and check the transfer status of location information. Refer to [Help] in the "Image App" menu for details.
- (When using "Image App" for iOS)  
If you press the Home or On/Off button of a smartphone while [Rec. loc. Info] is working, location information recording is stopped.
- The smartphone may fail to acquire location information in China and the border area in the neighbouring countries of China. (Current as of January 2014)

## Operating the camera to send pictures to a smartphone or tablet

## ■ Sending method, and pictures that can be sent

	JPEG	RAW	MP4	AVCHD	3D
<b>Sending a picture each time one is recorded</b> [Send Images While Recording]	○	—	—	—	—
<b>Sending selected pictures</b> [Send Images Stored in the Camera]	○	—	○	—	—

- Some images may not be played back or sent depending on the device.
- See the operating instructions of the destination device for more information about picture playback.
- For more details about picture sending methods. ([→253](#))

**Preparation:** Install “Image App” in advance. ([→189](#))

See the part of the manual that applies to your objective.

**Sending a picture each time one is recorded ([Send Images While Recording])**  
([→203](#))

**Sending selected pictures ([Send Images Stored in the Camera])** ([→205](#))

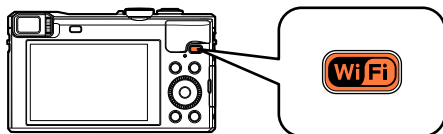
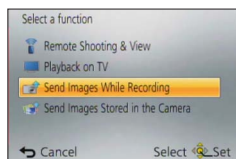
**■ Sending a picture each time one is recorded ([Send Images While Recording])****1 Press [Wi-Fi] button****2 Use cursor button to select [New Connection] and press [MENU/SET]****3 Use cursor button to select [Send Images While Recording] and press [MENU/SET]****4 Use cursor button to select [Smartphone] and press [MENU/SET]**

(Continued on the next page)

## 5 Select [Via Network] or [Direct] and press [MENU/SET]

- When connecting with [Via Network]

### (On the camera)

- ① Connect the camera to a wireless access point (→246)

### (On your smartphone)

- ② Set Wi-Fi function to "ON"
- ③ Select the wireless access point you connected to the camera, and set
- ④ Start "Image App" (→189)

- When connecting with [Wi-Fi Direct] or [WPS Connection] in [Direct]

### (On the camera)

- ① Connect the camera to a smartphone (→249)

### (On your smartphone)

- ② Start "Image App" (→189)

- When connecting with [Manual Connection] in [Direct] (→191)

## 6 Select the device you wish to connect to

- When the connection is established, the screen is displayed. To change the send setting, press the [DISP.] button. (→254)

## 7 Take still pictures

- The still pictures are sent automatically after taking them.
- To change the setting or disconnect, press [Wi-Fi] button.  
You cannot change the settings while sending still pictures. Wait until sending is complete.

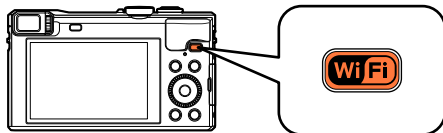
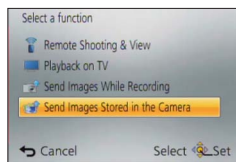

**■ Sending selected pictures ([Send Images Stored in the Camera])****1 Press [Wi-Fi] button****2 Use cursor button to select [New Connection] and press [MENU/SET]****3 Use cursor button to select [Send Images Stored in the Camera] and press [MENU/SET]****4 Use cursor button to select [Smartphone] and press [MENU/SET]**

(Continued on the next page)

## 5 Select [Via Network] or [Direct] and press [MENU/SET]

- When connecting with [Via Network]

### (On the camera)

- ① Connect the camera to a wireless access point (→246)

### (On your smartphone)

- ② Set Wi-Fi function to "ON"
- ③ Select the wireless access point you connected to the camera, and set
- ④ Start "Image App" (→189)

- When connecting with [Wi-Fi Direct] or [WPS Connection] in [Direct]

### (On the camera)

- ① Connect the camera to a smartphone (→249)

### (On your smartphone)

- ② Start "Image App" (→189)

- When connecting with [Manual Connection] in [Direct] (→191)

## 6 Select the device you wish to connect to

- When the connection is established, the screen is displayed. To change the send setting, press the [DISP.] button. (→254)

## 7 Select [SINGLE] or [MULTI]

- To change the setting or disconnect, press [Wi-Fi] button. (→186)

### ■ When [SINGLE] is selected

- ① Select the picture
- ② Select [Set]

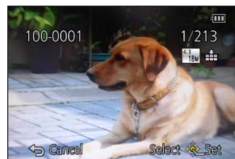

### ■ When [MULTI] is selected

- ① Select the picture (repeat)
  - If selected again, the setting will be cancelled.
- ② Select [OK]
  - The number of pictures that can be sent by [MULTI] is limited.

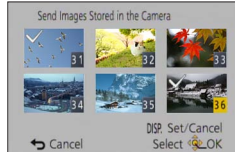

- Confirmation screen is displayed. If you select [Yes], the operation is executed.

## Displaying still pictures on a TV

You can display still pictures on a TV that is compatible with a DLNA certified digital media renderer (DMR) function.

**Preparations:** Set the TV to DLNA waiting Mode.

- Read the operating instructions for your TV.
- For details about compatible devices, refer to the website below.  
<http://panasonic.jp/support/global/cs/dsc/> (This site is available in English only.)

### 1 Press [Wi-Fi] button

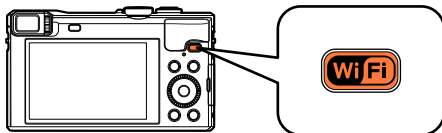

### 2 Use cursor button to select [New Connection] and press [MENU/SET]

### 3 Use cursor button to select [Playback on TV] and press [MENU/SET]

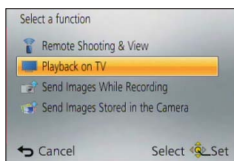

### 4 Select [Via Network] or [Direct] to connect (→245)

### 5 Select the device you wish to connect to

- When the connection is established, the screen is displayed.

### 6 Take or play back still pictures on this unit

- To change the setting or disconnect, press [Wi-Fi] button. (→186)

## Displaying still pictures on a TV

- When a TV is connected to this unit, the TV screen may temporarily return to the status before the connection. Pictures are displayed again when you take or play back pictures.
- [Effect] and [Sound] of the Slide Show are disabled.
- Motion pictures cannot be played back.
- During the multi/calendar playback, pictures displayed on the screen of this unit are not displayed on TV.

## Wireless printing

You can send still pictures to a compatible printer and print them wirelessly.

### ■ Sending method, and pictures that can be sent

	JPEG	RAW	MP4	AVCHD	3D
Sending selected pictures [Send Images Stored in the Camera]	○	—	—	—	—

- Some images may not be played back or sent depending on the device.
- For more details about picture sending methods. (→253)

#### Preparation:

- You can print out recorded still pictures wirelessly from a PictBridge (wireless LAN-compatible)\* printer.

\*Compliant with the DPS over IP standards. Contact the printer manufacturers for details on PictBridge (wireless LAN-compatible) printers.

#### 1 Press [Wi-Fi] button

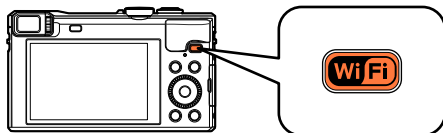

#### 2 Use cursor button to select [New Connection], and then press [MENU/SET]

#### 3 Use cursor button to select [Send Images Stored in the Camera], and then press [MENU/SET]

#### 4 Use cursor button to select [Printer], and then press [MENU/SET]

#### 5 Select [Via Network] or [Direct] to connect (→245)

#### 6 Select a printer you want to connect

(Continued on the next page)

## 7 Select the still picture and print

- Pictures are selected the same way as when connecting by USB connection cable (supplied). For more details ([→291](#)).
- To change the setting or disconnect, press [Wi-Fi] button. ([→186](#))

● Motion pictures cannot be printed out.

## Sending pictures to AV equipment

Still pictures and motion pictures can be sent to AV equipment in the home (home AV equipment), such as DLNA compatible recorders. Through "LUMIX CLUB", you can also send your still pictures and motion pictures to AV equipment of family and friends far away (outside AV equipment).

You can make a setting so that pictures in the camera can be sent to AV equipment automatically while the camera battery is charging. ([Smart Transfer] ([→238](#)))

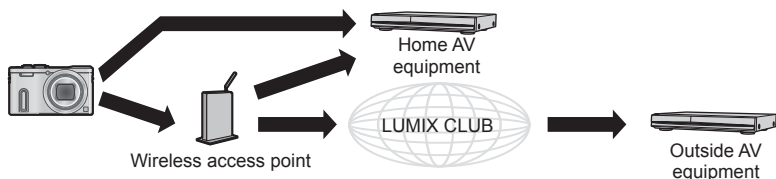

### ■ Sending method, and pictures that can be sent

	JPEG	RAW	MP4	AVCHD	3D
<b>Sending a picture each time one is recorded</b> [Send Images While Recording]	○	-	-	-	○
<b>Sending selected pictures</b> [Send Images Stored in the Camera]	○	-	-	-	○

- Some images may not be played back or sent depending on the device.
- See the operating instructions of the destination device for more information about picture playback.
- For more details about picture sending methods. ([→253](#))

**Preparations:**

When sending a picture to [Home], set your device to DLNA waiting Mode.

- Read the operating instructions of your device for details.

When sending images to [External], the following are required:

- Registration to "LUMIX CLUB". (→231)
- Address number and access number acquired by the destination External AV device. (→236)

See the part of the manual that applies to your objective.

**Sending a picture each time one is recorded ([Send Images While Recording]) (→213)**

**Sending selected pictures ([Send Images Stored in the Camera]) (→214)**



## ■ Sending a picture each time one is recorded ([Send Images While Recording])

### 1 Press [Wi-Fi] button

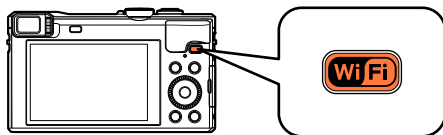

### 2 Use cursor button to select [New Connection], and then press [MENU/SET]

### 3 Use cursor button to select [Send Images While Recording], and then press [MENU/SET]

### 4 Use cursor button to select [AV device], and then press [MENU/SET]

### 5 Select [Home] or [External]

### 6 Select [Via Network] or [Direct] to connect (→245)

- [Direct] cannot be selected when [External] has been selected.

### 7 Select the device you wish to connect to

- When the connection is complete, the screen is displayed. To change the send setting, press [DISP.] button. (→254)

### 8 Take still pictures

- To change the setting or disconnect, press [Wi-Fi] button. (→186)  
You cannot change the settings while sending still pictures. Wait until sending is complete.

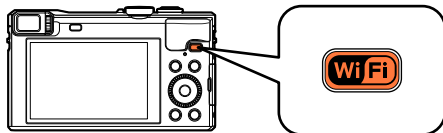
**■ Sending selected pictures ([Send Images Stored in the Camera])****1 Press [Wi-Fi] button****2 Use cursor button to select [New Connection], and then press [MENU/SET]****3 Use cursor button to select [Send Images Stored in the Camera], and then press [MENU/SET]****4 Use cursor button to select [AV device], and then press [MENU/SET]****5 Select [Home] or [External]****6 Select [Via Network] or [Direct] to connect (→245)**

• [Direct] cannot be selected when [External] has been selected.

**7 Select the device you wish to connect to**

• When the connection is complete, the screen is displayed. To change the send setting, press [DISP.] button. (→254)

(Continued on the next page)

## 8 Select [SINGLE] or [MULTI]

- To change the setting or disconnect, press [Wi-Fi] button. (→186)

### ■ When [SINGLE] is selected

- ① Select the picture
- ② Select [Set]

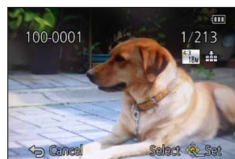

### ■ When [MULTI] is selected

- ① Select the picture (repeat)
  - If selected again, the setting will be cancelled.
- ② Select [OK]
  - The number of pictures that can be sent by [MULTI] is limited.

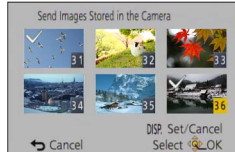

- Confirmation screen is displayed. If you select [Yes], the operation is executed.

## Sending pictures to a PC

Still pictures and motion pictures recorded by the camera can be sent to a PC. You can make a setting so that pictures in the camera can be sent to a PC automatically while the camera battery is charging. ([Smart Transfer] (→238))

### ■ Sending method, and pictures that can be sent

	JPEG	RAW	MP4	AVCHD*	3D
<b>Sending a picture each time one is recorded</b> [Send Images While Recording]	○	○	—	—	○
<b>Sending selected pictures</b> [Send Images Stored in the Camera]	○	○	○	○	○

\*Motion pictures recorded in [AVCHD] can be sent in file sizes of up to 4 GB. Files larger than 4 GB cannot be sent.

- Some images may not be played back or sent depending on the device.
- See the operating instructions of the destination device for more information about picture playback.
- For more details about picture sending methods. (→253)

#### Preparations:

- Turn the computer on.
- Prepare folders for receiving images on the PC before sending a picture to the PC. (→217)
- If the standard settings are changed for the workgroup on the connected PC, you must change settings in [PC Connection] on this unit. (→255)

See the part of the manual that applies to your objective.

**Sending a picture each time one is recorded ([Send Images While Recording]) (→218)**

**Sending selected pictures ([Send Images Stored in the Camera]) (→219)**

**■ To create a folder that receives images**

- Create a PC user account (account name (up to 254 characters) and password (up to 32 characters)) consisting of alphanumeric characters. An attempt to create a receive folder may fail if the account includes non-alphanumeric characters.

**■ When using “PHOTOfunSTUDIO”****1 Install “PHOTOfunSTUDIO” on the PC**

- “PHOTOfunSTUDIO” is not compatible with Mac.
- For details on hardware requirements and installation, read “Installing supplied software” (→286).

**2 Create a folder that receives images with “PHOTOfunSTUDIO”**

- To create the folder automatically, select [Auto-create]. To specify a folder, create a new folder, or set a password to the folder, select [Create manually].
- For details, refer to the operating instructions of “PHOTOfunSTUDIO” (PDF).

**■ When not using “PHOTOfunSTUDIO”**

(For Windows)

Supported OS: Windows 8.1 / Windows 8 / Windows 7 / Windows Vista / Windows XP

Example: Windows 7

**1 Select a folder you intend to use for receiving, then right-click****2 Select [Properties], then enable sharing of the folder**

- For details, refer to the operating instructions of your PC or Help on the operating system.

(For Mac)

Supported OS: OS X v10.5 to v10.9

Example: OS X v10.8

**1 Select a folder you intend to use for receiving, then click on the items in the following order**

[File] → [Get Info]

**2 Enable sharing of the folder**

- For details, refer to the operating instructions of your PC or Help on the operating system.

■ Sending a picture each time one is recorded ([Send Images While Recording])

**1** Press [Wi-Fi] button

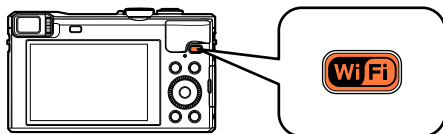

**2** Use cursor button to select [New Connection] and press [MENU/SET]

**3** Use cursor button to select [Send Images While Recording] and press [MENU/SET]

**4** Use cursor button to select [PC] and press [MENU/SET]

**5** Select [Via Network] or [Direct] to connect (→245)

**6** Select the PC you want to connect to

- If the PC you want to connect to is not displayed, select [Manual Input], then enter the computer name (for Mac, enter the NetBIOS name).

**7** Select the folder you want to send to

- When the connection is complete, the screen is displayed. To change the send setting, press [DISP.] button. (→254)

**8** Take still pictures

- To change the setting or disconnect, press [Wi-Fi] button. (→186)  
You cannot change the settings while sending still pictures. Wait until sending is complete.

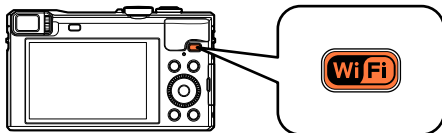
**■ Sending selected pictures ([Send Images Stored in the Camera])****1 Press [Wi-Fi] button****2 Use cursor button to select [New Connection], and then press [MENU/SET]****3 Use cursor button to select [Send Images Stored in the Camera], and then press [MENU/SET]****4 Use cursor button to select [PC] and press [MENU/SET]****5 Select [Via Network] or [Direct] to connect (→245)****6 Select the PC you want to connect to**

- If the PC you want to connect to is not displayed, select [Manual Input], then enter the computer name (for Mac, enter the NetBIOS name).

**7 Select the folder you want to send to**

- When the connection is complete, the screen is displayed. To change the send setting, press [DISP.] button. (→254)

(Continued on the next page)

## 8 Select [SINGLE] or [MULTI]

- To change the setting or disconnect, press [Wi-Fi] button. (→186)

### ■ When [SINGLE] is selected

- ① Select the picture
- ② Select [Set]

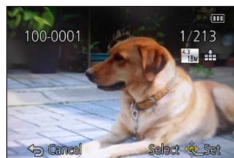

### ■ When [MULTI] is selected

- ① Select the picture (repeat)
  - If selected again, the setting will be cancelled.
- ② Select [OK]
  - The number of pictures that can be sent by [MULTI] is limited.

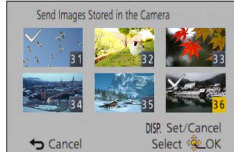

- Confirmation screen is displayed. If you select [Yes], the operation is executed.

- Folders sorted by the sent date are created in the specified folder, and pictures are saved in those folders.
- If the screen for a user account and password entry appears, enter the one you set on your PC.
- If the computer name (for Mac, the NetBIOS name) contains spaces, etc., the name may not be properly recognised. If you cannot connect, we recommend changing the computer name (for Mac, the NetBIOS name) to a combination of 15 or less alphanumeric characters only.



## Using WEB services

Through “LUMIX CLUB”, you can send still pictures and motion pictures to social networking services, etc. By selecting the setting to automatically transfer still pictures and motion pictures to [Cloud Sync. Service], you can receive the transferred still pictures and motion pictures on a PC or a smartphone.

You can make a setting so that pictures in the camera can be sent to a WEB service or cloud synchronisation service automatically while the camera battery is charging. ([Smart Transfer] (→238))



See the part of the manual that applies to your objective.

**When sending images to WEB service (→222)**

**When sending images to [Cloud Sync. Service] (→227)**

## When sending images to WEB service

## ■ Sending method, and pictures that can be sent

	JPEG	RAW	MP4	AVCHD	3D
<b>Sending a picture each time one is recorded</b> [Send Images While Recording]	○	—	—	—	○
<b>Sending selected pictures</b> [Send Images Stored in the Camera]	○	—	○	—	○

- Some images may not be played back or sent depending on the device.
- For details about playback of pictures, check the WEB service to which you will send the pictures.
- For more details about picture sending methods. ([→253](#))

**Preparation:**

You need to register to “LUMIX CLUB” ([→231](#)) to send a picture to a WEB service. When sending images to WEB services, such as Facebook or YouTube, the WEB service being used must be registered with the “LUMIX CLUB”. Registering multiple WEB services will send images to all services simultaneously. ([→224](#))

See the part of the manual that applies to your objective.

**Sending a picture each time one is recorded ([Send Images While Recording])**  
([→225](#))

**Sending selected pictures ([Send Images Stored in the Camera])** ([→226](#))

- Images uploaded to the WEB service cannot be displayed or deleted with this camera. Check images by accessing the WEB service with your smartphone or computer.
- If sending images fails, a report email outlining the failure will be sent to the email address registered with "LUMIX CLUB".
- **Images may contain personal information that can be used to identify the user, such as a title, the time and date when the images were taken, and the location where the image was taken. Check this information before uploading images to WEB services.**
  - Panasonic assumes no responsibility for the damages resulting from the leakage, loss, etc. of images uploaded on WEB services.
  - When uploading images to the WEB service, do not delete images from this camera, even after they have finished sending, until you have checked that they have been properly uploaded to the WEB service. Panasonic assumes no responsibility for the damages resulting from the deletion of images stored in this unit.

## ■ Using WEB services

When sending images to WEB services, such as Facebook or YouTube, the WEB service being used must be registered with the "LUMIX CLUB". Registering multiple WEB services will send images to all services simultaneously.

- Check the "FAQ/Contact us" on the following site for compatible WEB services.  
[http://lumixclub.panasonic.net/eng/c/lumix\\_faqs/](http://lumixclub.panasonic.net/eng/c/lumix_faqs/)

### Preparation:

Make sure that you have created an account on the WEB service you want to use, and have the login information available.

### 1 Connect to the "LUMIX CLUB" site using a smartphone or computer

<http://lumixclub.panasonic.net/eng/c/>

### 2 Enter your "LUMIX CLUB" login ID and password and log in to the service (→231)

### 3 Register your email address

### 4 Select the WEB service to be used and register it

- Follow the instructions on the screen to register the service.

■ Sending a picture each time one is recorded ([Send Images While Recording])

**1** Press [Wi-Fi] button

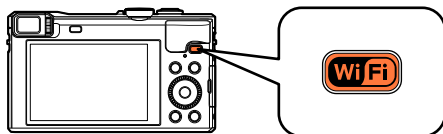

**2** Use cursor button to select [New Connection], and then press [MENU/SET]

**3** Use cursor button to select [Send Images While Recording], and then press [MENU/SET]

**4** Use cursor button to select [Web service], and then press [MENU/SET]

**5** Select [Via Network] and connect (→246)

**6** Select a WEB service you want to connect

- When the connection is complete, the screen is displayed. To change the send setting, press [DISP.] button. (→254)

**7** Take still pictures

- To change the setting or disconnect, press [Wi-Fi] button. (→186)  
You cannot change the settings while sending still pictures. Wait until sending is complete.

## ■ Sending selected pictures ([Send Images Stored in the Camera])

### 1 Press [Wi-Fi] button

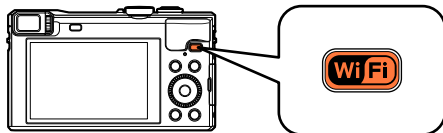

### 2 Use cursor button to select [New Connection], and then press [MENU/SET]

### 3 Use cursor button to select [Send Images Stored in the Camera], and then press [MENU/SET]

### 4 Use cursor button to select [Web service], and then press [MENU/SET]

### 5 Select [Via Network] and connect (→246)

### 6 Select a WEB service you want to connect

- When the connection is complete, the screen is displayed. To change the send setting, press [DISP.] button. (→254)

### 7 Select [SINGLE] or [MULTI]

- To change the setting or disconnect, press [Wi-Fi] button. (→186)

#### ■ When [SINGLE] is selected

- ① Select the picture
- ② Select [Set]

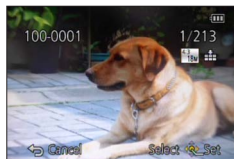

#### ■ When [MULTI] is selected

- ① Select the picture (repeat)
  - If selected again, the setting will be cancelled.
- ② Select [OK]
  - The number of pictures that can be sent by [MULTI] is limited.

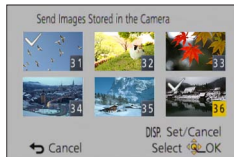

- Confirmation screen is displayed. If you select [Yes], the operation is executed.

## When sending images to [Cloud Sync. Service]

## ■ Sending method, and pictures that can be sent

	JPEG	RAW	MP4	AVCHD	3D
<b>Sending a picture each time one is recorded</b> [Send Images While Recording]	○	—	—	—	○
<b>Sending selected pictures</b> [Send Images Stored in the Camera]	○	—	○	—	○

- Some images may not be played back or sent depending on the device.
- See the operating instructions of the destination device for more information about picture playback.
- For more details about picture sending methods. (→253)

**Preparation:**

You need to register to "LUMIX CLUB" (→231) and configure the Cloud Sync. setting to send a picture to a Cloud Folder.

See the part of the manual that applies to your objective.

**Sending a picture each time one is recorded ([Send Images While Recording])**  
(→228)

**Sending selected pictures ([Send Images Stored in the Camera])** (→229)

**■ About the images sent to a Cloud Folder by the use of [Cloud Sync. Service] (Current as of January 2014)**

To send images to a PC, Cloud Sync. setting is required. Configure the settings on a PC with "PHOTOfunSTUDIO" or on a smartphone with "Image App".

- If you set the picture destination to [Cloud Sync. Service], sent pictures are temporarily saved in the cloud folder, and they can be synchronised with the device in use, such as the PC or smartphone.
- A Cloud Folder stores transferred images for 30 days (up to 1000 pictures). Transferred images are deleted automatically 30 days after the transfer. Furthermore, when the number of stored images exceeds 1000, some images may be deleted depending on the [Cloud Limit] (→254) setting even within 30 days after the transfer.
- When the download of images from a Cloud Folder to all specified devices is complete, images may be deleted from the Cloud Folder even within 30 days after the transfer.

## ■ Sending a picture each time one is recorded ([Send Images While Recording])

### 1 Press [Wi-Fi] button

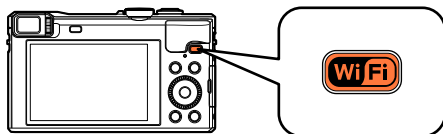

### 2 Use cursor button to select [New Connection], and then press [MENU/SET]

### 3 Use cursor button to select [Send Images While Recording], and then press [MENU/SET]

### 4 Use cursor button to select [Cloud Sync. Service], and then press [MENU/SET]

### 5 Check the message and press [MENU/SET]

### 6 Select [Via Network] and connect (→246)

### 7 Check the send setting

- When the connection is complete, the screen is displayed. To change the send setting, press [DISP.] button. (→254)

### 8 Take still pictures

- To change the setting or disconnect, press [Wi-Fi] button. (→186)  
You cannot change the settings while sending still pictures. Wait until sending is complete.

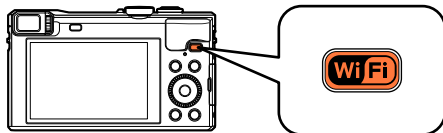

**■ Sending selected pictures ([Send Images Stored in the Camera])****1 Press [Wi-Fi] button****2 Use cursor button to select [New Connection], and then press [MENU/SET]****3 Use cursor button to select [Send Images Stored in the Camera], and then press [MENU/SET]****4 Use cursor button to select [Cloud Sync. Service], and then press [MENU/SET]****5 Check the message and press [MENU/SET]****6 Select [Via Network] and connect (→246)****7 Check the send setting**

- When the connection is complete, the screen is displayed. To change the send setting, press [DISP.] button. (→254)

(Continued on the next page)

## 8 Select [SINGLE] or [MULTI]

- To change the setting or disconnect, press [Wi-Fi] button. (→186)

### ■ When [SINGLE] is selected

- ① Select the picture
- ② Select [Set]

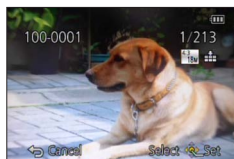

### ■ When [MULTI] is selected

- ① Select the picture (repeat)
  - If selected again, the setting will be cancelled.
- ② Select [OK]
  - The number of pictures that can be sent by [MULTI] is limited.

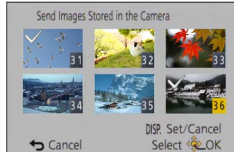

- Confirmation screen is displayed. If you select [Yes], the operation is executed.

## Using “LUMIX CLUB”

### About the [LUMIX CLUB]

Acquire a “LUMIX CLUB” login ID (free).

If you register this unit to the “LUMIX CLUB”, you can synchronise images between the devices you are using, or transfer these images to WEB services.

Use the “LUMIX CLUB” when uploading pictures to WEB services or external AV device.

- You can set the same “LUMIX CLUB” login ID for this unit and a smartphone. (→234)

Refer to the “LUMIX CLUB” site for details.  
<http://lumixclub.panasonic.net/eng/c/>

Please note;

- The service may be suspended due to regular maintenance or unexpected problems, and service contents may be changed or added to, without prior notice to the users.
- The service may be stopped in whole or in part with a reasonable period of advance notice.

**1** Select [Wi-Fi Setup] in the [Wi-Fi] menu, and press [MENU/SET] (→60)

**2** Use cursor button to select [LUMIX CLUB], and press [MENU/SET]

**3** Select [Set/Add Account]

**4** Select [New account]

- Connect to the network. Proceed to the next page by selecting [Next].
- A confirmation screen will be displayed if a login ID has already been acquired for the camera. Select [Yes] to acquire a new login ID, or [No] if you do not need to acquire a new login ID.

(Continued on the next page)

## 5 Select the method for connecting to a wireless access point, and set

- For details (→246).
- The settings screen will only appear during the first connection. Connection methods set on this unit are stored and will be used for subsequent connections. If you want to change the wireless access point to connect to, press the [DISP.] button, then change the connecting destination.

## 6 Read through the "LUMIX CLUB" terms of use and select [Agree]

- You can press ▲▼ to switch pages.
- Press [Q.MENU/☞] button to cancel the process without acquiring a login ID.

## 7 Enter the password

- Enter any combination of 8 to 16 characters and numbers for the password.
- For details on how to enter characters, refer to "Entering Text" (→75).

## 8 Check the login ID and select [OK]

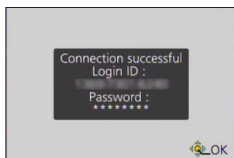

- The login ID (12-digit number) will be displayed automatically. When logging in to the "LUMIX CLUB" with a computer, you only need to enter the numbers.
- A message is displayed when the connection is complete. Select [OK].
- **Be sure to make a note of the login ID and password.**
- Close the menu after changing settings.

**■ Using a previously acquired login ID/confirming and changing login ID and password ([Set Login ID])****Preparation:**

To use a previously acquired login ID, confirm your ID and password.

To change the "LUMIX CLUB" password on the camera, access the "LUMIX CLUB" website from your smartphone or PC and change the "LUMIX CLUB" password in advance.

- 1** Select **[Wi-Fi Setup]** in the **[Wi-Fi]** menu, and press **[MENU/SET]** (→60)
- 2** Use cursor button to select **[LUMIX CLUB]**, and press **[MENU/SET]**
- 3** Select **[Set/Add Account]**
- 4** Select **[Set Login ID]**
  - The login ID and password are displayed.
  - The password is displayed as "★".
  - Close the menu if only checking the login ID.
- 5** Select the item you wish to change
- 6** Enter your login ID or password
  - Refer to "Entering Text" (→75) for information on how to enter text.
  - Enter the new password you have created on your smartphone or PC into the camera. If the password differs from the one you created on your smartphone or PC, you will not be able to upload images.
- 7** Select **[Exit]**

**■ To set the same login ID for the camera and the smartphone/tablet**

- Setting the same login ID on this unit and your smartphone is convenient for sending images on this unit to other devices or WEB services.

**■ When either this unit or the smartphone/tablet has acquired the login ID****1 Connect this unit to the smartphone (→190)****2 From the "Image App" menu, set the common login ID**

- The login IDs for this unit and the smartphone become the same.
- After connecting this unit to the smartphone, the setup screen for a common login ID may appear when you display the playback screen. You can also set a common login ID by following the on-screen instructions.
- This operation is not available for [Wi-Fi Direct] connection.

**■ When this unit and the smartphone/tablet have acquired different login IDs**

(When you want to use the smartphone's login ID for this unit)

**Change the login ID and password for this unit to those acquired by the smartphone**

(When you want to use this unit's login ID for the smartphone)

**Change the login ID and password for the smartphone to those acquired by this unit**

**■ Check the "LUMIX CLUB" terms of use**

Check the details if the terms of use have been updated.

**1 Select [Wi-Fi Setup] in the [Wi-Fi] menu, and press [MENU/SET] (→60)****2 Use cursor button to select [LUMIX CLUB], and press [MENU/SET]****3 Select [Terms of use]**

- The camera will connect to the network and the terms of use will be displayed. Close the menu after checking the terms of use.

**■ Delete your login ID and account from the "LUMIX CLUB"**

Delete the login ID from the camera when transferring it to another party or disposing of it. You can also delete your "LUMIX CLUB" account.

- 1 Select [Wi-Fi Setup] in the [Wi-Fi] menu, and press [MENU/SET] (→60)**
- 2 Use cursor button to select [LUMIX CLUB], and press [MENU/SET]**
- 3 Select [Delete account]**
  - The message is displayed. Select [Next].
- 4 Select [Yes] in the login ID delete confirmation screen**
  - The message is displayed. Select [Next].
- 5 Select [Yes] on the confirmation screen for deleting the "LUMIX CLUB" account**
  - If you want to continue using the service, selecting [No] will only delete the login ID. Exit the menu after it is executed.
- 6 Select [Next]**
  - The login ID is deleted, and then the message notifying the deletion of your account is displayed. Select [OK].
  - Exit the menu after it is executed.

● Changes and other actions to login IDs can only be made to the login ID acquired with the camera.

**Configuring the external AV device settings**

Images can be sent to the AV device of relatives and acquaintances via "LUMIX CLUB".

**Preparation:**

Check the address number (16-digit number) and access number (4-digit number) of the destination AV device issued by "LUMIX CLUB".

(Refer to the AV device instruction manual for details)

- 1** Select **[Wi-Fi Setup]** in the **[Wi-Fi]** menu, and press **[MENU/SET]** (→60)
- 2** Use cursor button to select **[External AV device]**, and press **[MENU/SET]**
- 3** Select **[Add new device]**
- 4** Enter the address number
- 5** Enter the access number
- 6** Enter any name
  - Up to 28 characters can be entered. A double-byte character will be treated as two characters.
  - Close the menu after changing settings.

● Refer to "Entering Text" (→75) for information on how to enter text.



### ■ Change or delete information on registered AV device

Information on AV device that has already been registered can be changed or deleted.

- 1** Select **[Wi-Fi Setup]** in the **[Wi-Fi]** menu, and press **[MENU/SET]** (→60)
- 2** Use cursor button to select **[External AV device]**, and press **[MENU/SET]**
- 3** Select the AV device you want to change or delete
- 4** Select **[Edit]** or **[Delete]**

Item	Description
[Edit]	Change information on AV device that has already been registered. Perform steps <b>4</b> through <b>6</b> of "Configuring the external AV device settings". (→236)
[Delete]	Delete information on AV device that has already been registered. <ul style="list-style-type: none"> <li>• Confirmation screen is displayed. It is executed when [Yes] is selected.</li> </ul>

- Exit the menu after it is executed.

## Transferring pictures automatically [Smart Transfer]

[Smart Transfer] automatically transfers pictures from your camera to your PC, AV equipment or Cloud Folder. [Auto Transfer] automatically transfers pictures while charging the camera, and [Transfer Now] transfers the recorded pictures immediately.

Example: [Auto Transfer]

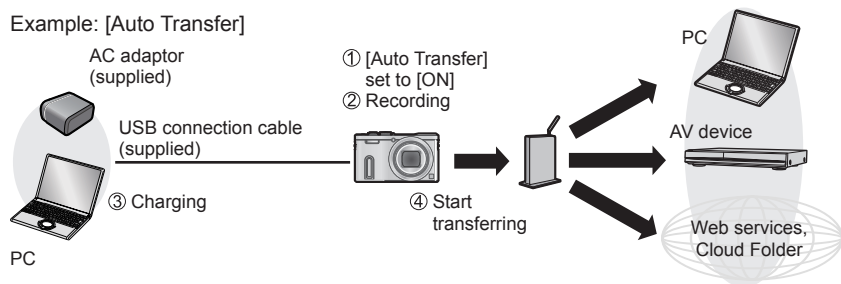

Pictures that can be sent with [Smart Transfer].

		JPEG	RAW	MP4	AVCHD*	3D
[Destination]	[PC]	○	○	○	○	○
	[Cloud Sync. Service]	○	—	○	—	○
	[AV device]	○	—	—	—	○

\* Motion pictures recorded in [AVCHD] can be sent in file sizes of up to 4 GB. Files larger than 4 GB cannot be sent.

Follow the procedures below to perform [Smart Transfer].

**1** [Setting \[Smart Transfer\] \(→240\)](#)

**2** [\[Auto Transfer\] \(→241\) or \[Transfer Now\] \(→242\)](#)

## Transferring pictures automatically [Smart Transfer]

- When [Auto Transfer] is set to [ON], the camera automatically uploads recorded pictures. For this reason pictures may be uploaded unintentionally if, for example, you share this unit with other people. Panasonic assumes no responsibility for any damages caused by uploaded images.
- Panasonic assumes no responsibility for any damages caused by the use of [Smart Transfer].
- Electromagnetic waves from the camera can affect instruments and meters. If you are on an airplane or anyplace where the use of functions like Wi-Fi or NFC is prohibited, turn [Airplane Mode] to [ON].
- If charging does not start due to an error (→304), [Smart Transfer] may not work.

## Setting [Smart Transfer]

The first time you use [Smart Transfer], follow the steps below to make settings. For the second and subsequent times, you can change the settings with [Set Destination] (→243).

- 1 Select [Wi-Fi Setup] in the [Wi-Fi] menu, and press [MENU/SET] (→60)**
- 2 Use cursor button to select [Smart Transfer] and press [MENU/SET]**
- 3 Use cursor button to select transfer destination and press [MENU/SET]**
- 4 Select the method for connecting to a wireless access point, and set**
  - For details (→246).
- 5 Set the transfer destination**
  - When [PC] is selected**
    - For details regarding preparation before transfer, read “To create a folder that receives images”. (→217)
    - ① Use cursor button to select a PC you want to connect, and then press [MENU/SET]
    - ② Use cursor button to select the incoming folder, and then press [MENU/SET]
  - When [Cloud Sync. Service] is selected**
    - For details regarding preparation before transfer, read “When sending images to [Cloud Sync. Service]”. (→227)
  - When [AV device] is selected**
    - For details, read “Sending pictures to AV equipment”. (→211)
    - Select the AV device you want to connect, and then press the [MENU/SET] button.
- 6 Use cursor button to select [Auto Transfer] and press [MENU/SET]**
- 7 Use cursor button to select [ON] and press [MENU/SET]**
  - Only the images you recorded when [Auto Transfer] is set to [ON] is transferred. Pictures recorded before that are not transferred.

**[Auto Transfer]**

Automatically transfer pictures during charging.

**Preparation:** Set [Smart Transfer]. (→240)

**1 Turn off the camera**

**2** (When using a power outlet)

**Connect the AC adaptor (supplied) and the camera using the USB connection cable (supplied), and plug the AC adaptor (supplied) into the electrical outlet**

(When using a PC)

**Connect the camera to a computer using the USB connection cable (supplied)**

- [Smart Transfer] starts automatically according to the [Charge Priority] (→244) setting.
- [Smart Transfer] is not available when the memory card is locked.
- Depending on the specifications of the PC, [Smart Transfer] may fail.

- If there are pictures that are not transferred when [Auto Transfer] is set to [OFF], the message that confirms whether to transfer these pictures is displayed. Select a desired option.

**[Transfer Now]**

Transfer pictures to the preset destination immediately.

**Preparation:** Set [Smart Transfer]. (→240)

- 1 Connect the AC adaptor (supplied) and the camera using the USB connection cable (supplied), and plug the AC adaptor (supplied) into the electrical outlet**
  - Switch to Playback Mode.
- 2 Select [Wi-Fi Setup] in the [Wi-Fi] menu, and press [MENU/SET] (→60)**
- 3 Use cursor button to select [Smart Transfer] and press [MENU/SET]**
- 4 Use cursor button to select [Transfer Now] and press [MENU/SET]**
  - Confirmation screen is displayed. It is executed when [Yes] is selected. Exit the menu after it is executed.

**[Set Destination]**

Changes transfer destination of pictures and settings.

- 1** Select **[Wi-Fi Setup]** in the **[Wi-Fi]** menu, and press **[MENU/SET]** (→60)
- 2** Use cursor button to select **[Smart Transfer]** and press **[MENU/SET]**
- 3** Use cursor button to select **[Set Destination]** and press **[MENU/SET]**
- 4** Use cursor button to select an item and press **[MENU/SET]**

Item	Description
<b>[Destination]</b>	Change the transfer destination. <b>[PC], [Cloud Sync. Service], [AV device]</b> <ul style="list-style-type: none"> <li>• To change the wireless access point you want to connect to           <ol style="list-style-type: none"> <li>① Select <b>[Change Access Point]</b> and press <b>[MENU/SET]</b> (If you selected <b>[Cloud Sync. Service]</b>, select <b>[Yes]</b> at the confirmation screen of the connection destination and press <b>[MENU/SET]</b>)</li> <li>② Select the method for connecting to a wireless access point, and set               <ul style="list-style-type: none"> <li>• For details (→246).</li> </ul> </li> </ol> </li> </ul>
<b>[Size]</b>	Change the size of the picture to be transferred. <b>[Original], [Change]</b> <ul style="list-style-type: none"> <li>• <b>[Change]:</b> <b>[M]</b> or <b>[S]</b> can be selected for picture size. The aspect ratio of the pictures does not change.</li> </ul>
<b>[File Format]*1</b>	<b>[JPG], [RAW+JPG], [RAW]</b>
<b>[Delete Location Data]*2</b>	You can select whether to delete location information from the picture when transferring pictures. <b>[ON]:</b> Erase location information and transfer. <b>[OFF]:</b> Transfer without deleting location information. <ul style="list-style-type: none"> <li>• The location information is only deleted for the transferred pictures. (Location information is not deleted from pictures in this unit)</li> </ul>
<b>[Cloud Limit]*2</b>	You can select whether to perform <b>[Smart Transfer]</b> when the capacity of the Cloud Folder runs out of free space. <b>[ON]:</b> Do not transfer pictures. <b>[OFF]:</b> Delete oldest pictures in order and transfer new pictures.

\*1 Only available when the **[Destination]** is set to **[PC]**.

\*2 Only available when the **[Destination]** is set to **[Cloud Sync. Service]**.

**[Charge Priority]**

Set priority to charge or picture transfer.

- 1** Select **[Wi-Fi Setup]** in the **[Wi-Fi]** menu, and press **[MENU/SET]** (→60)
- 2** Use cursor button to select **[Smart Transfer]** and press **[MENU/SET]**
- 3** Use cursor button to select **[Charge Priority]** and press **[MENU/SET]**
- 4** Use cursor button to select an item and press **[MENU/SET]**

Item	Description
[ON]	Give priority to charging. Pictures are transferred after charging.
[OFF]	Give priority to picture transfers. • When remaining battery is low, charging may be prioritised.

**[Display Log]**

You can check the day the picture was sent and its details.

- 1** Select **[Wi-Fi Setup]** in the **[Wi-Fi]** menu, and press **[MENU/SET]** (→60)
- 2** Use cursor button to select **[Smart Transfer]** and press **[MENU/SET]**
- 3** Use cursor button to select **[Display Log]** and press **[MENU/SET]**



## About connections

After selecting the Wi-Fi function and sending destination, select the connection method. If you are out and unable to use your wireless access point, or temporarily connecting to equipment you do not ordinarily use, or in a similar situation, it is convenient to make a direct connection.

If you are connecting with the same settings as used previously, you can quickly start using the Wi-Fi function by connecting with [History Connection] or [Favorite Connection].

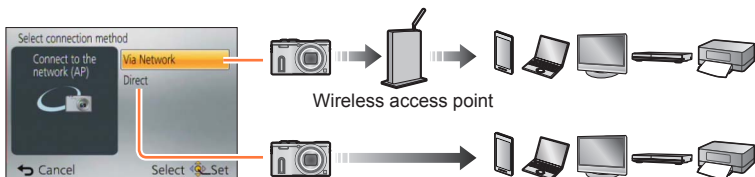

Connection method	Description
[Via Network]	Connects through a wireless access point. <a href="#">(→246)</a>
[Direct]	Your equipment connects directly to the camera. <a href="#">(→249)</a>

## [Via Network] Connecting via a wireless access point

Select a connection method to the wireless access point.

- WPS refers to a function that allows you to easily configure the settings related to the connection and security of wireless LAN devices. To check if the wireless access point you are using is compatible with WPS, refer to the instruction manual of the wireless access point.

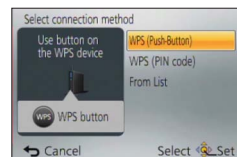

Connection method	Description
[WPS (Push-Button)]	<p>Save push button type wireless access point that is compatible with Wi-Fi Protected Setup™ with a WPS mark.</p> <p><b>Press the wireless access point WPS button until it switches to WPS Mode</b></p> <ul style="list-style-type: none"> <li>• Refer to the wireless access point instruction manual for details.</li> </ul>
[WPS (PIN code)]	<p>Save PIN code type wireless access point that is compatible with Wi-Fi Protected Setup with a WPS mark.</p> <ol style="list-style-type: none"> <li>① Select the wireless access point you are connecting to</li> <li>② Enter the PIN code displayed on the camera screen into the wireless access point</li> <li>③ Press [MENU/SET] <ul style="list-style-type: none"> <li>• Refer to the wireless access point instruction manual for details.</li> </ul> </li> </ol>
[From List]	<p>Select this option when you are not sure about the WPS compatibility, or when you want to search for and connect to a wireless access point.</p> <ul style="list-style-type: none"> <li>• For details (<a href="#">→247</a>).</li> </ul>

## ■ If you are not sure about the WPS compatibility (connecting by [From List])

Search for available wireless access points.

- Confirm encryption key of the selected wireless access point if the network authentication is encrypted.
- When connecting by [Manual Input], confirm SSID, network authentication type, encryption type, encryption key of the wireless access point you are using.

## 1 Use cursor button to select the wireless access point you are connecting to, and press [MENU/SET]

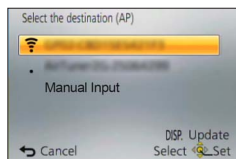

- Pressing [DISP.] button will search for a wireless access point again.
- If no wireless access point is found, refer to “When connecting with [Manual Input]” (→248).

## 2 (If network authentication is encrypted) Enter the encryption key

- For details on how to enter characters, refer to “Entering Text” (→75).

## ■ When connecting with [Manual Input]

- 1** On the screen of step **1** of “If you are not sure about the WPS compatibility (connecting by [From List])”, select [Manual Input] (→247)
- 2** Enter the SSID of the wireless access point you are connecting to, then select [Set]
  - For details on how to enter characters, refer to “Entering Text” (→75).
- 3** Select the network authentication type
  - For information on network authentication, see the instruction manual of the wireless access point.
- 4** Select the encryption type
  - The type of settings that can be changed may vary depending on the details of network authentication settings.

Network authentication type	Encryption types that can be set
[WPA2-PSK] / [WPA-PSK]	[TKIP] / [AES]
[Common Key]	[WEP]
[Open]	[No Encryption] / [WEP]

- 5** (When an option other than [No Encryption] is selected)  
Enter the encryption key

- Check the wireless access points instruction manual and settings when a saving wireless access point.
- If no connection can be established, the wireless access point's radio waves may be too weak. Refer to “Message displays” (→302) and “Q&A Troubleshooting” (→310) for details.
- Transmission speed may decrease, or may not be usable depending on the environment it is used in.

**[Direct] Connecting directly**

You can select the connection method to your equipment. Select a connection method with which your equipment is compatible.

- To connect this unit with [Wi-Fi Direct], Android OS 4.0 or above is required and the device must be compatible with Wi-Fi Direct™.
- WPS refers to a function that allows you to easily configure the settings related to the connection and security of wireless LAN devices.

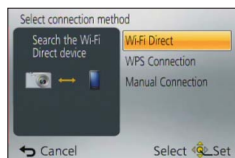

Connection method	Description
[Wi-Fi Direct]	<ol style="list-style-type: none"> <li>① Set the device to Wi-Fi Direct™ mode</li> <li>② Select [Wi-Fi Direct]</li> <li>③ Select the device to connect to           <ul style="list-style-type: none"> <li>• Read the operating instructions of your device for details.</li> </ul> </li> </ol>
[WPS Connection]	[WPS (Push-Button)] <ol style="list-style-type: none"> <li>① Select [WPS (Push-Button)]</li> <li>② Set the device to WPS mode           <ul style="list-style-type: none"> <li>• You can wait longer for a connection by pressing the [DISP.] button on this unit.</li> </ul> </li> </ol>
	[WPS (PIN code)] <ol style="list-style-type: none"> <li>① Select [WPS (PIN code)]</li> <li>② Enter the PIN code of the device into this unit</li> </ol>
[Manual Connection]	<ol style="list-style-type: none"> <li>① Enter the SSID and password into the device. The SSID and password are displayed on the connection waiting screen of this unit.           <ul style="list-style-type: none"> <li>• If the transfer destination is [Smartphone], you can read the QR Code with your smartphone to connect. (→191)</li> </ul> </li> </ol>

### Connecting quickly with the same settings as used previously ([History Connection]/[Favorite Connection])

The camera keeps a History of times you used the Wi-Fi function. You can register items in the History to Favourite.

You can easily connect with the same settings as used previously by connecting from History or Favourite.

#### 1 Press [Wi-Fi] button

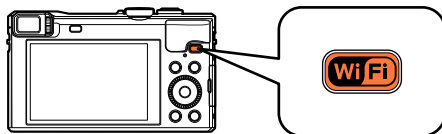

#### 2 Select [History Connection] or [Favorite Connection]



Item	Description
[History Connection]	Connects using the same settings as used previously.
[Favorite Connection]	Connects using settings registered in Favourite.

#### 3 Select the desired connection setting

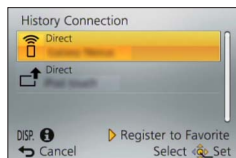

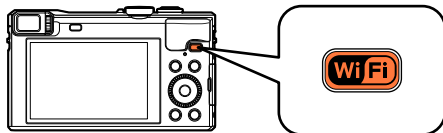
**■ Registering History items to Favourite****1** Press [Wi-Fi] button**2** Select [History Connection]**3** Select the item you wish to register and press ►**4** Enter a registration name

- For details on how to enter characters, refer to "Entering Text" (→75).
- Up to 30 characters can be entered. A double-byte character will be treated as two characters.

## ■ Editing items registered in Favourite

### 1 Press [Wi-Fi] button

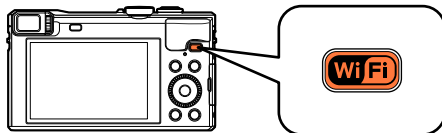

### 2 Select [Favorite Connection]

### 3 Select the Favourite item you wish to edit and press ►

### 4 Select item

Item	Description
[Remove from Favorite]	—
[Change the Order in Favorite]	Select the destination
[Change the Registered Name]	<ul style="list-style-type: none"> <li>• For details on how to enter characters, refer to “Entering Text” (→75).</li> <li>• Up to 30 characters can be entered. A double-byte character will be treated as two characters.</li> </ul>

- The number of settings that can be saved in the history is limited. We recommend that you register and save frequently used Wi-Fi connection settings to Favourite. (→251)
- When selecting History or Favourite items, you can view connection details by pressing the [DISP.] button.
- Performing [Reset Wi-Fi Settings] deletes content registered in History and Favourite.
- When using [History Connection] or [Favorite Connection] to connect to a network to which many PCs are connected, it may be difficult to make the connection because the camera searches for previously connected equipment out of a large number of equipment pieces. If you cannot connect, retry the connection using [New Connection].



## Settings for sending pictures

When sending pictures, first select [New Connection], then select the method of sending pictures.

After you have completed connecting, you can also change the sending settings, such as the size of pictures to be sent.

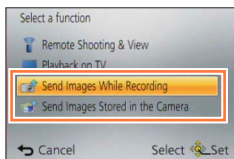

### ■ [Send Images While Recording]

A picture can be automatically sent to a specified device every time you take it.

- [Wi-Fi] is displayed on the recording screen while connected by [Send Images While Recording], and [Wi-Fi] is displayed while files are being sent.
- If you turn off the camera before you have completed sending, or if you close the Wi-Fi connection, or in similar situations, unsent files will not be resent.
- You may not be able to delete files or use the playback menu while sending.
- Motion pictures cannot be sent.



### ■ [Send Images Stored in the Camera]

You can select and send recorded images.

- Details of the playback menu [Favorite] or [Print Set] settings will not be sent.
- Some images taken with a different camera may not be able to be sent.
- Images that have been modified or edited with a computer may not be able to be sent.

## ■ Changing the settings for sending images

After you have completed connecting, you can change the sending settings, such as the size of pictures to be sent, by pressing the [DISP.] button.

Item	Description
[Size]	Resize the image to send. <b>[Original]/[Auto]*1/[Change]</b> <ul style="list-style-type: none"> <li>If you select [Auto], the image size is determined by the circumstances at the destination.</li> <li>You can select the image size for [Change] from [M] or [S]. The aspect ratio does not change.</li> </ul>
[File Format]*2	<b>[JPG], [RAW+JPG], [RAW]</b>
[Delete Location Data]*3	Select whether to delete the location information from images before sending them. <b>[ON]:</b> Delete the location information, then send. <b>[OFF]:</b> Keep the location information and send. <ul style="list-style-type: none"> <li>This operation only deletes the location information from the images that are set to be sent. (The location information will not be deleted from the original images stored in this unit.)</li> </ul>
[Cloud Limit]*4	You can select whether to send images when the Cloud Folder runs out of free space. <b>[ON]:</b> Do not send images. <b>[OFF]:</b> Delete images from the oldest ones, then send new images.

\*1 Only available when the destination is set to [Web service].

\*2 Only available when the destination is set to [PC].

\*3 Only available when the destination for [Send Images Stored in the Camera] is set to [Cloud Sync. Service], [Web service] or [External] in [AV device].

\*4 Only available when the destination is set to [Cloud Sync. Service].

## [Wi-Fi Setup] menu

Configure the settings required for the Wi-Fi function.

[Wi-Fi Setup] cannot be changed when connected to Wi-Fi. (excluding [Network Address])

- For details on how to select the [Setup] menu settings, refer to (→60).

**1** Select [Wi-Fi Setup] in the [Wi-Fi] menu

**2** Use cursor button to select item, and press [MENU/SET]

Item	Description
[Smart Transfer]	<ul style="list-style-type: none"> <li>• For details (→238).</li> </ul>
[LUMIX CLUB] Acquires or changes the "LUMIX CLUB" login ID.	<ul style="list-style-type: none"> <li>• For details (→231).</li> </ul>
[PC Connection] You can set the workgroup.	<p>You must connect to the same workgroup as the destination computer when sending pictures to the computer. (The default is set to "WORKGROUP")</p> <p><b>[Change Workgroup Name]:</b> Enter the workgroup of the connecting computer. Close the menu after changing settings.</p> <p><b>[Restore to Default]:</b> Returns settings to default settings. Confirmation screen is displayed. It is executed when [Yes] is selected. Exit the menu after it is executed.</p> <ul style="list-style-type: none"> <li>• Refer to "Entering Text" (→75) for information on how to enter text.</li> <li>• To use with a computer of the standard settings, you do not have to change the workgroup.</li> </ul>
[Device Name] You can change the name of this unit.	<ol style="list-style-type: none"> <li>① Press [DISP.] button</li> <li>② Enter the desired device name           <ul style="list-style-type: none"> <li>• Refer to "Entering Text" (→75) for information on how to enter text.</li> <li>• Up to 32 characters can be entered.</li> </ul> </li> </ol>
[External AV device] Images can be sent to the AV device of relatives and acquaintances via "LUMIX CLUB".	<ul style="list-style-type: none"> <li>• For details (→236).</li> </ul>

(Continued on the next page)

- For details on how to select the [Setup] menu settings, refer to (→60).

Item	Description
<p><b>[NFC Operation]</b> Makes NFC function setting.</p>	<p><b>[ON]:</b> The NFC function works. <b>[OFF]</b></p>
<p><b>[Wi-Fi Password]</b> To prevent incorrect operation or use of the Wi-Fi function by a third party and to protect saved personal information, it is recommended that you protect the Wi-Fi function with a password.</p>	<p>Setting a password will automatically display the password input screen when the Wi-Fi function is used.</p> <p><b>[Setup]:</b> Enter any 4-digit numbers as the password. Close the menu after changing settings.</p> <p><b>[Delete]:</b> Confirmation screen is displayed. It is executed when [Yes] is selected. Exit the menu after it is executed.</p> <hr/> <ul style="list-style-type: none"> <li>• For details on how to enter characters, refer to “Entering Text” (→75).</li> <li>• Make a copy of password. If you forget the password, you can reset it with [Reset Wi-Fi Settings] in the [Setup] menu, however other settings will also be reset. (excluding [LUMIX CLUB])</li> </ul>
<p><b>[Network Address]</b> Displays the MAC address and IP address of this unit.</p>	<ul style="list-style-type: none"> <li>• A “MAC Address” is a unique address that is used to identify network equipment.</li> <li>• “IP address” refers to a number that identifies a PC connected to a network such as the Internet. Usually, the addresses for homes are automatically assigned by the DHCP function such as a wireless access point. (Example: 192.168.0.87)</li> </ul>

## Using the GPS function to record the location of a picture

Before use, read “About GPS” (→10) and “User Licence Agreement for Location Name Data” (→320).

GPS stands for Global Positioning System. You can check your current location using GPS satellites. The camera receives radio signals that contain orbital information and time information from multiple GPS satellites, and uses them to calculate its current position. Calculating a position in this manner is known as “positioning”. The camera is also compatible with the satellite navigation system GLONASS operated by the Russian government.

This camera records the location information of a place where a picture was taken and also automatically adjusts the time to the local time.

### Precautions on properly receiving a GPS signal

- It is recommended to hold the camera steady with the GPS antenna (→258) pointed at the open sky while updating the GPS.
- The camera cannot properly receive radio signals from the GPS satellites in the following places. As a result, the camera may not be able to execute positioning or a significant error in positioning may occur.
  - Inside buildings
  - Surrounded by trees, such as in a forest
  - Inside a moving train, vehicle, etc.
  - Near high-voltage electrical power lines
  - In building basements
  - Between tall buildings or in a valley
  - Inside tunnels
  - Near devices such as a 1.5 GHz band mobile phone

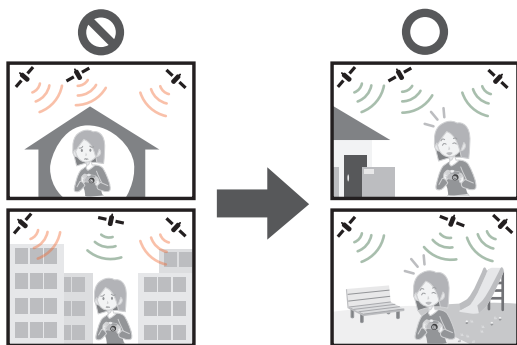

- Do not block the GPS antenna with your hand or other objects.
- If you want to execute positioning while you carry the camera around, do not put it in a metallic bag or case. If the camera is enclosed in something metallic, it cannot execute positioning.

**[GPS Setting]**

When [GPS Setting] is [ON], the camera periodically receives radio signals from the GPS satellites and executes positioning. When positioning is executed successfully, the place name and position (latitude and longitude) information are recorded in still pictures and motion pictures (excluding certain picture quality settings (→260)).

- If you select automatic time adjustment using the GPS function when you set the clock of this camera for the first time, [GPS Setting] is set to [ON].

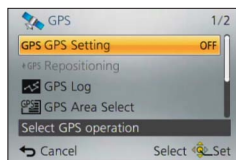
**1 Select [GPS Setting] from [GPS] menu and press [MENU/SET]****2 Use ▲ ▼ to select [ON] and press [MENU/SET]**

- A message appears on the screen. After confirming the message, press [MENU/SET].

[GPS Setting]	Description
[ON]	The camera periodically executes positioning. <ul style="list-style-type: none"> <li>• Even if the camera is turned off, positioning will be continued. (Positioning will stop after a certain period of time has elapsed.)</li> <li>• GPS turns off during charging. It remains off after charging finishes until the camera is turned on.</li> </ul>
[OFF]	The GPS function is set to OFF.
[INFO]	You can check the current reception status.

**■About operations during positioning**

The GPS status indicator lights up (green) while positioning is being executed and the GPS reception icon appears on the screen. (→259)

- The Wi-Fi connection lamp (blue) lights when GPS and Wi-Fi are operating simultaneously.

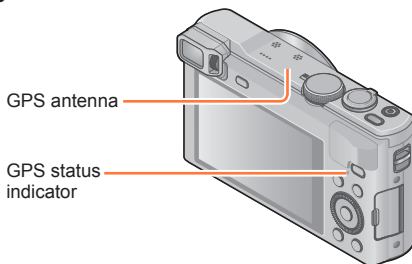

## ■ Displaying the status and result of positioning

The icons that indicate the status and result of positioning will appear. When positioning is successful, camera will search the place name information (name of place and landmark) inside its internal database and display it.

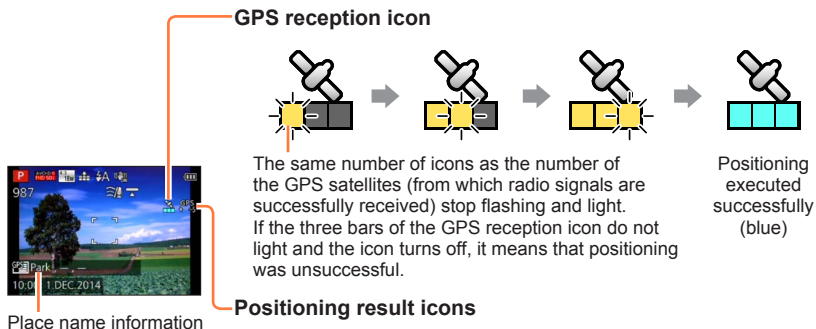

Icon	Time elapsed after successful positioning
GPS ↕ ~5	Less than 5 minutes.
GPS ↕ ~60	5 minutes to 1 hour have elapsed.
GPS ↕ ~120	1 hour to 2 hours have elapsed.
GPS ↕ 120~	2 hours or more have elapsed.
GPS ↕	Positioning failed. No location information/place name information available.

**Even if GPS reception is good, it will take approx. 2 to 3 minutes to successfully execute positioning in the following cases:**

- When positioning is executed for the first time
- When [GPS Setting] was set to [OFF]
- When [Airplane Mode] was set to [ON] and the camera was turned off (→264)
- When the battery was removed

**Positioning can be executed faster when you download GPS assist data to the camera using the “GPS Assist Tool”. (→266)**

## ■ Information to be recorded on the pictures

When the camera successfully executes positioning, it records the following information in still pictures and motion pictures\*.

- Location information (latitude and longitude)
- Place name information (Country/region, province/state, city/borough/county, town/village, landmark)

\*Only the information determined at the time when the recording was started is recorded.

Additionally, it will be recorded to AVCHD motion pictures that have motion picture quality settings without the [G] in the motion picture icon. (→153)

- [GPS] (with location information) and/or [▶] (with place name information) is displayed during playback for pictures that are recorded with location or place name information.
- The location information and place name information are not recorded on pictures that are recorded when the positioning result icon [Ⓜ] is displayed.
- Only the location information will be recorded for pictures recorded immediately after positioning was executed successfully (until place name information appears). However, even if positioning failed during recording, location information may be recorded later once the position becomes available.
  - During playback, you can add the place name information to pictures recorded with only the location information.

## ■ Place name information

The place name displayed for place name information is determined by searching for place names and landmarks from the database of this camera based on the latitude and longitude of positioning. (In some cases, the nearest place name or landmark may not be displayed.)

- Nearby place names and landmarks may be displayed instead of your actual location depending on the detected position.
- [---] may be displayed even if positioning is executed successfully depending on the detected position. In some cases, you can select place name information by using [GPS Area Select]. (→263)
- There are also cases where the landmarks you are looking for may not be registered in the camera database. Place name information such as landmarks is current as of October 2012. (Type of landmarks (→326))

- Place name information (place name and landmark name) may be different from the official names in some cases.



Using the GPS function to record the location of a picture

### [Repositioning]

If the displayed place name is different from the current location or a previous location is displayed, update the positioning information.

**If some time has elapsed since the last time positioning was executed successfully ([GPS], [GPS], [GPS], or [GPS] is displayed), we recommend updating the positioning information.**

Before starting the procedure, move to a place where positioning can be performed successfully. (→257)

#### 1 Select [Repositioning] from [GPS] menu and press [MENU/SET]

The GPS status indicator lights up and the positioning reception icon appears on the screen while positioning is executed. (→259)



## ■ Interval between positioning operations



Even if the positioning information is not updated, the camera automatically tries to execute positioning immediately after it is turned on and subsequently at regular intervals when [GPS Setting] is [ON].

Also, when [Airplane Mode] is set to [OFF], the camera automatically tries to execute positioning, even if the camera is turned off.

Note, however, that the positioning operation is interrupted in the following cases:

- When the camera is turned off when the battery remaining indication is [  ] (one bar) or less.
- When the camera is turned off and the remaining battery power becomes significantly depleted.
- When the battery charging is started.
- When the camera has not been turned on for a certain period of time.

## ■ Displaying the GPS reception status

- ① Select [GPS Setting] from the [GPS] menu: Perform steps **1** and **2** (→258)
  - ② Use ▲ ▼ to select [INFO] and press [MENU/SET]
    - Press [MENU/SET] again to update the positioning information.
- Checking GPS reception status
    -  : Time when positioning is executed
    -  : Number of GPS satellites from which the camera has received signals
    -  : Latitude  
Longitude

**[GPS Area Select]**

When there are other candidate locations as a result of positioning, you can change the location information to another place name or landmark in the neighbourhood.

- When there is a choice for differing place name information,  appears in front of the place name information.

**1** Select **[GPS Area Select]** from **[GPS]** menu and press **[MENU/SET]**

**2** Use **▲ ▼** to select an item to be changed and press **[MENU/SET]**



**3** Use **▲ ▼** to select a place name or landmark from the displayed candidates and press **[MENU/SET]**

#### ■ If you do not want to record a place name or landmark

When you select **[Delete all place-names]** in step **2** above, the place names and landmarks are not recorded.

You can also select the level of the place name and landmark information to be excluded in step **3** above. All place names and landmarks that are below the selected level will be deleted from the recording. (For example, if you delete **[County/Township]**, the lower level **[City/Town/Village]** and **[Landmark]** data will not be recorded either.)

- Note, however, that the latitude and longitude data are recorded. If you do not want to record the latitude and longitude data, set **[GPS Setting]** to **[OFF]**.
- To restore the place names and landmarks that you set not to be recorded, perform the **[GPS Area Select]** procedure again.

- A landmark may not be displayed at all or a different landmark may be displayed in places such as a large park. If the landmark that you want cannot be selected using **[GPS Area Select]**, perform the **[My Landmark]** procedure ([→272](#)) before recording a picture or the **[Place-Name Edit]** procedure after recording a picture. ([→173](#))

Using the GPS function to record the location of a picture

### [Area Info. Set]

You can switch the display of place name information on the screen on or off.

- 1 Select **[Area Info. Set]** from **[GPS]** menu and press **[MENU/SET]**
- 2 Use **▲ ▼** to select an item to be changed and press **[MENU/SET]**



- 3 Use **▲ ▼** to set items that you want to display to **[ON]** and items that you do not want to display to **[OFF]** and press **[MENU/SET]**

### [Airplane Mode]

When **[GPS Setting]** is **[ON]**, the GPS function remains activated even if the camera is turned off.

To disable the positioning function when the camera is turned off, set **[Airplane Mode]** to **[ON]**.

- 1 Select **[Airplane Mode]** from **[Setup]** menu and press **[MENU/SET]**
- 2 Use **▲ ▼** to select **[ON]** and press **[MENU/SET]**

- Electromagnetic waves from the camera can affect instruments and meters. In airplane cabins (during takeoff and landing) or in other restricted areas, set **[Airplane Mode]** to **[ON]**, and then turn off the camera.

## Adjusting the time using GPS

You can automatically update the [Clock Set] of the camera using the date and time information contained in GPS radio signals. When you move to a different time zone from your home area and positioning is executed successfully, the camera automatically adjusts the time to the local time.

**Preparation:** Set [GPS Setting] to [ON]. (→258)

- 1** Select [Auto Clock Set] from [Setup] menu and press [MENU/SET]
- 2** Use ▲ ▼ to select [ON] and press [MENU/SET]
- 3** (for the first time only)  
When [Please set the home area] is displayed, press [MENU/SET]
- 4** Press ◀▶ to set your home area and press [MENU/SET]

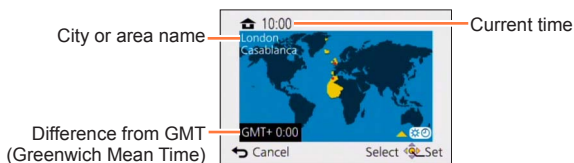

- If the positioning result indicates that the time zone of your current location is different from that of [Home], [World Time] is set to [Destination]. ([✈️]) will be displayed next to the time and date on the screen
- The date and time adjusted by [Auto Clock Set] are not as accurate as those of clock radios. If the date and time are not adjusted accurately, use [Clock Set] to re-adjust the date and time.

## Reducing the time required for positioning

You can reduce the time required for positioning by copying in advance the predicted satellite information (GPS assist data) of GPS satellites required for positioning to the camera.

- For downloading/updating GPS assist data, there is a method to use the “GPS Assist Tool” on a PC, and a method to use the Wi-Fi function.
- If the camera’s clock is not set, the GPS assist data cannot be used.

- The GPS assist data is valid for 30 days.
- The GPS assist data is updated once a day.
- The GPS assist data provider service may be changed or discontinued without prior notice. (The current service is provided as of January 2014.)

### Using the “GPS Assist Tool”

You can use the “GPS Assist Tool” to download the GPS assist data from the Internet and update the GPS assist data of the camera.

#### ■ Operating environment

You need a PC that can connect to the Internet.

<b>Supported OS</b>	Windows® 8.1 (32-bit/64-bit) Windows® 8 (32-bit/64-bit) Windows® 7 (32-bit, 64-bit) and SP1 Windows Vista® (32-bit) SP2 Windows® XP (32-bit) SP3 Mac® OS X v10.5, v10.6, v10.7, v10.8, and v10.9
---------------------	---

- You do not need to install the software on your computer.

- If the “GPS Assist Tool” cannot be used, download the GPS assist data from the support site and copy it to a memory card.  
To access the support site, double-click “GPSASIST.HTM”, which is displayed when the camera is connected to a computer or when the “GPS Assist Tool” is copied to a memory card.  
For detailed procedures, such as downloading the GPS assist data, read the information displayed on the support site.

## ■ Using “GPS Assist Tool” by connecting the camera and computer

### Preparation:

Turn on the computer and close all other open application programmes.

**1** Select [Assist Data] from [GPS] menu and press [MENU/SET]

**2** Use ▲ ▼ to select [Update] and press [MENU/SET]

**3** Use ▲ ▼ to select [Connect USB] and press [MENU/SET]

**4** Connect the camera to a computer

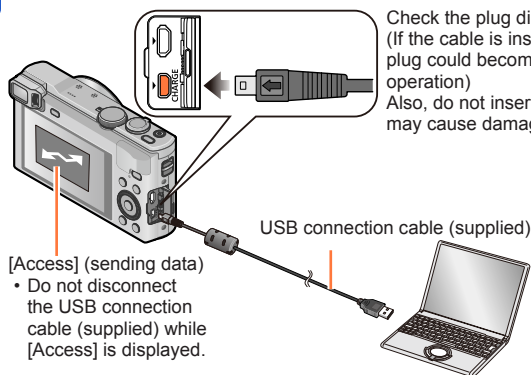

**5** Start up the “GPS Assist Tool” on your computer and update the GPS assist data (→269)

The GPS assist data of the camera is updated.

**6** Terminate the connection between the camera and computer and disconnect the USB connection cable (supplied)

- You can also update the assist data if you select [GPS assist data] for [USB Mode] (→72) when you connect the camera to a computer.
- Do not use any other USB connection cables except the supplied one or a genuine Panasonic USB connection cable (optional). Using cables other than the above may cause a malfunction.

**■ Using a card reader/writer (commercially available)****Preparation:**

- Turn on the computer that is connected to a card reader/writer (commercially available) and close all other open application programmes.
- Insert a memory card in the camera before starting the updating procedure.

**1** Select **[Assist Data]** from **[GPS]** menu and press **[MENU/SET]**

**2** Use **▲ ▼** to select **[Update]** and press **[MENU/SET]**

**3** Use **▲ ▼** to select **[SD card]** and press **[MENU/SET]**

The “GPS Assist Tool” is copied to a memory card.

**4** Turn off the camera and remove the memory card

**5** Insert the memory card into a card reader/writer (commercially available) connected to the computer

**6** Start up the “GPS Assist Tool” stored in the memory card on the computer and update the GPS assist data ([→269](#))

**7** Remove the memory card from the computer

**8** Insert the memory card into the camera and turn on the camera

The GPS assist data of the camera is updated.



## ■ Operating the “GPS Assist Tool”

### 1 Start up the “GPS Assist Tool” on the computer

- Windows:  
Double-click [GPSASIST.EXE] stored in the connected camera or memory card
- Mac:  
① Double-click [GPSASIST.DMG] stored in the connected camera or memory card  
② Double-click [GPSASIST]
- When the “GPS Assist Tool” is copied to the memory card, the execution file is stored in the [AD\_LUMIX] folder.

### 2 Operate the “GPS Assist Tool”

- ① Click [Update]
  - ② Click [Yes]
  - ③ Click [OK]
  - ④ Click [Exit]
- Do not terminate the connection between the camera/card and computer until the data is updated.

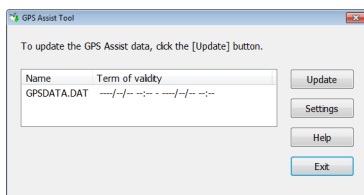

### 3 Terminate the connection between camera/card and computer

- Windows: Execute “Safely Remove Hardware” on the taskbar
- Mac: Open the Finder and click the eject icon that appears on the sidebar

## ■ Changing the proxy settings

Perform the proxy settings only if the GPS assist data cannot be updated successfully when the computer is connected to the Internet via proxy.

- ① Click [Settings]
- ② Perform the proxy settings
  - Windows: Enable [Use proxy server.] and change the settings.
  - Mac: Change the settings using the network settings screen of the displayed system environment settings screen.

## Using the Wi-Fi function to update

You can connect to a wireless access point that is hooked up to the Internet and update GPS assist data.

**1** Select **[Assist Data]** from **[GPS]** menu and press **[MENU/SET]**

**2** Use **▲ ▼** to select **[Update]** and press **[MENU/SET]**

**3** Use **▲ ▼** to select **[Wi-Fi]** and press **[MENU/SET]**

**4** Use **▲ ▼** to select the setting and press **[MENU/SET]**

[Charge and Update]	Update GPS assist data when this unit is charging while connected to a power outlet or PC.
[Update Now]	Immediately updates GPS assist data.
[Destination]	Change the connection destination.

- If Wi-Fi connection is not set, the Wi-Fi connection settings screen is displayed. For information on setting Wi-Fi connection. (→246)

● Connections for GPS assist data update that uses the Wi-Fi function will not remain in **[History Connection]** in the **[Wi-Fi]** menu. Also, it cannot be registered to **[Favorite Connection]**.

**Checking the expiration date of the GPS assist data**

The GPS assist data expires in 30 days. We recommend using new GPS assist data.

- 1** Select **[Assist Data]** from **[GPS]** menu and press **[MENU/SET]**
- 2** Use **▲ ▼** to select **[Expiry Date]** and press **[MENU/SET]**

- You can also check the expiration date on the screen when the “GPS Assist Tool” is started up on the computer.
- The starting date of the expiration period may be moved to an earlier time than the renewal date due to the update timing of GPS assist data or other factors.

## Registering my landmark

You can register a user-defined location that is not registered in this camera as my landmark in order to display it when positioning is executed or to record it on a picture. (Up to 50 landmarks)

First, move to the location that is to be registered, and operate the GPS where positioning can be executed.

**1** Select **[My Landmark]** from the **[GPS]** menu and press **[MENU/SET]**

**2** Use **▲ ▼** to select **[None]** and press **[MENU/SET]**

**3** Use **◀** to select **[Yes]** and press **[MENU/SET]**  
Positioning starts.

**4** After confirming the GPS information, press **[MENU/SET]**

- When positioning has failed  
→ Move to a location where positioning can be executed, then select **[Yes]** using cursor button and press **[MENU/SET]**.

**5** Input the landmark name (Entering text (→75))

### ■ Editing or deleting registered landmarks

- ① Select the landmark which was registered in step **2** above, and press **[MENU/SET]**
- ② Use **◀▶** to select the item and press **[MENU/SET]**

[Edit]	This corrects the landmark name.
[Delete]	This deletes the registered landmark.

## Using the GPS log

Location information positioned using GPS can be recorded as a "GPS log". An output of the GPS log file can be utilised on compatible websites, etc.

### Recording the GPS log

You can set the GPS log's recording interval or recording duration.

- GPS logs cannot be recorded to the built-in memory. Use a card.

**1** Select [GPS Log] from [GPS] menu and press [MENU/SET]

**2** Use ▲ ▼ to select [Log Record] and press [MENU/SET]

■ For the first time only (If [Auto Clock Set] and [World Time] are not set)

- ① When [Please set the home area] is displayed, press [MENU/SET]
- ② Press ◀▶ to set your home area and press [MENU/SET]

**3** Set recording interval and recording duration

[Recording interval]	<p>The GPS log is recorded at the set interval.</p> <p>■ <b>Settings:</b> [60SEC.] / [15SEC.]</p> <ul style="list-style-type: none"> <li>• Depending on the signal reception situation, the log recording intervals may be longer.</li> </ul>
[Recording duration]	<p>When the set time elapses, the GPS log automatically stops recording.</p> <p>■ <b>Settings:</b> [ENDLESS] (Does not set a time to stop logging.) / [24HRS] / [6HRS]</p>

**4** Use ▲ ▼ to select [Start] and press [MENU/SET]

"LOG" is displayed in the icon during positioning while recording logs.

### ■ Ending logging

Select [End] in step **3** and press [MENU/SET]

- In the following cases, GPS logging automatically ends:
  - When [GPS Setting] is set to [OFF]
  - When battery charging is started
- In the following cases, GPS logging will be aborted:
  - When the camera is turned off when the battery remaining indication is [] (one bar) or less
  - When the camera is turned off and the remaining battery power becomes significantly depleted
- The recorded GPS log is saved in the NMEA format.
  - You can convert to and output in the KML format. ([→275](#))
- A GPS log will be created only if positioning succeeds at least once during recording.

### Outputting the GPS log file

Convert GPS log files (NMEA format) to KML format and output to use it on a website, etc., that supports the KML format.

**1** Select [GPS Log] from [GPS] menu and press [MENU/SET]

**2** Use ▲ ▼ to select [KML File Output] and press [MENU/SET]

**3** Use ▲ ▼ to select the GPS log recording date and press [MENU/SET]

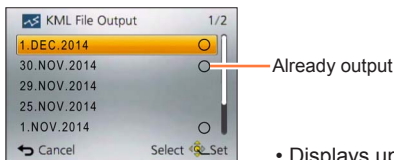

• Displays up to 1,000 items.

- The confirmation screen appears. Select [Yes] to perform output.
- If the time zones of the area set in [Home] under [World Time] and the area of the GPS information received by the camera are different, the time difference relative to GMT is displayed on the screen.

### ■ Save destination of the GPS log file

The log/output file is saved in the following folder on your card.

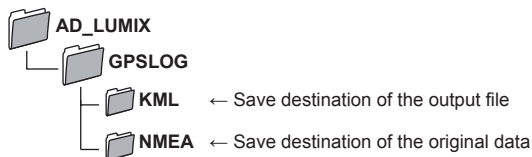

- The GPS log file may contain information that identifies the individual. When uploading data to a WEB service, please check carefully before uploading.
- For information on whether the file format this unit can output is compatible with a website, check the website's Q&A section.

## Deleting the GPS log

- 1** Select [GPS Log] from [GPS] menu and press [MENU/SET]
- 2** Use ▲ ▼ to select [Delete Log] and press [MENU/SET]
- 3** Use ▲ ▼ to select [1 DAY] / [ALL] and press [MENU/SET]
  - For [1 DAY]
    - Use ▲ ▼ to select the date and press [MENU/SET]
    - Displays up to 1,000 items.
  - The confirmation screen appears. Select [Yes] to delete.

● If there is an output KML file, it is simultaneously deleted.



## Viewing on TV screen

You can view pictures on a TV screen by connecting your camera to your TV with the HDMI micro cable or AV cable (optional).

- Also consult TV operating manual.

### Preparation:

- Set [TV Aspect] to connect your camera to a TV using the AV cable (optional) (→72).
- Turn off both camera and TV.

## 1 Connect camera to TV

### ■ To connect with an HDMI micro cable

An HDMI micro cable can be used to enable viewing of still and motion pictures in high resolution.

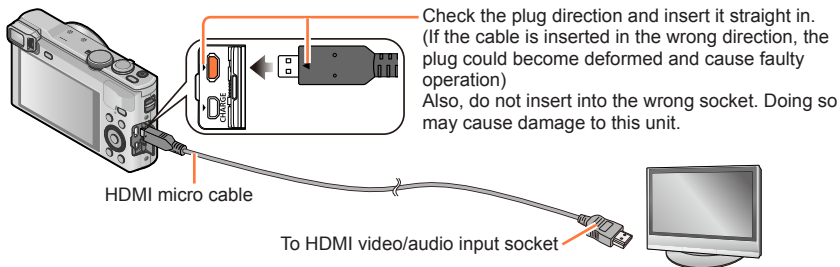

### ■ To connect with an AV cable (optional)

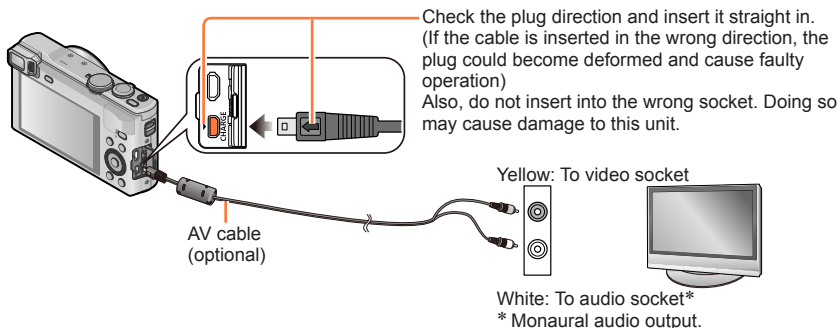

## 2 Turn on the TV and switch the TV input source to match the connection socket

## 3 Turn on the camera and press the playback button

- By holding down the Playback button while the camera is turned off, you can turn the camera on in Playback Mode.

**■ To connect with an HDMI micro cable**

- Use a "High Speed HDMI micro cable" with the HDMI logo. Cables that do not comply with the HDMI standards will not work.
- "High Speed HDMI micro cable" (Type D-Type A plug, up to 2 m (6.6 feet) long)
- Some of the playback functions cannot be performed.
- The following menus cannot be used: [Setup], [Playback], [GPS], and [Wi-Fi].
- Bars may appear at the sides or at the top and bottom of the screen, depending on the aspect ratio setting.
- Cables that do not comply with HDMI standards will not work.
- When an HDMI micro cable is connected, pictures are not displayed on the screen.
- HDMI output will be cancelled if a USB connection cable (supplied) is connected simultaneously.
- When the AV cable (optional) and HDMI micro cable are connected at the same time, no picture is output from the AV cable.
- Pictures may be momentarily distorted immediately after commencing playback or pausing on certain televisions.
- Audio output is stereo.

**■ To connect with an AV cable (optional)**

- Always use a genuine Panasonic AV cable (optional).
- You can play back pictures on TVs in other countries (regions) which use the NTSC or PAL system. You can find [Video Out] setting in [TV Connection] from the [Setup] menu.
- Pictures rotated to portrait may be blurred slightly.
- Change picture mode settings on TV if aspect ratios are not displayed correctly on widescreen or high-definition televisions.
- Viewfinder display cannot be used.

**When you insert a card into the SD card slot in a television or a DVD recorder, you can play back recorded still pictures.**

- AVCHD motion pictures can be played back on Panasonic televisions (VIERA) displaying the AVCHD logo.
- You may not be able to play back panorama pictures. Also you cannot perform automatic scrolling playback of panorama pictures.
- When using both SDHC and SDXC Memory Cards, be sure to play each type of card in equipment compatible with the particular format.

**VIERA Link (HDMI) (HDAVI Control™)****What is VIERA Link (HDMI)?**

- VIERA Link is a function that automatically links this camera to VIERA Link-compatible devices by connecting HDMI micro cables for enabling easy operation with the VIERA remote control. (Some operations are not available.)
- VIERA Link (HDMI) is an exclusive Panasonic function added to the industry-standard HDMI control functions known as HDMI CEC (Consumer Electronics Control). Operation is not guaranteed when connecting with non-Panasonic HDMI CEC-compatible devices. Refer to your product manual to verify compatibility with VIERA Link (HDMI).
- This camera supports VIERA Link (HDMI) Version 5. This is the Panasonic standard that also supports previous Panasonic VIERA Link devices.

- Use a "High Speed HDMI micro cable" with the HDMI logo. Cables that do not comply with the HDMI standards will not work.  
"High Speed HDMI micro cable" (Type D-Type A plug, up to 2 m (6.6 feet) long)
- If you do not know if your TV is VIERA Link (HDMI) compatible, see the TV's operating instructions.
- Cables that do not comply with HDMI standards will not work.
- If the [VIERA Link] setting on the camera is [ON], operations via the camera buttons will be limited.
- Ensure that the television you are connecting to has been set up to enable VIERA Link (HDMI) (consult your television operating instructions for details).

**Preparation:** Set [VIERA Link] to [ON] (→73).

- 1 Connect the camera to a VIERA Link (HDMI)-compatible Panasonic television (VIERA) with an HDMI micro cable (→277)**
- 2 Turn on the camera and press the playback button**
  - By holding down the Playback button while the camera is turned off, you can turn the camera on in Playback Mode.
- 3 Proceed with the operation while referring to what is displayed on the TV screen**
  - When operating, refer to the VIERA Link operating panel.

#### ■ Other related operations

- Turning the unit OFF
  - The camera can also be turned off when the television is turned off with the remote control.
- Automatic input select
  - This function automatically switches the television input to the camera screen whenever the camera is turned on while it is connected via the HDMI micro cable. The television can also be switched on via the camera from Standby Mode (if "Power on link" on the television is set to "on").
  - If VIERA Link (HDMI) does not function correctly (→313)

**Viewing 3D still pictures**

If you connect this camera to a 3D-capable TV, and play back still pictures that you recorded in 3D, you can enjoy impressive 3D still pictures on the TV. If a 3D-capable TV has an SD card slot, you can play back 3D still pictures that you recorded by inserting the card into the slot.

**Preparation:** Set [3D Playback] to [3D] (→72).

**1 Connect the camera to a 3D-capable TV by use of an HDMI micro cable to display the playback screen (→277)****2 Display still pictures recorded in 3D**

- When the [VIERA Link] setting on the camera is set to [ON] and the camera is connected to a VIERA Link (HDMI)-compatible Panasonic television (VIERA), the television automatically switches its input and the playback screen is displayed.
- [3D] appears on the thumbnail of the 3D still pictures.

**■ To perform Slide Show playback of only still pictures recorded in 3D**

Select [3D Play] in [Slide Show] of the [Playback Mode] menu (→164)

**■ To select and play back only still pictures recorded in 3D**

Select [3D Play] in [Filtering Play] of the [Playback Mode] menu (→160)

**■ To switch the playback method for the still pictures recorded in 3D**

- ① Select the picture recorded in 3D
- ② Select [2D/3D Settings] on the [Playback Mode] menu and then press [MENU/SET] (→159)

- Playback method will switch to 3D if it is playing back in 2D (conventional image), or it will switch to 2D if it is playing back in 3D.
- If you feel tired, uncomfortable or otherwise strange when playing back pictures recorded in 3D, set to 2D.

- Viewing 3D still pictures too close to a TV may cause eyestrain.
- When an image is not suitable for 3D viewing (due to excessive parallax, etc.):
  - During Slide Show playback: The image is displayed in 2D.
  - During [Filtering Play]: A message appears confirming whether to display the image in 3D or not.
- When a 3D image is played back on a TV that is not 3D-capable, 2 pictures may appear side-by-side on the screen.
- On the screen of this camera, 3D still pictures will be played back in 2D (conventional pictures).
- If you switch between 3D still pictures and normal still pictures while playing back pictures, a black screen will be displayed for a few seconds.
- If you select a thumbnail of 3D still pictures or display a thumbnail after playing back 3D still pictures, it may take a few seconds to start playing back or displaying the pictures.
- When a TV has not been converted for viewing 3D still pictures, do necessary preparation on the TV. (For details about the necessary preparation of the TV, read the manual for the TV.)
- During 3D playback, the [Wi-Fi] menu, [Setup] menu, [Playback] menu, [GPS] menu, Playback Zoom, and delete operation cannot be used.
- You can store 3D still pictures on a computer or Panasonic recorder. (→283, 284)

## Storing recorded still pictures and motion pictures in the recorder

Follow the correct method for your device.

### Copying by inserting the card into the recorder

You can copy pictures using Panasonic equipment (such as Blu-ray disc recorders) with support for each file format.

- See the instruction manual for the recorder for details for copying and playing back.

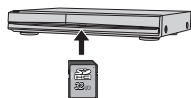

### Dubbing playback pictures via AV cables (optional)

Videos that are played on this camera can be dubbed on media such as a disc, hard disk or videotape using a device such as a video recorder. This method is useful as it allows dubbing to be performed even with devices that are not compatible with high definition images. Picture quality will be reduced from high definition to standard definition. Audio will be monaural.

#### 1 Connect camera to recorder

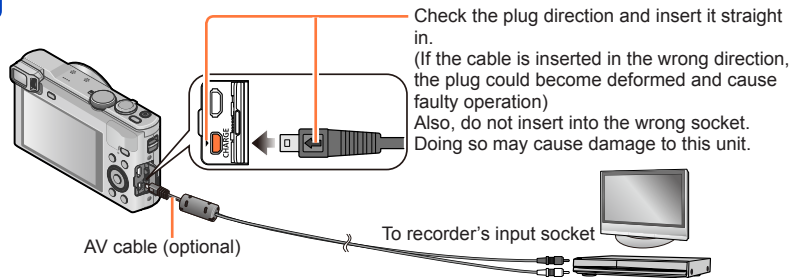

#### 2 Start playback on camera

#### 3 Start recording on recorder

- To stop recording (dubbing), stop the recording on your recorder first before stopping the playback on the camera.

- Always use a genuine Panasonic AV cable (optional).
- When using a TV with a 4:3 aspect ratio, always change the camera's [TV Aspect] setting (→72) to [4:3] before dubbing. Motion pictures copied in the [16:9] setting will appear vertically stretched when viewed on a 4:3 TV screen.
- For details on dubbing and playback methods, refer to your recorder's operating instructions.

## Storing recorded still pictures and motion pictures on your PC

Still/motion pictures can be copied from the camera to your computer by connecting the two together.

- Some computers can read directly from the camera's memory card.  
For details, see the instruction manual for your computer.
- If your computer does not support SDXC Memory Cards a message will be displayed requesting you to format the card. (Do not format the card. This will erase recorded pictures.) If the card is not recognised, refer to the following support website.  
<http://panasonic.net/avc/sdcard/information/SDXC.html>

### ■ Computer specifications

You can connect the camera to a computer that can detect a mass storage device (device that stores a large volume of data).

- Windows: Windows 8.1 / Windows 8 / Windows 7 / Windows Vista / Windows XP
- Mac: OS X v10.5 - v10.9

Some motion pictures recorded in [AVCHD] may not be scanned correctly by copying a file or folder.

- When using Windows, be sure to use the "PHOTOfunSTUDIO" software on the supplied CD-ROM to copy motion pictures recorded in [AVCHD].
- When using Mac, you can copy motion pictures recorded in [AVCHD] using "iMovie".  
Note, however, that it may not be possible to copy pictures depending on the picture quality settings.  
(For details about iMovie, please contact Apple Inc.)



### About supplied software

The supplied CD-ROM contains the following software.  
Install the software on your computer before using.

#### ■ PHOTOfunSTUDIO 9.3 PE

You can capture still pictures or motion pictures to your PC, or organise captured pictures by categorising by recording date, model name of the digital camera used to record, etc. You can also correct still pictures, edit motion pictures, or write to DVD.

#### • Operating environment

Supported OS	Windows® 8.1 (32-bit/64-bit) Windows® 8 (32-bit/64-bit) Windows® 7 (32-bit/64-bit) and SP1 Windows Vista® (32-bit) SP2 Windows® XP (32-bit) SP3	
CPU	Windows® 8.1	Pentium® III 1 GHz or higher
	Windows® 8	
	Windows® 7	
	Windows Vista®	Pentium® III 800 MHz or higher
	Windows® XP	Pentium® III 500 MHz or higher
Display	1024×768 pixels or more (1920×1080 pixels or more recommended)	
RAM	Windows® 8.1	1 GB or more (32-bit) / 2 GB or more (64-bit)
	Windows® 8	
	Windows® 7	
	Windows Vista®	512 MB or more
Windows® XP		
Free hard disk space	450 MB or more for installing software	

Refer to the Operating Instructions of "PHOTOfunSTUDIO" (PDF) for further information about the operating environment. You can read the Operating Instructions after launching the software.

Storing recorded still pictures and motion pictures on your PC

## ■ **LoiLoScope 30 day full trial version (Windows 8.1 / 8 / 7 / Vista / XP)**

LoiLoScope is a video editing software that draws out the full power of your PC. Creating videos is as easy as organising cards on top of a desk. Use your music, picture and video files to create videos to share with your friends and family by burning it to a DVD, uploading it to websites, or simply share your videos with your friends via e-mail.

- This will only install a shortcut to the trial version download site.

**For more information on how to use LoiLoScope, read the LoiLoScope manual available for download at the link below.**

**Manual URL: <http://loilo.tv/product/20>**

## Installing supplied software

The software compatible with your PC will be installed.

### Preparation:

- Check your PC's specifications and operating environment for each software.
- Before inserting the CD-ROM (supplied), close all running applications.

### **1** Insert the CD-ROM with the supplied software

### **2** When the install menu appears, click [Applications]

- If the automatic playback screen is displayed, you can display the menu by selecting and executing [Launcher.exe].
- In Windows 8.1/Windows 8, you can display the menu by clicking a message that is displayed after inserting the CD-ROM and then selecting and executing [Launcher.exe].
- You can also display the menu by opening [VFFXXXX] (the XXXX portion differs depending on the model) in [Computer] and double-clicking [Launcher.exe].

### **3** Click [Recommended Installation]

- Continue the installation procedure following the instructions displayed on the screen.

● PHOTOfunSTUDIO / LoiLoScope are not compatible with Mac.

Storing recorded still pictures and motion pictures on your PC

## Downloading SILKYPIX Developer Studio SE

This software develops and edits RAW file pictures. Edited pictures can be saved in a file format such as JPEG or TIFF that can be displayed on a PC, etc.

### ■ Download procedure

Download SILKYPIX Developer Studio SE from the following site and install it on your computer to use. (This software is not provided on the supplied CD-ROM.)

<http://www.isl.co.jp/SILKYPIX/english/p/>

### • Operating environment

<b>Supported OS</b>	Windows® 8.1 Windows® 8 Windows® 7 Windows Vista® Windows® XP Mac® OS X (10.5 - 10.9)
---------------------	--

- For details on how to use the SILKYPIX Developer Studio SE, refer to the “Help” or the Ichikawa Soft Laboratory’s support website.

- To download the software, the PC must be connected to the Internet.
- It may take time to download the software in some communication environments.

## Copying still pictures and motion pictures

### Preparation:

- When importing pictures from the built-in memory, remove any memory cards.
- Install "PHOTOfunSTUDIO" on your computer before starting the copying procedure. (→286)
- Turn on the camera and computer.

Check the plug direction and insert it straight in.  
(If the cable is inserted in the wrong direction, the plug could become deformed and cause faulty operation)  
Also, do not insert into the wrong socket. Doing so may cause damage to this unit.

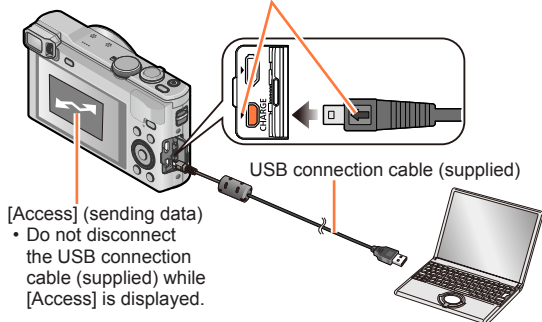

### 1 Connect camera to computer

- Do not use any other USB connection cables except the supplied one or a genuine Panasonic USB connection cable (optional). Using cables other than the above may cause a malfunction.

### 2 Use ▲ ▼ to select [PC] and press [MENU/SET]

- When [USB Mode] (→72) is set to [GPS assist data], the folder storing the pictures will not be displayed. Set [USB Mode] to [PC].

### 3 Use "PHOTOfunSTUDIO" to copy pictures to your computer

- For details on how to use "PHOTOfunSTUDIO", see the "PHOTOfunSTUDIO" manual (PDF).

- Files and folders containing copied AVCHD motion pictures cannot be played back or edited if they have been deleted, modified, or moved using Windows Explorer or similar methods. Always use "PHOTOfunSTUDIO" when handling AVCHD motion pictures.

### To cancel connection

- Windows: Execute "Safely Remove Hardware" on the taskbar
- Mac: Open the Finder and click the eject icon that appears on the sidebar

## ■ Copying to your computer without using “PHOTOfunSTUDIO” (except AVCHD motion pictures)

You can save pictures to use on your computer by dragging and dropping folders and files into separate folders on your computer.

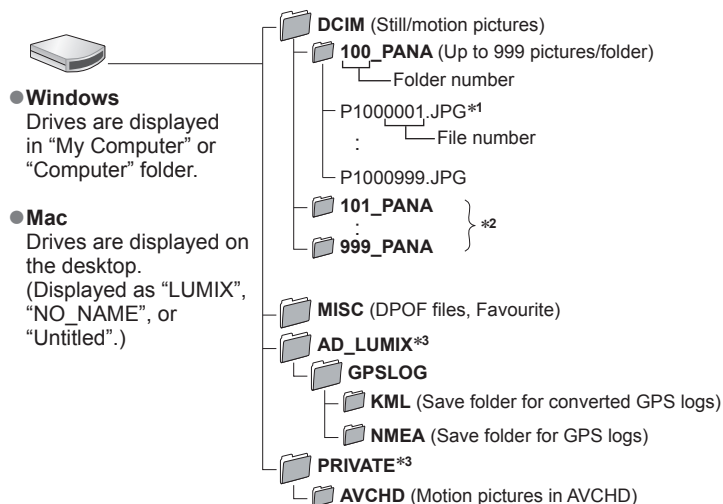

\*1 .JPG: Still pictures

- .RW2: Still pictures recorded in RAW file
- .MP4: [MP4] Motion Pictures / [High Speed Video]
- .MPO: 3D still pictures

\*2 New folders are created in the following cases:

- When there is a picture with file number 999 inside the folder.
- When using cards already containing the same folder number (for example, pictures taken with other cameras, etc.).
- When recording after performing [No.Reset].

\*3 This folder is not created in the built-in memory.

- Turn off the camera before inserting or removing memory cards.
- When the battery begins to run out during communication, a warning beep sounds. Cancel communication via your computer immediately.
- Setting the [USB Mode] to [PC] removes the need to make the setting each time the camera is connected to the computer.
- For more details, consult your computer operating manual.

### ■ For PTP mode

The camera can be connected to your computer even if [USB Mode] (→72) is set to [PictBridge(PTP)].

- Only picture output can be performed.
- If you cannot connect to your PC in PTP mode, set [USB Mode] to [PC] and reconnect.
- It may not be possible to import if there are 1000 or more pictures on the card.
- Motion pictures, 3D still pictures or RAW pictures cannot be read.

## Printing

You can connect directly to a PictBridge-compatible printer for printing.

- Some printers can print directly from the camera's memory card.  
For details, see the manual for your printer.

### Preparation:

- When printing pictures from the built-in memory, remove any memory cards.
- Adjust the print quality or other settings on your printer, as needed.
- Turn on the camera and printer.

Check the plug direction and insert it straight in.  
(If the cable is inserted in the wrong direction, the plug could become deformed and cause faulty operation)  
Also, do not insert into the wrong socket. Doing so may cause damage to this unit.

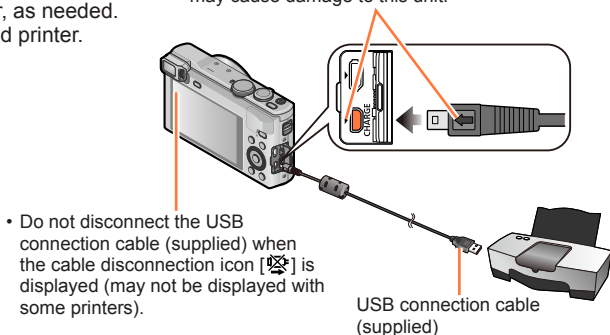

### 1 Connect camera to printer

- Do not use any other USB connection cables except the supplied one or a genuine Panasonic USB connection cable (optional).  
Using cables other than the above may cause a malfunction.

### 2 Use ▲ ▼ to select [PictBridge(PTP)] and press [MENU/SET]

### 3 Use ◀ ▶ to select a picture and press [MENU/SET]

### 4 Use ▲ to select [Print start] and press [MENU/SET] (Print settings (→294))

### ■ To cancel print

Press [MENU/SET].

- Turn off the camera before inserting or removing memory cards.
- Disconnect USB connection cable (supplied) after printing.
- When the battery begins to run out during communication, a warning beep sounds. Cancel printing and disconnect USB connection cable (supplied).
- Still pictures recorded in a RAW file cannot be printed. (The still pictures recorded in JPEG file format at the same time as the RAW file can be printed.)
- Motion pictures cannot be printed.



### Printing multiple pictures

Multiple pictures are printed at one time.

**1** Press **▲** to select **[Multi Print]** in step **3** (→291)

**2** Use **▲ ▼** to select the item and press **[MENU/SET]**

- **[Multi Select]:**
  - ① Scroll between pictures with cursor button, select pictures to print with the **[DISP.]** button. (Press **[DISP.]** button again to release selection.)
  - ② Press **[MENU/SET]** when selection is complete.
- **[Select All]:** Print all pictures.
- **[Print Set (DPOF)]:** Print pictures selected in **[Print Set]**. (→181)
- **[Favorite]:** Print pictures selected as **[Favorite]**. (→180)

**3** Use **▲** to select **[Print start]** and press **[MENU/SET]**

(Print settings (→294))

- Select **[Yes]** if print confirmation screen is displayed.

- An orange “•” displayed during printing indicates an error message.
- Print may be divided into several pictures if printing a large amount of pictures. (Remaining sheets display may differ from the number of pictures set for printing.)

### Printing with date and text

#### ■ Printing date without **[Text Stamp]**

Printing in store:

Only recording date can be printed. Request date printing in store.

- Making **[Print Set]** (→181) settings on the camera in advance allows settings for numbers of copies and date printing to be designated before giving the card to the store.
- When printing still pictures of 16:9 Aspect Ratio, check in advance that the store can accept this size.

Using computer:

Print settings for recording date and text information can be made using “PHOTOfunSTUDIO” software on the supplied CD-ROM.

Using printer:







Recording date can be printed by setting **[Print Set]** on the camera, or by setting **[Print with Date]** (→294) to **[ON]** when connecting to a printer compatible with date printing.

- Time and date can be set to be printed on the picture when taking the picture by activating the **[Date Stamp]** function in the **[Rec]** menu. (→151)



### Making print settings on the camera

Setting options include the number of printed pictures and their size. Make settings before selecting [Print start].

#### 1 Use ▲ ▼ to select the item and press [MENU/SET]

Item	Settings
[Print with Date]	[ON] / [OFF]
[Num.of prints]	Set number of pictures (up to 999 pictures)
[Paper Size]	When  is selected, the printer settings take priority.
[Page Layout]	 (printer takes priority) /  (1 picture, no border) /  (1 picture, with border) /  (2 pictures) /  (4 pictures)

#### 2 Use ▲ ▼ to select the setting and press [MENU/SET]

- When setting [Print with Date] to [ON], check the date printing settings on the printer (printer settings may be prioritised).
- To print a picture on which text or a date has been stamped, set [Print with Date] to [OFF]. (The still picture is printed with the date superimposed on it.)
- Items may not be displayed if incompatible with printer.
- To arrange  "2 pictures" or  "4 pictures" in the same still picture, set the number of prints for the still picture to 2 or 4.
- To print to paper sizes/layouts not supported by this camera, set to  and make settings on the printer. (Consult your printer's operating manual.)
- Even with completed [Print Set] settings, dates may not be printed, depending on the shop or printer used.

## List of LCD monitor/Viewfinder displays

Screens shown here are only examples. The actual display may vary.

### In recording

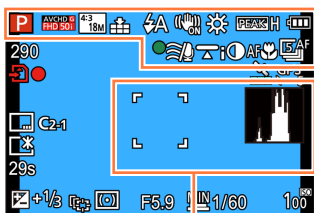

AF area ([→47](#))



Histogram ([→67](#))

	Recording Mode ( <a href="#">→30</a> )
	Backlight Compensation ( <a href="#">→36, 39, 150</a> )
	Rec Format ( <a href="#">→152</a> ) Rec Quality ( <a href="#">→152</a> )
	Aspect Ratio ( <a href="#">→140</a> ) Picture Size ( <a href="#">→140</a> )
	Quality ( <a href="#">→141</a> )
	Flash Mode ( <a href="#">→85</a> )
	Stabiliser ( <a href="#">→44, 150</a> )
	Motion Deblur ( <a href="#">→38</a> )
	Jitter alert ( <a href="#">→44</a> )
	White Balance ( <a href="#">→144</a> )
	Creative control adjustment display ( <a href="#">→111</a> )
	Peaking ( <a href="#">→68, 98</a> )
	Remaining battery ( <a href="#">→22</a> )
	Focus ( <a href="#">→47</a> )
	Zoom Microphone ( <a href="#">→155</a> )
	Wind cut ( <a href="#">→155</a> )
	Level Shot function ( <a href="#">→154</a> )
	Intelligent exposure ( <a href="#">→147</a> )
	AF macro ( <a href="#">→93</a> )
	Macro zoom ( <a href="#">→95</a> )
	Manual Focus ( <a href="#">→96</a> )
	AF Lock ( <a href="#">→99</a> )
	Colouring ( <a href="#">→42</a> )
	Burst Mode ( <a href="#">→102</a> )
	Auto Bracket ( <a href="#">→101</a> )
	Self-timer ( <a href="#">→105</a> )

## List of LCD monitor/Viewfinder displays



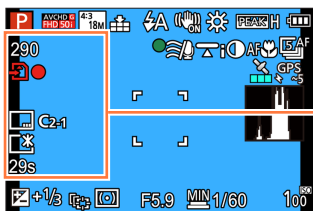

	Brightness (→42, 111, 119) Exposure Compensation (→100)
	Manual Exposure Assistance (→109)
	AF Tracking (→40, 90)
	AF Assist Lamp (→149)
	Metering Mode (→147)
	AEL AE Lock (→99)
	Defocus background condition (→37, 42, 111)
	Programme Shift (→45)
	F5.9 Aperture value (→44, 106, 108)
	MIN Minimum shutter speed (→148)
	1/60 Shutter speed (→44, 107, 108)
	100 ISO Sensitivity (→142)
	ISO MAX 400 ISO Limit Set (→143)



	290 Number of recordable pictures (→26)
	R29m59s Remaining recording time* (→48)
	Recording state
	IN Save destination (→25)
	Wi-Fi connection status
	Date Stamp (→151)
	C2-1 Custom Set (→131)
	Monitor Luminance (→66)
	ECO Monitor Power Save (→69)
	29s Elapsed recording time* (→48)

\* XXmXXs, RXXmXXs  
[m] and [s] indicate "minute" and "second".

## List of LCD monitor/Viewfinder displays

	GPS reception icon (→259)
	Updating GPS positioning (→259)

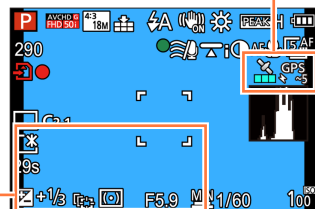

Place name information (→260)

 Changing the GPS place name (→263)

Destination settings (→138)

Travel elapsed days (→138)

Name (→127, 136)

Age in years/months (→127, 136)

Current date/time

World time (→139)

Focus range (→94)

Zoom (→80)

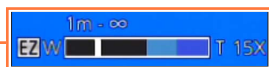

Screens shown here are only examples. The actual display may vary.

### In playback

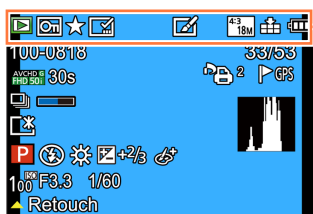

	Playback Mode (→159)
	Protected picture (→182)
	Favourites (→180)
	Date/text stamped display (→151, 174)
	Retouched picture (→167, 168)
	Aspect Ratio (→140) Picture Size (→140)
	Quality (→141)
	Remaining battery (→22)

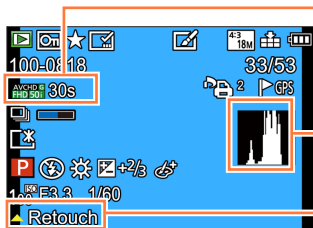

	Rec Format (→152) Rec Quality (→152)
	Motion picture recording time* (→56)
	Burst (→157)
	Histogram (→67)
	Retouch (→167)
	Motion picture playback (→56)
	Panorama playback (→122)
	Burst playback (→157)

\* XXmXXs  
[m] and [s] indicate "minute" and "second".



## Message displays

The following explains the meaning of major messages displayed on the LCD monitor or viewfinder, and how to respond to them.

### [This memory card cannot be used]

- Not compatible with the camera. Use a compatible card.

### [Some pictures cannot be deleted] [This picture cannot be deleted]

- Non-DCF pictures (→52) cannot be deleted.  
→ Save needed data on a computer or other device, and then use [Format] on the camera. (→74)

### [No additional selections can be made]

- The number of pictures that can be deleted at once has been exceeded.
- More than 999 pictures have been set as [Favorite].
- The number of pictures allowing [Title Edit], [Text Stamp] or [Resize] (multiple settings) at once has been exceeded.

### [Cannot be set on this picture]

- [Print Set], [Title Edit], or [Text Stamp] cannot be made for non-DCF pictures (→52).

### [Please turn camera off and then on again] [System Error]

- The lens is not working correctly.  
→ Turn the camera on again.  
(Consult the dealer or your nearest Service Centre if display still remains)

### [Some pictures cannot be copied] [Copy could not be completed]

- Pictures cannot be copied in following cases:  
→ Picture of same name already exists in built-in memory when copying from card.  
→ File is not of DCF standard (→52).  
→ Picture taken or edited on a different device.

### [Not enough space on built-in memory] [Not enough memory on the card]

- There is no space left on the built-in memory or the card. When you copy pictures from the built-in memory to the card (batch copy), the pictures are copied until the capacity of the card becomes full.

### [Memory card error. This card cannot be used in this camera. Format this card?]

- The card format cannot be used with this camera.  
→ Save needed data on a computer or other device, and then use [Format] on the camera. (→74)

### [Built-In Memory Error] [Format built-in memory?]

- Displayed when formatting built-in memory via computer, etc.  
→ Reformat directly using camera. Data will be deleted. (→74)

### [Insert SD card again] [Try another card]

- Access to card has failed.  
→ Insert card again.
- Try with a different card.



**[Read Error] / [Write Error] [Please check the card]**

- Data read has failed.  
→ Check whether card has been inserted correctly (→24).
- Data write has failed.  
→ Turn off the camera and remove the card. Reinsert the card and turn the camera on again.
- Card may possibly be damaged.  
→ Try with a different card.

**[Cannot record due to incompatible format(NTSC/PAL) data on this card.]**

- Format the card after saving necessary data on a PC etc. (→74)  
→ Insert a different card.

**[Motion recording was cancelled due to the limitation of the writing speed of the card]**

- Motion picture recording may be automatically terminated with certain cards.  
→ If recording stops even when using a card of the recommended speed class (→25), the data writing speed has dropped. If this happens, we recommend backing up the data on the memory card and formatting it (→74).

**[A folder cannot be created]**

- Folder numbers in use have reached 999.  
→ Save needed data on a computer or other device, and then use [Format] on the camera (→74).  
Folder number is reset to 100 when performing [No.Reset] (→71).

**[Picture is displayed for 16:9 TV] [Picture is displayed for 4:3 TV]**

- AV cable (optional) is connected to camera.  
→ To remove message immediately → Press [MENU/SET].  
→ To change aspect ratio → Change [TV Aspect] (→72).
- USB connection cable (supplied) is only connected to camera.  
→ Message disappears when cable is also connected to another device.

**[This battery cannot be used]**

- Use a genuine Panasonic battery.
- Battery cannot be recognised as terminal is dirty.  
→ Wipe any dirt away from the battery terminal.

**[GPS feature is not available in this region.]**

- GPS may not work in China or in the border regions of countries neighbouring China. (Current as of January 2014)

**[Recording failed.]**

- Recording may be impossible if the recording location for a 3D image is too dark/too bright, or if the subject lacks contrast.

**[Failed to connect wireless access point] / [Connection failed] / [No destination found]**

- Check following regarding the wireless access point.
  - The wireless access point information set on this unit is wrong. Check the authentication type, encryption type, and encryption key. (→248)
  - Power of the wireless access point is not turned on.
  - Setting of the wireless access point is not supported by this unit.
- Check the network setting of the destination.
- Radio waves from other devices may block the connection to a wireless access point.
  - Check other devices that are connected to the wireless access point and devices that use the 2.4 GHz band.

**[No picture to send]**

- This is displayed when there is no image to transmit due to the restriction of the destination. Check the file type of the image to transmit. (→202, 209, 211, 216, 222, 227)

**[Connection failed. Please retry in a few minutes.] / [Network disconnected. Transfer stopped.]**

- Radio waves from the wireless access point are getting weak.
  - Perform the connection closer to the wireless access point.
- There is no reply from the server or it has exceeded the communication processing time.
  - Try again after a while.
- Depending on the wireless access point, connection may be automatically disconnected after specific time has passed.
  - Reconnect the connection again.

**[Upload to the Cloud Folder is available after Cloud Sync settings have been set up on downloadable devices such as PCs or smartphones.]**

- Devices that download images from a cloud folder are not registered.
- Perform Cloud Sync setting. Configure the settings on a PC with "PHOTOfunSTUDIO" or on a smartphone with "Image App". For details on [Cloud Sync. Service], refer to (→227).

**[Connection failed]**

- Check following regarding the smartphones you intend to connect.
  - The smartphone does not operate.
  - Change the access point to connect to in the smartphone Wi-Fi settings to this camera.
  - There is no free storage space on the smartphone.

**[Login failed. Please check Login ID and Password.]**

- Login ID or password for the "LUMIX CLUB" is not correct. Please enter it again. If you have forgotten the login ID or the password, there is information in the login screen of the "LUMIX CLUB" website.

**[Some files cannot be sent because of destination limit] / [Transfer completed. Some files are left because of destination limit.]**

- Check the file format of the image to send.
- Sending motion pictures may fail if the file size is too large. Split the motion picture using [Video Divide]. (→176)

**[Unavailable. Please set Login settings on LUMIX CLUB web site.]**

- Login to the "LUMIX CLUB" from your smartphone or PC, and set the login details of the destination WEB service.

**[Both picture and video sharing service cannot be selected together]**

- WEB services designed only for pictures, and WEB services designed only for motion pictures cannot be selected at the same time. Deselect one of the services.

**[Cannot get IP address. Please set wireless AP's IP address setting to DHCP.]**

- Turn on DHCP settings of the IP address of the connected wireless access points.

**[Cannot connect to server]**

- If a message is displaying asking to update the root certificate, agree to update the root certificate.

## Q&A Troubleshooting

① Try checking these items (→304 - 315) first.

If the problem persists,

- ② Performing [Reset] in the [Setup] menu may resolve the issue (→71). (Note that except for some items such as [Clock Set], all settings are returned to their values at the time of purchase.)
- ③ Also, see the Panasonic support site for the latest support information.  
<http://panasonic.jp/support/global/cs/dsc/>  
 (This site is available in English only.)

## Battery, power

### The charging lamp is flashing.

- Charging is being performed in a place with extremely high or low temperature.  
 → Reconnect the USB connection cable (supplied) and retry charging in a place where ambient temperature is 10 °C to 30 °C (50 °F to 86 °F) (temperature conditions also apply to the battery itself).
- Charging is not possible if the power supply capacity of the computer is low.

### The charging lamp turns on again after it had turned off.

- The battery is being recharged.  
 → If the battery charge level is low when the camera is turned off and [GPS Setting] is set to [ON], battery recharging may be started automatically.

### Camera does not work even if the camera is turned on.

- Battery is not inserted correctly (→18), or needs recharging.

### Camera switches off as soon as the camera is turned on.

- Battery needs recharging.

### This unit is turned off automatically.

- If you connect to a TV compatible with VIERA Link (HDMI) with an HDMI micro cable and turn off the TV with the remote control for the TV, this unit also turns off.  
 → If you are not using VIERA Link (HDMI), set [VIERA Link] to [OFF]. (→73)

## GPS

### Cannot perform positioning.

- When [GPS Setting] is set to [OFF]. (→258)
- Depending on the recording environment, such as when indoors or near buildings, it may not be possible to correctly receive the signals from the GPS satellites. (→257)
  - When using the GPS, we recommend holding the camera still for a while with the GPS antenna facing upward in an outdoor location where you can see the entire sky.

### The GPS status indicator lights up while the camera is turned off.

- [GPS Setting] is [ON].
  - Electromagnetic waves from the camera can affect instruments and meters. In airplane cabins (during takeoff and landing) or in other restricted areas, set [Airplane Mode] to [ON], and then turn off the camera. (→264)

### Positioning takes time.

- When using the camera for the first time or after not using it for a while, positioning may take several minutes.
- Positioning usually takes less than two minutes, but because the positions of the GPS satellites change, it may take longer depending on the recording location and environment.
  - Positioning can be executed faster when you download GPS assist data to the camera using the "GPS Assist Tool". (→266)
- Positioning will take time in environments where it is difficult to receive the signals from the GPS satellites. (→257)

### The location name information is different from the recording location.

- Immediately after the camera is turned on or when the GPS icon is something other than [GPS], the location name information that is recorded in the camera may vary significantly from the current position.
- When [GPS] is displayed for the location name information, the information can be changed to a different candidate before starting to record. (→263)
  - You can edit a place name or landmark name recorded in a picture. (→173)

### The location name information is not displayed.

- "- -" is displayed if there is no nearby landmark or other points, or no information registered in the camera's database. (→260)
  - During playback, a location name or other information can be entered with [Place-Name Edit]. (→173)

## Recording

### Cannot record pictures.

- Built-in memory/card is full.  
→ Free space by deleting unwanted pictures (→58).

### Recorded pictures look white.

- Lens is dirty (fingerprints, etc.).  
→ Turn the camera on to extract lens barrel, and clean lens surface with a soft, dry cloth.
- Lens is foggy (→8).

### Recorded pictures are too bright/too dark.

- Adjust the exposure (→100).
- [Min. Shtr Speed] is set to fast speed. Check the setting (→148).

### The lower right portion of recorded pictures appears dark or the colour is unnatural.

- Your finger is blocking the flash.  
→ Make sure you are holding the camera correctly. (→31)

### Some pictures are taken when I press the shutter button just once.

- Camera is set to use [Auto Bracket] or [Burst].  
→ Clear the setting. (→101, 103)

### Focus not aligned correctly.

- Not set to mode appropriate for distance to subject. (Focus range varies according to Recording Mode.)
- Subject outside of focus range. (→94)
- Caused by jitter or subject movement. (→44)

### Recorded pictures are blurred. The stabiliser function ineffective.

- Shutter speed is slower in dark locations and the stabiliser function is less effective.  
→ Hold camera firmly with both hands, keeping arms close to body.
- Use a tripod and the self-timer (→105) when using slower shutter speed with [Min. Shtr Speed].

### Cannot use [Auto Bracket].

- Only enough memory for 2 pictures or fewer.

### Recorded pictures appear coarse, or there is interference.

- ISO Sensitivity is high, or shutter speed is low.  
(Default [Sensitivity] setting is [AUTO] – interference may appear with indoor pictures.)  
→ Lower [Sensitivity] (→142).  
→ Take pictures in brighter locations.
- Camera set to [High Sens.] Scene mode.  
(Picture becomes slightly coarser in response to high sensitivity)

### Striping or flicker may appear under lighting such as fluorescent lighting and LED lighting fixture.

- This is characteristic of MOS sensors which serve as the camera's pickup sensors.  
This is not a malfunction.



**Recording (continued)****Brightness or colouring of recorded picture different from real life.**

- When recording under fluorescent or LED lighting fixture etc., increasing the shutter speed may introduce slight changes to brightness and colour. These are a result of the characteristics of the light source and do not indicate a malfunction.
- When recording subjects in extremely bright locations or recording under fluorescent lighting, LED lighting fixture, mercury lamp, sodium lighting etc., the colours and screen brightness may change or horizontal striping may appear on the screen.

**Reddish horizontal streaks appear on the screen during recording.**

- This is characteristic of the MOS sensors, which serve as the camera's pickup sensors. The streaks appear when the subject has a bright part. Some unevenness may occur in the surrounding areas, but this is not a malfunction. It is recorded in motion pictures but is not recorded on still pictures.
- It is recommended that you take pictures while taking care not to expose the screen to sunlight or any other source of strong light.

**Motion picture recording stops midway.**

- If the surrounding temperature is high, or a motion picture is recorded continuously, [] is displayed and recording may be stopped halfway through to protect the camera.
- With some cards, access display may appear briefly after recording, and recording may end midway.
- Use a card of SD Speed "Class 4" or higher. If recording stops even when using a card of the recommended speed class, the data writing speed has dropped. If this happens, we recommend backing up the data on the memory card and formatting it ([→74](#)).

**Panorama picture recording stops before finishing.**

- If the pan motion of the camera is too slow, the camera assumes that the operation has been aborted and stops recording.
- If the pan motion of the camera is too shaky when it is moved toward the recording direction, the camera stops recording.  
→ To record panorama pictures, pan the camera in a small circular motion parallel to the recording direction at a speed of approx. 8 seconds per revolution (guideline).

**The subject cannot be locked. (AF track fails)**

- If the colour of the subject is similar to that of its background, AF Tracking may not function. Set the AF lock to the colours specific to the subject.

## LCD monitor/Viewfinder

### Pictures do not show on the LCD monitor.

- The camera is set for viewfinder display.  
→ Press [LVF] button and switch to LCD monitor display.

### Brightness is unstable.

- Aperture value is set while shutter button is pressed halfway. (Does not affect recorded picture.)  
This symptom may also occur when the brightness changes because the zoom is operated or the camera is moved. This is the automatic aperture operation of the camera and is not a malfunction.

### The screen flickers indoors.

- The screen may flicker for a few seconds after turning on. This is an operation to correct flicker caused by lighting such as fluorescent lights, LED lights, etc. and is not a malfunction.

### The screen is too bright/too dark.

- [Monitor Luminance] is activated. (→66)
- Use [Monitor Display]/[Viewfinder] to adjust the brightness of the screen. (→65)

### Black/blue/red/green dots or interference appears. LCD monitor looks distorted when touched.

- This is not a fault, and will not be recorded on the actual pictures.

### Cannot switch between the LCD monitor and viewfinder when pressing [LVF] button.

- When it is connected to a computer or printer, the camera can display pictures on the LCD monitor only.

## Flash

### No flash emitted.

- Flash set to [🚫] ([Forced Flash Off]) (→85).
- The flash becomes unavailable in the following cases :
  - [Auto Bracket]
  - [Burst] (Excluding [🔥]) ([Flash Burst])
  - Scene Modes ([Scenery], [Night Scenery], [Handheld Night Shot], [HDR], [Sunset], [Starry Sky], [Glass Through], [High Speed Video], [3D Photo Mode])
  - [Creative Control] Mode
  - [Panorama Shot] Mode

### Multiple flashes are emitted.

- Red-eye reduction is active (→85). (Flashes twice to prevent eyes appearing red.)
- [Burst] is set to [🔥] ([Flash Burst]).



## Playback

### Pictures have been rotated.

- [Rotate Disp.] is activated. (→73)

### Cannot view pictures. There are no recorded pictures.

- No pictures in built-in memory or card (pictures played from card if inserted, from built-in memory if not).
- Has the file name of the picture been changed on a computer? If so, it cannot be played back on the camera.
- During [Filtering Play], only pictures under the set filters are displayed.  
→ Cancel filtering (→160).

### Folder/file number displayed as [-]. Picture is black.

- Picture edited on computer or taken with different device.
- Battery removed immediately after picture taken, or picture taken with low battery.  
→ Use [Format] to delete (→74).

### Picture display takes a lot of time during Multi Playback.

- When you have many pictures that were edited with [Resize], [Retouch], etc., it may take several minutes for all pictures to be displayed during Multi Playback.

### Incorrect date displayed in Calendar Search.

- Picture edited on computer or taken with different device.
- [Clock Set] is incorrect (→29).  
(Incorrect date may be displayed in Calendar Search on pictures copied to a computer and then back to this unit, if computer and camera dates differ.)

### White round spots like soap bubbles appear on the recorded picture.

- If you take a picture with the flash in a dark place or indoors, white round spots may appear on the picture caused by the flash reflecting particles of dust in the air. This is not a fault. A characteristic of this is that the number of round spots and their position differ in every picture.



### [Thumbnail is displayed] is shown on the screen.

- The pictures may have been recorded on another device. If so, they may be displayed with poor picture quality.

### Red areas in pictures appear blackened.

- When digital red-eye correction ([A], [S]) is operating, if a subject is recorded that has skin-coloured areas with red areas inside, the digital red-eye correction function may blacken the red areas.  
→ We recommend setting the flash to [A], [S] or [Red-Eye Removal] to [OFF] before recording.

### Sounds of camera operations such as zoom will be recorded in motion pictures.

- Camera operation sounds may be recorded as camera automatically adjusts lens aperture during motion picture recording; this is not a fault.

### Motion pictures taken with this camera cannot be played in other cameras.

- Even if a device is compatible with AVCHD and MP4, the motion pictures that were recorded on this unit may have bad picture quality or sound quality upon playback, or may be unable to be played back. Also, the recording information may not be displayed correctly.

## About the Wi-Fi function

### It cannot connect to the wireless LAN. Radio waves get disconnected.

- Use within the communication range of the wireless LAN network.
- Connection types and security setting methods are different depending on the wireless access point.
  - Refer to the operating instructions of the wireless access point.
- When the radio waves are interrupted, the condition may improve by moving the location or changing the angle of the wireless access point.
- It may not automatically connect when the network SSID of the wireless access point is set not to broadcast.
  - Set the network SSID of the wireless access point to broadcast.
- Is any device, such as microwave oven, cordless phone, etc., that uses 2.4 GHz frequency operated nearby?
  - Radio waves may get interrupted when used simultaneously. Use them sufficiently away from the device.
- Is the 5 GHz/2.4 GHz switchable wireless access point connected to other equipment using the 5 GHz band?
  - The use of a wireless access point that can use 5 GHz/2.4 GHz simultaneously is recommended. It cannot be used simultaneously with this camera if it is not compatible.
- When the battery indicator is flashing red, the connection with other equipment may not start or the connection may be disrupted. (A message such as [Communication error] is displayed.)

### Wireless access point is not displayed. Or it cannot be connected.

- Check if the wireless access point to connect is in operating state.
- The camera may not display or connect to a wireless access point depending on the radio wave condition.
  - Perform the connection closer to the wireless access point.
- It may not display even if the radio waves exist depending on the setting of the wireless access point.
  - Check the settings of the wireless access point.
- The wireless access point may not be found depending on the radio wave condition.
  - Perform the [From List]. (→247)
- Is the network SSID of the wireless access point set not to broadcast?
  - It may not be detected when it is set not to broadcast. Enter and set the network SSID. (→248)
- Try the following:
  - Move this unit closer to the wireless access point
  - Remove the obstacles between this unit and the wireless access point
  - Change the direction of this unit

### It takes long time every time to connect to a smartphone.

- It may take longer time to connect depending on the Wi-Fi connection setting of the smartphone, but it is not a malfunction.

### This unit is not displayed in the Wi-Fi setting screen of the smartphone. It takes time to setup the connection.

- Try switching the ON/OFF of the Wi-Fi function in the Wi-Fi settings of the smartphone.

### I have forgotten the login ID or password for the "LUMIX CLUB".

- Check the information in the login screen of "LUMIX CLUB".
  - <http://lumixclub.panasonic.net/eng/c/>

### I do not have a wireless access point at my home, but I would like to perform service user registration of the "LUMIX CLUB".

- Service user registration for the "LUMIX CLUB" is not possible in the environment without a wireless access point.

### About the Wi-Fi function (continued)

#### The camera cannot be connected to Mac computer/Windows PC via Wi-Fi connection.

- Please confirm login name and password are correctly typed.
- When the system time of Mac computer or Windows PC connected to a camera differs severely from that of the camera, the camera cannot be connected to the computer or PC in some OSs. Please confirm clock set and world time of the camera matches with time, date and time zone in Windows PC or Mac computer. When both settings do not match severely, please match them.

#### I am having a problem connecting to my Windows 8 PC. The user name and password are not recognised.

- Depending on the OS version, on Windows 8, for example, there are two types of user account (local account/Microsoft account).
  - Be sure to use the user name and password for the local account. If you haven't set up a local account, please create one.

#### The Wi-Fi connection is not recognising my PC.

- By default, the Wi-Fi connection uses the default workgroup name of "WORKGROUP". If the name of the workgroup has been changed, it will not be recognised.
  - Select [PC Connection] then [Change Workgroup Name] in the [Wi-Fi Setup] menu to change the workgroup name to match that of your PC. (→255)

#### Pictures cannot be transmitted to the computer.

- If a firewall is enabled by the OS or security software, this unit may be unable to connect to the computer.

#### Images cannot be transmitted to the WEB service.

- Confirm that the login information (login ID/user name/email address/password) is correct.
- WEB service server or the network may be busy.
  - Try again after a while.
  - Check the site of the WEB service you are sending the image to.

#### It takes time to transmit an image to the WEB service.

- Is the size of the image too large?
  - Transmit after dividing the motion picture with [Video Divide] (→176).
  - Reduce the image size at [Size] (→254), and then send.
- It may take longer time to transmit when distance to the wireless access point is far.
  - Transmit closer to the wireless access point.

#### The image that was supposed to have uploaded to the WEB service is not there.

- Upload may not complete when it is disconnected while transmitting the image.
- It may take some time after uploading the image to be reflected in the WEB service depending on the status of the server.
  - Wait for a while and try again.
- You can check the transmission status on the WEB service link settings by logging into "LUMIX CLUB".

#### I would like to return the image in the WEB service to the camera.

- The images in the WEB Service cannot be saved (downloaded) to this unit. Do not delete the uploaded images, and make a backup of them.

### About the Wi-Fi function (continued)

#### I cannot display or delete the images uploaded to the WEB service by this unit.

- The images uploaded to the WEB service cannot be displayed or deleted by this unit.  
→ Perform the task using a smartphone or a PC.

#### Your "LUMIX CLUB" login ID and password were deleted after sending the camera in to be repaired.

- The settings stored in the camera may be deleted depending on the type of repair.  
→ Always make a copy of important settings.

#### There is an image that could not be transmitted.

- Is the size of the image too large?  
→ Divide the motion picture using [Video Divide] (→176).  
→ Reduce the image size at [Size] (→254), and then send.
- Capacity or number of images in the WEB service is full.  
→ Login to "LUMIX CLUB", and check the status of the destination on the WEB service link settings.

#### I have forgotten the password for the Wi-Fi.

- Execute the [Reset Wi-Fi Settings] in the [Setup] menu. (→71)  
However, the information you have set on the [Wi-Fi Setup] menu will be reset.

#### Transmission of the image fails midway.

- Is the size of the image too large?  
→ Transmit after dividing the motion picture with [Video Divide] (→176).  
→ Reduce the image size at [Size] (→254), and then send.  
→ Image cannot be transmitted when the battery indicator is flashing red.

#### Motion picture cannot be transmitted.

- File format of the motion picture that can be sent differs depending on the destination. (→202, 209, 211, 216, 222, 227)
- Is the size of the image too large?  
→ Transmit after dividing the motion picture with [Video Divide] (→176).

#### I cannot send images to an AV device.

- Sending may fail depending on the operational status of the AV device.  
Also, sending may take a while.

#### I cannot connect using the NFC function.

- The smartphone is not NFC compatible.  
This function can be used with NFC compatible devices with Android (2.3.3 or above).
- Is the NFC function on the smartphone turned off?
- The [NFC Operation] on this unit is set to [OFF]. (→256)
- The camera has a hard time recognising some smartphone models. If it is not recognised, slowly shift the smartphone while it is beside the unit.

**TV, computer, printer****No image appears on TV. Image blurred or not coloured.**

- Not connected correctly (→277).
- The television has not been switched to auxiliary input.
- Check the [Video Out] setting (NTSC/PAL) on the camera. (→72)

**The display on the TV and on the camera do not match.**

- Aspect ratio may be incorrect or edges may be cut off with certain televisions.

**Cannot play motion pictures on TV.**

- Card is inserted into TV.
  - Connect with AV cable (optional) or HDMI micro cable and play on camera (→277).

**Picture is not displayed on full TV screen.**

- Check [TV Aspect] settings (→72).

**No sound is output from the camera speaker.**

- When the AV cable (optional) or HDMI micro cable is connected to the camera, no sound is output from the camera.

**VIERA Link (HDMI) is not working.**

- Is the HDMI micro cable connected correctly? (→277)
  - Check that the HDMI micro cable is fully inserted.
- Is the camera's [VIERA Link] setting set to [ON]? (→73)
  - The input setting may not be able to be changed automatically with certain television HDMI sockets. In this case, please change the input setting with your television's remote control (consult your television's operating instructions for details).
  - Check the VIERA Link (HDMI) settings on the device you are connecting to.
  - Turn the camera off and on again.
  - Turn the "VIERA Link control (HDMI device control)" setting on your television (VIERA) to off and then to on again. (Consult your VIERA's operating instructions for details.)

**Cannot communicate with the computer.**

- Not connected correctly (→288).
- Check whether computer has recognised camera.
  - Set [USB Mode] to [PC] (→72).
  - Turn the camera off and then on again.

**TV, computer, printer (continued)****Computer does not recognise card (only reads built-in memory).**

- Disconnect USB connection cable (supplied) and reconnect with card in place.

**Computer does not recognise card. (When using an SDXC Memory Card)**

- Check whether your computer is compatible with SDXC Memory Cards.  
<http://panasonic.net/avc/sdcard/information/SDXC.html>
- A message prompting you to format the card may appear when you connect it. Do not format the card.
- If the [Access] indicator on the screen does not go off, turn the camera off before disconnecting the USB connection cable.

**Cannot print when connecting to printer.**

- Printer not compatible with PictBridge.
- Set [USB Mode] to [PictBridge(PTP)] (→72).

**The edges of pictures are cut off when printing.**

- Release any trimming or edgeless printing settings on printer before printing.  
(Refer to the instruction manual for the printer.)
- The pictures were recorded in [16:9] aspect ratio.  
→ If printing in shop, check if 16:9 sizes can be printed.

**Cannot print panorama pictures properly.**

- The aspect ratio of panorama pictures is different from that of regular still pictures, and some panorama pictures may not be printed correctly.  
→ Use a printer with support for panorama pictures. (Refer to the instruction manual for the printer.)  
→ We recommend adjusting the size of a picture in accordance with print paper using the "PHOTOfunSTUDIO" software on the CD-ROM (supplied).

**Others****Menu not displayed in desired language.**

- Change [Language] setting (→74).

**Camera rattles if shaken.**

- This sound is made by the lens movement and is not a fault.

**Red lamp illuminated when pressing shutter button halfway in dark locations.**

- [AF Assist Lamp] is set to [ON] (→149).

**AF Assist Lamp is not illuminated.**

- [AF Assist Lamp] is set to [OFF] (→149).
- Not illuminated in bright locations.

**Camera is hot.**

- Camera may become a little warm during use, but this does not affect performance or quality.

**Lens makes a clicking noise.**

- When brightness changes, the lens may make a clicking noise and the LCD monitor or viewfinder brightness may also change, but this is due to aperture settings being made.  
(Does not affect recording.)

**Clock is incorrect.**

- Camera has been left for a long period.  
→ Reset the clock (→29).
- A long time was taken to set the clock (clock will be behind by the same lapse of time).

**When using zoom, picture becomes slightly warped and the edges of the subject become coloured.**

- Pictures may be slightly warped or coloured around the edges, depending on the zoom ratio, but this is not a fault.

**Zoom does not reach the maximum ratio.**

- If the zoom ratio stops at 3x, [Macro Zoom] has been set. (→95)  
→ Press ◀ to disable [Macro Zoom].

**File numbers are not recorded in sequence.**

- File numbers are reset when new folders are created (→289).

**File numbers have jumped backwards.**

- Battery was removed/inserted with the camera turned on.  
(Numbers may jump backwards if folder/file numbers are not correctly recorded.)

## Usage cautions and notes

### When in use

- Camera may become warm if used for long periods of time, but this is not a fault.
- **Keep this unit as far away as possible from electromagnetic equipment (such as microwave ovens, TVs, video games etc.).**
  - If you use this unit on top of or near a TV, the pictures and/or sound on this unit may be disrupted by electromagnetic wave radiation.
  - Do not use this unit near cell phones because doing so may result in noise adversely affecting the pictures and/or sound.
  - Recorded data may be damaged, or pictures may be distorted, by strong magnetic fields created by speakers or large motors.
  - Electromagnetic wave radiation may adversely affect this unit, disturbing the pictures and/or sound.
  - If this unit is adversely affected by electromagnetic equipment and stops functioning properly, turn this unit off and remove the battery or disconnect AC adaptor (supplied). Then reinsert the battery or reconnect AC adaptor and turn this unit on.

### **Do not use this unit near radio transmitters or high-voltage lines.**

- If you record near radio transmitters or high-voltage lines, the recorded pictures and/or sound may be adversely affected.
- Do not extend the supplied cord or cable.
- Do not allow camera to come into contact with pesticides or volatile substances (can cause surface damage or coating to peel).
- Never leave the camera and the battery in a car or on a car hood in the summer. Doing so may cause leakage of the battery electrolyte, overheating, fire or a battery explosion due to the high temperature.

### Caring for your camera

To clean your camera, remove the battery or disconnect the power plug from the outlet, and wipe with a soft, dry cloth.

- Use a damp cloth to remove stubborn stains, before wiping with a dry cloth.
- Do not use benzine, thinners, alcohol, or kitchen detergent, as these may damage the outer casing and finish of the camera.
- If using a chemically-treated cloth, read the supplied instructions carefully.
- Do not touch the lens barrier.



Lens barrier



### When not using for a while

- Turn off the camera before removing battery and card (ensure that battery is removed to prevent damage through over-discharge).
- Do not leave in contact with rubber or plastic bags.
- Store together with a drying agent (silica gel) if leaving in drawer, etc. Store batteries in cool (15 °C to 25 °C (59 °F to 77 °F)) places with low humidity (40%RH to 60%RH) and no major temperature changes.
- Charge battery once per year and use completely before storing again.

### Memory cards

- To prevent damage to cards and data
  - Avoid high temperatures, direct sunlight, electromagnetic waves, and static electricity.
  - Do not bend, drop, or expose to strong impacts.
  - Do not touch terminals on reverse of card or allow them to become dirty or wet.
- When disposing of/transferring memory cards
  - If using the "format" or "delete" functions on your camera or computer, this only changes the file management information, and does not completely delete the data from within the memory card. When disposing of or transferring your memory cards, we recommend physically destroying them, or using commercially available computer data erasing software to completely delete the data from the card. Data within memory cards should be managed responsibly.

### LCD monitor/Viewfinder

- Do not press hard on the LCD monitor. This may cause uneven display and damage the LCD monitor.
- In cold climates or other situations when the camera becomes cold, the LCD monitor or the viewfinder may appear slightly darker than normal immediately after the camera is turned on. Normal brightness will return once the internal components have warmed up.

The LCD monitor and viewfinder are made with extremely high precision technology. However there may be some dark or bright spots (red, blue or green) on the screen. This is not a malfunction. The LCD monitor and viewfinder screens are controlled with extremely high precision (greater than 99.99%), but some pixels (under 0.01%) may be inactive. The spots will not be recorded on pictures on the built-in memory or a card.

### Battery

- The battery is a rechargeable lithium ion battery. If the temperature is too high or too low, the operating time of the battery will become shorter.
- The time required for charging varies depending on conditions of battery usage. Charging takes longer at high or low temperatures and when the battery has not been used in some time.
- Battery will be warm during charging and for some time thereafter.
- Battery will run out if not used for long periods of time, even after being charged.
- Do not leave any metal items (such as clips) near the contact areas of the power plug. Otherwise, a fire and/or electric shocks may be caused by short-circuiting or the resulting heat generated.
- Frequently charging up battery is not recommended. (Frequently charging battery reduces maximum usage time and can cause battery to expand.)
- If available battery power is significantly reduced, battery is reaching end of lifespan. Please purchase a new battery.
- When charging:
  - Wipe dirt from the battery terminal with a dry cloth.
  - Keep at least 1 m (3.3 feet) away from AM radio (may cause radio interference).
- Do not use a damaged or dented battery (especially connectors), e.g. by dropping (can cause faults).
- Do not peel off or scratch the covering on the battery.
  - Using a battery with a part of or all of its covering removed or broken may cause malfunction.

### AC adaptor (supplied)

- Keep at least 1 m (3.3 feet) away from AM radio (may cause radio interference).
- The AC adaptor (supplied) may generate whirring sounds when it is being used. This is not a malfunction.
- After use, be sure to disconnect the power supply device from the electrical outlet. (A very small amount of current is consumed if it is left connected.)

### Lens

- Images may appear slightly white if lens is dirty (fingerprints, etc.). Turn the camera on, hold the extracted lens barrel with your fingers, and gently wipe the lens surface with a soft, dry cloth.
- Do not leave the lens exposed to direct sunlight.
- Do not touch the lens barrier, as this may damage the lens. Be careful when removing camera from bag, etc.

### When using a tripod or unipod

- Do not apply excessive force or tighten screws when they are crooked. (This may damage the camera, screw hole, or label.)
- Ensure that the tripod is stable. (Refer to the tripod instructions.)
- You may not be able to remove the card or the battery when using a tripod or unipod.

### 3D viewing

- Anyone who is hypersensitive to light, suffers from heart disease or is otherwise unwell should avoid viewing 3D pictures.
  - Viewing 3D pictures may have an adverse effect to the individual.
- If you feel tired, uncomfortable or otherwise strange when viewing 3D pictures, stop viewing at once.
  - Continuing to view may cause illness.
  - After stopping viewing, please rest appropriately.
- When viewing 3D pictures, we recommend taking a break every 30 to 60 minutes.
  - Viewing for extended periods may cause eye-fatigue.
- Short-sighted or long-sighted persons, those with differences in the sight of their right and left eyes, and those with astigmatism are advised to correct their vision by wearing glasses etc. Stop viewing if you can clearly see a double image while watching 3D pictures.
  - There are differences in the way that different people experience 3D pictures. Please correct your sight appropriately before viewing 3D pictures.
  - You can change the 3D setting of your television or 3D output setting of the unit to 2D.

### Personal Information

To protect personal information, we recommend that you set a Wi-Fi password. (→256)

If names or birthdays are set in [Baby] Mode or in the [Face Recog.] function, keep in mind that the camera and recorded pictures will contain personal information.

- **Disclaimer**
  - Data containing personal information can be altered or lost due to malfunction, static electricity, accidents, breakdowns, repairs, or other operations.  
Panasonic will not be liable for any damage that occurs, direct or indirect, as a result of the alteration or loss of data containing personal information.
- **When ordering repairs or transferring/disposing of the camera**
  - To protect your personal information, please reset the settings. (→71)
  - If any pictures are contained in the built-in memory, copy (→184) them to a memory card if necessary, and then format (→74) the built-in memory.
  - Remove the memory card from the camera.
  - When ordering repairs, the built-in memory and other settings may be returned to the initial purchase state.
  - If the above operations cannot be performed because of a camera malfunction, consult with the dealer or nearest Service Centre.
- **When transferring or disposing of your memory card, see “When disposing of/transferring memory cards” in the previous section (→317)**
- **Uploading pictures to Web services**
  - Pictures may contain personal information that can be used to identify the user, such as titles, recording dates and times, and location information. Before uploading the pictures to Web services, check the pictures carefully for information that should not be disclosed.

**Important! Be sure to read the following before using the location names that are stored in this product.**

#### User Licence Agreement for Location Name Data

##### Personal Use Only.

You agree to use this Data together with this digital camera for the solely personal, non-commercial purposes for which you were licensed, and not for service bureau, time-sharing or other similar purposes. Accordingly, but subject to the restrictions set forth in the following paragraphs, you agree not to otherwise reproduce, copy, modify, decompile, disassemble or reverse engineer any portion of this Data, and may not transfer or distribute it in any form, for any purpose, except to the extent permitted by mandatory laws. Multi-disc sets may only be transferred or sold as a complete set as provided by Panasonic Corporation and not as a subset thereof.

##### Restrictions.

Except where you have been specifically licensed to do so by Panasonic Corporation, and without limiting the preceding paragraph, you may not (a) use this Data with any products, systems, or applications installed or otherwise connected to or in communication with vehicles, capable of vehicle navigation, positioning, dispatch, real time route guidance, fleet management or similar applications; or (b) with or in communication with any positioning devices or any mobile or wireless-connected electronic or computer devices, including without limitation cellular phones, palmtop and handheld computers, pagers, and personal digital assistants or PDAs.

##### Warning.

The Data may contain inaccurate or incomplete information due to the passage of time, changing circumstances, sources used and the nature of collecting comprehensive geographic data, any of which may lead to incorrect results.

**No Warranty.**

This Data is provided to you "as is," and you agree to use it at your own risk. Panasonic Corporation and its licensors (and their licensors and suppliers) make no guarantees, representations or warranties of any kind, express or implied, arising by law or otherwise, including but not limited to, content, quality, accuracy, completeness, effectiveness, reliability, fitness for a particular purpose, usefulness, use or results to be obtained from this Data, or that the Data or server will be uninterrupted or error-free.

**Disclaimer of Warranty:**

PANASONIC CORPORATION AND ITS LICENSORS (INCLUDING THEIR LICENSORS AND SUPPLIERS) DISCLAIM ANY WARRANTIES, EXPRESS OR IMPLIED, OF QUALITY, PERFORMANCE, MERCHANTABILITY, FITNESS FOR A PARTICULAR PURPOSE OR NON-INFRINGEMENT. Some States, Territories and Countries do not allow certain warranty exclusions, so to that extent the above exclusion may not apply to you.

**Disclaimer of Liability:**

PANASONIC CORPORATION AND ITS LICENSORS (INCLUDING THEIR LICENSORS AND SUPPLIERS) SHALL NOT BE LIABLE TO YOU: IN RESPECT OF ANY CLAIM, DEMAND OR ACTION, IRRESPECTIVE OF THE NATURE OF THE CAUSE OF THE CLAIM, DEMAND OR ACTION ALLEGING ANY LOSS, INJURY OR DAMAGES, DIRECT OR INDIRECT, WHICH MAY RESULT FROM THE USE OR POSSESSION OF THE INFORMATION; OR FOR ANY LOSS OF PROFIT, REVENUE, CONTRACTS OR SAVINGS, OR ANY OTHER DIRECT, INDIRECT, INCIDENTAL, SPECIAL OR CONSEQUENTIAL DAMAGES ARISING OUT OF YOUR USE OF OR INABILITY TO USE THIS INFORMATION, ANY DEFECT IN THE INFORMATION, OR THE BREACH OF THESE TERMS OR CONDITIONS, WHETHER IN AN ACTION IN CONTRACT OR TORT OR BASED ON A WARRANTY, EVEN IF PANASONIC CORPORATION OR ITS LICENSORS HAVE BEEN ADVISED OF THE POSSIBILITY OF SUCH DAMAGES. Some States, Territories and Countries do not allow certain liability exclusions or damages limitations, so to that extent the above may not apply to you.

**Export Control.**

Panasonic Corporation shall not export from anywhere any part of the Data or any direct product thereof except in compliance with, and with all licenses and approvals required under, applicable export laws, rules and regulations, including but not limited to the laws, rules and regulations administered by the Office of Foreign Assets Control of the U.S. Department of Commerce and the Bureau of Industry and Security of the U.S. Department of Commerce. To the extent that any such export laws, rules or regulations prohibit NT from complying with any of its obligations hereunder to deliver or distribute Data, such failure shall be excused and shall not constitute a breach of this Agreement.

**Entire Agreement.**

These terms and conditions constitute the entire agreement between Panasonic Corporation (and its licensors, including their licensors and suppliers) and you pertaining to the subject matter hereof, and supersedes in their entirety any and all written or oral agreements previously existing between us with respect to such subject matter.

**About Location Information and Place Name Information****About the geographical coordinate system**

The latitude and longitude standard (geographical coordinate system) recorded with this camera is WGS84.

**About copyright**

According to copyright law, the map data stored in this camera may not be used for purposes other than personal use without the permission of the copyright holder.

**About navigation functions**

This camera is not equipped with a navigation function.

**Notices related to licensed software copyright holders**

"MAPPLE" is a trademark of Shobunsha Publications, Inc.



© 1987-2012 HERE. All rights reserved.

This data includes information taken with permission from Canadian authorities, including © Her Majesty the Queen in Right of Canada, © Queen's Printer for Ontario, © Canada Post Corporation, GeoBase®, © Department of Natural Resources Canada. All rights reserved.

© United States Postal Service® 2012, USPS®, ZIP+4®

Fuente: INEGI (Instituto Nacional de Estadística y Geografía)

Traffic Codes for Belgium are provided by the Ministerie van de Vlaamse Gemeenschap and the Ministère de l'Équipement et des Transports.

Territory	Notice
Austria	© Bundesamt für Eich- und Vermessungswesen
Croatia	© EuroGeographics
Belgium (If using Traffic Codes for Belgium)	Traffic Codes for Belgium are provided by the Ministerie van de Vlaamse Gemeenschap and the Ministère de l'Équipement et des Transports.
Cyprus	© EuroGeographics
Estonia	© EuroGeographics
France	source: © IGN 2009 – BD TOPO ®
Germany	“Die Grundlagendaten wurden mit Genehmigung der zuständigen Behörden entnommen” or “Die Grundlagendaten wurden mit Genehmigung der zustaendigen Behoerden entnommen.”
Great Britain	Contains Ordnance Survey data © Crown copyright and database right 2010 Contains Royal Mail data © Royal Mail copyright and database right 2010
Greece **	Copyright Geomatics Ltd.
Hungary	Copyright © 2003; Top-Map Ltd.
Italy	La Banca Dati Italiana è stata prodotta usando quale riferimento anche cartografia numerica ed al tratto prodotta e fornita dalla Regione Toscana.
Latvia	© EuroGeographics
Lithuania	© EuroGeographics
Moldova	© EuroGeographics
Norway	Copyright © 2000; Norwegian Mapping Authority
Poland	© EuroGeographics
Portugal	Source: IgeoE – Portugal
Slovenia	© EuroGeographics
Spain	Información geográfica propiedad del CNIG
Sweden	Based upon electronic data © National Land Survey Sweden.
Switzerland	Topografische Grundlage: © Bundesamt für Landestopographie
Ukraine	© EuroGeographics
Canada	“This data includes information taken with permission from Canadian authorities, including © Her Majesty, © Queen’s Printer for Ontario, © Canada Post, GeoBase®, © Department of Natural Resources Canada. All rights reserved.”
United States	©United States Postal Service® 2012. Prices are not established, controlled or approved by the United States Postal Service®. The following trademarks and registrations are owned by the USPS: United States Postal Service, USPS, and ZIP+4.
Australia	Copyright. Based on data provided under license from PSMA Australia Limited (www.psm.com.au). Product incorporates data which is © 2012 Telstra Corporation Limited, GM Holden Limited, Intelomatics Australia Pty Ltd and Continental Pty Ltd.



<b>Territory</b>	<b>Notice</b>
<b>Australia</b> (If using RDS-TMC Traffic Codes for Australia)	Product incorporates traffic location codes which is © 2012 Telstra Corporation Limited and its licensors.
<b>Australia</b> (If using Actual Address Range Content for Australia)	Copyright. Based on data provided under license from PSMA Australia Limited ( <a href="http://www.pasma.com.au">www.pasma.com.au</a> ).
<b>Nepal</b>	Copyright © Survey Department, Government of Nepal.
<b>Sri Lanka</b>	This product incorporates original source digital data obtained from the Survey Department of Sri Lanka © 2009 Survey Department of Sri Lanka The data has been used with the permission of the Survey Department of Sri Lanka
<b>Israel</b>	© Survey of Israel data source
<b>Jordan</b>	"© Royal Jordanian Geographic Centre". The foregoing notice requirement for Jordan Data is a material term of the Agreement. If Client or any of its permitted sublicensees (if any) fail to meet such requirement, NT shall have the right to terminate Client's license with respect to the Jordan Data.
<b>Mozambique</b>	Certain Data for Mozambique provided by Cenacarta © 2012 by Cenacarta
<b>Réunion</b>	source: © IGN 2009 - BD TOPO ®
<b>Ecuador</b>	INSTITUTO GEOGRAFICO MILITAR DEL ECUADRO AUTORIZACION N° IGM-2011-01- PCO-01 DEL 25 DE ENERO DE 2011
<b>Guadeloupe</b>	source: © IGN 2009 - BD TOPO ®
<b>Guatemala</b>	Aprobado por el INSTITUTO GEOGRAFICO NACIONAL – Resolución del IGN N° 186-2011
<b>French Guiana</b>	source: © IGN 2009 - BD TOPO ®
<b>Martinique</b>	source: © IGN 2009 - BD TOPO ®
<b>Mexico</b>	Fuente: INEGI (Instituto Nacional de Estadística y Geografía)

### ■ Landmark types

Although approx. 1,000,000 landmarks are registered in the built-in memory, there are also some unregistered landmarks. (The registered information is current as of October 2012 and will not be updated.)

Zoo	Botanical garden	Aquarium
Amusement park	Golf course	Camp sites
Ski resorts	Skating rinks	Outdoor activity sites
Famous site, tourist attraction, beauty spot	Castle, ruins	Shrine
Temple	Church	Tomb, monument, mound, historic site
Airport	Port	Ferry terminal
Baseball park	Athletics ground	Gymnasium
Park	Station	Prefectural or state office
Lifts, cable cars	Art museum	History museum
Theatre	Cinemas, performing theatres	Wineries, breweries
Mountains, meadows, passes	Canyons, mountain streams, waterfalls, valleys, seashores	Tower, high-rise building



- SDXC Logo is a trademark of SD-3C, LLC.
- HDMI, the HDMI Logo, and High-Definition Multimedia Interface are trademarks or registered trademarks of HDMI Licensing LLC in the United States and other countries.
- HDAVI Control™ is a trademark of Panasonic Corporation.
- “AVCHD”, “AVCHD Progressive” and the “AVCHD Progressive” logo are trademarks of Panasonic Corporation and Sony Corporation.
- Manufactured under license from Dolby Laboratories. Dolby and the double-D symbol are trademarks of Dolby Laboratories.
- Windows and Windows Vista are either registered trademarks or trademarks of Microsoft Corporation in the United States and/or other countries.
- iMovie, Mac and Mac OS are trademarks of Apple Inc., registered in the U.S. and other countries.
- QuickTime and the QuickTime logo are trademarks or registered trademarks of Apple Inc., used under license therefrom.
- App Store is a service mark of Apple Inc.
- Android and Google Play are trademarks or registered trademarks of Google Inc.

- The Wi-Fi CERTIFIED Logo is a certification mark of the Wi-Fi Alliance.
- The Wi-Fi Protected Setup Mark is a mark of the Wi-Fi Alliance.
- “Wi-Fi”, “Wi-Fi Protected Setup”, “Wi-Fi Direct”, “WPA” and “WPA2” are marks or registered marks of the Wi-Fi Alliance.
- DLNA, the DLNA Logo and DLNA CERTIFIED are trademarks, service marks, or certification marks of the Digital Living Network Alliance.
- QR Code is a registered trademark of DENSO WAVE INCORPORATED.
- This product uses “DynaFont” from DynaComware Corporation. DynaFont is a registered trademark of DynaComware Taiwan Inc.
- Other names, company names, and product names mentioned in these instructions are trademarks or registered trademarks of the companies concerned.

This product is licensed under the AVC patent portfolio license for the personal and non-commercial use of a consumer to (i) encode video in compliance with the AVC Standard (“AVC Video”) and/or (ii) decode AVC Video that was encoded by a consumer engaged in a personal and non-commercial activity and/or was obtained from a video provider licensed to provide AVC Video. No license is granted or shall be implied for any other use. Additional information may be obtained from MPEG LA, LLC.  
See <http://www.mpegla.com>.

This product incorporates the following software:

- (1) the software developed independently by or for Panasonic Corporation,
- (2) the software owned by third party and licensed to Panasonic Corporation, and/or
- (3) open source software

The software categorized as (3) is distributed in the hope that it will be useful, but WITHOUT ANY WARRANTY, without even the implied warranty of MERCHANTABILITY or FITNESS FOR A PARTICULAR PURPOSE. Please refer to the detailed terms and conditions thereof displayed by selecting [MENU/SET] → [Setup] → [Version Disp.] → [Software info].

### Disposal of Old Equipment and Batteries Only for European Union and countries with recycling systems



These symbols on the products, packaging, and/or accompanying documents mean that used electrical and electronic products and batteries must not be mixed with general household waste.

For proper treatment, recovery and recycling of old products and used batteries, please take them to applicable collection points in accordance with your national legislation.

By disposing of them correctly, you will help to save valuable resources and prevent any potential negative effects on human health and the environment.

For more information about collection and recycling, please contact your local municipality.

Penalties may be applicable for incorrect disposal of this waste, in accordance with national legislation.



#### **Note for the battery symbol (bottom symbol):**

This symbol might be used in combination with a chemical symbol. In this case it complies with the requirement set by the Directive for the chemical involved.