

# Panasonic<sup>®</sup>

## Owner's Manual for advanced features

Digital Camera

Model No. **DMC-ZS10**

# LUMIX

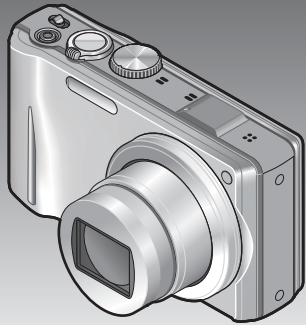

Before connecting, operating or adjusting this product,  
please read the instructions completely.



# Contents

## Before use

Before use .....	5
About GPS .....	7
Standard Accessories .....	8
Names of parts .....	9

## Preparations

Charging battery .....	10
Guidelines for number of recordable pictures and operating time .....	11
Inserting and removing the card (optional)/the battery .....	12
Using the AC adaptor (optional) and DC coupler (optional) instead of the battery .....	13
Picture save destination (cards and built-in memory) .....	14
Remaining battery and memory capacity .....	15
Recording capacity guidelines (pictures/recording time) .....	15
How to operate the camera .....	16
Touch operations .....	17
Setting the clock .....	18
To change time setting .....	19

## Basics

Sequence of operations .....	20
Taking pictures with your own settings [Program AE] Mode .....	22
How to adjust focus .....	23
Touching the screen and recording (Touch Shutter function) .....	24
Touching the screen and adjusting the focus and exposure (Touch AF/AE function) .....	25
Taking pictures with automatic settings [Intelligent Auto] Mode .....	26
Automatic Scene Detection .....	26
About flash .....	27
About Happy colors .....	27
[Motion Deblur] .....	27
[iHandheld Nite Shot] .....	27
AF Tracking .....	28
[Intelligent Auto] Mode restrictions .....	29

Taking motion pictures .....	30
Viewing your pictures [Normal Play] .....	32
Viewing motion pictures .....	33
Zooming in and viewing "Playback Zoom" .....	34
Viewing a list of pictures "Multi Playback" .....	34
Viewing pictures by their recording date "Calendar Playback" .....	35
Deleting pictures .....	36
To delete multiple (up to 100)/ To delete all pictures .....	37
Setting the menu .....	38
Menu type .....	40
Using Quick menu .....	41
Using the [Setup] menu .....	42
[Clock Set] .....	42
[Auto Clock Set] .....	42
[World Time] .....	42
[Travel Date] .....	42
[Beep] .....	42
[Volume] .....	43
[Cust.Set Mem.] .....	43
[LCD Mode] .....	43
[Guide Line] .....	43
[Histogram] .....	44
[Rec Area] .....	44
[Zoom Resume] .....	44
[Economy] .....	45
[Auto Review] .....	45
[No.Reset] .....	46
[Reset] .....	46
[USB Mode] .....	46
[Output] .....	47
[VIERA Link] .....	47
[3D Playback] .....	47
[Rotate Disp.] .....	48
[Version Disp.] .....	48
[Format] .....	48
[Calibration] .....	49
[Language] .....	49
[Demo Mode] .....	49

## Application (Record)

### Taking pictures with zoom..... 50

- Using the zoom by performing touch operations .....50
- Zoom types and use.....51

### Taking pictures with flash..... 52

### Taking close-up pictures ..... 54

- [Macro Zoom].....54
- Focus range .....55

### Taking pictures with self-timer..... 56

### Taking pictures with Exposure

### Compensation..... 57

- Recording while exposure is changed automatically ([Auto Bracket]) .....57

### Determine aperture and shutter speed and record ..... 58

- [Aperture-Priority] Mode .....58
- [Shutter-Priority] Mode .....58
- [Manual Exposure] Mode .....59

### Register your own settings and record

### [Custom] Mode ..... 60

- [Cust.Set Mem.] .....60
- [Custom].....60

### Taking pictures according to the scene

### [Scene Mode] ..... 61

- [My Scene Mode] .....62
- [Portrait].....62
- [Soft Skin].....62
- [Transform] .....62
- [Self Portrait] .....63
- [Scenery] .....63
- [Panorama Assist] .....63
- [Sports].....64
- [Night Portrait] .....64
- [Night Scenery].....64
- [Handheld Night Shot].....64
- [Food].....64
- [Party].....65
- [Candle Light].....65
- [Baby].....65
- [Pet].....65
- [Sunset].....66
- [High Sens.].....66
- [Flash Burst].....66
- [Starry Sky].....66
- [Fireworks].....67

- [Beach].....67
- [Snow] .....67
- [Aerial Photo].....67
- [Pin Hole].....67
- [Film Grain].....67
- [High Dynamic].....67
- [Photo Frame] .....68
- [Underwater].....68
- [High Speed Movie].....68

### Recording 3D still pictures

### [3D Photo Mode] ..... 69

### Burst function ..... 70

### Recording with the Face Recognition

### function [Face Recog.] ..... 72

- Registering face pictures .....73
- Editing or deleting information about registered persons .....74

### Recording the place of recording

### with GPS ..... 75

- Using GPS .....76
- Executing positioning immediately and updating your current location .....78
- Changing the recorded place name information .....79
- Registering your current location as a landmark .....80
- Changing the display of location name information .....81
- Using GPS to set the clock .....81

### Useful features for travel ..... 82

- [Travel Date].....82
- [World Time] .....83

### Entering Text..... 84



## Before use

### ■ Camera handling

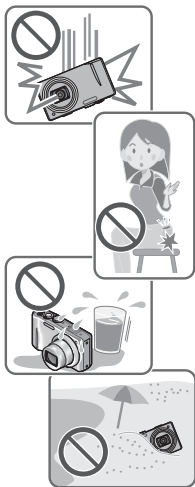

**Keep the camera away from excessive vibration, force, or pressure.**

- Avoid using the camera under the following conditions, which may damage the lens, LCD monitor, or camera body. This may also cause the camera to malfunction or prevent recording.
  - Dropping or hitting the camera against a hard surface
  - Sitting down with the camera in your pants pocket or forcing it into a full bag
  - Adding accessories to the camera strap
  - Pushing with excessive force on the lens or LCD monitor

**The camera is not dust resistant, splash resistant, or waterproof.**

**Avoid using the camera in places with excessive dust or sand, or where water can come into contact with the camera.**

- Avoid using the camera under the following conditions, which present a risk that sand, water, or foreign material may enter the camera through the lens or openings around buttons. Be especially careful, because these conditions may damage the camera and such damage may not be repairable.
  - In extremely dusty or sandy places
  - In the rain or by the shore, where the camera may be exposed to water

### ■ Condensation (lens clouding)

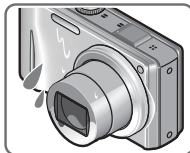

- Condensation may occur when the camera is exposed to sudden changes of temperature or humidity. Avoid these conditions, which may make the lens dirty, cause mold, or damage the camera.
- If condensation does occur, turn off the camera and wait about two hours before using it. Once the camera adjusts to the surrounding temperature, clouded lenses will clear naturally.

## Before use (Continued)

### ■ Always take a test shot first

Before important events when you will use the camera (at weddings, for example), always take a test shot to make sure that pictures and sound record correctly.

### ■ No compensation for missed shots

We cannot compensate for missed shots if technical problems with the camera or card prevent recording.

### ■ Carefully observe copyright laws

Unauthorized use of recordings which contain works with copyright for purposes other than personal use is prohibited under copyright law. Recording of certain material may be restricted even for the purpose of personal use.

### ■ Also refer to “Usage cautions and notes” (→141)

## About GPS

### ■ About the camera's location name information

Before using the camera, read "User License Agreement for Location Name Data". (→145)

### ■ When [GPS Setting] is [ON], the GPS function works even if the camera's power is off.

- Electromagnetic waves from the camera can affect instruments and meters. During airplane takeoff and landing or in other restricted area, set [GPS Setting] to [OFF] or , then turn the camera's power off. (→76)
- When [GPS Setting] is [ON], power will drain from the battery even if the camera's power is OFF.

### ■ Recording location information

- The names of recording locations and landmarks (such as buildings) are current as of December 2010. These will not be updated.
- Depending on the country or area, limited location name and landmark information may be available.

### ■ Positioning

- Positioning will take time in environments where it is difficult to receive the signals from the GPS satellites. (→75)
- **Even if GPS reception is good, it will take approximately 2 to 3 minutes to successfully execute positioning under the following conditions; when positioning is executed for the first time, or when positioning is executed after the camera is turned off with the [GPS Setting] set to  and then turned on again or when [GPS Setting] is set to [OFF].**
- Because the positions of the GPS satellites are constantly changing, depending on the recording location and conditions, it may not be possible to position such satellites accurately, or positioning discrepancy may occur.

### ■ When using in another country

- GPS may not work in China or in the border regions of countries neighboring China. (Current as of December 2010)
- Some countries or regions may regulate the use of GPS or related technology. Because this camera has a GPS function, before taking it into another country, check with the embassy or your travel agency whether there are any restrictions on bringing cameras with a GPS function.

## Standard Accessories

Check that all the accessories are supplied before using the camera.

- The accessories and their shape will differ depending on the country or area where the camera was purchased.

For details on the accessories, refer to Basic Owner's Manual.

- Battery Pack is indicated as battery pack or battery in the text.
- Battery Charger is indicated as battery charger or charger in the text.
- Please dispose of all packaging appropriately.
- Keep small parts in a safe place out of the reach of children.

### ■ Optional accessories

- **Cards are optional.** You can record or play back pictures on the built-in memory when you are not using a card. (→14)
- If any accessories are lost, customers in the USA and Puerto Rico should contact Panasonic's parts department at 1-800-833-9626 and customers in Canada should contact 1-800-99-LUMIX (1-800-995-8649) for further information about obtaining replacement parts.



# Names of parts

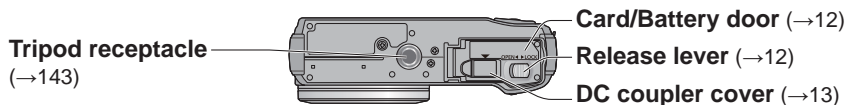
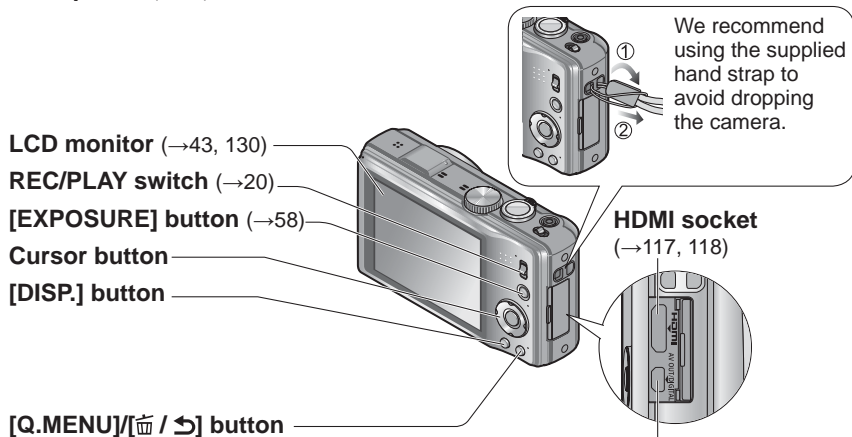
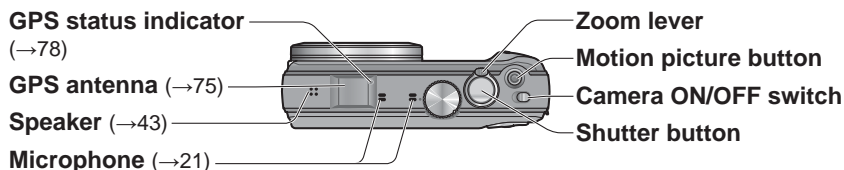
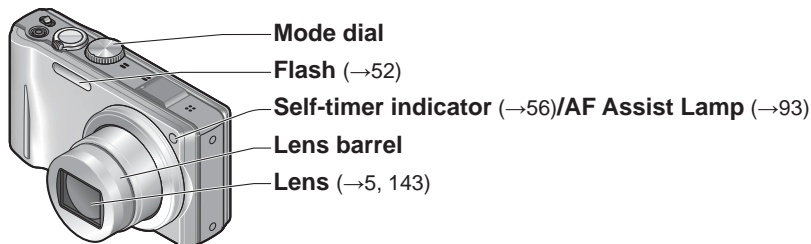

- The illustrations and screens in this manual may differ from the actual product.
- How to operate the camera (→16)

# Charging battery

Always charge before first use! (battery shipped uncharged)

## ■ About batteries that you can use with this unit

It has been found that counterfeit battery packs which look very similar to the genuine products are made available to purchase in some markets. Some of these battery packs are not adequately protected with internal protection to meet the requirements of appropriate safety standards. There is a possibility that these battery packs may lead to fire or explosion. Please be advised that we are not liable for any accident or failure occurring as a result of use of a counterfeit battery pack. To ensure that safe products are used we recommend that a genuine Panasonic battery pack is used.

- Use the dedicated charger and battery.
- The camera has a function for distinguishing batteries which can be used safely. The dedicated battery supports this function. The only batteries suitable for use with this unit are genuine Panasonic products and batteries manufactured by other companies and certified by Panasonic. (Batteries which do not support this function cannot be used). Panasonic cannot in any way guarantee the quality, performance or safety of batteries which have been manufactured by other companies and are not genuine Panasonic products.

### 1 Insert the battery terminals and attach the battery to the charger

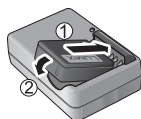

### 2 Connect the charger to the electrical outlet

● Plug-in type

● Inlet type

Battery

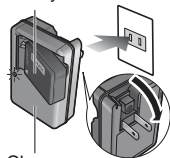

Charger  
(model-specific)

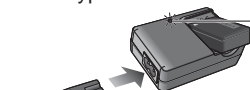

• The AC cable does not fit entirely into the AC input terminal. A gap will remain.

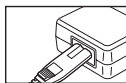

- Charge the battery with the charger indoors (10 °C - 30 °C (50 °F to 86 °F)).

### 3 Detach the battery after charging is completed

- The battery charger is in the standby condition when the AC power is supplied. The primary circuit is always "live" as long as the battery charger is connected to an electrical outlet.

#### Charging light ([CHARGE])

**On:** Charging in progress (approx. 130 min. if fully depleted)

**Off:** Charging complete

#### If light is flashing:

- Charging may take longer than normal if battery temperature is too high or too low (charging may not be completed).
- Battery/charger connector is dirty. Clean with a dry cloth.

## Guidelines for number of recordable pictures and operating time

The number of recordable pictures or available operating time may vary according to surrounding environment and usage conditions. Figures may be reduced if flash, zoom, or other functions are used frequently, or in colder climates.

### ■ Recording still pictures

Number of recordable pictures	Approx. 260 pictures	By CIPA standard
Recording time	Approx. 130 min	

### ● Recording conditions by CIPA standard

- CIPA is an abbreviation of [Camera & Imaging Products Association].
- [Program AE] Mode
- [GPS Setting] is set to [OFF]
- Temperature: 23 °C (73.4 °F)/Humidity: 50 %RH when LCD monitor is on.
- Using a Panasonic SD Memory Card (32 MB).
- Using the supplied battery.
- Starting recording 30 seconds after the camera is turned on. (When the Optical Image Stabilizer function is set to [ON].)
- Recording once every 30 seconds with full flash every second recording.
- Rotating the zoom lever from Tele to Wide or vice versa in every recording.
- Turning the camera off every 10 recordings and leaving it until the temperature of the battery decreases.

Number reduced if intervals are longer – e.g. to approx. one quarter for 2-minute intervals under the above conditions.

### ■ Recording motion pictures

[Rec Quality]	[AVCHD] [FSH]	[Motion JPEG] [HD]
Available recording time*1	About 70 minutes	About 85 minutes
Actual available recording time*2	About 35 minutes	About 40 minutes

### ● Recording conditions

- Temperature 23 °C (73.4 °F), humidity 50 %RH
- [GPS Setting] is set to [OFF]

\*1 An AVCHD motion picture can be recorded continuously for up to 29 minutes 59 seconds when [GFS] or [FSH] is set.

A maximum of approx. 2 GB of continuous motion picture can be recorded in [Motion JPEG] format. (Even if there is more than 2 GB of available space on the card, the available recording time will be calculated for a maximum of 2 GB.)

\*2 The time you can actually record when repeatedly turning the power on and off, starting and stopping recording and using zoom.

### ■ Viewing pictures

Playback time	About 210 minutes
---------------	-------------------

## Inserting and removing the card (optional)/ the battery

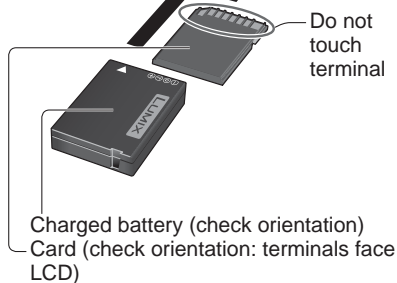
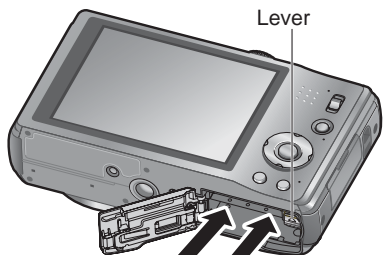

- 1** Set the camera ON/OFF switch to OFF  
**Slide to the [OPEN] position and open the lid**

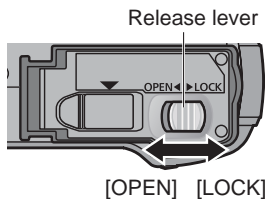

- 2** **Completely insert battery and card**

- Battery: Insert all the way firmly until a locking sound is heard, and check that the lever is hooked over the battery.
- Memory card: Push in until it clicks.

- 3** **Close lid**  
Slide to the [LOCK] position.

### ■ To remove

- **To remove battery:**  
move lever in direction of arrow.

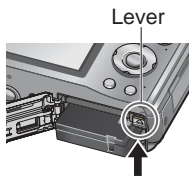

- **To remove card:**  
press down in center.

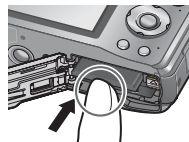

- Always use genuine Panasonic batteries.
- If you use other batteries, we cannot guarantee the quality of this product.
- **Remove battery from camera after use.**
  - Keep the battery in a plastic bag, making sure that it is kept away from metallic objects (such as clips) when carrying or storing the battery.
- To remove the card or battery, turn the camera off and wait until the LUMIX indicator on the LCD monitor goes off. (Failure to wait may cause the camera to malfunction and may damage the card or recorded data.)
- Keep the Memory Card out of reach of children to prevent swallowing.
- The unusable battery should be discarded in accordance with battery recycling laws. Call the RBRC hotline at 1-800-822-8837 for information.

## Using the AC adaptor (optional) and DC coupler (optional) instead of the battery

By using the AC adaptor (optional) and DC coupler (optional), you can record and play back without worrying about the remaining battery charge.

The optional DC coupler can only be used with the designated Panasonic AC adaptor.

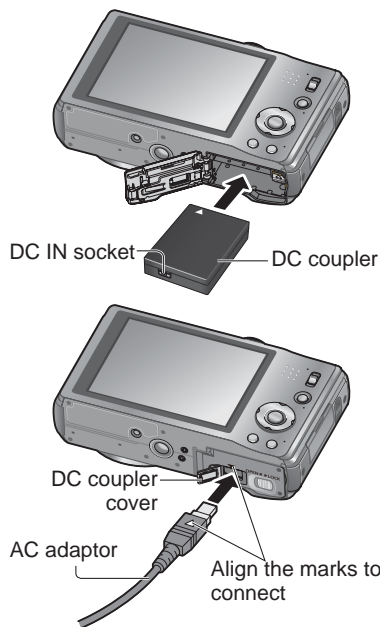

### 1 Insert DC coupler instead of battery (→12)

### 2 Open DC coupler cover

- If difficult to open, with the card/battery door open, press the DC coupler cover from the inside to open it.

### 3 Plug AC adaptor into power outlet

### 4 Connect AC adaptor to DC IN socket of DC coupler

- Always use a genuine Panasonic AC adaptor (optional).
- Use the AC adaptor and DC coupler specifically for this camera. Using other adaptors or couplers could cause camera failure.
- It may not be possible to install camera on a tripod or unipod when the DC coupler is connected, depending on the type of tripod or unipod.
- When the AC adaptor is connected, always remove the AC adaptor when opening the card/battery door.
- Remove the AC adaptor and DC coupler when not in use and close the DC coupler cover.
- Also read the AC adaptor and DC coupler operating instructions.

## Inserting and removing the card (optional)/ the battery (Continued)

### Picture save destination (cards and built-in memory)

#### ■ Built-in memory (approx. 18 MB)

#### ● Pictures may be copied between cards and the built-in memory. (→115)

- The access time for the built-in memory may be longer than the access time for a card.

#### ■ Compatible memory cards (optional)

The following SD standard-based cards (Panasonic brand recommended)

Type of Card	Capacity	Notes
SD Memory Cards	8 MB – 2 GB	<ul style="list-style-type: none"><li>• Using a card of SD speed "Class 4"* or above is recommended for recording motion pictures in [AVCHD].</li><li>• Using a card of SD speed "Class 6"* or above is recommended for recording motion pictures in "MOTION JPEG".</li><li>• Can be used with devices compatible with the respective formats.</li><li>• Before using SDXC Memory Cards, check that your computer and other devices support this type of card. <a href="http://panasonic.net/avc/sdcard/information/SDXC.html">http://panasonic.net/avc/sdcard/information/SDXC.html</a></li><li>• Only the cards listed on the left with the given capacities are supported.</li></ul>
SDHC Memory Cards	4 GB – 32 GB	
SDXC Memory Cards	48 GB, 64 GB	

\* SD speed class refers to a specification for sustained write speeds. Confirm the SD speed by checking the card label or other card related materials.

(Example)

CLASS 4

CLASS 6

- Please reformat the card with this camera if it has already been formatted with a computer or another device. (→48)
- If the write-protect switch is set to "LOCK", the card cannot be used to record or delete pictures, and it cannot be formatted.
- It is recommended that you copy important pictures to your computer (as electromagnetic waves, static electricity, or faults may cause data to be damaged).
- Latest information:  
<http://panasonic.jp/support/global/cs/dsc/> (This Site is English only.)



## Remaining battery and memory capacity

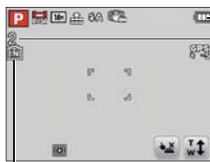

### Remaining battery (only when using battery)



If the battery mark flashes red, recharge or replace battery.

Estimated remaining pictures or recording time capacity (press [DISP.] button to switch display)

Displayed when no card is inserted (pictures will be saved to built-in memory)

### When in operation

(Card) or (Built-in memory) are illuminated red.

While the light remains lit, an operation is taking place, such as picture writing, reading, deletion or formatting. While the light is lit, do not turn off the power or remove battery, card, AC adaptor (optional) or DC coupler (optional), as this can cause data loss or damage. Do not subject the camera to vibrations, impact, or static electricity. Should any of these cause camera operation to be terminated, attempt to perform the operation again.

## Recording capacity guidelines (pictures/recording time)

The number of pictures you can take and the recording time vary in proportion to card capacity (and depending on recording conditions and type of card).

● If you make Web upload settings, the recording picture capacity and the recording time capacity of the card may be reduced. (→105)

### ■ Recording picture capacity (still pictures)

[Picture Size]	Built-in memory	2 GB	4 GB	16 GB
<b>14M</b>	2	330	670	2740
<b>5M</b>	5	650	1300	5300
<b>0.3M</b>	99	10050	19940	81340

• When the number of recordable pictures exceeds 99,999, "+99999" is displayed.

### ■ Recording time capacity (motion pictures)

#### When the [AVCHD] recording mode is used

Built-in memory	2 GB	4 GB	16 GB
–	14 min	29 min	2 h 4 min

• An AVCHD motion picture can be recorded continuously for up to 29 minutes 59 seconds when [GFS] or [FSH] is set. The time displayed in the table is the total time.

#### When the [Motion JPEG] recording mode is used

[Rec Quality]	Built-in memory	2 GB	4 GB	16 GB
<b>HD</b>	–	7 min 40 s	15 min 40 s	1 h 6 min
<b>VGA</b>	–	20 min	41 min	2 h 51 min
<b>QVGA</b>	32 s	55 min 30 s	1 h 53 min	7 h 55 min

• A maximum of approx. 2 GB of continuous motion picture can be recorded in [Motion JPEG] format. (Even if there is more than 2 GB of available space on the card, the available recording time will be calculated for a maximum of 2 GB.)  
The time displayed in the table is the total time.

# How to operate the camera

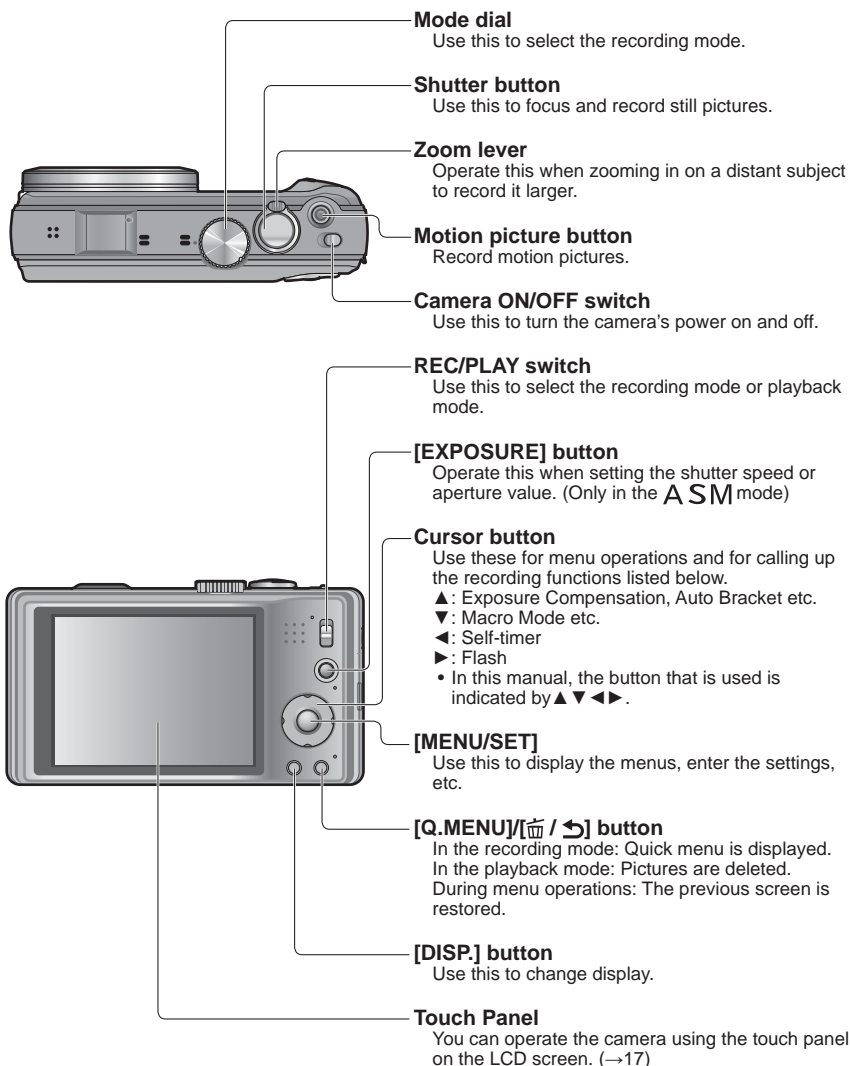



## Touch operations

This camera's touch panel senses pressure that is applied to the screen.

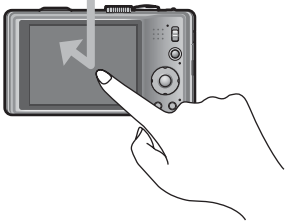
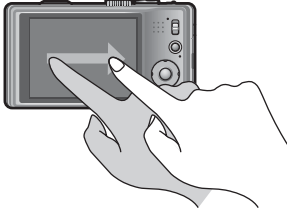
<b>Touch</b> To "touch" is to press the touch panel and then pull the finger back again.	<b>Drag</b> To "drag" is to touch and slide your finger across the touch panel surface.
 <p>Touching is used to select icons or pictures, among other actions.</p> <ul style="list-style-type: none"><li>• Touch an icon near its center. If multiple icons are touched simultaneously, the camera may not operate normally.</li></ul>	 <p>Dragging (sliding your finger across the screen) is used to scroll the pictures or change the range of the pictures displayed.</p>

- If the type of sheet to protect LCD screens that are available on the market is to be used, observe the precautions that are contained with the sheet. (Some types of protective sheets may impair the screen's visual recognition and ease of operation.)
- If the camera is used with a protective sheet available on the market attached to its screen or if the screen is not very responsive, touch the screen with a little more pressure.
- If your hand is pressed against the touch panel when holding the camera, the touch panel will not work properly.
- Do not press on the LCD monitor with hard pointed tips, such as ball point pens.
- Do not press the touch panel with your fingernails.
- Clean the LCD monitor with a soft dry cloth if there are fingerprints or other kinds of dirt on it.
- For details of the icons that appear on the touch panel, refer to "List of LCD monitor displays" (→130).

### ■ Stylus pen

The stylus pen (supplied) comes in handy when doing the kinds of jobs that require close or careful operation and your fingertips are too large to perform the operations easily.

- Do not use a pen other than the pen supplied.
- Keep the stylus pen out of the reach of infants and small children.
- Do not place the stylus pen on the LCD monitor when storing. LCD monitor may break when the stylus pen is pressed strongly against the LCD monitor.

# Setting the clock

Set REC/PLAY switch to  before turning on the power.



REC/PLAY switch

## 1 Turn on the power



The power is turned on.  
If the language select screen is not displayed, proceed to step 4.

## 2 Press [MENU/SET] while the message is displayed

## 3 Press ▲ ▼ to select the language, and press [MENU/SET]

- The [Please set the clock] message appears. (This message does not appear in Playback Mode.)

## 4 Press [MENU/SET]

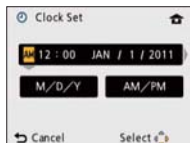

## 5 Press ◀ ▶ to select the items (year, month, day, hour, minute, display order or time display format), and press ▲ ▼ to set



- To cancel → Press  /  button.

## 6 Press [MENU/SET]

## 7 Press [MENU/SET]

- To return to the previous screen, press  /  button.

(The clock is not set when the camera is shipped.)

**8** Press **◀** to select **[Yes]** and press **[MENU/SET]** if automatically correcting time of day using the GPS function

- To manually set date and time → select **[No]**.

**9** When **[Please set the home area]** is displayed, press **[MENU/SET]**

**10** Press **◀▶** to set your home area and press **[MENU/SET]**

City or area name

Current time

The current time and home area are set.

- **[GPS Setting]** turns **[ON]**.



Difference from GMT (Greenwich Mean Time)

## To change time setting

When resetting date and time, select **[Clock Set]** from the **[Setup]** menu.

- Clock settings will be saved for approx. 3 months even after battery is removed, provided a fully-charged battery was installed in the camera for 24 hours beforehand.

**1** Select **[Clock Set]** from the **[Rec]** menu or **[Setup]** menu (→42)

**2** Set the date and time (Perform steps **5** - **6**. (→18))

- Failure to set the date and time will cause the date/time to be improperly printed when printing pictures at a digital photo center or when using **[Date Stamp]** or **[Text Stamp]**.
- After the time has been set, the date can be printed correctly even if the date is not displayed on the camera screen.

# Sequence of operations

**1 Turn on the power**

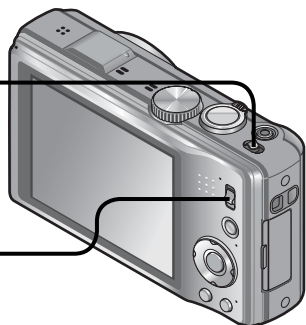

**2 Set to** 

## 3 Set to the desired Recording Mode

Align the mode dial correctly to the mode that you want to use. →

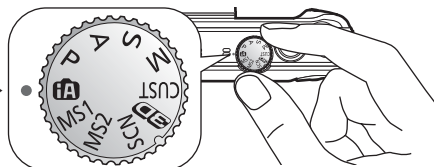

<b>iA</b>	<b>[Intelligent Auto] Mode</b>	Take pictures with automatic settings. (→26)
<b>P</b>	<b>[Program AE] Mode</b>	Record pictures with your own settings. (→22)
<b>A</b>	<b>[Aperture-Priority] Mode</b>	Determine aperture, then record pictures. (→58)
<b>S</b>	<b>[Shutter-Priority] Mode</b>	Determine shutter speed, then record pictures. (→58)
<b>M</b>	<b>[Manual Exposure] Mode</b>	Determine aperture and shutter speed, then record pictures. (→59)
<b>CUST</b>	<b>[Custom] Mode</b>	Record pictures using pre-registered settings. (→60)
<b>ED</b>	<b>[3D Photo Mode]</b>	Record 3D still pictures. (→69)
<b>SCN</b>	<b>[Scene Mode]</b>	Take pictures according to scene. (→61)
<b>MS1</b> <b>MS2</b>	<b>[My Scene Mode]</b>	Take pictures in frequently-used Scene Modes. (→62)

## Aim the camera and shoot

### ■ Taking still pictures

- ① Press the shutter button halfway to focus
- ② Press and hold the shutter button to take the picture

### ■ Recording motion pictures

- ① Press the motion picture button to start recording
- ② Press the motion picture button again to finish recording

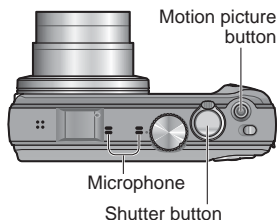

4

### ■ Holding the camera

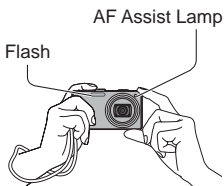

- Stand with your arms close to your body and with your legs apart.
- Do not touch the lens.
- Do not block the microphone when recording motion pictures.
- Do not block the flash or the lamp. Do not look at it from close range.
- Make sure that the camera does not move at the moment the shutter button is pressed.

- We recommend using the supplied hand strap to avoid dropping the camera.

## 5 Set to ▶



5

## 6 View pictures (→32)

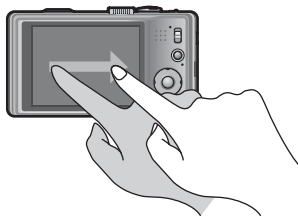

Scrolling to the next picture: Drag your finger across the screen from right to left.  
Returning to the previous picture: Drag your finger across the screen from left to right.

## 7 Turn off the power



7

# Taking pictures with your own settings

[Program AE] Mode

Recording Mode: **P**

Using the [Rec] menu to change settings and set up your own recording environment.

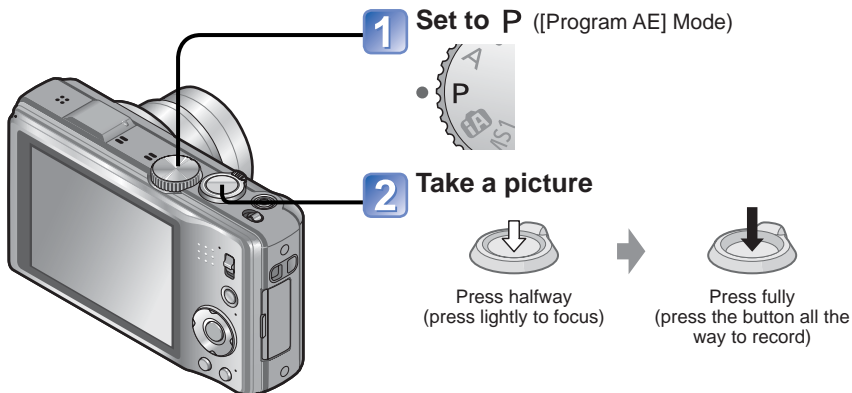

## ■ Changing recording information display

Press the [DISP.] button.

- If a warning is displayed about jitter, use [Stabilizer], a tripod, or [Selftimer].
- If aperture and shutter speed are shown in red, you do not have appropriate exposure. You should either use the flash, change [Sensitivity] settings or set [Min. Shtr Speed] to a slower speed.

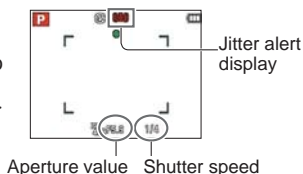

# How to adjust focus

Useful when subject is not in center of picture.

## 1 First adjust focus according to subject

Align the AF area with the subject



Hold down halfway



**Focus display**

(When focus is aligned: illuminated  
When focus is not aligned: flashing)

**AF area**

(When focus is aligned: green  
When focus is not aligned: red)

## 2 Return to desired composition



Press fully



AF area

- Subjects/environments which may make focusing difficult:
  - Fast-moving or extremely bright objects, or objects with no color contrast.
  - Taking pictures through glass or near objects emitting light. In dark, or with significant jitter.
  - When too close to object or when taking pictures of both distant and close objects together in the same picture.

- The focus display flashes and beep sounds when focus is not aligned.  
Use the focus range displayed in red as a reference.  
Even if the focus display is lit, the camera may be unable to bring the subject into focus if it is out of range.
- AF area is displayed larger in the following cases:
  - When using Digital Zoom
  - When focus is difficult to align for a subject in a dark scene

Focus display



Focus range

## Touching the screen and recording

(Touch Shutter function)

Recording Mode: **P** **A** **S** **M** **MS1** **MS2** **SCN** **BD**

This function enables you to focus and record still pictures simply by touching the subjects that appear on the screen.

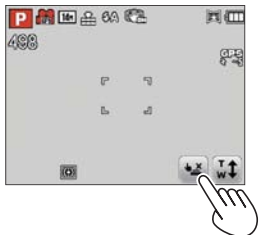

### 1 Touch on the screen

- The icon changes to , and you can now proceed with touch shutter recording.

### 2 Touch the subject you want to record

- The subject is recorded when the auto focus moves to the place that you touch and when the subject is brought into focus.
- To release the touch shutter function  
→ Touch .

- Motion pictures cannot be recorded.
- The touch shutter function will not work along the edges of the screen.
- Please note that the touch shutter will function even if you inadvertently touch the touch panel.
- When [Metering Mode] is set to (Spot), the exposure is adjusted to the place where you touched the screen.
- The setting of the touch shutter function will be stored even if the power switch is turned to off.





## Touching the screen and adjusting the focus and exposure (Touch AF/AE function)

Recording Mode: **[IA]** **[P]** **[A]** **[S]** **[M]** **[MS1]** **[MS2]** **[SCN]** **[3D]**

This function enables the focus and exposure to be set when you touch the subject displayed on the screen.



### 1 Touch the place where you want to set the focus and exposure

- When [AF Mode] is set to  (Face Detection), the Face Detection function continues to operate, but the focus is adjusted to the place where you touched.
- When [AF Mode] is set to , the camera locks onto the subject, and it automatically continues to focus on the subject and adjusts the exposure of the subject as the subject moves.

### 2 Press the shutter button halfway to bring the subject into focus, and then press the button fully to record the subject

- To release the touch AF/AE function  
→ Touch .

- The touch AF/AE function may fail to work under some recording conditions such as when the subject is too small or the recording location is too dark.
- The touch AF/AE function will not work along the edges of the screen.
- During [Intelligent Auto] Mode, the camera will determine the touched subject to be the optimal scene.

# Taking pictures with automatic settings

[Intelligent Auto] Mode

Recording Mode: 

Optimum settings are made automatically from information such as “face”, “movement”, “brightness”, and “distance” just by pointing the camera at the subject, meaning that clear pictures can be taken without the need to make settings manually.

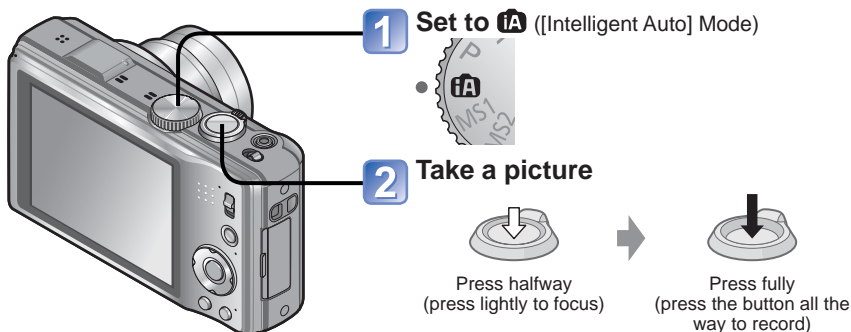





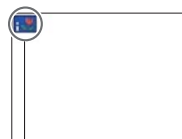



## Automatic Scene Detection

Camera reads scene when pointed at subject, and makes optimum settings automatically.





The icon of scene detected

	Recognizes people
	Recognizes babies*1
	Recognizes landscapes
	Recognizes night scenes and people in them (Only when <b>iA</b> is selected)*2
	Recognizes night scenes
	Recognizes night scenes without a tripod.*3
	Recognizes close-ups
	Recognizes sunsets
	Reads subject movement to avoid blurring when scene does not correspond to any of the above.

\*1 When babies (under 3 years) that are registered with the Face Recognition function are recognized

\*2 We recommend using a tripod and the self-timer.

\*3 When [iHandheld Nite Shot] is [ON]

- Depending on recording conditions, different scene types may be determined for the same subject.
- If desired scene type is not selected, we recommend manually selecting the appropriate Recording Mode.
- When , , or  is detected, Face Detection is activated, and the focus and exposure are adjusted for the recognized faces.

## About flash

Press **▶** to select **i/A** or **☺**.

- When **i/A** is selected, the optimum flash is selected automatically depending on conditions. (→52)
- When **i/S** or **i/S** is selected, the shutter speed is reduced.

## About Happy colors

If [Color Mode] (→93) is set to [Happy], both still and motion pictures are clearer, with more vivid coloring.

## [Motion Deblur]

The camera automatically sets the optimum shutter speed in accordance with the movements of the subject to minimize the blur of the subject.

### ■ Settings

- ① Press [MENU/SET]
  - ② Press **▲▼◀▶** to select [Rec] menu and press [MENU/SET]
  - ③ Press **▲▼** to select [Motion Deblur] and press [MENU/SET]
  - ④ Press **▲▼** to select [ON] and press [MENU/SET]
- When [Motion Deblur] is set to [ON], **☺** appears on the screen.
  - The subject may be recorded in a picture size smaller than the number of pixels that has been set.

## [iHandheld Nite Shot]

If a night scene is detected automatically while the camera is handheld, the camera can record the still picture with less jitter and less noise by combining a burst of pictures.

### ■ Settings

- ① Press [MENU/SET]
  - ② Press **▲▼◀▶** to select [Rec] menu and press [MENU/SET]
  - ③ Press **▲▼** to select [iHandheld Nite Shot] and press [MENU/SET]
  - ④ Press **▲▼** to select [ON] and press [MENU/SET]
- The recordable area becomes slightly narrower.

### ■ Recording

- ① Press the shutter button halfway
  - ② Press the shutter button fully
- Do not move the camera while any messages are displayed on the screen.
- When the camera is fixed in place on a tripod or by other means, [iHandheld Nite Shot] will not be identified.

# Taking pictures with automatic settings

## [Intelligent Auto] Mode (Continued)

Recording Mode: 

### AF Tracking

This function enables the camera to continue to focus on the subject and adjust the exposure of the subject even when the subject is moving.

#### ■With cursor button operations

##### 1 Press **▲** to set [AF Mode] to AF Tracking

- To cancel AF Tracking → Press **▲** again.

##### 2 Align the AF Tracking frame with the subject, and then press **▼** to lock

- To cancel AF Lock → Press **▼**.



AF Tracking frame  
AF Lock successful: Yellow  
AF Lock failed: Red (flash)

#### ■With touch panel operations







Perform these operations with the touch shutter function (→ 24) released.

##### 1 Touch the subject

- When switching to lock on to another subject → Touch the other subject.
- To release AF tracking → Touch .

- The optimal scene for the AF locked subject is automatically identified.
- Face Recognition will be inactive while using AF Tracking.
- Under certain recording conditions, such as when the subject is small or when it is dark, [AF Tracking] may not operate correctly.

## [Intelligent Auto] Mode restrictions

- Only menu items which are displayed in the [Intelligent Auto] Mode can be set.
- The settings selected in the [Program AE] or other modes are reflected for not displayed menu items on the [Setup] menu.
- The settings for the following items are different from other recording modes: [Picture Size] and [Color Mode] on the [Rec] menu, [Burst], and [Beep] on the [Setup] menu
- The settings for the following functions are fixed:
  - [Auto Review]: [2 SEC.]
  - [Guide Line]: 
  - [Quality]:  (Fine)
  - [Stabilizer]: [ON]
  - [AF Assist Lamp]: [ON]
  - [Metering Mode]:  (Multiple)
  - [i.Resolution]: [i.ZOOM]
  - [Active Mode]: [ON]
  - [Sleep Mode]: [5 MIN.]
  - [White Balance]: [AWB]
  - [Sensitivity]:  180
  - [AF Mode]:  (Face Detection)\*
  - [Quick AF]: [ON]
  - [i.Exposure]: [STANDARD]
  - [Red-Eye Removal]: [ON]
  - [Continuous AF]: [ON]
- \*  (23-area-focusing) when face cannot be recognized
- The following functions cannot be used: [Histogram], [Exposure], [Auto Bracket], [WB Adjust.], [Digital Zoom], [Min. Shtr Speed]

# Taking motion pictures

Recording Mode: **iA P A S M MS1 MS2 SCN**

Enables motion pictures to be recorded with (stereo) audio.



## 1 Press motion picture button to start recording

[Rec Mode] (→96)/[Rec Quality] (→97)



Elapsed recording time

Remaining recording time (approx.)

- Immediately release the motion picture button after pressing it.
- You can also use zoom while recording motion pictures.
  - The zoom speed will be slower than normal.
  - When using zoom while recording motion pictures, it may take some time to focus.
- Still pictures can be taken during motion picture recording. (→99)

## 2 Press the motion picture button again to end recording

## ■ Recording motion pictures in P

Records a motion picture at your preferred settings.

- Aperture and shutter speed are automatically set.

## ■ Recording motion pictures in iA

The camera automatically detects the scene to record motion pictures with optimal settings.

iA When scene does not correspond to any on the right.		

- In mode, focus and exposure will be set according to the face detected.
- will be selected for nightscapes and other dark scenes.
- If the camera does not select your desired Scene Mode, choosing an appropriate mode manually is recommended.
- The following menu options in the [Motion Picture] menu can be set:
  - [Rec Mode] • [Rec Quality]

## ■ Motion picture recording in other recording modes

For details, refer to the pages relating to the respective recording modes. (However, a motion picture cannot be recorded in [3D Photo Mode] mode)

- An AVCHD motion picture can be recorded continuously for up to 29 minutes 59 seconds when [GFS] or [FSH] is set.
- If [Rec Quality] is set to [GFS] or [FSH], and if the surrounding temperature is high, or motion picture is recorded continuously, is displayed, and the recording may be stopped halfway through.
- If data is repeatedly recorded and deleted, the total available recording time on the SD card may be reduced. To restore the original capacity, use the camera to format the SD card. Be sure to save all important data to your computer or other media before formatting, as all data saved to the card will be erased.
- The Optical Image Stabilizer functions regardless of the settings before a motion picture is recorded.
- The following functions are not available:  
AF tracking, Extended Optical Zoom, flash, [Face Recog.], [Rotate Disp.] for pictures taken vertically.
- For certain memory cards, recording may end while in progress.
- The screen can become narrower in motion pictures compared to still pictures. Also, if the Aspect Ratio is different for still pictures and motion pictures, the angle of view will change when starting to record a motion picture. The recordable area is displayed by setting [Rec Area] (→44) to [ON].
- If Extended Optical Zoom was used before pressing the motion picture button, these settings will be cleared, and the recordable area will be larger.
- Depending on the environment when recording motion pictures, the screen may turn black for an instant or noise may be recorded because of static electricity, electromagnetic waves, etc.
- When recording motion pictures using an AC adaptor, if you unplug the AC adaptor or a power outage occurs, power to the camera is cut, and the motion picture in progress will not be recorded.

# Viewing your pictures [Normal Play]

Playback Mode: 

When a card is in the camera, pictures are played back from the card, and without a card, pictures are played back from the built-in memory.

## 1 Drag your finger across the screen, and select the picture to be played back



Scrolling to the next picture: Drag your finger across the screen from right to left.

Returning to the previous picture: Drag your finger across the screen from left to right.

- If you keep your finger touching the left or right edge of the screen after scrolling the pictures, the pictures will continue to be scrolled.  
(The pictures are displayed in a reduced size.)

- The pictures can also be scrolled by pressing the ◀ ▶ cursor button. When the buttons are held down, the pictures can be scrolled quickly forward or backward.

## 2 View pictures





Picture number/Total pictures

Location name information and latitude & longitude information are provided

Folder/File number

### ■ Changing recording information display

Press the [DISP.] button.

- Some pictures edited on a computer may not be able to be viewed on this camera.
- If the REC/PLAY switch is moved from  to  while the power is on, the lens barrel will be retracted after approx. 15 seconds.
- This camera is compliant with the unified DCF (Design rule for Camera File system) standard formulated by the Japan Electronics and Information Technology Industries Association (JEITA), and with Exif (Exchangeable image file format). Files that are not DCF-compliant cannot be played back.



## Viewing motion pictures

### 1 Select a picture with the motion picture icon, and press ▲

Playback now starts.



Motion picture recording time

When playback starts, the elapsed playback time is displayed in the top right of the screen.

Example: After 10 minutes and 30 seconds: [10m30s]

Motion picture icon (differs depending on the recording mode and picture quality setting)

### ■ Operations during motion picture playback

▲: Pause/play

▼: Stop

◀: Fast rewind (2 steps)

Single-frame rewind (while paused)

▶: Fast forward (2 steps)

Single-frame forward (while paused)

- If ▲ is pressed during fast forward or rewind, it will return to normal playback speed.
- Volume can be adjusted with zoom lever.

- It may not be possible to play back properly the motion pictures recorded using other cameras.
- Some information will not be displayed for motion pictures recorded in [AVCHD].
- Motion pictures can be viewed on your computer using "PHOTOfunSTUDIO" on the supplied CD-ROM or "QuickTime".

# Viewing your pictures [Normal Play] (Continued)

Playback Mode: 

## Zooming in and viewing “Playback Zoom”

### 1 Touch the area that you want to magnify

Each time you touch, the magnification increases through four levels after 1x, 2x, 4x, 8x, and 16x. (The picture quality displayed becomes successively lower.)

- The area can also be magnified by turning the zoom lever toward T.

### 2 Drag your finger over the screen to move the position of the area magnified

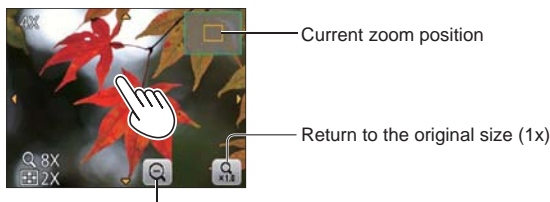

Reducing the display magnification rate

- The magnification rate can also be reduced by turning the zoom lever toward W.
  - The position of the area magnified can also be moved by operating the cursor button.
- Playback zoom cannot be used during motion picture playback.

## Viewing a list of pictures “Multi Playback”

### 1 Set to multiple screen display



Picture no./Total no.



Slide bar (drag this to change display)

- When the zoom lever is repetitively turned to W, the display method changes from a 12-picture screen to a 30-picture screen, and to Calendar Playback. (Turn the zoom lever toward T to return.)
- When a picture is touched on the 12-picture or 30-picture screen, the picture touched is displayed on the 1-picture screen (full-screen).

## Viewing pictures by their recording date “Calendar Playback”

**1** Turn the zoom lever toward W several times

**2** Touch the recording date to be displayed, and touch [Set] to enter the date

Select the month



The pictures recorded on the selected date appear on the 12-picture screen.

- The recording date can also be selected by using the cursor button, and press [MENU/SET].
- Only months when pictures were taken are shown on the calendar screen. Pictures taken without clock settings are displayed with the date January 1st, 2011.
- Pictures displayed with [!] cannot be played back.
- Pictures taken with destination settings made in [World Time] are displayed in the calendar screen using the appropriate date for the destination's time zone.

# Deleting pictures

Playback Mode: 

Pictures will be deleted from the card if the card is inserted, or from the built-in memory if the card is not inserted. (Deleted pictures cannot be recovered.)

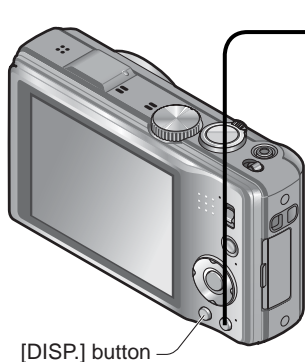

## 1 Press to delete displayed picture



- A confirmation screen is displayed. Select [Yes] with cursor button and then press [MENU/SET].

- Do not turn off the power during deletion.
- Use a sufficiently charged battery or an AC adaptor (optional) and DC coupler (optional).
- Pictures cannot be deleted in the following cases:
  - Protected pictures
  - Card switch is in "LOCK" position.
  - Pictures not of DCF standard (→32)

## To delete multiple (up to 100)/To delete all pictures

A burst group is handled as one picture. (All the pictures in the selected burst group are deleted.)

(after step 1)

### 2 Use cursor button to select [Delete Multi]/[Delete All] and press [MENU/SET]



#### ● [Delete Multi]

Use cursor button to select picture and press [DISP.] button



 Picture selected

- To cancel → Press [DISP.] button again.
- To execute → Press [MENU/SET].

- You can select [All Delete Except★] in [Delete All] if there are pictures that have been set as [Favorite] (→112).
- A confirmation screen is displayed. Select [Yes] with cursor button and then press [MENU/SET].
- May take time depending on number of pictures deleted.

# Setting the menu

## ■ About the menu screen



### Buttons used in menu operations

- Ⓐ: [MENU/SET]
- Ⓑ: Cursor button
- Ⓒ: [Back / Right] button

### Menu screen configuration

- Ⓓ: Menu description
- Ⓔ: Menu items
- Ⓕ: Operation guide

## ■ Menu operation flow

Displaying the menu screen

Selecting the menu type

Select the item

Changing the settings

Exiting the menu screen

Refer to the procedure example below when operating menus.

### Example: Changing [AF Mode] in the [Rec] menu in [Program AE] Mode

#### 1 Press [MENU/SET]

The menu selection screen is displayed.

#### 2 Select [Rec] menu and press [MENU/SET]

- The menu type can also be selected by touch operations.



#### 3 Press ▲▼ to select [AF Mode] and press [MENU/SET]

Ⓒ: Pages

The pages can also be selected with the zoom lever.

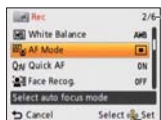

#### 4 Press ▲▼ to select a setting, and then press [MENU/SET]

The selected setting is set.

- To cancel → Press [⏪ / ⏩] button.

Ⓗ: Settings

①: Selected setting



#### 5 Press [⏪ / ⏩] button several times

The menu closes and the monitor returns to the previous screen.

- The operation screen examples in this manual may differ from the actual screen display or some parts of the screen display are omitted.
- The menu types and items that are displayed vary according to the mode.
- The setting methods vary depending on the menu item.
- In Recording Mode, the menu screen can also be exited by pressing the shutter button halfway.

## Setting the menu (Continued)

### Menu type

**[Rec] menu** (REC/PLAY switch: )

**Changing picture preferences** (→85)

- Displays settings such as White Balance, Sensitivity, Aspect Ratio, and Picture Size.

**[Motion Picture] menu** (REC/PLAY switch: )

**Recording motion pictures using your own settings** (→96)

- You can select the picture quality, data format (recording mode) and other settings.

**[GPS] menu** (REC/PLAY switch:  )

**Using the GPS function** (→75)

- You can select the GPS setting, location name display and other settings.

**[Setup] menu** (REC/PLAY switch:  )

**Making the camera more convenient to use** (→42)

- Displays settings for ease of use such as adjusting the clock and changing the beep sounds.

**[Playback Mode] menu** (REC/PLAY switch: )

**Viewing recorded pictures** (→102)

- Choose a playback mode to see Slide Shows or to narrow down the pictures for display, etc.

**[Playback] menu** (REC/PLAY switch: )

**Using your pictures** (→105)

- Enables you to specify picture protection, resizing, and other settings for pictures you have taken.

- The following menu is also displayed depending on the recording mode.
  - In the Scene Mode: Scene menu (→61)
  - In the custom mode: Custom menu (→60)



## Using Quick menu





















During recording, you can easily call some of the menu items and set them.

- 1** Press [Q.MENU] button ( [🗑️] / [↵] ) button
- 2** Press ◀▶ to select a menu item
- 3** Press ▲▼ to select the settings
- 4** Press [MENU/SET]









● The menu items and setting items that are displayed differ depending on the recording mode.

## Using the [Setup] menu



[Clock Set], [Economy] and [Auto Review] are important for clock setting and battery life. Please check these before use.

Item	Settings, notes
 <b>[Clock Set]</b> (→18)	Set time, date, and display format.
 <b>[Auto Clock Set]</b> Setting the clock automatically using GPS. (→81)	[ON]/[OFF]
 <b>[World Time]</b> Set the local time at travel destination. (→83)	 <b>[Destination]:</b> Set the local time at travel destination.  <b>[Home]:</b> Set date and time at home area.
 <b>[Travel Date]</b> Record the number of days elapsed in your travels. (→82)	<b>[Travel Setup]</b> <b>[SET]</b> (Register departure and return dates)/[OFF]
	<b>[Location]</b> <b>[SET]</b> (Input name of location)/[OFF]
 <b>[Beep]</b> Change or mute the beep/shutter sounds.	<b>[Beep Level]</b>  /  /  /  : Low/High/Mute
	<b>[Beep Tone]</b>  ① /  ② /  ③ : Change beep tone.
	<b>[Shutter Vol.]</b>  /  /  : Low/High/Mute
	<b>[Shutter Tone]</b>  ① /  ② /  ③ : Change shutter tone.

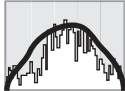

For details about the setting procedure in the [Setup] menu (→38)

Item	Settings, notes
 <b>[Volume]</b> Adjust volume of sound from speakers (7 levels).	<b>[0] / [1] / [2] / [3] / [4] / [5] / [6]</b> <ul style="list-style-type: none"> <li>• Cannot be used to adjust TV speaker volume when connected to TV.</li> </ul>
 <b>[Cust.Set Mem.]</b> Register settings on current camera. (→60)	<b>[C1] / [C2] / [C3]</b>
 <b>[LCD Mode]</b> Make LCD monitor easier to see.	 <b>[Auto Power LCD]:</b> The brightness is adjusted automatically depending on how bright it is around the camera.   <b>[Power LCD]:</b> Makes screen brighter than normal (for outdoor use).  <b>[OFF]</b>  <ul style="list-style-type: none"> <li>• [Auto Power LCD] does not work in Playback Mode.</li> <li>• [Power LCD] returns to ordinary brightness if there is no operation for 30 seconds when recording. (Press any button to make brighter again.)</li> <li>• Because the picture shown on the LCD monitor screen emphasizes brightness, some subjects may look different than their actual appearance, but this will not affect the recorded picture.</li> <li>• Setting [LCD Mode] will reduce the number of pictures that can be recorded and recording time.</li> </ul>
 <b>[Guide Line]</b> Select recording information display and types of guidelines.	<b>[Rec. Info.]</b> <b>[ON]</b> (Display recording information with guide lines.) <b>[OFF]</b>  <b>[Pattern]</b>  /  : Change the patterns of guide lines. <ul style="list-style-type: none"> <li>• When [Intelligent Auto] Mode has been selected, only  is displayed. Also recording information and guidelines cannot be displayed simultaneously.</li> </ul>







## Using the [Setup] menu (Continued)

Item	Settings, notes
 <b>[Histogram]</b> Check brightness in picture on graph.	<p><b>[ON]/[OFF]</b></p> <p>A peak in the center represents correct brightness (correct exposure). This can be used as a reference for exposure correction, etc.</p> <p>(Example)</p>  <p>Dark ← OK → Bright</p> <ul style="list-style-type: none"><li>• Histogram from time of recording is different to Histogram in playback and displayed in orange, when recording with flash or in dark locations. Also, Histogram may differ from Histograms made with image editing software.</li><li>• Not displayed during <b>[IA]</b> ([Intelligent Auto] Mode), [Photo Frame] or Playback Zoom.</li></ul>
 <b>[Rec Area]</b> Enables verification of the recordable area for a motion picture before recording.	<p><b>[ON]/[OFF]</b></p> <ul style="list-style-type: none"><li>• Recordable area displayed for motion pictures should be interpreted as a Guideline.</li><li>• When using Extended Optical Zoom, the recordable area may not always be displayed for certain zoom ratios.</li><li>• This setting cannot be used with [Intelligent Auto] Mode.</li></ul>
 <b>[Zoom Resume]</b> Remember the zoom position when turning the power off.	<p><b>[ON]/[OFF]</b></p> <ul style="list-style-type: none"><li>• Cannot be set when using [Self Portrait] Scene Mode.</li></ul>





For details about the setting procedure in the [Setup] menu (→38)

Item	Settings, notes
<p><b>ECO [Economy]</b></p> <p>Turn off the power or make the LCD monitor go dark while not using the camera to minimize battery consumption.</p>	<p> <b>[Sleep Mode]</b> <b>[2 MIN.]/[5 MIN.]/[10 MIN.]/[OFF]:</b> Automatically shut off power while not in use.</p> <ul style="list-style-type: none"><li>• To restore → Press the shutter button halfway, or turn on the power again.</li><li>• Cannot be used in the following cases: When using AC adaptor (optional) and DC coupler (optional), when connected to computer/printer, during motion picture recording/playback, during Slide Shows, during automatic demo playback</li><li>• Settings fixed to [5 MIN.] in [Intelligent Auto] Mode.</li></ul> <p> <b>[LCD Power Save]</b> <b>[ON]/[OFF]:</b> The LCD monitor goes dark to minimize power consumption.</p> <ul style="list-style-type: none"><li>• Reduces the picture quality of the LCD monitor display during recording to minimize battery consumption (except for the Digital Zoom area). Note, however, that there is no effect on the recorded picture.</li><li>• The setting in [LCD Mode] is prioritized over the setting in [LCD Power Save] for the brightness of the LCD monitor.</li></ul>
<p> <b>[Auto Review]</b></p> <p>Automatically display still pictures immediately after taking them.</p>	<p><b>[1 SEC.]/[2 SEC.]</b> <b>[HOLD]:</b> Auto review screen remains until a button (other than the [DISP.] button) is pressed</p> <p><b>[OFF]</b></p> <ul style="list-style-type: none"><li>• Fixed to [2 SEC.] in [Intelligent Auto] Mode.</li><li>• In [Panorama Assist], [Handheld Night Shot], [Flash Burst], and [Photo Frame] Scene Modes, or in [Auto Bracket], and [Burst] Mode, Auto Review performed regardless of setting.</li><li>• Motion pictures cannot be automatically reviewed.</li></ul>







## Using the [Setup] menu (Continued)

Item	Settings, notes
 <b>[No.Reset]</b> Reset picture file numbers.	<ul style="list-style-type: none"> <li>• The folder number is updated and the file number starts from 0001.</li> <li>• A folder number between 100 and 999 can be assigned. Numbers cannot be reset once folder number reaches 999. In this case, save all necessary pictures to your computer, and format the built-in memory/card (→48).</li> <li>• To reset folder number to 100: First, format the built-in memory or card, and reset the file numbers using [No.Reset]. Then, select [Yes] on the folder number reset screen.</li> </ul>
 <b>[Reset]</b> Reset to the default settings.	<p><b>[Reset Rec. settings?]</b></p> <p><b>[Reset setup parameters?]</b></p> <ul style="list-style-type: none"> <li>• Information registered in [Face Recog.] is reset if recording settings are reset.</li> <li>• Resetting the setup parameters will also reset the following. Age in years/months and names in [Baby] and [Pet] Scene Modes, [GPS] menu</li> <li>• Folder numbers and clock settings will not be reset.</li> <li>• Camera movement may be audible as the lens function is reset. This is not a fault.</li> </ul>
 <b>[USB Mode]</b> Select communication method for when connecting camera to a computer or printer with USB connection cable.	<p> <b>[Select on connection]:</b>            Select [PC] or [PictBridge (PTP)] each time you connect to a computer or PictBridge-compatible printer.</p> <p> <b>[PictBridge (PTP)]:</b> Select when connecting to a PictBridge-compatible printer.</p> <p> <b>[PC]:</b> Select when connecting to a computer.</p>

For details about the setting procedure in the [Setup] menu (→38)



Item	Settings, notes
 <b>[Output]</b> Change the settings to be used when the camera is connected to a TV or other device.	 <b>[TV Aspect]</b> (Operates when AV cable is connected.)  <b>16:9 / 4:3</b>
 <b>[VIERA Link]</b> Enable automatic linking with other VIERA Link-compatible devices, and operability with a VIERA remote control when connecting via an HDMI mini cable (optional) (→116).	<b>[ON]:</b> Operations may be performed via the remote control of the VIERA Link-compatible device. (Not all operations will be available.) Operability of the camera's own buttons will be limited. <b>[OFF]:</b> Operations must be performed via the camera's own buttons.
 <b>[3D Playback]</b> Set how 3D still picture is output.	<b>[3D]/[2D]</b> <ul style="list-style-type: none"><li>• If you want to play back a picture in 2D (conventional picture) on a 3D television, set to [2D].</li><li>• This item of the menu functions when an HDMI mini cable (optional) is connected.</li><li>• For the procedure for playing back a 3D still picture (→119).</li></ul>

## Using the [Setup] menu (Continued)

Item	Settings, notes
<p> [Rotate Disp.]</p> <p>Automatically rotate portrait still pictures.</p>	<p> : Rotate Display is turned on.  : Rotate Display is turned on for TV output only.  <b>[OFF]</b></p> <ul style="list-style-type: none"> <li>• [Rotate Disp.] cannot be used with motion pictures.</li> <li>• Some pictures taken facing up or facing down may not be rotated automatically.</li> <li>• Pictures cannot be rotated during Multi Playback.</li> <li>• Will only be displayed rotated on computer if in Exif-compatible (→32) environment (OS, software).</li> </ul>
<p> [Version Disp.]</p> <p>Check the version of the camera firmware.</p>	<p>Current version is displayed.</p>
<p> [Format]</p> <p>Use when [Built-In Memory Error] or [Memory Card Error] appears, or when formatting the built-in memory or card.</p> <p><b>When a card/built-in memory is formatted, the data cannot be restored. Check the content of the card/built-in memory carefully before formatting.</b></p>	<ul style="list-style-type: none"> <li>• This requires a sufficiently charged battery, or an AC adaptor (optional) and DC coupler (optional). When formatting the built-in memory, remove the cards. (Only inserted card will be formatted if present; built-in memory will be formatted if no card is inserted.)</li> <li>• Always format cards with this camera.</li> <li>• <b>All protected pictures and other picture data will be deleted.</b></li> <li>• Do not turn off power or perform other operations during formatting.</li> <li>• Formatting the built-in memory may take several minutes.</li> <li>• Consult the dealer or your nearest Service Center if format cannot be successfully completed.</li> </ul>

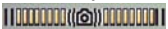
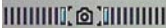

For details about the setting procedure in the [Setup] menu (→38)

Item	Settings, notes
 <b>[Calibration]</b> Perform these adjustments if something different from what was touched has been selected or if the camera did not respond when it was touched.	<ol style="list-style-type: none"> <li>① Press [MENU/SET].</li> <li>② Touch [+] which is displayed on the screen (in 5 places) in sequence using the stylus pen (supplied).</li> <li>③ Press [MENU/SET].               <ul style="list-style-type: none"> <li>• If the proper positions were not touched, the touch panel adjustments will not be performed. Touch the [+] places again.</li> </ul> </li> </ol>
 <b>[Language]</b> Change display language.	Set the language displayed on the screen.
<b>DEMO [Demo Mode]</b> View demonstration of functions.	<p><b>[Stabilizer Demo.]</b>            Extent of jitter is shown on graph (estimate)</p> <div style="display: flex; align-items: center; margin-bottom: 10px;">  <span style="margin-left: 10px;">Extent of jitter</span> </div> <div style="display: flex; align-items: center;">  <span style="margin-left: 10px;">Extent of jitter after correction</span> </div> <ul style="list-style-type: none"> <li>• During demo screen display, the Optical Image Stabilizer switches ON and OFF every time [MENU/SET] is pressed.</li> <li>• Cannot display during Playback Mode.</li> </ul> <p><b>[Auto Demo]:</b> View introductory Slide Show  <b>[ON]/[OFF]</b></p> <ul style="list-style-type: none"> <li>• [Auto Demo] cannot be displayed on external devices such as TVs.</li> </ul>

# Taking pictures with zoom

Recording Mode: **iA P A S M** MS1 MS2 SCN

You can zoom in up to 16 times with “Optical Zoom”, and up to 33.8 times with “Extended Optical Zoom” (pictures only) with lower picture quality. To zoom further, you can use [i.ZOOM] or [Digital Zoom].

## 1 Zoom In/Out

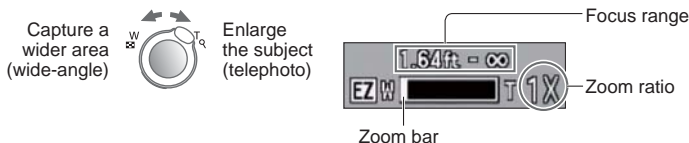

- The zoom speed can be set to one of 2 levels using the angle at which the zoom lever is turned.\*1

## Using the zoom by performing touch operations

### 1 Touch

The zoom lever appears on the screen.

### 2 Touch the T or W edge of the zoom lever on the screen

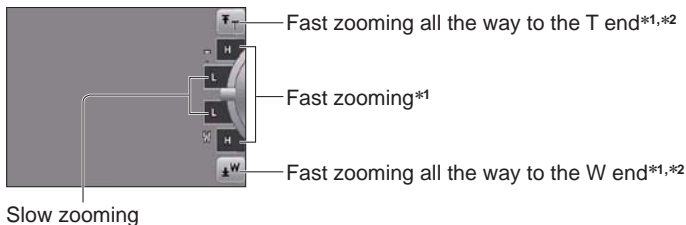

\*1 The zoom speed does not change during motion picture recording.

\*2 When or is touched again while zooming, zooming will stop.

- Adjust the focus after adjusting the zoom.
- Do not touch the lens barrel during zooming.
- The zoom ratio and the zoom bar displayed on the screen are estimates.
- The camera may make a rattling noise and vibrate when the zoom lever is operated - this is not a fault.

## Zoom types and use

The zoom ratio changes when the number of recording pixels is changed.



### ■ Optical Zoom

Zooming in up to 16 times is possible if pictures without  have been selected by [Picture Size] on the [Rec] menu. (→85)

### ■ Extended Optical Zoom

Zooming in up to 33.8 times is possible when pictures with  have been selected by [Picture Size] on the [Rec] menu. (→85) EZ is short for “Extended Optical Zoom.”



● Extended Optical Zoom cannot be used in the following cases:

- [Intelligent Auto] Mode (when [Motion Deblur] is [ON])
- [Macro Zoom] • Motion picture • When the [Burst] setting is set to  or 
- [Transform], [High Sens.], [Flash Burst], [Pin Hole], [Photo Frame] and [High Speed Movie] Scene Modes

To increase the zoom ratio further, the following zoom can be used in combination.



### ■ i.Zoom

The camera uses super resolution technology to increase the zoom ratio. Using super resolution technology, the zoom ratio can be increased up to about 1.3 times higher than the original zoom ratio with almost no deterioration of picture quality. (→92)

- When [i.Resolution] is set to [i.ZOOM], super resolution technology is applied to the picture.
- The i.Zoom functions in the following cases.
  - [Intelligent Auto] Mode (except when [Motion Deblur] is [ON])
  - Scene Modes (except for [Handheld Night Shot], [High Sens.], [Flash Burst], [Pin Hole])
- The [i.ZOOM] does not function when [Burst] is set (when  or  is set).

### ■ Digital Zoom

Zoom 4 times further than Optical/Extended Optical Zoom. Note that, with Digital Zoom, enlarging will decrease picture quality. Set the [Digital Zoom] in the [Rec] menu to [ON]. (→92)

- Digital Zoom cannot be used in the following modes:
  - [Intelligent Auto] Mode • When the [Burst] setting is set to  or 
  - Scene Modes ([Transform], [Handheld Night Shot], [High Sens.], [Flash Burst], [Pin Hole], [Film Grain], [Photo Frame] and [High Speed Movie])

# Taking pictures with flash

Recording Mode: **iA P A S M** MS1 MS2 SCN

- 1 Press **▶** to display [Flash]
- 2 Use cursor button to select the desired type and press **[MENU/SET]**

Type, operations	Uses
<b>[Auto]</b> • Automatically judges whether or not to flash	Normal use
<b>[Auto/Red-Eye]*1</b> • Automatically judges whether or not to flash (reduce red-eye)	Taking pictures of subjects in dark places
<b>[Forced Flash On]</b> • Always flash	Taking pictures with backlight or under bright lighting (e.g. fluorescent)
<b>[Forced On/Red-Eye]*1</b> • Always flash (reduce red-eye)	
<b>[Slow Sync./Red-Eye]*1</b> • Automatically judges whether or not to flash (reduce red-eye; slow shutter speed to take brighter pictures)	Taking pictures of subjects against a nightscape (tripod recommended)
<b>[Forced Flash Off]</b> • Never flash	Places where flash use is prohibited

\*1 Two flashes will be emitted. Do not move until after the second flash. Interval between flashes varies according to brightness of subject.

If [Red-Eye Removal] on the [Rec] menu is [ON], the appears with the flash icon, red-eye is automatically detected and still picture data is corrected. (Only when [AF Mode] is (Face Detection))

## ■ Available types in each mode (○: Available, -: Not available, : Default setting)

	iA	P	A	S	M	MS1	MS2	SCN	Movie	3D	Scene	HS
	○*2	○	○	○	○	○	○	○	-	-	-	-
	-	○	○	○	○	○	○	○	-	-	-	-
	-	○	○	○	○	○	○	○	-	-	○	○
	-	○	○	○	○	○	○	○	-	-	○	○
	○	○	○	○	○	○	○	○	○	○	-	○

\*2 Set to or depending on the subject and brightness.

- The flash cannot be used when recording motion pictures or 3D still pictures, Scene Modes or .

## ■ The available flash range when [Sensitivity] setting is [AUTO]

<b>Max. W</b>	Approx. 0.6 m-5.0 m (1.97 feet-16.4 feet)
<b>Max. T</b>	Approx. 1.0 m-2.8 m (3.28 feet-9.18 feet)

### ● Shutter speeds are as follows:

- : 1/60\*<sup>3</sup> - 1/4000th
- : 1\*<sup>3</sup>,\*<sup>4</sup> - 1/4000th

\*<sup>3</sup> Varies according to [Min. Shtr Speed] setting.

\*<sup>4</sup> When [Min. Shtr Speed] is set to [AUTO], and a jitter is detected when [Stabilizer] is turned to [ON], the maximum speed is 1/4 second. Also varies according to [Intelligent Auto] Mode and Scene Modes, etc.

### ● The effect of red-eye reduction varies depending on the subject and is affected by factors such as distance to the subject, whether the subject is looking at the camera during preliminary flash, and so on. In some cases, the effect of red-eye reduction may be negligible.

### ● Do not put your hands over the light-emitting area of the flash (→9) or look at it from close range (a few centimeters away). Do not use the flash at close distances to other subjects (heat/light may damage subject).

- Flash settings may be changed when changing Recording Mode.
- Scene Mode flash settings are restored to default when Scene Mode is changed.
- Edges of picture may become slightly dark if using flash at short distances without using zoom (close to max. W). This may be remedied by using a little zoom.
- No pictures may be taken if these marks (e.g. ) are flashing (flash is charging).
- Insufficient light may prevent appropriate exposure or White Balance.
- Flash charging may take time if battery is low, or if using flash repeatedly.

# Taking close-up pictures

Recording Mode: **P A S M 3D**

When you want to enlarge the subject, setting to [AF Macro] (AF $\downarrow$ ) enables you to take pictures at an even closer distance than the normal focus range (up to 3 cm (0.10 feet) for max. W).

**1** Press  $\blacktriangledown$  to display [Macro Mode]

**2** Use cursor button to select [AF Macro] and press [MENU/SET]



AF $\downarrow$  display

■ Taking close-up pictures without standing close to subject (TELE $\downarrow$  “Tele macro” function)

“Tele macro” operates automatically when zoom ratios are close to the maximum T setting. The focus can be aligned for distances as close as 1 m (3.28 feet). (AF $\downarrow$  changes to TELE $\downarrow$ )

## [Macro Zoom]

To take even larger images of the subject, setting to [Macro Zoom] enables the subject to appear even larger than when using [AF Macro].

**1** Press  $\blacktriangledown$  to display [Macro Mode]

**2** Use cursor button to select [Macro Zoom] and press [MENU/SET]

**3** Adjust the Digital Zoom magnification with the zoom lever

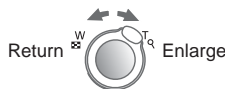

The zoom position is fixed at the Wide end.

Focus range is 3 cm (0.10 feet) -  $\infty$ .

Digital Zoom magnification (1 x to 3 x)

- In [Macro Zoom], higher magnification results in lower picture quality.
- When [Macro Zoom] is set, Extended Optical Zoom or [i.ZOOM] does not work.
- [Macro Zoom] cannot be set in [3D Photo Mode].
- When [AF Tracking] is set, zoom macro is canceled.

## Focus range

When a subject is too close to the camera, the picture may not be properly focused. The shortest recording distance differs depending on the zoom ratio and the setting in macro recording mode.

During optical zooming Zoom ratio (guideline)	Shortest recording distance*1	
	[Macro Mode] AF  *2	[Macro Mode] OFF*3
1x	3 cm (0.10 feet)	50 cm (1.64 feet)
2x	10 cm (0.33 feet)	50 cm (1.64 feet)
3x	20 cm (0.66 feet)	50 cm (1.64 feet)
4x	40 cm (1.32 feet)	50 cm (1.64 feet)
5x	1 m (3.28 feet)	1 m (3.28 feet)
6x	1.5 m (4.92 feet)	1.5 m (4.92 feet)
7x - 11x	2 m (6.57 feet)	2 m (6.57 feet)
12x - 15x	1.5 m (4.92 feet)	2 m (6.57 feet)
16x	1 m (3.28 feet)	2 m (6.57 feet)

\*1 The shortest recording distance is the distance from the lens front to the subject. This distance changes gradually depending on the zoom position.

\*2 The shortest recording distance is identical under the following settings.

- [Intelligent Auto] Mode
- [Food], [Candle Light], [Baby], [Pet], [High Sens.], [Flash Burst], [Pin Hole], [Film Grain], [High Dynamic], [Underwater], [High Speed Movie] in Scene Mode

\*3 The shortest recording distance is identical under the following settings.

- [Portrait], [Soft Skin], [Transform], [Panorama Assist], [Sports], [Party], [Sunset], [Starry Sky], [Beach], [Snow], [Photo Frame] in Scene Mode

- Ranges for focus alignment differ for Scene Modes.

- It may take some time until distant subjects come into focus.
- Using a tripod and [Selftimer] is recommended. Also, when recording a subject that is close to the camera, setting [Flash] to  [Forced Flash Off] is recommended.
- Moving the camera after aligning the focus is likely to result in poorly focused pictures if subject is close to the camera, due to the margin for focus alignment being severely reduced.
- Resolution may be reduced around the edges of the picture.

# Taking pictures with self-timer

Recording Mode: **iA P A S M MS1 MS2 SCN**

We recommend using a tripod. This is also effective for correcting jitter when pressing the shutter button, by setting the self-timer to 2 seconds.

- 1 Press ◀ to display [Selftimer]**
- 2 Use cursor button to select time duration and press [MENU/SET]**
- 3 Take a picture**  
Press the shutter button fully to start recording after the preset time.

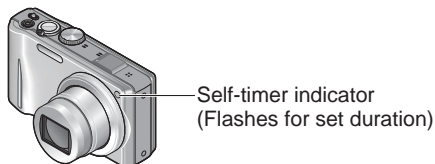

- To cancel while in operation → Press [MENU/SET]

- Focus will be automatically adjusted immediately before recording if shutter button is pressed fully here.
- After Self-timer indicator stops flashing, it may then be lit for AF Assist Lamp.
- This function cannot be used in the [Underwater] Scene Mode, or when recording motion pictures.
- [10sec.] cannot be chosen in Scene Mode [Self Portrait].



# Taking pictures with Exposure Compensation

Corrects exposure when adequate exposure cannot be obtained (if difference between brightness of object and background, etc.).

■ Recording Mode: **P** **A** **S** **MS1** **MS2** **SCN** **3D**

## 1 Press **▲** to display [Exposure]

## 2 Use cursor button to select a value and press [MENU/SET]



- If the picture is too dark, adjust the exposure to the “+” direction.
- If the picture is too bright, adjust the exposure to the “-” direction.
- After exposure adjustment, the adjustment value ( $\pm 2/3$  for example) is displayed in the bottom-left corner of the screen.
- The Exposure Compensation value you set is retained even after the camera is turned off.

- Depending on the brightness, this may not be possible in some cases.
- Exposure Compensation cannot be used with the [Starry Sky] Scene Mode.

## Recording while exposure is changed automatically ([Auto Bracket])

Records 3 pictures in continuous succession while exposure is changed automatically. After exposure adjustment, the adjustment value is set as the standard.

■ Recording Mode: **P** **A** **S** **M** **MS1** **MS2** **SCN**

## 1 Press **▲** several times to display [Auto Bracket]

## 2 Use cursor button to select a value and press [MENU/SET]

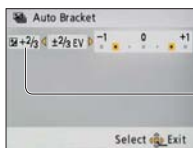

Value displayed after Exposure Compensation set

- The first still picture is recorded without compensation, the second still picture is recorded with exposure adjusted in the “-” direction, and the third still picture is recorded with exposure adjusted in the “+” direction.
- Canceled when the power is turned off.

- Cannot be used with flash.
- When [Auto Bracket] is set, [Burst] is canceled.
- Cannot be set in [Transform], [Panorama Assist], [Handheld Night Shot], [Flash Burst], [Starry Sky], [Pin Hole], [Film Grain], and [Photo Frame] Scene Modes or when recording motion pictures.

# Determine aperture and shutter speed and record

Recording Mode: **A S M**

## [Aperture-Priority] Mode

When recording, you can control the range of focus (depth of field) to meet your recording purposes.

Shutter speed is automatically adjusted to be appropriate for the set aperture value.

**1** Set mode dial to **A** ([Aperture-Priority] Mode)

**2** Press [EXPOSURE] button and use cursor button to determine aperture value

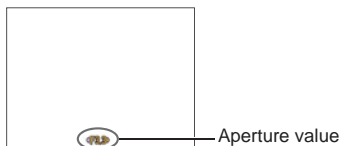

- When the aperture value is increased, the range of depth in focus expands, and the picture shows up clearly from the position of the camera to the background.
- When the aperture value is reduced, the range of depth in focus shrinks, and the background can get blurry.

**3** Press [EXPOSURE] button

## [Shutter-Priority] Mode

When recording, you can control the shutter speed to meet your recording purposes. Aperture is automatically adjusted to be appropriate for the set shutter speed.

**1** Set mode dial to **S** ([Shutter-Priority] Mode)

**2** Press [EXPOSURE] button and use cursor button to determine shutter speed

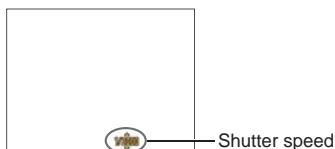

- At faster shutter speeds, movements by the subject show as if they are still.
- At slower shutter speeds, subjects that are moving show as jittery.

**3** Press [EXPOSURE] button

## [Manual Exposure] Mode

This mode of recording lets you set any aperture value and shutter speed when exposure adjustment prevents you from recording at the desired exposure (brightness/darkness). Also, long-exposure recording of up to 60 seconds is possible.

- 1 Set mode dial to M** ([Manual Exposure] Mode)
  - Manual exposure assist is displayed.

- 2 Press [EXPOSURE] button and use cursor button to determine aperture value and shutter speed**



Aperture value/shutter speed

- 3 Press [EXPOSURE] button**

### ■ Manual exposure assist (estimate)

If the shutter button is pressed halfway, manual exposure assist is displayed.

	Shows pictures with standard brightness.
	Shows brighter pictures. For standard brightness, either use a faster shutter speed or increase aperture value.
	Shows darker pictures. For standard brightness, either use a slower shutter speed or reduce aperture value.

### ■ Recording motion pictures in **A S M**

- Aperture and shutter speed are automatically set.
- When the picture is too bright or too dark or there is incorrect exposure, the numbers for the aperture value and shutter speed are shown in red.
- LCD monitor brightness may vary from the actual still picture recorded.

## Register your own settings and record

[Custom] Mode

Recording Mode: **CUST**

Registering your preferred Recording Mode, [Rec] menu settings, etc. to [Cust.Set Mem.] and setting the mode dial to CUST allows you to switch quickly to those settings.

### [Cust.Set Mem.]

Up to 3 current camera settings can be registered.

■ Recording Mode: **P A S M MS1 MS2 SCN**

- 1** Select the Recording Mode you wish to register and set the [Rec] menu, [Setup] menu, etc.
- 2** Select [Cust.Set Mem.] from the [Setup] menu (→43)
- 3** Use cursor button to select custom set for registration and press [MENU/SET]

- Self-timer is not stored in custom set.
- The following [Setup] menus are stored in custom set.
  - [Guide Line] • [Histogram] • [Rec Area] • [Zoom Resume] • [Auto Review]

### [Custom]

Settings registered in [Cust.Set Mem.] can be quickly called up by setting the mode dial to CUST.

- 1** Set mode dial to CUST (Custom Mode)
- 2** Use cursor button to select custom set and press [MENU/SET]

■ Recording motion pictures in **CUST**

Records motion pictures in registered Recording Mode.

- Even if [Rec] menu, etc. is changed in [Custom], the content of the custom set does not change. When changing registration content, reset in [Cust.Set Mem.].

## Taking pictures according to the scene

[Scene Mode]

Recording Mode: **MS1 MS2 SCN**

Using [Scene Mode] enables you to take pictures with optimum settings (exposure, coloring, etc.) for given scenes.

### 1 Set mode dial to SCN

### 2 Use cursor button to select the scene and press [MENU/SET]

(When the scene menu is not displayed →38)



### ■ Recording motion pictures in SCN

Records a motion picture at the optimum settings for the selected scene.

- Some scenes are switched to the following scenes:

Selected scene	Scenes for motion picture
[Baby]	Portrait motion picture
[Night Portrait], [Night Scenery], [Handheld Night Shot], [Starry Sky]	Low light motion picture
[Panorama Assist], [Sports], [Pet], [Flash Burst], [Fireworks], [Photo Frame]	Normal motion picture

- Selecting a Scene Mode inappropriate for the actual scene may affect the coloring of your picture.
- Following [Rec] menu settings will be automatically adjusted and cannot be selected manually.  
[Sensitivity], [Metering Mode], [i.Exposure], [Min. Shtr Speed], [i.Resolution], [Color Mode]

# Taking pictures according to the scene

[Scene Mode] (Continued)

Recording Mode: **MS1 MS2 SCN**

## [My Scene Mode]

You can register a commonly used Scene Mode in MS1MS2 on the mode dial. After the settings are made, pictures can be taken in the preset Scene Mode by simply setting the mode dial to MS1MS2.

- 1 Set mode dial to MS1MS2**
- 2 Use cursor button to select the scene and press [MENU/SET]**  
(If scene menu is not displayed →38)

### ■ Changing registered Scene Modes

Perform the registration operation again.



### ■ Recording motion pictures in **MS1 MS2**





Records motion pictures in registered Recording Mode.

### ● MS1 and MS2

Both represent the same function. Frequently-used scenes can be preset to each position so that you can quickly and easily switch to the desired Scene Mode.

- If recording settings are reset by [Reset] in the [Setup] menu, the preset Scene Modes are cleared.





 [Portrait]	<b>Improves the skin tone of subjects for a healthier appearance in bright daylight conditions.</b>  <b>Tips</b> <ul style="list-style-type: none"><li>• The closer the zoom is positioned to the T (telephoto) edge and the closer the camera is brought to the subject, the greater the effect will be.</li></ul>
 [Soft Skin]	<b>Smooths skin colors in bright, outdoor daylight conditions (portraits from chest upwards).</b>  <b>Tips</b> <ul style="list-style-type: none"><li>• The closer the zoom is positioned to the T (telephoto) edge and the closer the camera is brought to the subject, the greater the effect will be.</li></ul>
 [Transform]	<b>Changes the appearance of the subject by stretching the length or width, and at the same time, improves the skin appearances.</b>  ① Select the Transform level.  <b>Notes</b> <ul style="list-style-type: none"><li>• [Picture Size] will be fixed according to the [Aspect Ratio] setting, as detailed below. <b>4:3</b> : 3 M    <b>3:2</b> <b>1:1</b> : 2.5 M    <b>16:9</b> : 2 M</li></ul>

 [Self Portrait]	<p><b>Take pictures of yourself.</b></p>  <p><b>Tips</b></p> <ul style="list-style-type: none"><li>• Press shutter button halfway → self-timer indicator illuminates → press shutter button fully (if self-timer indicator flashes, focus is not correctly aligned)</li><li>• Use of the 2-second self-timer is recommended when the shutter speed is slow or jitter occurs easily.</li></ul>
 [Scenery]	<p><b>Takes clear pictures of wide, distant subjects.</b></p>
 [Panorama Assist]	<p><b>Use the supplied software to join multiple pictures into a single panorama picture.</b></p> <ol style="list-style-type: none"><li>① Use cursor button to select the recording direction, and press [MENU/SET] to set. Special panorama guidelines will be displayed.</li><li>② Take the picture.</li><li>③ Select [Next], and press [MENU/SET] to set.<ul style="list-style-type: none"><li>• Alternatively, press the shutter button halfway.</li><li>• You can take pictures again by selecting [Retake].</li></ul></li><li>④ Change the composition and take the picture so that a part of the picture overlaps with the previous picture.<ul style="list-style-type: none"><li>• To take more pictures, select [Next] and repeat steps ③ and ④.</li></ul></li></ol> <p>Section of picture that was taken last time</p> <ol style="list-style-type: none"><li>⑤ After you finish taking pictures, select [Exit], and press [MENU/SET] to set.</li></ol> <p><b>Tips</b></p> <ul style="list-style-type: none"><li>• Use a tripod.</li><li>• When it is dark, use the self-timer to record pictures.</li></ul> <p><b>Notes</b></p> <ul style="list-style-type: none"><li>• The focus, zoom, Exposure Compensation, White Balance, shutter speed, and ISO Sensitivity are all fixed at the setting for the first picture.</li><li>• Shutter speed may slow down up to 8 seconds.</li><li>• After recording, the shutter may stay closed (up to 8 seconds) to process the signal. This is not a malfunction.</li><li>• Panorama picture stitching cannot be performed by this camera. Use the software on the supplied CD-ROM "PHOTOfunSTUDIO" to make the pictures you record into a panorama still picture with your computer.</li></ul>





# Taking pictures according to the scene

[Scene Mode] (Continued)

Recording Mode:   

 [Sports]	<p><b>Takes pictures of scenes with fast movement, e.g. sports.</b></p> <p><b>Tips</b></p> <ul style="list-style-type: none"><li>• Stand at least 5 m (16.4 feet) away.</li></ul> <p><b>Notes</b></p> <ul style="list-style-type: none"><li>• Shutter speed may slow down up to 1 second.</li></ul>
 [Night Portrait]	<p><b>Takes pictures of people and nightscapes with close to actual brightness.</b></p> <p><b>Tips</b></p> <ul style="list-style-type: none"><li>• Use flash.</li><li>• Subject should not move.</li><li>• Tripod, self-timer recommended.</li></ul> <p><b>Notes</b></p> <ul style="list-style-type: none"><li>• Shutter speed may slow down up to 8 seconds.</li><li>• After recording, the shutter may stay closed (up to 8 seconds) to process the signal. This is not a malfunction.</li></ul>
 [Night Scenery]	<p><b>Takes clear pictures of night scenes.</b></p> <p><b>Tips</b></p> <ul style="list-style-type: none"><li>• Tripod, self-timer recommended.</li></ul> <p><b>Notes</b></p> <ul style="list-style-type: none"><li>• Shutter speed may slow down up to 8 seconds.</li><li>• After recording, the shutter may stay closed (up to 8 seconds) to process the signal. This is not a malfunction.</li></ul>
 [Handheld Night Shot]	<p><b>Takes clear pictures of night scenes without a tripod.</b></p> <p><b>Tips</b></p> <ul style="list-style-type: none"><li>• Stand at least 5 m (16.4 feet) away.</li><li>• After the shutter button has been pressed, do not move the camera during the burst operation.</li></ul> <p><b>Notes</b></p> <ul style="list-style-type: none"><li>• Since a burst of still pictures are combined after they have been recorded, it will be a few moments before you will be able to record another picture.</li></ul>
 [Food]	<p><b>Takes natural-looking pictures of food.</b></p>













 <b>[Party]</b>	<p><b>Brighten subjects and background in pictures of indoor events, such as weddings.</b></p> <p><b>Tips</b></p> <ul style="list-style-type: none"> <li>• Stand approx. 1.5 m (4.92 feet) away.</li> <li>• Zoom: Wide (W side)</li> <li>• Use flash.</li> <li>• Tripod, self-timer recommended.</li> </ul>
 <b>[Candle Light]</b>	<p><b>Brings out the atmosphere of a candlelit room.</b></p> <p><b>Tips</b></p> <ul style="list-style-type: none"> <li>• Do not use flash.</li> <li>• Tripod, self-timer recommended.</li> </ul> <p><b>Notes</b></p> <ul style="list-style-type: none"> <li>• Shutter speed may slow down up to 1 second.</li> </ul>
  <b>[Baby]</b>	<p><b>Uses weak flash to bring out skin colors.</b></p> <ul style="list-style-type: none"> <li>• To record age and name ([Baby1] and [Baby2] can be set separately.)             <ol style="list-style-type: none"> <li>① Select [Age] or [Name] with cursor button, press [MENU/SET], select [SET], and press [MENU/SET].</li> <li>② Set the birthday and name. Age: Set birthday with cursor button, and press [MENU/SET]. Name: (See "Entering Text": (→84))</li> <li>③ Use cursor button to select [Exit] and press [MENU/SET]</li> </ol> </li> </ul> <p><b>Tips</b></p> <ul style="list-style-type: none"> <li>• Make sure [Age] and [Name] are [ON] before taking a picture.</li> </ul> <p><b>Notes</b></p> <ul style="list-style-type: none"> <li>• Age display format depends on [Language] setting.</li> <li>• Shutter speed may slow down up to 1 second.</li> <li>• [Age] and [Name] print setting can be made on your computer using the supplied CD-ROM "PHOTOfunSTUDIO". Text may also be stamped onto the still picture using [Text Stamp].</li> </ul>
 <b>[Pet]</b>	<p><b>Records pet's age and name when taking pictures.</b></p> <ul style="list-style-type: none"> <li>• Refer to [Baby] for other tips and notes.</li> </ul>

# Taking pictures according to the scene

[Scene Mode] (Continued)

Recording Mode: **MS1** **MS2** **SCN**







 [Sunset]	Takes clear pictures of scenes such as sunsets.
 [High Sens.]	Prevents blurring of subject in dark, indoor conditions. Select the aspect ratio and the picture size with cursor button and press [MENU/SET].
 [Flash Burst]	Enables continuous recording in dim locations. ① Use cursor button to select the picture size and aspect ratio, and press [MENU/SET] to set. ② Take pictures (Hold shutter button). Still pictures are taken continuously while the shutter button is held down. Number of continuous shots: Max. 5 <b>Notes</b> <ul style="list-style-type: none"><li>• When [Selftimer] is set, 5 pictures are taken.</li><li>• The focus, zoom, Exposure Compensation, shutter speed, and ISO Sensitivity are all fixed at the setting for the first picture.</li></ul>
 [Starry Sky]	Takes clear pictures of starry skies or dark subjects.  • Shutter speed settings ① Select with cursor button and press [MENU/SET]. ② Press shutter button.  <b>Tips</b> <ul style="list-style-type: none"><li>• Always use a tripod.</li><li>• Self-timer recommended.</li><li>• Do not move the camera until the countdown has ended. (Countdown for processing is redisplayed afterwards)</li></ul>

 <b>[Fireworks]</b>	<p><b>Takes clear pictures of fireworks in the night sky.</b></p> <p><b>Tips</b></p> <ul style="list-style-type: none"> <li>• Stand at least 10 m (32.8 feet) away.</li> <li>• Tripod recommended.</li> </ul> <p><b>Notes</b></p> <ul style="list-style-type: none"> <li>• Shutter speed is fixed to 1/4 or 2 seconds. (Setting of shutter speed changes if exposure compensation is operated)</li> </ul>						
 <b>[Beach]</b>	<p><b>Brings out the clear blues of the sky and the sea without darkening subject.</b></p> <p><b>Notes</b></p> <ul style="list-style-type: none"> <li>• Do not touch camera with wet hands.</li> <li>• Beware of sand and sea water.</li> </ul>						
 <b>[Snow]</b>	<p><b>Brings out the natural color of snow in ski slope and mountain scenes.</b></p>						
 <b>[Aerial Photo]</b>	<p><b>Takes pictures of the view from aircraft windows.</b></p> <p><b>Notes</b></p> <ul style="list-style-type: none"> <li>• Turn the camera off when taking off or landing.</li> </ul>						
 <b>[Pin Hole]</b>	<p><b>Darkens the area around the screen for a retro effect.</b></p>						
 <b>[Film Grain]</b>	<p><b>Produces black and white pictures with a grainy texture.</b></p>						
 <b>[High Dynamic]</b>	<p><b>Reduces over- and underexposure when recording into the light and in night scenes.</b></p> <p><b>Use cursor button to select the effect and press [MENU/SET].</b></p> <table border="1" data-bbox="244 932 938 1028"> <tbody> <tr> <td>STD.</td> <td>Natural coloring effect</td> </tr> <tr> <td>ART</td> <td>An impressionistic effect emphasizing contrast and color</td> </tr> <tr> <td>B&amp;W</td> <td>Monochrome effect</td> </tr> </tbody> </table> <p><b>Notes</b></p> <ul style="list-style-type: none"> <li>• Shutter speed may slow down up to 8 seconds.</li> <li>• After recording, the shutter may stay closed (up to 8 seconds) to process the signal. This is not a malfunction.</li> </ul>	STD.	Natural coloring effect	ART	An impressionistic effect emphasizing contrast and color	B&W	Monochrome effect
STD.	Natural coloring effect						
ART	An impressionistic effect emphasizing contrast and color						
B&W	Monochrome effect						

# Taking pictures according to the scene

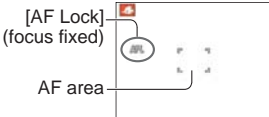
[Scene Mode] (Continued)

Recording Mode: **MS1 MS2 SCN**

 <p><b>[Photo Frame]</b></p>	<p><b>A frame is superimposed over the image.</b></p> <p>Use cursor button to select the frame, and then press [MENU/SET].</p> <p><b>Notes</b></p> <ul style="list-style-type: none"><li>• The recording pixel level is 2 M (4:3).</li><li>• Guide lines cannot be displayed.</li></ul>
 <p><b>[Underwater]</b></p>	<p><b>Achieve natural colors under water.</b></p> <p><b>Tips</b></p> <ul style="list-style-type: none"><li>• For fast moving subjects, align with the AF area and press ◀ (AF Lock). (Press ◀ again to release.)</li></ul>  <p>The diagram shows a rectangular frame with a red square in the top-left corner labeled "[AF Lock] (focus fixed)". Below it is a circle labeled "AF area". A line connects the AF area to the AF Lock label. To the right of the AF area are several small icons representing focus points.</p> <ul style="list-style-type: none"><li>• If the zoom is operated after AF Lock is set, the AF Lock setting will be canceled and must be set again.</li><li>• AF Lock cannot be set if [AF Mode] is set to .</li><li>• Adjust the coloring with "White Balance fine adjustment" (→87).</li></ul> <p><b>Notes</b></p> <ul style="list-style-type: none"><li>• <b>Always use marine case (optional).</b></li><li>• Positioning is not possible underwater, because the GPS signals cannot reach the camera.</li></ul>
 <p><b>[High Speed Movie]</b></p>	<p><b>Records rapid movements at a high speed of 220 fps.</b></p> <p>① Press the motion picture button to start recording ② Press the motion picture button again to finish recording</p> <ul style="list-style-type: none"><li>• Motion picture recording can also be started or finished by pressing the shutter button.</li><li>• During playback, the movements of a subject that cannot be seen by the naked eye can be made recognizable by playing back the motion pictures using slow motion.</li></ul> <p><b>Notes</b></p> <ul style="list-style-type: none"><li>• High-speed motion pictures cannot be recorded in the built-in memory.</li><li>• They are recorded in [QVGA] of [Motion JPEG] motion pictures. (up to 2 GB, about 7 minutes 20 seconds at one recording.)</li><li>• No sound is recorded.</li><li>• Still pictures cannot be recorded while high-speed motion pictures are being recorded.</li><li>• The settings for the focus, zoom, exposure and White Balance are fixed to the settings specified when recording was started.</li><li>• The Optical Image Stabilizer does not work.</li><li>• The [AF Mode] is set to  (1-area-focusing).</li><li>• Flickering or horizontal stripes may appear while recording under fluorescent lighting.</li></ul>

# Recording 3D still pictures [3D Photo Mode]

Recording Mode: **3D**

The camera continuously records multiple still pictures while being moved horizontally, and combines them into a 3D still picture. (The pictures are played back on the camera as 2D still pictures.)

To view 3D still pictures, you need a 3D-capable TV. For details on how to play back 3D still pictures (→119).

## 1 Set mode dial to **3D**

- The instructions on how to record pictures is displayed.

## 2 Record a picture so that the subject comes on the right side of the center

## 3 Slide this camera horizontally level from left to right while recording

- A guide is displayed while recording.
- By using the guide as a reference, slide the camera by approximately 10 cm (0.33 feet) in about 4 seconds.

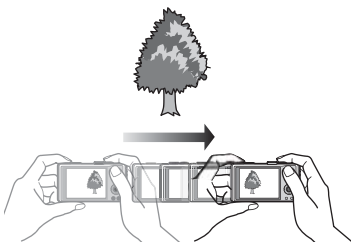

### Tips for recording pictures

- Record a stationary subject.
- Record a picture outdoors or in other bright locations.
- Press the shutter button halfway to fix the focus and the exposure, press the shutter button fully, and then slide the camera.

- 3D still pictures cannot be recorded by holding this camera vertically.
- 3D still pictures are recorded in MPO format (3D).
- The zoom position is fixed to the W end.
- The picture size is fixed to 2M **16:9**.
- ISO Sensitivity is automatically adjusted. However, ISO Sensitivity is increased to increase the shutter speed.
- Motion pictures cannot be recorded.
- When any of the recording conditions as listed below exists, the 3D effect may not be available even if a picture is recorded in 3D, or image may be distorted:
  - When the subject is too dark or its brightness changes
  - When the subject is moving
  - When pictures are recorded under water









# Burst function

Recording Mode:

A burst of still pictures can be recorded while the shutter button is pressed fully.

- 1 Select [Burst] from the [Rec] menu
- 2 Use cursor button to select the burst setting, and press [MENU/SET]

Setting	Speed	Description	No. of pictures										
	Approx. 2 - 10 pictures/sec.	<ul style="list-style-type: none"> <li>The burst speed is adjusted automatically in accordance with the movements of people, pets or other subjects. ([Intelligent Burst mode])</li> <li>This setting can be selected only in the [Intelligent Auto] Mode.</li> </ul>	100										
	Approx. 2 pictures/sec.	<ul style="list-style-type: none"> <li>The subject is brought into focus as far as this is allowed by the burst speed. The pictures are taken with the burst function while the exposure and White Balance are being adjusted. (However, when the burst function is operating during motion picture recording, the focus is fixed to the first picture.)</li> <li>The burst speed may be reduced under certain recording conditions.</li> </ul>	100										
	Approx. 5 pictures/sec.												
	Approx. 10 pictures/sec.	<ul style="list-style-type: none"> <li>Focus, exposure and White Balance are fixed in the first picture.</li> </ul>	15										
	40 pictures/sec.	<ul style="list-style-type: none"> <li>Focus, exposure and White Balance are fixed in the first picture.</li> <li>Number of recording pixels that can be set</li> </ul> <table border="1"> <thead> <tr> <th>[Aspect Ratio]</th> <th>[Picture Size]</th> </tr> </thead> <tbody> <tr> <td>4:3</td> <td>5M, 3M, 0.3M</td> </tr> <tr> <td>3:2</td> <td>4.5M, 2.5M, 0.3M</td> </tr> <tr> <td>16:9</td> <td>3.5M, 2M, 0.2M</td> </tr> <tr> <td>1:1</td> <td>3.5M, 2.5M, 0.2M</td> </tr> </tbody> </table>	[Aspect Ratio]	[Picture Size]	4:3	5M, 3M, 0.3M	3:2	4.5M, 2.5M, 0.3M	16:9	3.5M, 2M, 0.2M	1:1	3.5M, 2.5M, 0.2M	50
[Aspect Ratio]	[Picture Size]												
4:3	5M, 3M, 0.3M												
3:2	4.5M, 2.5M, 0.3M												
16:9	3.5M, 2M, 0.2M												
1:1	3.5M, 2.5M, 0.2M												
	60 pictures/sec.	<ul style="list-style-type: none"> <li>Focus, exposure and White Balance are fixed in the first picture.</li> <li>The recordable range is reduced.</li> <li>Number of recording pixels that can be set</li> </ul> <table border="1"> <thead> <tr> <th>[Aspect Ratio]</th> <th>[Picture Size]</th> </tr> </thead> <tbody> <tr> <td>4:3</td> <td>2.5M, 0.3M</td> </tr> <tr> <td>3:2</td> <td>3M, 0.3M</td> </tr> <tr> <td>16:9</td> <td>3.5M, 0.2M</td> </tr> <tr> <td>1:1</td> <td>2M, 0.2M</td> </tr> </tbody> </table>	[Aspect Ratio]	[Picture Size]	4:3	2.5M, 0.3M	3:2	3M, 0.3M	16:9	3.5M, 0.2M	1:1	2M, 0.2M	60
[Aspect Ratio]	[Picture Size]												
4:3	2.5M, 0.3M												
3:2	3M, 0.3M												
16:9	3.5M, 0.2M												
1:1	2M, 0.2M												
[OFF]	—	The burst function is released.	—										

- Pictures taken with the  or  setting are recorded together as a group (burst group). (→99)
- Depending on changes in the brightness of the subject, the second and subsequent pictures may be recorded brighter or darker when using the burst function at the ,  or  setting.
- Burst speed may be reduced if shutter speed is reduced in darker locations.
- The pictures taken using the burst function at the  or  setting may be distorted if the subjects were moving or the camera was moved.
- [Auto Bracket] is released.
- The flash is set to  [Forced Flash Off].
- Settings will be stored even if power is turned off.
- Burst is not available in the Scene Modes [Panorama Assist], [Handheld Night Shot], [Flash Burst], [Starry Sky], [Fireworks], [Pin Hole], and [Photo Frame].
- When [Selftimer] is set, 3 pictures are taken.
- It may take a while to store still pictures that were taken using the burst function.

# Recording with the Face Recognition function

[Face Recog.]

Recording Mode: **IA** **P** **A** **S** **M** **MS1** **MS2** **SCN**

## ■ How the Face Recognition function works

### During recording

(When [AF Mode] is  (Face Detection))

- The camera recognizes a registered face and adjusts focus and exposure.
- When registered faces that have set names are recognized, the names are displayed (up to 3 people).



### During playback

- The name and age are displayed (if information is registered).
- During recording, the names that have been set for the recognized faces are displayed (up to 3 people).
- Only pictures of the selected registered people are played back ([Category Selection]).

## ■ Recording tips when registering face pictures

- Make sure the subject's eyes are open and mouth closed; have the subject face the camera directly, and make sure the outline of the face, the eyes and eyebrows are not hidden by hair.
- Make sure there are no heavy shadows on the face. (During registration, the flash is not used).

## ■ If the camera seems to have difficulty recognizing faces when recording

- Register additional pictures of the same person's face, indoors and outdoors or with different expressions or angles.
- Register additional pictures at the place you are recording.
- If a registered person is no longer recognized, re-register that person.

- 
- When Burst is performed, recording information relating to Face Recognition is put only on the first picture.
  - If you press the shutter button halfway, then point the camera at a different subject and record, recording information for a different person may be put on the picture.
  - Face Recognition does not work in the following cases:  
Motion picture recording, Scene Modes [Transform], [Panorama Assist], [Night Scenery], [Handheld Night Shot], [Food], [Flash Burst], [Starry Sky], [Fireworks], [Aerial Photo], [Film Grain], [Underwater]
  - Face Recognition searches for faces similar to those registered, but there is no guarantee it will always recognize these faces. In some cases, the camera cannot recognize or incorrectly recognizes even registered people depending on their expression or the environment.
  - Even if Face Recognition information is registered, pictures recorded when the name is [OFF] are not categorized for Face Recognition in [Category Selection].
  - **Even if Face Recognition information is changed, Face Recognition information for previously recorded pictures is not changed.**  
For example, if a name is changed, pictures recorded before the change are not categorized for Face Recognition in [Category Selection].
  - To change name information for pictures already recorded, perform a [REPLACE] (→114) in [Face Rec Edit].



Default [Face Recog.] setting is [OFF].

When the face pictures are registered, the setting will be [ON] automatically.

## Registering face pictures

Up to 6 people's face pictures can be registered along with such information as name and birth date.

You can facilitate Face Recognition by the way you register faces: for example, register multiple face pictures of the same person (up to 3 pictures in one registration).

**1** Select [Face Recog.] from the [Rec] menu (→38)

**2** Select [MEMORY] with cursor button and then press [MENU/SET]

**3** Select [New] with cursor button and then press [MENU/SET]  
• If 6 people are already registered, first delete a registered person. (→74)

**4** Record the face picture

- ① Align the face with the guide and record.
- ② Select [Yes] with cursor button and then press [MENU/SET].
  - If re-recording, select [No]
  - Faces of subjects other than people (e.g. pets) cannot be registered.
  - When [DISP.] button is pressed, an explanation is displayed.

**5** Use cursor button to select the item for editing and press [MENU/SET]

[Name]	① Select [SET] with cursor button and then press [MENU/SET] ② Enter the name (text input procedure: →84)
[Age]	Set the birth date. ① Select [SET] with cursor button and then press [MENU/SET] ② Use ◀▶ to select year, month and day, set with ▲▼, and press [MENU/SET]
[Focus Icon]	Change the icon that is displayed when the subject is in focus. ① Select the focus icon with cursor button and then press [MENU/SET]
[Add Images]	Up to 3 face pictures of the person can be registered. ① Select an unregistered frame and press [MENU/SET] <ul style="list-style-type: none"><li>• When a registered face picture is selected with cursor button a screen to confirm deletion is displayed. Select [Yes] to delete the face picture. (If only one picture is registered, it cannot be deleted.)</li></ul> ② Record the picture (Step 4 above.) ③ Press [🗑️] / [↵] button

## Recording with the Face Recognition function

[Face Recog.] (Continued)

Recording Mode:

### ■ To set the Face Recognition function to [OFF]

- ① Select [Face Recog.] from the [Rec] menu
- ② Select [OFF] with cursor button and then press [MENU/SET]

## Editing or deleting information about registered persons

Information about registered people can be edited or deleted.

### 1 Select the person or persons to be edited or deleted in step 3 (→73) and press [MENU/SET]

### 2 Use cursor button to select the item and press [MENU/SET]

[Info Edit]	Edit name or other registered information. (→73)
[Priority]	Set priority order for focus and exposure. ① Select the registration order with cursor button and then press [MENU/SET]
[Delete]	Delete information and face pictures of registered persons.

# Recording the place of recording with GPS

Recording Mode: **IA P A S M MS1 MS2 SCN 3D**

Before use, read "About GPS" (→7) and "User License Agreement for Location Name Data" (→145).

## What is GPS?

GPS is an abbreviation for Global Positioning System, which enables people to find their locations using GPS satellites.

Receiving signals that contain orbit information and time information from multiple satellites to calculate one's current location is referred to as "Positioning".

This camera can perform positioning when it receives signals from three or more GPS satellites.

## To ensure successful positioning

- When using the GPS, we recommend holding the camera still for a while with the GPS antenna facing upward in an outdoor location where you can see the entire sky.
- In the following types of locations, it may not be possible to correctly receive the signals from the GPS satellites. In such cases, positioning may not be possible, or significant positioning discrepancy may occur.
  - Indoors
  - Underground or underwater (when using a marine case)
  - In forests
  - When in a moving vehicle, such as a car or train
  - Near buildings or in valleys
  - Near high-voltage power lines
  - In tunnels
  - Near 1.5 GHz mobile phones, etc.
- Do not cover the GPS antenna with your hands or anything else.
- If you are carrying the camera during positioning, do not carry it in a metal carrier or similar container. Positioning cannot be performed when the camera is covered by a material such as metal.

# Recording the place of recording with GPS

(Continued)

Recording Mode:

## Using GPS

- 1 Select [GPS Setting] from the [GPS] menu (→38)
- 2 Use cursor button to select [ON] or and press [MENU/SET]
  - To cancel, select [OFF]

[GPS Setting]	Description
[ON]	Even when the camera's power is turned off, positioning is executed periodically.
	Positioning is executed only while the camera's power is on. (It is not executed while the camera's power is off.)
[INFO]	You can check the current reception status. (→78)

### ■Using in locations such as airplanes or hospitals

When [GPS Setting] is set to [ON], the GPS function operates even when the camera's power is off.

Electromagnetic waves from the camera can affect instruments and meters. During airplane takeoff and landing or in other restricted area, set [GPS Setting] to [OFF] or , then turn the camera's power off.

- If the GPS status indicator lights up periodically while the camera's power is off, [GPS Setting] is set to [ON].

For [GPS] menu setting procedures (→38)





### ■ When [GPS Setting] is set to [ON] or



In Recording Mode, an icon that indicates the positioning status is displayed on the LCD monitor.

When positioning is executed successfully, your current location is stored in the camera's memory, and the location name information appears on the screen.



Location name information

Icon	Time elapsed after successful positioning
	In last 5 minutes
	From 5 minutes to 1 hour ago
	From 1 hour to 2 hours ago
	More than 2 hours ago
	Positioning failed

- Even if GPS reception is good, it will take approximately 2 to 3 minutes to successfully execute positioning under the following conditions; when positioning is executed for the first time, or when positioning is executed after the camera is turned off with the [GPS Setting] set to  and then turned on again or when [GPS Setting] is set to [OFF].
- The information of the current location stored in the camera's memory is deleted at the following times. (The information recorded on the pictures during recording is not deleted.)
  - When [GPS Setting] is set to [OFF]
  - When [GPS Setting] is set to  and then the camera's power is turned off
  - When the setup settings are reset with [Reset]

### ■ Information recorded on pictures

- If the positioning is executed successfully, the following information is recorded on the still picture or the motion picture you recorded (except when [Rec Quality] is set to [FSH] or [SH]).
  - Latitude/longitude
  - Location name information (Country/region, province/state, city/borough/county, town/village, landmark)
-  appears when the picture is played back.

### ■ Location name information

- The location name information consists of location names and landmarks that are found via a search of the camera's database based on the latitude and longitude that were acquired in positioning, and the most appropriate items are displayed (Sometimes the nearest items are not displayed.)
  - If there are no location names or landmarks "----" is displayed even if positioning is successful. Even when "----" is displayed, in some cases location name information can be selected in [GPS Area Select] (→79).
  - In some cases, the landmark that you are looking for may not have been registered. Location name information, such as landmarks, is current as of December 2010. (Landmark types →149)
- The location name information (location name or landmark name) may be different from the official name.

# Recording the place of recording with GPS

(Continued)

Recording Mode: **iA P A S M MS1 MS2 SCN BD**

## Executing positioning immediately and updating your current location

If there is a discrepancy in the displayed information such as the location name or if positioning has failed, move to a place where the signals from the GPS satellite can be received more easily, and update the positioning.

### 1 Select [Repositioning] from the [GPS] menu

Positioning starts.

The GPS status indicator lights during positioning.

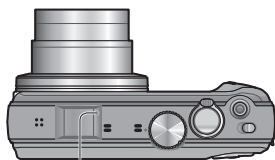

GPS status indicator

- When you select [GPS] or  in the [GPS Setting] displayed in the Quick menu (→41) and close the Quick menu, positioning will be executed.

### ■ Concerning the positioning intervals

Even if you do not manually update positioning, positioning is attempted automatically immediately after the power has been turned on and at a fixed intervals after that unless [GPS Setting] is [OFF].

When [GPS Setting] is [ON], positioning is tried at fixed time intervals even when the power is off.

However, positioning is canceled under the following conditions.

- When the battery power is low and  has appeared.
- When the power has not been turned on for a certain length of time.

### ■ To display the GPS reception status

① Select [GPS Setting] from the [GPS] menu.

② Use the cursor button to select [INFO] and press [MENU/SET].

- You can start positioning by pressing [MENU/SET] again.

● GPS reception status display

 : Received GPS time

 : Number of GPS satellite signals received

 : Latitude

Longitude

## Changing the recorded place name information

If there are other candidate locations for the positioning results, you can change the information to nearby place names or landmarks.

- When other place name information can be selected,  appears in front of the place name information.

- 1** Select **[GPS Area Select]** from the **[GPS]** menu
- 2** Use cursor button to select the item to change and press **[MENU/SET]**
- 3** Use cursor button to select the place name or landmark from the displayed candidates, and then press **[MENU/SET]**

### ■ If you do not wish to record place names and landmarks

In step **2**, select **[Delete all place-names]** and place names and landmarks will not be recorded.

Or, in step **3**, if you select **[Yes]** when a message asking whether to delete place names and landmarks lower than the selected place name, information of the place name will not be recorded (e.g., **[City/Town/Village]** and **[Landmark]** when **[County/Township]** is deleted).

- However, longitude and latitude will be recorded. If you do not wish to record them, turn **[GPS Setting]** to **[OFF]**.
- To return place names and landmarks set to not be recorded to the original setting (i.e., to record the place names and landmarks), perform **[GPS Area Select]** again.
- In large public parks or similar locations, landmarks may not be displayed, or incorrect landmarks may be displayed. If you cannot select the desired landmark in **[GPS Area Select]**, perform **[My Landmark]** (→80) before recording or **[Place-Name Edit]** (→107) after recording.

# Recording the place of recording with GPS (Continued)

Recording Mode: **iA P A S M MS1 MS2 SCN 3D**

## Registering your current location as a landmark

You can register a personal location that has not been registered in the camera as a landmark. The registered landmark can be displayed or recorded on the pictures. (Up to 50 landmarks)

First, move to the location that is to be registered, and operate the GPS where positioning can be executed.

- 1 Select [My Landmark] from the [GPS] menu**
- 2 Use cursor button to select [None] and press [MENU/SET]**
- 3 Use cursor button to select [Yes] and press [MENU/SET]**  
Positioning starts.
- 4 Press [MENU/SET]**
  - When positioning has failed  
→ Move to a location where positioning can be executed, then select [Yes] using cursor button and press [MENU/SET].
- 5 Input the landmark name** (Character input method →84)

### ■Editing or deleting registered landmarks

- ①Select the landmark which was registered in step 2 above, and press [MENU/SET].
- ②Select an item and press [MENU/SET].

[Edit]	This corrects the landmark name.
[Delete]	This deletes the registered landmark.



## Changing the display of location name information

The screen display of location name information found by positioning can be changed.

- 1** Select [Area Info. Set] from the [GPS] menu
- 2** Use cursor button to select the item for changing display and press [MENU/SET]
- 3** Use cursor button to turn items to be displayed [ON] and items not to be displayed [OFF], and then press [MENU/SET]

## Using GPS to set the clock

Using the date and time information in the GPS signal, the camera can automatically update its [Clock Set]. Also, after moving from your home area to one in a different time zone, the time is changed to the local time automatically when positioning is successful.

- 1** Select [Auto Clock Set] from the [Setup] menu
- 2** Use cursor button to select [ON] and press [MENU/SET]
- 3** Perform the operations from step **8** in “Setting the clock” (first time only) (→19)

- When [Auto Clock Set] is turned to [ON], [World Time] is set to [Destination].
- Time and date corrected by [Auto Clock Set] is not as accurate as radio clocks. If the time and date are not properly corrected, reset with [Clock Set].

# Useful features for travel

## [Travel Date]

If you set your travel schedule and record pictures, which day of your trip the picture was recorded will be recorded.

■ **Recording Mode:** \*

\* Recording only. (Cannot set.)

- 1** Select [Travel Date] from the [Setup] menu
- 2** Use cursor button to select [Travel Setup] and press [MENU/SET]
- 3** Use cursor button to select [SET] and press [MENU/SET]
- 4** Use cursor button to select the departure date and press [MENU/SET]
- 5** Use cursor button to select the return date and press [MENU/SET]

### ■ To record [Location]

Record your destination.

Once the [Travel Setup] is set, you can set the location.

- ① Select [Location] in step **2** above
  - ② Use cursor button to select [SET] and press [MENU/SET]
  - ③ Enter your location (Entering text →84)
- The travel date is calculated from the set departure date and the date set in the camera's clock. When destination is set in [World Time], days elapsed are calculated based on local destination time.
  - When [Travel Setup] is set to [OFF], the number of days elapsed is not recorded. It is not displayed even if [Travel Setup] is set to [SET] after recording.
  - If settings are made before the departure date, the number of days to departure are displayed in orange with a minus sign (but not recorded).
  - When [Travel Date] is displayed in white with a minus sign, the [Home] date is one day ahead of the [Destination] date due to the difference in time zones (this is recorded).
  - [Location] is recorded separately from the location name information which is recorded on the pictures by the GPS function.
  - To print [Location] or the number of days that have passed, either use [Text Stamp] or print using the software on the supplied CD-ROM "PHOTOfunSTUDIO".
  - [Travel Setup] and [Location] cannot be set for AVCHD motion pictures.

## [World Time]

Set the recording date and time with the local time at your destination.

■ Recording Mode: [A] [P] [A] [S] [M] [MS1] [MS2] [SCN] [3D]

### 1 Select [World Time] from the [Setup] menu

- Message will be displayed when setting for the first time. In this case, press [MENU/SET] and skip to step 3.

### 2 Use cursor button to select [Home] or [Destination] and press [MENU/SET]

### 3 Use cursor button to select area and press [MENU/SET]



When [Destination] has been selected

### ■ To set summer time

Press ▲ in step 3. (Press again to release the setting)

- When summer time is set, the current time is advanced by 1 hour. If the setting is canceled, the time automatically returns to the current time.
- If you cannot find your destination in the area displayed on the screen, set based on difference with home time.
- 🛩️ is displayed on the screen for pictures recorded at the destination when they are played back.
- When [Auto Clock Set] is set to [ON], only the summer time setting of [Destination] can be changed.

# Entering Text

Use the cursor button to enter names with the Face Recognition function and in Scene Modes [Baby] and [Pet], or to register locations in [Travel Date] etc.

## 1 Use cursor button to select characters

## 2 Press [MENU/SET] several times until the desired character is displayed



Text is inserted at the cursor position.

- To change the character type  
→ Select [ABC], and press [MENU/SET].

Cursor position

### ■ Editing text

- ① Use cursor button to move the cursor to text to edit.
  - You can also use the zoom lever to reposition the cursor.
- ② Use cursor button to select [Delete], and then press [MENU/SET].
- ③ Use cursor button to select the correct text, and then press [MENU/SET].

## 3 When you are finished entering text, use cursor button to select [Set] and press [MENU/SET]

- A maximum of 30 characters can be entered. (Maximum of 9 characters for [Face Recog.] names)

# Using the [Rec] menu

For [Rec] menu setting procedures (→38)

## [Aspect Ratio]

Aspect ratio of still picture can be changed according to printing or playback format.

■ Recording Mode: **P A S M** **MS1 MS2 SCN**

■ Settings: **4:3** / **3:2** / **16:9** / **1:1**

● Edges may be cut off when printing – be sure to check in advance.

## [Picture Size]

Set the size (number of pixels) of still pictures. Number of pictures which can be recorded depends on this setting and on [Quality].

■ Recording Mode: **IA P A S M** **MS1 MS2 SCN**

■ Settings:

Picture Size ([Aspect Ratio]: <b>4:3</b> )					
<b>14 M</b> 4320×3240	<b>10 M</b> <b>[Z]</b> * 3648×2736	<b>7 M</b> <b>[Z]</b> * 3072×2304	<b>5 M</b> <b>[Z]</b> 2560×1920	<b>3 M</b> <b>[Z]</b> * 2048×1536	<b>0.3 M</b> <b>[Z]</b> 640×480

Picture Size ([Aspect Ratio]: <b>3:2</b> )					
<b>12.5 M</b> 4320×2880	<b>9 M</b> <b>[Z]</b> * 3648×2432	<b>6 M</b> <b>[Z]</b> * 3072×2048	<b>4.5 M</b> <b>[Z]</b> * 2560×1712	<b>2.5 M</b> <b>[Z]</b> * 2048×1360	<b>0.3 M</b> <b>[Z]</b> * 640×424

Picture Size ([Aspect Ratio]: <b>16:9</b> )					
<b>10.5 M</b> 4320×2432	<b>7.5 M</b> <b>[Z]</b> * 3648×2056	<b>5.5 M</b> <b>[Z]</b> * 3072×1728	<b>3.5 M</b> <b>[Z]</b> * 2560×1440	<b>2 M</b> <b>[Z]</b> * 1920×1080	<b>0.2 M</b> <b>[Z]</b> * 640×360

Picture Size ([Aspect Ratio]: <b>1:1</b> )					
<b>10.5 M</b> 3232×3232	<b>7.5 M</b> <b>[Z]</b> * 2736×2736	<b>5.5 M</b> <b>[Z]</b> * 2304×2304	<b>3.5 M</b> <b>[Z]</b> * 1920×1920	<b>2.5 M</b> <b>[Z]</b> * 1536×1536	<b>0.2 M</b> <b>[Z]</b> * 480×480

\* This setting is not available in **IA** ([Intelligent Auto] Mode).

● Mosaic effect may appear depending on subject and recording conditions.

### Setting guide



Larger picture size	←→	Smaller picture size
Crisper picture		Coarser picture
Lower recording capacity		Higher recording capacity

## Using the [Rec] menu (Continued)

### [Quality]

Set quality of picture.

■ **Recording Mode:** **P A S M** MS1 MS2 SCN 3D

■ **Settings:**  High quality, priority to picture quality  
 Standard quality, priority to the number of pictures

- The setting is fixed to  in the following Scene Modes:  
[Transform], [High Sens.], and [Flash Burst]

### [Sensitivity]

Set ISO Sensitivity (sensitivity to lighting) manually.

We recommend higher settings to take clear pictures in darker locations.

■ **Recording Mode:** **P A S M**

■ **Settings:** [AUTO] / **I**ISO [Intelligent ISO] / [100] / [200] / [400] / [800] / [1600]

#### Setting guide

[Sensitivity]	[100] ←→ [1600]
Location (recommended)	Bright (outdoors) Dark
Shutter speed	Slow Fast
Interference	Low High
Subject blur	High Low

- [AUTO] is automatically set in a range up to 400 (1000 when flash is used) based on subject brightness.
- **I**ISO [Intelligent ISO] is automatically set in a range up to 1600 based on subject movement and brightness.

## [White Balance]

Adjust coloring to suit light source if colors otherwise appear unnatural.

■ **Recording Mode:** P A S M MS1 MS2 SCN 3D

■ **Settings:** [AWB] (automatic) / ☀ (outdoor, clear sky) / ☁ (outdoor, cloudy sky) /  
🏠 (outdoor, shade) / ⚡ (Incandescent lighting) /  
📺 (uses value set in 📺SET) / 📺SET (set manually)

- When [AWB] (Automatic White Balance) is set, the coloring is adjusted in accordance with the light source. However, if the scene is too bright or too dark or if other extreme conditions apply, the pictures may appear reddish or bluish. The White Balance may not operate correctly if there is a multiple number of light sources.
- We recommend setting to [AWB] or 📺SET when under fluorescent lighting.
- White Balance setting is fixed to [AWB] in the following Scene Modes: [Scenery], [Night Portrait], [Night Scenery], [Handheld Night Shot], [Food], [Party], [Candle Light], [Sunset], [Flash Burst], [Starry Sky], [Fireworks], [Beach], [Snow], [Aerial Photo], [Film Grain] and [Underwater]

### ■ White Balance fine adjustment (excluding [AWB])

White Balance settings can be individually fine tuned if colors still do not appear as anticipated.

- ① Select the white balance to be fine-tuned, and press the [DISP.] button to display the [WB Adjust.] screen.
- ② Adjust with ► if reds are strong, adjust with ◀ if blues are strong.
- ③ Press [MENU/SET].
  - Settings are remembered even if power is turned off.
  - Settings remain applied when using flash.
  - Even though the [AWB] setting is fixed in [Underwater] Scene Mode, fine adjustments may still be made.
  - Fine adjustments cannot be made when [Color Mode] (→93) is set to [B/W], [SEPIA], [COOL], or [WARM].

## Using the [Rec] menu (Continued)

### ■ Setting White Balance manually ( SET)

① Select  SET and press [MENU/SET].

② Point the camera towards a white object (e.g. paper) and press [MENU/SET].

White Balance is set to .

- Making this setting will reset White Balance fine adjustment.
- Even if the camera's power is OFF, the set White Balance is remembered.
- It may not be possible to set the correct White Balance if subjects are too bright or too dark. In this case, adjust the brightness and try to set the White Balance again.

### ■ [AWB] operational range:

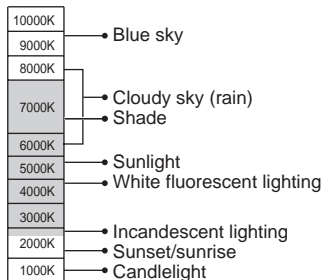









## [AF Mode]









Method of aligning focus can be changed according to position and number of subjects.

■ **Recording Mode:** **P A S M MS1 MS2 SCN 3D**

■ **Settings:**  /  /  /  / 

<p><b>Taking front-on pictures of people</b></p> <p> (Face Detection)</p>	<p>Recognizes faces (up to 15 people) and adjusts exposure and focus accordingly.</p> <p>AF area                      Yellow : When the shutter button is pressed halfway, the frame turns green when the camera is focused.                      White : Displayed when more than one face is detected. Other faces that are the same distance away as faces within the yellow AF area are also focused.</p>
<p><b>Automatically locking the focus on a moving subject</b></p> <p> (AF Tracking)</p>	<p>Touch the subject</p> <ul style="list-style-type: none"> <li>• Perform these operations with the touch shutter function (→24) released.</li> </ul> <p>AF Tracking frame                      When the subject is recognized, the AF Tracking frame changes from white to yellow, and the subject is automatically kept in focus. If AF Lock fails, a red frame flashes.</p> <ul style="list-style-type: none"> <li>• To release AF tracking → Touch .</li> <li>• Focus (same as macro recording) (→55)</li> </ul>
<p><b>Subject not centered in picture</b> (AF area not displayed until focused)</p> <p> (23-area-focusing)</p>	<p>Focuses on up to 23 points in each AF area.</p>
<p><b>Determined position for focus</b></p> <p> (1-area-focusing)   (Spot-focusing)</p>	<p>1-area-focusing: Focuses on AF area in center of picture.                      (Recommended when focus is difficult to align)                      Spot-focusing: Focuses on smaller, limited area.</p>

## Using the [Rec] menu (Continued)

- Focus is fixed to  (1-area-focusing) in the following cases:  
[Starry Sky], [Fireworks], [High Speed Movie] Scene Modes
- Use  (1-area-focusing) if focus is difficult to align with  (Spot-focusing).
- Cannot set to “Face Detection” in the following cases:  
[Panorama Assist], [Night Scenery], [Handheld Night Shot], [Food], [Aerial Photo], [Underwater] Scene Modes
- If the camera misinterprets a non-human subject as a face in the “Face Detection” setting, switch to another setting.
- If conditions prevent the face from being recognized, such as when the movement of the subject is too rapid, the [AF Mode] setting switches to  (23-area-focusing).
- Under certain recording conditions, such as when the subject is small or dark, AF Tracking may not operate correctly.
- When AF Tracking does not work, focus will be on  (23-area-focusing).
- Cannot set to  in the following cases.
  - [Panorama Assist], [Starry Sky], [Fireworks], [Pin Hole], [Film Grain], [High Dynamic] or [High Speed Movie] Scene Modes
  - [B/W], [SEPIA], [COOL], and [WARM] in [Color Mode]
- While recording motion pictures and the setting is other than , focus will be on  (1-area-focusing).

### [Quick AF]

The focus is automatically adjusted when camera blurring is small even when the shutter button is not pressed. (Increases battery consumption)

■ **Recording Mode:** **P A S M**    

■ **Settings:** [ON]/[OFF]

- Focus alignment may take time if zoom is suddenly changed from max. W to max. T, or if suddenly moving closer to subject.
- Press shutter button halfway if focus is difficult to align.
- The function will turn [OFF] in the following cases.  
In Scene Modes [Night Portrait], [Night Scenery], [Handheld Night Shot], [Starry Sky], [Fireworks] or [High Speed Movie]
- [Quick AF] will not work while AF Tracking is operating.

For [Rec] menu setting procedures (→38)

## [Face Recog.]

For details (→72).

## [Metering Mode]

You can change the position for measuring brightness when correcting exposure.

■ Recording Mode: **P A S M**

■ Settings:

	Brightness measurement position	Conditions
<input checked="" type="checkbox"/> <b>Multiple</b>	Whole screen	Normal usage (produces balanced pictures)
<input type="checkbox"/> <b>Center weighted</b>	Center and surrounding area	Subject in center
<input type="checkbox"/> <b>Spot</b>	Center and close surrounding area	Great difference between brightness of subject and background (e.g. person in spotlight on stage, backlighting)

## [i.Exposure]

Automatically adjusts contrast and exposure to give more lifelike colors when there is significant contrast between background and subject.

■ Recording Mode: **P A S M**

■ Settings: **[LOW]/[STANDARD]/[HIGH]/[OFF]**

- [LOW], [STANDARD] and [HIGH] indicate the maximum range of correction.
- When [i.Exposure] works, the color of **i** changes.
- Even if [Sensitivity] is set to [100], when [i.Exposure] is activated, pictures may be taken at a higher ISO Sensitivity than the setting.

## Using the [Rec] menu (Continued)

### [Min. Shtr Speed]

Sets shutter speed to minimum. We recommend using slower shutter speeds to take brighter pictures in dark locations.

■ **Recording Mode:** **P**

■ **Settings:** [AUTO] [1/250] [1/125] [1/60] [1/30] [1/15] [1/8] [1/4] [1/2] [1]

- Slower shutter speeds allow for brighter pictures but increase risk of jitter, so we recommend using a tripod and the self-timer.
- As still pictures may become dark when using faster values such as [1/250], we recommend that still pictures are taken in bright locations ( **⏻** flashes red when shutter button is pressed halfway if still picture will be dark).
- **⏻** displayed on screen for settings other than [AUTO].

### [i.Resolution]

Super resolution technology can be used to record still pictures with sharper outlines and clearer resolution. Also, when [i.ZOOM] is set, the zoom ratio can be increased to about 1.3 with almost no deterioration of picture quality.

■ **Recording Mode:** **P A S M**

■ **Settings:** [ON]/[i.ZOOM]/[OFF]

- About i.ZOOM (→51)
- The setting is fixed to [i.ZOOM] in [Intelligent Auto] Mode (except when [Motion Deblur] or [iHandheld Nite Shot] is set to [ON]).
- The setting is fixed to [ON] in [Handheld Night Shot] and [High Sens.] Scene Modes, [OFF] in [Flash Burst] and [Pin Hole] Scene Modes, and [i.ZOOM] in other Scene Modes.

### [Digital Zoom]

Multiplies effect of Optical Zoom or Extended Optical Zoom by up to 4 times.

■ **Recording Mode:** **P A S M MS1 MS2 SCN**

■ **Settings:** [ON]/[OFF]

- This is fixed to [ON] when [Macro Zoom] is set.

For [Rec] menu setting procedures (→38)

## [Burst]

For details (→70).

## [Color Mode]

Set color effects.

■ **Recording Mode:** **[IA] [P] [A] [S] [M]**

■ **Settings:** **[STANDARD]/[NATURAL]** (softer)/**[VIVID]** (sharper)/**[B/W]/[SEPIA]/[COOL]** (more blue)/**[WARM]** (more red)/**[Happy]** ([Intelligent Auto] Mode only)

- Set to [NATURAL] if there is excessive noise in the picture when recording in the dark.
- In [Intelligent Auto] Mode, only [STANDARD], [Happy], [B/W] or [SEPIA] can be set (these are set separately from other modes).

## [AF Assist Lamp]

Illuminates lamp when dark to facilitate focus alignment.

■ **Recording Mode:** **[P] [A] [S] [M] [MS1] [MS2] [SCN] [3D]**

■ **Settings:** **[ON]** : Lamp illuminated with halfway press of shutter button (**[AF-ON]** and larger AF area displayed)  
**[OFF]** : Lamp off (taking pictures of animals in dark, etc.)

- The AF Assist Lamp has an effective distance of 1.5 m (4.92 feet).
  - Do not block the lamp with your fingers or look at it from close range.
- The setting is fixed to [OFF] in the following Scene Modes: [Self Portrait], [Scenery], [Night Scenery], [Handheld Night Shot], [Sunset], [Fireworks], [Aerial Photo], [Underwater] and [High Speed Movie] Scene Modes



AF Assist Lamp



## Using the [Rec] menu (Continued)

### [Red-Eye Removal]

Automatically detects red-eye and corrects still picture data when recording with flash red-eye reduction (⚡A⊙ ⚡⊙ ⚡SO).

■ **Recording Mode:** P A S M [MS1] [MS2] SCN

■ **Settings:** [ON]/[OFF]

- This setting will work only when [AF Mode] is  (Face Detection).
- Depending on the circumstance, it may not be possible to correct red-eye.
- When the function setting is [ON], a  appears with the flash icon.

### [Stabilizer]

Automatically detects and prevents jitter.

■ **Recording Mode:** P A S M [MS1] [MS2] SCN

■ **Settings:** [ON]/[OFF]

- Setting fixed to [ON] during recording motion pictures, and in [Self Portrait] and [Handheld Night Shot] Scene Modes.
- In the [Starry Sky], [High Speed Movie] Scene Mode and [3D Photo Mode], the setting is fixed to [OFF].
- Cases where Optical Image Stabilizer may be ineffective:  
Heavy jitter, high zoom ratio (also in the Digital Zoom range), fast-moving objects, indoors or in dark locations (due to low shutter speed)

For [Rec] menu setting procedures (→38)

### [Date Stamp]

Still pictures can be taken with the recording date and time stamped on the still picture.

■ **Recording Mode:** P A S M MS1 MS2 SCN

■ **Settings:** [W/O TIME]/[WITH TIME]/[OFF]

- Date stamps on still pictures cannot be erased.
- The date cannot be stamped when [Auto Bracket] or [Burst] is set, in [3D Photo Mode], when recording a motion picture, or when [Panorama Assist] or [Flash Burst] Scene Mode is set.
- Do not request date printing in store or make date printing on printer for still pictures with date stamps. (Date printing may be overlapping.)

### [Clock Set]

Set the clock. Same function as that in [Setup] menu.



# Using the [Motion Picture] menu

## [Rec Mode]

Sets the data format of the motion picture that is recorded.

■ **Recording Mode:**        

■ **Settings:**

Recording format	Effect
 [AVCHD]	<ul style="list-style-type: none"><li>• This is a data format suitable for playback on high-definition TVs.</li><li>• The motion pictures on the card can be played back straight away by inserting the card into a device that supports AVCHD. For details, consult the instructions of the device used and find out what the device supports.</li></ul>
 [Motion JPEG]	<ul style="list-style-type: none"><li>• This data format is suited for playing back motion pictures on a computer and other such devices.</li></ul>

- Even when devices are compatible with motion pictures recorded with this camera, the playback may have poor picture or sound quality, or playback may not be possible. Also, the recording information may not be displayed properly. In this case, use this unit.

For details on AVCHD compatible devices, refer to the support sites below.

<http://panasonic.jp/support/global/cs/dsc/>

(This Site is English only.)



## [Rec Quality]

Sets the picture quality of the motion picture that is recorded.

■ **Recording Mode:** **[A]** **[P]** **[A]** **[S]** **[M]** **[MS1]** **[MS2]** **[SCN]**

■ **Settings:**

[AVCHD] in [Rec Mode]

Setting	Resolution	Bit rate* (average)	Aspect ratio
[GFS]	1920x1080	Approx. 17 Mbps	16:9
[FSH]			
[GS]	1280x720		
[SH]			

[Motion JPEG] in [Rec Mode]

Setting	Resolution	Number of frames per second	Aspect ratio
[HD]	1280x720	30 fps	16:9
[VGA]	640x480		
[QVGA]	320x240		4:3

\* The bit rate is the amount of data per unit time. A higher value translates into a higher image quality.

- About [GFS] and [FSH]
  - The number of frames is set to 60i (60 fps for the sensor output).
- About [GS] and [SH]
  - The number of frames is set to 60p (60 fps for the sensor output).
- The location information that was acquired in positioning is not recorded on motion pictures recorded in [FSH] or [SH].
- [QVGA] only can be recorded to the built-in memory.
- To play back AVCHD motion pictures recorded with this unit on Panasonic Blu-ray Disc Players (DMP-BD30/DMP-BD31/DMP-BD50) it is necessary to update the firmware of the Blu-ray Disc Player.  
You can download the latest firmware version from the following website.  
<http://panasonic.net/support/>

## Using the [Motion Picture] menu (Continued)

### [Active Mode]

This mode provides image stabilization for major jittering that occurs when recording motion pictures while walking.

- A stronger correction effect can be obtained when recording with the zoom set to the W end.

■ **Recording Mode:** **P A S M** MS1 MS2 **SCN**

■ **Settings:** **[ON]/[OFF]**

- The setting is fixed to [OFF] when [Rec Mode] is set to [Motion JPEG].

### [Continuous AF]

Either allow the focus to be constantly adjusted during motion picture recording, or fix the focus position at the start of recording.

■ **Recording Mode:** **P A S M** MS1 MS2 **SCN**

■ **Settings:** **[ON]**

**[OFF]:** Fix focus position at the start of motion picture recording.

- The setting is fixed to [OFF] in the following Scene Modes:  
[Starry Sky] and [Fireworks] Scene Modes

### [Wind Cut]

Reduces recording of wind sounds (wind noise) when recording in a strong wind.

■ **Recording Mode:** **P A S M** MS1 MS2 **SCN**

■ **Settings:** **[ON]/[OFF]**

- When [Wind Cut] is set to [ON], lower sounds will be eliminated and the sound quality will differ from that of normal recordings.

# Recording still pictures while a motion picture is being recorded

Recording Mode:

Still pictures can be recorded even while a motion picture is being recorded.

## 1 Press the shutter button fully during the motion picture recording

Still pictures with an aspect ratio of **16:9** and 3.5 mega pixels are recorded. (Max. 40 pictures)

Motion picture recording continues unchanged.

- The clicking sound made when the shutter button is operated may be recorded.
- When still pictures are recorded during zooming, the zooming may stop.

### ■ Burst function

When the burst function has been set in advance, a burst of still pictures can be recorded during motion picture recording.

- When or is selected as the burst setting, the still pictures are automatically recorded at the setting.
- Even at the or setting, the focus is fixed at the first picture.

- If the touch shutter function has been set, still pictures will be recorded if the touch panel has been touched inadvertently during motion picture recording.
- The camera will refocus if the shutter button is pressed halfway during motion picture recording or if still pictures are recorded using the touch shutter function. This refocus movement is recorded even during motion picture recording. When priority is to be given to the motion picture videos, press the shutter button fully, and record the still pictures. Still pictures can also be created after motion picture recording. (→100)
- When the shutter button is pressed halfway, the picture size and the number of recordable pictures are displayed.
- Still pictures cannot be recorded at the following cases:
  - When [Rec Quality] is set to [VGA] or [QVGA]
  - When recording [High Speed Movie]
- The flash is set to [Forced Flash Off].
- Since the electronic shutter is used for recording, the pictures recorded may be distorted.

# Editing motion pictures

Playback Mode: 

## Capturing still pictures from motion pictures

Save a scene from a motion picture as a still picture.

- 1 Display the picture that you want to capture as a still picture by pausing a motion picture during playback
- 2 Press [MENU/SET]

[Rec Quality] of the original motion picture	[Picture Size]	[Aspect Ratio]
[GFS] [FSH] [GS] [SH] [HD]	2M	16:9
[VGA] [QVGA]	0.3M	4:3

- The picture quality becomes slightly lower because of the [Rec Quality] setting of the original motion picture.
- It may not be possible to capture still pictures from motion pictures that were recorded with a different camera.

## Splitting up motion pictures

A single motion picture can be split into 2 parts. This is convenient when you want to keep just the necessary scenes, or if you wish to delete unnecessary scenes to increase free space on your card, such as when traveling.

- 1 Select [Video Divide] from [Playback] menu (→38)
- 2 Select the motion picture to split with cursor button and then press [MENU/SET]
- 3 Play back the motion picture and pause at the place to split
- 4 Press ▼ to decide the point to split the motion picture
  - Confirmation screen is displayed. If you select [Yes], the operation is executed.
  - **The original motion picture that was split does not remain.**  
(There will only be the 2 motion pictures that were created after the split.)

- During splitting, do not turn off the camera's power or remove the card or battery. If you do so, the motion picture may be deleted.
- Splitting a Motion JPEG motion picture will cause the order of pictures to change. It is recommended to display with [Calendar] (Calendar Playback) or [Filtering Play].
- Splitting an AVCHD motion picture will not cause the order of pictures to change.
- It may not be possible to split motion pictures that were recorded with a different camera.

## Playing back still pictures recorded using the burst function

Playback Mode: 

Pictures taken with the  or  setting are recorded together as a group (burst group).

### ■ Representative picture display

A representative picture (first burst picture) is displayed when it is displayed together with other still pictures or with motion pictures.

- All the still pictures in a burst group can be deleted or edited together.
- Continuous playback can be performed using the same operations as for motion pictures.
- When [Favorite] or [Print Set], for instance, has been set for only some of the still pictures in a burst group, the number of pictures set is displayed underneath the applicable icon.

### ■ Display within each burst group

Still pictures recorded by a single burst can be displayed separately or as a list.

1

#### Press ▼ while the representative picture is being displayed

The display within each burst group appears on the screen.

On the display within each burst group, only the series of burst still pictures are displayed.

- To return to the representative screen display → Press ▼.

### ■ Re-acquiring the burst group information

When pictures have been deleted or filenames changed using another device, for instance, by connecting it to a computer, the  (acquiring information icon) will appear the next time the camera's power is turned on.

While  is displayed, pictures cannot be deleted and the [Playback] menu cannot be used. Only [Normal Play] or [Calendar] is available as the playback mode.

- [Playback] menu items cannot be used while the display appears within each burst group.
- The burst pictures cannot be displayed as a burst group during [GPS Area Play] or [Favorite] playback using [Slide Show] or [Filtering Play].
- [Cropping] cannot be performed for the pictures in a burst group together.
- Burst pictures recorded after the total number of still pictures has exceeded 50,000 will not be grouped.  
If only one still picture is left over in a burst group after deletion or other operations, it will not be formed into a group, either.
- The burst pictures recorded by another device may not be recognized as burst group pictures.
- Burst pictures will not be grouped if recorded without setting the clock.

## Different playback methods [Playback Mode]

Playback Mode: 

Recorded pictures can be played back in a variety of ways.

- 1 Press [MENU/SET]
- 2 Use cursor button to select [Playback Mode] menu and press [MENU/SET]
- 3 Use cursor button to select the playback method and press [MENU/SET]

- When no card is inserted, pictures are played back from the built-in memory.
- The [Playback Mode] automatically becomes [Normal Play] when the REC/PLAY switch is set to  and the power is turned on, or when switching from Recording Mode to Playback Mode.

### [Slide Show]

Automatically play pictures in order and to music. Recommended when viewing on TV screen.

- 1 Use cursor button to select the playback method and press [MENU/SET]

[All]	Play all.
[Picture Only]	Plays back still pictures.
[Video Only]	Plays back motion pictures.
[3D Play]	Plays back only 3D still pictures that were recorded in [3D Photo Mode].
[GPS Area Play]	Selects place name or landmark to play back pictures recorded in the same place. (Use cursor button to select place name or landmark and press [MENU/SET]).
[Travel]	Play only pictures that were recorded with the [Travel Setup] or [Location].
[Category Selection]	Select category and playback still pictures only. (Select category with cursor button and press [MENU/SET].) (→104)
[Favorite]	Play back pictures set as [Favorite].

## 2 Use cursor button to set playback effects and press [MENU/SET]

[Effect] (Select music and effects according to picture atmosphere)	
[AUTO] (only available with [Category Selection] setting)/[NATURAL]/[SLOW]/[SWING]/[URBAN]/[OFF]*	
[Setup]	
[Duration]*	[1 SEC.] / [2 SEC.] / [3 SEC.] / [5 SEC.] (Only available when [Effect] is [OFF])
[Repeat]	[ON]/[OFF]
[Sound]	[AUTO]: With still pictures, music will play back, and with motion pictures, audio will play back. [Music]: Music effect will play back. [Audio]: Audio is played back from motion pictures. [OFF]: Music and audio will not play back.

\* If [Video Only] was selected in step 1, [Effect] is fixed at [OFF]. Also, the duration cannot be set.

## 3 Select [Start] with cursor button and press [MENU/SET]

### ■ Operations during Slide Show

During motion picture/burst group playback

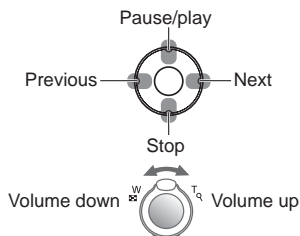

During still picture playback

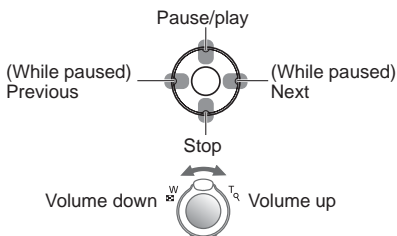

- When [URBAN] has been selected, the picture may appear in black and white as a screen effect.
- Part of [Effect] cannot be used when displaying pictures on television using an HDMI mini cable (optional) or when displaying pictures recorded in portrait position.
- Music effects cannot be added.

## Different playback methods [Playback Mode]































































(Continued)

Playback Mode: 

### [Filtering Play]

You can refine the selection of pictures to be viewed by narrowing them down to pictures in selected categories or to favorite pictures, and then view those pictures.

#### 1 Select the filtering method using cursor button, and press [MENU/SET]

[Picture Only]	Play back still pictures																				
[Video Only]	Play back motion pictures																				
[3D Play]	Play back only 3D still pictures that were recorded in [3D Photo Mode].																				
[GPS Area Play]	Select the location name of the place where the pictures were taken or the landmark name, and plays the pictures back. ① Select the region whose pictures are to be played back using cursor button, and press [MENU/SET]. ② Select the location name or landmark name using cursor button, and press [MENU/SET].																				
[Travel]	Play back pictures with [Travel Date] that have been set at the time of their recording. ① Select whether to play back the pictures by date or by travel location using cursor button, and press [MENU/SET]. <ul style="list-style-type: none"><li>• When [All] is selected, the pictures recorded with [Travel Date] are played back.</li></ul> ② Select the date or travel location using cursor button, and press [MENU/SET].																				
[Category Selection]	Play back pictures that have been narrowed down by category, such as Scene Mode. ① Select the category using cursor button, and press [MENU/SET]. <table border="1"><tr><td></td><td>Pictures taken using Face Recognition</td></tr><tr><td></td><td>[Portrait]/ /[Soft Skin]/[Transform]/[Self Portrait]/[Night Portrait]/ /[Baby]/ </td></tr><tr><td></td><td>[Scenery]/ /[Sunset]/ /[Aerial Photo]</td></tr><tr><td></td><td>[Night Portrait]/ /[Night Scenery]/ /[Handheld Night Shot]/ /[Starry Sky]</td></tr><tr><td></td><td>[Sports]/[Party]/[Candle Light]/[Fireworks]/[Beach]/ [Snow]/[Aerial Photo]</td></tr><tr><td></td><td>[Baby]/ </td></tr><tr><td></td><td>[Pet]</td></tr><tr><td></td><td>[Food]</td></tr><tr><td></td><td>[Underwater]</td></tr><tr><td></td><td>[Burst] () or () only</td></tr></table>		Pictures taken using Face Recognition		[Portrait]/  /[Soft Skin]/[Transform]/[Self Portrait]/[Night Portrait]/  /[Baby]/ 		[Scenery]/  /[Sunset]/  /[Aerial Photo]		[Night Portrait]/  /[Night Scenery]/  /[Handheld Night Shot]/  /[Starry Sky]		[Sports]/[Party]/[Candle Light]/[Fireworks]/[Beach]/ [Snow]/[Aerial Photo]		[Baby]/ 		[Pet]		[Food]		[Underwater]		[Burst] (  ) or (  ) only
	Pictures taken using Face Recognition																				
	[Portrait]/  /[Soft Skin]/[Transform]/[Self Portrait]/[Night Portrait]/  /[Baby]/ 																				
	[Scenery]/  /[Sunset]/  /[Aerial Photo]																				
	[Night Portrait]/  /[Night Scenery]/  /[Handheld Night Shot]/  /[Starry Sky]																				
	[Sports]/[Party]/[Candle Light]/[Fireworks]/[Beach]/ [Snow]/[Aerial Photo]																				
	[Baby]/ 																				
	[Pet]																				
	[Food]																				
	[Underwater]																				
	[Burst] (  ) or (  ) only																				
[Favorite]	Play back pictures set as [Favorite].																				

### [Calendar]

Select the date from the calendar screen to view only the pictures taken on that day. (→35)



# Using the [Playback] menu

Playback Mode: 

You can set the recorded picture to upload to the image-sharing websites, edit the picture (for example, trimming), and set a protection setting in the picture.

- For Playback menu display and operation methods (→38)
- Depending on the Playback Mode, some [Playback] menu items are not displayed.
- New pictures are created after editing pictures with tools such as [Text Stamp] and [Resize]. Before starting to edit, make sure that there is enough free space in the built-in memory or memory card.

## [Upload Set]

You can select pictures on the camera for uploading to image-sharing websites (Facebook or YouTube).

- Only still pictures can be uploaded to Facebook and only motion pictures can be uploaded to YouTube.
- Pictures on the built-in memory cannot be set. Copy pictures to a card (→115) before making [Upload Set] settings.

### 1 Use cursor button to select [SINGLE] or [MULTI], and then press [MENU/SET]

### 2 Select picture and make setting

#### ● [SINGLE]

Use cursor button to select picture and press [MENU/SET]



Web upload setting

#### ● [MULTI]

Use cursor button to select picture and press [DISP.] button



Web upload setting

- To cancel → Press [DISP.] button again.
- To execute → Press [MENU/SET].

### ■ Uploading to image-sharing websites

When setting [Upload Set], the built-in uploading tool automatically makes copies on the card inside the camera. Connect the camera to your computer (→124) before performing uploading operations. For more details, refer to (→126).

### ■ To clear all

Select [CANCEL] in step 1 and select [Yes].

- May not be compatible with pictures taken on other devices.
- Not available on cards with less than 512 MB.

# Using the [Playback] menu (Continued)

Playback Mode: 

## [Title Edit]

You can give titles, etc. to your favorite still pictures.

**1** Use cursor button to select [SINGLE] or [MULTI], and then press [MENU/SET]

**2** Select a still picture

● [SINGLE]

Use cursor button to select a still picture and press [MENU/SET]



● [MULTI]

(up to 100 pictures with the same text)

Use cursor button to select a still picture and press [DISP.] button



[Title Edit] setting

[Title Edit] already set

- To cancel → Press [DISP.] button again.
- To execute → Press [MENU/SET].

**3** Enter characters (Entering text (→84))

To delete a title, delete all the characters in the character input screen.

- Cannot be used with still pictures taken by other devices or motion pictures.
- To print text, use [Text Stamp] or the supplied CD-ROM "PHOTOfunSTUDIO".

## [Place-Name Edit]

You can edit location name or landmark name recorded by GPS function.

**1 Use cursor button to select the picture and press [MENU/SET]**

**2 Use cursor button to select [Candidate] and press [MENU/SET]**

Nearby location names and landmark names for the location information that are recorded on picture are searched.

**3 Use cursor button to select the item for editing and press [MENU/SET]**

**4 Select the location name or landmark name, and press [MENU/SET]**

### ■ Directly edit the name of the location or landmark

- ① Select [Direct] in step **2** above, and press [MENU/SET]
- ② Enter characters (Entering text (→84))

### ■ Apply the edited name of the location or landmark to other pictures

- ① Select [Repeat] in step **2** above, and press [MENU/SET]  
The name of the location or landmark that you previously selected or entered is displayed.
  - ② Confirm the location name or landmark name and press [MENU/SET]
- You cannot edit pictures recorded using a Panasonic digital camera (LUMIX) that supports GPS recording released in 2010 or earlier.

# Using the [Playback] menu (Continued)

Playback Mode: 

## [Text Stamp]

The recording date and time, location name information and the text registered in the [Baby], [Pet] Scene Modes, [Travel Date] and [Title Edit] are stamped on the still picture.

**1** Use cursor button to select [SINGLE] or [MULTI], and then press [MENU/SET]

**2** Select a still picture

● [SINGLE]

Use cursor button to select a still picture and press [MENU/SET]



● [MULTI] (up to 100 pictures)

Use cursor button to select a still picture and press [DISP.] button

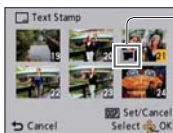

[Text Stamp] setting

- To cancel  
→ Press [DISP.] button again.
- To execute  
→ Press [MENU/SET].

**3** Use cursor button to select [Set] and press [MENU/SET]

**4** Use cursor button to select items and press [MENU/SET]

**5** Use cursor button to select settings and press [MENU/SET]

**6** Press  /  button



**7** Use cursor button to select [OK] and press [MENU/SET]

**8** Use cursor button to select whether to stamp age and press [MENU/SET]

- If [Name] is [OFF] in step **5**, this step will not be displayed.

For Playback menu display and operation methods (→38).

## ■ Items that can be stamped

[Shooting Date]	[W/O TIME]: Stamp recording date [WITH TIME]: Stamp recording date and time
[Name]	 : Stamp name registered in Face Recognition  /  : Stamp name registered in [Baby] or [Pet]
[Location]	Stamp location registered in [Setup] menu's [Travel Date]
[Travel Date]	Stamp Travel Date set in [Setup] menu's [Travel Date]
[Title]	Stamp text registered in [Title Edit]
[Country/Region]	Stamp place name information recorded by GPS function • If text such as the location name or landmark name is long, it may not be possible to stamp all the text.
[State/Prov./County]	
[County/Township]	
[City/Town/Village]	
[Landmark]	

- Items set to [OFF] are not stamped.
- Cannot be used with still pictures taken on other devices, still pictures taken without setting clock, motion pictures or still pictures with a [Text Stamp] applied.
- Characters may be cut off on certain printers.
- Text is difficult to read when stamped on pictures of 0.3M or less.
- **Do not request date printing in store or make date printing on printer for still pictures with date stamps. (Date printing may be overlapping.)**

## [Video Divide]

For details (→100).

# Using the [Playback] menu (Continued)

Playback Mode: 

## [Resize]

Picture size can be reduced to facilitate e-mail attachment and use in web pages, etc. (Still pictures recorded at the smallest recording pixel level cannot be further reduced.)

### ■[SINGLE]

- 1 Use cursor button to select [SINGLE] and press [MENU/SET]
- 2 Use cursor button to select a still picture and press [MENU/SET]
- 3 Use cursor button to select size and press [MENU/SET]

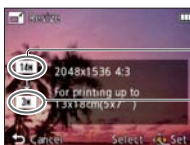

Current size

Size after change

- Confirmation screen is displayed. If you select [Yes], the operation is executed.

### ■[MULTI]

- 1 Select [MULTI] in step 1 above
- 2 Use cursor button to select size and press [MENU/SET]
- 3 Use cursor button to select a still picture and press [DISP.] button (up to 100 pictures)



Resize setting

Number of pixels before/after resizing

- To cancel  
→ Press [DISP.] button again.
- To execute  
→ Press [MENU/SET].

- Confirmation screen is displayed. If you select [Yes], the operation is executed.

- Picture quality is reduced after resizing.
- Cannot be used with motion pictures, and still pictures with text stamp or date stamp. May not be compatible with still pictures taken on other devices.

For Playback menu display and operation methods (→38).

## [Cropping]

Enlarge your still pictures and crop unwanted areas.

**1 Use cursor button to select a still picture, and then press [MENU/SET]**

**2 Select area to crop and press [MENU/SET]**



Expand



Change position

- Confirmation screen is displayed. If you select [Yes], the operation is executed.

- Picture quality is reduced after cropping.
- Cannot be used with motion pictures, and still pictures with text stamp or date stamp.  
May not be compatible with still pictures taken on other devices.
- Original Face Recognition information will not be copied when still pictures are cropped.

# Using the [Playback] menu (Continued)

Playback Mode: 

## [Favorite]

By labeling your favorite pictures with a star (★), you can play back your favorite pictures only, or you can delete all pictures except your favorites.

**1** Use cursor button to select [SINGLE] or [MULTI] and press [MENU/SET]

**2** Select picture

● [SINGLE]

Use cursor button to select picture and press [MENU/SET]



Favorite picture setting

● [MULTI]

Use cursor button to select picture and press [MENU/SET]

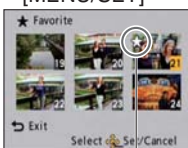

Favorite picture setting

- To cancel → Press [MENU/SET] again.

### ■ To clear all

Select [CANCEL] in step **1** and select [Yes].

### ■ To cancel while releasing all

Press [MENU/SET].

- It may not be possible to set pictures taken with certain other devices as favorites.



## [Print Set]

Picture/picture no./date printing settings can be made for when printing with DPOF print-compatible shops or printers. (Ask at shop to check compatibility)

For more information visit:

[http://panasonic.jp/dc/dpof\\_110/white\\_e.htm](http://panasonic.jp/dc/dpof_110/white_e.htm)

### 1 Use cursor button to select [SINGLE] or [MULTI] and press [MENU/SET]

### 2 Select picture

- [SINGLE]

Use cursor button to select picture and press [MENU/SET]

- [MULTI]

Use cursor button to select picture and press [MENU/SET]

### 3 Use cursor button to set number of pictures and press [MENU/SET]

(repeat steps 2 and 3 when using [MULTI] (up to 999 pictures))

- [SINGLE]



Date print set

No. to print

- [MULTI]



Date print set

No. to print

- Date print setting/release → Press [DISP.] button

#### ■ To clear all

Select [CANCEL] in step 1 and select [Yes].

- Depending on the type of printer, the printer settings may take priority over camera settings.
- Cannot be set for files that are not compliant with the DCF standard.
- Some DPOF information set by other equipment cannot be used. In such cases, delete all of the DPOF information and then set it again with this camera.
- Date print setting cannot be made for still pictures that have been taken with [Date Stamp] and pictures with a [Text Stamp] applied.
- Motion pictures recorded in [AVCHD] format cannot be set.

# Using the [Playback] menu (Continued)

Playback Mode:

## [Protect]

Set protection to disable picture deletion. Prevents deletion of important pictures.

**1 Use cursor button to select [SINGLE] or [MULTI] and press [MENU/SET]**

**2 Select picture**

● [SINGLE]

Use cursor button to select picture and press [MENU/SET]



Picture protected

● [MULTI]

Use cursor button to select picture and press [MENU/SET]

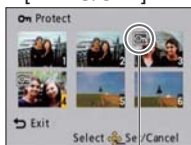

Picture protected

- To cancel → Press [MENU/SET] again.

### ■ To clear all

Select [CANCEL] in step **1** and select [Yes].

### ■ To cancel while releasing all

Press [MENU/SET].

- May not be effective when using other devices.

## [Face Rec Edit]

Edit or delete the recognition information for pictures with mistaken Face Recognition.

**1 Use cursor button to select [REPLACE] or [DELETE] and press [MENU/SET]**

**2 Use cursor button to select the picture and press [MENU/SET]**

**3 Use cursor button to select a person and press [MENU/SET]**

- If [DELETE], go to step **5**.
- People whose Face Recognition information has not been registered cannot be selected.

For Playback menu display and operation methods (→38).

#### **4 Use cursor button to select the person to replace for another and press [MENU/SET]**

#### **5 Use cursor button to select [Yes] and press [MENU/SET]**

- When Face Recognition information is deleted, it cannot be restored.
- Pictures for which all Face Recognition information has been deleted are not categorized in Face Recognition during [Category Selection].
- Recognition information cannot be edited in protected pictures.

### [Copy]

You can copy pictures between built-in memory and memory card.

#### **1 Use cursor button to select the copy method (direction) and press [MENU/SET]**



: Copy all pictures from built-in memory to card (go to step 3).

: Copy 1 picture at a time from card to built-in memory.

#### **2 Select picture with cursor button and press [MENU/SET]**

#### **3 Use cursor button to select [Yes] and press [MENU/SET]**

- To cancel → Press [MENU/SET].
- After all the pictures are copied from the built-in memory to the memory card, the display returns automatically to the playback screen.

- Copying pictures may take several minutes. Do not turn off power or perform other operations during copying.
- If identical names (folder/file numbers) are present in the copy destination, a new folder for copying will be created when copying from built-in memory to card () . Identically-named files will not be copied from card to built-in memory () .
- The following settings are not copied. Set them again after copying.  
- [Print Set] - [Protect] - [Favorite]
- Only pictures from Panasonic digital cameras (LUMIX) may be copied.
- Motion pictures recorded in [AVCHD] format cannot be set.

# Viewing on TV screen

You can view pictures on a TV screen by connecting your camera to your TV with the AV cable (supplied) or HDMI mini cable (optional).

- Also consult TV operating manual.

## Getting Ready:

- Set [TV Aspect]. (→47)
- Turn off both camera and TV.

### 1 Connect camera to TV

### 2 Turn on TV

- Set to auxiliary input.

### 3 Turn on camera

### 4 Set REC/PLAY switch to

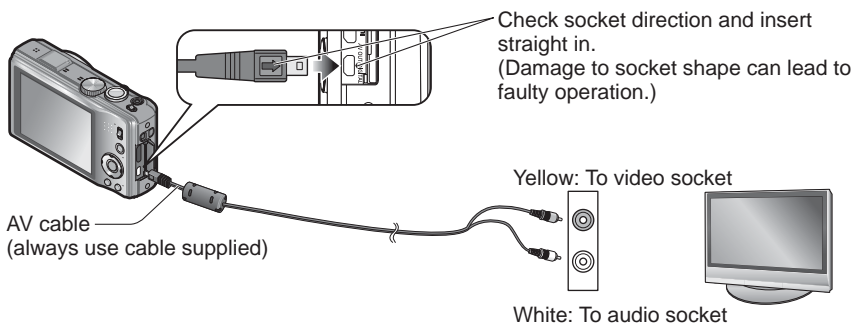

## ■ When TVs or DVD recorders have an SD card slot

Insert the SD Memory Card into the SD card slot

- AVCHD motion pictures can be played back on Panasonic televisions (VIERA) displaying the AVCHD logo.  
To play motion pictures on other televisions, please connect the camera to the television with the AV cable (supplied).
- When using both SDHC and SDXC Memory Cards, be sure to play each type of card in equipment compatible with the particular format.

- Do not use any other AV cables except the supplied one.
- Pictures rotated to portrait may be blurred slightly.
- Change picture mode settings on TV if aspect ratios are not displayed correctly on widescreen or high-definition televisions.

## Viewing on a TV with HDMI Socket

An HDMI mini cable (optional) can be used to enable viewing of still and motion pictures in high resolution.

**Preparation:** Turn off the camera and TV.

Check the socket direction and insert straight in.  
(Damage to socket can lead to faulty operation.)

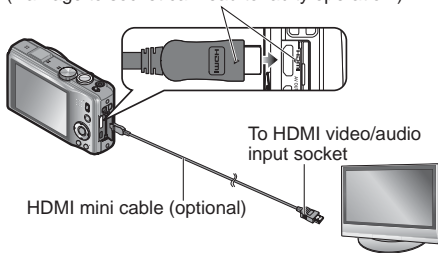

### 1 Connect camera to TV

### 2 Turn on TV

- Set to HDMI input.

### 3 Turn on camera

### 4 Set REC/PLAY switch to

- Do not use any other cables except a genuine Panasonic HDMI mini cable (optional).
- Some of the playback functions cannot be performed.
- [Playback], [GPS], and [Setup] menus cannot be used.
- Blank stripes may appear at the sides or at the top and bottom of the screen, depending on Aspect Ratio setting.
- Cables that do not comply with HDMI standards will not work.
- When an HDMI mini cable is connected, pictures are not displayed on the LCD monitor.
- HDMI output will be canceled if a USB connection cable is connected simultaneously.
- No picture output will occur through AV cables connected.
- Pictures may be momentarily distorted immediately after commencing playback or pausing on certain televisions.
- Audio output is stereo.

## Viewing on TV screen (Continued)

### VIERA Link (HDMI) (HDAVI Control™)

#### What is VIERA Link (HDMI)?

- VIERA Link™ is a new name for EZ Sync™.
- VIERA Link is a function that automatically links this camera to VIERA Link-compatible devices by connecting HDMI mini cables (optional) for enabling easy operation with the VIERA remote control. (Some operations are not available.)
- VIERA Link (HDMI) is an exclusive Panasonic function added to the industry-standard HDMI control functions known as HDMI CEC (Consumer Electronics Control). Operation is not guaranteed when connecting with non-Panasonic HDMI CEC-compatible devices. Refer to your product manual to verify compatibility with VIERA Link (HDMI).
- This camera supports VIERA Link (HDMI) Version 5. This is the latest Panasonic standard that also supports previous Panasonic VIERA Link devices. (As of December 2010)

- Do not use any other cables except a genuine Panasonic HDMI mini cable (optional).
- The shape of remote control will differ depending on the country or area where the TV was purchased.
- Cables that do not comply with HDMI standards will not work.
- If you are unsure whether or not the TV you are using is compatible with VIERA Link, read the operating instructions for the TV.
- If the [VIERA Link] setting on the camera is [ON], operations via the camera buttons will be limited.
- Ensure that the television you are connecting to has been set up to enable VIERA Link (HDMI) (consult your television operating instructions for details).

**Preparation:** Set [VIERA Link] to [ON] (→47).

- 1 Connect the camera to a VIERA Link (HDMI)-compatible Panasonic television (VIERA) with an HDMI mini cable (optional) (→117)**
- 2 Turn on camera**
- 3 Set REC/PLAY switch to **
- 4 Proceed with the operation while referring to what is displayed on the TV screen**
  - When operating, refer to the VIERA Link operating panel.

#### ■ Other related operations

- Power OFF  
The camera's power can also be switched off when switching the television's power off with the remote control.
- Automatic input select
  - This function automatically switches the television input to the camera screen whenever the camera's power is switched on while it is connected via the HDMI mini cable. The television can also be switched on via the camera from Standby Mode (if "Power on link" on the television is set to "on").
  - If VIERA Link (HDMI) does not function correctly (→139)

### Viewing 3D still pictures

If you connect this camera to a 3D-capable TV, and play back still pictures that you recorded in 3D, you can enjoy impressive 3D still pictures on the TV. If a 3D-capable TV has an SD card slot, you can play back 3D still pictures that you recorded by inserting the card into the slot.

<http://panasonic.jp/support/global/cs/dsc/> (This Site is English only.)

## Viewing on TV screen (Continued)

**Preparation:** Set [3D Playback] to [3D] (→47).

- 1 Connect the camera to a 3D-capable TV by use of an HDMI mini cable (optional) to display the playback screen** (→117)
- 2 Display still pictures recorded in 3D**  
[3D] appears on the thumbnail of the 3D still pictures.

### ■To select and play back only still pictures recorded in 3D

Select [3D Play] in [Filtering Play] of the Playback Mode (→104)

### ■To perform Slide Show playback of only still pictures recorded in 3D

Select [3D Play] in [Slide Show] of the Playback Mode (→102)

If you experience any ill effects, such as tiredness or sickness while viewing 3D-recorded still pictures, switch the playback type to 2D.

### ■The functions that are not operational or available for 3D still pictures:

- Playback Zoom\*
  - Delete\*
  - [Title Edit], [Text Stamp], [Resize] and [Cropping] in the [Playback] menu
- \* These functions are available when a picture is displayed in 2D.
- On the LCD monitor of this camera, 3D still pictures will be played back in 2D (conventional pictures).
  - If you switch between 3D still pictures and normal still pictures while playing back pictures, a black screen will be displayed for a few seconds.
  - If you select a thumbnail of 3D still pictures or display a thumbnail after playing back 3D still pictures, it may take a few seconds to start playing back or displaying the pictures.
  - Viewing 3D still pictures too close to a TV may cause eyestrain.
  - When a TV has not been converted for viewing 3D still pictures, do necessary preparation on the TV. (For details about the necessary preparation of the TV, read the manual for the TV.)



# Keep the recorded still pictures and motion pictures

The methods for copying still and motion pictures recorded with this camera to other devices vary according to the file format (JPEG, MPO, AVCHD, Motion JPEG). Follow the correct method for your device.

## Copy by inserting the SD card into the recorder

Available file types: **Still picture** JPEG/ **Motion picture** AVCHD

It is possible to copy onto Blu-ray disc, DVD disc, or hard disk by inserting an SD card with still pictures and motion pictures recorded by this unit into a Panasonic Blu-ray Disc Recorder or DVD Recorder.

Check the latest information about the equipment that can copy directly by inserting the SD card recorded by this unit, and equipment that is compatible with high definition (AVCHD) on the following website.

<http://panasonic.jp/support/global/cs/dsc/> (This Site is English only.)

- See the instruction manual for the recorder for the details of copying and playing back.
- **Note that the equipment described may not be available in certain countries and regions.**



## Dubbing playback pictures via AV cables

Available file types: **Motion picture** AVCHD, Motion JPEG

Videos that are played on this camera can be dubbed to media such as a DVD disc, hard disk or video tape using a device such as a DVD recorder or video recorder. This method is useful as it allows dubbing to be performed even with devices that are not compatible with high definition (AVCHD) images. Picture quality will be reduced from high definition to standard definition.

### 1 Connect camera to recorder

### 2 Start playback on camera

### 3 Start recording on recorder

- To stop recording (dubbing), stop the recording on your recorder first before stopping the playback on the camera.

AV cable  
(always use cable  
supplied)

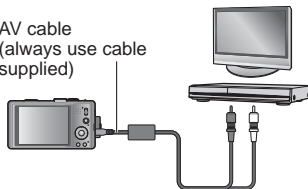

To recorder's input socket

- Do not use any other AV cables except the supplied one.
- When using a TV with a 4:3 aspect ratio, always change the camera's [TV Aspect] setting (→47) to [4:3] before dubbing. Motion pictures copied in the [16:9] setting will appear vertically stretched when viewed on a 4:3 TV screen.
- For details on dubbing and playback methods, refer to your recorder's operating instructions.

# Keep the recorded still pictures and motion pictures (Continued)

## Use “PHOTOfunSTUDIO” to copy to your computer

Available file types: **Still picture** JPEG, MPO/ **Motion picture** AVCHD, Motion JPEG

With the “PHOTOfunSTUDIO” software on the supplied CD-ROM, a computer can be used to manage the recorded pictures.

- 1 Install “PHOTOfunSTUDIO” to your computer**
- 2 Connect the camera to your computer**
  - For connection procedures (→123)
- 3 Use “PHOTOfunSTUDIO” to copy pictures to your computer**
  - For details on how to use “PHOTOfunSTUDIO”, see the “PHOTOfunSTUDIO” manual (PDF).

Files and folders containing copied AVCHD motion pictures cannot be played back or edited if they have been deleted, modified, or moved using Windows Explorer or similar methods. Always use “PHOTOfunSTUDIO” when handling AVCHD motion pictures.

## Keeping the 3D still pictures

### ■ Copying to your computer

Use “PHOTOfunSTUDIO” to copy to your computer.

## Using with your PC

Still/motion pictures can be copied from the camera to your computer by connecting the two together.

- Some computers can read directly from the camera's memory card.  
For details, see the manual for your computer.
- If your computer does not support SDXC Memory Cards a message will be displayed requesting you to format the card. (Do not format the card. This will erase recorded pictures.) If the card is not recognized, refer to the following support website.  
<http://panasonic.net/avc/sdcard/information/SDXC.html>

### ■ Computer specifications

	Windows			Macintosh
	98/98SE	Me/2000	XP/Vista/7	OS 9/OS X
Can I use "PHOTOfunSTUDIO"?	No		Yes*1	No
Can I copy AVCHD motion pictures to my computer?	No		Yes*2	No
Can I copy still pictures and Motion JPEG motion pictures from my camera to my computer via USB connection cable?	No	Yes		Yes OS 9.2.2 OS X (10.1 - 10.6)

- USB connection cables cannot be used with Windows 98/98SE, Mac OS 8.x, or older versions of either, but still/motion pictures may still be copied with compatible SD memory card reader/writers.

\*1 Internet Explorer 6.0 or above must be installed.

Correct playback and operation depends on your computer's environment and cannot always be guaranteed.

\*2 Always use "PHOTOfunSTUDIO" when copying AVCHD motion pictures.

# Using with your PC (Continued)

## Copying still pictures and motion pictures

### Getting Ready:

- Charge the battery sufficiently. Or, connect the AC adaptor (optional) and DC coupler (optional).
- When importing pictures from the built-in memory, remove any memory cards.

Check socket direction and insert straight in.  
(Damage to socket shape can lead to faulty operation.)

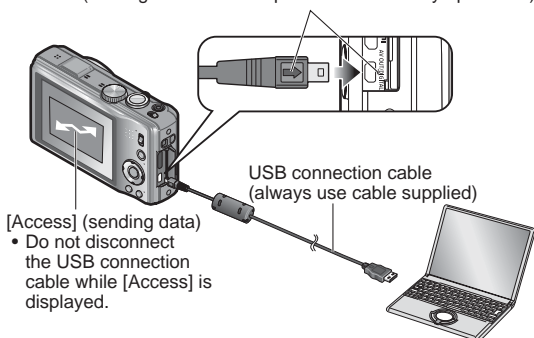

### 1 Connect camera to computer

- Please make sure you use the supplied USB connection cable. Use of cables other than the supplied USB connection cable may cause malfunction.

### 2 Use cursor button on the camera to select [PC], and press [MENU/SET]

A message may be displayed on screen if [USB Mode] (→46) is set to [PictBridge (PTP)]. Select [CANCEL] to close the screen, and set [USB Mode] to [PC].

### 3 Operate with your computer

#### ■To cancel connection

Click **“Safely Remove Hardware”** in the Windows System Tray

#### ■When using Windows XP, Windows Vista, Windows 7, or Mac OS X

The camera can be connected to your computer even if [USB Mode] (→46) is set to [PictBridge (PTP)].

- Only picture output can be performed.
- It may not be possible to import if there are 1000 or more pictures on the card.
- AVCHD motion pictures cannot be read.

You can save pictures to use on your computer by dragging and dropping folders and files into separate folders on your computer.

## ■ Folder and file names on computer

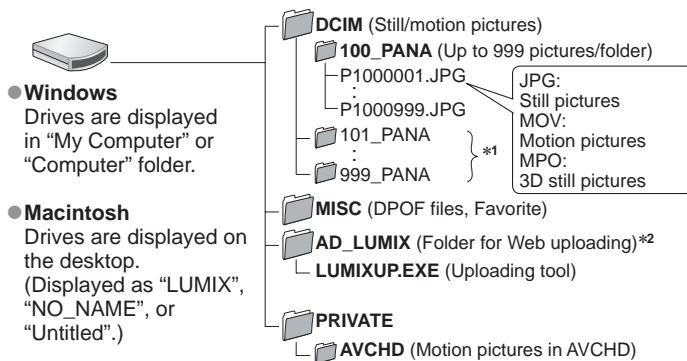

\*1 New folders are created in the following cases:

- When pictures are taken to folders containing files numbered 999.
- When using cards already containing the same folder number (for example, pictures taken with other cameras, etc.).
- When recording after performing [No.Reset].

\*2 Note that pictures cannot be uploaded to image-sharing websites if the files in the AD\_LUMIX folder are deleted.

● **Do not delete or modify folders or data in the AVCHD folder using Windows Explorer or other tools. The camera may be unable to play back the motion pictures correctly if any of these files are deleted or modified. For data management and editing of AVCHD motion pictures, use the "PHOTOfunSTUDIO" software on the supplied CD-ROM.**

- Do not use any other USB connection cables except the supplied one.
- Turn off power before inserting or removing memory cards.
- When the battery begins to run out during communication, a warning beep sounds. Cancel communication via your computer immediately. Use a sufficiently charged battery or an AC adaptor (optional) and DC coupler (optional).
- Setting the [USB Mode] to [PC] removes the need to make the setting each time the camera is connected to the computer.
- For more details, consult your computer operating manual.

## Using with your PC (Continued)

### Uploading pictures to image-sharing websites

Using the uploading tool ([LUMIX Image Uploader]), you can upload still pictures and motion pictures to image-sharing websites (Facebook or YouTube).

There is no need to copy pictures to your computer or install specialized software.

Uploading pictures from the camera is easy with a computer connected to a network, even when you are away from your regular computing environment.

- This tool supports only computers that run on Windows XP, Windows Vista, and Windows 7.

(To view the manual for [LUMIX Image Uploader], use Internet Explorer.)

#### Getting ready:

- Use [Upload Set] to select the pictures for uploading (→105)
- Connect your computer to the Internet
- Create an account for the applicable image-sharing website and prepare your login information

#### 1 Double-click “LUMIXUP.EXE” to start it

- If you have installed “PHOTOfunSTUDIO” from the CD-ROM (supplied), “Uploading tool ([LUMIX Image Uploader])” may start automatically.

#### 2 Select the upload destination

- Do the further steps in accordance with the instructions displayed on the computer screen.
- Because YouTube and Facebook services and specifications are subject to change, operation of online services cannot be guaranteed in the future. Available services and screens are subject to change without notice.  
(This service is available as of December 1, 2010)
- Do not upload pictures protected by copyright except when you are the copyright holder or permission has been obtained from the corresponding copyright holder.
- Pictures recorded using the GPS function are uploaded to image-sharing websites with the recorded place-name information intact. Be sure to confirm that it is okay to share the information before uploading.

# Printing

You can connect directly to a PictBridge-compatible printer for printing.

## Getting Ready:

- Charge the battery sufficiently. Or, connect the AC adaptor (optional) and DC coupler (optional).
- When copying pictures from the built-in memory, remove any memory cards.
- Adjust the print quality or other settings on your printer, as needed.

- Do not disconnect the USB connection cable when the cable disconnection icon  is displayed (may not be displayed with some printers).

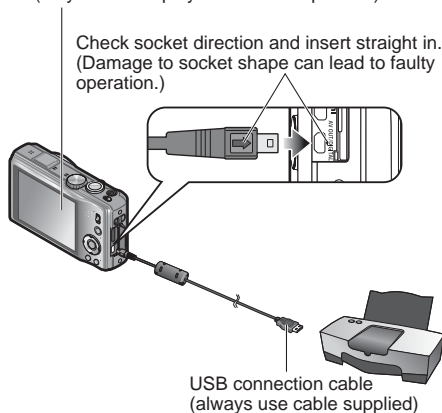

## 1 Connect camera to printer

- Please make sure you use the supplied USB connection cable. Use of cables other than the supplied USB connection cable may cause malfunction.

## 2 Use cursor button on the camera to select [PictBridge (PTP)], and press [MENU/SET]

## 3 Use cursor button to select a picture to print and press [MENU/SET]

## 4 Use cursor button to select [Print start] and press [MENU/SET] (Print settings (→129))

### ■ To cancel print Press [MENU/SET]

- Do not use any other USB connection cables except the supplied one.
- Disconnect USB connection cable after printing.
- Turn off power before inserting or removing memory cards.
- When the battery begins to run out during communication, a warning beep sounds. Cancel printing and disconnect USB connection cable. Use a sufficiently charged battery or an AC adaptor (optional) and DC coupler (optional).
- AVCHD motion pictures cannot be printed.

## Printing multiple pictures

**1** Use cursor button to select [Multi Print] in step **3** (→127)

**2** Use cursor button to select item and press [MENU/SET]

- **[Multi Select]:**
  - ① Scroll between pictures with cursor button select pictures to print with the [DISP.] button. (Press [DISP.] button again to release selection.)
  - ② Press [MENU/SET] when selection is complete.
- **[Select All]:** Print all pictures.
- **[Print Set (DPOF)]:** Print pictures selected in [Print Set].
- **[Favorite]:** Print pictures selected as [Favorite].  
(displayed only when [Favorite] pictures are present and setting is set to [ON].)

**3** Use cursor button to select [Print start] and press [MENU/SET]  
(Print settings (→129))

- Select [Yes] if print confirmation screen is displayed.
- An orange ● displayed during printing indicates an error message.
- Print may be divided into several times if printing a large amount of pictures.  
(Remaining sheets display may differ from set number.)

## Print with date and text

### ■ Printing date without [Text Stamp]

- Printing in store: Only recording date can be printed. Request date printing in store.
  - Making [Print Set] settings on the camera in advance allows settings for numbers of copies and date printing to be designated before giving the card to the store.
  - When printing still pictures of 16:9 Aspect Ratio, check in advance that the store can accept this size.
- Using computer: Print settings for recording date and text information can be made using the supplied CD-ROM "PHOTOfunSTUDIO".
- Using printer: Recording date can be printed by setting [Print Set] on the camera, or by setting [Print with Date] (→129) to [ON] when connecting to a printer compatible with date printing.









Some printers can print directly from the camera's memory card.  
For details, see the manual for your printer.



## Making print settings on the camera

(Make settings before selecting [Print start])

### 1 Use cursor button to select the item and press [MENU/SET]

Item	Settings
[Print with Date]	[ON]/[OFF]
[Num.of prints]	Set number of pictures (up to 999 pictures)
[Paper Size]	When  is selected, the printer settings take priority.
[Page Layout]	 (printer takes priority) /  (1 picture, no border) /  (1 picture, with border) /  (2 pictures) /  (4 pictures)

### 2 Use cursor button to select setting and press [MENU/SET]

- Items may not be displayed if incompatible with printer.
- To arrange  "2 pictures" or  "4 pictures" in the same still picture, set the number of prints for the still picture to 2 or 4.
- To print to paper sizes/layouts not supported by this camera, set to  and make settings on the printer. (Consult your printer's operating manual.)
- [Print with Date] and [Num.of prints] are not shown when you have selected [Print Set] settings.
- Even with completed [Print Set] settings, dates may not be printed, depending on the shop or printer used.
- When setting [Print with Date] to [ON], check the date printing settings on the printer (printer settings may be prioritized).

# List of LCD monitor displays

## ■ In recording

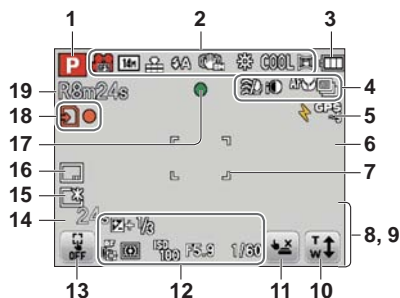

- |   |  |
|---|--|
| <p><b>1</b> Recording Mode (→20)</p> <p><b>2</b> Recording quality (→97)<br/>Picture Size (→85)<br/>Quality (→86)<br/>Flash (→52)<br/>Optical Image Stabilizer (→94)<br/>Jitter alert (→22)<br/>White Balance (→87)<br/>Color Mode (→93)<br/>Active mode (→98)</p> <p><b>3</b> Battery capacity (→15)</p> <p><b>4</b> Wind cut (→98)<br/>Intelligent exposure (→91)<br/>Macro recording (→54)<br/>Burst Mode (→70)<br/>Auto Bracket (→57)</p> <p><b>5</b> GPS (→75)</p> <p><b>6</b> Histogram (→44)</p> <p><b>7</b> AF area (→23)</p> <p><b>8</b> Self-timer Mode (→56)</p> | <p><b>9</b> Current date/time<br/>World time (→83)<br/>Name (→65, 73)<br/>Age in years/months (→65, 73)<br/>Place name information (→77)<br/>Destination settings (→82)<br/>Travel elapsed days (→82)</p> <p><b>10</b> Touch zoom (→50)</p> <p><b>11</b> Touch shutter (→24)</p> <p><b>12</b> Exposure Compensation (→57)<br/>AF Tracking (→89)<br/>AF Assist Lamp (→93)<br/>Metering Mode (→91)<br/>ISO Sensitivity (→86)<br/>Aperture value/Shutter speed (→22, 58, 59)</p> <p><b>13</b> Touch AF/AE function (→25)</p> <p><b>14</b> Elapsed recording time (→30)<br/>XXhXXmXXs*</p> <p><b>15</b> LCD Mode (→43)</p> <p><b>16</b> Date Stamp (→95)</p> <p><b>17</b> Focus (→23)</p> <p><b>18</b> Save destination (→14)<br/>Recording state</p> <p><b>19</b> Number of recordable pictures (→15)<br/>Available recording time (→30)<br/>RXhXXmXXs*</p> |
|---|--|

Press the [DISP.] button to change display.

## ■ In playback

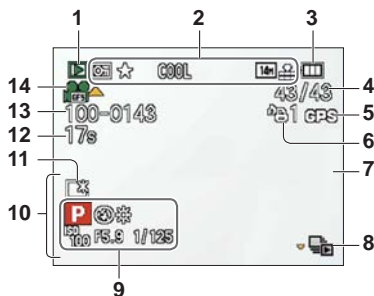

- |  |  |
|--|--|
| 1 Playback Mode (→102)   | 10 Current date/time<br>World time (→83)<br>Name (→65, 73)<br>Age in years/months (→65, 73)<br>Place name information (→77)<br>Destination settings (→82)<br>Travel elapsed days (→82)<br>Title (→106) |
| 2 Protected picture (→114)<br>Favorites (→112)<br>Date/text stamped display (→95, 108)<br>Color Mode (→93)<br>Picture Size (→85)<br>Quality (→86)                  | 11 LCD Mode (→43)  |
| 3 Battery capacity (→15)   | 12 Motion picture recording time (→33)<br>XXhXXmXXs*   |
| 4 Picture number/Total pictures (→32)<br>Elapsed playback time (→33)<br>XXhXXmXXs*   | 13 Folder/File number (→32, 125)   |
| 5 GPS (→75)  | 14 Recording quality (→97)<br>Burst group (→101)<br>Cable disconnection warning icon (→127)  |
| 6 Print settings (→113)  |  |
| 7 Histogram (→44)  |  |
| 8 Burst group display (→101)   |  |
| 9 Recording Mode (→20)<br>Flash (→52)<br>White Balance (→87)<br>Exposure Compensation (→57)<br>ISO Sensitivity (→86)<br>Aperture value/Shutter speed (→22, 58, 59) |  |

• The order of priority for display is location name information, title, destination, name ([Baby]/[Pet]), name ([Face Recog.]).

\* [h], [m] and [s] indicate "hour", "minute" and "second".

Screens shown here are only examples. The actual display may vary.

# Message displays

## **[This memory card cannot be used]**

- A MultiMediaCard was inserted.  
→ Not compatible with the camera. Use a compatible card.

## **[Some pictures cannot be deleted] [This picture cannot be deleted]**

- Non-DCF pictures (→32) cannot be deleted.  
→ Save needed data on a computer or other device, and then use [Format] on the camera. (→48)

## **[No additional selections can be made]**

- The number of pictures that can be deleted at once has been exceeded.
- More than 999 pictures have been set as [Favorite].
- The number of pictures allowing [Title Edit], [Text Stamp] or [Resize] (multiple settings) at once has been exceeded.

## **[Cannot be set on this picture]**

- [Print Set], [Title Edit], or [Text Stamp] cannot be made for non-DCF pictures (→32).

## **[Please turn camera off and then on again] [System Error]**

- The lens is not working correctly.  
→ Turn on power again.  
(Consult the dealer or your nearest Service Center if display still remains)

## **[Some pictures cannot be copied] [Copy could not be completed]**

- Pictures cannot be copied in following cases.  
→ Picture of same name already exists in built-in memory when copying from card.  
→ File is not of DCF standard (→32).  
→ Picture taken or edited on a different device.

## **[Not enough space on built-in memory] [Not enough memory on the card]**

- There is no space left on the built-in memory or the card. When you copy pictures from the built-in memory to the card (batch copy), the pictures are copied until the capacity of the card becomes full.

## **[Built-In Memory Error] [Format built-in memory?]**

- Displayed when formatting built-in memory via computer, etc.  
→ Reformat directly using camera. Data will be deleted.

## **[Memory Card Error] [Format this card?]**

- The card format cannot be used with this camera.  
→ Save needed data on a computer or other device, and then use [Format] on the camera. (→48)

## **[Insert SD card again] [Try another card]**

- Access to card has failed.  
→ Insert card again.
- Try with a different card.

Meanings of and required responses to major messages displayed on LCD monitor.

**[Memory Card Error] [Memory card parameter error]**

- Card is not of SD standard.
- When cards in capacities of 4 GB or more are used, only SDHC or SDXC Memory Cards are supported.

**[Read Error]/[Write Error] [Please check the card]**

- Data read has failed.  
→ Check whether card has been inserted correctly (→12).
- Data write has failed.  
→ Turn off power and remove card, before re-inserting and turning on power again.
- Card may possibly be damaged.
- Try with a different card.

**[Cannot record due to incompatible format(NTSC/PAL) data on this card.]**

- A card that has been used in another camera to record an AVCHD motion picture in a different broadcast system cannot be used to record AVCHD motion pictures with this camera.  
→ Format the card with this camera. The data will be deleted.

**[Motion recording was cancelled due to the limitation of the writing speed of the card]**

- If recording stops even when using a card of the recommended speed class (→14), the data writing speed has dropped. If this happens, we recommend backing up the data on the memory card and formatting it (→48).
- Motion picture recording may be automatically terminated with certain cards.

**[A folder cannot be created]**

- Folder numbers in use have reached 999.  
→ Save needed data on a computer or other device, and then use [Format] on the camera. (→48)  
Folder number is reset to 100 when performing [No.Reset] (→46).

**[Picture is displayed for 16:9 TV] [Picture is displayed for 4:3 TV]**

- AV cable (supplied) is connected to camera.  
→ To remove message immediately → Press [MENU/SET].  
→ To change aspect ratio → Change [TV Aspect] (→47).
- USB connection cable (supplied) is only connected to camera.  
→ Message disappears when cable is also connected to another device.

**[This battery cannot be used]**

- Use a genuine Panasonic battery.
- Battery cannot be recognized as terminal is dirty.  
→ Wipe any dirt away from the battery terminal.

**[GPS feature is not available in this region.]**

- GPS may not work in China or in the border regions of countries neighboring China. (Current as of December 2010)

### Battery, power

#### Camera does not work even if power is turned on.

- Battery is not inserted correctly (→12), or needs recharging.

#### LCD monitor shuts off even if power is turned on.

- [Sleep Mode] is activated. (→45)  
→ Press shutter button halfway to release.
- Battery needs recharging.

#### Camera switches off as soon as power is turned on.

- Battery needs recharging.
- [Sleep Mode] is activated. (→45)  
→ Press shutter button halfway to release.

#### This unit is turned off automatically.

- If you connect to a TV compatible with VIERA Link with an HDMI mini cable (optional) and turn off the power on the TV with the remote control for the TV, the power on this unit also turns off.  
→ If you are not using VIERA Link, set [VIERA Link] to [OFF]. (→47)

### GPS

#### Cannot perform positioning.

- When [GPS Setting] is set to [OFF]. (→76)
- Depending on the recording environment, such as when indoors or near buildings, it may not be possible to correctly receive the signals from the GPS satellites. (→75)  
→ When using the GPS, we recommend holding the camera still for a while with the GPS antenna facing upward in an outdoor location where you can see the entire sky.



#### The GPS status indicator lights up while the camera's power is off.

- [GPS Setting] is [ON].  
→ When turning off the camera's power in an airplane, hospital or other restricted area, set [GPS Setting] to [OFF] or .

#### Positioning takes time.

- When using the camera for the first time or after not using it for a while, positioning may take several minutes.
- Positioning usually takes less than two minutes, but because the positions of the GPS satellites change, it may take longer depending on the recording location and environment.
- Positioning will take time in environments where it is difficult to receive the signals from the GPS satellites. (→75)

#### The location name information is different from the recording location.

- Immediately after the camera's power is turned on or when the GPS icon is something other than , the location name information that is recorded in the camera may vary significantly from the current position.
- When  is displayed for the location name information, the information can be changed to a different candidate before starting to record. (→79)

#### The location name information is not displayed.

- "- -" is displayed if there is no nearby landmark or other points, or no information registered in the camera's database. (→77)  
→ During playback, a location name or other information can be entered with [Place-Name Edit]. (→107)

Try checking these items (→134 - 140) first.

If the problem persists, performing [Reset] in the [Setup] menu may resolve the issue. (Note that except for some items such as [Clock Set], all settings are returned to their values from the time of purchase.)

## Recording

### Cannot record pictures.

- REC/PLAY switch is not set to  (record).
- Built-in memory/card is full. → Free space by deleting unwanted pictures (→36).

### Recorded pictures look white.

- Lens is dirty (fingerprints, etc.).  
→ Turn on power to extract lens barrel, and clean lens surface with a soft, dry cloth.
- Lens is foggy (→5).

### Recorded pictures are too bright/too dark.

- **Adjust the exposure (→57).**
- **[Min. Shtr Speed] is set to fast speeds, e.g. [1/250] (→92).**

### Some pictures are taken when I press the shutter button just once.

- [iHandheld Nite Shot] is activated in [Intelligent Auto] Mode. (→27)
- Camera is set to use [Auto Bracket], [Burst], [Handheld Night Shot] or [Flash Burst] Scene Modes.

### Focus not aligned correctly.

- Not set to mode appropriate for distance to subject. (Focus range varies according to Recording Mode.)
- Subject outside of focus range.
- Caused by jitter or subject movement.

### Recorded pictures are blurred. Optical Image Stabilizer ineffective.

- Shutter speed is slower in dark locations and Optical Image Stabilizer is less effective.  
→ Hold camera firmly with both hands, keeping arms close to body.
- Use a tripod and the self-timer (→56) when using slower shutter speed with [Min. Shtr Speed].

### Cannot use [Auto Bracket].

- Only enough memory for 2 pictures or fewer.

### Recorded pictures appear coarse, or there is interference.

- ISO Sensitivity is high, or shutter speed is low.  
(Default [Sensitivity] setting is [AUTO] – interference may appear with indoor pictures.)  
→ Lower [Sensitivity] (→86).  
→ Set [Color Mode] to [NATURAL]. (→93)  
→ Take pictures in brighter locations.
- Camera set to [High Sens.] Scene mode.  
(Picture becomes slightly coarser in response to high sensitivity)

### Under fluorescent lighting, flicker or horizontal bars may be seen.

- This is characteristic of MOS sensors which serve as the camera's pickup sensors.  
This is not a malfunction.



## Q&A Troubleshooting (Continued)

### Recording (continued)

#### Brightness or coloring of recorded picture different from real life.

- Taking pictures under fluorescent lighting may require a faster shutter speed and result in slightly changed brightness or coloring, but this is not a fault.

#### Reddish horizontal streaks appear on the LCD monitor during recording.

- This is characteristic of MOS sensors which serve as the camera's pickup sensors. It appears when the subject has a bright part. Some unevenness may occur in the surrounding areas, but this is not a malfunction. It is recorded in motion pictures but is not recorded on still pictures.
- It is recommended that you take pictures while taking care not to expose the screen to sunlight or any other source of strong light.

#### Motion picture recording stops midway.

- An AVCHD motion picture can be recorded continuously for up to 29 minutes 59 seconds when [GFS] or [FSH] is set.
- If [Rec Quality] is set to [GFS] or [FSH], and if the surrounding temperature is high, or motion picture is recorded continuously,  is displayed, and the recording may be stopped halfway through.
- With some cards, access display may appear briefly after recording, and recording may end midway.
- If recording stops even when using a card of the recommended speed class (→14), the data writing speed has dropped. If this happens, we recommend backing up the data on the memory card and formatting it (→48).

#### The subject cannot be locked. (AF track fails)

- If the color of the subject is similar to that of its background, AF Tracking may not function. Set the AF area to those colors specific to the subject by aligning that area with the AF area.

### LCD monitor

#### LCD monitor dims during motion picture recording.

- LCD monitor may dim if continuing motion picture recording for long periods.

#### Brightness is unstable.

- Aperture value is set while shutter button is pressed halfway.  
(Does not affect recorded picture.) This symptom may also occur when the brightness changes because the zoom is operated or the camera is moved. This is the automatic aperture operation of the camera and is not a malfunction.

#### Monitor flickers indoors.

- Monitor may flicker after turning on (prevents influence from fluorescent lighting).

#### Monitor is too bright/too dark.

- [LCD Mode] is activated (→43).

#### Black/blue/red/green dots or interference appears. Monitor looks distorted when touched.

- This is not a fault, and will not be recorded on the actual pictures.



## Flash

### No flash emitted.

- Flash set to  [Forced Flash Off] (→52).
- Flash cannot be emitted in the [Scenery], [Panorama Assist], [Night Scenery], [Handheld Night Shot], [Sunset], [Starry Sky], [Fireworks], [Aerial Photo] and [High Speed Movie] Scene Modes, or when using [Auto Bracket] or [Burst].

### Multiple flashes are emitted.

- Red-eye reduction is active (→52). (Flashes twice to prevent eyes appearing red.)
- The Scene Mode is set to [Flash Burst].

## Playback

### Pictures have been rotated.

- [Rotate Disp.] is set to .

### Cannot view pictures. There are no recorded pictures.

- REC/PLAY switch is not set to  (play).
- No pictures in built-in memory or card (pictures played from card if inserted, from built-in memory if not).
- Has the file name of the picture been changed on a computer? If so, it cannot be played back on the camera.
- The Playback Mode has been changed.  
→ Set Playback Mode to [Normal Play] (→102).

### Folder/file number displayed as [-]. Picture is black.

- Picture edited on computer or taken on different device.
- Battery removed immediately after picture taken, or picture taken with low battery.  
→ Use [Format] to delete (→48).

### Incorrect date displayed in Calendar Playback.

- Picture edited on computer or taken on different device.
- [Clock Set] is incorrect (→18).  
(Incorrect date may be displayed in Calendar Playback on pictures copied to computer and then back to camera, if computer and camera dates differ.)

### White round spots like soap bubbles appear on the recorded picture.

- If you take a picture with the flash in a dark place or indoors, white round spots may appear on the picture caused by the flash reflecting particles of dust in the air. This is not a fault. A characteristic of this is that the number of round spots and their position differ in every picture.



### [Thumbnail is displayed] is shown on the screen.

- The pictures may have been recorded on another device. If so, they may be displayed with poor picture quality.

## Q&A Troubleshooting (Continued)

### Playback (continued)

#### Blacken red areas of recorded pictures.

- When digital red-eye correction (ⓂA, Ⓜ, ⓂS) is operating, if a subject is recorded that has skin-colored areas with red areas inside, the digital red-eye correction function may blacken the red areas.  
→ We recommend setting the flash to ⓂA, Ⓜ, or Ⓜ, or [Red-Eye Removal] to [OFF] before recording.

#### Sounds of camera operations such as zoom will be recorded in motion pictures.

- Camera operation sounds may be recorded as camera automatically adjusts lens aperture during motion picture recording; this is not a fault.

#### Motion pictures taken by this camera cannot be played in other cameras.

- Motion pictures (Motion JPEG) taken with this camera may not always be able to be played back with cameras by other manufacturers. Playback may also not be possible with certain Panasonic digital cameras (LUMIX).\*  
\* Cameras launched before December 2008, and some cameras launched in 2009 (FS, LS Series).
- AVCHD motion pictures\* cannot be played in devices that do not support AVCHD. In some cases, motion pictures cannot be played back correctly in AVCHD-compatible devices.  
\* Motion pictures recorded in [GFS] [GS] cannot be played back with Panasonic digital cameras (LUMIX) compatible with AVCHD recording that were sold in or before 2010.

### TV, computer, printer

#### No image appears on TV. Image blurred or not colored.

- Not connected correctly (→116, 117).
- The television has not been switched to auxiliary input.

#### TV screen display different to LCD monitor.

- Aspect ratio may be incorrect or edges may be cut off with certain televisions.

#### Cannot play motion pictures on TV.

- Card is inserted into TV.  
→ Connect with AV cable (supplied) or HDMI mini cable (optional) and play on camera (→116, 117).

#### Picture is not displayed on full TV screen.

- Check [TV Aspect] settings (→47).

## TV, computer, printer (continued)

### VIERA Link (HDMI) is not working.

- Is the HDMI mini cable (optional) connected correctly? (→117)
  - Check that the HDMI mini cable (optional) is fully inserted.
- Is the camera's [VIERA Link] setting set to [ON]? (→47)
  - The input setting may not be able to be changed automatically with certain television HDMI sockets. In this case, please change the input setting with your television's remote control (consult your television's operating instructions for details).
  - Check the VIERA Link (HDMI) settings on the device you are connecting to.
  - Turn the camera's power off and on again.
  - Turn the "VIERA Link control (HDMI device control)" setting on your television (VIERA) to off and then to on again. (Consult your VIERA's operating instructions for details.)

### Cannot send pictures to computer.

- Not connected correctly (→123).
- Check whether computer has recognized camera.
- Set [USB Mode] to [PC] (→46).

### Computer does not recognize card (only reads built-in memory).

- Disconnect USB connection cable (supplied) and reconnect with card in place.

### Computer does not recognize card. (When using an SDXC Memory Cards)

- Check whether your computer is compatible with SDXC Memory Cards.  
<http://panasonic.net/avc/sdcard/information/SDXC.html>
- A message prompting you to format the card may appear when you connect it. Do not format the card.
- If the [Access] indicator on the LCD monitor does not go off, turn off the camera's power before disconnecting the USB connection cable.

### Uploading to YouTube or Facebook cannot be performed properly.

- Confirm that the login information (login ID, user name, e-mail address and password) is correct.
- Confirm that the computer is connected to the Internet.
- Confirm that the resident software (such as anti-virus software and the firewall, etc.) is not blocking access to YouTube or Facebook.
- Check the YouTube or Facebook site.

### Cannot print when connecting to printer.

- Printer not compatible with PictBridge.
- Set [USB Mode] to [PictBridge (PTP)] (→46).

### The edges of pictures are cut off when printing.

- Release any trimming or edgeless printing settings on printer before printing.  
(Consult printer operating manual.)
- The pictures were recorded in 16:9 aspect ratio.
  - If printing in shop, check if 16:9 sizes can be printed.

## Q&A Troubleshooting (Continued)

### Others

#### **Menu not displayed in desired language.**

- Change [Language] setting (→49).

#### **Camera rattles if shaken.**

- This sound is made by the lens movement and is not a fault.

#### **Red lamp illuminated when pressing shutter button halfway in dark locations.**

- [AF Assist Lamp] is set to [ON] (→93).

#### **AF Assist Lamp is not illuminated.**

- [AF Assist Lamp] is set to [OFF].

#### **Camera is hot.**

- Camera may become a little warm during use, but this does not affect performance or quality.

#### **Lens makes a clicking noise.**

- When brightness changes, the lens may make a clicking noise and the monitor brightness may also change, but this is due to aperture settings being made.  
(Does not affect recording.)

#### **Clock is incorrect.**

- Camera has been left for a long period.  
→ Reset the clock (→19).
- Long time was taken to set clock (clock will be behind by the same lapse of time).

#### **When using zoom, picture becomes slightly warped and the edges of the subject become colored.**

- Pictures may be slightly warped or colored around the edges, depending on the zoom ratio, but this is not a fault.

#### **Zoom movement stops momentarily.**

- The zoom movement stops momentarily during Extended Optical Zoom and i.Zoom operation, but this is not a malfunction.

#### **Zoom does not reach the maximum ratio.**

- If the zoom ratio stops at 3 x, [Macro Zoom] has been set. (→54)

#### **File numbers are not recorded in sequence.**

- File numbers are reset when new folders are created (→125).

#### **File numbers have jumped backwards.**

- Battery was removed/inserted with power on.  
(Numbers may jump backwards if folder/file numbers are not correctly recorded.)

#### **When no operation is performed for a while, the demo is suddenly displayed.**

- This is the Automatic Demo Mode that introduces the features of this camera.  
Press [MENU/SET] to return to the previous screen.

# Usage cautions and notes

## When in use

- Camera may become warm if used for long periods of time, but this is not a fault.
- **Keep the camera as far away as possible from electromagnetic equipment (such as microwave ovens, TVs, video games etc.).**
  - If you use the camera on top of or near a TV, the pictures and sound on the camera may be disrupted by electromagnetic wave radiation.
  - Do not use the camera near cell phones because doing so may result in noise adversely affecting the pictures and sound.
  - Recorded data may be damaged, or pictures may be distorted, by strong magnetic fields created by speakers or large motors.
  - Electromagnetic wave radiation generated by microprocessors may adversely affect the camera, disturbing the pictures and sound.
  - If the camera is adversely affected by electromagnetic equipment and stops functioning properly, turn the camera off and remove the battery or disconnect AC adaptor (optional). Then reinsert the battery or reconnect AC adaptor and turn the camera on.
- **Do not use the camera near radio transmitters or high-voltage lines.**
  - If you record near radio transmitters or high-voltage lines, the recorded pictures and sound may be adversely affected.
- Do not extend the supplied cord or cable.
- Do not allow camera to come into contact with pesticides or volatile substances (can cause surface damage or coating to peel).
- Never leave the camera and the battery in a car or on a car hood in the summer. It may cause leakage of the battery electrolyte, a generation of heat, and may cause a fire and the battery to burst due to the high temperature.

## Caring for your camera

To clean your camera, remove the battery or disconnect the power plug from the outlet, and wipe with a soft, dry cloth.

- Use a damp cloth to remove stubborn stains, before wiping with a dry cloth.
- Do not use benzene, thinners, alcohol, or kitchen detergent, as these may damage the outer casing and finish of the camera.
- If using a chemically-treated cloth, read the supplied instructions carefully.
- Do not touch the lens barrier.

## When not using for a while

- Turn off camera power before removing battery and card (ensure that battery is removed to prevent damage through over-discharge).
- Do not leave in contact with rubber or plastic bags.
- Store together with a drying agent (silica gel) if leaving in drawer, etc. Store batteries in cool (15 °C - 25 °C (59 °F - 77 °F)) places with low humidity (40 %RH - 60 %RH) and no major temperature changes.
- Charge battery once per year and use completely before storing again.

## Usage cautions and notes (Continued)

### Memory cards

- To prevent damage to cards and data
  - Avoid high temperatures, direct sunlight, electromagnetic waves, and static electricity.
  - Do not bend, drop, or expose to strong impacts.
  - Do not touch connectors on reverse of card or allow them to become dirty or wet.
- When disposing of/transferring memory cards
  - If using the "format" or "delete" functions on your camera or computer, this only changes the file management information, and does not completely delete the data from within the memory card. When disposing of or transferring your memory cards, we recommend physically destroying the memory card itself, or using commercially available computer data erasing software to completely delete the data from the card. Data within memory cards should be managed responsibly.

### LCD Monitor

- Do not press hard on the LCD monitor. This may cause uneven display and damage the monitor.
- In cold climates or other situations when the camera becomes cold, the LCD monitor may be slightly less responsive than normal immediately after startup. Normal brightness will return once the internal components have warmed up.

Extremely high precision technology is employed to produce the LCD monitor screen. However there may be some dark or bright spots (red, blue or green) on the screen. This is not a malfunction. The LCD monitor screen has more than 99.99% effective pixels with a mere 0.01% of the pixels inactive or always lit. The spots will not be recorded on pictures on the built-in memory or a card.

### About charging the battery

- The time required for charging varies depending on conditions of battery usage. Charging takes longer at high or low temperatures and when the battery has not been used in some time.
- Battery will be warm during charging and for some time thereafter.
- Battery will run out if not used for long periods of time, even after being charged.
- Do not leave any metal items (such as clips) near the contact areas of the power plug. Otherwise, a fire and/or electric shocks may be caused by short-circuiting or the resulting heat generated.
- Frequently charging up battery is not recommended.  
(Frequently charging battery reduces maximum usage time and can cause battery to expand.)
- Do not disassemble or modify the charger.
- If available battery power is significantly reduced, battery is reaching end of lifespan. Please purchase a new battery.
- When charging:
  - Remove any dirt on connectors of charger and battery with dry cloth.
  - Keep at least 1 m (3.28 feet) away from AM radio (may cause radio interference).
  - Noises may be emitted from inside of charger, but this is not a fault.
  - After charging, remove the charger from the wall socket, and then remove the battery from the charger (up to 0.1 W consumed if left in place).
- Do not use a damaged or dented battery (especially connectors), e.g. by dropping (can cause faults).

## Lens

- If lens is dirty:  
Images may appear slightly white if lens is dirty (fingerprints, etc.). Turn the power on, hold the extracted lens barrel with your fingers, and gently wipe the lens surface with a soft, dry cloth.
- Do not leave the lens exposed to direct sunlight.
- Do not touch the lens barrier, as this may damage lens. Be careful when removing camera from bag, etc.

## When using a tripod or unipod

- Do not apply excessive force or tighten screws when they are crooked. (This may damage the camera, screw hole, or label.)
- Ensure that the tripod is stable. (Refer to the tripod instructions.)

## About 3D viewing

- Anyone who is hypersensitive to light, suffers from heart disease or is otherwise unwell should avoid viewing 3D pictures.
  - Doing so may have an adverse effect on such medical conditions.
- If you feel tired, uncomfortable or otherwise strange when viewing 3D pictures, stop viewing at once.
  - Continuing to view may cause illness.
  - Please rest appropriately after stopping the viewing.
- When viewing 3D pictures, we recommend taking a break every 30 to 60 minutes.
  - Viewing for extended periods may cause eye-fatigue.
- Short-sighted or long-sighted persons, those with differences in the sight of their right and left eyes, and those with astigmatism are advised to correct their vision by wearing glasses etc. Stop viewing if you can clearly see a double image while viewing 3D pictures.
  - There are differences in the way that different people experience 3D pictures. Please correct your sight appropriately before viewing 3D pictures.
  - You can change the 3D setting of your television or 3D output setting of the unit to 2D.
- When viewing 3D pictures on a 3D compatible television, position yourself a distance away that is at least 3 times the effective height of the television.
  - (Recommended distance): For 42 inch; approx. 1.6 m (5.24 feet), for 46 inch; approx. 1.7 m (5.58 feet), for 50 inch; approx. 1.9 m (6.23 feet), for 54 inch; approx. 2.0 m (6.57 feet).
  - Viewing from a distance closer than the recommended distance may lead to eye-fatigue.

## Usage cautions and notes (Continued)

### Personal Information

If names or birthdays are set in [Baby] Mode or in the [Face Recog.] function, keep in mind that the camera and recorded pictures will contain personal information.

- Disclaimer
  - Data containing personal information can be altered or lost due to malfunction, static electricity, accidents, breakdowns, repairs, or other operations.  
Panasonic will not be liable for any damage that occurs, direct or indirect, as a result of the alteration or loss of data containing personal information.
- When ordering repairs or transferring/disposing of the camera
  - To protect your personal information, please reset the settings. (→46)
  - If any pictures are contained in the built-in memory, copy (→115) them to a memory card if necessary, and then format (→48) the built-in memory.
  - Remove the memory card from the camera.
  - When ordering repairs, the built-in memory and other settings may be returned to the initial purchase state.
  - If the above operations cannot be performed because of a camera malfunction, consult with the dealer or nearest Service Center.

**When transferring or disposing of your memory card, see “When disposing of/transferring memory cards” in the previous section.**



**Important! Be sure to read the following before using the location names that are stored in this product.**

## User License Agreement for Location Name Data

### Personal Use Only.

You agree to use this Data together with this digital camera for the solely personal, non-commercial purposes for which you were licensed, and not for service bureau, time-sharing or other similar purposes. Accordingly, but subject to the restrictions set forth in the following paragraphs, you may copy this Data only as necessary for your personal use to (i) view it, and (ii) save it, provided that you do not remove any copyright notices that appear and do not modify the Data in any way. You agree not to otherwise reproduce, copy, modify, decompile, disassemble or reverse engineer any portion of this Data, and may not transfer or distribute it in any form, for any purpose, except to the extent permitted by mandatory laws. Multi-disc sets may only be transferred or sold as a complete set as provided by Panasonic Corporation and not as a subset thereof.

### Restrictions.

Except where you have been specifically licensed to do so by Panasonic Corporation, and without limiting the preceding paragraph, you may not (a) use this Data with any products, systems, or applications installed or otherwise connected to or in communication with vehicles, capable of vehicle navigation, positioning, dispatch, real time route guidance, fleet management or similar applications; or (b) with or in communication with any positioning devices or any mobile or wireless-connected electronic or computer devices, including without limitation cellular phones, palmtop and handheld computers, pagers, and personal digital assistants or PDAs.

### Warning.

The Data may contain inaccurate or incomplete information due to the passage of time, changing circumstances, sources used and the nature of collecting comprehensive geographic data, any of which may lead to incorrect results.

## Usage cautions and notes (Continued)

### **No Warranty.**

This Data is provided to you "as is," and you agree to use it at your own risk. Panasonic Corporation and its licensors (and their licensors and suppliers) make no guarantees, representations or warranties of any kind, express or implied, arising by law or otherwise, including but not limited to, content, quality, accuracy, completeness, effectiveness, reliability, fitness for a particular purpose, usefulness, use or results to be obtained from this Data, or that the Data or server will be uninterrupted or error-free.

### **Disclaimer of Warranty:**

PANASONIC CORPORATION AND ITS LICENSORS (INCLUDING THEIR LICENSORS AND SUPPLIERS) DISCLAIM ANY WARRANTIES, EXPRESS OR IMPLIED, OF QUALITY, PERFORMANCE, MERCHANTABILITY, FITNESS FOR A PARTICULAR PURPOSE OR NON-INFRINGEMENT. Some States, Territories and Countries do not allow certain warranty exclusions, so to that extent the above exclusion may not apply to you.

### **Disclaimer of Liability:**

PANASONIC CORPORATION AND ITS LICENSORS (INCLUDING THEIR LICENSORS AND SUPPLIERS) SHALL NOT BE LIABLE TO YOU: IN RESPECT OF ANY CLAIM, DEMAND OR ACTION, IRRESPECTIVE OF THE NATURE OF THE CAUSE OF THE CLAIM, DEMAND OR ACTION ALLEGING ANY LOSS, INJURY OR DAMAGES, DIRECT OR INDIRECT, WHICH MAY RESULT FROM THE USE OR POSSESSION OF THE INFORMATION; OR FOR ANY LOSS OF PROFIT, REVENUE, CONTRACTS OR SAVINGS, OR ANY OTHER DIRECT, INDIRECT, INCIDENTAL, SPECIAL OR CONSEQUENTIAL DAMAGES ARISING OUT OF YOUR USE OF OR INABILITY TO USE THIS INFORMATION, ANY DEFECT IN THE INFORMATION, OR THE BREACH OF THESE TERMS OR CONDITIONS, WHETHER IN AN ACTION IN CONTRACT OR TORT OR BASED ON A WARRANTY, EVEN IF PANASONIC CORPORATION OR ITS LICENSORS HAVE BEEN ADVISED OF THE POSSIBILITY OF SUCH DAMAGES. Some States, Territories and Countries do not allow certain liability exclusions or damages limitations, so to that extent the above may not apply to you.

### **Export Control.**

You agree not to export from anywhere any part of the Data provided to you or any direct product thereof except in compliance with, and with all licenses and approvals required under, applicable export laws, rules and regulations.

### **Entire Agreement.**

These terms and conditions constitute the entire agreement between Panasonic Corporation (and its licensors, including their licensors and suppliers) and you pertaining to the subject matter hereof, and supersedes in their entirety any and all written or oral agreements previously existing between us with respect to such subject matter.

### **About the geographical coordinate system**

The latitude and longitude standard (geographical coordinate system) recorded with this camera is WGS84.

### **About copyright**

According to copyright law, the map data stored in this camera may not be used for purposes other than personal use without the permission of the copyright holder.

### **About navigation functions**

This camera is not equipped with a navigation function.

### **Notices related to licensed software copyright holders**



© 2010 NAVTEQ. All rights reserved.



This service uses POI (Points Of Interest) of ZENRIN CO., LTD. "POWERED BY ZENRIN" is a trademark of ZENRIN CO., LTD. © 2011 ZENRIN CO., LTD. All rights reserved.

© Her Majesty the Queen in Right of Canada, © Queen's Printer for Ontario, © Canada Post Corporation, GeoBase®, © Department of Natural Resources Canada, © United States Postal Service® 2009, USPS®, ZIP+4®

## Usage cautions and notes (Continued)

Australia	Copyright. Based on data provided under license from PSMA Australia Limited ( <a href="http://www.pasma.com.au">www.pasma.com.au</a> ).
Austria	© Bundesamt für Eich- und Vermessungswesen
Croatia, Cyprus, Estonia, Latvia, Lithuania, Moldova, Poland, Slovenia and/or Ukraine	© EuroGeographics
France	source: Géoroute® IGN France & BD Carto® IGN France
Germany	Die Grundlagendaten wurden mit Genehmigung der zuständigen Behörden entnommen.
Great Britain	Based upon Crown Copyright material.
Greece	Copyright Geomatics Ltd.
Hungary	Copyright © 2003; Top-Map Ltd.
Italy	La Banca Dati Italiana è stata prodotta usando quale riferimento anche cartografia numerica ed al tratto prodotta e fornita dalla Regione Toscana.
Norway	Copyright © 2000; Norwegian Mapping Authority
Portugal	Source: IgeoE – Portugal
Spain	Información geográfica propiedad del CNIG
Sweden	Based upon electronic data © National Land Survey Sweden.
Switzerland	Topografische Grundlage: © Bundesamt für Landestopographie.

## ■ Landmark types

The following points of interest, such as tourist spots and public facilities, are displayed as landmarks.

- Although about 1,000,000 landmarks are registered (out of which about 70,000 are located in Japan), there are some that are not registered. (The registered information is current as of December 2010 and will not be updated.)

Zoo	Botanical garden	Aquarium
Amusement park	Golf course	Camp sites
Ski resorts	Skating rinks	Outdoor activity sites
Famous site, tourist attraction, beauty spot	Castle, ruins	Shrine
Buddhist temple	Church	Tomb, monument, mound, historic site, palace
Airport, airfield	Port	Ferry terminal, ship boarding point
Baseball park	Athletics ground	Gymnasium
Park	Station	Hospital
Prefectural or state office	City or ward office	Town or village office
Embassy, consulate	Art museum	History museum
Other museum	Theater	Cinemas, performing theaters
Department stores	Shopping centers, malls	Auditoriums, halls
Cultural facilities	Microbreweries, sake breweries, wineries	Canyons, mountain streams, waterfalls, valleys, seashores
Lifts, cable cars	Tower	



- HDMI, the HDMI Logo, and High-Definition Multimedia Interface are trademarks or registered trademarks of HDMI Licensing LLC in the United States and other countries.
- HDAVI Control™ is a trademark of Panasonic Corporation.
- The “AVCHD” and the “AVCHD” logo are trademarks of Panasonic Corporation and Sony Corporation.
- Manufactured under license from Dolby Laboratories. Dolby and the double-D symbol are trademarks of Dolby Laboratories.
- SDXC Logo is a trademark of SD-3C, LLC.
- QuickTime and the QuickTime logo are trademarks or registered trademarks of Apple Inc., used under license therefrom.
- YouTube is a trademark of Google Inc.
- This product uses “DynaFont” from DynaComware Corporation. DynaFont is a registered trademark of DynaComware Taiwan Inc.
- Other names, company names, and product names printed in these instructions are trademarks or registered trademarks of the companies concerned.

This product is licensed under the AVC patent portfolio license for the personal and noncommercial use of a consumer to (i) encode video in compliance with the AVC Standard (“AVC Video”) and/or (ii) decode AVC Video that was encoded by a consumer engaged in a personal and non-commercial activity and/or was obtained from a video provider licensed to provide AVC Video. No license is granted or shall be implied for any other use. Additional information may be obtained from MPEG LA, LLC.  
See <http://www.mpegla.com>.