



Scan, watch and discover how to get the most out of your TV
<http://SCN.BY/9T9AB0HTW8JBKM>

U.S. and Canada only

Panasonic®

Model No.

TC-L32B6/TC-32LB64
TC-L39B6
TC-L50B6

Operating Instructions

LCD TV

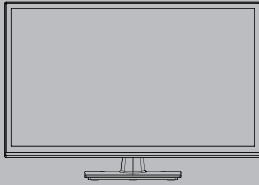

Standard accessories

Check that you have the accessories and items shown

Remote Control

N2QAYB000820



Pedestal

For 32" TV For 39" 50" TV

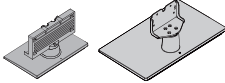

Power cord



Batteries for the Remote Control (2)
 • (AA)



Assembly screws
 (4 of each)

For 32" TV



For 39" 50" TV

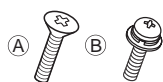

Operating Instructions

USA Only: Disposal may be regulated in your community due to Environmental considerations. For disposal or recycling information, please visit Panasonic website: <http://www.panasonic.com/environmental> or call 1-888-769-0149.

English

Thank you for purchasing this Panasonic product. Please read these instructions before operating your set and retain them for future reference. The images shown in this manual are for illustrative purposes only.

Register online at www.panasonic.com/register
 (U.S. customers only)



HDA70D32021

Contents

Safety Precautions	2
Note to CATV System Installer	2
Secure Ventilation	2
Important Safety Instructions	2
FCC STATEMENT	3
CHILD SAFETY	3
Attaching the pedestal to TV.....	4
Connection Panels.....	5
AV cable connection.....	5
Audio connection.....	6
Audio ARC connection.....	6
Using Controls on the TV	6
Indicators on the TV.....	6
Power cord connection	6
Installing the remote's batteries	6
Remote control.....	7
First Time Setup.....	7
Watching TV.....	8
Listen with SAP (Secondary Audio Programming)...8	
Closed Caption (CC)	8
Displaying information	8
Display the "Options menu".....	8
Call up a Favorite channel	8
Password setting/entering	8
Set the "Sleep timer"	8
How to Use Menu Functions	9
Using Media player.....	11
Supported file format in Media Player.....	13
Specifications	13
Limited Warranty (for U.S.A. and Puerto Rico only)	14
Limited Warranty (for Canada).....	14
Customer Services Directory (for U.S.A. and Puerto Rico)	15
Accessory Purchases (United States and Puerto Rico)	15

This product incorporates some kinds of open source software. The software is distributed in the hope that it will be useful, but WITHOUT ANY WARRANTY, without even the implied warranty of MERCHANTABILITY or FITNESS FOR A PARTICULAR PURPOSE. Please refer to the detailed terms and conditions thereof shown in the "License" menu on this product.

Panasonic does not guarantee operation and performance of peripheral devices made by other manufacturers; and we disclaim any liability or damage arising from operation and/or performance from usage of such other maker's peripheral devices.

HDMI, the HDMI logo and High- Definition Multimedia Interface are trademarks or registered trademarks of HDMI Licensing LLC in the United States and other countries.

Manufactured under license from Dolby Laboratories. Dolby and the double-D symbol are trademarks of Dolby Laboratories.

Support models: TC-L32B6/TC-32LB64



Energy Star is a joint program of the US Environmental Protection Agency and the U.S. Department of Energy. It is administered in Canada by Natural Resources Canada (NRC) through the Office of Energy Efficiency (OEE). This program is helping to protect the environment and save money through energy efficient products and practices. This product qualifies for ENERGY STAR in the "Home Use" setting and this is the setting in which energy savings will be achieved. Any modifications to the "Home Use" setting or other factory default settings could result in greater energy consumption beyond levels that meet ENERGY STAR qualifications.

Safety Precautions



The lightning flash with arrowhead within a triangle is intended to tell the user that parts inside the product are a risk of electric shock to persons.



The exclamation point within a triangle is intended to tell the user that important operating and servicing instructions are in the papers with the appliance.

Note to CATV System Installer

This reminder is provided to direct the CATV system installer's attention to Article 820-40 of the NEC that provides guidelines for proper grounding and, in particular, specifies that the cable ground shall be connected to the grounding system of the building, as close to the point of cable entry as practical.

Secure Ventilation

Slots and openings in the cabinet and the back or bottom are provided for ventilation, and to ensure reliable operation of the LCD TV and to protect it from overheating. These openings must not be blocked or covered. There should be at least 10 cm of space around the TV. The openings should never be blocked by placing the LCD TV on a bed, sofa, rug or other similar surface. This LCD TV should not be placed in a built-in installation such as a bookcase unless proper ventilation is provided.

Important Safety Instructions

- 1) Read these instructions.
- 2) Keep these instructions.
- 3) Heed all warnings.
- 4) Follow all instructions.
- 5) Do not use this apparatus near water.
- 6) Clean only with dry cloth.
- 7) Do not block any ventilation openings. Install in accordance with the manufacturer's instructions.
- 8) Do not install near any heat sources such as radiators, heat registers, stoves or other apparatus (including amplifiers) that produce heat.
- 9) Do not defeat the safety purpose of the polarized or grounding-type plug. A polarized plug has two blades with one wider than the other. A grounding type plug has two blades and a third grounding prong. The wide blade or the third prong are provided for your safety. If the provided plug does not fit into your outlet, consult an electrician for replacement of the obsolete outlet.
- 10) Protect the power cord from being walked on or pinched particularly at plugs, convenience receptacles, and the point where they exit from the apparatus.
- 11) Only use attachments / accessories specified by the manufacturer.
- 12) Use only with the cart, stand, tripod, bracket or table specified by the manufacturer, or sold with the apparatus. When a cart is used, use caution when moving the cart / apparatus combination to avoid injury from tip-over. 
- 13) Unplug this apparatus during lightning storms or when unused for long periods of time.
- 14) Refer all servicing to qualified service personnel. Servicing is required when the apparatus has been damaged in any way, such as power-supply cord or plug is damaged, liquid has been spilled or objects have fallen into the apparatus, the apparatus has been exposed to rain or moisture, does not operate normally, or has been dropped.
- 15) Operate only from the type of power source indicated on the marking label. If you are not sure of the type of power supplied to your home consult your television dealer or local power company.
- 16) Follow all warnings and instructions marked on the LCD TV.

- 17) Never push objects of any kind into this LCD TV through cabinet slots as they may touch dangerous voltage points or short out parts that could result in a fire or electric shock. Never spill liquid of any kind on the LCD TV.
- 18) If an outside antenna is connected to the television equipment, be sure the antenna system is grounded so as to provide some protection against voltage surges and built up static charges. In the U.S. Section 810-21 of the National Electrical Code provides information with respect to proper grounding of the mast and supporting structure, grounding of the lead-in wire to an antenna discharge unit, size of grounding conductors, location of antenna discharge unit, connection to grounding electrodes, and requirements for the grounding electrode.

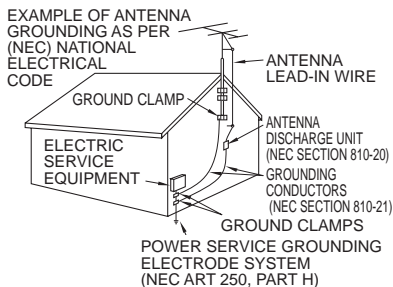

- 19) An outside antenna system should not be located in the vicinity of overhead power lines, other electric light, power circuits, or where it can fall into such power lines or circuits. When installing an outside antenna system, extreme care should be taken to keep from touching such power lines or circuits as contact with them might be fatal.
- 20) Unplug this LCD TV from the wall outlet and refer servicing to qualified service personnel under the following conditions:
 - a. When the power cord or plug is damaged or frayed.
 - b. If liquid has been spilled into the LCD TV.
 - c. If the LCD TV has been exposed to rain or water.
 - d. If the LCD TV does not operate normally by following the operating instructions. Adjust only those controls that are covered by the operating instructions as improper adjustment of other controls may result in damage and will often require extensive work by a qualified technician to restore the LCD TV to normal operation.
 - e. If the LCD TV has been dropped or the cabinet has been damaged.
 - f. When the LCD TV exhibits a distinct change in performance - this indicates a need for service.
- 21) When replacement parts are required, be sure the service technician uses replacement parts specified by the manufacturer that have the same characteristics as the original parts. Unauthorized substitutions may result in fire, electric shock, or other hazards.
- 22) **WARNING: TO REDUCE THE RISK OF FIRE OR ELECTRIC SHOCK, DO NOT EXPOSE THIS APPARATUS TO RAIN, MOISTURE, DRIPPING OR SPLASHING. DO NOT PLACE LIQUID CONTAINERS (FLOWER VASES, CUPS, COSMETICS, ETC.) ABOVE THE SET (INCLUDING ON SHELVES ABOVE, ETC.).**
- 23) **WARNING: SMALL PARTS CAN PRESENT CHOKING HAZARD IF ACCIDENTALLY SWALLOWED. KEEP SMALL PARTS AWAY FROM YOUNG CHILDREN. DISCARD UNNEEDED SMALL PARTS AND OTHER OBJECTS, INCLUDING PACKAGING MATERIALS AND PLASTIC BAGS/ SHEETS TO PREVENT THEM FROM BEING PLAYED WITH BY YOUNG CHILDREN, CREATING THE POTENTIAL RISK OF SUFFOCATION.**
- 24) **WARNING:** To prevent the spread of fire, keep candles or other open flames away from this product at all times. 
- 25) **WARNING:** A warning that batteries (battery pack or batteries installed) shall not be exposed to excessive heat such as sunshine, fire or the like.

- 26) **CAUTION:** The Power switch on this unit will not completely shut off all power from AC outlet. Since the power cord serves as the main disconnect device for the unit, you will need to unplug it from the AC outlet to shut down all power. Therefore, make sure the unit has been installed so that the power cord can be easily unplugged from AC outlet in case of an accident. To avoid fire hazard, the power cord should also be unplugged from the AC outlet when left unused for a long period of time (for example, when on vacation).
- 27) **CAUTION:** TO PREVENT ELECTRIC SHOCK, DO NOT USE THIS PLUG WITH A RECEPTACLE OR OTHER OUTLET UNLESS THE BLADES CAN BE FULLY INSERTED TO PREVENT BLADE EXPOSURE.
- 28) **CAUTION:** USE WITH OTHER STAND MAY RESULT IN INSTABILITY POSSIBLY CAUSING INJURY.
- 29) **CAUTION:** DANGER OF EXPLOSION IF BATTERY IS INCORRECTLY REPLACED. REPLACE ONLY WITH THE SAME OR EQUIVALENT TYPE.

NOTE:

- This equipment is designed to operate in North America and other countries where the broadcasting system and AC house current are exactly the same as in North America.

FCC STATEMENT

This equipment has been tested and found to comply with the limits for a Class B digital device, pursuant to Part 15 of the FCC Rules. These limits are designed to provide reasonable protection against harmful interference in a residential installation. This equipment generates, uses and can radiate radio frequency energy and, if not installed and used in accordance with the instructions, may cause harmful interference to radio communications. However, there is no guarantee that interference will not occur in a particular installation. If this equipment does cause harmful interference to radio or television reception, which can be determined by turning the equipment off and on, the user is encouraged to try to correct the interference by one or more of the following measures:

- Reorient or relocate the receiving antenna.
- Increase the separation between the equipment and receiver.
- Connect the equipment into an outlet on a circuit different from that to which the receiver is connected.
- Consult the dealer or an experienced radio/TV technician for help.

This device complies with Part 15 of the FCC Rules. Operation is subject to the following two conditions: (1) This device may not cause harmful interference, and (2) this device must accept any interference received, including interference that may cause undesired operation.

FCC Caution: To assure continued compliance, follow the attached installation instructions and use only shielded interface cables when connecting to computer or peripheral devices. Any changes or modifications not expressly approved by Panasonic Corp. of North America could void the user's authority to operate this device.

**Models: TC-L32B6/TC-32LB64/
TC-L39B6/TC-L50B6**

Responsible Party: Panasonic Corporation of North America
One Panasonic Way, Secaucus, NJ 07094

Contact Source: Panasonic Consumer Marketing Company of North America
1-877-95-VIERA (958-4372)

email: consumerproducts@panasonic.com

CHILD SAFETY:

It Makes A Difference How and Where You Use Your Flat Panel Display

Congratulations on your purchase! As you enjoy your new product, please keep these safety tips in mind:



THE ISSUE

- The home theater entertainment experience is a growing trend and larger flat panel displays are popular purchases. However, flat panel displays are not always supported on the proper stands or installed according to the manufacturer's recommendations.
- Flat panel displays that are improperly situated on dressers, bookcases, shelves, desks, speakers, chests or carts may fall over and cause injury.

THIS MANUFACTURER CARES!

- The consumer electronics industry is committed to making home entertainment enjoyable and safe.

TUNE INTO SAFETY

- One size does NOT fit all. Follow the manufacturer's recommendations for the safe installation and use of your flat panel display.
- Carefully read and understand all enclosed instructions for proper use of this product.
- Don't allow children to climb on or play with furniture and television sets.
- Don't place flat panel displays on furniture that can easily be used as steps, such as a chest of drawers.
- Remember that children can become excited while watching a program, especially on a "larger than life" flat panel display. Care should be taken to place or install the display where it cannot be pushed, pulled over, or knocked down.
- Care should be taken to route all cords and cables connected to the flat panel display so that they cannot be pulled or grabbed by curious children.



WALL MOUNTING: IF YOU DECIDE TO WALL MOUNT YOUR FLAT PANEL DISPLAY, ALWAYS:

- Use a mount that has been recommended by the display manufacturer and/or listed by an independent laboratory (such as UL, CSA, ETL).
- Follow all instructions supplied by the display and mount manufacturers.
- If you have any doubts about your ability to safely install your flat panel display, contact your retailer about professional installation.
- Make sure that the wall where you are mounting the display is appropriate. Some wall mounts are not designed to be mounted to walls with steel studs or old cinder block construction. If you are unsure, contact a professional installer.
- A minimum of two people are required for installation. Flat panel displays can be heavy.

The American Academy of Pediatrics discourages media viewing for children younger than 2 years. For more details, see www.aap.org



Attaching the pedestal to TV

Set-up

- Fix securely with assembly screws **A**. (Total 4 screws)
- Tighten screws firmly.
- Tighten assembly screws **B** (total 4 screws) loosely at first, then tighten them firmly to fix securely.

32"

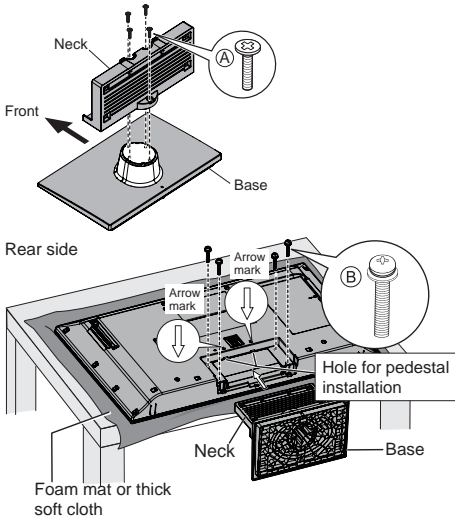

39" and 50" TV

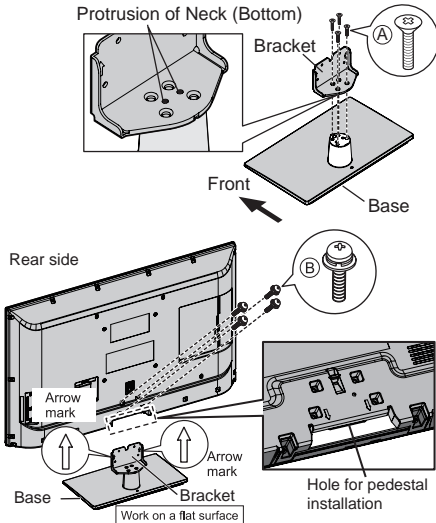

WARNING

Do not disassemble or modify the pedestal.

- Otherwise the TV may fall over and become damaged, and personal injury may result.

Caution

Do not use any pedestal other than that provided with this TV.

- Otherwise the TV may fall over and become damaged, and personal injury may result.

Do not use the pedestal if it becomes warped or physically damaged.

- If you use the pedestal when it is physically damaged, personal injury may result. Contact your nearest Panasonic Dealer immediately.
- During set-up, make sure that all screws are securely tightened.
- If sufficient care is not taken to ensure screws are properly tightened during assembly, the pedestal will not be strong enough to support the TV, and it might fall over and become damaged, and personal injury may result.

Optional accessories

Wall-hanging bracket (not supplied)

Use the screws that are threaded into the stand-mounting inserts on the back of your LCD TV to secure it to a Wall Mounting kit.

It is safe to use long screws for this product.

When using long screws, the two bottom screws may loosen, but the top two will remain tightly in place to secure the mounted TV.

Wall Mounting Inserts

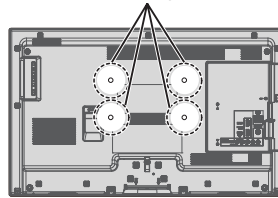

VESA standard interface

32"	200 x 100 mm
39"	200 x 200 mm
50"	400 x 400 mm

Mounting screws measurements:

M4 x 4 (only for 32")

M6 x 4 (for 39" and 50")

Please contact your nearest Panasonic dealer to purchase the recommended wall-hanging bracket. For additional details, please refer to the wall-hanging bracket installation manual.

Screw for fixing the TV onto the wall-hanging bracket (not supplied with the TV)

Depth of screw:

32" Minimum: 0.39" (10.0 mm)
32" Maximum: 0.63" (16.0 mm)

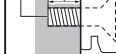

(View from the side)

Screw for fixing the TV onto the wall-hanging bracket (not supplied with the TV)

Depth of screw:

39" Minimum: 0.47" (12.0 mm)
39" Maximum: 0.87" (22.0 mm)

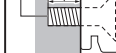

(View from the side)

WARNING

- Customer assumes liability if mounting the unit themselves or if a Panasonic bracket is not used. Any damage resulting from not having a professional installer mount your unit will void your warranty.
- Always be sure to ask a qualified technician to perform any necessary set-up. Incorrect fitting may cause equipment to fall, resulting in injury and product damage.
- Do not mount the unit directly below ceiling lights (such as spotlights, floodlights or halogen lights) which typically give off high heat. Doing so may warp or damage plastic cabinet parts.
- Take care when fixing wall brackets to the wall. Always ensure that there are no electrical cables or pipes in the wall before hanging bracket.
- When using an angled-type wall hanging bracket, please ensure that there is sufficient space for the connecting cables so that they do not press against the wall when the TV is tilted forward.
- For safety reasons, remove units no longer being used from their wall-mounted locations.

Connection Panels

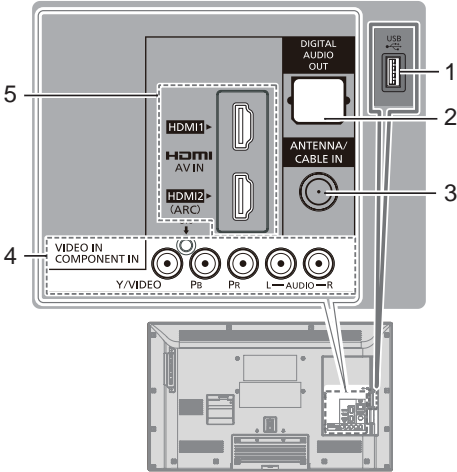

Back of the TV

- 1 USB port
- 2 DIGITAL AUDIO OUT
- 3 ANTENNA / CABLE IN
- 4 Video IN / COMPONENT IN
- 5 HDMI 1 - 2

Note:

- When using a Cable box, external equipment and video cables shown in this manual are not supplied with the TV.
- For additional assistance, visit us at: www.panasonic.com/help
www.panasonic.ca

AV cable connection

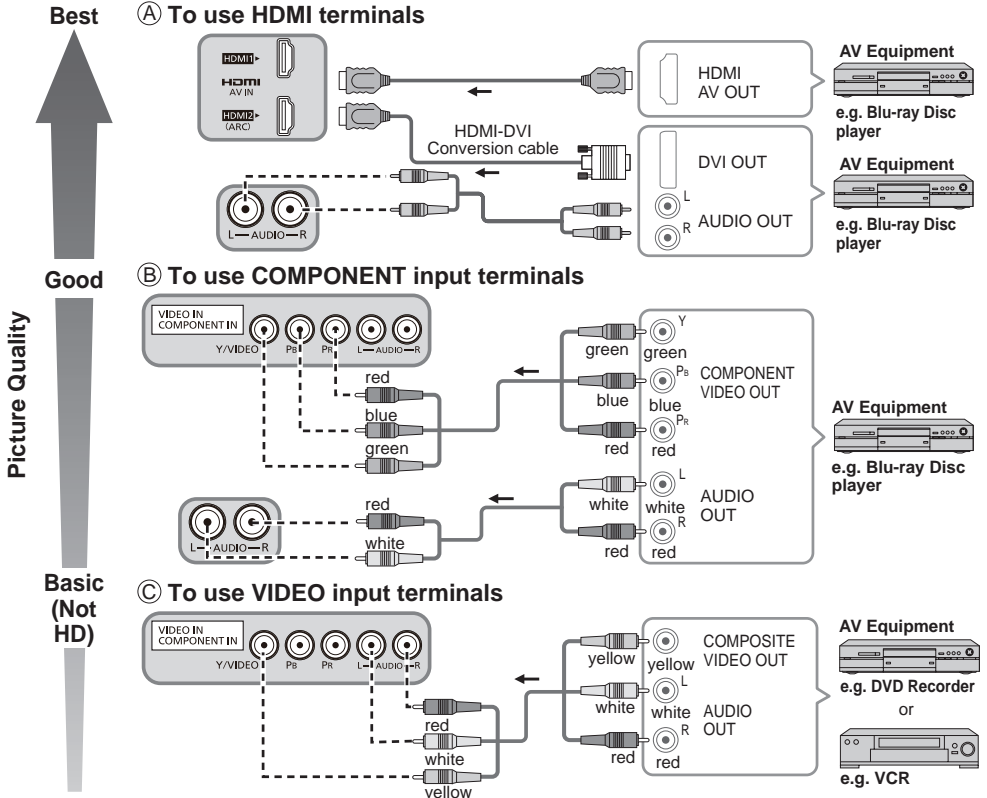

Audio connection

- Listen to your TV through your stereo

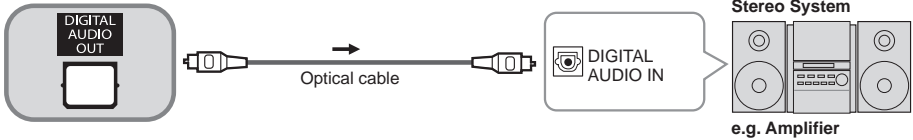

Audio ARC connection

- Listen to your TV through your HDMI AMP

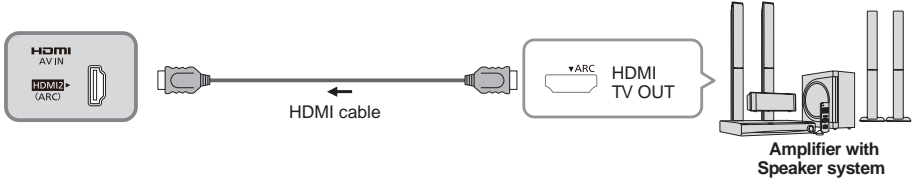

Using Controls on the TV

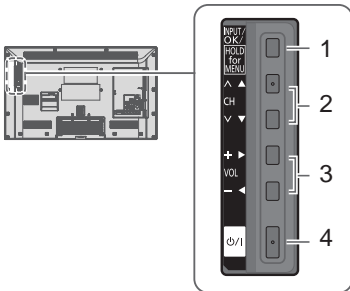

1 Changes the input mode

- Chooses menu and submenu entries, and returns (Press and hold down for MENU function)

2 Channel up/down

3 Volume up/down

4 Power button

Power cord connection

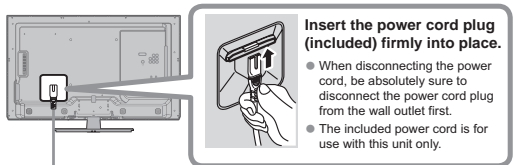

Installing the remote's batteries

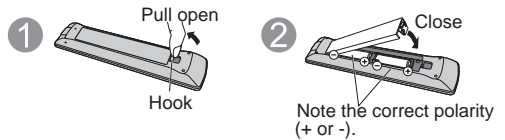

Caution:

- Incorrect installation may cause battery leakage and corrosion, resulting in damage to the remote control.
- Do not mix old and new batteries.
- Do not mix different battery types (such as alkaline and manganese batteries).
- Do not use rechargeable (Ni-Cd) batteries.
- Do not burn or break batteries.

Indicators on the TV

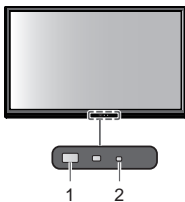

1 Remote control signal receiver

- Remote control sensor range is about 23 feet (7 meters) in front of the TV set

2 Power LED

- ON: red
- OFF: no light

Note:

- The TV consumes a small amount of electric energy even when turned off.
- Do not place any objects between the TV remote control sensor and remote control.

Remote control

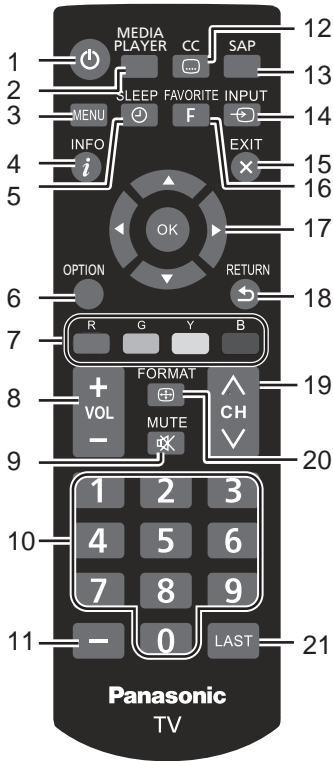

- 1 **POWER** - Switches TV On or Off.
- 2 **MEDIA PLAYER** - Viewing media contents from a USB.
- 3 **MENU** - Press to display the menu screen .
- 4 **INFO** - Displays TV status information as well as program details.
- 5 **SLEEP** - Accesses the sleep timer.
- 6 **OPTION** - Displays Options menu for special functions (when available)
- 7 **COLOR KEY** - Red/Green/Yellow/Blue key for various function.
- 8 **Volume Up / Down (VOL+ / -)** - Press to decrease or increase the audio volume.
- 9 **MUTE** - Turns off/on the sound.
- 10 **Channel Numbers** - Directly tune channels.
- 11 **—** - Use for digital channels.
- 12 **CC** - Switches the Closed Caption mode On or Off.
- 13 **SAP** - Select the Audio mode for watching TV. (SAP : Secondary Audio Programming).
- 14 **INPUT** - Select input sources "ANT/Cable in", "HDMI 1", "HDMI 2", "Component", "Video" by pressing INPUT button on Remote Control.
- 15 **EXIT** - Exit from the menu screen.
- 16 **FAVORITE** - Accesses the favorite channels.
- 17 **OK / ▲▼◀▶** - Selects/OK/Change.
- 18 **RETURN** - Press to return to previous menu.
- 19 **Channel Up / Down (CH ^ / v)** - Press to switch to the last or next channel.
- 20 **FORMAT** - To cycle through the aspect ratio modes.
- 21 **LAST** - Switches to previously viewed channel or input.

First Time Setup

First time setup screen is only displayed automatically after the power cord is inserted into a wall outlet and the TV is turned on for the first time.

- **Turn the TV On with the "POWER" button**
- **Select your language**
English/Español/Français
- **Set viewing mode**
 - 1 Select your viewing mode (Be sure to select "**Home use**")
 - 2 Please confirm your selection (**Home use**) before pressing the **OK** button.
 - If you select "Store demonstration" by mistake in "Set viewing mode", confirmation screen will be displayed.
 - Select "No" and return to previous screen "Set viewing mode".
 - If you select "Yes", screen enters the store demonstration mode.
 - To display the "Set viewing mode" screen again as shown above and select "**Home use**", perform "**Reset to defaults**" in the "**Setup**" menu.
 - If you perform "Reset to defaults", please do not unplug the AC Cord while the TV is being reset.
- **ANT/Cable setup (Auto channel setup)**
 - 1 Select signal type "Over-the-Air" or "Cable service".
 - 2 Select "**Auto program**" and start scanning, the channel scanning starts.
- **Finished First time setup.**
Congratulations! Setup is complete.

To watch TV via a Cable box, Satellite receiver, or any other source (DVD, DVR, gaming device, etc.), press the **INPUT** button and select the appropriate input.

Note:

- If you turn the TV off before completing "First time setup", the initial setup will not launch again the next time you power on the unit.
- You can repeat "First time setup" by selecting "Reset to defaults" in the "Setup" menu.
- After "First time setup", you can also change "Language" and "ANT/Cable setting" from the "Setup" and "TV" menus respectively.
- About broadcasting systems
Analog (NTSC): Conventional broadcasting
Digital (ATSC): Digital TV Standards include digital high-definition television (HDTV), standard-definition television (SDTV), data broadcasting, multi-channel surround sound audio and interactive television.

Watching TV

■ Turn power on

- Select correct input.

■ Select a channel number

To directly enter the digital channel number
Also press CH \wedge / CH \vee buttons on Side Controls or CH \wedge / CH \vee buttons on Remote Controls to select programs.

- Press CH \wedge button to select next channel.
- Press CH \vee button to select previous channel.

For Cable/Satellite box connection-

Use your connected box's remote control.

Note:

- Reselect "Cable" or "Antenna" in "ANT in" of "TV" settings menu to switch the signal reception between cable TV and antenna.
- The channel number and volume level remain the same even after the TV is turned off.

Listen with SAP (Secondary Audio Programming)

■ Select the Audio mode for watching TV

Digital mode

Press [SAP] to select next Audio track (if available) when receiving a digital channel.

Analog mode

Press [SAP] to select the desired Audio mode.

- Each press of [SAP] will change the Audio mode. ("Stereo" / "SAP" / "Mono")
- The selected mode is only set for the program you are watching at the moment.
- SAP is not available when watching TV with a Cable or Satellite box connected via HDMI.
- Contact your Cable or Satellite operator for instructions on enabling SAP with their box.

Closed Caption (CC)

■ Press [CC] to select the CC1/CC2/CC3/CC4, receiving mode and CC setting in menu.

- The selected mode is only set for the program you are watching at the moment.
- Closed Caption is not available when watching TV with a Cable or Satellite box connected via HDMI.
- Contact your Cable or Satellite operator for instructions on enabling CC with their box.
- The CC service is depend on the input signal.

Displaying information

■ Displays or hides information. Shows the channel banner when watching programs via the Antenna/Cable input.

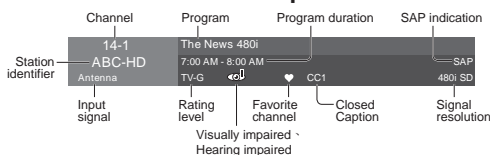

Display the "Options menu"

■ Press [OPTION] to show the "Options menu"

This menu consists of shortcuts to convenient functions.
This menu is only available when the TV is using the Antenna/Cable input, not when using Cable or Satellite box.

Channel surf mode

Specify favorites or type of channels to view when pressing the [◀ / ▶ Left / Right] button.

- "All" / "Favorite" / "Digital only" / "Analog only"
- "Favorite": Only channels registered as FAVORITE.

Signal meter

Check the signal strength if interference is found or freezing occurs on a digital image.

- If the signal is weak, check the antenna. If a problem is found, consult your local dealer.

Call up a Favorite channel

■ FAVORITE

Channel numbers registered in Favorite are displayed on the "Favorite list" screen. Select the desired channel with the up/down cursor.

To set Favorite channels

While viewing the channel that you want to set:

- "All" / "Favorite" / "Digital only" / "Analog only"
- "Favorite": Only channels registered as FAVORITE.
- When watching a Favorite channel, the icon "♥" will be displayed on the channel banner.
- You can set up to 10 channels as Favorite.
- If you set a new channel in a used slot, the original Favorite channel will be deleted first then you can add a new one.
- You can set Favorite channels when using Cable or Satellite box.

To delete Favorite channels

- Select the channel you want to remove, then press OK button.
- The icon "♥" will be removed from the channel banner.

Password setting/entering

You need to enter the password when you access locked channel or inputs.

■ Input your 4-digit password

- If it is your first time entering the password, please enter "1234". This is the default password.
- **To change password** - Input the new 4-digit password twice.
- Make a note of your password. Do not forget it. (If you have forgotten your password, consult your local dealer.)
- When you select a locked channel, a message will be displayed that allows you to view the channel after you input your password.

Set the "Sleep timer"

The TV automatically goes into Standby after the selected period.

■ Press [SLEEP] repeatedly until the desired time appears.

Note:

- It is also possible to set the time from "Sleep timer" in the "Setup" menu.
- To cancel, set to "Off" or turn off the TV.
- When the remaining time is within 3 minutes, the remaining time will flash on screen.
- "Off" / "15" / "30" / "60" / "90" (minutes)

How to Use Menu Functions

Various menus allow you to make settings for the picture, sound, and other functions so that you can enjoy watching TV best suited for you.

- 1 Press **MENU** button, the menu will be displayed.
- 2 Press **▲▼** buttons to select item desired.
- 3 Press **◀▶** buttons to adjust value.
- 4 Press **RETURN** button return to the previous menu.

■ Display the menu

- Shows the functions that can be adjusted.
- Some functions will be disabled depending on the type of input signal.

Menu structure

Menu bar

Press **[OK]** or **[right cursor]** to move to the menu items.

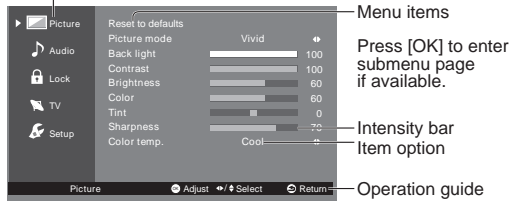

(example: "Picture" menu)

Select the menu

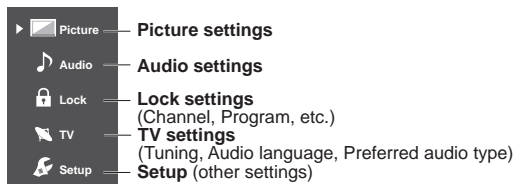

Adjust or select a menu item

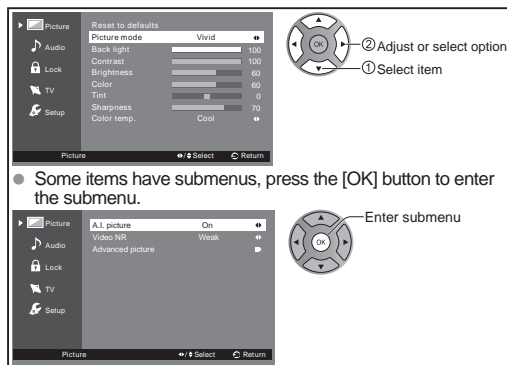

Settings	Items	Option
Picture	Reset to defaults	Resets all picture adjustments to factory default settings.
	Picture mode	Vivid/Standard/Cinema/Game/Custom
	Back light	[Adjusts the luminance of the back light.]
	Contrast, Brightness, Color, Tint, Sharpness	[Adjusts the color, brightness, etc. for each picture mode to suit your preference]
	Color temp.	Cool/Normal/Warm • Selects a choice of Cool (blue), Normal, or Warm (red) color.
	A.I. picture	Off/On • Controls dark areas without affecting the black level or brightness in the overall picture.
	Video NR (DOT NOISE REDUCTION)	Off/Weak/Medium/Strong • Reduces noise, commonly called snow. Leave it off when receiving a strong signal.
		• Some menus are grayed out depending on the input signal or condition.
	Advanced picture	3D Y/C Filter : Minimizes noise and cross-color in the picture. Color matrix : Selects image resolution of component-connected devices. SD: Standard-Definition HD: High-Definition Only used with 480p video signal. Black level : Selects Dark or Light. Valid only for external input signals. MPEG NR : Reduces picture noise in MPEG-compressed video. • For Digital TV only 3:2 pulldown : (Off/Auto) Adjusts the picture recorded in 24 fps for optimum quality. Aspect adjustments : Screen format (FULL/4:3/JUST/ZOOM/H-FILL) Changes the format (aspect ratio). Lets you choose the aspect depending on the format of received signal. H size (Size1/Size2) Adjusts the horizontal display range to reduce noise of both side edges of an image. Size 2: Adjusts the image size according to the aspect mode to reduce noise. HD size (Size1/Size2) 1: Display 95% of HD signal, to trim noise at the edges of the screen. 2: Full image. Zoom adjustments (V-position/V-size) Adjusts vertical alignment and size when aspect setting is "Zoom".

Settings	Items	Option
Audio	Reset to defaults	Resets all audio adjustments to factory default settings.
	Bass	[Increases or decreases the bass response.]
	Treble	[Increases or decreases the treble response.]
	Balance	[Emphasizes the left / right speaker volume.]
	Surround	Off/On Enhances audio L/R response when listening to stereo.
	TV speakers	Off/On Switches to "Off" when using external speakers. Off: "Surround" does not work if "Off" is selected.
	Digital audio out	Auto : Bypass DTS signal if input source is DTS format, or fixed output to Dolby Digital besides DTS source. PCM : Digital output signal is fixed to PCM.
Audio input	HDMI1-2 in : Digital/Analog Select audio input terminal when DVI cable is connected. (Analog audio input signal)	

You will be asked to enter your password each time you display the "Lock" menu.

Settings	Items	Option
Lock	Mode	Off : Unlocks all the Lock settings of "Channel", "Program" and "Input". All : Locks all the inputs regardless of the Lock settings of "Channel", "Program" and "Input". Custom : Locks specified inputs of "Channel", "Program" and "Input".
	Channel (These channels will be blocked regardless of the program rating.)	[Select a channel to lock.]
	Program (To set a rating level)	Mode: (Off/On) Set program lock status. "V-chip" technology enables restricted shows to lock according to TV ratings. On: Set each rating level (U.S.TV Ratings, U.S. Movie Ratings, Canadian English ratings., Canadian French ratings.) U.S.TV ratings/U.S. Movie ratings/Canadian English ratings/Canadian French ratings
	Input	HDMI1/HDMI2/Component/Video Locks external inputs accordingly.
	Change password	[Changes the password. Input the new 4-digit password twice.]

- This television is designed to support the "Downloadable U.S. Region Rating System" when available. (Available only in the U.S.A.)
- The Off rating is independent of other ratings.
- When placing a lock on a specific-age-based-rating level, the Off rating and any other more restrictive ratings will also be blocked.

Settings	Items	Option
TV	ANT in	Cable/Antenna
	Auto program	Automatically retune the channels received in the area.
	Manual Program	Set Analogue channel manually after Automatic Channel Search.
	MTS	Stereo/SAP/Mono
	Audio Language	English/Spanish/French
	Preferred audio type	Main audio/Hearing impaired/Visually impaired Narration settings for impaired users Hearing Impaired: Activates closed captioning when available on broadcasts. Visual Impaired: Activates the narration soundtrack when available on broadcasts. • For Digital TV only.

Settings	Items	Option
Setup	Language	English/Español/Français
	Timer set	Sleep Timer : (Off/15/30/60/90 (minutes)) No signal for 10 minutes : (Stay on/ Power TV off) To conserve energy, the TV automatically turns off when NO SIGNAL and NO OPERATION continue for more than 10 minutes. No activity for 3 hours : (Stay on/ Power TV off) To conserve energy, the TV automatically turns off when no operation of remote and side panel key continues for more than 3 hours.
	Closed Caption	Displays subtitles (Closed caption)
	Input labels	You can label the terminal with the type of equipment connected to it.
	HDMI control	CEC function : (Off/On) On: The TV is turned on automatically and switches to the appropriate HDMI input whenever an HDMI connected equipment is initially turned on and the Play mode is selected. Power off link : (No/Yes) On: When the TV is turned off, all HDMI connected equipment is also automatically turned off. • A Panasonic DVD Recorder will not turn off if it is still in Rec mode. • The TV remains on even if the HDMI connected equipment is turned off.
	About	Displays TV version and software license.
	Reset to defaults	Performing reset will clear all settings made in the "Setup" menu, such as channel settings. After reset, "First time setup" will launch when you next power on the TV.

- The television includes a built-in decoder that is capable of providing a text display of the audio. The program being viewed must be transmitting the Closed Caption (CC) information.
- The settings in "Analog" or "Digital" depend on the broadcaster.

Using Media player

Media Player allows you to enjoy photo or music recorded on a USB Flash Memory.

The picture may not appear correctly on this TV depending on the recording equipment used.

- Display may be delayed when there are many files and folders.
- Partly degraded files might be displayed at a reduced resolution.
- Picture settings may not take effect depending on the conditions.
- The folder and file names may be different depending on the digital camera or digital video camera used.

Starting Media Player

■ Insert the USB Flash Memory to the TV

- Insert the device
- Remove the device

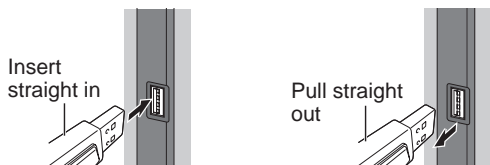

- Media player only supports USB Mass storage class devices.

COMPLIANCE:

- Supports only USB1.1 or USB2.0 standard.
- Supports file format of FAT16 or FAT32.
- Maximum USB capacity supported is 32GB.
- USB Hub or card adapter is not supported.

Viewing Contents

■ Start Media Player



■ Select the contents

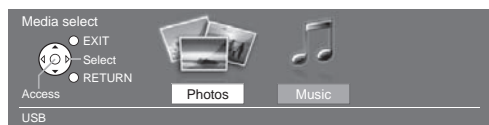

■ Select the data [Photos] / [Music]

How to view the data differs depending on data storage conditions.

- 1 Select Title/Folder
- 2 Select file

■ View or play

Thumbnail / Playback view image and operation differ depending on selected contents.

Photos view

Supported file format → (p.13)

The thumbnail of all the photos in the USB Flash Memory will be displayed.

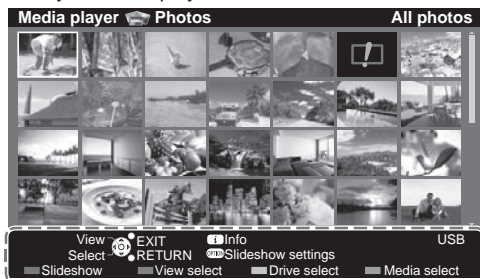

Operation guide

Features

- Slideshow → R
- View select → G
- Drive select → Y
- Media select → B

☐ : Error display

Displays data information (file name, date, size, etc.) and differs depending on selected data.



[View select]

- 1 Display the viewing mode selection screen



- 2 Select the view type

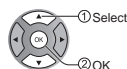

- Folder view: Displays the thumbnails grouped by folders

- 3 Select folder view to display the thumbnails of the selected group

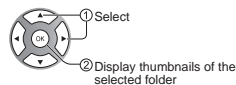
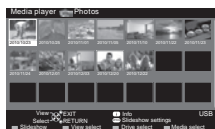

- To return to the thumbnail of all photos



[Slideshow settings]

1 Display the “Slideshow settings” screen

OPTION



2 Select the items and set

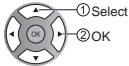
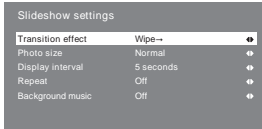

■ Transition effect

Effect for photo switching during slideshow. [None] / [Dissolve] / [Wipe →] / [Wipe ←] / [Wipe ↑] / [Wipe ↓] / [Box in] / [Box out] / [Random]

■ Photo size

Selects enlarged or normal viewing mode on Single view and Slideshow. [Normal] / [Zoom]

- Depending on the photo size, the photo may not be enlarged.

■ Display interval

Sets the interval for each image to be displayed in the Slideshow mode. [5] / [10] / [15] / [30] / [60] / [90] / [120] (seconds)

■ Repeat

Turn the slideshow repeat (cycle) function on or off. [Off] / [On]

■ Background music

Selects the background music during Photo mode [Off] / [Type1] / [Type2] / [Type3]

- [Type1], [Type2] and [Type3] are the fixed music each installed in this TV.

Note:

- Picture quality may suffer depending on the slideshow settings.
- Picture setting may not work depending on the slideshow settings.

Music play

Supported file format ➔ (p.13)

Music folders in the USB Flash Memory will be displayed.

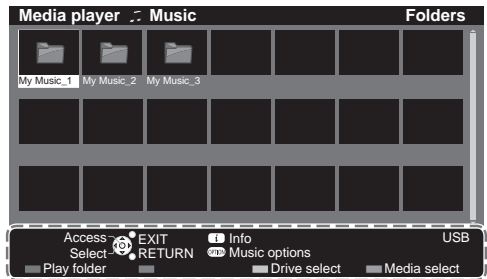

Operation guide

Features

- Play folder ➔
- Drive select ➔
- Media select ➔

[Music options]

1 Display the “Music options” screen

OPTION



2 Set the play repeat mode to your preference

■ Repeat

([Off] / [One] / [Folder])

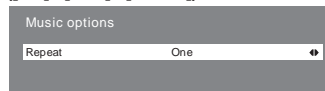

[Other settings in Media player]

1 Display the menu

MENU

2 Select the “Picture” item

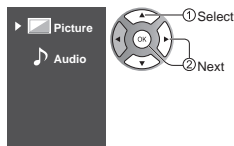

3 Set

■ Adjust the Picture and Audio

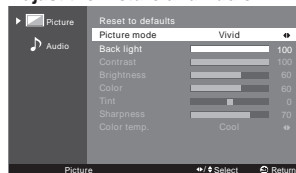

- Some items are grayed out to indicate that these items are not available. Availability depends on the contents you are enjoying.

Supported file format in Media Player

■ Photos

Format	File extension
JPEG	.jpg .jpeg
Image resolution (pixel)	Details / Restrictions
4 × 4 to 15,360 × 8,640	DCF and EXIF standards Sub-sampling: 4:4:4, 4:2:2, 4:2:0 ● Progressive JPEG is not supported.

■ Music

Codec	File extension
MP3	.mp3
Restrictions	
Bit rate support ● 32/40/48/56/64/80/96/112/128/160/192/224/256/320 kbits/s ● VBR no support	

Note:

- Some files may not be played back even if they fulfill these conditions.
- Do not use two-byte characters or other special codes for data.
- The device may become unusable with this TV if the file or folder names are changed.
- The picture may not appear correctly on this TV depending on the recording equipment used.
- Display may take some time when there are many files and folders.
- The function cannot display Motion JPEG and still image not DCF formatted (i.e. TIFF, BMP).
- Data modified with a PC may not be displayed.
- Images imported from a PC must be compatible with EXIF 2.0, 2.1 and 2.2.
- Partly degraded files might be displayed at a reduced resolution.
- All ".JPG" extension data in the USB flash memory will be read in Photo viewer Mode.
- The folder and file names may be different depending on the digital camera used.

Specifications

Power rating

AC 110-127 V, 60 Hz

Rated Power Consumption

32" : 60 Watts ; 39" : 91 Watts ; 50" : 137 Watts

Standby condition

32" : 0.3 Watts ; 39" : 0.3 Watts ; 50" : 0.3 Watts

Visible screen size (diagonal)

32" class : 31.5 inch (80cm)

39" class : 38.5 inch (98cm)

50" class : 49.5 inch (127cm)

Number of pixels

32" HD (1366X768)

39" FHD (1920X1080)

50" FHD (1920X1080)

Dimensions (W × H × D) (Including Stand)

32" : 29.2" × 20.3" × 7.3" (741 mm × 515 mm × 184 mm)

39" : 35.3" × 23.7" × 8.6" (896 mm × 602 mm × 217 mm)

50" : 44.9" × 29.1" × 10.9" (1139 mm × 739 mm × 275 mm)

Net Weight

32" : 15.4lb. (7 kg) (Including Stand)

32" : 14.3lb. (6.5 kg) (TV only)

39" : 24.3lb. (11 kg) (Including Stand)

39" : 20.9lb. (9.5 kg) (TV only)

50" : 43.0lb. (19.5 kg) (Including Stand)

50" : 35.3lb. (16 kg) (TV only)

Sound System

1-way 2 bottom SP System

Channel Capability-ATSC/NTSC (Digital/Analog)

VHF/UHF: 2 - 69, CATV: 1 - 135

Sound Output

32" : 5W+5W ; 39" / 50" : 10W+10W

Maximum Visible Range

32" : 27.6" × 15.6" (701 mm × 396 mm)

39" : 33.7" × 19.0" (856 mm × 482 mm)

50" : 43.3" × 24.4" (1099 mm × 619 mm)

Operating Conditions

Temperature: 32° F - 95° F (0°C to 35°C)

Humidity: 20 % - 80 % RH (non-condensing)

- Specifications are subject to change without notice.
- The On-Screen Menu and figures in this manual may differ slightly from the product.
- USB Flash Memory format : FAT16, FAT32 (no support exFAT or NTFS).
- Some USB devices (USB HUB or card adapter) or some USB stick may not be used with this TV.

Limited Warranty (for U.S.A. and Puerto Rico only)

Panasonic Consumer Marketing Company of North America:

PANASONIC CORPORATION OF NORTH AMERICA One Panasonic Way Secaucus, New Jersey 07094

Panasonic LCD Televisions Limited Warranty

Limited Warranty Coverage

If your product does not work properly because of a defect in materials or workmanship, Panasonic Consumer Marketing Company of North America. (referred to as "the warrantor") will, for the length of the period indicated on the chart below, which starts with the date of original purchase ("warranty period"), at its option either (a) repair your product with new or refurbished parts, (b) replace it with a new or a refurbished equivalent value product, or (c) refund your purchase price. The decision to repair, replace or refund will be made by the warrantor.

LCD TV CATEGORIES	PARTS	LABOR	SERVICE
Up to 42" (diagonal)	1 (ONE) YEAR	1 (ONE) YEAR	Carry-In
46" (diagonal) and larger			On-Site

During the "Labor" warranty period there will be no charge for labor. During the "Parts" warranty period, there will be no charge for parts. You must carry-in your product or arrange for on-site service during the Limited warranty period. If non-rechargeable batteries are included, they are not warranted. This Limited Warranty only applies to products purchased and serviced in the United States or Puerto Rico. This Limited Warranty is extended only to the original purchaser of a new product which was not sold "as is". A purchase receipt or other proof of the original purchase date is required for warranty service.

On-Site or Carry-in Service

For On-Site or Carry-In Service in the United States and Puerto Rico call 1-877-95-VIERA (1-877-958-4372)

On-site service where applicable requires clear, complete and easy access to the product by the authorized servicer and does not include removal or re-installation of an installed product. It is possible that certain on-site repairs will not be completed on-site, but will require that the product or parts of the product, at the servicer's discretion be removed for shop diagnosis and/or repair and then returned.

Limited Warranty Limits And Exclusions

This Limited warranty ONLY COVERS failures due to defects in materials or workmanship, and DOES NOT COVER normal wear and tear or cosmetic damage, nor does it cover markings or retained images on the LCD panel resulting from viewing fixed images (including, among other things, non-expanded standard 4:3 pictures on wide screen TV's, or onscreen data in a stationary and fixed location). The Limited Warranty ALSO DOES NOT COVER damages which occurred in shipment, or failures which are caused by products not supplied by the warrantor, or failures which result from accidents, misuse, abuse, neglect, bug infestation, mishandling, misapplication, alteration, faulty installation, set-up adjustments, misadjustment of consumer controls, improper maintenance, power line surge, lightning damage, modification, or commercial use (such as in a hotel, office, restaurant, or other business), rental use of the product, service by anyone other than a Factory Service Center or other Authorized Servicer, or damage that is attributable to acts of God.

THERE ARE NO EXPRESS WARRANTIES EXCEPT AS LISTED UNDER "LIMITED WARRANTY COVERAGE". THE WARRANTOR IS NOT LIABLE FOR INCIDENTAL OR CONSEQUENTIAL DAMAGES RESULTING FROM THE USE OF THIS PRODUCT, OR ARISING OUT OF ANY BREACH OF THIS LIMITED WARRANTY. (As examples, this excludes damages for lost time, cost of having someone remove or re-install an installed unit if applicable, or travel to and from the servicer. The items listed are not exclusive, but are for illustration only.) **ALL EXPRESS AND IMPLIED WARRANTIES, INCLUDING THE LIMITED WARRANTY OF MERCHANTABILITY, ARE LIMITED TO THE PERIOD OF THE LIMITED WARRANTY.**

Some states do not allow the exclusion or limitation of incidental or consequential damages, or limitations on how long an implied Limited Warranty lasts, so the exclusions may not apply to you. This Limited Warranty gives you specific legal rights and you may also have others rights which vary from state to state. If a problem with this product develops during or after the Limited Warranty period, you may contact your dealer or Service Center. If the problem is not handled to your satisfaction, then write to the warrantor's Consumer Affairs Department at the addresses listed for the warrantor.

PARTS AND SERVICE (INCLUDING COST OF AN ON-SITE SERVICE CALL, WHERE APPLICABLE) WHICH ARE NOT COVERED BY THIS LIMITED WARRANTY ARE YOUR RESPONSIBILITY.

Limited Warranty (for Canada)

Panasonic Canada Inc.

5770 Ambler Drive, Mississauga, Ontario L4W 2T3

PANASONIC PRODUCT – LIMITED WARRANTY

Panasonic Canada Inc. warrants this product to be free from defects in material and workmanship under normal use and for a period as stated below from the date of original purchase agrees to, at its option either (a) repair your product with new or refurbished parts, (b) replace it with a new or a refurbished equivalent value product, or (c) refund your purchase price. The decision to repair, replace or refund will be made by Panasonic Canada Inc.

Viera TV (46" & over)	In-home service	One (1) year, parts (including panel) and labour.
Viera TV (under 46")	Carry-in service	One (1) year, parts (including panel) and labour.

In-home Service will be carried out only to locations accessible by roads and within 50 km of an authorized Panasonic service facility. In-home service requires clear, complete and easy access to the product by the Authorized Servicer and does not include removal or re-installation of an installed product. If removal is required to service the product, it will be at the discretion of the Servicer and in no event will Panasonic Canada Inc. or the Servicer be liable for any special, indirect or consequential damages.

This warranty is given only to the original purchaser, or the person for whom it was purchased as a gift, of a Panasonic brand product mentioned above sold by an authorized Panasonic dealer in Canada and purchased and used in Canada, which product was not sold "as is", and which product was delivered to you in new condition in the original packaging.

IN ORDER TO BE ELIGIBLE TO RECEIVE WARRANTY SERVICE HERUNDER, A PURCHASE RECEIPT OR OTHER PROOF OF DATE OF ORIGINAL PURCHASE, SHOWING AMOUNT PAID AND PLACE OF PURCHASE IS REQUIRED

LIMITATIONS AND EXCLUSIONS

This warranty **ONLY** COVERS failures due to defects in materials or workmanship, and **DOES NOT COVER** normal wear and tear or cosmetic damage. The warranty **ALSO DOES NOT COVER** damages which occurred in shipment, or failures which are caused by products not supplied by Panasonic Canada Inc., or failures which result from accidents, misuse, abuse, neglect, mishandling, misapplication, alteration, faulty installation, set-up adjustments, misadjustment of consumer controls, improper maintenance, power line surge, lightning damage, modification, introduction of sand, humidity or liquids, commercial use such as hotel, office, restaurant, or other business or rental use of the product, or service by anyone other than a Authorized Servicer, or damage that is attributable to acts of God. Dry cell batteries are also excluded from coverage under this warranty.

THIS EXPRESS, LIMITED WARRANTY IS IN LIEU OF ALL OTHER WARRANTIES, EXPRESS OR IMPLIED, INCLUDING ANY IMPLIED WARRANTIES OF MERCHANTABILITY AND FITNESS FOR A PARTICULAR PURPOSE. IN NO EVENT WILL PANASONIC CANADA INC. BE LIABLE FOR ANY SPECIAL, INDIRECT OR CONSEQUENTIAL DAMAGES RESULTING FROM THE USE OF THIS PRODUCT OR ARISING OUT OF ANY BREACH OF ANY EXPRESS OR IMPLIED WARRANTY. (As examples, this warranty excludes damages for lost time, travel to and from the Authorized Servicer, loss of or damage to media or images, data or other memory or recorded content. This list of items is not exhaustive, but for illustration only.)

In certain instances, some jurisdictions do not allow the exclusion or limitation of incidental or consequential damages, or the exclusion of implied warranties, so the above limitations and exclusions may not be applicable. This warranty gives you specific legal rights and you may have other rights which vary depending on your province or territory.

WARRANTY SERVICE

For product operation and information assistance, please contact:

Our Customer Care Centre: 1-800 #: 1-866-330-0014
or visit our website: concierge.panasonic.ca

For product repairs, please contact Viera Customer Care Agent using the above contact info.

IF YOU SHIP THE PRODUCT TO A SERVICENTRE

Carefully pack and send prepaid, adequately insured and preferably in the original carton.
Include details of the defect claimed, and proof of date of original purchase.

Customer Services Directory (for U.S.A. and Puerto Rico)

Obtain Product Information and Operating Assistance; locate your nearest Dealer or Service Center; purchase Parts and Accessories; or make Customer Service and Literature requests by visiting our Web Site at:

<http://www.panasonic.com/help>

or, contact us via the web at:

<http://www.panasonic.com/contactinfo>

You may also contact us directly at:

1-877-95-VIERA (958-4372)

Monday-Friday 9 am-9 pm; Saturday-Sunday 10 am-7 pm, EST.

■ For hearing or speech impaired TTY users, TTY: 1-877-833-8855

Accessory Purchases (United States and Puerto Rico)

Purchase Parts, Accessories and Instruction Books on line for all Panasonic Products by visiting our Web Site at:

<http://www.pstc.panasonic.com>

or, send your request by E-mail to:

npccparts@us.panasonic.com

You may also contact us directly at:

1-800-332-5368 (Phone) 1-800-237-9080 (Fax Only) (Monday - Friday 9 am to 9 pm, EST.)

Panasonic National Parts Center

20421 84th Ave. S., Kent, WA 98032

(We Accept Visa, MasterCard, Discover Card, and American Express)

■ For hearing or speech impaired TTY users, TTY: 1-866-605-1277

Customer's Record

The model number and serial number of this product can be found on its back cover. You should note this serial number in the space provided below and retain this book, plus your purchase receipt, as a permanent record of your purchase to aid in identification in the event of theft or loss, and for Warranty Service purposes.

Model Number _____

Serial Number _____

**Panasonic Consumer Marketing Company of North America,
Division of Panasonic Corporation of North America**

One Panasonic Way, Secaucus

New Jersey 07094 U.S.A.

Panasonic Canada Inc.

5770 Ambler Drive

Mississauga, Ontario

L4W 2T3 CANADA