

Panasonic®

Model No.

TX-L32E5B

TX-L37E5B

TX-L42E5B

TX-L47E5B

Operating Instructions LCD Television

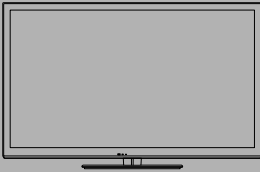

VIERA

Thank you for purchasing this Panasonic product.
Please read these instructions carefully before operating this product and
retain them for future reference.
The images shown in this manual are for illustrative purposes only.

English

UK and Ireland model



TQB0E2222

Features

DVB-T tuner built-in

Receives DVB (Digital Video Broadcasting) digital terrestrial broadcasts.

DVB-T2 tuner built-in (UK only)

DVB-T2 is an advanced digital terrestrial system for more efficient transmission.

Available DVB-T2 broadcasts will be tuned automatically when you perform DVB Auto Setup.

Sharp pictures and clear sound with HDMI connection (p. 90)

Enjoy high definition digital picture and high quality sound by using an HDMI cable.

Using USB devices

Enjoy the photo, video and music in the USB Flash Memory on Media Player. (p. 57)

USB keyboard, gamepad, etc. are available. (p. 90, 91)

Timer Programming (p. 24, 48)

Timer Programming enables you to use functions such as programme reminder and programme recording to the external recorder.

SDXC Card

This TV supports SDXC Card. SDXC is the latest standard of SD Card and a higher storage capacity card.

DLNA

DLNA is a standard that makes digital electronics easier and more convenient to use on a home network. (p. 70)

VIERA Connect - Enjoy great web entertainment (p. 18, 73)

VIERA Connect allows you to access some specific websites supported by Panasonic, and enjoy internet contents such as videos, games, EPG, communication tools, etc. from VIERA Connect home screen.

Link up and control the connected equipment with “Q-Link” and “VIERA Link” (p. 74)

Q-Link and VIERA Link provide easy recording and playback, creation of a home theatre without complicated settings, etc.

VIERA TOOLS - Display special feature icons for easy accessibility (p. 31)

Special features (such as VIERA Link and Media Player) can be accessed easily by using the VIERA TOOLS button.

Dolby Digital Plus / Dolby Pulse decoders

It is possible to decode Dolby Digital Plus / Dolby Pulse multi-channel audio tracks and output as Dolby Digital Bitstream (multi-channel sound signal) from DIGITAL AUDIO OUT / HDMI2 (ARC function) terminals.

Owner ID (p. 52)

Owner ID is an anti-theft function. Entering the PIN number and owner's personal information will help the Police to determine the owner in the case of theft.

Voice Guidance (p. 21, 36)

Voice Guidance narrates the operation of the basic features (EPG, on-screen messages, etc.) to assist visually-impaired users.

Supports Audio Description signal (p. 21, 36)

Audio Description (when broadcast) adds an additional soundtrack to describe events on screen (narration) and aids understanding and enjoyment, particularly for visually-impaired users.

Digital Switchover for Terrestrial broadcasts (UK only)

Starting in late 2007 and ending in 2012, TV services in the UK will go completely digital, TV region by TV region.

If you have any questions, please call Digital UK on **08456 50 50 50** or visit **www.digitaluk.co.uk**

Digital Switchover will cover a period of several weeks. When it starts you will lose all Analogue TV channels and some Digital TV channels will be missing.

You will need to retune your TV each time this happens to recover your digital channels. Analogue channels are permanently turned off, it will not be possible to recover them.

• To retune your TV ➔ [Auto Setup] in [DVB Tuning Menu]-DVB mode (p. 44)

Users of cable or satellite boxes should still retune the TV to continue to receive Freeview channels via their aerial. (Your Analogue channel for viewing Cable or Satellite services will change to a new position.)

• Due to the digital reception technologies involved, quality of the digital signals may be relatively low in some cases, despite good reception of analogue channels.

Transport only in upright position

Panasonic does not guarantee operation and performance of peripheral devices made by other manufacturers; and we disclaim any liability or damage arising from operation and/or performance from usage of such other maker's peripheral devices.

This product is licensed under the AVC patent portfolio license for the personal and non-commercial use of a consumer to (i) encode video in compliance with the AVC Standard ("AVC Video") and/or (ii) decode AVC Video that was encoded by a consumer engaged in a personal and non-commercial activity and/or was obtained from a video provider licensed to provide AVC Video. No license is granted or shall be implied for any other use. Additional information may be obtained from MPEG LA, LLC. See <http://www.mpegla.com>.

Rovi Corporation and/or its subsidiaries and related affiliates are not in any way liable for the accuracy or availability of the program schedule information or other data in the Rovi Guide system and cannot guarantee service availability in your area. In no event shall Rovi Corporation and/or its related affiliates be liable for any damages in connection with the accuracy or availability of the program schedule information or other data in the Rovi Guide system.

Notice for DVB / Data broadcasting / IPTV functions

This TV is designed to meet the standards (as of August, 2011) of digital services.

- Not all the features are available depending on the country, area, broadcaster, service provider and network environment.
- The compatibility with future services is not guaranteed.
- Check the latest information on the available services at the following website.

<http://panasonic.jp/support/global/cs/tv/>

Contents

Be Sure to Read

Safety Precautions	4
--------------------------	---

Quick Start Guide

Accessories / Options	6
Identifying Controls	9
Basic Connection	11
Auto Setup	14

Enjoy your TV!

Basic

Using "VIERA Connect"	18
Watching TV	19
Using TV Guide	23
Viewing Teletext	26
Watching External Inputs	29
How to Use VIERA TOOLS	31
How to Use Menu Functions	32

Advanced

Retuning from Setup Menu	44
Tuning and Editing Channels	45
Timer Programming	48
Child Lock	50
Shipping Condition	51
Owner ID	52
Using Common Interface	53
Updating the TV Software	54
Displaying PC Screen on TV	55
Advanced Picture Settings	56
Using Media Player	57
Using Network Services (DLNA / VIERA Connect) ..	65
Link Functions (Q-Link / VIERA Link)	74
External Equipment	82

Others

Technical Information	85
FAQs	94
On-screen messages	96
Maintenance	98
Glossary	99
Licence	99
Index	101
Specifications	102

Safety Precautions

Warning

■ Mains plug and lead

To help avoid risk of electrical shock, fire, damage or injury, please follow the warnings below:

- This TV is designed to operate on AC 220-240 V, 50 / 60 Hz.
- Insert the mains plug fully into the socket outlet.
- Ensure that the mains plug is easily accessible.
- Remove the mains plug when cleaning the TV.

- Do not touch the mains plug with a wet hand.



- Do not damage the mains lead.

- Do not place a heavy object on the lead.



- Do not place the lead near a high temperature object.



- Do not pull on the lead.
Hold onto the mains plug body when disconnecting the plug.

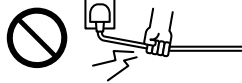

- Do not move the TV with the lead plugged into a socket outlet.
 - Do not twist the lead, bend it excessively or stretch it.
 - Do not use a damaged mains plug or socket outlet.
 - Ensure the TV does not crush the mains lead.
- Do not use any mains lead other than that provided with this TV.

If you detect anything unusual, immediately switch off the mains supply switch and remove the mains plug.

AC 220-240 V
50 / 60 Hz





IMPORTANT: THE MOULDED MAINS PLUG

FOR YOUR SAFETY, PLEASE READ THE FOLLOWING TEXT CAREFULLY.

This TV is supplied with a moulded three pin mains plug for your safety and convenience.

A 5 amp fuse is fitted in this mains plug. Shall the fuse need to be replaced, please ensure that the replacement fuse has a rating of 5 amps and that it is approved by ASTA or BSI to BS1362.

Check for the ASTA mark  or the BSI mark  on the body of the fuse.

If the mains plug contains a removable fuse cover, you must ensure that it is refitted when the fuse is replaced.

If you lose the fuse cover the mains plug must not be used until a replacement cover is obtained.

A replacement fuse cover may be purchased from your local dealer.

Do not cut off the mains plug.

Do not use any other type of mains lead except the one supplied with this TV.

The supplied mains lead and moulded plug are designed to be used with this TV to avoid interference and for your safety.

If the socket outlet in your home is not suitable, get it changed by a qualified electrician.

If the plug or mains lead becomes damaged, purchase a replacement from an authorized dealer.

How to replace the fuse

For plug type shown in example 1:

Lift out the removable fuse compartment with a screwdriver and replace the fuse, then refit securely into the mains plug (see example 1).

For plug type shown in example 2:

Lift open the fuse compartment, in the mains plug, with a screwdriver, and replace the fuse, then press the fuse cover down securely (see example 2).

Example 1

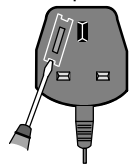

Example 2

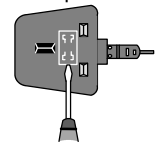

Warning

Take care

To help avoid risk of electrical shock, fire, damage or injury, please follow the warnings below:

- Do not remove covers and never modify the TV yourself as live parts are accessible when they are removed. There are no user serviceable parts inside.

- Do not expose the TV to rain or excessive moisture. This TV must not be exposed to dripping or splashing water and objects filled with liquid, such as vases, must not be placed on top of or above the TV.

- Do not expose the TV to direct sunlight and other sources of heat. To prevent fire never place any type of candle or naked flame on top or near the TV.

- Do not place the TV on sloped or unstable surfaces, and ensure that the TV does not hang over the edge of the base.

- Do not insert foreign objects into the TV through the air vents.
- Do not use an unapproved pedestal / mounting equipment. Be sure to ask your local Panasonic dealer to perform the setup or installation of approved wall-hanging brackets.
- Do not apply strong force or impact to the display panel.
- This TV is designed for Table-top use.

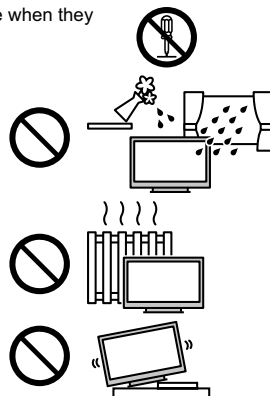

To prevent the spread of fire, keep candles or other open flames away from this product at all times



Small object

This product contains possibly dangerous parts that can be breathed in or swallowed by young children accidentally.

- Keep the dangerous parts out of reach of young children.
- Do not allow children to handle SD Card. As with any small object, the SD Card could be swallowed by young children. Please remove SD Card immediately after use and store out of reach of young children.



Caution

Ventilation

Allow sufficient space around the TV in order to help prevent excessive heat, which could lead to early failure of some electronic components.

- Ventilation should not be impeded by covering the ventilation openings with items such as newspapers, tablecloths and curtains.
- Whether you are using the pedestal or not, always ensure the vents in the bottom of the TV are not blocked and there is sufficient space to enable adequate ventilation.



Minimum distance

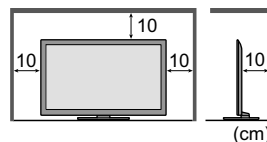

Moving the TV

Before moving the TV, disconnect all cables.

When not in use for a long time

This TV will still consume some power even in the Off mode, as long as the mains plug is still connected to a live socket outlet.

- Remove the mains plug from the wall socket when the TV is not in use for a prolonged period of time.

Excessive volume

Do not expose your ears to excessive volume from the headphones. Irreversible damage can be caused.



Accessories / Options

Standard accessories

Remote Control

- N2QAYB000753



Batteries for the Remote Control (2)

- R6
- ➔ (p. 7)



Pedestal ➔ (p. 7, 8)

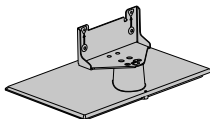

Mains lead ➔ (p. 11)

- TX-L32E5B
- TX-L37E5B

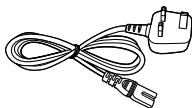

- TX-L42E5B
- TX-L47E5B

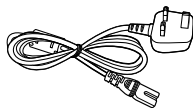

Clamper

- TMME289
- ➔ (p. 13)



Terminal adaptors

AV1 (SCART) adaptor

- K1HY20YY0011

➔ (p. 12)



AV2 (COMPONENT / VIDEO) adaptor

- K2KYYYY00206 or K2KYYYY00199

➔ (p. 82, 83)

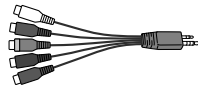

Operating Instructions

- Accessories may not be placed all together. Take care not to throw them away unintentionally.
- This product contains possibly dangerous parts (such as plastic bags), that can be breathed in or swallowed by young children accidentally. Keep these parts out of reach of young children.

Production Registration Leaflet

Optional accessories

Please contact your local Panasonic dealer to purchase the recommended optional accessories. For additional details, please read the manual of the optional accessories.

Wireless LAN Adaptor and exclusive stand

- TY-WL20E



- To use the Wireless LAN Adaptor, an access point needs to be obtained.
- It is recommended to use the Wireless LAN Adaptor with the extension cable.
- To avoid malfunctions caused by radio wave interference, keep the TV away from the devices such as other wireless LAN devices, microwaves and the devices that use 2.4 GHz and 5 GHz signals when using the Wireless LAN Adaptor.
- Depending on the area, this optional accessory may not be available.
- Additional information for Wireless LAN Adaptor and access point may be on the following website.

<http://panasonic.jp/support/global/cs/tv/>

Communication Camera

- TY-CC20W



- This camera can be used on VIERA Connect (p. 18, 73).
- Depending on the area, this optional accessory may not be available. For details, consult your local Panasonic dealer.

Wall-hanging bracket

Please contact your local Panasonic dealer to purchase the recommended wall-hanging bracket.

- Holes for wall-hanging bracket installation

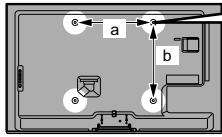

Rear of the TV

- TX-L32E5B / TX-L37E5B
a: 200 mm
b: 200 mm
- TX-L42E5B / TX-L47E5B
a: 400 mm
b: 400 mm

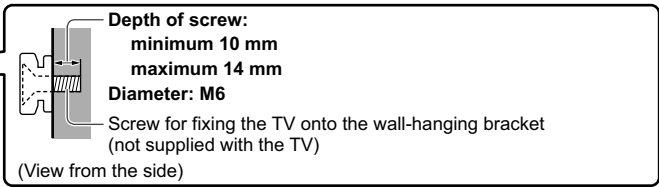

Warning

- Using other wall-hanging brackets, or installing a wall-hanging bracket by yourself has the risk of personal injury and product damage. In order to maintain the unit's performance and safety, be sure to ask your dealer or a licensed contractor to secure the wall-hanging brackets. Any damage caused by installing without a qualified installer will void your warranty.
- Carefully read the instructions accompanying optional accessories, and be sure to take steps to prevent the TV from falling off.
- Handle the TV carefully during installation since subjecting it to impact or other forces may cause product damage which will void your warranty.
- Do not mount the unit directly below ceiling lights (such as spotlights or halogen lights) which typically give off high heat. Doing so may warp or damage plastic cabinet parts.
- Take care when fixing wall brackets to the wall. Wall mounted equipment must not be grounded by metal within the wall. Always ensure that there are no electrical cables or pipes in the wall before hanging bracket.
- To prevent fall and injury, remove the TV from its fixed wall position when it is no longer in use for an extended period of time.

Installing / removing remote's batteries

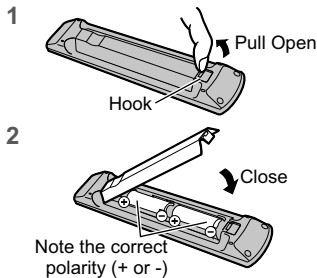

Caution

- Incorrect installation may cause battery leakage and corrosion, resulting in damage to the remote control.
- Do not mix old and new batteries.
- Replace only with same or equivalent type. Do not mix different battery types (such as alkaline and manganese batteries).
- Do not use rechargeable (Ni-Cd) batteries.
- Do not burn or break up batteries. Batteries must not be exposed to excessive heat such as sunshine, fire, etc.
- Make sure you dispose of batteries correctly.
- Ensure batteries are replaced correctly, there is danger of explosion and fire if battery is reversed.
- Do not disassemble or modify the remote control.

Attaching / removing the pedestal

Warning

Do not disassemble or modify the pedestal.

- Otherwise the TV may fall over and become damaged, and personal injury may result.

Caution

Do not use any pedestal other than the one provided with this TV.

- Otherwise the TV may fall over and become damaged, and personal injury may result.

Do not use the pedestal if it becomes warped or physically damaged.

- If you use the pedestal while it is physically damaged, personal injury may result. Contact your local Panasonic dealer immediately.

During set-up, make sure that all screws are securely tightened.

- If insufficient care is taken to ensure screws are properly tightened during assembly, the pedestal will not be strong enough to support the TV, and it might fall over and become damaged, and personal injury may result.

Ensure that the TV does not fall over.

- If the TV is knocked or children climb onto the pedestal with the TV installed, the TV may fall over and personal injury may result.

Two or more people are required to install and remove the TV.

- If two or more people are not present, the TV may be dropped, and personal injury may result.

When removing the pedestal from the TV, do not remove the pedestal by the methods other than the specified procedure. ➔ (p. 8)

- Otherwise the TV and / or pedestal may fall over and become damaged, and personal injury may result.

(A) Assembly screw (4)

- XSS5+15FNK



M5 × 15

(B) Assembly screw (4)

- XYN4+F25FJK



M4 × 25

(C) Bracket

- TBL5ZA32261 (TX-L32E5B)
- TBL5ZA32591 (TX-L37E5B)
- TBL5ZA32821 (TX-L42E5B)
- TBL5ZA32821 (TX-L47E5B)

**(D) Base**

- TBL5ZX0280 (TX-L32E5B)
- TBL5ZX0276 (TX-L37E5B)
- TBL5ZX0272 (TX-L42E5B)
- TBL5ZX04091 (TX-L47E5B)

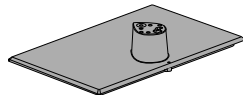
**1 Assembling the pedestal**

Use the assembly screws (A) to fasten the bracket

(C) to the base (D) securely.

- Make sure that the screws are securely tightened.
- Forcing the assembly screws the wrong way will strip the threads.

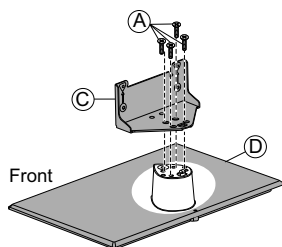
**2 Securing the TV**

Use the assembly screws (B) to fasten securely.

- Tighten the four assembly screws loosely at first, then tighten them firmly to fix securely.
- Carry out the work on a horizontal and level surface.

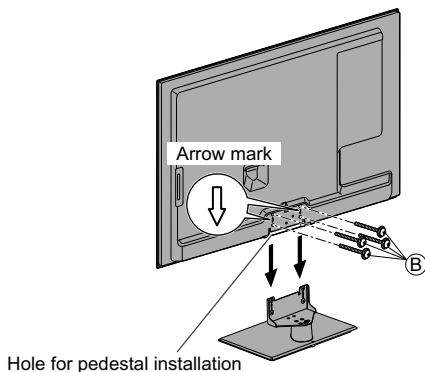
**Removing the pedestal from the TV**

Be sure to remove the pedestal in the following way when using the wall-hanging bracket or repacking the TV.

- 1 Remove the assembly screws (B) from the TV.
- 2 Pull out the pedestal from the TV.
- 3 Remove the assembly screws (A) from the bracket.

Preventing the TV from falling over

Using the fall-prevent screw hole and a screw (commercially available), securely fix the body of the pedestal to the installation surface.

- The place where the pedestal is to be fixed should be thick enough and made of hard material.

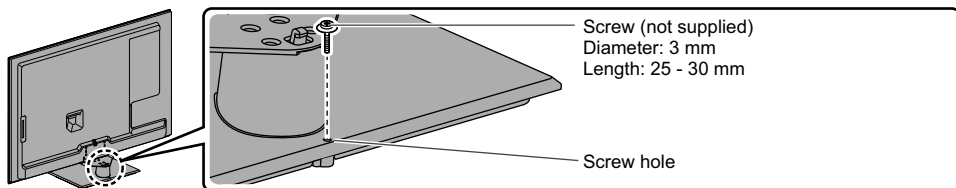

Identifying Controls

Remote Control

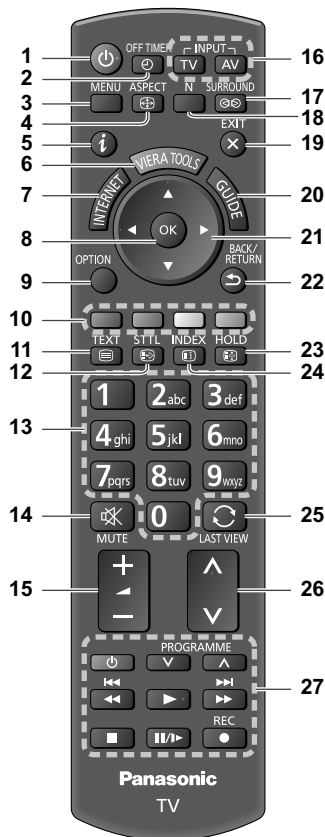

- 1 Standby On / Off switch**
 - Switches TV on or off standby.
- 2 OFF TIMER** ➔ (p. 21)
 - Turn the TV to Standby mode automatically after a fixed period
- 3 [Main Menu]** ➔ (p. 32)
 - Press to access Picture, Sound, Timer and Setup Menus.
- 4 Aspect** ➔ (p. 22)
 - Changes aspect ratio.
- 5 Information** ➔ (p. 20)
 - Displays channel and programme information.
- 6 VIERA TOOLS** ➔ (p. 31)
 - Displays some special feature icons and accesses easily.
- 7 INTERNET ([VIERA Connect])** ➔ (p. 18, 73)
 - Displays VIERA Connect home screen.
- 8 OK**
 - Confirms selections and choices.
 - Press after selecting channel positions to quickly change channel.
 - Displays the Channel List.
- 9 [Option Menu]** ➔ (p. 21)
 - Easy optional setting for viewing, sound, etc.
- 10 Coloured buttons (red-green-yellow-blue)**
 - Used for the selection, navigation and operation of various functions.
- 11 Teletext** ➔ (p. 26)
 - Switches to teletext mode.
- 12 Subtitles** ➔ (p. 22)
 - Displays subtitles.
- 13 Numeric buttons**
 - Changes channel and teletext pages.
 - Sets characters.
 - When in Standby mode, switches TV on (Press for about 1 second).
- 14 Sound Mute**
 - Switches sound mute on or off.
- 15 Volume Up / Down**
- 16 Input mode selection**
 - TV - switches DVB-C / DVB-T / Analogue mode. ➔ (p. 19)
 - AV - switches to AV input mode from Input Selection list. ➔ (p. 29)
- 17 Surround** ➔ (p. 35)
 - Switches surround sound setting
- 18 Normalise** ➔ (p. 32)
 - Resets picture and sound settings to their default levels
- 19 Exit**
 - Returns to the normal viewing screen.
- 20 TV Guide** ➔ (p. 23)
- 21 Cursor buttons**
 - Makes selections and adjustments.
- 22 Return**
 - Returns to the previous menu / page.
- 23 Hold**
 - Freezes / unfreezes the picture. ➔ (p. 21)
 - Holds the current teletext page (teletext mode). ➔ (p. 27)
- 24 Index** ➔ (p. 27)
 - Returns to the teletext index page (teletext mode).
- 25 Last view** ➔ (p. 20)
 - Switches to previously viewed channel or input mode.
- 26 Channel Up / Down**
- 27 Operations for contents, connected equipment, etc.** ➔ (p. 30, 58, 70, 76, 78)

Indicator / Control panel

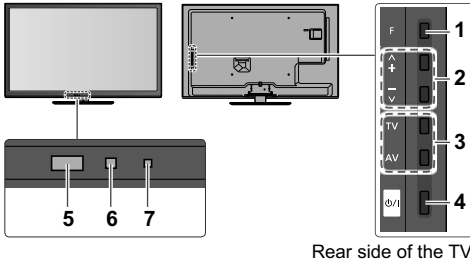

1 Function select

- [Volume] / [Contrast] / [Brightness] / [Colour] / [Sharpness] / [Tint] (NTSC signal) / [Bass]* / [Treble]* / [Balance] / [Auto Setup] (p. 45) * [Music] or [Speech] mode in the Sound Menu

2 Channel Up / Down, Value change (when using the F button), Switching the TV on (press either button for about 1 second when in Standby mode)

3 Changes the input mode

4 Mains power On / Off switch

- Use to switch the mains power.
If you turned the TV off during Standby mode by the remote control last time, the TV will be in Standby mode when you turn the TV on with Mains power On / Off switch.

When pressing the control panel button (1 - 4), the control panel guide appears on the right side of the screen for 3 seconds to highlight the pressed button.

5 Remote control signal receiver

- Do not place any objects between the TV remote control signal receiver and remote control.

6 C.A.T.S. (Contrast Automatic Tracking System) sensor

- Senses brightness to adjust picture quality when [C.A.T.S.] in the Picture Menu is set to [On].
➔ (p. 33)

7 Power and Timer LED

Red: Standby

Green: On

Orange: Timer Programming On

Orange (flash):

Recording of Timer Programming or Direct TV Recording in progress

Red with orange flash:

Standby with Timer Programming On or Direct TV Recording

- The LED blinks when the TV receives a command from the remote control.

Using the On Screen Displays - Operation guide

Many features available on this TV can be accessed via the On Screen Display menu.

■ Operation guide

Operation guide will help you to operate by using the remote control.

Example: [Sound Menu]

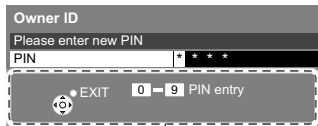

Operation guide

■ How to use remote control

MENU



Open the main menu



Move the cursor / select from a range of options / select the menu item (up and down only) / adjust levels (left and right only)



Access the menu / store settings after adjustments have been made or options have been set

BACK/RETURN



Return to the previous menu

EXIT



Exit the menu system and return to the normal viewing screen

Auto power standby function

The TV will automatically go into Standby mode in the following conditions:

- No signal is received and no operation is performed for 30 minutes in Analogue TV mode.
- [Off Timer] is active in the Timer Menu. (p. 21)
- No operation is performed for the period selected in [Auto Standby] (p. 36).
- This function does not affect the recording of Timer Programming and Direct TV Recording.

Basic Connection

External equipment and cables shown are not supplied with this TV.
Please ensure that the unit is disconnected from the mains socket before attaching or disconnecting any leads.

Terminals

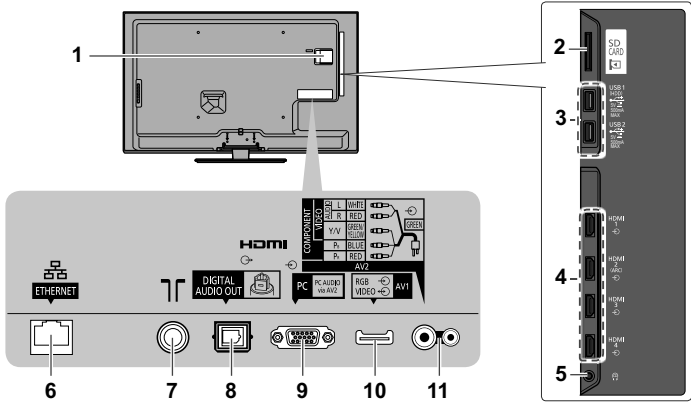

- 1 CI slot → (p. 53)
- 2 SD Card slot → (p. 57)
- 3 USB 1 - 2 port → (p. 57, 82)
- 4 HDMI 1 - 4 → (p. 12, 82)
- 5 Headphone jack → (p. 83)
- 6 ETHERNET → (p. 13)
- 7 Terrestrial terminal (see below)
- 8 DIGITAL AUDIO OUT → (p. 83)
- 9 PC terminal → (p. 82)
- 10 AV1 (SCART) → (p. 12)
- 11 AV2 (COMPONENT / VIDEO) → (p. 82)

Connections

Mains lead and aerial

■ DVB, Analogue

RF cable

Aerial input terminal

■ Mains lead

Insert the mains plug (supplied) firmly into place.

- When disconnecting the mains lead, be absolutely sure to disconnect the mains plug at the socket outlet first.

AC 220-240 V
50 / 60 Hz

AV devices

■ Player

TV

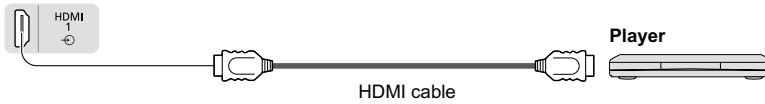

■ DVD Recorder / VCR

TV

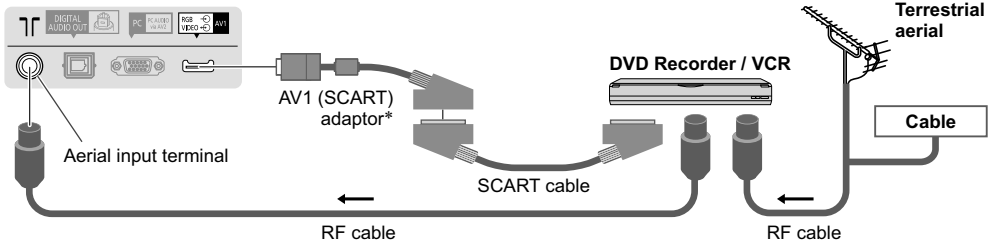

■ DVD Recorder / VCR and Satellite receiver

TV

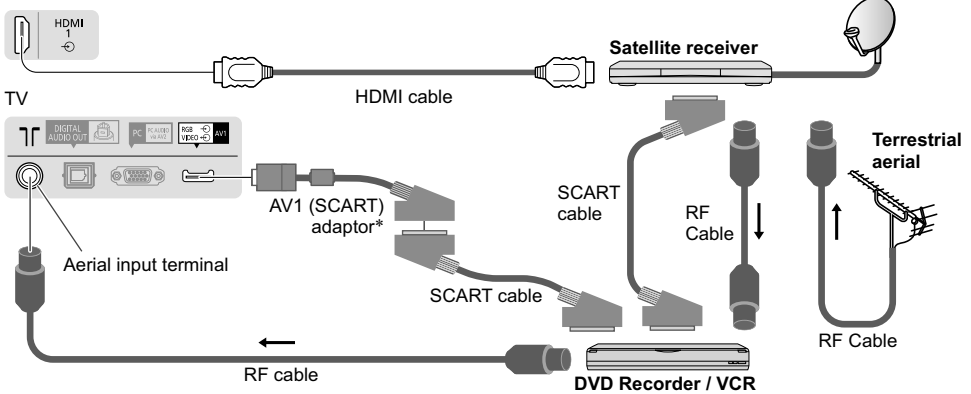

*Supplied with this TV

Note

- Connect to the TV's AV1 for a DVD Recorder / VCR supporting Q-Link (p. 76).
- Q-Link and VIERA Link connection ➔ (p. 74, 75)
- Please also read the manual of the equipment being connected.
- Keep the TV away from electronic equipment (video equipment, etc.) or equipment with an infrared sensor. Otherwise, distortion of image / sound may occur or operation of other equipment may be interfered.
- When using a SCART or HDMI cable, use the fully wired one.
- Check the type of terminals and cable plugs are correct when connecting.

Network

To enable the network service functions (VIERA Connect, etc.), you need to connect the TV to a broadband network environment.

- If you do not have any broadband network services, please consult your retailer for assistance.
- Prepare the internet environment for wired connection or wireless connection.
- Setup of the network connection will start after the tuning (when first using the TV). ➔ (p. 15 - 16)

■ Wired connection

TV

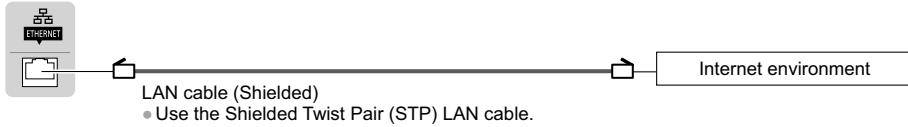

■ Wireless connection

TV

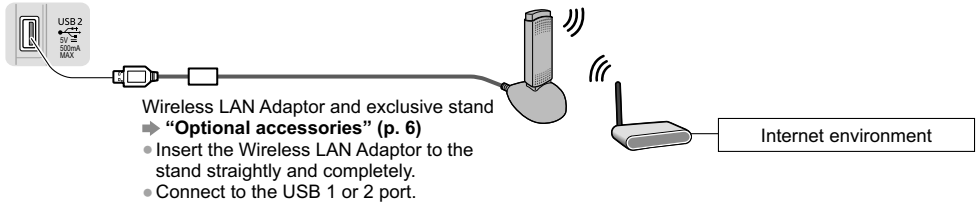

Using clamper

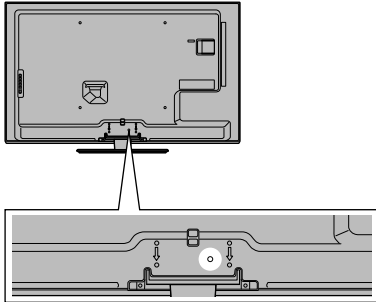

- Do not bundle the RF cable and mains lead together (could cause distorted image).
- Fix cables with clampers as necessary.
- When using the optional accessory, follow the option's assembly manual to fix cables.

■ Clamper (Standard accessory)

<p>Attach the clamper</p> <p>Insert the clamper in a hole</p> <p>hole</p>	<p>Bundle the cables</p> <p>hooks</p> <p>① Set the tip in the hooks</p>
<p>To remove from the TV:</p> <p>snaps</p> <p>① Keep pushing both side snaps</p>	<p>To loosen:</p> <p>knob</p> <p>① Keep pushing the knob</p>

Auto Setup

Search and store TV channels automatically.

- These steps are not necessary if the setup has been completed by your local dealer.
- Please complete connections (p. 11 - 13) and settings (if necessary) of the connected equipment before starting Auto Setup. For details of settings for the connected equipment, read the manual of the equipment.

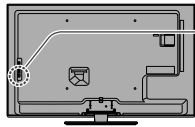

1

Plug the TV into mains socket and switch on



- Takes a few seconds to be displayed.
- If the red LED shows on the TV, press the Standby On / Off switch on the remote control for about 1 second.

2

Select your country



Example: **[UK]**

Example: **[Ireland]**

Auto Setup - DVB and Analogue				
DVB Scan	CH 21	68		
Analogue Scan	CH 21	68		
This will take about 6 minutes				
Ch	Channel Name	Type	Quality	
62	CBBC Channel	Free TV	10	
62	BBC Radio Wales	Free TV	10	
62	E4	Free TV	10	
62	Cartoon Nwk	Free TV	10	
29		Analogue	-	
33	BBC1	Analogue	-	
Free TV: 6	Play TV: 0	Radio: 0	Data: 0	Analogue: 2
Searching				

Auto Setup - DVB and Analogue				
DVB Scan	CH 5	69		
Analogue Scan	CH 1	41		
This will take about 6 minutes				
Ch	Channel Name	Type	Quality	
62	CBBC Channel	Free TV	100	
62	BBC Radio Wales	Free TV	100	
62	E4	Free TV	100	
62	Cartoon Nwk	Free TV	100	
CH29		Analogue	-	
CH33	BBC1	Analogue	-	
Free TV: 6	Play TV: 0	Radio: 0	Data: 0	Analogue: 2
Searching				

Auto Setup will start to search for TV channels and store them.

- Actual number of channels may differ due to channel duplication.

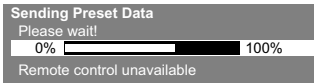

If Q-Link or similar technology (p. 76) compatible recorder with analogue tuner is connected, analogue channel setting is automatically downloaded to the recorder. (Digital channel setting is not downloaded.)

- If downloading has failed, you can download later through the Setup Menu.
 - ➔ "Q-Link Download" (p. 37)

- Region selection screen may appear. **[UK only]**

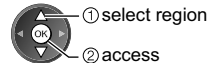

(select repeatedly until you reach the available region)



Setup the network connection

Setup the network connection to enable the network service functions such as VIERA Connect, etc. (p. 18, 65).

- Please note that this TV does not support wireless public access points.
- Ensure the network connections (p. 13) and network environment are completed before starting setup.

Select the network type

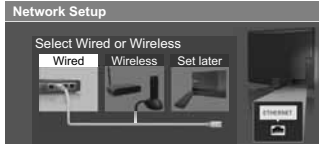

[Wired] → "Wired connection" (p. 13)

[Wireless] → "Wireless connection" (p. 13)



- To setup later on or skip this step

→ Select [Set later] or EXIT

■ [Wired]

1. Select [Auto]



Connection Test

- Check network cable connection.
- Check acquired IP address.
- Check for devices using same IP address.
- Check gateway connection.
- Check server connection for VIERA Connect.

: succeeded

The test is successful and the TV is connected to the network.

Automatically setup is done and the test of the network connection starts.

- To set manually, select [Manual] and set each item. For details → (p. 68)

: failed

Check the settings and connections. And then select [Retry].

2. Go to the next step



■ [Wireless]

Access points found automatically are listed.

1. Select your desired access point

No.	Network Name(SSID)	Wireless type	Status
1	Access Point A	11n(2.4GHz)	
2	Access Point B	11n(5GHz)	
3	Access Point C	11n(5GHz)	



- For [WPS(Push button)] (p. 16)



: Encrypted access point

- To search access points again



- For the information of the highlighted



- To set manually (p. 70)



2. Access the encryption key input mode

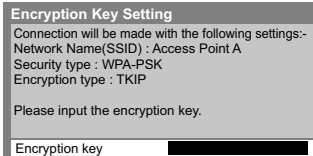

- If the selected access point is not encrypted, the confirmation screen will be displayed. It is recommended to select the encrypted access point.

3. Enter the encryption key of the access point

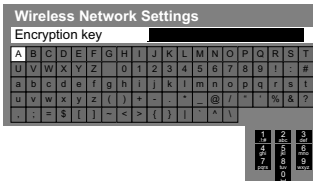

Set characters



- You can set characters by using numeric buttons.



4. After the access point setting is finished, perform the connection test



Connection Test

- Check wireless network connection.
- Check acquired IP address.
- Check for devices using same IP address.
- Check gateway connection.
- Check server connection for VIERA Connect.

: **succeeded**

The test is successful and the TV is connected to the network.

: **failed**

Check the settings and connections. And then select [Retry].

- To set manually, select [Manual] and set each item.
For details ➔ (p. 68)

5. Go to the next step **4**



(Press twice)

[WPS(Push button)]

1. Press the WPS button on the access point until the light flashes
2. Connect the TV with the access point

WPS(Push button)

1) Please press the 'WPS' button on the access point until its light flashes.

2) When the light is flashing select 'Connect' on TV.

If you are unsure, please check the instruction manual of the access point.

Connect



- Ensure that your access point supports WPS for this setup.
- WPS: Wi-Fi Protected Setup™
- If the connection has failed, check the settings and positions of your access point. And then, follow the on-screen instructions.

3. After the access point setting is finished, perform the connection test



Connection Test

- Check wireless network connection.
- Check acquired IP address.
- Check for devices using same IP address.
- Check gateway connection.
- Check server connection for VIERA Connect.

: **succeeded**

The test is successful and the TV is connected to the network.

: **failed**

Check the settings and connections. And then select [Retry].

- To set manually, select [Manual] and set each item.

For details ➔ (p. 68)

4. Go to the next step **4**



(Press twice)

Input Owner ID

Owner ID

Please enter new PIN

PIN

Please enter your own choice of PIN number, name, etc. to help the police to crack crime.

- Make a note of the PIN number in case you forget it. The PIN number cannot be reset.
- You can input or change the Owner ID later. ➔ "Owner ID" (p. 52)

- To skip this step

EXIT



- This step will be skipped in the Auto Setup after [Shipping Condition] (p. 51) is performed.

4

How to input Owner ID

1 Enter the PIN number (4 digits)



• Enter the PIN number twice at first setting.

2 Select the item (NAME / HOUSE NO / POSTCODE)



3 Enter your name, house number and postcode

Set characters

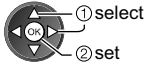
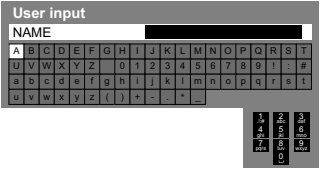

• You can set characters by using numeric buttons.
➔ “Characters table for numeric buttons” (p. 92)

Return to select other items



• Select the next item and repeat the operations.

4 Exit to go to next step



5

Select [Home]

Select [Home] viewing environment to use in your home environment.



Shop viewing environment (for shop display only)

[Shop] viewing environment is the demonstration mode to explain main features of this TV.

Select [Home] viewing environment to use in your home environment.

• You can return to viewing environment selection screen at the stage of Shop confirmation screen.

1 Return to viewing environment selection screen

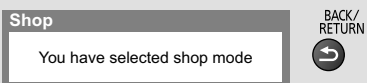

2 Select [Home]



To change viewing environment later on, you will need to initialise all settings by accessing Shipping Condition. ➔ [Shipping Condition] (p. 51)

Auto Setup is now complete and your TV is ready for viewing.

If tuning has failed, check the connection of the RF cable, and then, follow the on-screen instructions.

Note

- To check the channel list ➔ “Using TV Guide” (p. 23)
- To edit or hide (skip) channels ➔ “Tuning and Editing Channels” (p. 45 - 47)
- To retune all channels ➔ [Auto Setup] (p. 44)
- To initialise all settings ➔ [Shipping Condition] (p. 51)

Using “VIERA Connect”

VIERA Connect is a gateway to the internet services unique to Panasonic.

VIERA Connect allows you to access some specific websites supported by Panasonic, and enjoy internet contents such as videos, games, EPG, communication tools, etc. from VIERA Connect home screen.

- This TV does not support full web browser function and some features of the websites may not be available.



1 Turn power on



- Press for about 1 second.
- Mains power On / Off switch should be on. (p. 10)

- Every time you turn on the TV, VIERA Connect introduction banner appears. The banner is subject to change.



2 Access VIERA Connect

While the banner is displayed



or



- Depending on the usage conditions, it may take a while to read all the data.
- Messages might be displayed before VIERA Connect home screen. Please read these instructions carefully and follow the on-screen instructions.

Example: VIERA Connect home screen



- To go to the next level, select [MORE].
- To back to the previous level, select [BACK].
- To return to VIERA Connect home screen



- Video communication (for example Skype™) requires an exclusive Communication Camera TY-CC20W.

➔ “Optional accessories” (p. 6)

For details, read the manual of the Communication Camera.

- You can connect a keyboard and a gamepad via USB port for character input and playing games in VIERA Connect. You can also operate the TV with a keyboard or a gamepad other than VIERA Connect features.

For more information ➔ “USB connection” (p. 90)

Note

- If you cannot access VIERA Connect, check the network connections (p. 13) and settings (p. 15 - 16).
- For more information of VIERA Connect ➔ (p. 73)

Watching TV



Volume

1 Turn power on



- Press for about 1 second.
- Mains power On / Off switch should be on. (p. 10)

■ VIERA Connect introduction banner appears

Every time you turn on the TV, this banner appears at the bottom of the screen.

You can access to VIERA Connect easily and enjoy the various contents. ➔ (p. 18)

- To remove this banner, leave for about 5 seconds or press any buttons (except the buttons to access VIERA Connect).
- To set this banner display off ➔ [VIERA Connect Banner] (p. 38)
- The banner is subject to change.



2 Select the mode



- You can also select the mode pressing the TV button repeatedly on the remote control or the TV (p. 10).

3 Select a channel



DVB channel position numbers run from 1 onwards. Analogue channel position numbers run in the ranges 0 - 99.

- To select a more than two-digit channel position number, e.g. 399



■ To select a channel using Information banner (p. 20)

It is possible to confirm the channel name and programme information by using the Information banner before changing channels.

1 Display Information banner if it is not displayed



2 While the banner is displayed, select the channel

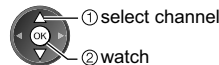

■ To select a channel using TV Guide (p. 23)

It is possible to confirm the channel and programme information by using the TV Guide (EPG) before changing channels.

1 Display TV Guide



2 Select the current programme or channel



3 Select [View] (DVB)

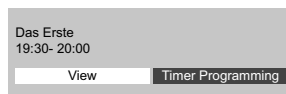

Note

- To watch pay-TV ➔ “Using Common Interface” (p. 53)

Other useful functions

Display Information banner

Display Information banner

- Also appears when changing a channel.

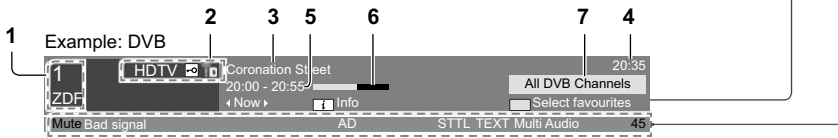

- 1 Channel position and name
- 2 Channel type ([Radio], [Data], [HDTV], etc.) / Encrypted channel (⊞) / TV mode (TV, A)
- 3 Programme
- 4 Current time
- 5 Programme Start / Finish time (DVB) Channel number, etc. (Analogue)
- 6 Progress time indicator of the selected programme (DVB)
- 7 [All DVB Channels] or [Favourites] 1 to 4 (p. 45) (DVB)
 - To switch
 - (blue)

Features available / Message meanings

[Mute]

Sound mute on

[Bad signal]

Poor TV signal quality

[Dolby D+], [Dolby D], [HE-AAC]

Dolby Digital Plus, Dolby Digital or HE-AAC audio track

[Also in HD] (UK only)

Same programme available as HD broadcast

- To display the extra information for details



[AD]

Audio Description service available

- This function can aid visually-impaired viewers by adding an additional audio track to describe events on screen.
- For settings ➔ (p. 36)

[STTL]

Subtitle service available

[TEXT]

Teletext service available

[Multi Audio]

Multiple audio available

[Stereo], [Mono], [NICAM]

Audio mode

1 - 90

Off Timer remaining time

- For settings ➔ (p. 21)

- To confirm another tuned channel name



- To watch the channel listed in the banner



- Information on the next programme (DVB)



- To hide



- Extra information (DVB)



(Press again to hide the banner)

- To set display timeout

➔ [Banner Display Timeout] (p. 38)

- [AD], [STTL], [TEXT], [Multi Audio] indications are displayed as available on particular programmes, but may not be available for all individual programmes being broadcast. Display the extra information to confirm availability of these functions.

Example:

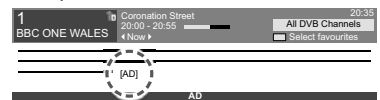

Last view

Switch to previously viewed channel or input mode easily

- Press again to return to the current view.



LAST VIEW

Note

- Switching channel is not available while the recording of Timer Programming or Direct TV Recording is in progress.
- Watching less than 10 seconds is not regarded as the previously viewed channel or input mode.

Hold

Freeze / unfreeze picture



Display the selectable settings for the current status

Confirm or change the current status instantly

OPTION

- To change

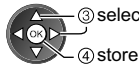

[Multi Audio / AD] (Ireland only) (DVB)

Selects between alternative language or Audio Description for sound tracks (if available)

- Set Audio Description [Auto] in the Sound Menu (p. 36) to select the audio description sound track. In freesat mode, Audio Description cannot be controlled separately from the audio description sound track.
- This setting is not memorised and it will return to the default setting once you exit the current programme.

[Audio Description] (UK only) (DVB)

Set to [Auto] if the programme has Audio Description service, then you will hear an additional audio track to describe events on screen

- To adjust the volume for Audio Description
➔ **[Audio Description Menu]**
(p. 36)

[Multi Audio] (UK only) (DVB)

Selects between alternative language for sound tracks (if available)

- This setting is not memorised and it will return to the default setting once you exit the current programme.

[Voice Guidance Settings]

Guidance settings for visually impaired users ➔ (p. 36)

[Monaural Audio] (DVB)

Selects stereo / monaural (if available)

- This setting is not memorised and it will return to the default setting once you exit the current programme.

[Subtitle Language] (DVB)

Selects the language in which subtitles should appear (if available)

- This setting is not memorised and it will return to the default setting once you exit the current programme.

[Teletext Character Set]

(Ireland only)

Sets the teletext language font

➔ (p. 38)

[Teletext Language] (Ireland only)

(DVB)

Selects between alternative language for teletext (if available)

[NICAM] (Analogue)

Switches NICAM sound (if available)

➔ (p. 35)

[Volume Correction]

Adjusts volume of individual channel or input mode

Off Timer

Turn the TV to Standby mode automatically after a fixed period

OFF TIMER



Press the button repeatedly until you reach the desired time.

[Off] / [15] / [30] / [45] / [60] / [75] / [90] (minutes)

- To cancel, set to [Off] or turn the TV off.
- To confirm the remaining time ➔ **"Display Information banner"** (p. 20)
- When the remaining time is within 3 minutes, the remaining time will flash on the screen.
- You can also set the [Off Timer] via the [Timer] menu ➔ (p. 36)

Aspect

Change the aspect ratio (image size)

ASPECT Enjoy viewing the image at its optimum size and aspect. Programmes usually contain an "Aspect Control Signal" (Widescreen signal, etc.), and the TV will choose the aspect ratio automatically according to the "Aspect Control Signal" (p. 85).

■ To change the aspect ratio manually

1 Display Aspect Selection list

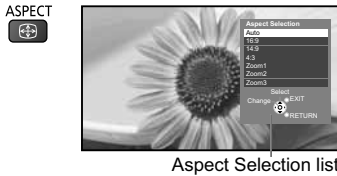

2 While the list is displayed, select the mode

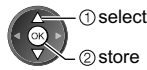

- You can also change the mode only using the ASPECT button.

ASPECT (Press repeatedly until you reach the desired mode.)

[Auto]



The best ratio is chosen and the image expanded to fill the screen. For details ➔ (p. 85)

[16:9]



Directly displays the image at 16:9 without distortion (anamorphic).

[14:9]



Displays the image at the standard 14:9 without distortion.

[4:3]



Displays the image at the standard 4:3 without distortion.

[Zoom1]



Displays a 16:9 letterbox or 4:3 image without distortion.

[Zoom2]



Displays a 16:9 letterbox (anamorphic) image full-screen without distortion.

[Zoom3]

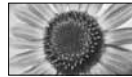

Displays a 2.35:1 letterbox (anamorphic) image full-screen without distortion. At 16:9, displays the image at its maximum (with slight enlargement).

Note

- Aspect mode can be memorised separately for SD (Standard definition) and HD (High definition) signals.

Display subtitles

■ DVB

Display / hide subtitles (if available)



- To change the language for DVB (if available) ➔ [Preferred Subtitles] (p. 38)

■ Analogue

Display subtitles



Hide subtitles



Note

- This is the same as switching to Analogue teletext service and selecting "P888" (subtitle service). (p. 27)
- You cannot change the channel when this function is active.

Using TV Guide

TV Guide - Electronic Programme Guide (EPG) provides an on-screen listing of the programmes currently broadcast and the forthcoming broadcasts over the next seven days (depending on the broadcasters).

- DVB and Analogue channels are displayed on the same TV Guide screen. [D] means DVB channel and [A] means Analogue channel. There will be no programme listings for Analogue channels.
- When this TV is turned on for the first time, or the TV is switched off for more than a week, it may take some time before TV Guide is completely shown.



1 Select the mode

→ (p. 19)



2 View TV Guide



■ To return to TV



or



Example: **[UK]** 5 6 7

Freeview	TV Guide	Wed 26 Oct 2011 10:48
Wed 26 Oct	Search	All Channels
1 BBC ONE 20:00 - 20:30 DIY SOS: Who spent it?	Batterby	Also in
2 Time: 19:30	2:00	23:30 21:50 21:30
D 1 BBC ONE Das Erste	DIY SOS	Holiday News
D 7 BBC THREE Hot Wars		Holiday Program
D 14 E4 Emmerdale	Coronation Street	The Bill
D 70 BBC FOUR 10 O'clock News BBC	Pepsi Char	Good bye
D 72 BBC 2W Panorama	Spring watch	Coast
D 105 BBC I'm A Celebrity		Pop Idol News
D 718 BBC Raid	Rugby	15 To 1 Sports

- 1 TV Guide date
- 2 TV Guide time
- 3 [D]: DVB
[A]: Analogue
- 4 Channel position and name

- 5 Some programmes may also be broadcast in HD **[UK only]**
 - You can select HD or SD broadcast before viewing or setting Timer Programming.
- 6 Programme
- 7 Current date and time

■ To change the layout of TV Guide → [TV Guide View] (p. 37)

■ To watch the programme

1 Select the current programme or channel

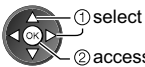

or



2 Select [View] (DVB)

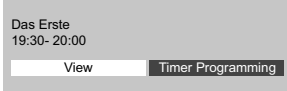

- To use Timer Programming → (p. 24)

• If a programme exists in both HD and SD broadcasts, the [View Options] screen will be displayed to select HD or SD broadcast. (DVB) **[UK only]**

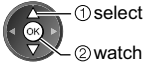
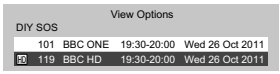

■ To the previous day (DVB)



■ To the next day (DVB)

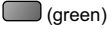

■ View details of the programme (DVB)

1 Select the programme



2 View details

- Press again to return to TV Guide.

■ To view a channel list of the selected category

 (blue)

(Category list)



Only Analogue channels are listed

• To list favourite channels
➔ (p. 45)

■ To search programme types and view a channel list of the searched programmes (DVB)

 (yellow)

(UK) (Search list)

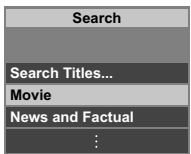

(Ireland) (Type list)

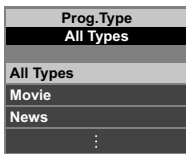

■ To search programme titles and view a list of the searched programmes (DVB) UK only

 (yellow)

(Search list)

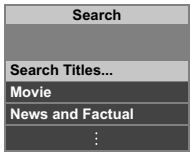

1 Select [Search Titles...]



2 Set characters
(maximum 19 characters)

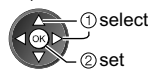

3 Start [Search]

 (green)

- All the programme titles including the word you set will be listed.
- Searching without any characters will list all programmes including current programmes.

• To use numeric buttons
➔ "Characters table for numeric buttons" (p. 92)

Timer Programming (DVB)

The Timer Programming menu allows you to choose programmes that you want to remind watching or record to the external recorder. At the correct time, the TV will tune to the correct channel even if the TV is in Standby mode.

1 Select the forthcoming programme



- LED will turn to orange if Timer Programming is set. (Orange LED will flash if the recording of Timer Programming is in progress.)
➔ "Indicator / Control panel" (p. 10)

2 Select the function ([Ext Rec.] or [Reminder])

(Timer Programming screen)

Timer Programming		Wed 26 Oct 2011 10:46			
Function	No.	Channel Name	Date	Start	End
	12	BBC ONE	Wed 26 Oct 2011	20:00	20:30
		<TIMER>			(20 min.)
					[---min.]
					[---min.]
					[---min.]



[Ext Rec.] / [Reminder]

➔ "Set timer programming event details" (p. 48)

■ To check / change / cancel a timer programming event

➔ "Timer Programming" (p. 48 - 49)

■ If you select the current programme

A confirmation screen asking whether you want to watch or record the programme appears. Select [Timer Programming] and set [Ext Rec.] to record from the time you finish the timer programming event setting.

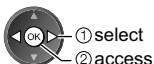

■ To return to TV Guide



■ If a programme exists in both HD and SD broadcasts (UK only)

The [Timer Options] screen will be displayed to select HD or SD broadcast.

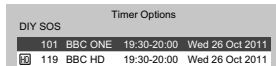

(Timer Programming screen)

Function	No.	Channel Name	Date	Start	End
Ext Rec.	119	BBC HD	Wed 26 Oct	19:30	20:00 (30 min.)
		DIY SOS			(--:--)

HD will be displayed if HD broadcast is set.

Note

- This function is not available in Analogue mode.
- Timer Programming reminder messages will remain displayed until one of the following occurs:
 - You press the OK button to view the programme or the EXIT button to cancel the reminder.
 - The timer programming event that the reminder is set for ends.
- No other channel can be selected while the recording of Timer Programming is in progress.
- When recording programmes to the external recorder, be sure to make the proper settings on the recorder connected to the TV.

If a compatible recorder with Q-Link, VIERA Link or similar technologies is connected to the TV (p. 76, 77) and [Link Settings] (p. 37) are completed, no setting of the recorder is required. Also read the manual of the recorder.

Guide link programming (Timer Programming from the TV Guide signal) (UK only)

Guide link programming is Timer Programming which is controlled by information from the TV Guide; if programme start and end times are changed by the broadcaster, the timer programming event will follow the change. A Split Programme programming is a Guide link programming which is interrupted by one or more other programmes. Note that Guide link programming (including Split Programme programming) only works reliably if correct information is received from broadcasters.

(Timer Programming screen)

Function	No.	Channel Name	Date	Start	End
Ext Rec.	7	BBC ONE	Wed 26 Oct	20:00	20:30 (30 min.)
Reminder	14	E4 The Bill	Wed 26 Oct	21:00	22:30 (90 min.)
Ext Rec.	72	BBC 2W STIMPER	Wed 26 Oct	22:45	23:00 (15 min.)
Ext Rec.	1	BBC ONE Red Cap	Thu 27 Oct	18:30	11:30 (60 min.)

"S/P" is displayed if the timer is set from the TV Guide and the programme is a Split Programme

"Guide" is displayed if the timer is set from the TV Guide (Guide link programming)

Example: (UK)

Preview	TV Guide
1 BBC ONE 20:00 - 20:30 DIY SOS: We open in the Batterys	Search All Channels
D 1 BBC ONE Das Erste DIY SOS Holiday News	Time 19:30 20:00 20:30 21:00 21:30
D 7 BBC THREE Holt Wars Holiday Program	
D 14 E4 Emmerdale Soronation Street	
D 70 BBC FOUR 10 O'clock New BBC The Bill	
D 72 BBC 2W Panorama Spring watch	
D 55 BBC Tim & Celebrity Pop Idol	
D 79 BBC Red Rugby 5 To 1	

"D" or "S/P" will be displayed in the TV Guide if Timer Programming is set as the Guide link programming.

Note

- If you edit the start time or end time of a Guide link programming event by more than 10 minutes, it will no longer follow the broadcaster's changes to the start or end time. The start and end times will become fixed.
- While making the Split Programme programming event for [Ext Rec.], you cannot record any channels between the interrupted programmes.
- The Split Programme programming event for Reminder will be cleared by pressing the OK button once to view.
- The Split Programme programming event for Reminder will switch to the programmed channel by pressing the OK button even if it is between the interrupted programmes.
- The Split Programme programming does not work if the separated parts are broadcast on different channels.

Viewing Teletext

You can enjoy news, weather forecasts and subtitles, etc. (depending on the broadcaster)

- The availability of teletext services for a programme is indicated by [TEXT] in the information banner.

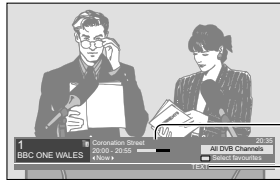

Information banner → (p. 20)

Displayed if programme has teletext service

Ireland

Depending on the broadcaster, the digital teletext (MHEG) services may not be available. In this case, the operation of the teletext services may be the same as the analogue teletext services (p. 27).

Digital teletext (MHEG)

Digital teletext services differ greatly from analogue teletext.

When you switch to a digital teletext service, the images you see can contain graphics and text, laid out and controlled in a manner decided by the broadcaster.



1 Select DVB

→ (p. 19)



- DVB programmes have digital teletext services (MHEG).

2 Switch to Teletext

TEXT



Example:

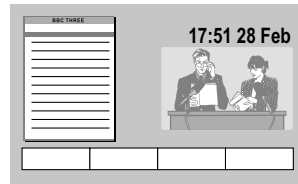

■ How to operate services

In all cases, it is possible to navigate the pages using buttons on the remote control, but because the commands available must apply to all manufacturers of digital equipment, some on-screen commands may not correspond exactly to the remote control buttons.

- Select, go
- Symbol: ◀▶▶▶▲

■ To return to TV



- Back key



- Coloured characters



Coloured button

- When options with numbers are displayed



Note

- As soon as you switch to a digital channel with links to a teletext service, software is downloaded in the background to enable the teletext function. This means that when switching to a digital channel, you should wait for approximately 5 seconds before pressing the TEXT button - this will allow the software to download. If you press the TEXT button before download is complete, it will be ignored and you will have to press the TEXT button again when the download is complete.
- While navigating digital teletext, you will find there is a short delay when moving between pages while the page downloads. There is often a prompt shown somewhere on the page (for example "Loading") to let you know that this is happening.

Analogue teletext

Teletext services are the text information provided by the broadcasters.
The features may vary depending on the broadcasters.

What is FASTEXT mode?

In FASTEXT mode, four differently coloured subjects are situated at the bottom of the screen. To access more information about one of these subjects, press the appropriate coloured button. This facility enables fast access to information on the subjects shown.

What is List mode?

In List mode, four differently coloured page numbers are situated at the bottom of the screen. Each of these numbers can be altered and stored in the TV's memory. ➔ "Store frequently viewed pages" (p. 28)

■ To change mode ➔ [Teletext] (p. 38)

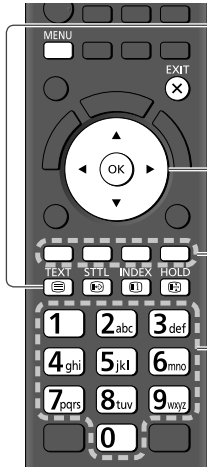

■ To return to TV



1 Switch to Teletext

TEXT



Sub page number

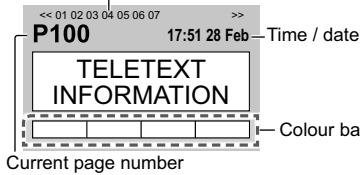

- Displays the index page (content varies depending on the broadcasters).

Current page number

2 Select the page



or Coloured button
(Corresponds to the colour bar)

■ To adjust contrast



(Press twice)



As the blue bar is displayed



Reveal hidden data

Reveal hidden words e.g. quiz page answers



(red)

- Press again to rehide.

INDEX

Return to the main index page



HOLD

Stop automatic updating

(If you want to hold the current page without updating.)

HOLD • Press again to resume.



Subtitles

View a favourite page stored



- Factory setting is "P888" (subtitle service) on the blue button (List mode).

FULL / TOP / BOTTOM

MENU → (green)

(TOP)

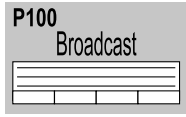

(Expand the TOP half)

(BOTTOM)

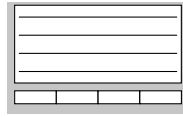

(Expand the BOTTOM half)

Normal (FULL)

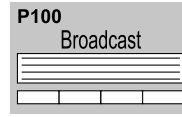

View in multi window

Watch TV and Teletext in two windows at once

TEXT



- Operations can be made only in Teletext screen.
- Each time pressed: Teletext → TV and Teletext



Store frequently viewed pages

Store frequently viewed pages in the colour bar (List mode only)

As page is displayed



(Corresponding coloured button)



press and hold

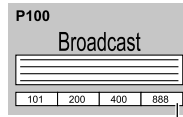

The number changes to white.

- If you wish to use Subtitles, do not change number on blue button.

■ To change stored pages



Coloured button you want to change



Enter new page number



press and hold

View sub page

View sub page (Only when Teletext is more than one page)



<<01 02 03 04 05

Appears at top of the screen

- The number of sub pages varies depending on the broadcasters (up to 79 pages).
- It may take some time for searching, during which time you can watch TV.

■ To view specific sub page

MENU



(blue)

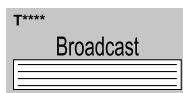

Enter the 4-digit number

Example: P6
0 0 0 6...

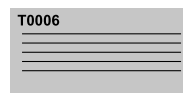

Watch TV while waiting for update

View the TV picture while searching for a teletext page

Teletext automatically updates itself when new information becomes available.

MENU



(yellow)



Changes to TV screen temporarily



Appears when updating is completed



View the updated page

(yellow)

(You cannot change the channel.)

- The news page provides a function that indicates arrival of the latest news ("News Flash").

Watching External Inputs

Connect the external equipment (VCRs, DVD equipment, etc.) and you can watch through the input.

- To connect the equipment ➔ (p. 11 - 13, 82 - 84)

The remote control is capable of operating the contents or external equipment.



1 Turn the TV on



When connecting with SCART (p. 12)

Receives input signals automatically when playback starts

- Input signals are automatically identified by the SCART (pin 8) terminal.
- This function is also available for HDMI connections (p. 82).

If input mode is not switched automatically

Perform **2** and **3**

- Check the setup of the equipment.

2 Display the input selection menu



3 Select the input mode connected to the equipment

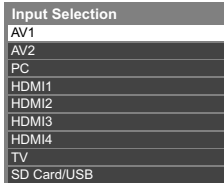

- You can also select the input using the AV button on the remote control or the TV (except [SD Card/USB]).
 - Press the button repeatedly until the desired input is selected.
 - To switch between [COMPONENT] and [VIDEO] in [AV2], move the indicator by pressing left and right cursor button.
 - [SD Card/USB]: Switches to Media Player. ➔ “Using Media Player” (p. 57)
 - You can label or skip each input mode (except [SD Card/USB]). ➔ “Input Labels” (p. 38)
- Skipped inputs will not be displayed when the AV button is pressed.

- To return to TV



4 View

AV1 ————— Displays the selected mode

Terminal	AV1	AV2	PC	HDMI1	HDMI2	HDMI3	HDMI4
Manual input (default setting in “Input Labels”)	AV1 AV1-RGB	COMPONENT VIDEO	PC	HDMI1	HDMI2	HDMI3	HDMI4
Auto input (EC mode or VIERA Link)	EC/AV1 EC/AV1-RGB	-	-	EC/HDMI1 Applicable for EC mode and VIERA Link	EC/HDMI2 Applicable for VIERA Link	EC/HDMI3 Applicable for VIERA Link	EC/HDMI4 Applicable for VIERA Link









- If the above information is permanently displayed on the top left of the screen, press the **i** button to clear.

Note

- If the external equipment has an aspect adjustment function, set it to [16:9].
- For details, read the manual of the equipment or ask your local dealer.

Operating the contents or equipment with the TV remote control

You can operate the contents in Media Player / media servers, recording functions or the connected equipment with the below buttons of this TV remote control.

	Standby Set to Standby mode / Turn on
	Play Playback videocassette / DVD / video content
	Stop Stop the operations
	Rewind / Skip / Search VCR: Rewind, view the picture rapidly in reverse DVD / video content: Skip to the previous track, title or chapter Press and hold to search backward
	Fast-forward / Skip / Search VCR: Fast-forward, view the picture rapidly forward DVD / video content: Skip to the next track, title or chapter Press and hold to search forward
	Pause Pause / Resume DVD: Press and hold to play at slow speed
	Channel Up / Down Select channel
	[Direct TV Rec] ➔ (p. 76, 78)

How to change the code

Each type of the Panasonic equipment has its own remote control code. To use in some features of this TV, you have to select the code "73". Change to the appropriate code according to the equipment or features below.

Press and hold  **during the following operations**

Enter the appropriate code, see table below



Press



Type of the equipment, features	Code
DVD Recorder, DVD Player, Blu-ray Disc Player	70 (default)
Player theatre, Blu-ray Disc theatre	71
VCR	72
Media Player (p. 58), DLNA features (p. 70) or Direct TV Recording (p. 76, 78) Equipment using in VIERA Link (p. 79)	73

Note

- Confirm if the remote control works correctly after changing the code.
- The codes may be reset to default values if batteries are replaced.
- Some operations may not be possible on some equipment models.

How to Use VIERA TOOLS

You can access some special features easily by using the VIERA TOOLS function.

- For [VIERA Link] function to operate correctly, ensure the connections and settings are completed.
 - ➔ “Summary of Q-Link and VIERA Link features” (p. 74), “Preparations” (p. 77)
 - After connection, turn the equipment on and then switch the TV on.
- For [Photo], [Video] and [Music] functions to operate correctly, ensure the device has photo, video or music data on it and insert it into the SD Card slot or USB port properly. ➔ “Using Media Player” (p. 57)



1 Display icons of the feature



2 Select a feature



■ To return to TV



■ Follow the operations of each feature



* When two or more available devices are connected, a selection screen will be displayed. Please select the correct description and access.

Note

- If the selected feature is not available, the demonstration to explain how to use it can be displayed. Press the OK button to view the demonstration after selecting the unavailable feature.

How to Use Menu Functions

Various menus allow you to make settings for the picture, sound, and other functions.



■ To return to TV at any time



■ To return to the previous screen



■ To change menu pages



1 Display the menu

● Displays the functions that can be set (varies according to the input signal).

2 Select the menu

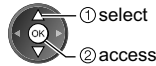
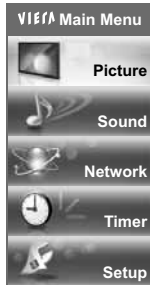

3 Select the item

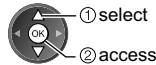
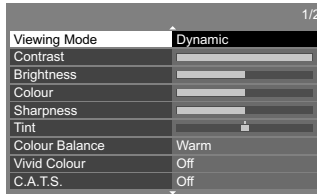

■ Choose from among alternatives

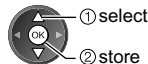

■ Adjust using the slide bar

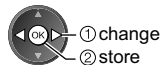

■ Go to the next screen

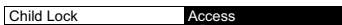

Displays the next screen

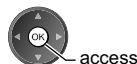

■ Enter characters by free input menu

You can enter names or numbers freely for some items.

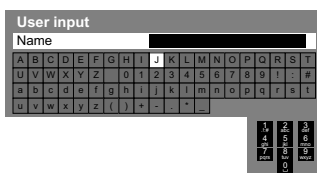

Set characters one by one

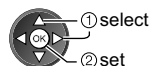

● You can set characters by using numeric buttons.
 ➔ **“Characters table for numeric buttons” (p. 92)**

■ To reset the settings

● Picture or sound settings only
 ➔ **[Reset to Defaults] in the Picture Menu (p. 34) or Sound Menu (p. 36)**

● Picture and sound settings together
 N (Also volume level and aspect mode are reset)
 ● To initialise all settings ➔ **[Shipping Condition] (p. 39)**

Note

● If “Demo Settings” item is displayed in the Setup Menu, the TV is in “Shop” viewing environment. To return to “Home” viewing environment initialise all settings by accessing Shipping Condition. ➔ (p. 51)

Menu list

Menu	Item	Adjustments / Configurations (alternatives)
Picture	Viewing Mode	<p>Selects your favourite picture mode for each input [Dynamic] / [Normal] / [Cinema] / [True Cinema] / [Game] [Dynamic]: Improves contrast and sharpness for viewing in a bright room. [Normal]: The [Colour Balance] default setting is set to [Cool]. This is ideal for natural day light conditions. • For indoor lighting conditions, change the [Colour Balance] setting to [Normal] or [Warm] for best picture viewing. If [Reset to Defaults] is performed, the [Colour Balance] setting will return to [Cool]. [Cinema]: Improves the performance of contrast, black and colour reproduction for watching movies in a darkened room. [True Cinema]: Reproduces the original image quality precisely without any revision. [Game]: Provides suitable images for fast response signal when playing games. • Not valid on TV mode • To display a continuous record of time spent using Game mode ➔ [Playing Time Display] (p. 38)</p> <p>In each Viewing Mode, [Contrast], [Brightness], [Colour], [Sharpness], [Tint], [Colour Balance], [Vivid Colour], [C.A.T.S.], [P-NR] and [3D-COMB] can be adjusted and stored. Additionally, you can adjust the detailed settings when [Advance(Calibration)] in the Setup Menu is set to [On]. ➔ (p. 39)</p>
	Contrast, Brightness, Colour, Sharpness	Adjusts the levels of these options according to your personal preference
	Tint	Adjusts the picture hue to suit your taste • For NTSC signal reception
	Colour Balance	Sets the overall colour tone of the picture [Cool] / [Normal] / [Warm] • Not valid when [Viewing Mode] is set to [True Cinema]
	Vivid Colour	Automatically adjusts colours to vivid ones [Off] / [On] • Not valid on PC mode
	C.A.T.S.	Contrast Automatic Tracking System (Automatic Brightness Control function) Adjusts picture settings automatically depending on ambient lighting conditions [Off] / [On] • Set to [On] to make the suitable contrast setting automatically. The default setting is [On] when [Viewing Mode] is set to [Normal].
	P-NR	Picture Noise Reduction Reduces unwanted picture noise and flicker noise in the contoured parts of a picture [Off] / [Min] / [Mid] / [Max] / [Auto] • Not valid on PC mode or when [Viewing Mode] is set to [Game]
	3D-COMB	Makes still or slow moving pictures more vivid [Off] / [On] • Occasionally, while viewing still or slow moving pictures, colour patterning may be seen. Set to [On] to display sharper and more accurate colours. • For PAL / NTSC signal reception in TV mode or from composite
	Screen Display	Turns the screen off when you select [Off] [Off] / [On] • The sound is active even if the screen turns off. • Press any buttons (except Standby) to turn the screen on. • This function is effective in reducing power consumption when listening to the sound without watching the TV screen.

Menu	Item	Adjustments / Configurations (alternatives)
Picture	Advanced Settings	Clear Cinema Improves vertical resolution for movie images [Off] / [On] <ul style="list-style-type: none"> This function is available for the interlaced signal (except in the mode of PC, VIERA Connect or when [Viewing Mode] is set to [Game]).
		16:9 Overscan Selects the screen area displaying the image [Off] / [On] [On]: Enlarges the image to hide the edge of the image. [Off]: Displays the image in the original size. <ul style="list-style-type: none"> Set to [On] if noise is generated on the edge of the screen. This function is available when aspect is set to [Auto] (16:9 signal only) or [16:9]. This function can be memorised separately for SD (Standard definition) and HD (High definition) signals. Not valid on PC mode or VIERA Connect
		DVI Input Setting Changes the black level of the image for HDMI input mode with DVI input signal manually [Normal] / [Full] <ul style="list-style-type: none"> When the DVI input signal from the external equipment (especially from PC) is displayed, the black level may not be suitable. In this case, select [Full]. The black level for HDMI input signal will be adjusted automatically. For HDMI input mode with DVI input signal
	Reset to Defaults Press the OK button to reset the current Picture Viewing Mode to the default settings	
Sound	Mode Selects your favourite sound mode [Music] / [Speech] / [User] <ul style="list-style-type: none"> The selected mode affects all input signals. [Music]: Improves sound quality for watching music videos, etc. [Speech]: Improves sound quality for watching news, drama, etc. <ul style="list-style-type: none"> In Music and Speech modes, you can adjust [Bass] and [Treble] settings, and those settings will be stored for each mode. [User]: Adjusts the sounds manually by using the equaliser to suit your favourite sound quality. <ul style="list-style-type: none"> For the User mode, [Equaliser] will appear on the Sound Menu instead of [Bass] and [Treble]. Select [Equaliser] and adjust the frequency. ➔ [Equaliser] (p. 34) 	
	Bass Adjusts level to enhance or minimise lower, deeper sound output	
	Treble Adjusts level to enhance or minimise sharper, higher sound output	
	Equaliser Adjusts the frequency level to suit your favourite sound quality <ul style="list-style-type: none"> This function is available when [Mode] is set to [User]. Select the frequency and change the frequency level by using the cursor button. To enhance the bass sound, raise the level of the lower frequency. To enhance the treble sound, raise the level of the higher frequency. To reset the levels of each frequency to the default settings, select [Reset to Defaults] by using the cursor button, and then press the OK button. 	

Menu	Item	Adjustments / Configurations (alternatives)
Sound	Balance	Adjusts volume level of right and left speakers
	Headphone Volume	Adjusts the volume of the headphones
	Surround	Surround sound settings [Off] / [V-Audio] / [V-Audio Surround] [V-Audio]: Provides a dynamic enhancer of width to simulate improved spatial effects. [V-Audio Surround]: Provides a dynamic enhancer of width and depth to simulate improved spatial effects. • Switching is also possible by the SURROUND button on the remote control (p. 9).
	Auto Gain Control	Automatically regulates large sound level differences between channels and inputs [Off] / [On]
	Volume Correction	Adjusts the volume of individual channel or input mode
	Speaker Distance to Wall	Compensates for the low frequency sound due to the distance between the speakers and the wall [Over 30cm] / [Up to 30cm] • If the back space between the TV and wall is over 30 cm, [Over 30cm] is recommended. • If the back space between the TV and wall is within 30 cm, [Up to 30cm] is recommended.
	Preferred Multi Audio [UK only]	Selects the preferred language for digital channel multi audio (depending on the broadcaster) [English] / [Welsh] / [Gaelic] / [Irish]
	NICAM	Near Instantaneous Companded Audio Multiplex Reproduces NICAM stereo sound [Off] / [On] • Off if reception is poor (FM monaural sound) • For Analogue mode
	SPDIF Selection	SPDIF: A standard audio transfer file format Selects the initial setting for digital audio output signal from DIGITAL AUDIO OUT and HDMI2 (ARC function) terminals [Auto] / [PCM] [Auto]: Dolby Digital Plus, Dolby Digital and HE-AAC multi-channel are output as Dolby Digital Bitstream. MPEG is output as PCM. [PCM]: Digital output signal is fixed to PCM. • For DVB mode or video contents of Media Player / Network services (p. 63, 73) • ARC (Audio Return Channel): A function of digital audio output using HDMI cable
HDMI1 / 2 / 3 / 4 Input	Selects to fit the input signal [Digital] / [Analogue] (p. 90) [Digital]: When sound is carried via the HDMI cable connection [Analogue]: When sound is not carried via the HDMI-DVI adaptor cable connection • For HDMI input	

Menu	Item	Adjustments / Configurations (alternatives)
Sound	Voice Guidance Settings	Voice Guidance Set to [On] to enable voice guidance of the basic features (EPG, on-screen messages, etc.) for visually impaired users [Off] / [On]
		Speed Selects the readout speed for the voice guidance [Normal] / [Fast]
		Volume Selects the volume for the voice guidance [Min] / [Mid] / [Max]
		User Level Selects the level of verbosity for voice guidance [Beginner] / [Expert]
	Audio Description Menu	Audio Description Narration settings for visually impaired users [Off] / [Auto] Set to [Auto] to activate the narration sound track when available on the broadcast. <ul style="list-style-type: none"> • The availability of audio description sound track is indicated by [AD] in the information banner (p. 20). • For DVB mode
		Volume <input type="text" value="UK only"/> Adjusts the volume for Audio Description <ul style="list-style-type: none"> • For DVB mode
		Speakers <input type="text" value="UK only"/> Set to [On] to activate the description sound track from TV speakers [Off] / [On] <ul style="list-style-type: none"> • For DVB mode
		Headphones <input type="text" value="UK only"/> Set to [On] to activate the description sound track from headphones [Off] / [On] <ul style="list-style-type: none"> • For DVB mode
		Reset to Defaults Press the OK button to reset the current Sound Mode, [Balance], [Headphone Volume] and [Surround] to the default settings
	Network	Connection Test, Network Connection, Wireless Network Settings, IP/DNS Settings Sets the network setting to use in your network environment (p. 67)
Network Link Settings Sets to control the TV with the devices connected to the network (p. 67)		
Software Update Checks for available software updates from the Panasonic website		
New Software Message Selects whether to give a notification message when new software is found via network [Off] / [On]		
Network Status Displays the network status (MAC Address, current network settings, etc.)		
Timer Programming Sets a timer to record or remind forthcoming programmes (p. 48)		
Timer	Off Timer Sets the duration of time until the TV automatically goes into Standby mode [Off] / [15] / [30] / [45] / [60] / [75] / [90] (minutes) (p. 21)	
	Auto Standby Sets the duration of time that the TV will remain on when no operation is performed [Off] / [2] / [4] (hours) <ul style="list-style-type: none"> • Starting Timer Programming automatically does not affect this function. • Automatic input switching with the connected equipment affects this function and time-count will be reset. • The notification message will appear 3 minutes before going into Standby mode. 	

Menu	Item	Adjustments / Configurations (alternatives)	
Setup	TV Guide Settings	<p>TV Guide View</p> <p>Changes the layout of TV Guide [Normal] / [Full] / [Info] [Normal]: Default TV Guide screen [Full]: Displays channels and programmes full-screen without the operation guide [Info]: Displays details of the selected programme at the bottom without the operation guide</p>	
		<p>Eco Navigation</p> <p>Automatically sets the TV to the most suitable energy-saving mode</p> <ul style="list-style-type: none"> • If you press the OK button, the following items are set as below: [C.A.T.S.], [VIERA Link], [Standby Power Save], [Power Save] ➔ [On] [Intelligent Auto Standby] ➔ [On (No reminder)] [Auto Standby] ➔ [2 hours] 	
	Link Settings	VIERA Link	Sets to use VIERA Link functions [Off] / [On] (p. 77)
		HDMI Content Detection	<p>Automatically adjusts the picture settings according to the received HDMI content via HDMI cable [Off] / [Auto]</p> <ul style="list-style-type: none"> • This function is available if the connected equipment supports HDMI Content Type. • The content type information will be displayed for several seconds when this function works.
		AV1 out	<p>Chooses the signal to be transmitted from the TV to Q-Link [TV] / [AV2] / [Monitor] [Monitor]: Image displayed on screen</p> <ul style="list-style-type: none"> • Component and HDMI signals cannot be output.
		Standby Power Save	<p>Controls the connected equipment to reduce power consumption in Standby [Off] / [On] (p. 78)</p> <ul style="list-style-type: none"> • This function is available when [VIERA Link] is set to [On].
		Intelligent Auto Standby	<p>Makes non-watched or non-used connected equipment go into Standby mode to reduce the power consumption [Off] / [On (With reminder)] / [On (No reminder)] (p. 78)</p> <ul style="list-style-type: none"> • This function is available when [VIERA Link] is set to [On].
		Q-Link Download	Downloads analogue channel information to a Q-Link compatible equipment connected to the TV
		Child Lock	Applies access control for channels or inputs to prevent unwanted access (p. 50)
	Tuning Menu*	Favourites Edit	<p>Creates a list of favourite channels (p. 45)</p> <ul style="list-style-type: none"> • Not valid on Analogue mode
		Channel List	Skips the unwanted channels or edits channels (p. 46)
		Auto Setup	Automatically searches for the receivable channels (p. 44)
		Channel Sorting by Region UK only	<p>Automatically sorts tuned channels according to the available region (p. 46)</p> <ul style="list-style-type: none"> • For DVB mode
		Manual Tuning	Searches for the channels manually (p. 47)

Menu	Item	Adjustments / Configurations (alternatives)
Tuning Menu*	Update Channel List	Updates the channel list while keeping your settings (p. 47) • For DVB mode
	New Channel Message	Selects whether to give a notification message when a new channel is found [Off] / [On] (p. 47) • For DVB mode
	Signal Condition	Checks the signal condition (p. 47) • Not valid on Analogue mode
Language <small>(Ireland only)</small>	Preferred Audio 1 / 2	Selects the first and second preferred language for digital channel multi audio (depending on the broadcaster)
	Preferred Subtitles 1 / 2	Selects the first and second preferred language for digital channel subtitles (depending on the broadcaster) • To display subtitles ➔ (p. 22)
	Preferred Teletext	Selects the preferred language for digital channel teletext service (depending on the broadcaster)
Setup	Preferred Subtitle Type <small>(Ireland only)</small>	Selects the preferred subtitle type [Standard] / [Hard of Hearing] • [Hard of Hearing] provides aids in understanding and enjoyment with digital channel subtitles (depending on the broadcaster). • [Preferred Subtitles 1 / 2] in [Language] are given priority.
	Teletext	Analogue teletext display mode [FASTEXT] / [List] (p. 27)
	Teletext Character Set <small>(Ireland only)</small>	Selects teletext language font [West] / [East1] / [East2] [West]: English, French, German, Greek, Italian, Spanish, Swedish, Turkish, etc. [East1]: Czech, English, Estonian, Lettish, Rumanian, Russian, Ukrainian, etc. [East2]: Czech, Hungarian, Lettish, Polish, Rumanian, etc.
	Preferred Subtitles <small>(UK only)</small>	Selects the preferred language for digital channel subtitles (depending on the broadcaster) [English] / [Welsh] / [Gaelic] / [Irish] To display subtitles ➔ (p. 22) <input checked="" type="checkbox"/> provides aids in understanding and enjoyment with DVB subtitles (depending on the broadcaster).
	Input Labels	Accesses the input labels list to select the label of each input mode or set to skip unconnected one for easier identification and selection in [Input Selection] (p. 29) or banner • To name each input mode freely, select [User input] and set characters (maximum 10 characters). • To skip the input mode, select [Skip].
	Banner Display Timeout	Sets how long the Information banner stays on screen [0 (No display)] / [1] / [2] / [3] / [4] / [5] / [6] / [7] / [8] / [9] / [10] (seconds)
	VIERA Connect Banner	Sets the VIERA Connect introduction banner display [Off] / [On] (p. 18, 19)
	Playing Time Display	Set to [On] to display a continuous record of time spent using Game mode in the top right of the screen every 30 minutes [Off] / [On] • This function is available when [Viewing Mode] is set to [Game]. ➔ (p. 33)
	Radio Mode	Sets the timer for turning off the screen automatically when a radio channel is selected [Off] / [5] / [10] / [15] / [20] (seconds) • The sound is active even if the screen turns off. This function is effective in reducing power consumption when listening to a radio channel. • Press any buttons except Standby, Volume Up / Down and Sound Mute buttons to turn the screen on. • Not valid on Analogue mode

Menu	Item	Adjustments / Configurations (alternatives)	
Setup	DivX® VOD	Displays DivX VOD registration code (p. 88)	
	Advance(Calibration)	Enables the advanced picture settings [Off] / [On] <ul style="list-style-type: none"> Set to [On] to display the advanced items in the Picture Menu. (p. 56) 	
	System Menu	USB Keyboard Layout	Selects the language that your USB Keyboard supports <ul style="list-style-type: none"> For the information of using USB Keyboard ➔(p. 90)
		Shipping Condition	Resets all settings to the original condition (p. 51)
		Owner ID	Inputs the owner ID (p. 52)
		Common Interface	Sets for watching encrypted channels, etc. (p. 53)
		System Update	Downloads new software to this TV (p. 54)
		Software Licence	Displays the software licence information
		System Information	Displays the system information of this TV
		Device Information	Displays the device information of this TV
Other Settings	Power on Preference	Automatically selects the input when the TV is turned on [TV] / [AV] <ul style="list-style-type: none"> Set to [TV] to view picture from TV tuner. Set to [AV] to view input from the external equipment connected to the AV1 or HDMI1 terminal, e.g. satellite receiver. The external equipment must be switched on and sending a control signal for automatic switching at power on to occur. 	
	Power on Channel List	Automatically selects All Channels or Favourites list in the Information banner when the TV is turned on [All Channel List] / [Last] <ul style="list-style-type: none"> Set to [All Channel List] to display all the channels. Set to [Last] to display the one you selected last time. Not valid on Analogue mode 	
	Power Save	Reduces brightness of the picture to economise on power consumption [Off] / [On]	

*The settings in [Tuning Menu] are applicable only for the selected TV mode. The menu name varies depending on the TV mode. ([DVB Tuning Menu] / [Analogue Tuning Menu])

- A different menu will be displayed when [Advance(Calibration)] in the Setup Menu is set to **[On]** or in the mode of PC input, Media Player or network service operations. (p. 55, 56, 57 - 64, 70 - 73)
- Only available items can be selected.

Overview (Picture, Sound, Network, Timer, Setup)

How to operate → (p. 32)



1/2	
Viewing Mode	Dynamic
Contrast	[Slider]
Brightness	[Slider]
Colour	[Slider]
Sharpness	[Slider]
Tint	[Slider]
Colour Balance	Warm
Vivid Colour	Off
C.A.T.S.	Off
2/2	
P-NR	Off
3D-COMB	Off
Screen Display	On
Advanced Settings	Access
Reset to Defaults	Reset

(p. 33, 34)

For NTSC

Not valid when [Viewing Mode] is set to [True Cinema]

For NTSC / PAL

2/2	
White Balance	Access
Colour Management	Access
Gamma	Access
Clear Cinema	Off
16:9 Overscan	Off
DVI Input Setting	Normal

(p. 34, 56)

1/2	
Mode	Music
Bass	[Slider]
Treble	[Slider]
Equaliser	Access
Balance	[Slider]
Headphone Volume	[Slider]
Surround	Off
Auto Gain Control	Off
Volume Correction	[Slider]
Speaker Distance to Wall	Over 30cm
2/2	
Preferred Multi Audio	English
NICAM	Off
SPDIF Selection	Auto
HDMI1 Input	Digital
Voice Guidance Settings	Access
Audio Description	Access
Reset to Defaults	Reset

(p. 34 - 36)

Available when [Mode] is set to [Music] or [Speech]

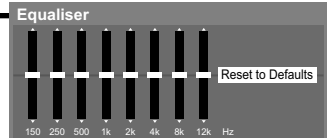

Available when [Mode] is set to [User]

For DVB (UK only)

For Analogue

For DVB, network video contents or Video mode

For HDMI input

Audio Description Menu	
Audio Description	Off
Volume	[Slider]
Speakers	Off
Headphones	Off

For DVB

(p. 36)

UK only

Connection Test	Access
Network Connection	Wired
Wireless Network Settings	Access
IP/DNS Settings	Access
Network Link Settings	Access
Software Update	Access
New Software Message	On
Network Status	Access

(p. 67 - 70)

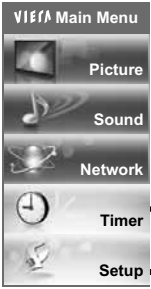

Timer Programming	Access
Off Timer	Off
Auto Standby	Off

(p. 36)

Function	No.	Channel Name	Date	Start	End
Ext Rec.	0	72 BBC 2W <TIMER>	Wed 26 Oct	20:00 (90 min.)	21:30
Reminder	0	14 E4 The Bill	Wed 26 Oct	21:00 (60 min.)	22:00
Ext Rec.	0	1 BBC ONE DIY SOS	Wed 26 Oct	22:45 (15 min.)	23:00
Ext Rec.	0	BBC ONE <TIMER>	STTL Thu 27 Oct	10:30 (60 min.)	11:30

(p. 48)

TV Guide Settings	Access
Eco Navigation	Access
Link Settings	Access
Child Lock	Access
DVB Tuning Menu	Access
Analogue Tuning Menu	Access
Language	Access
Display Settings	Access
DivX® VOD	Access
Advance(Calibration)	Off
System Menu	Access

(p. 37 - 39)

Ireland only

Child Lock-PIN Entry

Please enter new PIN

PIN

(p. 50)

Child Lock

Change PIN	Access
Child Lock List	Access
Freeview Players	Unlock
Parental Rating	No limit

--- For DVB (Ireland only)

--- For DVB (UK only)

(p. 50)

Child Lock List - TV and AV

Name	Input	Type	Lock
101 BBC 1 Wales	DVB	Free TV	▲
7 BBC THREE	DVB	Free TV	▲
14 E4C	DVB	Free TV	▲
VCR	Analogue	Analogue	▲
1 BBC1	Analogue	Analogue	▲
2 ****	Analogue	Analogue	▲
AV1	External	AV	▲
AV2	External	AV	▲

(p. 50)

Link Settings

VIERA Link	On
HDMI Content Detection	Off
AV1 out	TV
Standby Power Save	On
Intelligent Auto Standby	On (No reminder)
Q-Link Download	Access

(p. 37)

Sending Preset Data

Please wait!

0% 100%

Remote control unavailable

(p. 37)

Overview (Setup)

How to operate ➔ (p. 32)

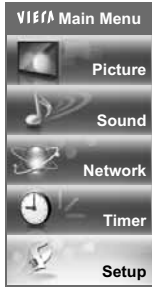

TV Guide Settings	Access
Eco Navigation	Access
Link Settings	Access
Child Lock	Access
DVB Tuning Menu	Access
Analogue Tuning Menu	Access
Language	Access
Display Settings	Access
DivX® VOD	Access
Advance(Calibration)	Off

System Menu	Access
Other Settings	Access

(p. 37 - 39)

Other Settings	
Power on Preference	TV
Power on Channel List	Last
Power Save	Off

---For DVB
(p. 39)

System Menu	
USB Keyboard Layout	English(UK)
Shipping Condition	Access
Owner ID	Access
Common Interface	Access
System Update	Access
Software Licence	Access
System Information	Access
Device Information	Access

(p. 39)

System Update	
Auto Update Search in Standby	Off
System Update Search Now	Access

(p. 54)

Common Interface	
Slot 1:	Module inserted

For DVB (p. 53)

Owner ID	
Please enter new PIN	
PIN	* * * *

(p. 52)

Shipping Condition	
All tuning data will be erased	
Are you sure ?	
Are you sure ?	

(p. 51)

DVB Tuning Menu	
Favourites Edit	Access
Channel List	Access
Auto Setup	Access
Channel Sorting by Region	Access
Manual Tuning	Access
Update Channel List	Access
New Channel Message	On
Signal Condition	Access

For DVB (p. 44 - 47)

DVB Update Channel List			
Progress	CH 21 68		
This will take about 3 minutes.			
CH	Channel Name	Type	Quality
Free TV: 0	Pay TV: 0	Radio: 0	Data: 0
Searching			

(p. 47)

Analogue Tuning Menu	
Channel List	Access
Auto Setup	Access
Manual Tuning	Access

For Analogue (p. 44 - 47)

How to Use Menu Functions

DVB Manual Tuning

Frequency: [CH21] 474.00 MHz

Signal Quality: 0 — 10

Signal Strength: 0 — 10

No.	Channel Name	Type	New

Free TV: 0 Pay TV: 0 Radio: 0 Data: 0

Searching

(p. 47)

All DVB Channels

- 70 CBBC Channel
- 72 Cartoon Nwk
- 105 BBCi
- 719 BBC Radio Wales
- 720 BBC Radio Cymru
- 1 BBC ONE Wales
- 7 BBC THREE

(p. 46)

DVB Favourites Editor

All DVB Channels	Favourites 1
1 BBC One Wales	
7 BBC THREE	
14 E4	
70 CBBC Channel	
72 Cartoon Nwk	
105 BBCi	
719 BBC Radio Wales	
720 BBC Radio Cymru	

(p. 45)

Channel Sorting by Region

GBR>

Best signal quality (All Regions)

England Regions>

Region choice available

(p. 46)

UK only

DVB Auto Setup

Progress: CH 21 — 88

This will take about 3 minutes.

CH	Channel Name	Type	Quality
62	CBBC Channel	Free TV	110
62	BBC Radio Wales	Free TV	110
62	E4	Free TV	110
62	Cartoon Nwk	Free TV	110

Free TV: 4 Pay TV: 0 Radio: 0 Data: 0

Searching

(p. 44)

Analogue Manual Tuning

1 BBC1 CH33

Manual Tuning: 21 — 33

Store

(p. 47)

Analogue Auto Setup

Scan: CH 21 — 88

This will take about 3 minutes.

CH	Channel Name
29	
30	

Analogue: 2

Searching

(p. 44)

Analogue Channel List

- 1 BBC1
- 2 *****
- 3 *****
- 4 *****
- 5 *****
- 6 *****
- 7 *****

(p. 46)

Display Settings

Preferred Subtitle Type	Standard
Teletext	FASTEXT
Teletext Character Set	West
Preferred Subtitles	English
Input Labels	Access
Banner Display Timeout	3 seconds
VIERA Connect Banner	On
Playing Time Display	On
Radio Mode	Off

(p. 38)

----- Ireland only

----- For Analogue

----- Ireland only

----- For DVB UK only

Input Labels

AV1	DVD
AV2	AV2
PC	PC
HDMI1	HDMI1
HDMI2	HDMI2
HDMI3	HDMI3
HDMI4	HDMI4
DVB	DVB
Analogue	Analogue

(p. 38)

Retuning from Setup Menu

Automatically retune the channels received in the area.

- This function is available if channel tuning is already performed.
- Only the selected mode is retuned. All the previous tuning settings are erased.
- If Child Lock PIN number (p. 50) has been set, the PIN number is required.
- If tuning has not been done completely → **[Manual Tuning]** (p. 47)

DVB or Analogue channels

1 Select the mode

→ (p. 19)



2 Display the menu and select [Setup]



- ① select
- ② access

3 Select [DVB Tuning Menu] or [Analogue Tuning Menu]

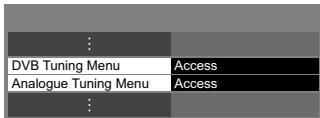

- ① select
- ② access

- The displayed item depends on the selected mode.

4 Select [Auto Setup]

Example:

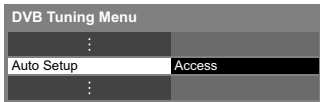

- ① select
- ② access

5 Start Auto Setup (Settings are made automatically)

Example: DVB

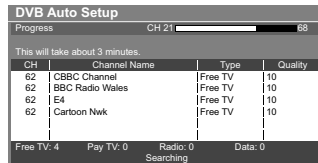
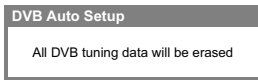

Example: Analogue

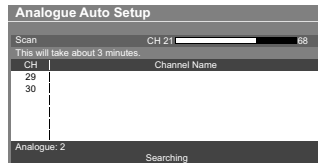
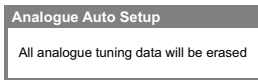

- The analogue settings are downloaded to a Q-Link compatible equipment connected to the TV in Analogue mode. When the operation is completed, the channel at the lowest position will be displayed.

Auto setup using the buttons on the TV

For Auto Setup, using the buttons on the TV (p. 10)

- 1 Press the F button repeatedly until [Auto Setup] appears
- 2 Access [Auto Setup]
- 3 Start [Auto Setup]

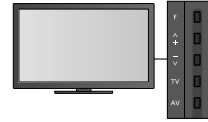

- To return to TV
- Control panel OSD appears when pressing the control panel button.

Tuning and Editing Channels

You can retune channels or make your favourite channel lists, skip unwanted channels, etc.

1 Select the mode

→ (p. 19)



2 Display the menu and select [Setup]



- ① select
- ② access

3 Select [DVB Tuning Menu] or [Analogue Tuning Menu]

⋮	
DVB Tuning Menu	Access
Analogue Tuning Menu	Access
⋮	



- ① select
- ② access

4 Select one of the following functions

DVB Tuning Menu	
Favourites Edit	Access
Channel List	Access
Auto Setup	Access
Channel Sorting by Region	Access
Manual Tuning	Access
Update Channel List	Access
New Channel Message	On
Signal Condition	Access



- ① select
- ② access

• [Auto Setup] → “Returning from Setup Menu” (p. 44)

List favourite DVB channels [Favourites Edit]

Create your favourite channel lists from various broadcasters (up to 4: [Favourites]1 to 4).

The DVB Favourites lists are available for switching in the Information banner (p. 20) and from [Category] in the TV Guide screen (p. 23).

1 Select a channel to list (🔒: Encrypted channel)

DVB Favourites Editor	
All DVB Channels	Favourites1
1 BBC One Wales	
7 BBC THREE	
14 E4	
70 CBBC Channel	
72 Cartoon Nwk	
105 BBC1	
719 BBC Radio Wales	
720 BBC Radio Cymru	



To display other Favourites
 (green)

2 Add it to the Favourites list

DVB Favourites Editor	
All DVB Channels	Favourites1
1 BBC One Wales	1 BBC One Wales
7 BBC THREE	
14 E4	
70 CBBC Channel	
72 Cartoon Nwk	
105 BBC1	
719 BBC Radio Wales	
720 BBC Radio Cymru	



To add all channels to the list
 (yellow)

■ To edit Favourites list

While the cursor is in the Favourites field to edit

- To move the channel



Select the new position



or



Store



- To delete the channel



- To delete all channels

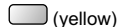

- To name the Favourites



Set characters (maximum 10 characters)



- To use numeric buttons → (p. 92)



Store



3 Store

BACK/RETURN



Note

- Channel position numbers (known as logical channel numbers) can be swapped in Channel List. To swap the channel position number → [Channel List] (see below)

Skip unwanted channels, Edit Channels [Channel List]

You can hide (skip) unwanted channels. The hidden channels cannot be displayed except in this function.

Select a channel and reveal / hide

Example: DVB

All DVB Channels	
<input checked="" type="checkbox"/>	70 CBBC Channel
<input checked="" type="checkbox"/>	72 Cartoon Nwk
<input checked="" type="checkbox"/>	105 BBCi
<input type="checkbox"/>	719 BBC Radio Wales
<input type="checkbox"/>	720 BBC Radio Cymru
<input type="checkbox"/>	1 BBC ONE Wales
<input checked="" type="checkbox"/>	7 BBC THREE

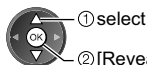

- : [Reveal]
- : [Hide] (skip)

- To reveal all channels

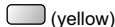

■ To edit channels

- To swap the channel position number (logical channel number)

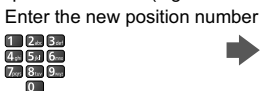

Store



Example: Analogue



- To retune each channel → [Manual Tuning] (p. 47) (only for the revealed channels)



- To rename the channel name (Analogue)



Set characters (maximum 5 characters)



- To use numeric buttons → (p. 92)



Store



Note

- If a VCR is connected only with the RF cable in Analogue mode, edit [VCR].

Sort DVB channels according to the region [Channel Sorting by Region] UK only

You can sort DVB channels so that those with the best signal quality, or those for your preferred region, appear nearer the top of your Channel List.

Normally, you should select [Best signal quality (All Regions)].

Channel Sorting by Region	
GBR	Best signal quality (All Regions)
England	England Regions

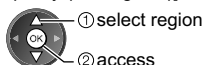

(select repeatedly until you reach the available region)

- If you choose to select your preferred region, you could find channels with a weaker signal appear nearer the top of your Channel List. If you have any image or sound problems, select [Best signal quality (All Regions)] instead.

Set DVB channel manually [Manual Tuning]

Normally use [Auto Setup] or [Update Channel List] to retune DVB channels. If tuning has not been done completely or for adjusting the direction of the aerial, use this function.

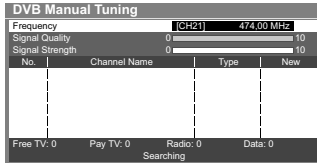

Ireland

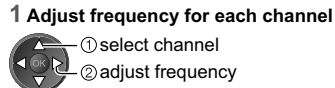

- Set where the level of [Signal Quality] becomes the maximum.

- All channels found will be added to the Channel List.

Set Analogue channel manually [Manual Tuning]

[Fine Tuning]: Use to make small adjustments to the tuning of an individual programme (affected by weather conditions, etc.). (Ireland only)

[Manual Tuning]: Set Analogue channel manually after Auto Setup.

- If a VCR is connected only with the RF cable, select channel position [0].

Example: (Ireland)

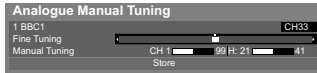

1 Select the channel position



2 Select the channel



3 Search



4 Select [Store]

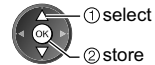

Update DVB channel automatically [Update Channel List]

You can add new channels, delete removed channels, update channel name and position automatically to the channel list.

Example: (UK)

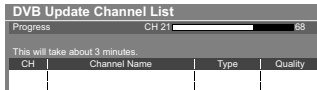

- The channel list is updated while keeping your settings in [Favourites Edit], [Channel List], [Child Lock], etc.
- Depending on the signal condition, the update may not work properly.

Display a notification message [New Channel Message] (DVB)

Selects whether to give a notification message when a new DVB channel is found.

- Selecting OK will perform [Update Channel List].

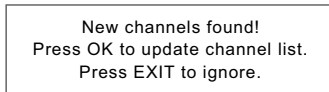

Check DVB signal [Signal Condition]

Selects a channel and checks the DVB signal condition.

A good Signal Strength is not an indication of suitable signal for DVB reception. Use the Signal Quality indicator as follows.

- Green bar: Good
- Yellow bar: Poor
- Red bar: Bad (Check the Terrestrial aerial)

- To change the channel



Example: (UK)

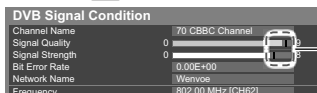

These bars show the maximum signal value of the selected channel.

Timer Programming

Timer Programming from Menu

The Timer Programming menu allows you to choose programmes that you want to remind watching or record to the external recorder. At the correct time, the TV will tune to the correct channel even if the TV is in Standby mode. TV Guide may also be used to set timer programming event (p. 24).

- Timer Programming can store up to 15 events.
- Timer Programming only works reliably if correct time information is received via the signal from the broadcaster or service provider.
- For recording using Timer Programming, the TV must be either on or in Standby. For reminders to be displayed, the TV must be on.
- No other channel can be selected while the recording of Timer Programming is in progress.
- Recording an encrypted (copy-protected) programme may not be possible.
- When recording programmes to the external recorder, be sure to make the proper settings on the recorder connected to the TV. If a recorder compatible with Q-Link, VIERA Link or similar technologies is connected to the TV (p. 76, 77) and [Link Settings] (p. 37) are completed, no setting of the recorder is required. Also read the manual of the recorder.
- If the recorder is not compatible with Q-Link, VIERA Link or similar technologies, make timer programming of the recorder. For preparations of a recorder, read the manual of the recorder.
- Recording to the external equipment via SCART is always in standard definition (composite video), even if the original programme is in high definition.
- 2 minutes before the starting time, a reminder message appears if you are watching TV.
 - To remove the message and start the programming
 - To cancel the programming



1 Select the tuner you want to use (DVB or Analogue)

→ (p. 19)



2 Display the menu and select [Timer]



- ① select
- ② access

3 Select [Timer Programming]

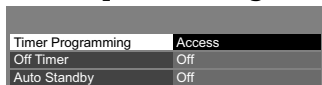

- ① select
- ② access

Set timer programming event details

1 Start making the settings



[Ext Rec.]  :

Records the programme to the external recorder.

When the start time comes, the channel will be switched automatically and the video and audio signals will be output. 2 minutes before the starting time, a reminder message appears if you are watching TV.

[Reminder]  :

Reminds you to watch the programme.

When you are watching TV, a reminder message appears 2 minutes before the start time.

Press the OK button to switch to the programmed channel.

2 Select the function ([Ext Rec.] or [Reminder])



3 Set the channel, date and time (repeat the operations as below)

Set items in the order of 1 to 4.



select the item



set

- 1, 3 and 4 can also be entered with numeric buttons.

Store



! : Overlapped timer programming events

Timer programming - Programmes according to the time setting

Function	No.	Channel Name	Date	Start	End
Ext Rec.	72	BBC 2W <TIMER>	Wed 26 Oct	20:00 (90 min.)	21:30
Reminder	14	E4 The Bill	Wed 26 Oct	21:00 (60 min.)	22:00
Ext Rec.	1	BBC ONE DIY SOS	Wed 26 Oct	22:45 (15 min.)	23:00
Ext Rec.		BBC ONE <TIMER>	Thu 27 Oct	10:30 (90 min.)	11:30

Duration (automatic display)

Records with subtitles (if available)

• To indicate this

 (yellow) (Press again to remove subtitles)

2 Date

 one day ahead

 daily or weekly (press repeatedly)

• [Daily Sun-Sat]: Sunday to Saturday

• [Daily Mon-Sat]: Monday to Saturday

• [Daily Mon-Fri]: Monday to Friday



• [Weekly Sat/Fri/Thu/Wed/Tue/Mon/Sun]:

Same time on the same day every week

1 Channel number

4 Ending time

3 Starting time

 : DVB /  : Analogue 

D: DVB / A: Analogue 

• You cannot change the mode within the menu.



 : Guide link programming - Programmes according to the TV Guide signal (p. 25)

 : Split Programme programming (p. 25)

• These functions are not available in Analogue mode.

Guide link programming is Timer Programming which is controlled by information from the TV Guide; if programme start and end times are changed by the broadcaster, the timer programming event will follow the change.

A Split Programme programming is a Guide link programming which is interrupted by one or more other programmes. Note that Guide link programming (including Split Programme programming) only works reliably if correct information is received from broadcasters.

■ To edit a timer programming event

Select the event



• To change a timer programming event



➔ Correct as necessary (p. 48)

• To delete a timer programming event



• To record with subtitles (if available)

 (yellow)

• Each time pressed:
auto ↔ off

• To cancel a timer programming event temporarily

 (blue)

• Each time pressed:
cancel ↔ stop cancelling

■ To unlock the tuner and stop recording



■ To view details of the programming (only for Guide link programming)

Select the programme



• Press again to return to
Timer Programming menu.

Note

• Check that the LED is orange. If not, timer programming events are not active or not stored.

• Timer Programming reminder messages will remain displayed until one of the following occurs:

• You press the OK button to view the programme or the EXIT button to cancel the reminder.

• The timer programming event that the reminder is set for ends.

• "!" identifies that two or more timer programming events are overlapped. [Ext Rec.] is given priority over [Reminder]. As for the overlapped recording events, the first event starts and finishes as programmed. The next event can then start.

• The recording of Timer Programming will automatically change to the programmed channel a few seconds before the start time.

• To stop recording the timer programming event, it may be necessary to stop the recorder manually.

• The recording of Timer Programming will be performed even if the TV is in [Pause Live TV] recording (p. 79). In this case, [Pause Live TV] recording will be cancelled.

Child Lock

You can lock specific channels / AV input terminals and control who watches them. When the locked channel / input is selected, a message appears. Enter the PIN number to watch.

1 Display the menu and select [Setup]



2 Select [Child Lock]



Control channel audience [Child Lock]

1 Enter the PIN number (4 digits)



- Enter the PIN number twice at first setting.
- Make a note of the PIN number in case you forget it.

2 Select [Child Lock List]

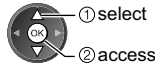

3 Select the channel / input to be locked

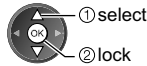
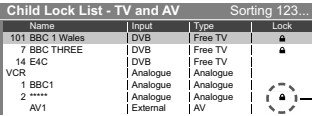

: Appears when the channel / input is locked

- To cancel
Select the locked channel / input
- To lock all
 (green)
- To cancel all locks
 (yellow)
- To jump to the top of the next input
 (blue)
- In DVB mode, additional lock item will appear. **[UK only]**
[Freeview Players]: Applies access control for some MHEG services.

■ To change the PIN number

1. Select [Change PIN]

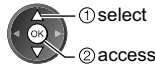

2. Enter a new PIN number twice



■ To set Parental Rating **[Ireland only]**

To watch the DVB programme that has the rating information over the selected age, enter the PIN number to watch (depending on the broadcaster).

Select [Parental Rating] and set an age for the restriction of programmes.

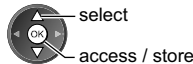

Note

- Setting [Shipping Condition] (p. 51) erases the PIN number and all settings.

Shipping Condition

Resets the TV to its original condition, i.e. no channels tuned in.

All settings other than [Owner ID] are reset (channels, picture, sound settings, etc.).

- To retune TV channels only, e.g. after moving house ➔ **"Retuning from Setup Menu"** (p. 44)

1 Display the menu and select [Setup]



2 Select [System Menu]

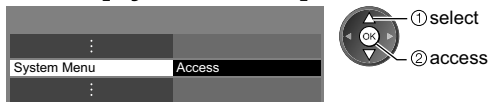

3 Select [Shipping Condition]

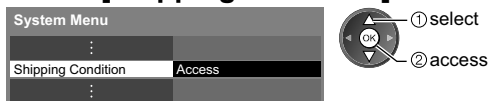

Restore Settings [Shipping Condition]

1 Check the message and initialise

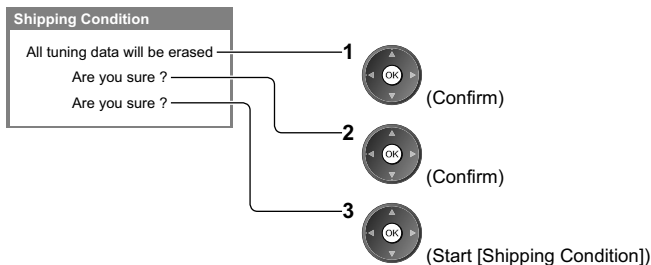

2 Follow the on-screen instructions

Reset to Factory Shipping Condition Completed.
TV will automatically restart.
Do not turn off

- [Auto Setup] will automatically start. (p. 14)

Owner ID

Entry of the PIN number and personal information (your name, address and postcode).
 In the unfortunate event of theft, the Owner ID will help the Police to determine the owner.

1 Display the menu and select [Setup]



2 Select [System Menu]



3 Select [Owner ID]



Input owner ID [Owner ID]

1 Enter the PIN number (4 digits)



- Enter the PIN number twice at first setting.
- Make a note of the PIN number in case you forget it. The PIN number cannot be reset.

2 Select the item (NAME / HOUSE NO / POSTCODE) and set characters

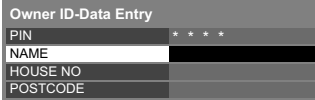

Return to select other items



- Select the next item and repeat the operations.

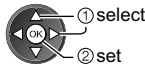

- To use numeric buttons → (p. 92)

3 Exit the menu



■ To check the personal information stored

Hold down for about 5 seconds



- The PIN number is not displayed.

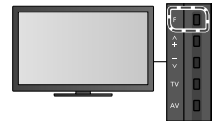

■ To change the PIN number

1. Select [PIN]

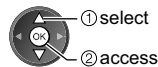
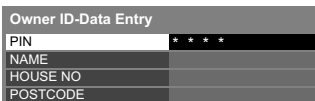

2. Enter a new PIN number twice



Using Common Interface

The Common Interface Module menu provides access to software contained on Common Interface (CI) Modules.

This TV works only for Pay TV modules complying with CI standard.

This function is not available for BskyB's Sky channels.

- Video and audio signals may not be output depending on broadcasts or services.

Caution

- Turn off Mains power On / Off switch whenever inserting or removing the CI module.
- If a view card and a card reader come as a set, first insert the card reader, then insert the view card into the card reader.
- Insert the module in the correct direction.
- Remove the CI module from the TV when placing the TV facing upward. This may cause damages to the CI module and CI slot.

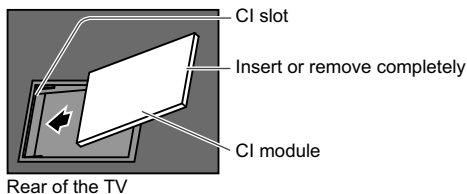

Insert the CI module (optional)

- The features that appear on screen are dependent on the contents of the selected CI module.
- Follow the instructions that came with the viewing card to tune in the encrypted channels. If encrypted channels do not appear, perform the below to verify the card is recognised by the TV.
- For more details, read the manual of the CI module, or check with the broadcaster.

1 Select DVB

➔ (p. 19)



2 Display the menu and select [Setup]

MENU



3 Select [System Menu]



4 Select [Common Interface]

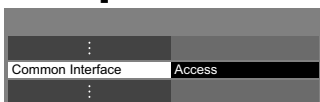

5 Access Common Interface and follow the on-screen instructions



- On-screen instructions may not correspond to the remote control buttons.

Updating the TV Software

A new version of software may be released for download to enhance the performance or operations of the TV. In DVB mode, a notification banner will appear when one of the BBC channels is turned to if a new available software is found.

- To download

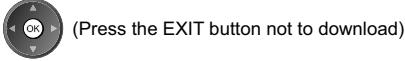

You can update new software automatically or update manually.

1 Display the menu and select [Setup]

2 Select [System Menu]

3 Select [System Update]

Update TV's software system [System Update]

■ To update automatically

Select [Auto Update Search in Standby]

- Automatically performs a search in standby and downloads an update, if any software updates are available.
- The automatic updating is performed at night under the following conditions:
 - Standby (TV turned off with the remote control)
 - Recording of Timer Programming or Direct TV Recording is not in progress.

If System Update is performed, the software will be updated (it may change TV functions). If you do not want to do so, set [Auto Update Search in Standby] to [Off]. The notification banner will keep appearing during the period of new software availability, usually 2 to 3 days.

■ To update immediately

1 Select [System Update Search Now]

2 Searches for an update (for several minutes) and displays a corresponding message if any

3 Download

Note

- Download may take up to 60 minutes.
- During software download and update, DO NOT perform any operations on the TV or switch Off the TV.

Displaying PC Screen on TV

The screen of the PC connected to the TV can be displayed on the TV.
 You can also listen to PC sound with the audio cable connected.

- To connect PC ➔ (p. 82)

1 Select the external input

AV

2 Select [PC]

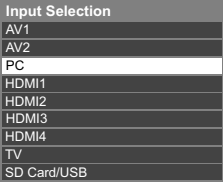

- Corresponding signals ➔ (p. 91)
- If [H-freq.] or [V-freq.] is shown in red, the signals may not be supported.

PC menu setting

- To make settings ➔ “How to Use Menu Functions” (p. 32)

Menu	Item	Adjustments / Configurations (options)
Setup PC Setup	Input Resolution	Switches to a wide view: • VGA (640 × 480 pixels) / WVGA (852 × 480 pixels) / XGA (1,024 × 768 pixels) / WXGA (1,280 × 768 pixels, 1,366 × 768 pixels) • Options change depending on signals
	Clock	Set to the minimum level if noise occurs
	H-pos	Adjusts horizontal position
	V-pos	Adjusts vertical position
	Clock Phase	Eliminates flicker and distortion • Adjust after Clock adjustment • Set to the minimum level if noise occurs
	Sync	Chooses another synchronous signal if the image is distorted [H & V] / [On Green] [H & V] : by the horizontal and vertical signals from your PC [On Green] : by the green signal from your PC (if available)
	Reset to Defaults	Press the OK button to reset [PC Setup] to the default settings

- Other items ➔ (p. 33 - 39, 56)

Note

- For HDMI-compatible PC, possible to connect to HDMI terminals (HDMI1 / HDMI2 / HDMI3 / HDMI4) by using HDMI cable (p. 90).

Advanced Picture Settings

You can adjust and setup the detailed picture settings for each Viewing Mode.

- To use this function completely, set [Advance(Calibration)] to [On] in the Setup Menu. ➔ (p. 39)
- For PC input mode, some functions are available without setting [Advance(Calibration)].

1 Display the menu and select [Picture]



2 Select [Viewing Mode] and set the mode



3 Select [Advanced Settings]

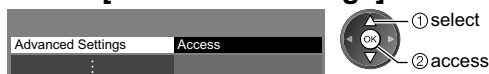

Adjust the detailed picture settings [Advanced Settings]

Advanced Settings	
White Balance	Access
Colour Management	Access
Gamma	Access
⋮	



- [Colour Management] is available when [Viewing Mode] in the Picture Menu is set to [True Cinema].

Menu	Item	Adjustments / Configurations (alternatives)
Picture	White Balance	R-Gain, G-Gain, B-Gain Adjusts the white balance of bright red / green / blue area
		R-Cutoff, G-Cutoff, B-Cutoff Adjusts the white balance of dark red / green / blue area
		Reset to Defaults Press the OK button to reset to the default White Balance
	Colour Management	R-Hue, G-Hue, B-Hue Adjusts the picture hue of red / green / blue area
		R-Saturation, G-Saturation, B-Saturation Adjusts the saturation of red / green / blue area
		R-Luminance, G-Luminance, B-Luminance Adjusts the luminance of red / green / blue area
		Reset to Defaults Press the OK button to reset to the default Colour Management
	Gamma	Gamma Switches the gamma curve [1.8] / [2.0] / [2.2] / [2.4] / [2.6] • Please note the numerical values are reference for the adjustment.
		Reset to Defaults Press the OK button to reset to the default Gamma

Using Media Player

Media Player allows you to enjoy photo, video or music recorded on an SD Card and a USB Flash Memory. VIERA IMAGE VIEWER is the function of the easy viewing for photos or videos recorded on an SD Card on the TV screen by simply inserting into the SD Card slot.

Photo mode:

Still pictures recorded by digital cameras will be displayed.

Video mode:

Moving pictures recorded by digital video cameras will be played back.

Music mode:

Digital music data will be played back.

- During the operation, audio signal is output from AV1, DIGITAL AUDIO OUT and HDMI2 (ARC function) terminals. But no video signals are output. AV1 can output audio signal if [AV1 out] is set to [Monitor] in the Setup Menu (p. 37). To use HDMI2 with ARC function, connect an amplifier that has ARC function (p. 75) and set to use theatre speakers (p. 81).
- [Date] shows the date on which the recording was made by the recording equipment. The file without record of the date is shown "****/****".
- The picture may not appear correctly on this TV depending on the recording equipment used.
- Display may take some time when there are many files and folders.
- Partly degraded files might be displayed at a reduced resolution.
- Picture setting may not work depending on the conditions.
- The folder and file names may be different depending on the digital camera or digital video camera used.

■ To insert or remove the SD Card / USB Flash Memory

USB Flash Memory

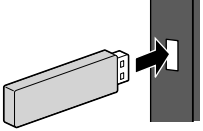

- Insert or remove straightly and completely.
- Connect the USB Flash Memory to the USB 1 or 2 port.

SD Card

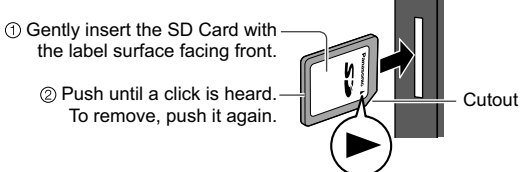

- ① Gently insert the SD Card with the label surface facing front.
- ② Push until a click is heard. To remove, push it again.



- For the information of the devices ➔ **“Devices for recording or playing back”** (p. 89)
- For the supported file format ➔ **“Supported file format in Media Player and media servers”** (p. 86, 87)

Starting Media Player

1 Insert the SD Card or USB Flash Memory to the TV

➔ (p. 57)

2 Confirm the message and start Media Player



• You can also start by pressing following button.

AV ➔ “Watching External Inputs” (p. 29)

3 Select the device to access



① select
② access

Selected device name

• If two or more devices are not connected, this step will be skipped.

4 Select the content



① select
② access

[Photo] ➔ (p. 59)

[Video] ➔ (p. 62)

[Music] ➔ (p. 64)

5 Enjoy Media Player

Example: Thumbnail - [All photos]



• To display the information of the highlighted content



File name	1/48
Date	p1010001.JPG
Size	23/10/2011
	1600X1200

File number / Total file number

Selected device name

Note

- You can also access each mode directly by using VIERA TOOLS. ➔ (p. 31)
- Select the appropriate device and content for playing back each file.
- You can use the following buttons during playback. Set the code of the remote control to “73” (p. 30).



Change the device

You can change to the other device directly in the same mode if two or more devices are connected.

1 While the thumbnail is displayed, display the device selection

(yellow)

2 Select the device to access

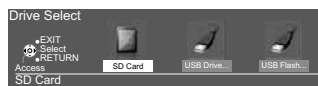

① select
② access

Selected device name

Change the contents

You can switch to the other mode of Media Player from the thumbnail view.

• The mode can be switched in the current device.

1 While the thumbnail is displayed, display the contents selection

(blue)

2 Select the contents



① select
② access

Photo mode

Photo mode will read all ".jpg" extension files in the SD Card or USB Flash Memory.

The thumbnail of all the photos in the SD Card or USB Flash Memory will be displayed.

Example: Thumbnail - [All photos]



- To change the size of photos on a thumbnail screen
 OPTION →

: Error display

[Single view] - Photos are displayed one at a time.

Select the file from the thumbnail of photos to be viewed

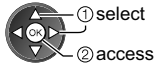

Example:

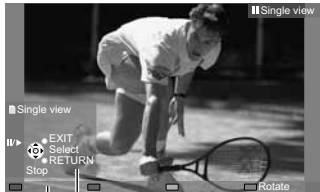

Operation guide

- To display / hide the operation guide
- To return to thumbnail
BACK/RETURN

- To operate Single view
 To the previous photo
 Slideshow
 To the next photo
 Stop (return to thumbnail)

- To rotate 90°
 (blue)

[Slideshow] - Slideshow completes when all photos are viewed within the current thumbnail.

1 Select the file from the thumbnail of photos for the first view



- To display / hide the operation guide
- To pause (return to Single view)

- To change the back ground music → "Photo Settings" (p. 60)

2 Start Slideshow

(red)



- To return to thumbnail
BACK/RETURN

■ To sort by folder, recorded date or recorded month

1 Display the view selection in the thumbnail view

(green)

2 Select the sort type

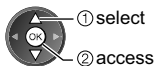

[Folder view]:

Displays the thumbnail grouped by folder.

- The files which are not into a folder will be collected to the folder named "/".

[Sort by Date] / [Sort by Month]:

Displays the thumbnail grouped by the same date or month.

- The group of the photos without a recorded date is shown as [Unknown].

- To return to the thumbnail of all photos

(green)



Photo Settings

Setup the settings for Photo mode.

1 Display the option menu

OPTION



2 Select [Slideshow Settings]



3 Select the items and set



Slideshow Settings	
Frame	Off
Colour Effect	Off
Transition Effect	Fade
Aspect	Normal
Burst Playback	Off
Interval	5 seconds
Repeat	On
Back Ground Music	



select

access / store

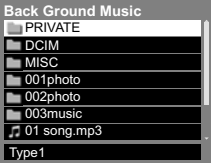
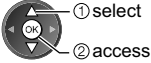
Menu	Item	Adjustments / Configurations (alternatives)
Slideshow Settings	Frame	<p>Selects the frame type of the slideshow [Off] / [Multi] / [Collage] / [Drift (+ calendar)] / [Drift] / [Gallery (+ calendar)] / [Gallery] / [Cinema]</p> <p>[Multi]: 9 photos are displayed orderly at once.</p> <p>[Collage]: Each photo is displayed at a random position and random scale.</p> <p>[Drift (+ calendar)] / [Drift]: Photos are displayed like flow images.</p> <ul style="list-style-type: none"> You can select to display the calendar or not. The month of calendar is turned by pressing the left or right cursor button. <p>[Gallery (+ calendar)] / [Gallery]: The various sizes of photos in the frame are displayed.</p> <ul style="list-style-type: none"> You can select to display the calendar or not. The month of calendar is turned by pressing the left or right cursor button. <p>[Cinema]: Photos are displayed like old films (sepia tone).</p>
	Colour Effect	<p>Selects the colour effect of photos on Single view and Slideshow [Off] / [Sepia] / [Gray scale]</p> <ul style="list-style-type: none"> This function is not available when [Frame] is set to [Drift], [Gallery] or [Cinema].
	Transition Effect	<p>Selects the transition effect for switching the photo during the slideshow [Off] / [Fade] / [Slide] / [Dissolve] / [Motion] / [Random]</p> <p>[Fade]: The next photo fades in gradually.</p> <p>[Slide]: The next photo slides and appears from the left side.</p> <p>[Dissolve]: Each photo is dissolved when switching to the next photo.</p> <p>[Motion]: Each photo is displayed with an effect of enlarging, reducing, moving up or moving down.</p> <p>[Random]: Each transition is selected at random.</p> <ul style="list-style-type: none"> This function is available when [Frame] is set to [Off].
	Aspect	<p>Selects enlarged or normal viewing on Single view and Slideshow [Original] / [Zoom]</p> <ul style="list-style-type: none"> This function is not available when [Frame] is set to [Collage], [Drift], [Gallery] or [Cinema] or when [Transition Effect] is set to [Motion]. Depending on the photo size, it may not be fully enlarged to fill the screen, e.g. portrait style picture.
	Burst Playback	<p>Selects whether to display burst photos in a fast-paced slideshow mode [Off] / [On]</p> <ul style="list-style-type: none"> This function is not available when [Frame] is set to [Drift], [Gallery] or [Cinema] or when [Transition Effect] is set to [Motion].
	Interval	<p>Selects slideshow interval [5] / [10] / [15] / [30] / [60] / [90] / [120] (seconds)</p> <ul style="list-style-type: none"> This function is not available when [Frame] is set to [Drift], [Gallery] or [Cinema] or when [Transition Effect] is set to [Motion].
	Repeat	<p>Slideshow repeat [Off] / [On]</p>

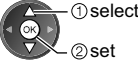
Menu	Item	Adjustments / Configurations (alternatives)
Slideshow Settings	Back Ground Music	<p>Selects the back ground music during Photo mode [Off] / [Type1] / [Type2] / [Type3] / [Type4] / [Type5] / [User] / [Auto] • [Type1 - 5] are the fixed music each installed in this TV. [User]: Music data in the device registered by yourself will be played back.</p> <p>To register the music</p> <ol style="list-style-type: none"> Select the music file Depending on the condition of the device, select folders until you reach the desired music file.   <ol style="list-style-type: none"> Select [File] or [Folder]   <p>[File]: The selected music file will be registered. [Folder]: All the music in the folder which contains the selected music file will be registered.</p> <p>• If no music has been registered or the device which has the registered music is removed, no sound will be produced.</p> <p>[Auto]: Music data stored in the root folder of the current device will be played back randomly.</p> <p>• If there is no available music data, no sound will be produced.</p>

Note

- Picture quality may become lower depending on the slideshow settings.
- Picture setting may not work depending on the slideshow settings.

Video mode

- Supported file format ➔ (p. 86, 87)

The thumbnail of video titles in the SD Card or USB Flash Memory will be displayed.

Example: Thumbnail - [Title view]



The preview will start when the title / scene is highlighted if it supports a preview.

- To turn off the preview ➔ "Video Setup" (p. 63)

: Error display

: The file does not support thumbnail view.

- To play back the selected title

Select the title → Start playback



(red)

- If you stopped the last playback on the way, the confirmation screen is displayed to select whether to start from where you stopped last time or from the beginning.

■ Playback from the selected scene in the title (SD-Video or AVCHD)

Playback of the selected scene will start to the end of the title.

1 Select the title



2 Select the scene



3 Start playback

(red)

Note

- The structure of titles and scenes may vary depending on the digital video camera used.
- To repeat playback ➔ "Video Setup" (p. 63)

■ How to operate in the playback

Example: Playback



Operation guide

Information banner

- To display / hide the operation guide and information banner



- To the previous title / scene

(red)

- To the next title / scene

(green)

- To change aspect



- To return to thumbnail



- To operate the playback

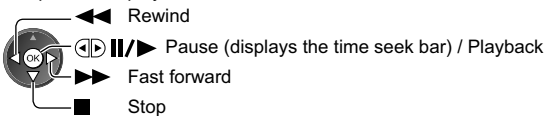

- To jump to the specified time point

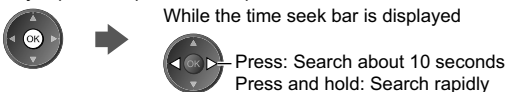

■ Video Setup

Setup the settings for Video mode.

- Menu items and selectable options vary depending on the content.

1 Display the option menu

OPTION



2 Select [Video Setup]



3 Select the items and set

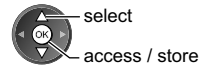

Menu	Item	Adjustments / Configurations (alternatives)
Video Setup	Video Preview	Sets to start the preview of the title or scene in the thumbnail view [Off] / [On] <ul style="list-style-type: none"> • Image may not be displayed for an instant in the thumbnail view. Set the preview [Off] to resolve this. • Only available in the thumbnail view
	Multi Audio, Dual Mono Audio	Selects between selectable sound tracks (if available) <ul style="list-style-type: none"> • It may take several seconds to change the sound. • Only available during playback
	Subtitle	Subtitles On / Off (if available) <ul style="list-style-type: none"> • Only available during playback
	Subtitle Text	Selects the font type to display subtitles correctly. (if available) <ul style="list-style-type: none"> • Only available during playback
	Aspect Change	[Aspect1]: Displays the content enlarged without distortion. [Aspect2]: Displays the content full-screen. [Original]: Displays the content original size. <ul style="list-style-type: none"> • You can also change the aspect using the ASPECT button. • Aspect change may not work depending on the content. • Only available during playback
	Repeat	Playback repeat within the title or selected file (depending on the content) [Off] / [On]
	Title	Selects from a group of titles (if available)

Audio output Settings

You can enjoy the multi-channel sound via an amplifier connected to DIGITAL AUDIO OUT or HDMI2 (ARC function) terminal.

- To confirm or change the current sound status ➔ (see above)

1 Display the menu and Select [Sound]

MENU

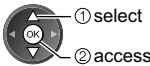

2 Select [SPDIF Selection] and set

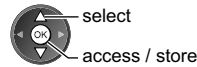

Menu	Item	Adjustments / Configurations (alternatives)
Sound	SPDIF Selection	SPDIF: A standard audio transfer file format Selects the initial setting for digital audio output signal from DIGITAL AUDIO OUT and HDMI2 (ARC function) terminals [Auto] / [PCM] [Auto]: Dolby Digital Plus, Dolby Digital and HE-AAC multi-channel are output as Dolby Digital Bitstream. DTS is output as DTS. MPEG is output as PCM. [PCM]: Digital output signal is fixed to PCM.

Music mode

- Supported file format ➔ (p. 87)

The thumbnail of music folders in the SD Card or USB Flash Memory will be displayed.

Example: Thumbnail - [Folder view]

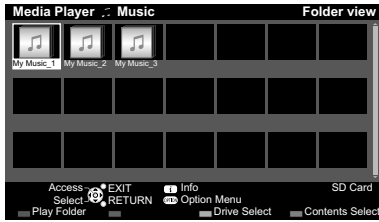

- To play back the selected folder
Select the folder



- Start playback



■ Playback from File view

Selected file will be played back.

1 Select the folder



2 Select the file



3 Start playback



■ How to operate in the playback

Example: Playback



Operation guide

- To display / hide the operation guide



- To operate the playback

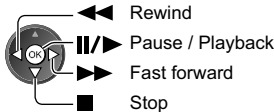

- To the previous track



- To the next track



- To return to thumbnail



Music Setup

Setup the setting for Music mode (only available in the thumbnail view).

1 Display the option menu



2 Select [Music Setup]



3 Set



[Folder]: Playback repeat within the selected folder

[One]: Playback repeat of the selected one file

Using Network Services (DLNA / VIERA Connect)

DLNA®

This TV is a DLNA Certified™ product.

DLNA (Digital Living Network Alliance) is a standard that makes DLNA Certified digital electronics easier and more convenient to use on a home network. To learn more, visit www.dlna.org.

It allows you to share photos, videos and music stored in the DLNA Certified media server (for example, PC with Windows 7 installed, DIGA Recorder etc.) connected to your home network, and enjoy the contents on the TV screen. It also allows you to control the TV with the DLNA Certified equipment connected to your home network. (DLNA Remote Control)

- For the supported file format ➔ (p. 86, 87)
- AVCHD and DivX files are not supported by DLNA functions of this TV, but can be played by Media Player (p. 57).

■ Media server

Store photos, videos or music into the DLNA Certified media server, and then you can enjoy them on the TV.

To use a PC as a media server

Prepare the PC with Windows 7 or ensure the server software is installed on the PC.

“Windows 7” and “TwonkyMedia server 6 (installed on the PC with Windows 7, Windows Vista or Windows XP)” are the server software that has been tested for compatibility with this TV (as of January, 2011). Any other server software have not been tested with this TV, therefore compatibility and performance cannot be assured.

- Windows 7
The setup for homegroup settings of Windows 7 is required. For details, refer to the help functions of Windows 7.
- TwonkyMedia server
“TwonkyMedia server” is the product of PacketVideo Corporation.
To obtain the Installation Guides for installing and setting “TwonkyMedia server”, visit the website of TwonkyMedia.
Additional fees may be charged to obtain server software.

Note

- For more information about the server software, please consult each software company.
- When server software for the media server is installed on the PC, the data may be at risk of being accessed by other people. Please take care of the settings and connections under the network circumstances at the office, hotel or even at home when not using a router.

To use a DLNA compatible DIGA Recorder as a media server

By connecting a DLNA compatible DIGA Recorder to your home network, you can enjoy and control it as one of the media servers.

- Please read the manual of your DIGA Recorder to confirm whether the recorder is compatible with DLNA.

■ DLNA Remote Control

You can control the TV with the DLNA Certified equipment.

- To use this function, set [Network Link Settings]. ➔ (p. 67)
- “Windows 7” is the OS that has been tested for compatibility of this TV (as of January, 2011). For the operations, refer to the help functions of Windows 7.

Network connection ➔ “Example 1”, “Example 2” (p. 66)

Network setup ➔ (p. 67 - 70)

DLNA operations ➔ (p. 70 - 73)

VIERA Connect

VIERA Connect is a gateway to the internet services unique to Panasonic.

VIERA Connect allows you to access some specific websites supported by Panasonic, and enjoy internet contents such as videos, games, EPG, communication tools, etc. from VIERA Connect home screen.

- This TV does not support full web browser function and some features of the websites may not be available.

Network connection ➔ “Example 1”, “Example 3” (p. 66)

Network setup ➔ (p. 67 - 70)

VIERA Connect operations ➔ (p. 18, 73)

Network connections

To use only DLNA features, you can operate the features without broadband network environment.

To use VIERA Connect features, you need a broadband network environment.

- If you do not have any broadband network services, please consult your retailer for assistance.
- Set up and connect any equipment required for the network environment. You cannot make settings for the equipment on this TV. Read the manual of the equipment.
- Required speed (effective): at least 1.5 Mbps for SD and 6 Mbps for HD picture quality, respectively. If the transfer speed is not enough, contents may not be played back properly.

Example 1

(For DLNA and VIERA Connect)

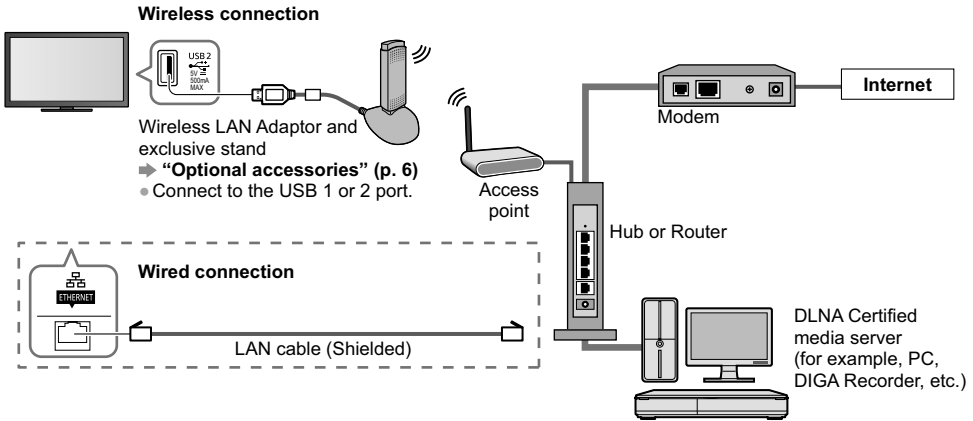

- Ensure to use a LAN straight cable for this connection.
- If your modem has no broadband router functions, use a broadband router.
- If your modem has broadband router functions but there are no vacant ports, use a hub.
- Ensure that the broadband routers and hubs are compatible with 10BASE-T / 100BASE-TX.
- If you use the equipment compatible only with 100BASE-TX, category 5 LAN cables are required.

Example 2

(For DLNA)

You can connect the TV and the equipment directly to use DLNA features.

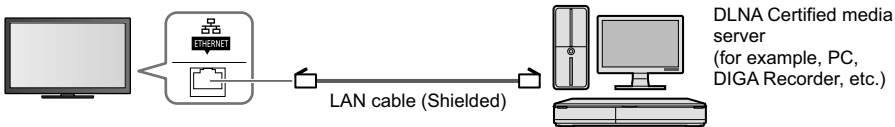

- Ensure to use a LAN cross cable for this connection.

Example 3

(For VIERA Connect)

You can connect the TV and the telecommunication equipment directly to use VIERA Connect features.

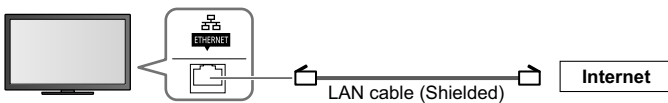

Note

- Contact your Internet Service Provider (ISP) telecommunications company for further assistance regarding the network equipment.
- Confirm the terms and conditions of the contracts with your Internet Service Provider (ISP) or telecommunications company. Depending on the contracts, additional fees may be charged or multiple connections to the internet may be impossible.

Network Setup

- Ensure the connections are completed before starting Network Setup.
 - ➔ “Network connections” (p. 66)

1 Display the menu and select [Network]



Network Link settings

Sets the link settings to control this TV from the network equipment via the network.

1 Select [Network Link Settings]

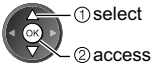
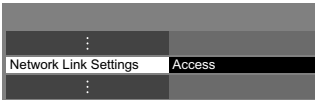

2 Select the items and set

Network Link Settings	
VIERA Name	VIERA
DLNA Remote Control	On
DLNA Remote Volume	On
Network Remote Control	On

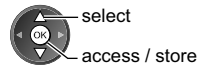

Menu	Item	Adjustments / Configurations (alternatives)
Network Link Settings	VIERA Name	Sets your favourite name for this TV <ul style="list-style-type: none"> • This name will be used as the name of this TV on the screen of the other network equipment.
	DLNA Remote Control	Enables to control the TV using Windows 7 via the network [Off] / [On]
	DLNA Remote Volume	Enables to control the volume of the TV using Windows 7 via the network [Off] / [On]
	Network Remote Control	Enables to control the TV from the network equipment (Smartphone, etc.) [Off] / [On] <ul style="list-style-type: none"> • Depending on the area, this function may not be available. For details, consult your local Panasonic dealer. • For more information of this function: http://panasonic.jp/support/global/cs/tv/

Wired connection settings

This setting is for the network connection by using the LAN cable.

1 Select [Network Connection] and set to [Wired]

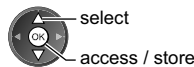
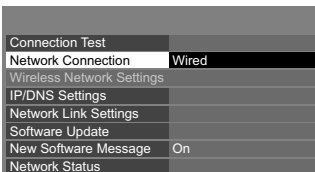

If you make the network connection like “Example 2” (p. 66), you do not have to set [Acquire DNS Address], [Proxy] and [Proxy Port].

2 Select [IP/DNS Settings] and set the items



■ [Acquire IP Address] / [Acquire DNS Address]

Sets [IP Address], [Subnet Mask], [Default Gateway], [Primary DNS] and [Secondary DNS].
 Select [Acquire IP Address] / [Acquire DNS Address] and set to [Auto] (recommended).

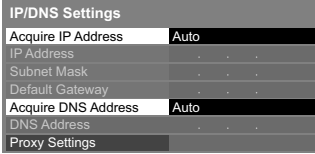

- The available settings are displayed automatically.

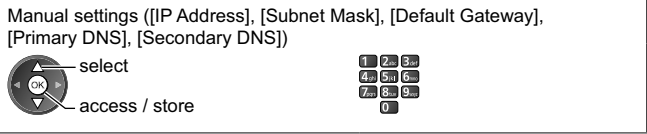

3 Select [Proxy Settings] and set the items

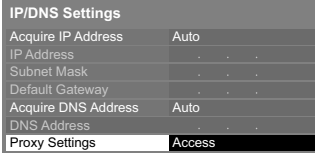

- After settings, return to the previous menu.



■ [Proxy]

Sets Proxy address.

- This is the address of the relay server that is connected to the target server instead of the browser and sends data to the browser. Setting is required if specified by the provider.

1. Select [Proxy]

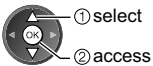
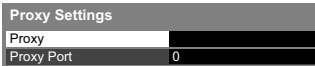

2. Enter the address

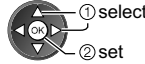

- You can set characters by using numeric buttons.

3. Store



■ [Proxy Port]

Sets Proxy port number.

- This number is also specified by the provider with the Proxy address.

1. Select [Proxy Port]

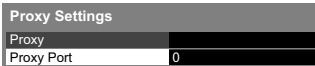

2. Move the cursor and enter the number



4 Select [Connection Test] and access to test

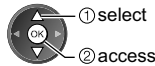

- Performs automatic testing of the network connection for the TV. (It takes a while to test.)

: **succeeded**

The test is successful and the TV is connected to the network.

: **failed**

Check the settings and connections. And then select [Retry].

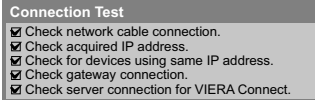

Wireless connection settings

This setting is for the wireless network connection.

- Confirm the encryption key, settings and positions of your access point before starting setup. For details, read the manual of the access point.

1 Select [Network Connection] and set to [Wireless]

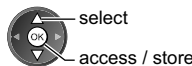
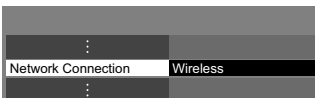

2 Select [Wireless Network Settings]

Connection Test	
Network Connection	Wireless
Wireless Network Settings	Access
IP/DNS Settings	
Network Link Settings	
Software Update	
New Software Message	On
Network Status	

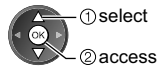

- When the access point is already set, [Current Settings] screen will be displayed.
To change the settings, select [No] on this screen and go to the next step.

3 Select your desired access point

Available Wireless Networks			
No.	Network Name (SSID)	Wireless type	Status
1	Access Point A	11n(2.4GHz)	Encrypted
2	Access Point B	11n(5GHz)	Not encrypted
3	Access Point C	11n(5GHz)	Not encrypted

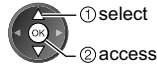

: Encrypted access point

- For [WPS(Push button)] (p. 16)



- For [WPS(PIN)] (see below)



- To set manually (p. 70)

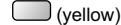

- To search access points again



- For the information of the highlighted access point



4 Access the encryption key input mode

Encryption Key Setting

Connection will be made with the following settings:-
 Network Name(SSID) : Access Point A
 Security type : WPA-PSK
 Encryption type : TKIP

Please input the encryption key.

Encryption key



- If the selected access point is not encrypted, the confirmation screen will be displayed. It is recommended to select the encrypted access point.

5 Enter the encryption key of the access point

Wireless Network Settings

Encryption key

A	B	C	D	E	F	G	H	I	J	K	L	M	N	O	P	Q	R	S	T
U	V	W	X	Y	Z	0	1	2	3	4	5	6	7	8	9	*	#		
a	b	c	d	e	f	g	h	i	j	k	l	m	n	o	p	q	r	s	t
u	v	w	x	y	z	()	+	-	*	@	/	'	%	&	?			
-	_	\$	[]	<	>	()		^	\								

1 2 3 4 5 6 7 8 9 0
 F1 F2 F3 F4 F5 F6 F7 F8 F9 F10
 F11 F12

Set characters

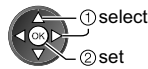

- You can set characters by using numeric buttons.
- After settings, return to the previous menu.



6 Select [Connection Test] and access to test

Connection Test	Access



- Performs automatic testing of the network connection for the TV. (It takes a while to test.)

Connection Test

Check wireless network connection.
 Check acquired IP address.
 Check for devices using same IP address.
 Check gateway connection.
 Check server connection for VIERA Connect.

: succeeded

The test is successful and the TV is connected to the network.

: failed

Check the settings and connections. And then select [Retry].
 If you continue to have difficulty, please contact your internet service provider.

■ [WPS(PIN)]

Enter the PIN code to the access point, and then select [Connect]

WPS(PIN)

Please register the following PIN codes on the wireless access point.

PIN code : 12345678

Select 'Connect' after entering and saving the settings on the wireless access point.

Connect



■ [Manual]

You can setup SSID, authentication type, encryption type, and encryption key manually. Follow the on-screen instructions and set manually.

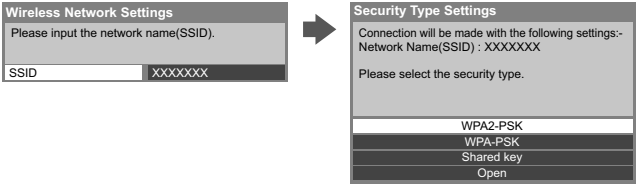

Update TV's software

Accesses the specific website to update TV's software and search if any software updates are available.

Select [Software Update]

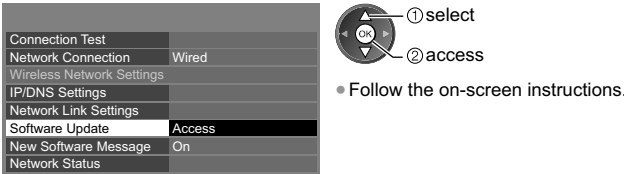

Using DLNA® features

- Ensure the preparation of the media server, network connections and network settings are completed.
 - ➔ "Media server" (p. 65), "Network connections" (p. 66), "Network Setup" (p. 67 - 70)

1 Display [VIERA TOOLS] and select [Media Server]



2 Select one of the media servers to access

Example: Media server list

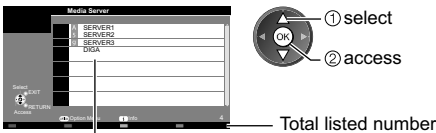

- To display the information of the highlighted media server



Available media servers

3 Select the file

Example: File list



- Depending on the condition of media server, you may need to select the folder before selecting the file.
- To display the information of the highlighted file



Note

- Non-playable files are also listed but cannot be selected.
- Turn the TV off, and then on again when changing or reconnecting the network connection.
- You can use the following buttons during playback. Set the code of the remote control to "73" (p. 30).



For photo file

[Single view] - Photos are displayed one at a time.

Example:



Operation guide

- To display / hide the operation guide
 -
- To operate Single view
 - To the previous photo
 - Slideshow
 - To the next photo
 - Stop (return to list)
- To return to list
 -
 -
- To rotate 90°
 - (blue)

[Slideshow] - Slideshow completes when all photos are viewed within the list.

1 Select the photo file from the list for the first view **2 Start Slideshow**



- To display / hide the operation guide



(red) →



- To return to list



- To pause (return to Single view)

For video file

Playback - Playback will start.

- If you stopped the last playback on the way, the confirmation screen is displayed to select whether to start from where you stopped last time or from the beginning.

Example: Playback



Operation guide

Information banner

- To change aspect



- To display / hide the operation guide and information banner
 -

- To the previous content



- To the next content



- To return to list



- To operate the playback

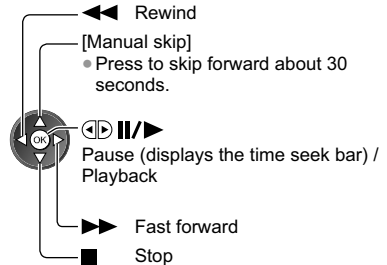

For music file

Playback - Playback will start.

Example: Playback

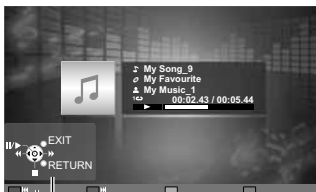

Operation guide

- To display / hide the operation guide



- To operate the playback

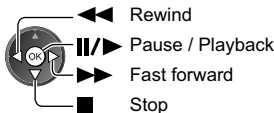

- To the previous track



- To the next track



- To return to list



For DIGA Recorder

Control the DIGA Recorder

The screen of the DIGA Recorder will be displayed. You can control the functions of the DIGA Recorder with this TV remote control according to the operation guide.

- Before operating, register this TV on the DIGA Recorder.
- For details, read the manual of the DIGA Recorder.

Example:

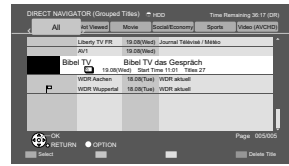

Option menu for each content

Setup the settings for Photo, Video and Music file operations.

1 Display the option menu



2 Select [Slideshow Settings], [Video Setup] or [Music Setup]

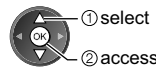
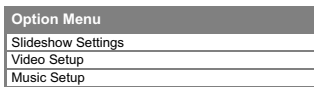

3 Select the items and set

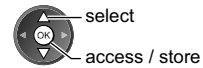

Menu	Item	Adjustments / Configurations (alternatives)
Slideshow Settings	Transition Effect	Selects the transition effect for switching the photo during the slideshow [Off] / [Fade] / [Slide] / [Dissolve] / [Motion] / [Random] [Fade]: The next photo fades in gradually. [Slide]: The next photo slides and appears from the left side. [Dissolve]: Each photo is dissolved when switching to the next photo. [Motion]: Each photo is displayed with an effect of enlarging, reducing, moving up or moving down. [Random]: Each transition is selected at random.
	Interval	Selects slideshow interval [5] / [10] / [15] / [30] / [60] / [90] / [120] (seconds) • This function is not available when [Transition Effect] is set to [Motion].
	Repeat	Slideshow repeat [Off] / [On]
	Back Ground Music	Selects the back ground music during Photo mode [Off] / [Type1] / [Type2] / [Type3] / [Type4] / [Type5]
Video Setup	Video Preview	Sets to start the preview of the title or scene in the thumbnail screen [Off] / [On] • Image may not be displayed for an instant in the thumbnail screen. Set the preview [Off] to resolve this.
	Multi Audio, Monaural Audio, Dual Mono Audio	Selects between selectable sound tracks (if available) • It may take several seconds to change the sound. • Only available during playback
	Subtitle	Subtitles On / Off (if available) • Only available during playback
	Subtitle Text	Selects the font type to display subtitles correctly. (if available) • Only available during playback
	Subtitle Language	Selects the language in which subtitles should appear (if available) • Only available during playback
Aspect Change	Aspect Change	[Aspect1]: Displays the content enlarged without distortion. [Aspect2]: Displays the content full-screen. [Original]: Displays the content original size. • You can also change the aspect using the ASPECT button. • Aspect change may not work depending on the content. • Only available during playback
	Repeat	Playback repeat within the selected file [Off] / [On]
Music Setup	Repeat	Playback repeat [Off] / [Folder] / [One] [Folder]: Playback repeat within the selected folder. [One]: Playback repeat of the selected one file.

Audio output settings (for video contents)

You can enjoy the multi-channel sound via an amplifier connected to DIGITAL AUDIO OUT or HDMI2 (ARC function) terminal.

- To confirm or change the current sound status ➔ (p. 63)

1 Display the menu and Select [Sound]

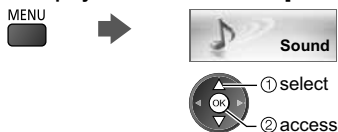

2 Select [SPDIF Selection] and set

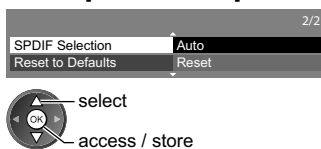

Menu	Item	Adjustments / Configurations (alternatives)
Sound	SPDIF Selection	<p>SPDIF: A standard audio transfer file format</p> <p>Selects the initial setting for digital audio output signal from DIGITAL AUDIO OUT and HDMI2 (ARC function) terminals [Auto] / [PCM]</p> <p>[Auto]: Dolby Digital Plus, Dolby Digital and HE-AAC multi-channel are output as Dolby Digital Bitstream. DTS is output as DTS. MPEG is output as PCM.</p> <p>[PCM]: Digital output signal is fixed to PCM.</p>

VIERA Connect

You can access VIERA Connect and enjoy various network contents.

- VIERA Connect requires a broadband internet connection. Dial-up internet connections cannot be used.
- Ensure the network connections and network settings are completed.
 - ➔ “Network connections” (p. 66), “Network Setup” (p. 67 - 70)
- For details about VIERA Connect operation ➔ (p. 18)

- Setup & Help menu (Items in [Setup & Help] may change without notice.)

Customize HomeScreen	Changes the position of each services on VIERA Connect home screen
My Account	Confirms or removes the account information of the TV you entered on VIERA Connect
Lock	Sets to restrict access to some services
Restrictions	Sets to restrict reveal of the restricted services
Beep	Sets beep sound On or Off when operating VIERA Connect
Notices	Displays the information of VIERA Connect
Help	Explains the setup items and operations in VIERA Connect

Note

- Be sure to update the software when a software update notice is displayed on the TV screen. If the software is not updated, you will not be able to use VIERA Connect.
 - You can update the software later manually. ➔ **[Software Update]** in **[Network]** (p. 70)
- VIERA Connect home screen is subject to change without notice.
- The services through VIERA Connect are operated by their respective service providers, and service may be discontinued either temporarily or permanently without notice. Therefore, Panasonic will make no warranty for the content or the continuity of the services.
- Some content may be inappropriate for some viewers.
- Some content may only be available for specific countries and may be presented in specific languages.
- Depending on the connection environment, the internet connection may be slow or may not be successful.
- During the operation, audio signal is output from AV1, DIGITAL AUDIO OUT and HDMI2 (ARC function) terminals. But no video signals are output. AV1 can output audio signal if [AV1 out] is set to [Monitor] in the Setup Menu (p. 37). To use HDMI2 with ARC function, connect an amplifier that has ARC function (p. 75) and set to use theatre speakers (p. 81).
- You can restrict access to VIERA Connect. ➔ **[Child Lock]** (p. 50)
- Turn the TV off, and then on again when changing or reconnecting the network connection.

Link Functions (Q-Link / VIERA Link)

Q-Link connects the TV and DVD Recorder / VCR, and enables easy recording, playback, etc. ➔ (p. 76)

VIERA Link (HDAVI Control™) connects the TV and the equipment with VIERA Link function, and enables easy control, convenient recording, playback, energy saving, creating home theatre, etc., without complicated setting. ➔ (p. 77 - 81)

You can use Q-Link and VIERA Link functions together.

- This TV supports "HDAVI Control 5" function. But available features are depending on the connected equipment's version of HDAVI Control. Please read the manual of the equipment to confirm the version.
- VIERA Link features may be available even with other manufacturers' equipment supporting HDMI CEC.

Summary of Q-Link and VIERA Link features

Q-Link (SCART connection)

Connected equipment	DVD Recorder / VCR with Q-Link function
Features	
Analogue channel download	○
Easy playback	○
Power on link	○
Power off link	○
Direct TV Recording	○

Connection

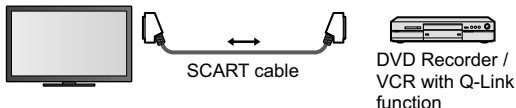

- Use fully wired SCART cable.
- Connect the DVD Recorder / VCR supporting Q-Link to the TV's AV1 terminal via a SCART cable.

VIERA Link (HDMI connection)

Connected equipment	DIGA Recorder with VIERA Link function	DVD Player / Blu-ray Disc Player with VIERA Link function	HD Video Camera / LUMIX Camera with VIERA Link function
Features			
Analogue channel download	—	—	—
Easy playback	○	○	○
Power on link	○	○	○
Power off link	○	○	○
Reduce unnecessary power consumption in Standby	○*3	○*3	—
Auto standby for unnecessary equipment	○*3	○*3	—
Pause Live TV programme	○*3 *4	—	—
Direct TV Recording	○*3	—	—
Control the menu of the connected equipment by VIERA remote control	○*1	○*1	○*1
Speaker control	—	—	—

Connection

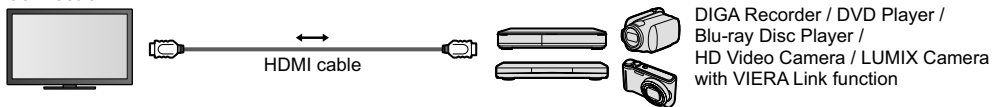

- Use fully wired HDMI compliant cable.
- Connect the equipment supporting VIERA Link to the TV's HDMI1, HDMI2, HDMI3 or HDMI4 terminal via an HDMI cable.
- About HDMI cable for connecting Panasonic HD Video Camera or LUMIX Camera, read the manual of the equipment.

VIERA Link (HDMI and SCART connections)

Connected equipment	DIGA Recorder with VIERA Link function
Features	
Analogue channel download	○
Easy playback	○
Power on link	○
Power off link	○
Reduce unnecessary power consumption in standby	○*3
Auto standby for unnecessary equipment	○*3
Pause Live TV programme	○*2 *4
Direct TV Recording	○*2
Control the menu of the connected equipment by VIERA remote control	○*1
Speaker control	—

Connection

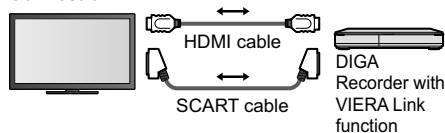

- Use a fully wired HDMI compliant cable.
- Connect the equipment supporting VIERA Link to the TV's HDMI1, HDMI2, HDMI3 or HDMI4 terminal via an HDMI cable.
- Use a fully wired SCART cable.
- Connect the equipment supporting VIERA Link to the TV's AV1 terminal via a SCART cable.

VIERA Link (HDMI and Audio out connections)

Connected equipment	Player theatre with VIERA Link function	Blu-ray Disc theatre with VIERA Link function	Amplifier with VIERA Link function
Features			
Analogue channel download	—	—	—
Easy playback	○*5	○*5	—
Power on link	○	○	—
Power off link	○	○	○
Reduce unnecessary power consumption in Standby	—	○*3	—
Auto standby for unnecessary equipment	○*3 *6	○*3 *6	○*3
Pause Live TV programme	—	—	—
Direct TV Recording	—	—	—
Control the menu of the connected equipment by VIERA remote control	○*1	○*1	—
Speaker control	○	○	○

Connection

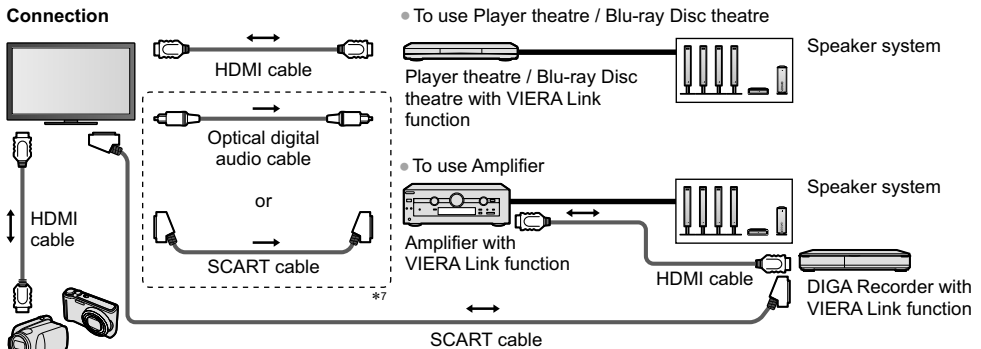

HD Video Camera / LUMIX Camera with VIERA Link function

- Use fully wired HDMI compliant cable.
- Connect the equipment supporting VIERA Link to the TV's HDMI2, HDMI3 or HDMI4 terminal via an HDMI cable.
- Use fully wired SCART cable.
- If you use a SCART cable for audio output, connect the equipment supporting VIERA Link to the TV's AV1 terminal and set [AV1 out] to [Monitor] in the Setup Menu (p. 37).
- Use the optical digital audio cable or SCART cable for audio output from the TV.

*1: Available with the equipment which has "HDAVI Control 2 or later" function.

*2: Available with the equipment which has "HDAVI Control 3 or later" function.

*3: Available with the equipment which has "HDAVI Control 4 or later" function.

*4: Available with a DIGA Recorder which has HDD.

*5: While playing a disc.

*6: Except for watching a disc.

*7: If the connected equipment has "HDAVI Control 5" function, you do not have to use this audio cable (Optical digital audio cable or SCART cable). In this case, connect the equipment to the TV's HDMI2 terminal via an HDMI cable.

VIERA Link Control of compatible equipment ➔ [VIERA Link Control] (p. 79)

● Table below displays maximum number of compatible equipment that can be controlled by VIERA Link Control. This includes connections to equipment already connected to the TV.

For example, DIGA Recorder connected to Amplifier which is connected to the TV via an HDMI cable.

Type of the equipment	Maximum number
Recorder (DIGA Recorder, etc.)	3
Player (DVD Player, Blu-ray Disc Player, HD Video Camera, LUMIX Camera, Digital Camera, Player theatre, Blu-ray Disc theatre, etc.)	3
Audio system (Player theatre, Blu-ray Disc theatre, Amplifier, etc.)	1
Tuner (Set top box, etc.)	4

Q-Link

Preparations

- Connect the DVD Recorder / VCR with the following logos: "Q-Link", "NEXTVIEWLINK", "DATA LOGIC (a trademark of Metz Corporation)", "Easy Link (a trademark of Philips Corporation)", "Megalogic (a trademark of Grundig Corporation)", "SMARTLINK (a trademark of Sony Corporation)"
- Q-Link connection ➔ (p. 74)
- Use fully wired SCART cable.
- Set up the DVD Recorder / VCR. Read the manual of the recorder.
- Q-Link terminal setup in the Setup Menu ➔ [AV1 out] (p. 37)
- Download Analogue channel setting ➔ "Analogue channel download" (see below)

Features available

Analogue channel download

Analogue channel settings can be downloaded to a recorder with an analogue tuner (where Analogue is still broadcast). Digital channel settings are not downloaded.

- To download the Analogue channel settings
➔ [Q-Link Download] (p. 37), [Auto Setup] (p. 14, 44)

Direct TV Recording - What you see is What you record

Recording the current programme on a DVD Recorder / VCR immediately.

- Set the code of the remote control to "73" (p. 30).

REC ● Available conditions:



Picture source	Mode	Recording from
Analogue	TV	TV monitor out
	AV	Recorder's tuner
DVB	TV	TV monitor out
AV (watching recorder's tuner)	AV	Recorder's tuner
AV (watching recorder's external input)	AV	Recorder's external input
AV (watching TV's external input)	AV	TV monitor out

- When Direct TV Recording is performed, the recorder is automatically turned on if it is in Standby mode.
- You can change channel or turn the TV off while the recorder is recording from its own tuner.
- Changing channel is not available while the recorder is recording from the TV tuner.

■ To stop recording



Unlock the tuner

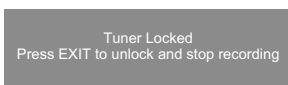

Power on link and Easy playback

When DVD Recorder / VCR starts playback or direct navigator / function menu for the equipment are activated, the TV is turned on and input mode is switched automatically so that you can view the content. (Only when the TV is in Standby mode.)

Power off link

When TV is set to Standby mode, the recorder is also automatically set to Standby. (Only when the videocassette or disc is not active.)

- This function works even if the TV enters Standby mode automatically by auto power standby function.

Note

- Some recorders are not applicable. Read the manual of the recorder.

VIERA Link "HDAVI Control"™**

***Enjoy additional HDMI Inter-Operability with Panasonic products which have "HDAVI Control" function.**

This TV supports "HDAVI Control 5" function.

Connections to the equipment (DIGA Recorder, HD Video Camera, Player theatre, Amplifier, etc.) with HDMI and SCART cables allow you to interface them automatically (p. 74, 75).

These features are limited to models incorporating "HDAVI Control" and "VIERA Link".

- Some functions are not available depending on the equipment's version of HDAVI Control. Confirm the connected equipment's version of HDAVI Control.
- VIERA Link "HDAVI Control", based on the control functions provided by HDMI which is an industry standard known as HDMI CEC (Consumer Electronics Control), is a unique function that we have developed and added. As such, its operation with other manufacturers' equipment that supports HDMI CEC cannot be guaranteed.
- Please refer to individual manuals for other manufacturers' equipment supporting VIERA Link function.
- For information about applicable Panasonic equipment, consult your local Panasonic dealer or refer to www.panasonic.co.uk

Preparations

- Connect the equipment supporting VIERA Link.
- VIERA Link connection ➔ (p. 74, 75)
- Use fully wired HDMI compliant cable. Non-HDMI-compliant cables cannot be utilised.
Recommended Panasonic's HDMI cable part number:
 - RP-CDHS15 (1.5 m)
 - RP-CDHS30 (3.0 m)
 - RP-CDHS50 (5.0 m)
- Use fully wired SCART cable.
- Set up the connected equipment. Read the manual of the equipment.
- For optimal recording, the settings of the recorder may need to be changed. For details, read the manual of the recorder.
- Download Analogue channel setting ➔ **"Analogue channel download"** (see below)
- Set [VIERA Link] to [On] in the Setup Menu. ➔ [VIERA Link] (p. 37)
- Set up the TV.

After connection, turn the equipment on and then switch the TV on.

Select the input mode from HDMI1, HDMI2, HDMI3 or HDMI4 (p. 29), and make sure that an image is displayed correctly.

This setup should be done each time when the following conditions occur:

- for the first time
- when adding or reconnecting equipment
- when changing setup

Features available

Analogue channel download

Analogue channel settings can be downloaded to a recorder with an analogue tuner (where Analogue is still broadcast). Digital channel settings are not downloaded.

- To download the Analogue channel settings
➔ [Q-Link Download] (p. 37), [Auto Setup] (p. 14, 44)

Easy playback

Automatic input switching - When the connected equipment is operated (during playback or menu operations, etc.), the input mode is switched automatically. When playback is stopped or menus are exited, the input mode returns to the original setting.

Power on link

When DVD Recorder / VCR starts playback or direct navigator / function menu for the equipment are activated, the TV is turned on and input mode is switched automatically so that you can view the content. (Only when the TV is in Standby mode.)

Power off link

When the TV is set to Standby mode, the connected equipment is also automatically set to Standby.

- This function will work even if the TV enters Standby mode automatically by auto power standby function.

Reduce unnecessary power consumption in Standby [Standby Power Save]

Set Standby Power Save [On] in the Setup Menu to use this function ➔ [Standby Power Save] (p. 37)

The power consumption in Standby mode of the connected equipment is controlled higher or lower in synchronisation with the TV on / off state to reduce the consumption.

When the TV is set to Standby mode, the connected equipment is automatically set to Standby and the power consumption of the connected equipment is automatically minimised.

When the TV is turned on, the connected equipment is still in Standby mode, but the power consumption is increased to make startup time fast.

- This function is effective if the connected equipment can change the power consumption in Standby mode and is set to higher consumption.

Auto standby for unnecessary equipment [Intelligent Auto Standby]

Set Intelligent Auto Standby [On (With reminder)] or [On (No reminder)] in the Setup Menu to use this function ➔ [Intelligent Auto Standby] (p. 37)

When the TV is on, non-watched or non-used connected equipment goes into Standby mode automatically to reduce the power consumption. For example, when the input mode is switched from HDMI, the connected equipment will go into Standby mode / or when Speaker Selection is changed to [TV] (except for watching a disc).

- If you select [On (With reminder)], the on-screen message will be displayed before the connected equipment turns to standby.
- This function may not work properly depending on the connected equipment. If required, set to [Off].

Direct TV Recording - What you see is What you record [Direct TV Rec]

Records the current programme in the DIGA Recorder immediately.

- If you connect a variety of recorders including other manufacturers' recorders at the same time, connect the DIGA Recorder to the TV's lower HDMI terminal number. For example, if you use HDMI1 and HDMI2 for two recorders, connect the DIGA Recorder to HDMI1.
- If you cannot operate, check the settings and the equipment.
 - ➔ "Summary of Q-Link and VIERA Link features" (p. 74, 75), "Preparations" (p. 77)
- To record the programme which DIGA Recorder does not support, SCART connection is required and the programme is recorded by Q-Link function (p. 76).
- Depending on the programme, SCART connection may be required to record.
- You can change channel or turn the TV off while the recorder is recording from its own tuner.
- You can not change channel while the recorder is recording from the TV tuner.

1 Display [VIERA TOOLS] and select [VIERA Link]



2 Select [Direct TV Rec] and start recording

VIERA Link Menu	
Pause Live TV	Start
Direct TV Rec	Start
VIERA Link Control	Recorder
Speaker Selection	Home Cinema

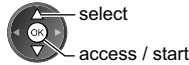

- You can also start recording directly when the code of the remote control is "73" (p. 30).



■ To stop recording

Select [Stop] in [Direct TV Rec]

VIERA Link Menu	
Pause Live TV	Start
Direct TV Rec	Stop
VIERA Link Control	Recorder
Speaker Selection	Home Cinema

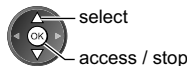

- You can also stop recording directly.



Unlock the tuner

Tuner Locked
Press EXIT to unlock and stop recording



Pause Live TV programme [Pause Live TV]

You can pause the current TV programme and resume later.

The current TV programme will be recorded on HDD of the connected DIGA Recorder.

- This function is available with a DIGA Recorder which has HDD.
- If you connect a variety of recorders including other manufacturers' recorders at the same time, connect the DIGA Recorder which has HDD to the TV's lower HDMI terminal number. For example, if you use HDMI1 and HDMI2 for two recorders, connect the DIGA Recorder which has HDD to HDMI1.
- If you cannot operate, check the settings and the equipment.
 - ➔ "Summary of Q-Link and VIERA Link features" (p. 74, 75), "Preparations" (p. 77)

1 Display [VIERA TOOLS] and select [VIERA Link]



2 Select [Pause Live TV] and pause

The TV picture will be paused.

VIERA Link Menu	
Pause Live TV	Start
Direct TV Rec	Start
VIERA Link Control	Recorder
Speaker Selection	Home Cinema

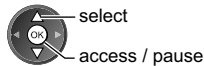

- The current TV programme is recorded on HDD from where it was paused.
- If the paused TV picture disappears after a few minutes, press OPTION button to restore the pause picture.
- Follow the operation guide to operate [Pause Live TV] function.

■ To operate [Pause Live TV]

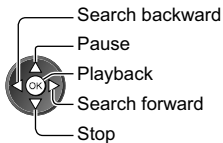

- Operations may vary depending on the recorder. In this case, follow the operation guide or read the manual of the recorder.

- If you stop playback, the recorded programme will be deleted from HDD.

■ To return to current TV (Stop playback of [Pause Live TV] / cancel pause)

Select [Yes]

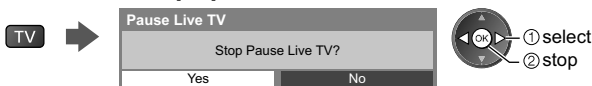

- If you stop playback or cancel pause, the recorded programme will be deleted from HDD.

Control the menu of the connected equipment by VIERA remote control [VIERA Link Control]

You can control some functions of the connected equipment with this TV remote control pointing at the TV's signal receiver.

- If you cannot operate, check the settings and the equipment.
 - ➔ "Summary of Q-Link and VIERA Link features" (p. 74, 75), "Preparations" (p. 77)
- For details of the operations for the connected equipment, read the manual of the equipment.

1 Display [VIERA TOOLS] and select [VIERA Link]



2 Select [VIERA Link Control]

VIERA Link Menu	
Pause Live TV	Start
Direct TV Rec	Start
VIERA Link Control	Recorder
Speaker Selection	Home Cinema

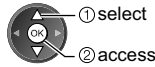

3 Select the equipment to access

Select the type of the connected equipment and access.

VIERA Link Menu	
Pause Live TV	Start
Direct TV Rec	Start
VIERA Link Control	Recorder
Speaker Selection	Home Cinema

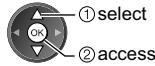

[Recorder] / [Player] / [Home Cinema] / [Video Camera] / [LUMIX] / [Digital Camera] / [Other]

- You can also access directly by using VIERA TOOLS. ➔ (p. 31)
- The displayed item may vary depending on the connected equipment.
- [Home Cinema] means Player theatre, Blu-ray Disc theatre or Recorder theatre.
- [Other] means Tuner set top box.

The menu of the accessed equipment will be displayed.
(Input mode will be changed automatically)

4 Operate the menu of the equipment

- Set the code of the remote control to "73" (p. 30).

Follow the operation guide

- To display the operation guide

OPTION



If other manufacturers' equipment is accessed, Setup / Contents Selection menu may be displayed.

- Available VIERA remote control buttons depend on the connected equipment.

Note

- Some operations may not be available depending on the equipment. In this case use its own remote control to operate the equipment.

■ If multiple recorders or players are connected

VIERA Link Menu	
Pause Live TV	Start
Direct TV Rec	Start
VIERA Link Control	Recorder2
Speaker Selection	Home Cinema

[Recorder1-3 / Player1-3]

The number is given from the TV's lower number of HDMI terminal connected to the same type equipment. For example, two recorders to HDMI2 and HDMI3, the recorder connected to HDMI2 is displayed as [Recorder1], and the recorder connected to HDMI3 is displayed as [Recorder2].

■ If you access non-VIERA Link equipment

VIERA Link Menu	
Pause Live TV	Start
Direct TV Rec	Start
VIERA Link Control	Recorder
Speaker Selection	Home Cinema

The type of the connected equipment is displayed. Although you can access the connected equipment, you cannot operate it. Use its own remote control to operate the equipment.

Speaker control [Speaker Selection]

You can control the theatre speaker with this TV remote control pointing at the TV's signal receiver.

- If you cannot operate, check the settings and the equipment.

➔ “Summary of Q-Link and VIERA Link features” (p. 74, 75), “Preparations” (p. 77)

1 Display [VIERA TOOLS] and select [VIERA Link]



2 Select [Speaker Selection]

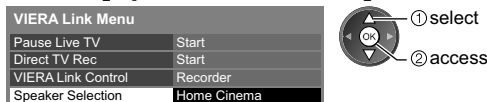

3 Set to [Home Cinema] or [TV]

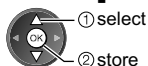

[Home Cinema]:

The sound is from theatre speakers. Player theatre, Blu-ray Disc theatre or Amplifier will be automatically turned on if it is in Standby mode.

- Volume up / down



- Mute



- The sound of TV speakers is mute.
- When the equipment is turned off, TV speakers will be active.

[TV]:

TV speakers are active.

Multi-channel sound

If you want to enjoy the multi-channel sound (e.g. Dolby Digital 5.1ch) via an Amplifier, connect it with HDMI cable and Optical digital audio cable (p. 75), and then select [Home Cinema]. If your Amplifier has “HDAVI Control 5” function, you only need to connect it with HDMI cable to the TV's HDMI2 terminal.

To enjoy the sound from the DIGA Recorder in multi-channel sound, connect an HDMI cable from the DIGA Recorder to the Amplifier (p. 75).

Note

- These functions may not work properly depending on the connected equipment.
- Image or sound may not be available for the first few seconds when input mode is switched.
- “HDAVI Control 5” is the newest standard (as of November, 2011) for HDAVI Control compatible equipment. This standard is compatible with conventional HDAVI equipment.
- To confirm this TV's version of HDAVI Control ➔ [System Information] (p. 39)

External Equipment

These diagrams show our recommendations for connection of your TV to various pieces of equipment. For other connections, consult the instructions for each piece of equipment, the basic connection (p. 11 - 13), the table (p. 84), and the specifications (p. 102, 103).

To watch DVDs

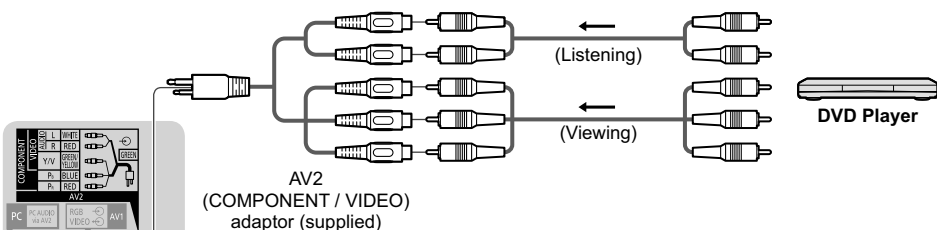

USB devices

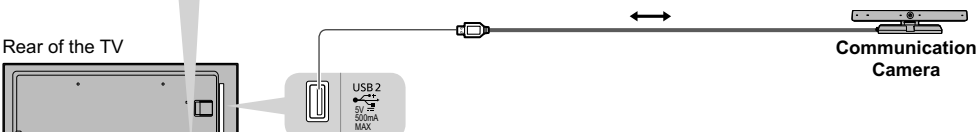

HDMI equipment

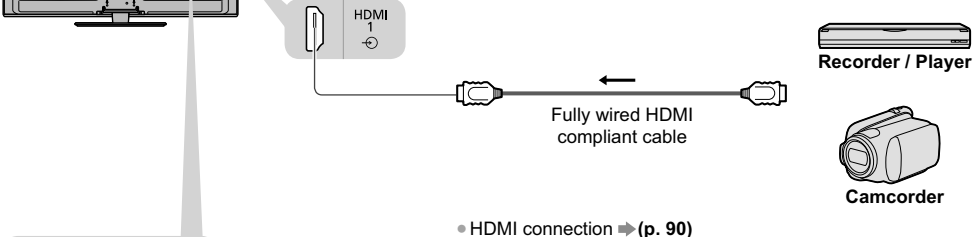

PC

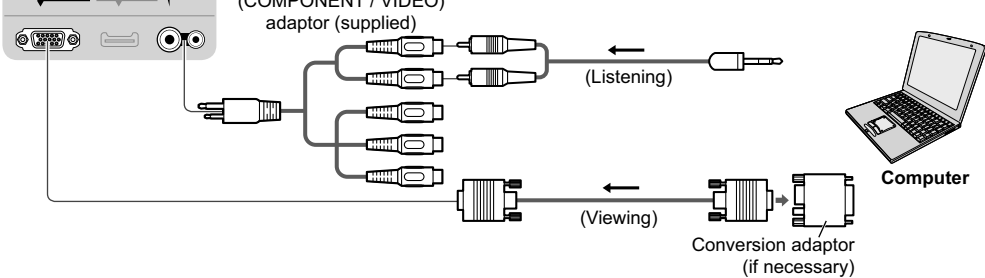

External Equipment

Network (wired)

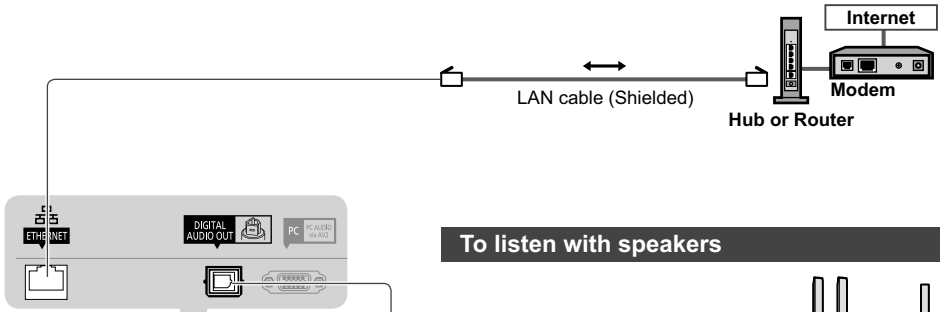

To listen with speakers

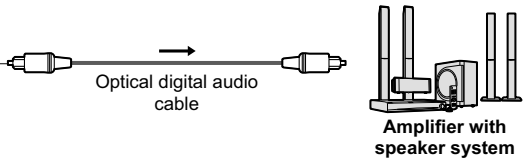

To enjoy the sound from the external equipment in multi-channel sound (e.g. Dolby Digital 5.1ch), connect the equipment to the amplifier. For the connections, read the manuals of the equipment and amplifier.

Rear of the TV

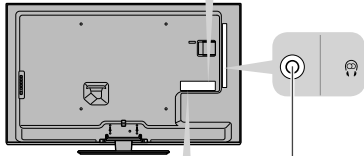

Headphones

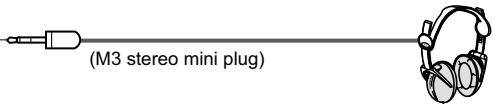





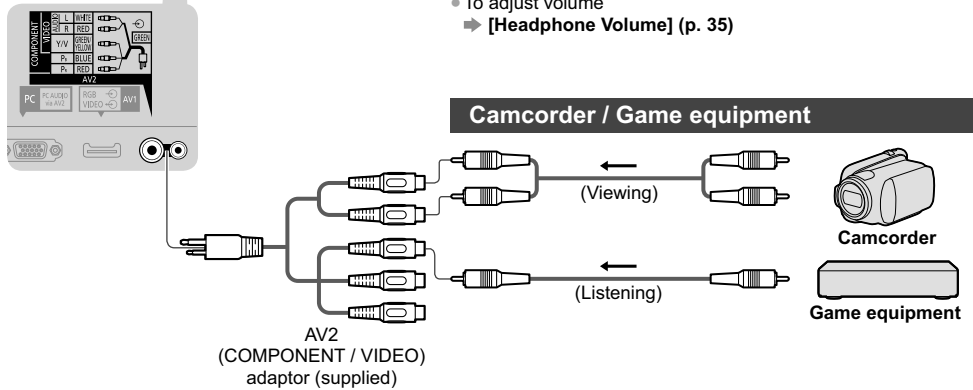

- To adjust volume
➔ **[Headphone Volume]** (p. 35)

Camcorder / Game equipment



Types of connectable equipment to each terminal

Features	Terminal						
	AV1*1 	AV2*1		DIGITAL AUDIO OUT 	ETHERNET 	HDMI 1 - 4 	USB 1 - 2 
		COMPONENT 	VIDEO 				
To record / playback videocassettes / DVDs (VCR / DVD Recorder)	<input type="radio"/>						
To watch satellite broadcasts (Set top box)	<input type="radio"/>		<input type="radio"/>			<input type="radio"/> *2	
To watch DVDs (DVD Player)	<input type="radio"/>	<input type="radio"/>	<input type="radio"/>			<input type="radio"/>	
To watch camcorder images (Video camera)	<input type="radio"/>		<input type="radio"/>			<input type="radio"/>	
To play games (Game equipment)	<input type="radio"/>		<input type="radio"/>			<input type="radio"/>	
To use amplifier with speaker system				<input type="radio"/>		<input type="radio"/> *3	
To use network services					<input type="radio"/>		<input type="radio"/> *4
Q-Link	<input type="radio"/>						
VIERA Link	<input type="radio"/> (with HDMI)					<input type="radio"/>	
Direct TV Recording	<input type="radio"/>					<input type="radio"/>	

○ : Recommended Connection

*1: To connect the equipment, the terminal adaptor (supplied) is necessary.

*2: Use HDMI1 for automatic input switching.

*3: Use HDMI2 for connecting an amplifier. This connection is applicable when using an amplifier that has ARC (Audio Return Channel) function.

*4: Use USB 2 port for connecting the Communication Camera.

Technical Information

Auto Aspect

The optimum size and aspect can be chosen automatically, and you can enjoy finer images. ➔ (p. 22)

■ Aspect Control Signal

[WIDE] will appear in the top left of the screen if a Widescreen signal (WSS) or a Control signal through SCART / HDMI terminal is found.

The aspect will switch to the appropriate 16:9 or 14:9 widescreen ratio.

This function will work in any aspect mode.

Input terminal	Input signal format	Aspect Control Signal	
		Widescreen signal (WSS)	Control signal through SCART (pin8) / HDMI terminal
RF	DVB	○	
	PAL I	○	
	M.NTSC 6.0 MHz	-	
AV1 / AV2 (Composite)	PAL	○	○
	PAL 525/60	-	○
	M.NTSC	-	○
	NTSC	-	○
AV2 (Component)	525 (480) / 60i, 60p	-	
	625 (576) / 50i, 50p	○	
	750 (720) / 60p, 50p	-	
	1,125 (1,080) / 60i, 50i	-	
HDMI1 HDMI2 HDMI3 HDMI4	525 (480) / 60i, 60p	-	○
	625 (576) / 50i, 50p	-	○
	750 (720) / 60p, 50p	-	○
	1,125 (1,080) / 60i, 50i	-	○
	1,125 (1,080) / 60p, 50p, 24p	-	○

■ Auto mode

Auto mode determines the best aspect ratio to fill the screen using a four step process (WSS, Control signal through SCART / HDMI terminal, Letterbox detection or Justify to fill the screen).

This process may take several minutes, depending on the darkness of the image.

Letterbox detection:

If black bands at the top and bottom of the screen are detected, Auto mode chooses the best ratio and expands the image to fill the screen.

If no aspect signals are detected, Auto mode enhances the image for optimum viewing pleasure.

Note

- The ratio varies depending on the programme, etc. If the ratio is out of the standard 16:9, black bands at the top and bottom of the screen may appear.
- If the screen size looks unusual when a widescreen-recorded programme is played back on a VCR, adjust the tracking of the VCR. Read the manual of the VCR.

Supported file format in Media Player and media servers

■ Photo

Format	File extension	Image resolution (pixel)	Details / Restrictions
JPEG	.jpg .jpeg	8 × 8 to 30,719 × 17,279	DCF and EXIF standards Sub-sampling: 4:4:4, 4:2:2, 4:2:0 • Progressive JPEG is not supported.

■ Video

Container	File extension	Video codec	Audio codec	Details / Restrictions
AVCHD	.mts	H.264	Dolby Digital	AVCHD Standard Ver. 2.0 (AVCHD Progressive) • The data may not be available if a folder structure on the device is modified.
SD-Video	.mod	MPEG1 MPEG2	Dolby Digital MPEG Audio	SD-Video Standard Ver. 1.31 (Entertainment Video Profile) • The data may not be available if a folder structure on the device is modified.
MOV	.mov .qt	DivX3 DivX4 DivX5 DivX6 H.264 BP/MP/HP Motion JPEG MPEG1 MPEG2 MPEG4 SP/ASP	AAC Dolby Digital Dolby Digital Plus DTS core HE-AAC LPCM MPEG Audio MP3	• This TV supports Motion JPEG recorded by Panasonic LUMIX Camera*1. • This TV is not available for playing back Motion JPEG with the media server. *1: Some products of before the year 2004 may not be available. The compatibility with future products is not guaranteed.
AVI	.avi .divx	DivX3 DivX4 DivX5 DivX6 H.264 BP/MP/HP MPEG1 MPEG2 MPEG4 SP/ASP VC-1 Windows Media Video Ver. 9	AAC ADPCM Dolby Digital Dolby Digital Plus DTS core HE-AAC LPCM MPEG Audio MP3 WMA WMA Pro	• Certified to play DivX Plus HD video file in Media Player For details of DivX ➔ (p. 88) • Some subtitles or chapter functions may not be available.
MKV	.mkv	DivX3 DivX4 DivX5 DivX6 H.264 BP/MP/HP MPEG1 MPEG2 MPEG4 SP/ASP	AAC Dolby Digital Dolby Digital Plus DTS core HE-AAC MPEG Audio MP3	

Container	File extension	Video codec	Audio codec	Details / Restrictions
ASF	.asf .wmv	DivX3 DivX4 DivX5 DivX6 MPEG4 SP/ASP VC-1 Windows Media Video Ver. 9	AAC Dolby Digital Dolby Digital Plus HE-AAC LPCM MP3 WMA WMA Pro	<ul style="list-style-type: none"> • Copy-protected files cannot be played back.
MP4	.f4v .m4v .mp4	DivX3 DivX4 DivX5 DivX6 H.264 BP/MP/HP MPEG1 MPEG2 MPEG4 SP/ASP	AAC Dolby Digital Dolby Digital Plus HE-AAC MPEG Audio MP3	<ul style="list-style-type: none"> • This TV supports this container recorded by Panasonic products. For details, read the manual of the products.
FLV	.flv	H.264	AAC MP3	–
3GPP	.3gp .3g2	H.264 MPEG4 SP/ASP	AAC HE-AAC	–
PS	.mpg .mpeg .vob .vro	H.264*2 MPEG1 MPEG2 VC-1*2	AAC*2 Dolby Digital Dolby Digital Plus*2 HE-AAC*2 LPCM MPEG Audio MP3*2	<ul style="list-style-type: none"> *2: This codec can be played back only in Media Player.
TS	.m2ts .tp .trp .ts	H.264 MPEG1 MPEG2 VC-1*3	AAC Dolby Digital Dolby Digital Plus DTS core*3 HE-AAC MPEG Audio MP3*3	<ul style="list-style-type: none"> *3: This codec can be played back only in Media Player.

■ Music

Codec	File extension	Restrictions
MP3	.mp3	–
AAC	.m4a	<ul style="list-style-type: none"> • Copy-protected files cannot be played back.
WMA WMA Pro	.wma	<ul style="list-style-type: none"> • Copy-protected files cannot be played back. • WMA Lossless is not supported.
FLAC	.flac	–

Note

- Some files may not be played back even if they fulfil these conditions.
- Do not use two-byte characters or other special codes for data.
- The device may become unusable with this TV if the file or folder names are changed.

DivX Certified® to play DivX® and DivX Plus® HD (H.264/MKV) video up to 1080p HD including premium content.

ABOUT DIVX VIDEO:

DivX® is a digital video format created by DivX, LLC, a subsidiary of Rovi Corporation. This is an official DivX Certified® device that plays DivX video. Visit divx.com for more information and software tools to convert your files into DivX videos.

■ Subtitle text file of DivX

Subtitles format - MicroDVD, SubRip, TPlayer

- The DivX video file and subtitles text file are inside the same folder, and the file names are the same except for the file extensions.
- If there are more than one subtitles text files inside the same folder, they are displayed in the following order of priority:
“.srt”, “.sub”, “.txt”.
- To confirm or change the current subtitle status while playing DivX content, press the OPTION button to display Option Menu.
- Depending on the methods used to create the file or the state of recording, only parts of the subtitles may be displayed, or the subtitles may not be displayed at all.

Note

- Depending on how you make SD Card, USB Flash Memory or the media server, files and folders may not be displayed in the order you numbered.
- Depending on how you create the files and the structure of folders, the files and folders may not be displayed.
- When there are many files and folders, operation may take time to complete or some files may not be displayed or playable.

ABOUT DIVX VIDEO-ON-DEMAND:

This DivX Certified® device must be registered in order to play purchased DivX Video-on-Demand (VOD) movies. To obtain your registration code, locate the DivX VOD section in the Setup Menu. Go to vod.divx.com for more information on how to complete your registration.

■ To show DivX VOD registration code

➔ [DivX® VOD] (p. 39)

- If you want to generate the new registration code, you have to deregister the current registration code. After playing DivX VOD content once, the confirmation screen to deregister will be displayed in [DivX® VOD] in the Setup Menu. If you press the OK button on the confirmation screen, the deregistration code will be generated and you will not be able to play any contents that you purchased using the current registration code. You will obtain the new registration code by pressing the OK button on the deregistration code screen.
- If you purchase DivX VOD content using a registration code different from this TV's code, you will not be able to play this content. ([Your device is not authorized to play this DivX protected video.] is displayed.)

■ Regarding DivX content that can only be played a set number of times

Some DivX VOD content can only be played a set number of times.

When you play this content, the remaining number of plays is displayed. You cannot play this content when the number of remaining plays is zero. ([This DivX rental has expired.] is displayed.)

- When playing this content, the number of remaining plays is reduced by one in the following conditions:
 - If you exit the current application.
 - If you play the other content.
 - If you go to the next or previous content.

Devices for recording or playing back

■ SD Card

Card format:

- SDXC Card - exFAT
- SDHC Card / SD Card - FAT16 or FAT32

Compliant card type (maximum capacity):

- SDXC Card (64 GB), SDHC Card (32 GB), SD Card (2 GB), miniSD Card (2 GB) (requiring miniSD adaptor)

- If miniSD Card is used, insert / remove it together with the adaptor.
- Check the latest information on the card type at the following website.
<http://panasonic.jp/support/global/cs/tv/>
- Use an SD Card which meets SD standards. If not, it may cause the TV to malfunction.

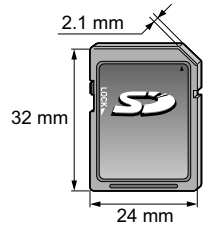

■ USB Flash Memory (for playing back in Media Player)

USB Flash Memory format: FAT16, FAT32 or exFAT

- A USB HDD formatted by PC is not supported in Media Player.

Note

- Data modified with a PC may not be displayed.
- Do not remove the device while the TV is accessing data. Otherwise this can damage device or TV.
- Do not touch the pins on the device.
- Do not subject the device to a high pressure or impact.
- Insert the device in the correct direction. Otherwise this can damage device or TV.
- Electrical interference, static electricity, or erroneous operation may damage the data or device.
- Back up the recorded data at regular intervals in case of deteriorated or damaged data or erratic operation of the TV. Panasonic is not liable for any deterioration or damage of recorded data.

PC connection

A PC may be connected to this TV so that the PC screen is displayed and sound is heard from the TV.

- PC signals that can be input: Horizontal scanning frequency 31 to 69 kHz; vertical scanning frequency 59 to 86 Hz (more than 1,024 signal lines could result in incorrect display of the image).
- A PC adaptor is not necessary for the DOS/V-compliant D-sub 15-pin connector.

Note

- Some PC models cannot be connected to this TV.
- When using PC, set the colour display quality of PC to the highest position.
- For details of the applicable PC signals
➔ **“Input signal that can be displayed” (p. 91)**
- D-sub 15-pin connector signal

- Max. display resolution

4:3	1,440 × 1,080 pixels
16:9	1,920 × 1,080 pixels

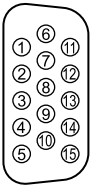

Pin No.	Signal Name	Pin No.	Signal Name	Pin No.	Signal Name
①	R	⑥	GND (Ground)	⑪	NC (not connected)
②	G	⑦	GND (Ground)	⑫	NC (not connected)
③	B	⑧	GND (Ground)	⑬	HD
④	NC (not connected)	⑨	NC (not connected)	⑭	VD
⑤	GND (Ground)	⑩	GND (Ground)	⑮	NC (not connected)

HDMI connection

HDMI (high-definition multimedia interface) is the world's first complete digital consumer AV interface complying with a non-compression standard.

HDMI allows you to enjoy high-definition digital images and high-quality sound by connecting the TV and the equipment.

HDMI-compatible equipment*1 with an HDMI or DVI output terminal, such as a DVD player, a set top box or game equipment, can be connected to the HDMI terminal using an HDMI compliant (fully wired) cable.

For more information about connections ➔ (p. 12, 82)

■ Applicable HDMI features

- Input audio signal:
2ch Linear PCM (sampling frequencies - 48 kHz, 44.1 kHz, 32 kHz)
- Input video signal:
➔ **"Input signal that can be displayed"** (p. 91)
Match the output setting of the digital equipment.
- Input PC signal:
➔ **"Input signal that can be displayed"** (p. 91)
Match the output setting of the PC.
- VIERA Link (HDAVI Control 5)
➔ **[VIERA Link]** (p. 77)
- Content Type
- Audio Return Channel*2
(HDMI2 terminal only)

■ DVI connection

If the external equipment has only a DVI output, connect to the HDMI terminal via a DVI to HDMI adaptor cable*3.

When the DVI to HDMI adaptor cable is used, connect the audio cable to AUDIO terminal with the supplied AV2 (COMPONENT / VIDEO) adaptor.

Note

- Audio settings can be made on [HDMI1 / 2 / 3 / 4 Input] in the Sound Menu. (p. 35)
- If the connected equipment has an aspect adjustment function, set the aspect ratio to "16:9".
- These HDMI connectors are "type A".
- These HDMI connectors are compatible with HDCP (High-Bandwidth Digital Content Protection) copyright protection.
- Equipment having no digital output terminal may be connected to the input terminal of component or video to receive analogue signals.
- This TV incorporates HDMI™ technology.

*1: The HDMI logo is displayed on HDMI-compliant equipment.

*2: Audio Return Channel (ARC) is a function to send digital sound signals via an HDMI cable.

*3: Enquire at your local digital equipment retailer shop.

USB connection

- It is recommended to connect the USB Flash Memory or Communication Camera to the TV's USB ports directly.
- Some USB devices or USB HUB may not be used with this TV.
- You cannot connect any devices by using USB card reader.
- You cannot use two or more same kind of USB devices simultaneously except USB Flash Memory.
- Additional information for USB devices may be on the following website.
<http://panasonic.jp/support/global/cs/tv/>

■ USB Keyboard

- The USB Keyboard requiring its driver is not supported.
- To change the language type ➔ **[USB Keyboard Layout]** (p. 39)
- Characters may not be displayed correctly on the TV screen depending on the connected keyboard or the keyboard layout setting.
- Some of the keys of USB keyboards may correspond to the operation of the remote control.

USB Keyboard	Remote Control	USB Keyboard	Remote Control
↑ / ↓ / ← / →	Cursor buttons	F2	VIERA TOOLS
Enter	OK	F3	MENU
Backspace	BACK/RETURN	F4	INPUT (AV)
Esc	EXIT	F5 / F6	Channel Down / Up
0 - 9 / Character	Numeric buttons	F7 / F8	Volume Down / Up
F1	GUIDE	F9 / F10 / F11 / F12	Coloured buttons

■ Gamepad

- Check the gamepads that have been tested for the performance with this TV at the following website.

<http://panasonic.jp/support/global/cs/tv/>

- Some of the keys of gamepads correspond to the operation of the remote control.

Example:

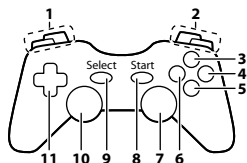

Remote Control		Remote Control	
1	Volume Up / Down	7	VIERA TOOLS
2	Channel Up / Down	8	EXIT
3	GUIDE	9	INPUT (AV)
4	OK	10	MENU
5	BACK/RETURN	11	Cursor buttons
6	INTERNET		

Input signal that can be displayed

■ COMPONENT (Y, P_B, P_R) (from AV2 terminal), HDMI

Signal name	COMPONENT	HDMI
525 (480) / 60i, 60p	○	○
625 (576) / 50i, 50p	○	○
750 (720) / 60p, 50p	○	○
1,125 (1,080) / 60i, 50i	○	○
1,125 (1,080) / 60p, 50p, 24p		○

○ : Applicable input signal

■ PC (from D-sub 15P)

Signal name	Horizontal frequency (kHz)	Vertical frequency (Hz)
640 × 480 @60 Hz	31.47	59.94
800 × 600 @60 Hz	37.88	60.32
852 × 480 @60 Hz	31.44	59.89
1,024 × 768 @60 Hz	48.36	60.00
1,280 × 768 @60 Hz	47.70	60.00
1,280 × 1,024 @60 Hz	63.98	60.02
1,366 × 768 @60 Hz	48.39	60.04

Applicable input signal for PC is basically compatible to VESA standard timing.

■ PC (from HDMI terminal)

Signal name	Horizontal frequency (kHz)	Vertical frequency (Hz)
640 × 480 @60 Hz	31.47	60.00
1,280 × 720 @60 Hz	45.00	60.00
1,920 × 1,080 @60 Hz	67.50	60.00

Applicable input signal for PC is basically compatible to HDMI standard timing.

Note

- Signals other than above may not be displayed properly.
- The above signals are reformatted for optimal viewing on your display.
- PC signal is magnified or compressed for display, so that it may not show fine detail with sufficient clarity.

Characters table for numeric buttons

You can enter characters by using numeric buttons for free input items.

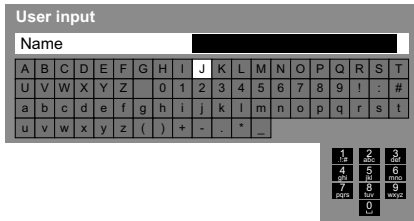

Press the numeric button repeatedly until you reach the desired character.

- The character is set automatically if you leave for 1 second.
- You can also set the character by pressing the OK button or other numeric buttons within 1 second.
- The characters may vary depending on the input items.

Characters table:

Numeric buttons	Characters	Numeric buttons	Characters
1	. @ / ! : # + - * _ () " ' % & ? , ; = \$ [] ~ < > { } ` ^ \	6 _{MNO}	m n o 6 M N O
2 _{abc}	a b c 2 A B C	7 _{PQRS}	p q r s 7 P Q R S
3 _{def}	d e f 3 D E F	8 _{TUV}	t u v 8 T U V
4 _{ghi}	g h i 4 G H I	9 _{WXYZ}	w x y z 9 W X Y Z
5 _{jkl}	j k l 5 J K L	0	Space 0

SCART and HDMI terminal information

AV1 SCART terminal (RGB, VIDEO, Q-Link)

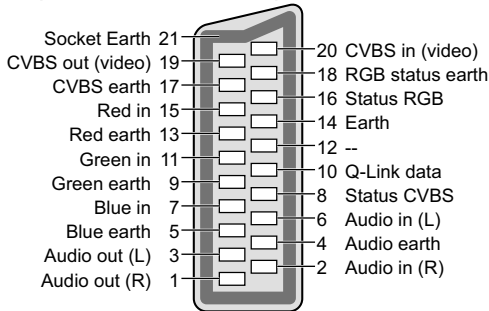

HDMI terminal

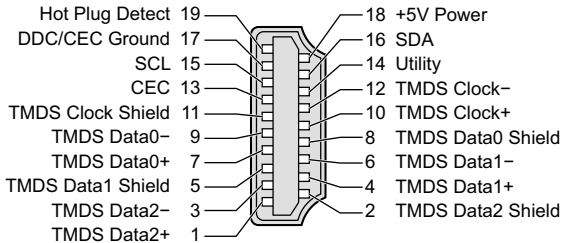

How to use Windows 7 as a media server

Follow the examples below to set up Windows 7 for use as a media server.

Confirm the MAC Address of VIERA in [Network Status] (p. 36).

The following procedure and screens are examples. For more information, refer to the help functions of Windows 7.

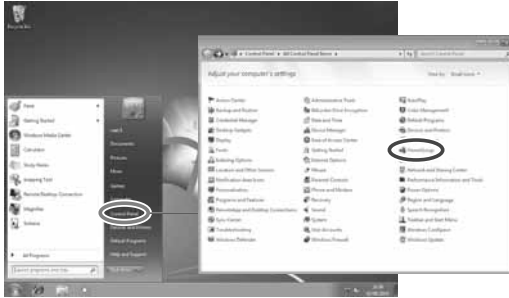

- ① Open the Windows start menu and select [Control Panel]. Select [HomeGroup] in Control Panel window.



- ② Be sure [Pictures], [Music] and [Videos] of "Share libraries and printers" and (Stream my pictures, music, and videos to all devices on my home network) of "Share media with devices" are checked. (Check them and click [Save changes] if necessary). Then select [Choose media streaming options...].



property window

- ③ In [Name your media library:] text box, enter a name that will identify your PC as VIERA. On the Show devices drop bar, select [All networks] to display all the available devices in the list. VIERA Name stored in [Network Link Settings] (p. 67) will be displayed. Select the VIERA Name and click [Allowed] so that VIERA can access your PC. Then, click [OK]. If the VIERA Name is not displayed correctly, click the device to confirm the MAC address of the device in property window. Find a device that has the same MAC address as VIERA: that is your VIERA.

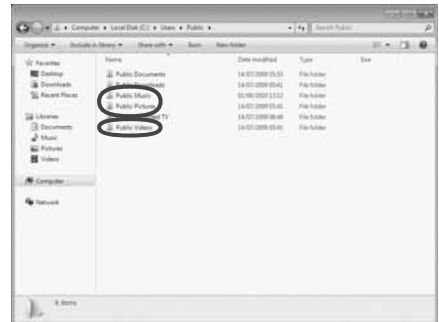

- ④ To share photos, music and videos with VIERA, put photo files into [Public Pictures] folder and video files into [Public Videos] folder under \Computer\Local Disk (C:)\Users\Public.

FAQs

Before requesting service or assistance, please follow these simple guides to resolve the problem. If the problem still persists, please contact your local Panasonic dealer for assistance.

Block noise, frozen or disappearing image occurs in DVB mode / White spots or shadow image (ghosting) occurs in Analogue mode / Some channels cannot be tuned

- Check the position, direction and connection of the aerial.
- Check [Signal Condition] (p. 47). If [Signal Quality] is displayed in red, the DVB signal is weak.
- Check your postcode area is able to receive the Freeview channels at www.freeview.co.uk
- Digital signals may be relatively low to prevent interference with analogue signals for the period of Digital Switchover. Check the schedule of Digital Switchover at www.digitaluk.co.uk
- Weather conditions will affect signal reception (heavy rain, snow, etc.), in particular in poor reception areas. Even during good weather, the high pressure can cause poor reception of some channels.
- Due to the digital reception technologies involved, quality of the digital signals may be relatively low in some cases, despite good reception of analogue channels.
- Turn the TV off with the Mains power On / Off switch, and then on again.
- If problem persists, consult your local dealer or service provider for the availability of services.

No programmes shown on TV Guide

- Check the digital transmitter.
- Adjust the direction of the aerial to another transmitter installed nearby.
- Check the analogue broadcast. If the image quality is poor, check the aerial and consult your local dealer.

Neither image nor sound is produced

- Check the TV is turned on.
- Check the mains lead is plugged into the TV and the socket outlet.
- Check the TV is in AV mode.
- Check the correct input mode is selected.
- Check the Picture Menu (p. 33, 34) and volume.
- Check all required cables and connections are firmly in place.

Auto aspect

- Auto aspect is designed to provide you with the best ratio to fill the screen. ➔ (p. 85)
- Press the ASPECT button if you want to change the aspect ratio manually. ➔ (p. 22)

Black and white picture

- Check that the output of the external equipment matches the input of the TV.
When connecting with SCART, ensure the output setting of the external equipment is not S-Video.

Input mode, i.e. EC/AV1 remains on the screen

- Press the  button to clear it.
Press again to redisplay.

Q-Link function does not work

- Confirm SCART cable and connection.
Also set [AV1 out] in the Setup Menu. ➔ (p. 37)

[VIERA Link] function does not work and an error message appears

- Confirm the connection. ➔ (p. 74, 75)
- Turn the connected equipment on and then switch the TV on. ➔ (p. 77)

Recording does not start immediately

- Check the settings of the recorder. For details, read the manual of the recorder.

There may be red, blue, green and black spots on the screen

- This is a characteristic of liquid crystal panels and is not a problem. The liquid crystal panel is built with very high precision technology giving you fine picture details. Occasionally, a few non-active pixels may appear on the screen as a fixed point of red, green, blue or black. Please note this does not affect the performance of your LCD.

	Problem	Causes / Actions
Screen	Chaotic image, noisy	<ul style="list-style-type: none"> • Set [P-NR] in the Picture Menu to remove noise. ➔ (p. 33) • Check nearby electrical products (car, motorcycle, fluorescent lamp).
	No image can be displayed	<ul style="list-style-type: none"> • Is [Contrast], [Brightness] or [Colour] in the Picture Menu set to the minimum? ➔ (p. 33) • Check the setting of [AV2] ([COMPONENT] / [VIDEO]) in [Input Selection] to match the output of the external equipment. (p. 29)
	Blurry or distorted image (no sound or low volume)	<ul style="list-style-type: none"> • Reset channels. ➔ (p. 44)
	Unusual image is displayed	<ul style="list-style-type: none"> • Turn the TV off with Mains power On / Off switch, then turn it on again. • If the problem persists, initialise all settings. ➔ [Shipping Condition] (p. 51)
Sound	No sound is produced	<ul style="list-style-type: none"> • Is "Sound mute" active? ➔ (p. 9) • Is the volume set to the minimum?
	Sound level is low or sound is distorted	<ul style="list-style-type: none"> • Sound signal reception may be deteriorated. • Set [NICAM] (p. 35) in the Sound Menu to [Mono]. (Analogue)
HDMI	Sound is unusual	<ul style="list-style-type: none"> • Set the sound setting of the connected equipment to "2ch L.PCM". • Check the [HDMI1 / 2 / 3 / 4 Input] setting in the Sound Menu. ➔ (p. 35) • If digital sound connection has a problem, select analogue sound connection. ➔ (p. 90)
	Pictures from external equipment are unusual when the equipment is connected via HDMI	<ul style="list-style-type: none"> • Check the HDMI cable is connected properly. ➔ (p. 82) • Turn the TV and equipment off, then turn them on again. • Check an input signal from the equipment. ➔ (p. 91) • Use equipment compliant with EIA/CEA-861/861D.
Network	Cannot connect to the network	<ul style="list-style-type: none"> • Check the LAN cable or wireless LAN is connected properly. ➔ (p. 66) • Check the connections and settings. ➔ (p. 66 - 70) • Check the network equipment and network environment. • The router may not be set to issue IP address automatically. If the network administrator prefers to allocate an IP address, set an IP address manually. ➔ (p. 68) • The router may be using MAC address filtering (security setting). Confirm the MAC Address of this TV (p. 36) and set the router to use it. • If the problem persists, consult your Internet Service Provider or telecommunications company.
	Cannot select the file during DLNA operations	<ul style="list-style-type: none"> • Is media server of the connected equipment prepared? ➔ (p. 65) • Check applicable data format. ➔ (p. 86, 87)
	Cannot operate VIERA Connect	<ul style="list-style-type: none"> • Check the connections and settings. ➔ (p. 66 - 70) • The server or connected line may be busy now.

	Problem	Causes / Actions
Other	The TV does not switch on	<ul style="list-style-type: none"> • Check the mains lead is plugged into the TV and the socket outlet.
	The TV goes into Standby mode	<ul style="list-style-type: none"> • Auto power standby function is activated. ➔ (p. 10) • The TV enters Standby mode about 30 minutes after analogue broadcasting ends.
	The remote control does not work or is intermittent	<ul style="list-style-type: none"> • Are the batteries installed correctly? ➔ (p. 7) • Has the TV been switched on? • The batteries may be running low. Replace them. • Point the remote control directly at the front of the TV (within about 7 m and a 30 degree angle of the front of the TV). • Situate the TV away from sunshine or other sources of bright light not to shine on the TV's remote control signal receiver.
	Parts of the TV become hot	<ul style="list-style-type: none"> • Even when the temperature of parts of the front, top and rear panels has risen, these temperature rises do not cause any problems in terms of performance or quality.
	The LCD panel moves slightly when it is pushed with a finger Clattered sound might be heard	<ul style="list-style-type: none"> • There is some flexibility around the panel to prevent damage to the panel. • The panel might move slightly when it is pushed with a finger, and clattered sound might be heard. This is not a malfunction.
	Overcurrent error message appears	<ul style="list-style-type: none"> • The connected USB device might cause this error. Remove the device and turn the TV off with Mains power On / Off switch, then turn it on again. • Check foreign objects are not inside the USB port.
	An error message appears	<ul style="list-style-type: none"> • Follow the message's instructions. • If the problem persists, contact your local Panasonic dealer or the authorised service centre.

On-screen messages

Message	Meaning / Action
All tuning data will be erased	<ul style="list-style-type: none"> • [Shipping Condition] will erase all tuning data. ➔ (p. 51)
Are you sure ?	<ul style="list-style-type: none"> • Confirm correct operation.
Are you sure you want to delete this timer ? Press OK to delete timer. Press RETURN to return.	<ul style="list-style-type: none"> • Confirm correct operation.
Bad signal	<ul style="list-style-type: none"> • The signal is weak. Check the aerial is plugged in properly. It may be necessary to have an aerial installer check the signal and aerial alignment. • Reset channels. ➔ (p. 44)
Child Lock is active! Press OK to enter PIN.	<ul style="list-style-type: none"> • The selected channel is locked in Child Lock (p. 50). You must enter the PIN number before the channel will be displayed.
External Recording Due to Start	<ul style="list-style-type: none"> • This message will appear 2 minutes before timer programming event for external recording due to start.
Feature not available.	<ul style="list-style-type: none"> • It is not possible to record from AV2 (COMPONENT) or HDMI. Connect the recorder to the TV using a fully wired SCART cable for recording from the TV tuner. • Confirm Q-Link or VIERA Link settings. ➔ (p. 74 - 77)
Feature not available. Press OK to view how it works.	<ul style="list-style-type: none"> • The selected feature on VIERA TOOLS is not available. Press the OK button to view the demonstration to explain how to use it.
Found new software version ***. Press OK to start update (may take over 40 mins) or press EXIT to ignore and you can update when TV is in standby	<ul style="list-style-type: none"> • There is a new software available.

Message	Meaning / Action
Invalid operation - Please check settings and connections.	<ul style="list-style-type: none"> ● Check the Q-Link or VIERA Link connection and setting. ➔ (p. 74 - 77)
Invalid system time. Please exit !	<ul style="list-style-type: none"> ● Cannot get the time information and cannot edit Timer Programming screen. Check the connection of the RF cable.
Invalid system time, Timer Programming will not work. Please press TV button on remote control and check time display on Banner	<ul style="list-style-type: none"> ● Cannot get the time information. If there is no time displayed on the Information banner, check the connection of the RF cable.
Max. number of timers already set !	<ul style="list-style-type: none"> ● The maximum number of timer programming events is 15.
New channels found! Press OK to update channel list. Press EXIT to ignore.	<ul style="list-style-type: none"> ● There may be new channels available. ● This message will appear each time a change is made by the broadcasters. This message can be deactivated by setting [New Channel Message] to [Off] in [DVB Tuning Menu]. Selecting OK will perform [Update Channel List].
No channel found. Please check aerial or local signal availability. Press OK to start Auto Setup.	<ul style="list-style-type: none"> ● Follow the on-screen instructions. ● Please also refer to p. 94. ● If channels are still not found, consult your local Panasonic dealer.
No module inserted	<ul style="list-style-type: none"> ● Check the CI module is inserted completely (p. 53).
No recording - Already recording	<ul style="list-style-type: none"> ● The equipment may already be recording.
No recording - Check media	<ul style="list-style-type: none"> ● The tape or disc may be "write protected", full, missing or damaged.
No recording - Playing	<ul style="list-style-type: none"> ● The equipment may be playing the tape or disc.
No recording - Unknown reason	<ul style="list-style-type: none"> ● The recording may not be performed. Check the equipment.
No service	<ul style="list-style-type: none"> ● The broadcaster has stopped the service. Check the channel in the TV Guide. (p. 23)
No signal	<ul style="list-style-type: none"> ● The TV cannot detect the signal. Check the connection of the RF cable.
Overcurrent error on USB device occurred. Please remove the USB device, and switch off the TV by mains power switch.	<ul style="list-style-type: none"> ● The connected USB device might cause overcurrent error. Follow the on-screen instructions. ● Check if foreign objects are inside the USB port.
PIN incorrect!	<ul style="list-style-type: none"> ● The PIN number you entered is wrong.
Please check settings and connections on HDMI devices.	<ul style="list-style-type: none"> ● Communication error in VIERA Link function (p. 77).
Please wait.	<ul style="list-style-type: none"> ● A function is in progress.
Recording this channel now	<ul style="list-style-type: none"> ● The recorder is recording the programme from its own tuner. You can turn the TV off and leave the equipment recording in the normal way.
Reset to Factory Shipping Condition Completed. TV will automatically restart. Do not turn off	<ul style="list-style-type: none"> ● [Auto Setup] will automatically start (p. 14).
Sending Preset Data	<ul style="list-style-type: none"> ● Q-Link or VIERA Link channel download is in progress.
Software successfully updated. Press EXIT to continue.	<ul style="list-style-type: none"> ● The software updating is finished.
Software update failed. Please try again later. Press EXIT to continue.	<ul style="list-style-type: none"> ● Perform [System Update Search Now] in System Update (p. 54). If this is still unsuccessful, there may not be any new software available.
The device is not directly connected to the TV. The device may not work correctly.	<ul style="list-style-type: none"> ● Please do not connect the device via a USB HUB.
This timer will not follow the TV Guide information. Press OK to continue, RETURN to restore original timer.	<p>UK only</p> <ul style="list-style-type: none"> ● If you edit the start time or end time of Guide link programming by more than 10 minutes, it will no longer be performed as Guide link programming. The programming will be performed according to the time setting.

Message	Meaning / Action
Timer already expired !	<ul style="list-style-type: none"> The starting time in Timer Programming has already passed. Set the timer correctly (p. 48).
Timer incorrect !	<ul style="list-style-type: none"> Set the start and end times in Timer Programming correctly (p. 48).
Timer overlap. Press OK to keep, RETURN to edit.	<ul style="list-style-type: none"> Timer programming events are overlapped. Press the OK button to keep the overlapped setting. [Ext Rec.] is given priority over [Reminder]. When two or more [Ext Rec.] overlap, the first timer programming event starts and finishes as programmed. The next timer programming event can then start.
Tuner Locked Press EXIT to unlock and stop recording	<ul style="list-style-type: none"> If you want to unlock the tuner, cancel Direct TV Recording (p. 76, 78) or the recording of Timer Programming (p. 48).
Unable to download, please check equipment	<ul style="list-style-type: none"> The tape or disc is active. Stop the equipment and try again.

Media Player / Network

Message	Meaning / Action
Cannot read file	<ul style="list-style-type: none"> The file is broken or unreadable. Check applicable data format. (p. 86, 87)
No Device Inserted	<ul style="list-style-type: none"> Confirm the SD Card or USB device is inserted correctly.
No valid file to play	<ul style="list-style-type: none"> The card has no data.
This operation is not possible	<ul style="list-style-type: none"> The selected operation is not available.
An internal error occurred.	<ul style="list-style-type: none"> Check the settings. (p. 67 - 70)
Cannot read file	<ul style="list-style-type: none"> The file is broken or unreadable. Check applicable data format. (p. 86, 87)
Communication with the server failed.	<ul style="list-style-type: none"> This might be a problem of the media server. Read the manual of the server software.
Connection to the server failed.	<ul style="list-style-type: none"> Check the connections and settings. (p. 66 - 70)
Server not found	<ul style="list-style-type: none"> There are no available media server on your home network. Check the connections and settings. (p. 66 - 70)
The software update is not completed.	<ul style="list-style-type: none"> Network download failed. Check the connections and settings. (p. 66 - 70)
Ethernet cable not connected	<ul style="list-style-type: none"> Check the connection of the LAN cable. If you use a hub, also check the light on the hub is lit. The LAN cable might be defective.

Maintenance

First, remove the mains plug from the socket outlet.

Display panel, Cabinet, Pedestal

Regular care:

Gently wipe the surface of the display panel, cabinet, or pedestal by using a soft cloth to clean the dirt or fingerprints.

For stubborn dirt:

First clean the dust on the surface. Dampen a soft cloth with clean water or diluted neutral detergent (1 part detergent to 100 parts water). Wring the cloth and wipe the surface. Finally, wipe away all the moisture.

Caution

- Do not use a hard cloth or rub the surface too hard, otherwise this may cause scratches on the surface.
- Take care not to subject the TV's surfaces to water or detergent. Liquid inside the TV could lead to product failure.
- Take care not to subject the surfaces to insect repellent, solvent, thinner or other volatile substances. This may degrade surface quality or cause peeling of the paint.
- The surface of the display panel is specially treated and may be easily damaged. Take care not to tap or scratch the surface with your fingernail or other hard objects.
- Do not allow the cabinet and pedestal to make contact with a rubber or PVC substance for a long time. This may degrade surface quality.

Mains plug

Wipe the mains plug with a dry cloth at regular intervals. Moisture and dust may lead to fire or electrical shock.

Glossary

DLNA

Digital Living Network Alliance

DVI

Digital Visual Interface - A high quality video interface standard to connect to the display

ETHERNET

One of the popular standards of LAN

EPG

Electronic Programme Guide - A digital guide showing scheduled programmes

HDMI

High-Definition Multimedia Interface - A digital audio and video interface for transmitting uncompressed digital signals on a single cable

LAN

Local Area Network

MAC Address

Media Access control Address

NICAM

Near Instantaneous Companded Audio Multiplex - A format for digital sound over television

NTSC

National Television System Committee - One of the television signals used in USA, etc.

RF

Radio Frequency - Signal received from terrestrial aerial

SCART

21 pin connection used for video, audio and switching signals (Also known as Euro SCART and Peritel)

Shop viewing environment

Shop viewing environment is the demonstration mode to explain main features of this TV in an easy understandable way. This mode will work if you select [Shop] in "Auto Setup" (p. 17).

SPDIF

A standard audio transfer file format

USB

Universal Serial Bus - An interface specification to connect devices

VCR

Video Cassette Recorder

Licence

Even if no special notation has been made of company or product trademarks, these trademarks have been fully respected.

- DVB and the DVB logos are trademarks of the DVB Project.
- SDXC Logo is a trademark of SD-3C, LLC.
- "AVCHD" and "AVCHD Progressive" are trademarks of Panasonic Corporation and Sony Corporation.
- DivX®, DivX Certified®, DivX Plus® HD and associated logos are trademarks of Rovi Corporation or its subsidiaries and are used under license.
- QuickTime and the QuickTime logo are trademarks or registered trademarks of Apple Inc., used under license therefrom.
- VIERA Connect is a trademark of Panasonic Corporation.
- Skype is a trade mark of Skype Limited.
- DLNA®, the DLNA Logo and DLNA CERTIFIED™ are trademarks, service marks, or certification marks of the Digital Living Network Alliance.
- Windows is a registered trademark of Microsoft Corporation in the United States and other countries.
- HDMI, the HDMI Logo, and High-Definition Multimedia Interface are trademarks or registered trademarks of HDMI Licensing LLC in the United States and other countries.
- HDAVI Control™ is a trademark of Panasonic Corporation.
- VGA is a trademark of International Business Machines Corporation.
- S-VGA is a registered trademark of the Video Electronics Standard Association.
- Manufactured under license from Dolby Laboratories.
Dolby and the double-D symbol are trademarks of Dolby Laboratories.
- Manufactured under license under U.S. Patent Nos: 5,956,674; 5,974,380; 6,487,535 & other U.S. and worldwide patents issued & pending. DTS, the Symbol, & DTS and the Symbol together are registered trademarks & DTS 2.0+Digital Out is a trademark of DTS, Inc. Product includes software. © DTS, Inc. All Rights Reserved.
- Text-To-Speech technology is powered by Nuance®.
2002-2012 Nuance Communications, Inc. All rights reserved.
- Rovi and Rovi Guide are trademarks of Rovi Corporation and/or its subsidiaries.
The Rovi Guide system is manufactured under license from Rovi Corporation and/or its subsidiaries.
The Rovi Guide system is protected by patents and patent applications filed in the US, Europe, and other countries including one or more of the United States patents 6,396,546; 5,940,073; 6,239,794 issued to Rovi Corporation and/or its subsidiaries.

This product incorporates the following software or technology:

- (1) the software developed independently by or for Panasonic Corporation,
- (2) the software owned by third party and licensed to Panasonic Corporation,
- (3) the software based in part on the work of the Independent JPEG Group,
- (4) the software developed by the FreeType Project,
- (5) the software licensed under the GNU LESSER GENERAL PUBLIC LICENSE (LGPL) and/or,
- (6) open sourced software other than the software licensed under the LGPL.
- (7) "PlayReady"(digital right management technology) licensed by Microsoft Corporation or its affiliates.

For the software categorized as (5), please refer to the terms and conditions of LGPL, as the case may be at <http://www.gnu.org/licenses/old-licenses/lgpl-2.1.html>

In addition, the software categorized as (5) are copyrighted by several individuals.

Please refer to the copyright notice of those individuals at <http://www.am-linux.jp/dl/EUIDTV12/>

The LGPL software is distributed in the hope that it will be useful, but WITHOUT ANY WARRANTY, without even the implied warranty of MERCHANTABILITY or FITNESS FOR A PARTICULAR PURPOSE.

At least three (3) years from delivery of products, Panasonic will give to any third party who contact us at the contact information provided below, for a charge no more than our cost of physically performing source code distribution, a complete machine-readable copy of the corresponding source code covered under LGPL.

Contact Information

cdrequest@am-linux.jp

Source code covered under LGPL is also freely available to you and any other member of the public via our website below.

<http://www.am-linux.jp/dl/EUIDTV12/>

For the software categorized as (5) and (6), please refer to the applicable license terms included in the "Setup" menu on product.

Further, for PlayReady categorized as (7), please be aware of the following.

(a) This product contains technology subject to certain intellectual property rights of Microsoft. Use or distribution of this technology outside of this product is prohibited without the appropriate license(s) from Microsoft.

(b) Content owners use Microsoft PlayReady™ content access technology to protect their intellectual property, including copyrighted content. This device uses PlayReady technology to access PlayReady-protected content and/or WMDRM-protected content. If the device fails to properly enforce restrictions on content usage, content owners may require Microsoft to revoke the device's ability to consume PlayReady-protected content. Revocation should not affect unprotected content or content protected by other content access technologies.

Content owners may require you to upgrade PlayReady to access their content.

If you decline an upgrade, you will not be able to access content that requires the upgrade.



Index

- A** Accessories 6
 - Advanced Settings 34, 56
 - Analogue Tuning Menu 44, 45
 - Aspect 22, 85
 - Audio Description 21, 36
 - Auto Gain Control 35
 - Auto Setup 14, 44
 - Auto Standby 36
 - AV1 out 37, 75
- B** Banner Display Timeout 38
- C** Category list 24
 - C.A.T.S. 33
 - Channel List 46
 - Channel Sorting by Region 46
 - Child Lock 50
 - Clamper 13
 - Common Interface 53
 - COMPONENT 84, 91
 - Connection 11 - 13, 66, 74, 75, 82 - 84
- D** Direct TV Recording 76, 78
 - DivX 88
 - DLNA 70
 - DTS 63
 - DVB Tuning Menu 44, 45
 - DVD Recorder 12, 30
 - DVI 90
 - DVI Input Setting 34
- E** EPG 23
 - External equipment 11 - 13, 29, 82 - 84
 - External input 29
- F** FAQs 94 - 96
 - Favourites Edit 45
 - Free input menu 32, 92
- G** Glossary 99
 - Guide link programming 25
- H** HDMI 90, 92, 102
 - HDMI Content Detection 37
 - Hold 21, 27
 - Home Cinema 81
- I** Information banner 20
 - Input Labels 38
 - Input signal 91
- L** Last view 20
- M** Mains lead 11
 - Mains power On / Off switch 10, 14
 - Maintenance 98
 - Manual Tuning 47
 - Media Player 57 - 64
 - Menu Functions 32 - 39
 - Monaural Audio 21
 - Multi Audio 21
 - Music mode 64
- N** Network connections 66
 - Network Setup 67 - 70
 - New Channel Message 47
 - NICAM 35
 - NTSC 33, 102
- O** Off Timer 21, 36
 - Optional accessories 6
 - Owner ID 16, 52
- P** PAL 102
 - Pedestal 7
 - Photo mode 59
 - PIN number 16, 50, 52
 - Playing Time Display 38
 - P-NR 33
 - Power and Timer LED 10
- Q** Q-Link 74, 76
 - Q-Link Download 14, 37
 - Quick Start Guide 6 - 17
- R** Radio Mode 38
 - Remote control 6, 7, 9
 - Reset to Defaults 34, 36
 - RGB 102
- S** Sales and Support Information 104
 - SCART 92, 102
 - SD Card 57, 89
 - Search list 24
 - Shipping Condition 51
 - Signal Condition 47
 - Slideshow 59, 71
 - Software Update 54, 70
 - Specifications 102 - 103
 - Split Programme 25
 - Subtitles 22, 27
 - System Update 54
- T** Teletext 26 - 28
 - Timer Programming 24, 48
 - True Cinema 33
 - TV Guide 23 - 25
 - TV Guide Settings 37
- U** Update Channel List 47
 - USB Flash Memory 57, 89
 - USB connection 90
- V** V-Audio Surround 35
 - VCR 12, 30
 - Video mode 62
 - VIERA Connect 18, 73
 - VIERA Link 74, 77 - 81
 - VIERA TOOLS 31
 - Viewing Mode 33
 - Vivid Colour 33
 - Volume Correction 21, 35
- Z** Zoom 22, 60

Specifications

Model No.		TX-L32E5B	TX-L37E5B	TX-L42E5B	TX-L47E5B
Power source		AC 220-240 V, 50 / 60 Hz			
Panel		LED LCD panel			
Dimensions (W × H × D)		764 mm × 519 mm × 230 mm (With Pedestal) 764 mm × 473 mm × 52 mm (TV only)	874 mm × 581 mm × 238 mm (With Pedestal) 874 mm × 534 mm × 52 mm (TV only)	997 mm × 650 mm × 247 mm (With Pedestal) 997 mm × 604 mm × 52 mm (TV only)	1,107 mm × 712 mm × 268 mm (With Pedestal) 1,107 mm × 666 mm × 52 mm (TV only)
Mass		11.0 kg Net (With Pedestal) 9.0 kg Net (TV only)	13.5 kg Net (With Pedestal) 11.5 kg Net (TV only)	17.0 kg Net (With Pedestal) 14.0 kg Net (TV only)	20.0 kg Net (With Pedestal) 16.5 kg Net (TV only)
Sound	Speaker	(75 mm × 22 mm) × 2, 8 Ω			
	Audio output	20 W (10 W + 10 W)			
	Headphones	M3 (3.5 mm) stereo mini Jack × 1			
Receiving systems / Band name		UK	DVB-T / T2	Digital terrestrial services.	
			PAL I	UHF E21 - 68	
		Ireland	PAL 525/60	Playback of NTSC tape from some PAL Video recorders (VCR) or NTSC disc playback from DVD player and recorder.	
			M.NTSC	Playback from M.NTSC Video recorders (VCR).	
			NTSC (AV input only)	Playback from NTSC Video recorders (VCR).	
				DVB-T	Digital terrestrial services.
				PAL I	VHF A - J
					CATV S1 - S20
				PAL 525/60	Playback of NTSC tape from some PAL Video recorders (VCR) or NTSC disc playback from DVD player and recorder.
				M.NTSC	Playback from M.NTSC Video recorders (VCR).
				NTSC (AV input only)	Playback from NTSC Video recorders (VCR).
Aerial input			UK	UHF	Ireland
Operating conditions		Temperature: 0 °C - 35 °C Humidity: 20 % - 80 % RH (non-condensing)			
Connection terminals	AV1 input / output	SCART (Audio/Video in, Audio/Video out, RGB in, Q-Link)			
	AV2 input (COMPONENT / VIDEO)	VIDEO	RCA PIN Type × 1	1.0 V[p-p] (75 Ω)	
		AUDIO L - R	RCA PIN Type × 2	0.5 V[rms]	
	HDMI 1 / 2 / 3 / 4 input	Y	1.0 V[p-p] (including synchronisation)		
P _B , P _R		±0.35 V[p-p]			
		TYPE A Connectors HDMI1 / 3 / 4: Content Type HDMI2: Content Type, Audio Return Channel • This TV supports "HDAVI Control 5" function.			

Connection terminals	PC	HIGH-DENSITY D-SUB 15PIN R,G,B: 0.7 V[p-p] (75 Ω) HD, VD: TTL Level 2.0 – 5.0 V[p-p] (high impedance) • Applicable input signals: VGA, SVGA, WVGA, XGA SXGA, WXGA …… (compressed) Horizontal scanning frequency 31 - 69 kHz Vertical scanning frequency 60 Hz
	Card slot	SD Card slot × 1 Common Interface slot (complies with CI Plus) × 1
	ETHERNET	RJ45, IEEE802.3 10BASE-T / 100BASE-TX
	USB 1 / 2	USB2.0 DC 5 V, Max. 500 mA
	DIGITAL AUDIO OUT	PCM / Dolby Digital / DTS, Fibre optic

Note

- Design and Specifications are subject to change without notice. Mass and Dimensions shown are approximate.
- For the information of power consumption, display resolution, etc., please refer to Product fiche.
- This equipment complies with the EMC standards listed below.
EN55013, EN61000-3-2, EN61000-3-3, EN55020, EN55022, EN55024

Information for Users on Collection and Disposal of Old Equipment and used Batteries



These symbols on the products, packaging, and/or accompanying documents mean that used electrical and electronic products and batteries should not be mixed with general household waste. For proper treatment, recovery and recycling of old products and used batteries, please take them to applicable collection points, in accordance with your national legislation and the Directives 2002/96/EC and 2006/66/EC.

By disposing of these products and batteries correctly, you will help to save valuable resources and prevent any potential negative effects on human health and the environment which could otherwise arise from inappropriate waste handling.



For more information about collection and recycling of old products and batteries, please contact your local municipality, your waste disposal service or the point of sale where you purchased the items. Penalties may be applicable for incorrect disposal of this waste, in accordance with national legislation.

For business users in the European Union

If you wish to discard electrical and electronic equipment, please contact your dealer or supplier for further information.



[Information on Disposal in other Countries outside the European Union]

These symbols are only valid in the European Union. If you wish to discard these items, please contact your local authorities or dealer and ask for the correct method of disposal.

Cd

Note for the battery symbol (bottom two symbol examples):

This symbol might be used in combination with a chemical symbol. In this case it complies with the requirement set by the Directive for the chemical involved.

Sales and Support Information

Customer Communications Centre

- For customers within the UK: **0844 844 3899**
- For customers within Ireland: **01 289 8333**
- For further support on your product, please visit our website: www.panasonic.co.uk

Direct Sales at Panasonic UK

- Order accessory and consumable items for your product with ease and confidence by phoning our Customer Communications Centre.
Monday – Thursday 9:00am – 5:30pm, Friday 9:30am – 5:30pm (Excluding public holidays)
- Or go on line through our Internet Accessory ordering application at www.pas-europe.com.
- Most major credit and debit cards accepted.
- All enquiries transactions and distribution facilities are provided directly by Panasonic UK.
- It couldn't be simpler!
- Also available through our Internet is direct shopping for a wide range of finished products. Take a browse on our website for further details.



Declaration of Conformity (DoC)

Authorized Representative:

Panasonic Testing Centre

Panasonic Marketing Europe GmbH

Winsbergring 15, 22525 Hamburg, Germany

Customer's Record

The model number and serial number of this product may be found on its rear panel. You should note this serial number in the space provided below and retain this book, plus your purchase receipt, as a permanent record of your purchase to aid in identification in the event of theft or loss, and for Warranty Service purposes.

Model Number

Serial Number

Panasonic UK, a branch of Panasonic Marketing Europe GmbH

Willoughby Road, Bracknell, Berkshire, RG12 8FP

Web Site: <http://panasonic.net>

F0112(5)-0