

Panasonic®

DVD Stereo System Operating Instructions

Model No. **SC-DP1**

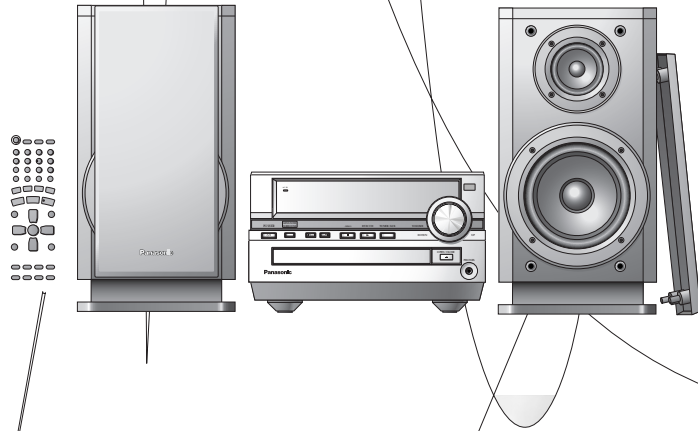

Before connecting, operating or adjusting this product,
please read these instructions completely.
Please keep this manual for future reference.

Region number supported by this player

Region numbers are allocated to DVD players and software
according to where they are sold.

- The region number of this player is "1".
- The player will play DVD-Video marked with labels containing
"1" or "ALL".

Example:



For U.S.A. only

The warranty can be found on page 39.

P PC

RQT6815-1P

Dear customer

Thank you for purchasing this product.
For optimum performance and safety, please read these instructions carefully.

Operations in these instructions are described mainly with the remote control, but you can do the operations on the main unit if the controls are the same.

Getting started

CAUTION!

THIS PRODUCT UTILIZES A LASER.
USE OF CONTROLS OR ADJUSTMENTS OR PERFORMANCE OF PROCEDURES OTHER THAN THOSE SPECIFIED HEREIN MAY RESULT IN HAZARDOUS RADIATION EXPOSURE.
DO NOT OPEN COVERS AND DO NOT REPAIR YOURSELF. REFER SERVICING TO QUALIFIED PERSONNEL.

WARNING:



TO REDUCE THE RISK OF FIRE, ELECTRIC SHOCK OR PRODUCT DAMAGE, DO NOT EXPOSE THIS APPARATUS TO RAIN, MOISTURE, DRIPPING OR SPLASHING AND THAT NO OBJECTS FILLED WITH LIQUIDS, SUCH AS VASES, SHALL BE PLACED ON THE APPARATUS.

CAUTION:

TO PREVENT ELECTRIC SHOCK MATCH WIDE BLADE OF PLUG TO WIDE SLOT, FULLY INSERT.

CAUTION!

DO NOT INSTALL OR PLACE THIS UNIT IN A BOOKCASE, BUILT-IN CABINET OR IN ANOTHER CONFINED SPACE. ENSURE THE UNIT IS WELL VENTILATED. TO PREVENT RISK OF ELECTRIC SHOCK OR FIRE HAZARD DUE TO OVERHEATING, ENSURE THAT CURTAINS AND ANY OTHER MATERIALS DO NOT OBSTRUCT THE VENTILATION VENTS.

	CAUTION RISK OF ELECTRIC SHOCK DO NOT OPEN	
<p>CAUTION: TO REDUCE THE RISK OF ELECTRIC SHOCK, DO NOT REMOVE SCREWS. NO USER-SERVICEABLE PARTS INSIDE. REFER SERVICING TO QUALIFIED SERVICE PERSONNEL.</p>		



The lightning flash with arrowhead symbol, within an equilateral triangle, is intended to alert the user to the presence of uninsulated "dangerous voltage" within the product's enclosure that may be of sufficient magnitude to constitute a risk of electric shock to persons.



The exclamation point within an equilateral triangle is intended to alert the user to the presence of important operating and maintenance (servicing) instructions in the literature accompanying the appliance.

System	SC-DP1
Main unit	SA-DP1
Speakers	SB-DP1

CAUTION	- LASER RADIATION WHEN OPEN. DO NOT STARE INTO BEAM. FDA 21 CFR / Class II
CAUTION	- VISIBLE AND INVISIBLE LASER RADIATION WHEN OPEN. AVOID EXPOSURE TO BEAM. IEC60825-1 / Class 3b
VARNING	- SYNLIIG OCH USYNLIIG LASERSTRÅLNING NÄR DENNA DEL ÄR ÖPPNAD. BEHÅRKA EJSSTRÅLEN.
ADVARSEL	- SYNLIG OG USYNLIG LASERSTRÅLING VED ÅBNING. UNDGÅ UDSÆTTELSE FOR STRÅLING.
ADVARSEL	- SYNLIG OG USYNLIG LASERSTRÅLING NÄR DEKSEL ÅPNES. UNNGÅ EKSPONERING FÖR STRÅLEN.
VARO!	- AVATTAESSA OLET ALTTIINA NÄKYVÄÄ JA NÄKYMÄTÖN LASERSTRÄLVIÄ. ÄLÄ KATSO SÄTEESEEN.
VORSICHT	- SICHTBARE UND UNSICHTBARE LASERSTRÄHLUNG WENN ABDECKUNG GEÖFFNET. NICHT DEM STRAHL AUSSETZEN.
ATTENTION	- RAYONNEMENT LASER VISIBLE ET INVISIBLE EN CAS D'OUVERTURE. EXPOSITION DANGEREUSE AU FAISCEAU.
注意	- 打开時有可见及不可见激光辐射。避免激光照射。
注意	- ここを開くと可視及び不可視レーザー光が出ます。ビームを直たり、触れたりしないで下さい。 RCLXS0054

(Inside of product)

THE FOLLOWING APPLIES ONLY IN THE U.S.A.:

CAUTION:

This equipment has been tested and found to comply with the limits for a Class B digital device, pursuant to Part 15 of the FCC Rules.

These limits are designed to provide reasonable protection against harmful interference in a residential installation. This equipment generates, uses and can radiate radio frequency energy and, if not installed and used in accordance with the instructions, may cause harmful interference to radio communications. However, there is no guarantee that interference will not occur in a particular installation. If this equipment does cause harmful interference to radio or television reception, which can be determined by turning the equipment off and on, the user is encouraged to try to correct the interference by one or more of the following measures:

- Reorient or relocate the receiving antenna.
- Increase the separation between the equipment and receiver.
- Connect the equipment into an outlet on a circuit different from that to which the receiver is connected.
- Consult the dealer or an experienced radio/TV technician for help.

Any unauthorized changes or modifications to this equipment would void the user's authority to operate this device.

This device complies with Part 15 of the FCC Rules. Operation is subject to the following two conditions: (1) This device may not cause harmful interference, and (2) this device must accept any interference received, including interference that may cause undesired operation.

Accessories



Please check and identify the supplied accessories. Use numbers indicated in parentheses when asking for replacement parts.

(Only for U.S.A.)

To order accessories contact 1-800-332-5368 or the website (<http://www.panasonic.com>).

(Only for Canada)

To order accessories, call the dealer from whom you have made your purchase.

- 1 Remote control (N2QAJB000073)



- 2 Batteries for remote control

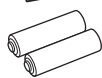

- 1 AC power supply cord (RJA0065-1D)

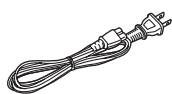

- 1 AM loop antenna (N1DAAA00001)



- 1 FM indoor antenna (RSA0007-J)

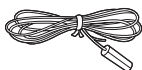

- 1 Video cable (RJL1P016B15A)



- 1 Antenna plug (K2RC021B0001)



Note

The included AC power supply cord is for use with this unit only. Do not use it with other equipment.

User memo:

DATE OF PURCHASE	_____
DEALER NAME	_____
DEALER ADDRESS	_____
TELEPHONE NUMBER	_____

The model number and serial number of this product can be found on either the back or the bottom of the unit. Please note them in the space provided below and keep for future reference.

MODEL NUMBER _____ SC-DP1
SERIAL NUMBER _____

Table of contents

Getting started

Accessories	3
IMPORTANT SAFETY INSTRUCTIONS	4
Disc information	5

Simple setup

STEP1 Locating	6
STEP2 Connecting the speakers	7
STEP3 Television	8
STEP4 Connecting the antennas and AC power supply cord	9
STEP5 The remote control	9
STEP6 QUICK SETUP	10
STEP7 Setting the time	11
Turning DEMO off	11

Control reference guide	12
-------------------------	----

Disc operations

Discs—Basic play	13
Position Memory function	13
Skipping items/Fast forward and rewind—SEARCH	14
Slow-motion play/Frame-by-frame viewing	14
Discs—Convenient functions	15
Starting play from a selected item/Repeat play	15
A-B repeat play/Selecting groups to play	15
All group play/Random play/Program play	16
Soundtracks/Subtitles/Angles	17
Marking places to play again/Variable Zoom function	18
Advanced surround/Cinema	19
Selecting still pictures—Page Skip/Dialogue enhancer	19
Rotating pictures/Replaying a scene—QUICK REPLAY	19
Navigation menus	20
Playing WMA/MP3/JPEG and CD text	20
Playing HighMAT discs	21
Playing the programs or play lists on DVD-RAM	22
Using On-Screen Menu Icons	23
Common procedures/Progress indicator	23
Disc information/Unit information	24

Radio operations

The radio	26
Manual tuning/Preset tuning	26

Other functions

Convenient functions	27
Double re-master—Enjoying more natural sound	27
Adjusting the bass and treble with manual equalizer	27
Using the built-in sound quality settings	27
Enjoying more powerful bass	28
Muting the volume/Changing the display	28
Operating a television	28
The play timer/The sleep timer/Using headphones	29
Changing settings	30
Language code list	32
Optional antenna connections	32
Using other equipment	33

Reference

Glossary	34
Specifications	35
Troubleshooting guide	36
Product Service	38
Maintenance	38
Limited Warranty (U.S.A.)	39

IMPORTANT SAFETY INSTRUCTIONS

Read these operating instructions carefully before using the unit. Follow the safety instructions on the unit and the applicable safety instructions listed below. Keep these operating instructions handy for future reference.

- 1) Read these instructions.
- 2) Keep these instructions.
- 3) Heed all warnings.
- 4) Follow all instructions.
- 5) Do not use this apparatus near water.
- 6) Clean only with dry cloth.
- 7) Do not block any ventilation openings. Install in accordance with the manufacturer's instructions.
- 8) Do not install near any heat sources such as radiators, heat registers, stoves, or other apparatus (including amplifiers) that produce heat.
- 9) Do not defeat the safety purpose of the polarized or grounding-type plug. A polarized plug has two blades with one wider than the other. A grounding-type plug has two blades and a third grounding prong. The wide blade or the third prong are provided for your safety. If the provided plug does not fit into your outlet, consult an electrician for replacement of the obsolete outlet.
- 10) Protect the power cord from being walked on or pinched particularly at plugs, convenience receptacles, and the point where they exit from the apparatus.
- 11) Only use attachments/accessories specified by the manufacturer.
- 12) Use only with the cart, stand, tripod, bracket, or table specified by the manufacturer, or sold with the apparatus. When a cart is used, use caution when moving the cart/apparatus combination to avoid injury from tip-over. 
- 13) Unplug this apparatus during lightning storms or when unused for long periods of time.
- 14) Refer all servicing to qualified service personnel. Servicing is required when the apparatus has been damaged in any way, such as power-supply cord or plug is damaged, liquid has been spilled or objects have fallen into the apparatus, the apparatus has been exposed to rain or moisture, does not operate normally, or has been dropped.

Getting started

Disc information

Discs that can be played

Disc type	Logo	Indication used in instructions
DVD-RAM		RAM
DVD-Audio		DVD-A
DVD-Video		DVD-V
DVD-R		
Video CD		VCD Including SVCD (conforming to IEC62107)
CD		CD Including CD text
CD-R/RW	—	WMA MP3 JPEG

- Multiple-channel signals are down-mixed to stereo (2-channel). (To enjoy multi-channel surround sound → page 33)
- Use discs with the above logos and that conform to specifications. The unit cannot play other discs correctly.
- Do not use irregularly shaped discs (e.g. heart-shaped), as these can damage the unit.

Discs that cannot be played

PAL discs (except DVD-Audio), DVD-ROM, CD-ROM, CDV, CD-G, +RW, DVD-RW, CVD, SACD, Divx Video Discs, Photo CD and "Chaoji VCD" available on the market including CVD, DVCD and SVCD that do not conform to IEC62107.

Disc structure

Disc structure and the labels given to the items on discs depend on the disc type.

Track: the smallest division on DVD-Audio, CDs, and Video CDs, or a single WMA/MP3 file.

Chapter: the smallest division on DVD-Video.

Group: collections of tracks on DVD-Audio and equivalent to folders or albums on data discs.

Title: the largest division on DVD-Video, usually an entire movie.

Program: the division on DVD-RAM equivalent to a single recording.

Picture: a single JPEG file.

Play list: the largest grouping on a HighMAT disc, or a group of scenes on DVD-RAM

Scene: DVD-RAM program sections specified and grouped into play lists on a DVD video recorder.

Content: covers tracks and pictures on HighMAT discs.

Built-in decoders

This unit has Dolby Digital and DTS decoders so you can enjoy these systems in stereo without connecting a separate decoder.



Playing DVDs and Video CDs

The producer of these discs can control how they are played so you may not always be able to control play as described in these operating instructions (for example if the play time is not displayed or if a Video CD has menus). Read the disc's instructions carefully.

HighMAT discs

This unit is compatible with HighMAT discs containing WMA, MP3, and/or JPEG files.

CD-R and CD-RW discs

This unit can play CD-R/RW (audio recording disc) recorded with CD-DA, video CD, SVCD (conforming to IEC62107), WMA, MP3 or JPEG. Close the sessions or finalize the disc after recording.

DVD-R discs

Panasonic DVD-R recorded and finalized on a Panasonic DVD video recorder are played as DVD-Video on this unit.

DVD-RAM discs

DVD-RAM discs must meet the following conditions for this unit to be able to play them.

Type	<ul style="list-style-type: none"> • Non-cartridge discs • Discs that can be removed from their cartridges (TYPE 2 and 4)
Capacity	<ul style="list-style-type: none"> • 12 cm (5") 9.4 GB (double-sided) and 4.7 GB (single-sided) • 8 cm (3") 2.8 GB (double-sided)
Recording format	Discs recorded with DVD video recorders, DVD video cameras, personal computers, etc., using Version 1.1 of the Video Recording Format (a unified video recording standard).

- Remove TYPE 2 and 4 discs from their cartridges before use, then return them when you are finished, making sure that the labels of the disc and cartridge face the same way.
- Some parts of the disc, for example where one program ends and another begins, may not play smoothly.

Note

It may not be possible to play CD-R, CD-RW, DVD-R and DVD-RAM in all cases due to the type of disc or condition of the recording.

Playing PAL system DVD-Audio

This unit converts PAL to NTSC for play. The picture is compressed to show it in its entirety, but this may cause it to be stretched vertically.

To clean discs

DVD-Audio, DVD-Video, Video CD, CD

Wipe with a damp cloth and then wipe dry.

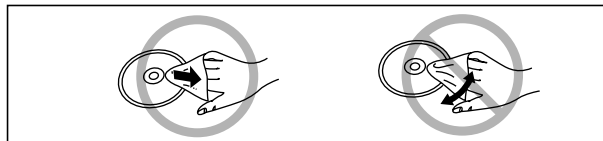

DVD-RAM, DVD-R

- Clean with an optional DVD-RAM/PD disc cleaner (LF-K200DCA1, where available).
- Never use cloths or cleaners for CDs etc.

Handling precautions

- Do not write on the label side with a ball-point pen or other writing instrument.
- Do not use record cleaning sprays, benzine, thinner, static electricity prevention liquids or any other solvent.
- Do not attach labels or stickers to discs. (Do not use discs with exposed adhesive from tape or left over peeled-off stickers.)
- Do not use scratch-proof protectors or covers.
- Do not use discs printed with label printers available on the market.

Simple setup

STEP 1 Locating

**• Use only supplied speakers**

Using other speakers can damage the unit and sound quality will be negatively affected.

- Set the speakers up on an even surface to prevent them from falling. Take proper precautions to prevent the speakers from falling if you cannot set them up on an even surface.

Positioning for best effect

How you set up your speakers can affect the bass and the sound field. Note the following points.

- Place speakers on flat secure bases.
- Placing speakers too close to floors, walls, and corners can result in excessive bass. Cover walls and windows with thick curtain.

Notes on speaker use

- You can damage your speakers and shorten their useful life if you play sound at high levels over extended periods.
- Reduce the volume in the following cases to avoid damage.
 - When playing distorted sound.
 - When the speakers are receiving howling from a record player, noise from FM broadcasts, or continuous signals from an oscillator, test disc, or electronic instrument.
 - When adjusting the sound quality.
 - When turning the unit on or off.

If irregular coloring occurs on your television

These speakers are designed to be used close to a television, but the picture may be affected with some televisions and setup combinations.

If this occurs, turn the television off for about 30 minutes.

The television's demagnetizing function should correct the problem. If it persists, move the speakers further away from the television.

STEP 2 Connecting the speakers

Twist the vinyl tip and pull off.

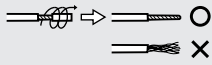

Confirm the colors of the tags on the ends of the cords.

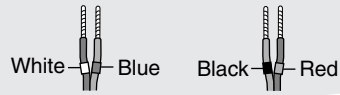

Note

- Never short-circuit positive (+) and negative (-) speaker wires.
 - Be sure to connect only positive (copper) wires to positive (+) terminals and negative (silver) wires to negative (-) terminals.
- Incorrect connection can damage the speakers.

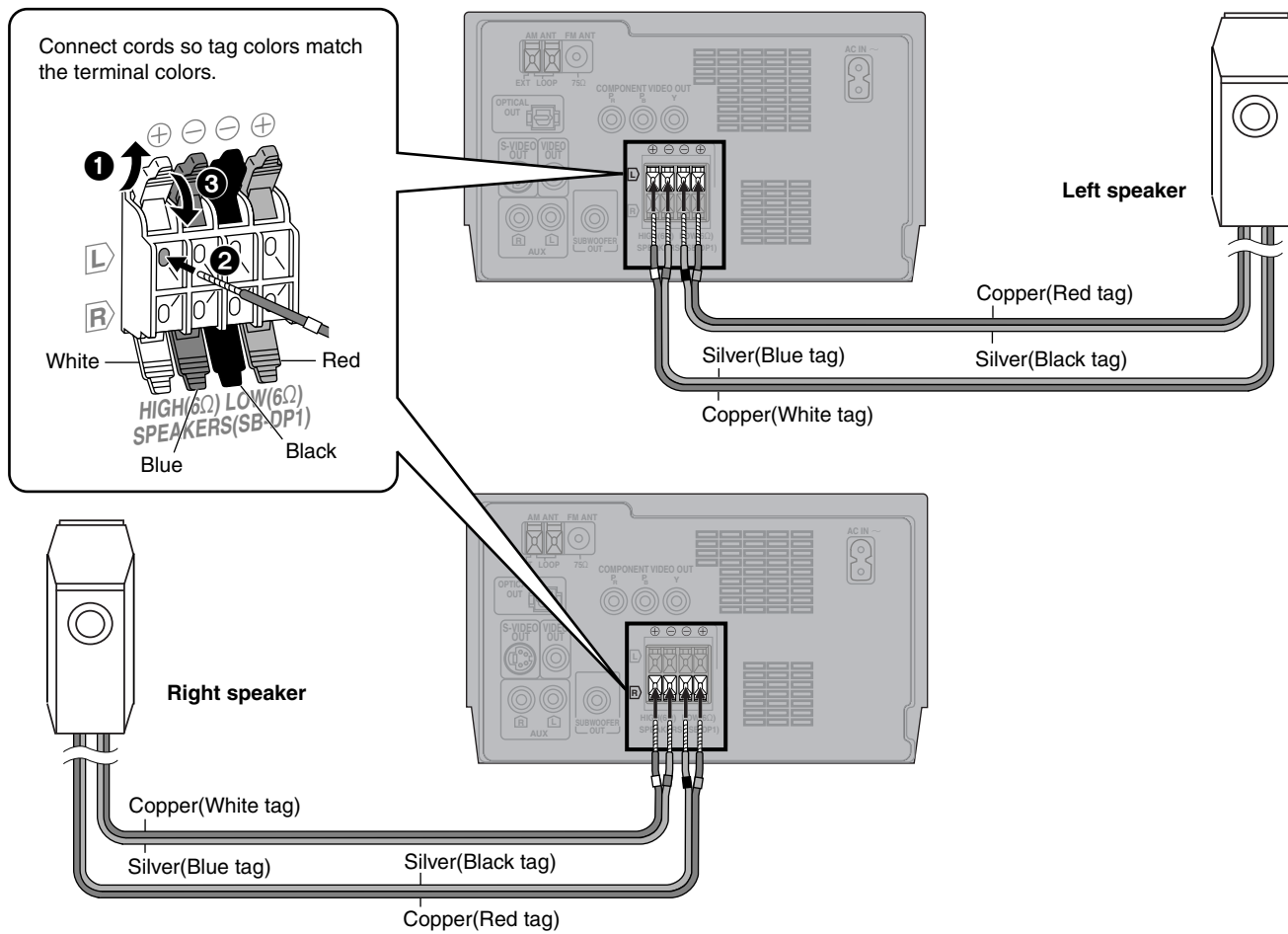

STEP 4 Connecting the antennas and AC power supply cord

Connect the AC power supply cord after all other connections are complete.

AM loop antenna

Stand the antenna up on its base.

Keep loose antenna cord away from other wires and cords.

FM indoor antenna

Fix the other end of the antenna where reception is best.

Conserving power

The unit consumes power (approx. 0.9 W) even when it is turned off with [⏻]. To save power when the unit is not to be used for a long time, unplug it from the household AC outlet. You will need to reset some memory items after plugging the unit.

AM loop antenna



FM indoor antenna



AC power supply cord

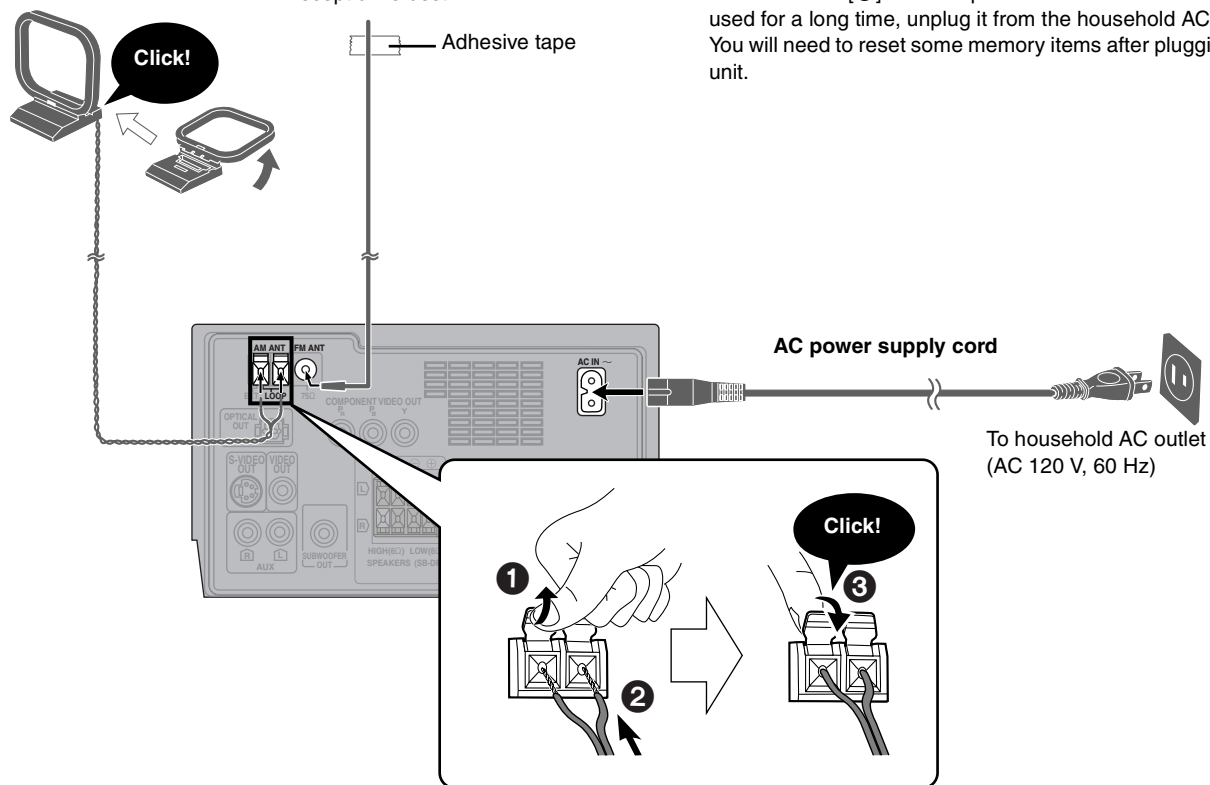
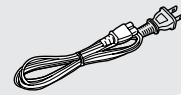

STEP 5 The remote control

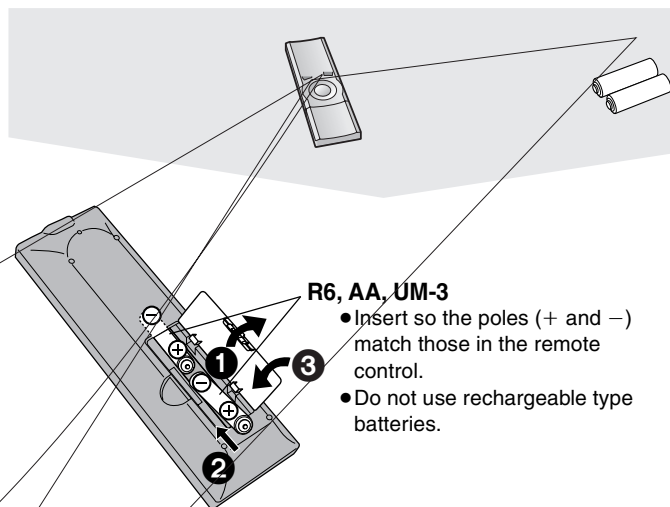

- Insert so the poles (+ and -) match those in the remote control.
- Do not use rechargeable type batteries.

Do not;

- mix old and new batteries.
- use different types at the same time.
- heat or expose to flame.
- take apart or short circuit.
- attempt to recharge alkaline or manganese batteries.
- use batteries if the covering has been peeled off.

Mishandling of batteries can cause electrolyte leakage which can damage items the fluid contacts and may cause a fire.

Remove if the remote control is not going to be used for a long period of time. Store in a cool, dark place.

Use

Aim at the sensor, avoiding obstacles, at a maximum range of 7 m (23 feet) directly in front of the unit.

STEP 6 QUICK SETUP

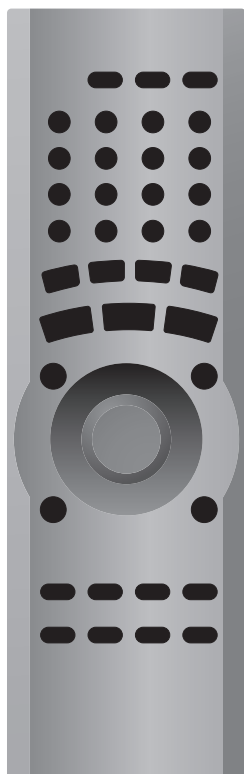

The **QUICK SETUP** screen appears when you press [SETUP] the first time after purchase and assists you to make necessary settings. You can access this screen again later if you need to (⇒ page 30, Others—QUICK SETUP).

Preparation

Turn on the television and select the appropriate video input on the television to suit the connections for the unit.

To return to the previous screen

Press [RETURN].

■ TV Type

Select to suit the type of television.

- **Standard (Direct View TV)** (factory preset)
- **CRT Projector**
- **LCD TV/Projector**
- **Projection TV**
- **Plasma TV**

■ TV Aspect

Select “**4:3**” (regular) or “**16:9**” (widescreen) to suit your television.

If you have a regular 4:3 television, you can also select how video on some discs is shown (⇒ page 30, Video—TV Aspect).

● **4:3 Pan&Scan** (factory preset)

Widescreen software is expanded to fill the screen of a 4:3 aspect television (unless prohibited by the producer of the disc).

● **4:3 Letterbox**

Widescreen software is shown in the letterbox style on a 4:3 aspect television.

- 1** Press [⏻] to turn on the unit.
- 2** Press [▶ DVD/CD] to select “DVD/CD” as the source.
Press [■] when a disc is in the tray.
- 3** Press [SETUP] to show the **QUICK SETUP** screen.
- 4** Press [▲, ▼] to select the menu language and press [ENTER].
- 5** Press [▲, ▼] to select “Yes” to continue and press [ENTER].
- 6** Press [▲, ▼] to select the item and press [ENTER].
 - Audio Language (⇒ page 30)
 - Subtitle Language (⇒ page 30)
 - TV Type (⇒ below)
 - TV Aspect (⇒ below)
 - Progressive Out (⇒ page 30)
 - PCM Digital Output (⇒ page 30)
- 7** Press [ENTER] and then [SETUP] to end the settings.

■ To enjoy progressive video

- 1 Connect to the component video input terminals on a 480P compatible television (⇒ page 8). (Video will not be displayed correctly if connected to an incompatible television.)
 - 2 In QUICK SETUP, set “Progressive Out” to “Enable”.
 - 3 Change “Video output mode” to “480P”(⇒ page 25).
- All televisions manufactured by Panasonic and that have 480P input connectors are compatible. Consult the manufacturer if you have another brand of television.
 - If the unit is connected to the television through VIDEO OUT or S-VIDEO OUT, output will be interlace, irrespective of the settings.

STEP 7 Setting the time

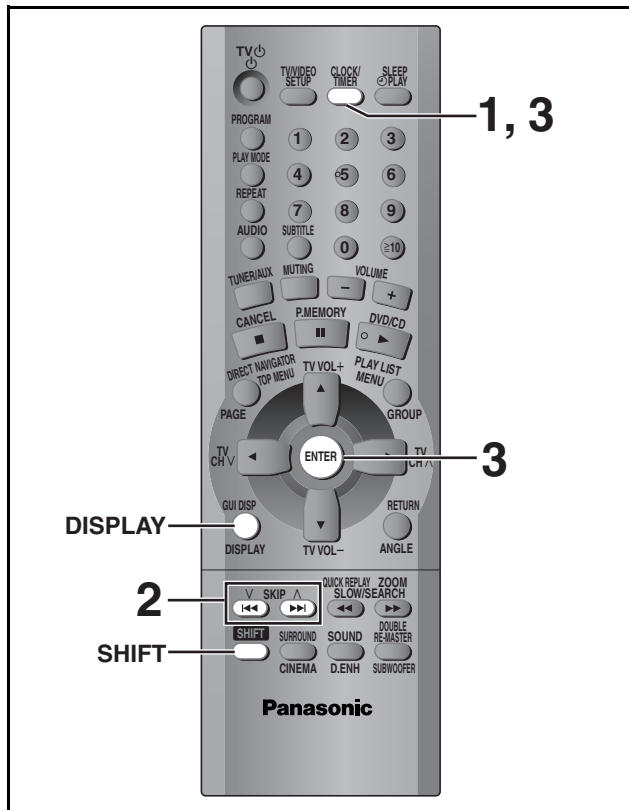

This is a 12-hour clock.

- 1 Press [CLOCK/TIMER] to select the clock.

AM-- : --

Each time you press the button:

Clock → ⓄPLAY → Original display

- 2 Within 10 seconds Press [◀◀, v] or [▶▶, ^] to set the time.

The time display can be changed quickly by holding down the buttons.

- 3 Press [CLOCK/TIMER] or [ENTER].

The time is set and the original display is restored.

To display the time when the unit is off

Press [SHIFT] + [DISPLAY].

The clock is shown for about 5 seconds.

Reset the clock regularly to maintain accuracy.

Turning DEMO off

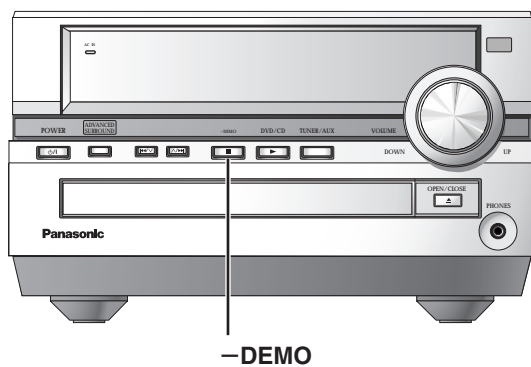

A demonstration of the display is shown in standby mode if you have not set the clock.

You can reduce the power consumed in standby mode by turning the demonstration off.

While the DEMO display is shown

Press and hold [-DEMO] until "DEMO OFF" is displayed.

DEMO OFF

Each time you press and hold the button:

DEMO OFF ↔ DEMO ON

Control reference guide

Getting started

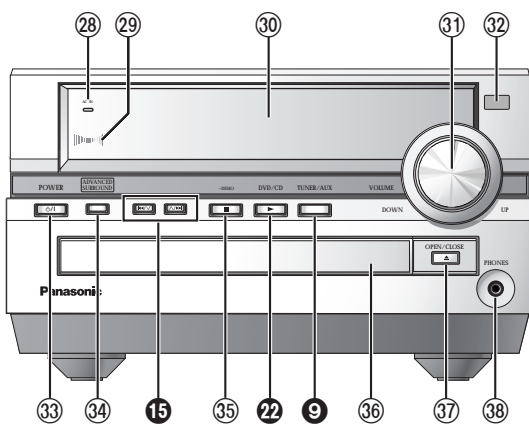
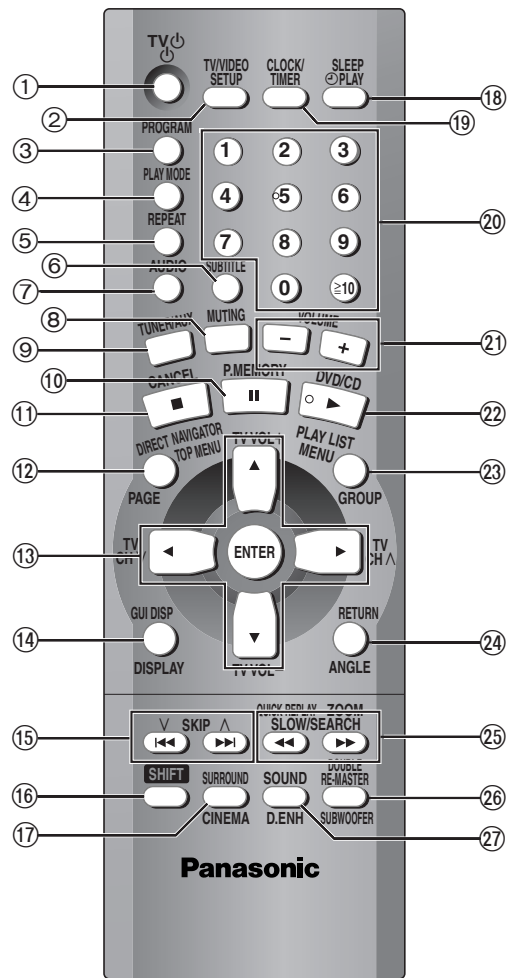

Remote control

- ① Standby/on, TV standby/on switch [⏻, TV⏻] 10, 28
- ② Setup, TV/VIDEO button [SETUP, TV/VIDEO] 10, 28
- ③ Program button [PROGRAM] 16, 26
- ④ Play mode button [PLAY MODE] 16, 26
- ⑤ Repeat button [REPEAT] 15
- ⑥ Subtitle button [SUBTITLE] 17
- ⑦ Audio button [AUDIO] 17
- ⑧ Muting button [MUTING] 28
- ⑨ Tuner/Aux button [TUNER/AUX] 26
- ⑩ Pause, Position memory button [⏸, P.MEMORY] 13
- ⑪ Stop, Cancel button [■, CANCEL] 13, 16
- ⑫ Direct navigator, Top menu, Page button [DIRECT NAVIGATOR, TOP MENU, PAGE] 14, 19, 22
- ⑬ Cursor buttons [▲, ▼, ◀, ▶], Enter button [ENTER] 10
These buttons have the following functions.
[▲, ▼]: TV volume buttons [TV VOL +, -] 28
[◀, ▶]: TV channel buttons [TV CH v, ^] 28
- ⑭ GUI display, Display button [GUI DISP, DISPLAY] 23, 28
- ⑮ Skip, Preset channel buttons [◀◀ ▶▶, v SKIP ^] 14, 26
- ⑯ Shift button [SHIFT]

To use functions labeled in orange:
While pressing [SHIFT], press the corresponding button.

- ⑰ Advanced Surround, Cinema button [SURROUND, CINEMA] 19
- ⑱ Play timer, Sleep timer button [⌚PLAY, SLEEP] 29
- ⑲ Clock/Timer button [CLOCK/TIMER] 11, 29
- ⑳ Numbered buttons [1-9, 0, ≥10] 14
- ㉑ Volume buttons [-, +, VOLUME] 13
- ㉒ Play button [▶ DVD/CD] 13
- ㉓ Play list, Menu, Group button [PLAY LIST, MENU, GROUP] 14, 15, 22
- ㉔ Return, Angle button [RETURN, ANGLE] 10, 17
- ㉕ Slow/search, Tuning buttons [◀◀, ▶▶ SLOW/SEARCH] 14, 26
These buttons have the following functions.
[◀◀]: Quick replay button [QUICK REPLAY] 19
[▶▶]: Zoom button [ZOOM] 18
- ㉖ Double re-master, Subwoofer button [DOUBLE RE-MASTER, SUBWOOFER] 27, 28
- ㉗ Sound, Dialogue enhancer button [SOUND, D.ENH] 19, 27

Main unit

Buttons ⑨, ⑮ and ㉒ function the same as the controls on the remote control.

- ⑳ AC supply indicator [AC IN]
This indicator lights when the unit is connected to the AC power supply.
- ㉑ Advanced Surround indicator 19
- ⑳ Display
- ㉑ Volume control [VOLUME, DOWN, UP] 13
- ㉒ Remote control signal sensor
- ㉓ Standby/on switch [⏻/⏻ POWER] 10
Press to switch the unit from on to standby mode or vice versa.
In standby mode, the unit is still consuming a small amount of power.
- ㉔ Advanced Surround button [ADVANCED SURROUND] 19
- ㉕ Stop, Demo button [■, -DEMO] 11, 13
- ㉖ Disc tray 13
- ㉗ Open/close button [▲ OPEN/CLOSE] 13
- ㉘ Headphone jack [PHONES] 29

Discs—Basic play

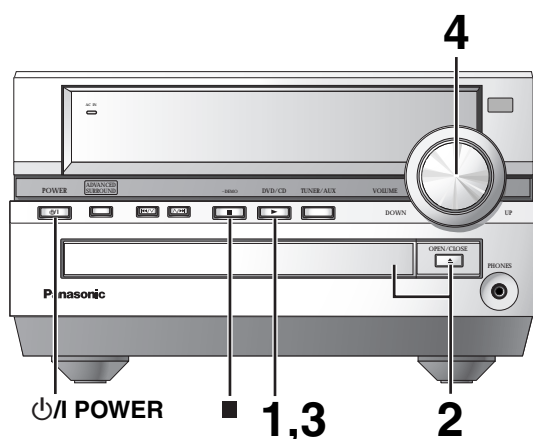

RAM DVD-A DVD-V VCD CD WMA MP3 JPEG

Preparation

- Press [POWER] to turn on the unit.
- Turn on the television and select the appropriate video input on the television to suit the connections for the unit.

1 Press [▶ DVD/CD] to select “DVD/CD” as the source.

- Press [■] when a disc is in the tray.
- If the disc contains both audio data (WMA and MP3) and JPEG, check “Mixed Disc—Audio & Stills” setting in the SETUP menu (➔ page 30). Select “Stills (JPEG)” to play JPEG or “Audio (MP3/WMA)” to play WMA/MP3.

2 Press [▲ OPEN/CLOSE] to open the disc tray and place the disc.

- Remove TYPE 2 and 4 discs from their cartridges before use. **RAM**
- Label-up (With double-sided discs, load so the label for the side you want to play is facing up.)

Press [▲ OPEN/CLOSE] again to close and start play.
When a menu appears after inserting a HighMAT disc
 ➔ page 21

3 If play doesn't start after step 2

Press [▶ DVD/CD].

[CD] (CD text only) [WMA] [MP3]

Track information appears on the television. Press [SUBTITLE] to turn the display on or off.

4 Adjust the volume.

■ To pause play

Press [II] during play.
 Press [▶ DVD/CD] to restart play.

■ To stop play

Press [■] (➔ below, Resume function).

Note

- If “⊘” appears on the television
 The operation is prohibited by the unit or disc.
- It may take some time for play to start but this is normal.
- Multiple-channel signals are down-mixed to stereo (2-channel). (To enjoy multi-channel surround sound ➔ page 33)
 If “D.MIX” flashes on the display **DVD-A**
 The DVD-Audio contains multiple-channel signals that cannot be down-mixed.

RAM DVD-A DVD-V VCD CD WMA MP3 JPEG

During play

Press [SHIFT]+[P.MEMORY] to memorize a position.

Press again to replace the position.

This position is saved even if you turn the unit off, change the source or open the disc tray. When you turn the unit on, reselect “DVD/CD” or reinsert the disc whose position you memorized, “RESUME” lights on the display. Press [▶ DVD/CD] to start play from the memorized position. The position is cleared.

- You can memorize positions on up to five different discs at a time. When you memorize another position, the earliest position is replaced.

“RESUME” lights on the display when the unit has recorded the position at which you stopped play.

Press [▶ DVD/CD] to start play from that position.

- The position is cleared when you:
 - Turn the unit off.
 - Select another source or open the disc tray.
- Press [■] to clear the position.

DVD-V

The following message appears immediately after you press [▶ DVD/CD] when “RESUME” is displayed. Press [▶ DVD/CD] while the message is displayed and the beginning portions of each chapter up to the current one are played.

Full play resumes from the point where you pressed [■] or [SHIFT]+[P.MEMORY].

(This feature works only within a title.)

If you do not press [▶ DVD/CD], the message disappears and play starts from where you pressed [■] or [SHIFT]+[P.MEMORY].

Discs—Convenient functions

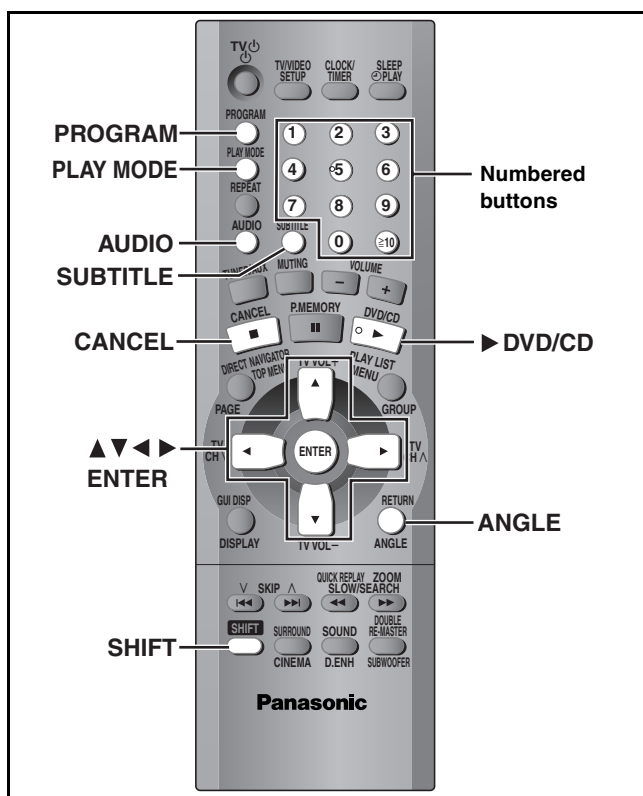

Common procedures for all group and random play

While stopped

Press [PLAY MODE].

Each time you press the button:

All group (DVD-A) → Random
 ↑ Off (Normal play) ←

All group play

DVD-A

Press [▶ DVD/CD].

GROUP ALLRandom Play

Random play

DVD-A DVD-V VCD CD

1 DVD-A DVD-V

Press the numbered buttons to select a title or a group.

Example: DVD-V

DVD-A

- You can select more than one group.
- To enter all groups, select "All" using [◀, ▶] and press [ENTER].
- To deselect a group, press the numbered buttons corresponding to the group you want to clear.

2 Press [▶ DVD/CD].

DVD-A DVD-V VCD CD WMA MP3

You can select up to 24 items to play in the order you choose.

1 While stopped

Press [PROGRAM].

Example: DVD-V

2 Press the numbered buttons to select a title, chapter, group or track (WMA MP3) then press [ENTER].

• To select a 2-digit number

Example: To select item 25, press [≥10] → [2] → [5].
 WMA MP3: [2] → [5] → [ENTER]

• Repeat this step to program other items.

• To select an item using the cursor buttons

Press [ENTER] and [▲, ▼] to select an item, then press [ENTER] again to register the number.

All the items in the selected disc, title or group are selected when you select "ALL".

3 Press [▶ DVD/CD].

To add or change the program

Press [▲, ▼] to select an available item, then repeat step 2.

To clear an item

- Select the item you want to clear with [▲, ▼].
- Press [SHIFT]+[CANCEL], or select "Clear" with [▲, ▼, ▶, ◀] and press [ENTER].

To clear the whole program

Select "Clear all" with [▲, ▼, ▶, ◀] and press [ENTER].

Note

DVD-V WMA MP3

Times are not displayed while programming.

• The program is cleared when you switch the unit to standby, open the disc tray or select another source.

Note

• DVD-A If you select bonus groups, you will have to enter a password (⇒ page 15).

• Disable HighMAT disc play to use random and program play. In the SETUP menu, set "HighMAT" to "Disable" (⇒ page 30) and perform the necessary operations (⇒ above).

- “—” or “—” is displayed instead of the language number in circumstances such as when no language is recorded on the disc.

VCD (SVCD only)

Soundtrack and subtitle numbers may change even if corresponding soundtracks are not recorded.

Soundtracks

RAM DVD-A DVD-V VCD

(Discs with multiple soundtracks)

During play

Press **[AUDIO]**.

The number changes each time you press the button.

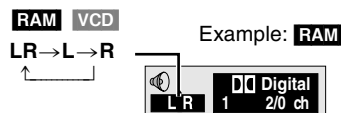
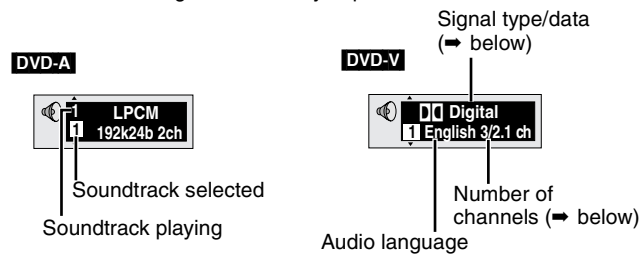

- You can also use this button to turn the vocals on and off on karaoke discs. Read the disc's instructions for details.

DVD-A

- Play restarts from the beginning of the soundtrack when changing soundtracks that are accompanied by still pictures.

- Even if a second soundtrack isn't recorded, two soundtrack numbers will normally be shown when you press [AUDIO]. The soundtrack currently playing is number 1.

Signal type/data

LPCM/PPCM/Digital/DTS: Signal type

k (kHz): Sampling frequency

b (bit): Number of bits

ch (channel): Number of channels

Example:

3/2 .1ch

.1: Low frequency effect (not displayed if there is no signal)
0: No surround 1: Mono surround 2: Stereo surround (left/right)
1: Center 2: Front left+Front right 3: Front left+Front right+Center

Subtitles

DVD-A (Motion picture parts only)

DVD-V

VCD (SVCD only)

(Discs with multiple subtitle languages)

You can change the subtitle language and turn the subtitles on and off.

RAM

You can turn the subtitles on and off.

During play

Press **[SUBTITLE]**.

The number changes each time you press the button.

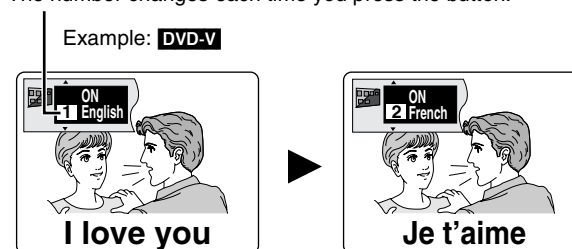

- In some cases, the subtitle language is not changed to the selected one immediately.
- If the subtitles overlap closed captions recorded on discs, turn the subtitles off.

To clear/display the subtitles

- 1 Press [SUBTITLE].
- 2 Press [▶]. (**DVD-A DVD-V VCD**)
- 3 Press [▲, ▼] to select "OFF" or "ON".

Changing the position and brightness of the subtitles (→ page 25)

Angles

DVD-A DVD-V

During play

Press **[SHIFT]+[ANGLE]**.

The angle changes each time you press the buttons.

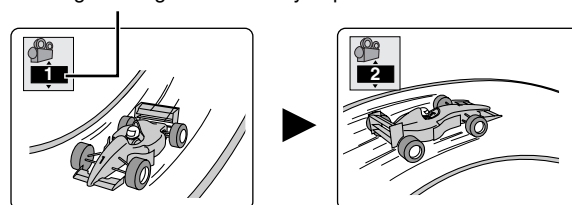

Discs—Convenient functions

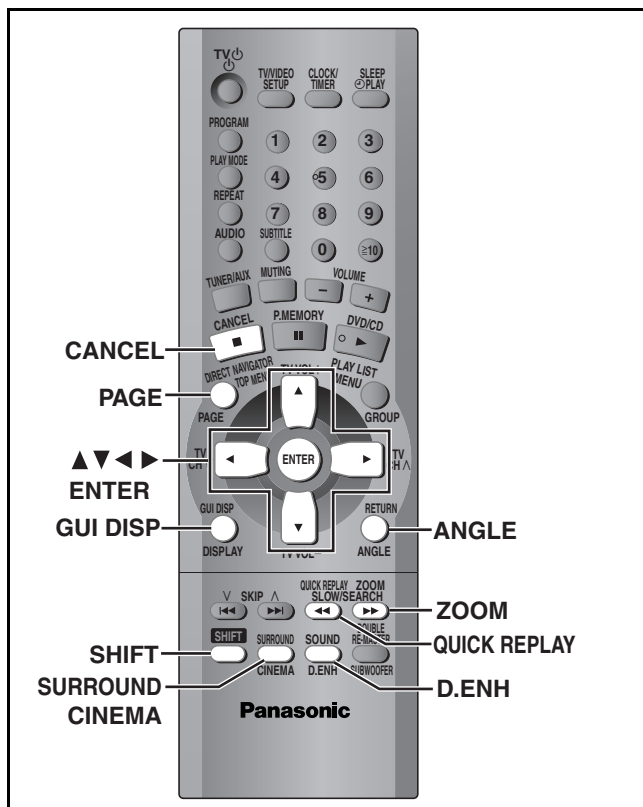

Marking places to play again

RAM DVD-A DVD-V VCD CD WMA MP3 JPEG

You can mark a position so you can return to it easily at a later time.

- 1 During play
Press **[GUI DISP]** until the unit information screen is displayed (⇒ page 24).
- 2 Press **[▲, ▼]** to select the play menu.
Example: **DVD-V**  Marker
- 3 Press **[◀, ▶]** to select “Marker” and press **[ENTER]**.
RAM
Press **[▶]** to select an asterisk (*).
- 4 Press **[ENTER]** at the point you want to mark.

To mark another position

Up to 5 points (**RAM** only: up to 999 points)

- 1 Press **[▶]** to select “*”.
- 2 Press **[ENTER]** at the point.

To recall or erase a marker

- 1 Press **[◀, ▶]** to select a marker.
- 2 Press **[ENTER]** to recall or press **[SHIFT]+[CANCEL]** to erase.

RAM

To mark the eleventh point and beyond

- 1 Press **[◀, ▶]** to select the marker pin icon.

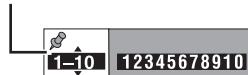

- 2 Press **[▲, ▼]** to select “11–20”.
You can select the next group when the current group is full.

Note

Markers added with this unit clear when you switch the unit to standby, change the source, or open the disc tray.

Variable Zoom function

RAM DVD-V VCD

DVD-A (Motion picture parts only)

Change the zoom ratio so the picture expands to the optimum size to fill the screen.

Preparation

Change the setting “TV Aspect” to suit your television (⇒ page 30).

During play

Press **[SHIFT]+[ZOOM]** to select the aspect ratio.

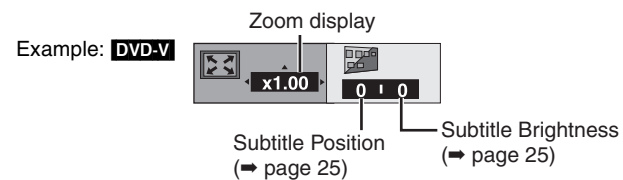

Each time you press the buttons:

4:3 Standard → **European Vista** → **16:9 Standard**

↑ **Cinemascope2** ← **Cinemascope1** ← **American Vista** ↓

- Refer to the disc’s instructions and “Screen size” below for the aspect ratio of the picture.

To restore the original ratio

Press **[SHIFT]+[ZOOM]** until the ratio returns to 1.00.

- The ratio also returns to 1.00 when you open the disc tray, change the source or switch the unit to standby.
- The ratio may return to 1.00 when a menu is displayed.

Making fine adjustments to the zoom ratio

While the ZOOM icon is displayed

Press **[▲, ▼]**.

The ratio changes in 0.01 units between 1.00 and 1.60 and in 0.02 units between 1.60 and 2.00.

Screen size

Movies are made using a variety of screen sizes.

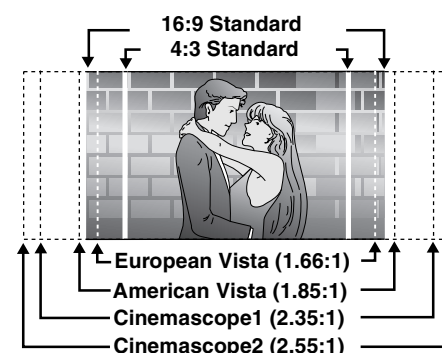

RAM DVD-A DVD-V VCD CD WMA MP3

(only for 2 or more channels)

Enjoy a surround-like effect when using 2 front speakers (SP) or headphones (HP). The effect broadens when playing discs with surround effects and sound seems to come from speakers on either side of you.

Press [SURROUND].

Each time you press the button:

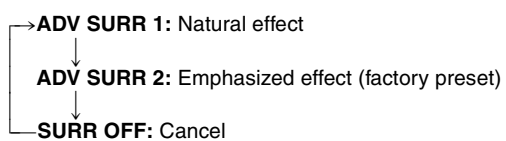

- Use the Audio Menu (➡ page 24) to change the SP/HP mode.
- This feature also works when you select "TUNER" or "AUX" as the

Navigation menus

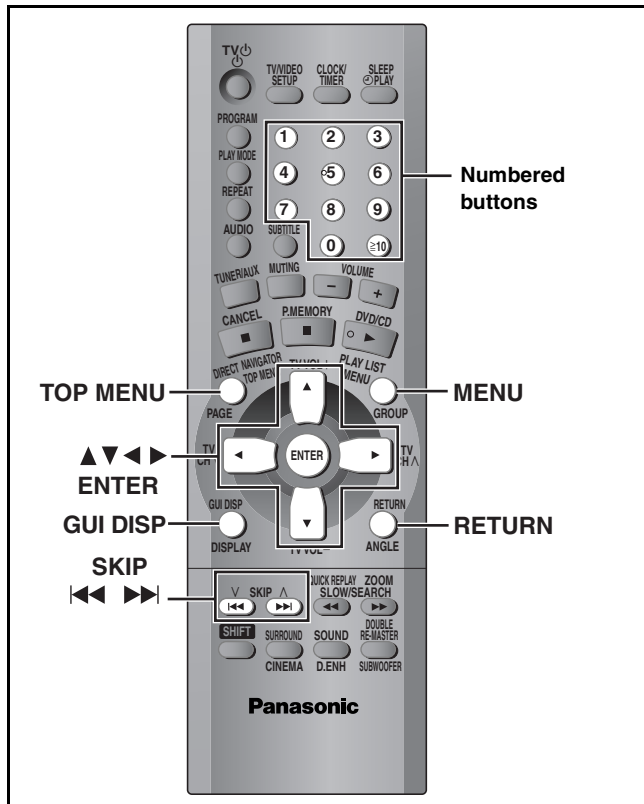

Playing WMA/MP3/JPEG and CD text

If the disc contains both audio data (WMA and MP3) and JPEG, check "Mixed Disc—Audio & Stills" setting in the SETUP menu (→ page 30). Select "Stills (JPEG)" to play JPEG or "Audio (MP3/WMA)" to play WMA/MP3.

CD (CD text only) **WMA** **MP3** **JPEG**

These menus help you find items to play.

1 Press [TOP MENU].

Example: **MP3**

Audio navigation menu

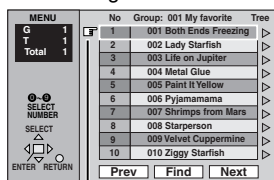

"P" indicates the track currently playing.

Example: **JPEG**

Album display

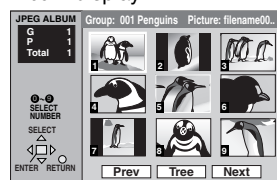

2 Press [▲, ▼] to select a track or [▲, ▼, ◀, ▶] to select a picture, and press [ENTER].

To show other pages, press [▲, ▼, ◀, ▶] to select "Prev" or "Next" and press [ENTER].

- After listing all the tracks in one group or pictures, the list for the next group appears.

To exit the audio navigation menu/album display

Press [TOP MENU].

Track title search **CD** (CD text only) **WMA** **MP3**

Example: finding a track including the word "LOVE"

1 While the menu is displayed

Press [▲, ▼] to select "Find" and press [ENTER].

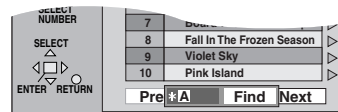

2 Press [▲, ▼] to select "L" and press [ENTER].

Characters change in alphanumeric order each time you press [▲].

Repeat this step to enter "O", "V", and "E".

- Press [◀, ▶] to skip between A, E, I, O, and U.
- Only uppercase appear but the search also includes lower case.
- Press [◀] to erase a character.
- You can erase the asterisk (*) to search for the first word in a title.
- You can enter numbers with the numbered buttons.

3 Press [▶] to select "Find" and press [ENTER].

The search results screen appears.

4 Press [▲, ▼] to select the track and press [ENTER].

To return to the navigation menu

Press [RETURN].

To use the tree screen to find a group **WMA** **MP3** **JPEG**

1 While the menu is displayed

WMA **MP3**

Press [▶] while a track is highlighted to display a tree screen.

JPEG

Press [▲, ▼, ◀, ▶] to select "Tree" and press [ENTER].

Example: **MP3**

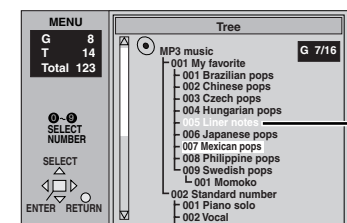

You cannot select groups that contain no compatible files.

2 Press [▲, ▼, ◀, ▶] to select a group and press [ENTER].

The audio navigation menu/album display for the group appears.

To return to the audio navigation menu/album display

Press [RETURN].

To use the contents screen to find a track

CD (CD text only)

You can use the text information recorded on these discs to find a track to play.

- 1 While the menu is displayed
Press [▶] while a track is highlighted to display the contents screen.

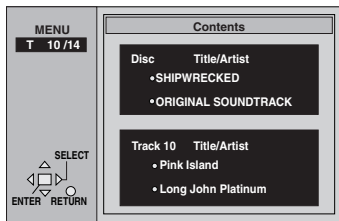

- 2 Press [◀, ▶] to move through the tracks and press [ENTER].

To return to the navigation menu

Press [RETURN].

See page 34 for details about WMA/MP3/JPEG and CD text .

Playing HighMAT discs

A menu appears after you insert the disc.

Press [▲, ▼, ◀, ▶] to select then press [ENTER].

When you press [ENTER]:



Menu: Takes you to the next menu which shows play lists or another menu



Play list: play starts

- To return to the menu screen
Press [TOP MENU].
- To return to the menu above the current one
Press [RETURN].
- To change the menu background
Press [GUI DISP].
The background changes to the one recorded on the disc.

Selecting from the lists

- 1 While playing
Press [MENU].



- 2 Press [◀] then [▲, ▼] to switch between the play list, group and content lists.
- 3 Press [▶] then [▲, ▼] to select an item and press [ENTER].

To exit the list screen

Press [MENU].



HighMAT and the HighMAT logo are either trademarks or registered trademarks of Microsoft Corporation in the United States and/or other countries.

Playing the programs or play lists on DVD-RAM

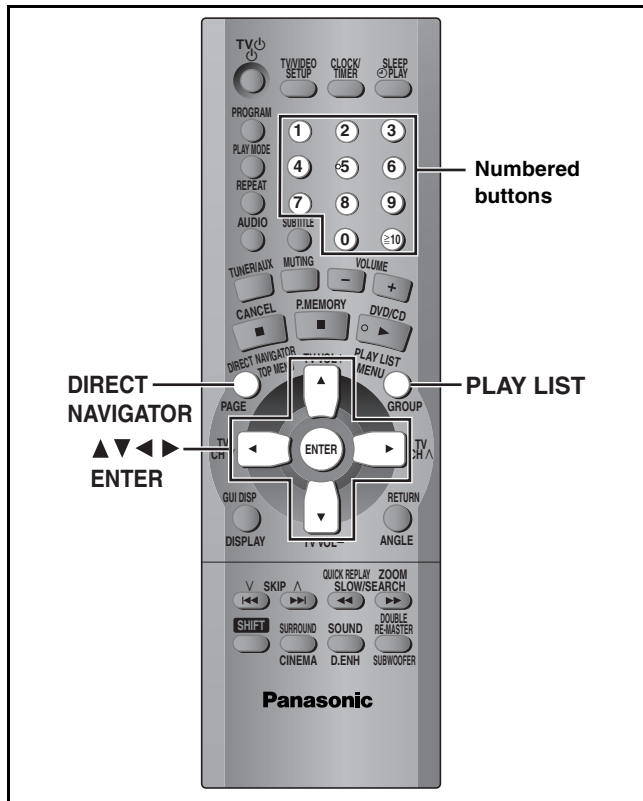

RAM

Selecting a program to play —DIRECT NAVIGATOR

Use the program list to find programs to play.

1 Press [DIRECT NAVIGATOR].

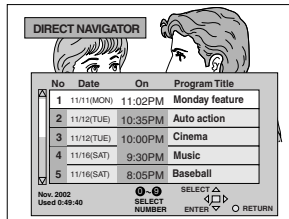

2 Press [▲, ▼] to select the program.

The selected program plays in the background.

- You can select programs with the numbered buttons.

To select a 2-digit number

Example 23: [≥10] → [2] → [3]

3 Press [ENTER].

The program being played in the background continues.

To clear the program list

Press [DIRECT NAVIGATOR].

Note

- Titles appear only if you have entered them.
- You cannot change program and disc titles.

Using the play list menu

You can play a group of scenes, a play list, created on other equipment such as a DVD video recorder.

1 Press [PLAY LIST].

No.	Date	Length	Title
1	10/17	0:46:35	Clay Penguin
2	10/24	0:09:15	Ashley at Prom
3	11/29	0:12:32	Formula one
4	12/22	0:07:30	Soccer
5	12/23	0:30:20	Baseball
6	12/23	0:08:15	Neanderthal
7	12/24	0:15:30	Cartoons
8	12/24	0:20:30	Trilobites
9	12/25	0:20:00	White Dwarf
10	12/25	0:55:00	Discovery

2 Press [▲, ▼] to select the play list.

- You can select play lists with the numbered buttons.

To select a 2-digit number

Example 23: [≥10] → [2] → [3]

3 Press [ENTER] to start play.

To clear the play list screen

Press [PLAY LIST].

Using On-Screen Menu Icons

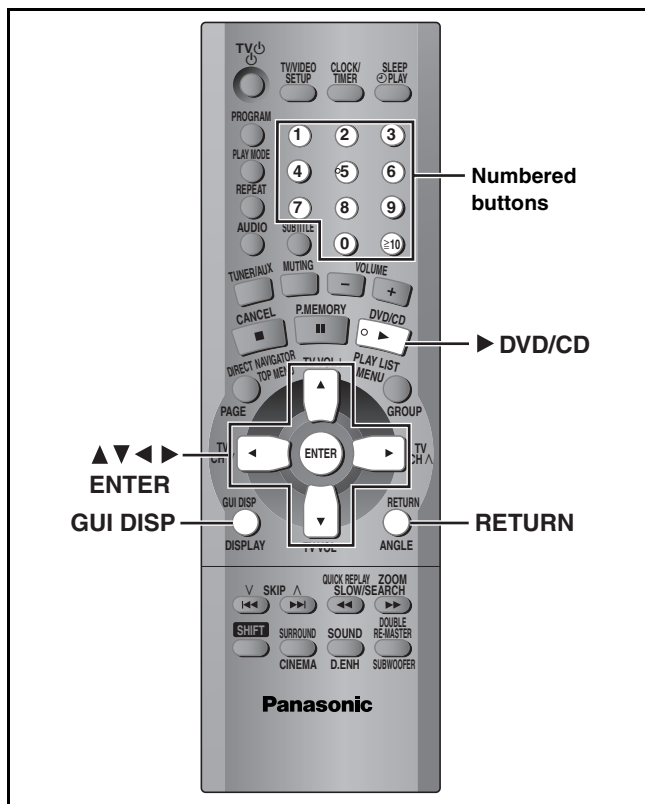

RAM DVD-A DVD-V VCD CD WMA MP3 JPEG

On-Screen Menu Icons are menus that contain information about the disc or unit. These menus allow you to perform operations by changing this information.

Common procedures

1 Press [GUI DISP].

Each time you press the button:

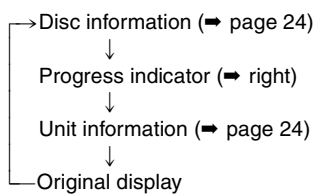

2

Unit information only

While the leftmost icon is highlighted

Press [**▲**, **▼**] to select the menu.

Each time you press the button:

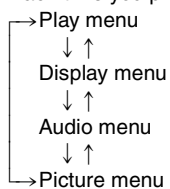

3

Press [**◀**, **▶**] to select the item.

4 Press [**▲**, **▼**] to select the setting.

- Items with “▲” or “▼” above and below can be changed by [**▲**, **▼**].
- Press [ENTER] if the setting does not change after pressing [**▲**, **▼**].
- Some items require different operations. Read the explanations on the following pages.

For your reference

• Depending on the condition of the unit (playing, stopped, etc.) and the type of software you are playing, there are some items that you cannot select or change.

• When numbers are displayed (e.g. title No.), the numbered buttons are also effective for setting. After entering the numbers, press [ENTER] to register the setting.

To clear the menus

Press [RETURN] until the menus disappear.

■ To change the position of the icons

- 1 Press [**◀**, **▶**] to select the rightmost icon.
- 2 Press [**▲**, **▼**] to move the icons. (There are 5 positions.)

Progress indicator

Indicates how far you have played through an item.

Example: **DVD-V**

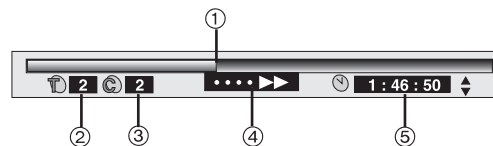

- ① **Current position** RAM DVD-A DVD-V VCD CD WMA MP3
- ② **PG: Program number** RAM
PL: Play list number RAM
T: Title number DVD-V
Track number VCD CD
G: Group number DVD-A WMA MP3 JPEG
- ③ **T: Track number in group** DVD-A WMA MP3
C: Chapter number DVD-V
P: Picture number JPEG
- ④ **Condition – play, pause, or slow/search**
RAM DVD-A DVD-V VCD CD WMA MP3
Play speed (⇒ below)
- ⑤ **Changing the time display** RAM DVD-A DVD-V VCD CD
Press [**▲**, **▼**] to show the elapsed play time or remaining time for the program, play list, track or title (or chapter during program and random play).
Elapsed play time VCD (SVCD only) WMA MP3
(display only, cannot be changed)

Changing play speed

DVD-V (Dolby Digital only)

You can slow down or speed up play.

During play

Press [**◀**] (slower) or [**▶**] (faster).

There are five speeds:

×0.8 ↔ ×0.9 ↔ ×1.0 (normal speed) ↔ ×1.2 ↔ ×1.4

• After you change the speed:

- Output is in stereo,
- Advanced surround does not work,
- Digital output switches to PCM.

• Sound is stereo as long as “×1.0” is orange.

To return to normal play

Press [**▶** DVD/CD] or [ENTER].

Normal play is also restored when you return the speed to ×1.0 and clear the progress indicator.

Using On-Screen Menu Icons

Unless otherwise indicated, select items with [◀, ▶] and change with [▲, ▼].

Disc information

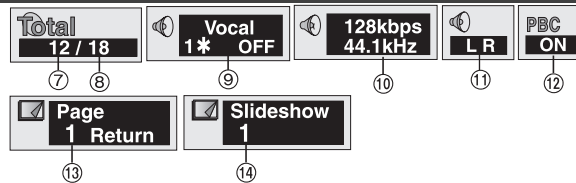
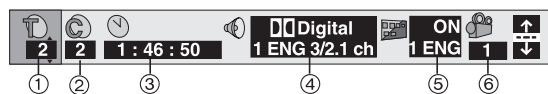

Disc operations

①	PG: Program number RAM PL: Play list number RAM G: Group number DVD-A WMA MP3 JPEG T: Title number DVD-V Track number VCD CD	[▲, ▼] ↓ [ENTER]
②	T: Track number in group DVD-A WMA MP3 C: Chapter number DVD-V P: Picture number JPEG	
③	Time RAM DVD-A DVD-V Select a position to start play by specifying a time.	Numbered buttons ↓ [ENTER]
③	Changing the time display RAM DVD-A DVD-V VCD CD VCD (SVCD only) WMA MP3 : Display only → Elapsed play time for the program, play list, title or track ↓ ↑ Remaining time for the group (DVD-A) or disc (VCD CD) ↓ ↑ → Remaining time for the program, play list, title or track	
④	Soundtrack DVD-A DVD-V (⇒ page 17)	
⑤	Subtitle language DVD-A DVD-V VCD (SVCD only) (⇒ page 17) Subtitles on/off RAM DVD-A DVD-V VCD (SVCD only) Track information on/off CD (CD text only) WMA MP3 Picture information JPEG Full: Group title, picture title, picture size, file size, date of shooting, and camera model used*. Date: Date of shooting only. OFF: No display. * Actual displays depend on the camera and data.	
⑥	Angle number DVD-A DVD-V (⇒ page 17) Rotating pictures JPEG (⇒ page 19) 0 ↔ 90 ↔ 180 ↔ 270 ↑ ↓	

⑦	Track/picture number in disc WMA MP3 JPEG	[▲, ▼] ↓ [ENTER]
⑧	Total number of tracks/pictures on disc WMA MP3 JPEG	Display only
⑨	Karaoke vocal on/off DVD-V (Karaoke DVD only) If a DVD title is a duet, select V1 or V2 to duet with the unit.	
⑩	Current bitrate (kbps) Current sampling frequency (kHz) WMA MP3	Display only
⑪	Audio mode RAM VCD LR ↔ L ↔ R ↑ ↓	
⑫	Menu play VCD (with playback control only)	Display only
⑬	Still picture number DVD-A ● To return to page 1 [◀, ▶] → Select "Return" → [ENTER]	
⑭	Slideshow DVD-A Picture number	Display only
⑭	Slideshow setting on/off JPEG Slideshow timing JPEG 0 – 30 sec	

Audio/Subtitle language

ENG: English FRA: French DEU: German ITA: Italian ESP: Spanish NLD: Dutch	SVE: Swedish NOR: Norwegian DAN: Danish POR: Portuguese RUS: Russian JPN: Japanese	CHI: Chinese KOR: Korean MAL: Malay VIE: Vietnamese THA: Thai *: Others
--	---	--

Unit information

Play menu

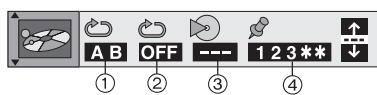

①	A-B repeat (⇒ page 15) RAM DVD-A DVD-V VCD CD WMA MP3	[ENTER]
②	Repeat mode (⇒ page 15) RAM DVD-A DVD-V VCD CD WMA MP3 JPEG	
③	Play mode (⇒ page 16) DVD-A DVD-V VCD CD WMA MP3 ---: Normal play PGM: Program play RND: Random play ALL: All group play (DVD-A)	Display only
④	Marker RAM DVD-A DVD-V VCD CD WMA MP3 JPEG	⇒ page 18

Audio menu

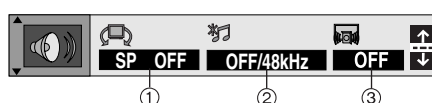

①	Advanced surround (VSS) (⇒ page 19) RAM DVD-A DVD-V VCD CD WMA MP3 ● VSS mode SP ↔ HP ● SP/HP level 1 ↔ 2 ↔ OFF ↑ ↓	
②	Double re-master (⇒ page 27) RAM DVD-A DVD-V CD WMA MP3	
③	Dialogue enhancer on/off (⇒ page 19) DVD-V	

Display menu

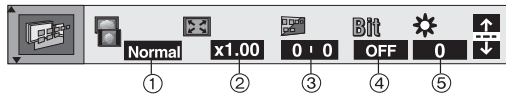

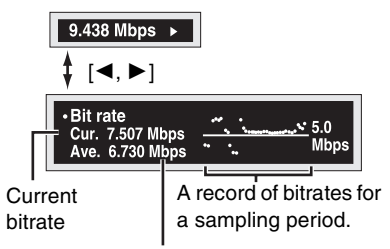
①	4:3 Aspect RAM DVD-A DVD-V VCD JPEG Select how to show images made for 4:3 aspect screens on a 16:9 aspect television. Normal: laterally stretches images made for a 4:3 screen. Auto: expands suitable 4:3 letterbox images to fill more of the screen. Other images appear in full in the center of the screen. Shrink: images appear in the center of the screen. Zoom: expands all images to fill the screen. If your television has a similar feature, use it instead for a better effect.
②	Zoom (⇒ page 18) RAM DVD-A DVD-V VCD [ENTER] ↓ [◀, ▶] ↓ [ENTER] ----- Making fine adjustments to the zoom ratio
③	Subtitle position/Subtitle brightness DVD-A DVD-V • Position (0 to -60): in 2 unit steps • Brightness (Auto*/0 to -9) * The brightness adjusts automatically against the background.
④	Bitrate display on/off RAM DVD-A DVD-V VCD During play: shows the bitrate (approximate values) of the video being played While paused: shows the data volume of the frame and type of picture (⇒ page 34, Glossary—I/P/B) To change the bitrate display:  Current bitrate Average bitrate A record of bitrates for a sampling period.
⑤	OSD brightness (-3 to +3) Adjust the brightness of the on-screen displays.

Picture menu

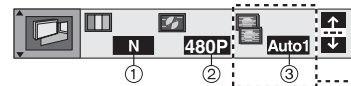

①	Picture mode (⇒ page 19, Cinema) RAM DVD-A DVD-V VCD JPEG N: Normal mode S: Soft mode (Soft picture with fewer video artifacts) F: Fine mode (Details are sharper) C1: Mellows images and enhances detail in dark scenes C2: Sharpens images and enhances detail in dark scenes U1/U2: User mode (⇒ below)
②	Video output mode RAM DVD-A DVD-V VCD JPEG 480I: Interlace video 480P: Progressive video (“PROGRESSIVE” appears on the display.) • You can change the video output mode only when “Progressive Out (Component)” in the Video menu is set to “Enable” (⇒ page 30). • When progressive output is on, closed captions will not be displayed.
③	Transfer mode RAM DVD-A DVD-V VCD Select the method of conversion for progressive output to suit the type of material being played. Auto 1 (normal): for viewing film material Auto 2: for viewing film material (the same as Auto 1, but able to convert 30-frame-per-second progressive video) Video: for video material

To change the user mode

- Select User mode and press [▶] to highlight the number.
- Press [▲, ▼] to select “1” or “2”.

U1

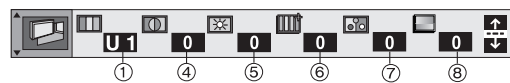

④	Contrast (-7 to +7) Increases the contrast between light and dark parts of the picture.
⑤	Brightness (0 to +15) Brightens the picture.
⑥	Sharpness (-7 to +7) Adjusts the sharpness of the edges of the horizontal lines.
⑦	Color (-7 to +7) Adjust the shade of the picture's color.
⑧	Gamma (0 to +5) Adjust the emphasis of outlines.

U2

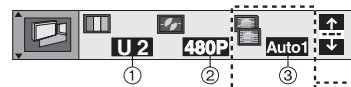

①-③ (⇒ above)

Only when “PROGRESSIVE” is on

The radio

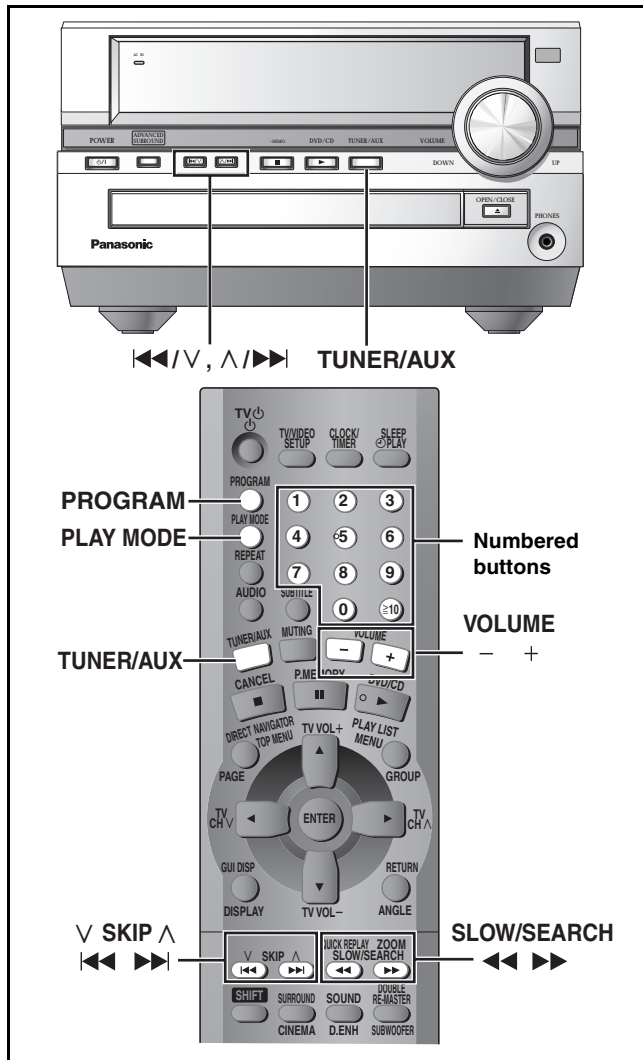

Manual tuning

- 1 Press [TUNER/AUX] to select “FM” or “AM”.

Each time you press the button:

FM → AM → AUX

- 2 Press [◀◀] or [▶▶] to select the frequency of the desired station.

TUNED: Displayed when a radio station is tuned.

ST: Displayed when a stereo FM broadcast is being received.

Press and hold [◀◀] or [▶▶] until the frequency starts scrolling to start automatic tuning. Tuning stops when a station is found.

• You can also use [◀◀/V] or [▶▶/∧] on the main unit.

- 3 Adjust the volume.

■ If noise is excessive in FM
Press and hold [PLAY MODE] to display “MONO”.

Press and hold [PLAY MODE] again to cancel the mode.
The mode is also canceled when you changed the frequency.

FM frequency step (Main unit only)

The step is factory-set to 0.2 MHz, but you can change it to receive broadcasts allocated to 0.1 MHz steps.

- 1 Press [TUNER/AUX] to select “FM”.

- 2 Press and hold [TUNER/AUX].

After a few seconds the display changes to show the current minimum frequency. Continue to hold the button down. The minimum frequency changes and the step is changed.

To return to the original step, repeat the above steps.

Note

Any FM frequencies preset in channels will be changed by this procedure. Preset the gain.

Preset tuning

Preset channels to make selection simple.

Up to 15 stations can be set in the FM and AM bands.

Automatic presetting

- 1 Tune to “FM 87.9” or “FM 87.5” (→ left).

- 2 Press and hold [PROGRAM].

Release the button when “AUTO” is displayed.

The tuner presets all the stations it can receive into the channels in ascending order.

When finished, the last station to be set is then played.

- 3 Tune to “FM 520”.

- 4 Press and hold [PROGRAM].

Manual presetting

- 1 Tune to the station (→ left).

- 2 Press [PROGRAM].

PROGR. M ch ← →

- 3 While “-” is flashing

Press the numbered buttons to select a channel.

The station occupying that channel is erased if another station is preset in that channel.

Selecting channels

- 1 Press [TUNER/AUX] to select “FM” or “AM”.

Each time you press the button:

FM → AM → AUX

- 2 Press the numbered buttons or [◀◀, V] or [▶▶, ∧] to select the channel.

To select a 2-digit number

Example: To select channel 12, press [≥10] → [1] → [2]

• You cannot select the channel with [◀◀/V] or [▶▶/∧] on the main unit.

Convenient functions

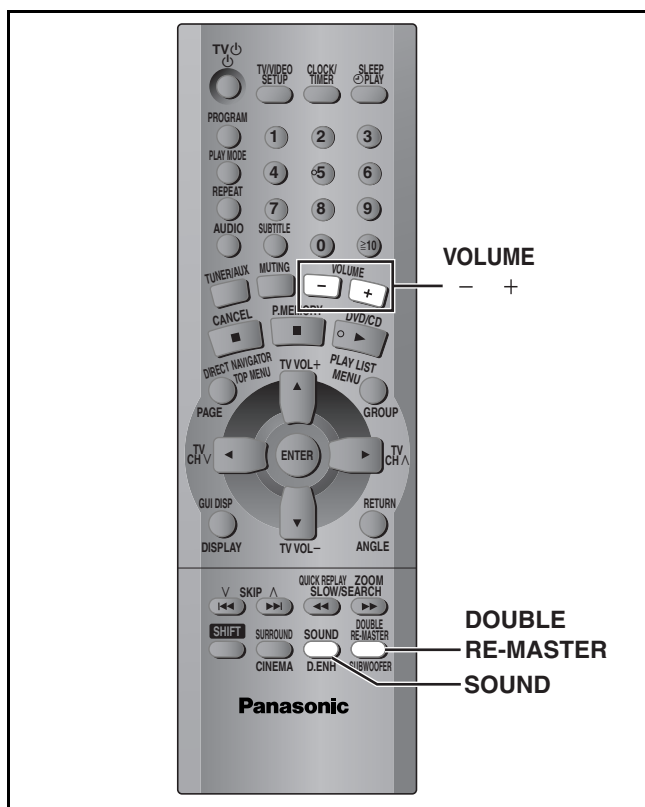

Double re-master—Enjoying more natural sound

RAM **DVD-A** **DVD-V** **CD**

Discs recorded with 2-channel LPCM at 44.1 kHz or 48 kHz
This feature gives you a more natural sound by adding the higher frequency signals not recorded on the disc.

WMA **MP3**

Discs recorded at 44.1 kHz or 48 kHz
This feature reproduces the frequencies lost during recording to give you a sound closer to the original.

During play

Press [**DOUBLE RE-MASTER**].



Output sampling frequency
Each time you press the button:

Setting	RAM DVD-A DVD-V CD Type of music	WMA MP3 Effect level
1	High tempo (e.g., pops and rock)	Light
2	Various tempos (e.g., jazz)	Medium
3	Low tempo (e.g., classical)	Strong
OFF	Off	Off

Note

The actual output sampling frequency depends on the PCM Digital Output setting (⇒ page 31) when using a digital connection (⇒ page 33).

Adjusting the bass and treble with manual equalizer

1 Press and hold [**SOUND**] to select “**MANUAL EQ**”.

MANUAL EQ

Each time you press and hold the button:
MANUAL EQ ↔ PRESET EQ

2 Press [**SOUND**] to select “**BASS**” or “**TREBLE**”.

BASS 0

Each time you press the button:
BASS → TREBLE → Original display

3 While displaying “**BASS**” or “**TREBLE**”
Press [**VOLUME**] to adjust the level (–4 to +4).

BASS +1

Using the built-in sound quality settings

1 Press and hold [**SOUND**] to select “**PRESET EQ**”.

PRESET EQ

Each time you press and hold the button:
MANUAL EQ ↔ PRESET EQ

2 Press [**SOUND**] to select a setting.

EQ → Heavy

Each time you press the button:
Heavy: Adds punch to rock (factory preset).
Clear: Clarifies higher sounds.
Soft: For background music.
Vocal: Makes vocals more alive.
OFF: Canceled (no effect is added).

Convenient functions

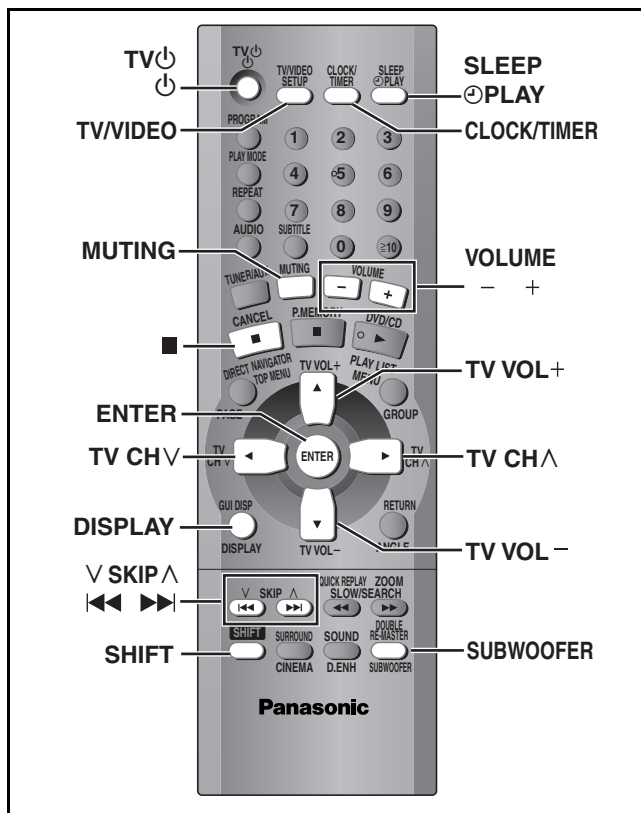

Enjoying more powerful bass

Preparation

- Connect an active subwoofer (not included). See below for connection.
- Place the subwoofer as close as possible to the front center.

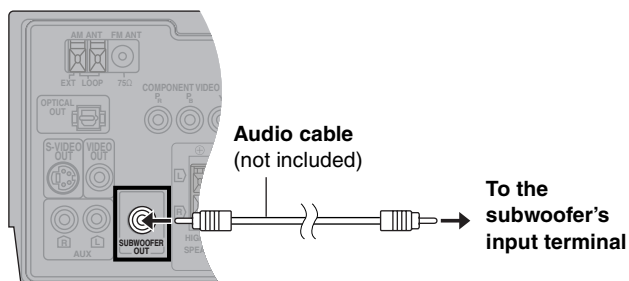

Adjusting the bass

Press **[SHIFT]+[SUBWOOFER]**.

SUB W MID

Each time you press the buttons:

SUB W LOW (factory preset) → SUB W MID → SUB W MAX

Adjust the volume on the subwoofer to suit your preference.

Note

When using headphones, the subwoofer should be switched off.

Muting the volume

Press **[MUTING]**.



Volume is reduced to minimum.

To cancel

Press **[MUTING]** again or reduce the volume to minimum (--- dB), then raise it to the required level.

Muting is also canceled when you switch the unit to standby.

Changing the display

You can display the time or dim the display.

Press **[SHIFT]+[DISPLAY]** until the display you want appears.

Each time you press the buttons:

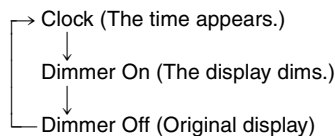

Note

The original display is restored when you:
— Turn the unit off.
— Select another source.

Operating a television

Face the remote control at the television for the following operations.

Turning the television on/off

Press **[SHIFT]+[TV]**.

Switching the television's video input mode

Press **[SHIFT]+[TV/VIDEO]**.

Changing channels

Press **[SHIFT]+[TV CH V]** or **[SHIFT]+[TV CH ^]**.

Adjusting the volume

Press **[SHIFT]+[TV VOL+]** or **[SHIFT]+[TV VOL-]**.

Note

Some models cannot be operated by this remote control.

The play timer

This timer starts play of the selected source at the selected time.

Preparation

Turn the unit on and set the time (⇒ page 11).

1 Press [CLOCK/TIMER] to select “⌚PLAY”.

⌚PLAY

Each time you press the button:
Clock → ⌚PLAY → Original display

2 Within 8 seconds

① Press [⏮, ∨] or [⏭, ∧] to select the start time.

ON ⌚AM 6:30

② Press [CLOCK/TIMER] or [ENTER].

3 ① Press [⏮, ∨] or [⏭, ∧] to select the finish time.

OFF ⌚AM 7:40

② Press [CLOCK/TIMER] or [ENTER].

4 ① Play the desired source.

To play an external source
⇒ page 33

To set only your favorite tracks/chapters
Start program play (⇒ page 16).

② Adjust the volume.

When playing a disc, press [■] to stop play before step 5.

5 Press [⌚PLAY].

TIMER-PLAY ⌚PLAY

6 Press [⏻] to turn the unit off.

The timer starts at the set time with the volume increasing gradually to the set level.

To cancel

Press [⌚PLAY] to clear “⌚PLAY”. The timer comes on at the set time everyday if the timer is on.

To check settings

(While the unit is off)

Press [CLOCK/TIMER].

The settings are displayed in the following order:

Start time → Finish time → Source → Volume

(While the unit is on)

Press [CLOCK/TIMER] until “⌚PLAY” appears on the display.

The start and finish times are displayed.

To change the settings

① Turn the unit on and press [⌚PLAY] to clear “⌚PLAY”.

② Do steps 1–6 again.

To enjoy the desired source after the timer setting is completed

① Turn the unit on and play the desired source.

② After playing, turn the unit off.

Even if you change the volume and source, the timer will start in these preset conditions.

If you select “AUX” as the source

Set the connected equipment’s timer to the same time. (See the instruction manual that came with the equipment.)

The sleep timer

This timer turns the unit off after a set time.

Press [SHIFT]+[SLEEP] to select the time (minutes).

SLEEP 30 SLEEP

Each time you press the button:

SLEEP 30 → SLEEP 60 → SLEEP 90

↑ SLEEP OFF ← SLEEP 120 ←

To cancel the timer

Press [SLEEP] to select “SLEEP OFF”.

To check the SLEEP setting

Press [SLEEP] once.

The remaining time appears.

To change the setting

Press [SLEEP] to display the remaining time, then press again to select the required time.

Note

The sleep timer can be used in combination with the play timer. The sleep timer always has priority. Be sure not to overlap timer settings.

Using headphones

1 Reduce the volume and connect the headphones (not included).

Headphone plug type: 3.5 mm (1/8”) stereo

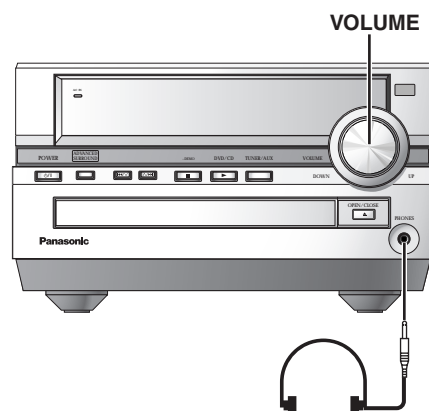

2 Adjust headphone volume with [VOLUME].





Audio is automatically switched to stereo (2-channel).

Note

Avoid listening for prolonged periods of time to prevent hearing damage.

Changing settings

This chart shows the settings for this unit. Change the settings to suit your preferences and to suit the unit to the environment in which it is being used. These settings are retained in memory until they are changed, even if the unit is turned off. See page 31 for details on menu operation.

Menus	Items	Options (Underlined items are the factory preset.)
 Disc	Audio Choose the preferred audio language.	<u>English</u> French Spanish Original Other ***** Original: The original language of each disc will be selected. Other *****: Input a code number with the numbered buttons (⇒ page 32).
	Subtitle Choose the preferred subtitle language.	<u>Automatic</u> English French Spanish Other ***** Automatic: If the language selected for "Audio" is not available, subtitles of that language will automatically appear if available on that disc.
	Menus Choose the preferred language for disc menus.	<u>English</u> French Spanish Other *****
	Ratings (⇒ page 31) Set a ratings level to limit DVD-Video play. • The password screen is shown if you choose levels 0 to 7 or if you choose "Ratings" when levels 0 to 7 have been selected. • Select "Level 0" to prevent play of discs that do not have ratings levels recorded on them.	Setting ratings (When level 8 is selected) 8 <u>No Limit</u> : All DVD-Video can be played. 1 to 7: Prohibits play of DVD-Video with corresponding ratings recorded on them. 0 <u>Lock All</u> : Prohibits play of all DVD-Video. <hr/> Changing ratings (When level 0–7 is selected) Unlock Player Change Password Change Level Temporary Unlock
 Video	TV Aspect (⇒ page 10) Choose the setting to suit your television and preference.	<u>4:3 Pan&Scan</u> 4:3 Letterbox 16:9
	Progressive Out (Component) Choose "Enable" to enable progressive output.	<u>Disable</u> Enable
	TV Type (⇒ page 10) Select to suit the type of television.	<u>Standard (Direct View TV)</u> CRT Projector LCD TV/Projector Projection TV Plasma TV
	Still Mode Specify the type of picture shown when paused.	<u>Automatic</u> Field Frame
	Black Level Control Change the black level of the picture if you connected a television through the COMPONENT VIDEO OUT terminals.	<u>Lighter</u> : when connected to a TV through the VIDEO OUT or S-VIDEO OUT terminal. <u>Darker</u> : when connected to a TV through the COMPONENT VIDEO OUT (Y/P _B /P _R) terminals.
 Audio	PCM Digital Output (⇒ page 31)	Off <u>Up to 48 kHz</u> Up to 96 kHz Up to 192 kHz
	Dolby Digital (⇒ page 31)	<u>Bitstream</u> PCM
	DTS Digital Surround (⇒ page 31)	<u>PCM</u> Bitstream
	Dynamic Range Compression (Dolby Digital only) Change the dynamic range for late night viewing.	<u>Off</u> On: For clear dialogue when listening at low volume.
	Audio during Search Choose whether to have sound during search.	<u>On</u> Off • This feature doesn't work for some discs.
 Display	Menu Language Choose the preferred language for these menus and the on-screen messages.	<u>English</u> Français Español
	On-Screen Messages Choose whether to show on-screen messages or not.	<u>On</u> Off
 Others	HighMAT Play HighMAT discs as HighMAT discs, or as regular WMA/MP3/JPEG discs. (Reload the disc for the setting to be effective.)	<u>Enable</u> : Play HighMAT discs as HighMAT discs. Disable: Play HighMAT discs as regular WMA/MP3/JPEG discs.
	Mixed Disc—Audio & Stills Select the type of file played on discs containing both JPEG and WMA/MP3. (Reload the disc for the setting to be effective.)	<u>Audio (MP3/WMA)</u> Stills (JPEG)
	DVD-Video Mode Select how to play pictures contained on some DVD-Audio. The setting returns to "Off" when you remove the disc, turn the unit off or change the source.	<u>Off</u> : DVD-Audio are played as DVD-Audio. On: DVD-Video contents found on DVD-Audio can be played.
	QUICK SETUP (⇒ page 10) Answer questions to make basic settings.	Yes <u>No</u>

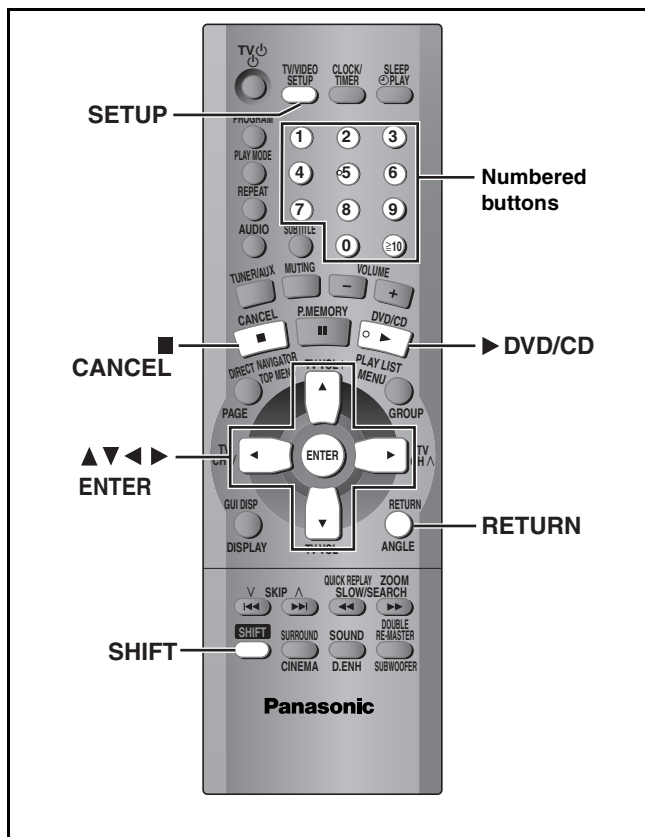

Common procedures

See page 30 for menu and option details.

Preparation

Press [▶ DVD/CD].

(When a disc is in the tray, press [▶ DVD/CD] and press [■].)

1 Press [SETUP] to show the menus.



2 Press [◀, ▶] to select the menu's tab.

The screen changes to display the menu.

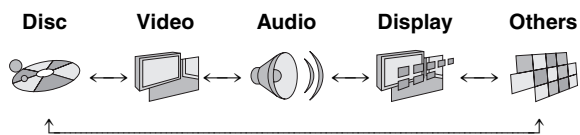

3 Press [▲, ▼] to select the item you want to change and press [ENTER].

4 Press [▲, ▼, ▶, ◀] to select the option and press [ENTER].

The screen now shows the menu option again.

To return to the previous screen

Press [RETURN].

When you are finished

Press [SETUP].

Entering a password (Ratings)

DVD-V

The password screen is shown when you select levels 0 to 7.

1 Input a 4-digit password with the numbered buttons and press [ENTER].

- If you enter a wrong number, press [SHIFT]+[CANCEL] to erase it before you press [ENTER].

- The lock symbol appears closed to show the rating is locked.

- **Do not forget your password.**

2 Press [ENTER] to confirm the 4 digits.

Now, when you insert a DVD-Video that exceeds the ratings limit you set, a message appears on the television. Follow the on-screen instructions.

Digital output

RAM DVD-A DVD-V VCD CD WMA MP3

Change the settings when you have connected equipment through this unit's OPTICAL OUT terminal.

PCM Digital Output

Select the maximum sampling frequency of PCM digital output. Check the digital input limitations of the equipment you connect.

Off: When not connected digitally

Up to 48 kHz (factory preset):

Signals over 48 kHz converted to 48 or 44.1 kHz

Up to 96 kHz: Signals over 96 kHz converted to 48 or 44.1 kHz

Up to 192 kHz: Signals up to 192 kHz are output

Note

- Signals from copy-protected discs are converted to 48 or 44.1 kHz irrespective of the setting.

- Some equipment cannot handle sampling frequencies of 88.2 kHz, even if they can handle 96 kHz. Read your equipment's operating instructions for details.

Dolby Digital and DTS Digital Surround

Bitstream (Factory preset for Dolby Digital):

Select if the equipment you connected can decode the signal.

PCM (Factory preset for DTS Digital Surround):

Select if the equipment you connected cannot decode the signal.

IMPORTANT

If the equipment you connected cannot decode the signal, the setting must be changed to PCM. If not, signals the equipment cannot process will be output by this unit, causing high levels of noise which can damage your hearing and the speakers.

Language code list

Abkhazian: 6566	Chinese: 9072	Hausa: 7265	Lithuanian: 7684	Romanian: 8279	Telugu: 8469
Afar: 6565	Corsican: 6779	Hebrew: 7387	Macedonian: 7775	Russian: 8285	Thai: 8472
Afrikaans: 6570	Croatian: 7282	Hindi: 7273	Malagasy: 7771	Samoan: 8377	Tibetan: 6679
Albanian: 8381	Czech: 6783	Hungarian: 7285	Malay: 7783	Sanskrit: 8365	Tigrinya: 8473
Ameharic: 6577	Danish: 6865	Icelandic: 7383	Malayalam: 7776	Scots Gaelic: 7168	Tonga: 8479
Arabic: 6582	Dutch: 7876	Indonesian: 7378	Maltese: 7784	Serbian: 8382	Turkish: 8482
Armenian: 7289	English: 6978	Interlingua: 7365	Maori: 7773	Serbo-Croatian: 8372	Turkmen: 8475
Assamese: 6583	Esperanto: 6979	Irish: 7165	Marathi: 7782	Shona: 8378	Twi: 8487
Aymara: 6588	Estonian: 6984	Italian: 7384	Moldavian: 7779	Sindhi: 8368	Ukrainian: 8575
Azerbaijani: 6590	Faroese: 7079	Japanese: 7465	Mongolian: 7778	Singhalese: 8373	Urdu: 8582
Bashkir: 6665	Fiji: 7074	Javanese: 7487	Nauru: 7865	Slovak: 8375	Uzbek: 8590
Basque: 6985	Finnish: 7073	Kannada: 7578	Nepali: 7869	Slovenian: 8376	Vietnamese: 8673
Bengali; Bangla: 6678	French: 7082	Kashmiri: 7583	Norwegian: 7879	Somali: 8379	Volapük: 8679
Bhutani: 6890	Frisian: 7089	Kazakh: 7575	Oriya: 7982	Spanish: 6983	Welsh: 6789
Bihari: 6672	Galician: 7176	Kirghiz: 7589	Pashto, Pushto: 8083	Sundanese: 8385	Wolof: 8779
Breton: 6682	Georgian: 7565	Korean: 7579	Persian: 7065	Swahili: 8387	Xhosa: 8872
Bulgarian: 6671	German: 6869	Kurdish: 7585	Polish: 8076	Swedish: 8386	Yiddish: 7473
Burmese: 7789	Greek: 6976	Laotian: 7679	Portuguese: 8084	Tagalog: 8476	Yoruba: 8979
Byelorussian: 6669	Greenlandic: 7576	Latin: 7665	Punjabi: 8065	Tajik: 8471	Zulu: 9085
Cambodian: 7577	Guarani: 7178	Latvian, Lettish: 7686	Quechua: 8185	Tamil: 8465	
Catalan: 6765	Gujarati: 7185	Lingala: 7678	Rhaeto-Romance: 8277	Tatar: 8484	

Optional antenna connections

Use outdoor antennas if radio reception is poor.

Note

Disconnect the antenna when the unit is not in use.
Do not use the outdoor antenna during an electrical storm.

AM outdoor antenna (Using a vinyl wire)

Run a piece of vinyl wire horizontally across a window or other convenient location.

5–12 m
(16–39 feet)

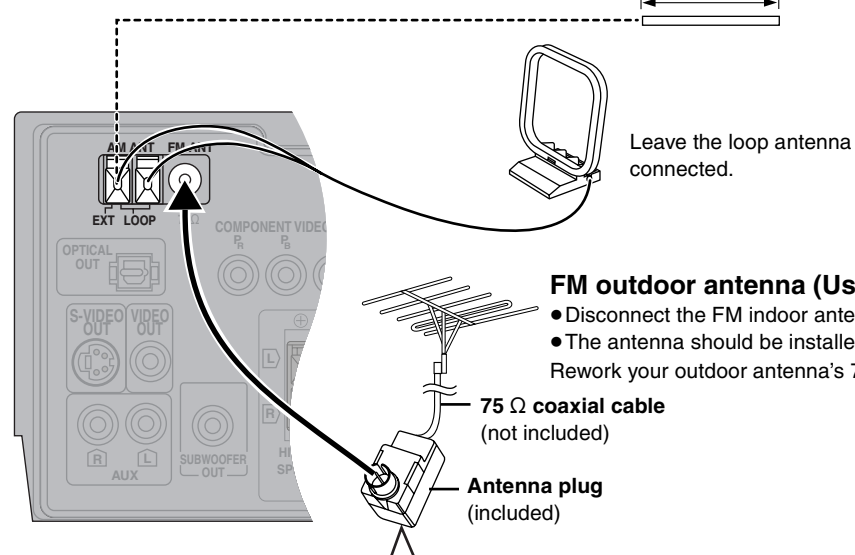

① Remove a piece of the outer vinyl insulator.

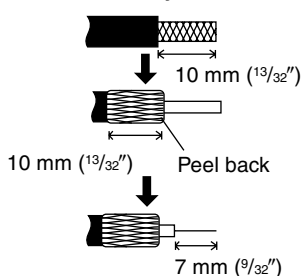

② Carefully pull the tabs apart to remove the cover.

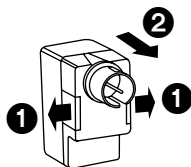

③ Install the coaxial cable. Clamp the cable conductor, and wind it on so that it does not contact anything else.

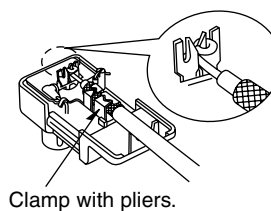

④ Attach the cover.

Using other equipment

Before connection

- Disconnect the AC power supply cord.
- Turn off all equipment and read the appropriate operating instructions.
- The equipment connections described are examples.
- Peripheral equipment and optional cables sold separately unless otherwise indicated.

Home Theater—Enjoying more powerful sound

Enjoy the powerful movie theater and hall-like sound available with multiple channel audio found on DVDs by connecting an amplifier and speakers.

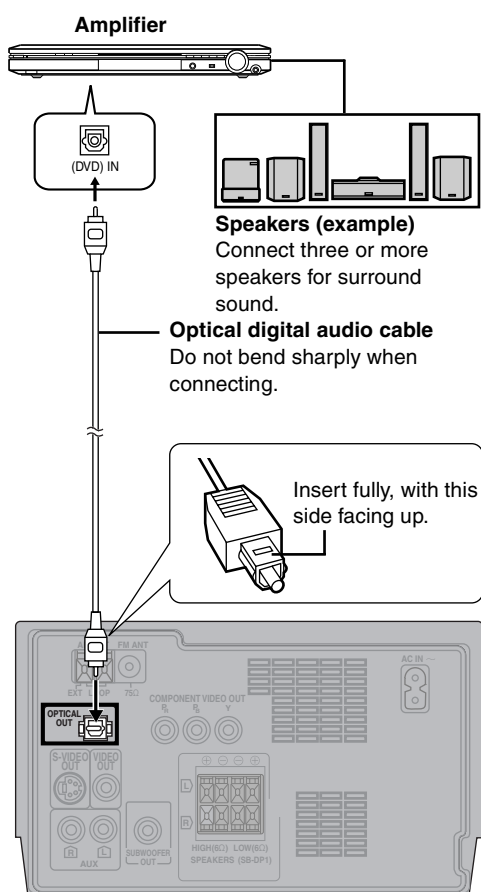

To enjoy multi-channel surround sound

Connect an amplifier with a built-in decoder or a decoder-amplifier combination.

Change the settings in "Digital output" (⇒ page 31).

- You can only use DTS Digital Surround decoders that are compatible with DVD.

Recording Output

- With DVD, the following conditions must be met: (a) the disc doesn't have protection preventing digital recording, and (b) the recording equipment can handle signals with a sampling frequency of 48 kHz.

- You cannot record WMA/MP3.

When recording DVDs, make the following settings.

- Advanced surround: OFF (⇒ page 19)
- PCM Digital Output: Up to 48 kHz (⇒ page 31)
- Dolby Digital/DTS Digital Surround: PCM (⇒ page 31)

Listening to an external source through this unit's speaker

You can playback the sound from a video cassette recorder, tape deck, laser disc player, etc., through this unit's speaker.

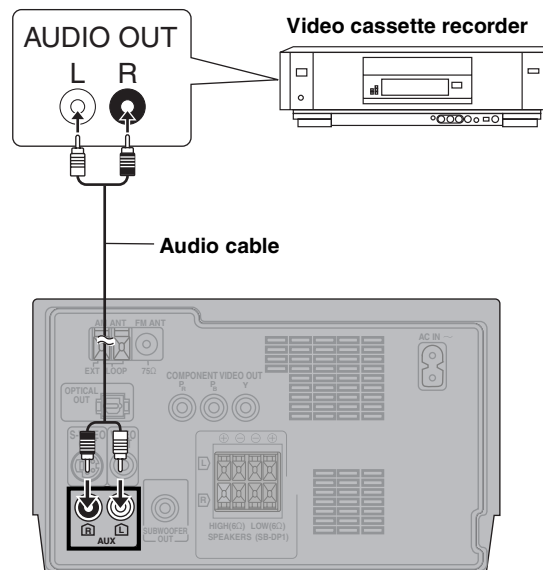

When connecting a record player

We recommend using a record player with a built-in phono equalizer. If your player doesn't have a built-in equalizer, connect it first to a separate equalizer and then connect that to this unit.

To playback

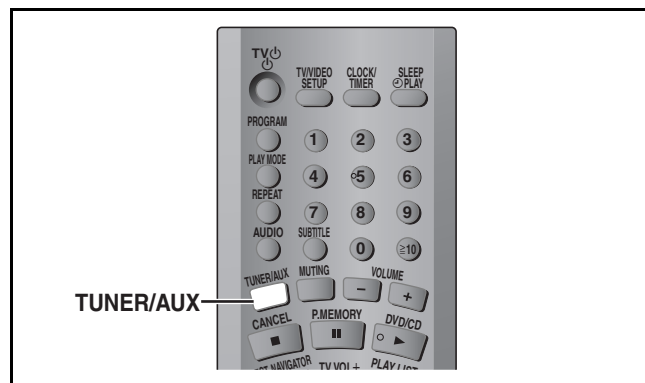

1 Press [TUNER/AUX] to select "AUX".

Each time you press the button:

FM → AM → AUX

2 Start play.

Glossary

Decoder

A decoder restores the coded audio signals on DVDs to normal. This is called decoding.

Dolby Digital

This is a method of coding digital signals developed by Dolby Laboratories. Apart from stereo (2-channel) audio, these signals can also be multi-channel audio. A large amount of audio information can be recorded on one disc using this method.

DTS (Digital Theater Systems)

This surround system is used in many movie theaters around the world. There is good separation between the channels, so realistic sound effects are possible.

Dynamic range

Dynamic range is the difference between the lowest level of sound that can be heard above the noise of the equipment and the highest level of sound before distortion occurs.

Film and video

DVD-Videos are recorded using either film or video. Usually, film is recorded at 24 frames per second, the rate movies are filmed at, while video is recorded at 30 frames per second.

Frame still and field still

Frames are the still pictures that go together to make a moving picture. There are about 30 frames shown each second. One frame is made up of two fields. A regular television shows these fields one after the other to create frames.

A still is shown when you pause a moving picture. A frame still is made up of two alternating fields, so the picture may appear blurred, but overall quality is high.

A field still is not blurred, but it has only half the information of a frame still so picture quality is lower.

Interlace and progressive output

NTSC, the video signal standard, has 480 interlaced (I) scan lines, whereas progressive scanning uses twice the number of scan lines. This is called 480P. The video signals output from this unit's COMPONENT VIDEO OUT terminals (Y, P_B, P_R) allow you to enjoy higher quality pictures than if the signals were output from the VIDEO OUT terminal or S-VIDEO OUT terminal.

I/P/B

MPEG 2, the video compression standard adopted for use with DVD-Video, codes frames using these 3 picture types.

I: Intra coded picture

This picture has the best quality and is the best to use when adjusting the picture.

P: Predictive coded picture

This picture is calculated based on past I or P-pictures.

B: Bidirectionally-predictive coded picture

This picture is calculated by comparing past and future I and P-pictures so it has the lowest volume of information.

Linear PCM (pulse code modulation)

These are uncompressed digital signals, similar to those found on CDs.

Playback control (PBC)

If a Video CD has playback control, you can select scenes and information with menus.

WMA/MP3/JPEG and CD text information

- Discs must conform to ISO9660 level 1 or 2 (except for extended formats).
- This unit is compatible with multi-session but if there are a lot of sessions it takes more time for play to start. Keep the number of sessions to a minimum to avoid this.
- The order tracks appear in the menus may differ to the order shown on your computer.

WMA

- Noise may occur when playing WMA files.
- You cannot play WMA files that are copy protected.

MP3

- This unit is not compatible with ID3 tags.
- If you play an MP3 track that includes still picture data, it will take some time before the music itself starts playing and the elapsed time will not be displayed during this time. Even after the track starts, the correct play time will not be displayed.

JPEG

- To view JPEG files on this unit:
 - Take them on a digital camera that meets the DCF (Design rule for Camera File System) standard.
 - Do not alter the files in any way or save them under a different name.
- This unit cannot display moving pictures, MOTION JPEG and other such formats, still pictures other than JPEG (i.e. TIFF) or play associated sound.

Order of play

WMA MP3 JPEG

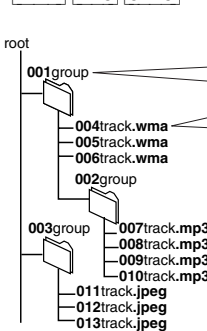

Naming folders and files

Prefix folder and file names with 3-digit numbers in the order you want to play them.

Extension

004track.wma (or .WMA)

The extension for MP3 is ".mp3" or ".MP3".

The extension for JPEG is ".JPG", ".jpg", ".JPEG" or ".jpeg".

CD (CD text only)

When making your own CD text discs

The unit plays the tracks in the order you record them so you do not have to prefix the titles with numbers.

MPEG Layer-3 audio decoding technology licensed from Fraunhofer IIS and Thomson multimedia.

Windows Media, and the Windows logo are trademarks, or registered trademarks of Microsoft Corporation in the United States and/or other countries.

WMA is a compression format developed by Microsoft Corporation. It achieves the same sound quality as MP3 with a file size that is smaller than that of MP3.



Specifications

AMPLIFIER SECTION

RMS Output Power both channel driven	
10 % total harmonic distortion	
1 kHz	(Low-channel) 25 W per channel (6 Ω)
8 kHz	(High-channel) 25 W per channel (6 Ω)
Total Bi-Amp power 50 W per channel	
Total RMS Stereo mode power 100 W	
Total RMS Dolby Digital mode power 100 W	
FTC Output Power both channel driven	
10 % total harmonic distortion	
60 Hz–3 kHz	(Low-channel) 20 W per channel (6 Ω)
3 kHz–16 kHz	(High-channel) 20 W per channel (6 Ω)
Total Bi-Amp power 40 W per channel	
Total FTC Power in Stereo mode (Band 10 % THD) 80 W	
Total FTC Power in Dolby Digital mode (Band 10 % THD) 80 W	
Input sensitivity/Input impedance	
AUX	250 mV, 19 kΩ

FM TUNER SECTION

Frequency range	
	87.9–107.9 MHz (200-kHz step)
	87.5–108.0 MHz (100-kHz step)
Sensitivity	
S/N 26 dB	2.5 μV(IHF)
	2.2 μV
Antenna terminals 75 Ω (unbalanced)	
Preset station 15	

AM TUNER SECTION

Frequency range 520–1710 kHz (10-kHz step)	
Sensitivity	
S/N 20 dB at 1000 kHz	560 μV/m
Preset station 15	

DISC SECTION

- Discs played [8 cm (3 ") or 12 cm (5 ")]:**
- (1) DVD-RAM (DVD-VR compatible)
 - (2) DVD-Audio
 - (3) DVD-Video
 - (4) DVD-R (DVD-Video compatible)
 - (5) CD-Audio (CD-DA)
 - (6) Video CD
 - (7) SVCD (Conforming to IEC62107)
 - (8) CD-R/CD-RW (CD-DA, Video-CD formatted discs)
 - (9) MP3/WMA
 - Maximum number of tracks and groups recognizable: 999 tracks and 99 groups
 - Compatible compression rate:
 - MP3: between 32 kbps and 320 kbps
 - WMA: between 48 kbps and 192 kbps
 - (10) JPEG
 - Exif Ver 2.1 JPEG Baseline files
 - Maximum number of pictures and groups recognizable: 3000 pictures and 300 groups
 - Picture resolution: between 320×240 and 6144×4096 pixels (sub sampling is 4:2:2 or 4:2:0)
 - (11) HighMAT Level 2 (Audio and Image)

Video

Signal system	NTSC
Output level	
Composite video 1 Vp-p (75 Ω)	
S-video	
Y output level	1 Vp-p (75 Ω)
C output level	0.286 Vp-p (75 Ω)
Component video (Y:green, P_B:blue, P_R:red)	
Y output level	1 Vp-p (75 Ω)
P _B output level	0.7 Vp-p (75 Ω)
P _R output level	0.7 Vp-p (75 Ω)

Audio

Sampling frequency	
CD	44.1 kHz
MP3	32 kHz, 44.1 kHz, 48 kHz
DVD (Linear Audio) 48 kHz, 96 kHz	
DVD-Audio 192 kHz	
Decoding 16/20/24 bit linear	
Number of channels Stereo	
Frequency response 20 Hz–20 kHz (+1, –2dB)	
Digital audio output	
Optical digital output Optical terminal	
Pick up	
Beam Source Semiconductor Laser	
Wavelength	
CD/VCD	780 nm
DVD	658 nm
Wow and flutter Less than possible measurement data	
D/A converter Delta sigma DAC	

SPEAKER SECTION

Type 2 way, 2 speaker system	
Speaker units	
Tweeter	6 cm (2 ³ / ₈ ") cone type 6 Ω
Woofer	10 cm (4") cone type 6 Ω
Input power	
	High 50 W (Music)
	Low 50 W (Music)
Output sound pressure level 81 dB/W (1.0 m)	
Crossover frequency 2.2 kHz	
Frequency range	
	47 Hz–32 kHz (–16 dB)
	64 Hz–31 kHz (–10 dB)
Dimensions (W×H×D)	
	158×276×280 mm
	(6 ⁷ / ₃₂ " × 10 ⁷ / ₈ " × 11 ¹ / ₃₂ ")
Mass 2.4 kg (5.3 lbs)	

GENERAL

Power supply	AC 120 V, 60 Hz
Power consumption	85 W
Dimensions (W×H×D)	
	205×123.5×383.5 mm
	(8 ¹ / ₁₆ " × 4 ²⁷ / ₃₂ " × 15 ³ / ₃₂ ")
Mass 4.1 kg (9.0 lbs)	

Power consumption in standby mode	0.9 W
--	-------

Note

- 1 Specifications are subject to change without notice. Mass and dimensions are approximate.
- 2 Total harmonic distortion is measured by the digital spectrum analyzer.

Troubleshooting guide

Before requesting service, make the below checks. If you are in doubt about some of the check points, or if the remedies indicated in the chart do not solve the problem:

In the U.S.A., contact the Panasonic Customer Call Center at 1-800-211-7262, or e-mail consumerproducts@panasonic.com, or the website (<http://www.panasonic.com>).

In Canada, contact the Panasonic Canada Inc. Customer Care Centre at 1-800-561-5505, or visit the website (www.panasonic.ca), or an authorized Servicentre closest to you.

Power		Page
No power.	• Insert the AC power supply cord securely.	9
The unit is automatically switched to the standby mode.	• The unit was switched to standby by the sleep timer.	29

Operation		
No response when buttons pressed.	<ul style="list-style-type: none"> • Some operations may be prohibited by the disc. • The unit may not be operating properly due to lightning, static electricity or some other external factor. <p>Reset procedure: Press [⏻] to switch the unit to the standby mode and then back to ON. Alternatively, press [⏻] to switch the unit to the standby mode, disconnect the AC power supply cord, and then reconnect it.</p>	— —
No operations can be performed with the remote control.	<ul style="list-style-type: none"> • Check that the batteries are installed correctly. • The batteries are depleted: Replace them with new ones. • Point the remote control at the remote control sensor and operate. 	9 9 —
Play doesn't start (or stops immediately) when you press [▶ DVD/CD].	<ul style="list-style-type: none"> • Condensation has formed: Wait 1 to 2 hours for it to evaporate. • This unit cannot play discs other than the ones listed in these operating instructions. • This unit cannot play DVD-Video with a region number other than "1", "ALL" or multiple region numbers including "1". • The disc may be dirty and may require cleaning. • Ensure that the disc is loaded with the label of the side to be played facing upwards. • Check that the DVD-RAM has something recorded on it. 	— 5 Cover 5 13 —
Cannot select alternative languages.	<ul style="list-style-type: none"> • This function is dependent on software availability. • Try selecting from the disc's menu if one is available. 	— 14
No menu play.	<ul style="list-style-type: none"> • This function is dependent on software availability. 	—
No subtitles.	<ul style="list-style-type: none"> • This function is dependent on software availability. • Subtitles are cleared from the television. Turn on the subtitles. 	— 17
The position of the subtitles is incorrect.	<ul style="list-style-type: none"> • Change the position of the subtitles with "Subtitle Position" in the on-screen icon menus. 	25
Soundtrack and/or subtitle language is not the one selected with the SETUP menus.	<ul style="list-style-type: none"> • This function is dependent on software availability. 	—
Cannot change angle.	<ul style="list-style-type: none"> • This function is dependent on software availability. Even if a disc has a number of angles recorded, these angles may be recorded for specific scenes only. 	—
The SETUP menu cannot be accessed.	<ul style="list-style-type: none"> • Select "DVD/CD" as the source. • Cancel all group, program and random play. 	— 16
Cannot add markers.	<ul style="list-style-type: none"> • You cannot add markers while playing a play list or if the disc's play time doesn't appear on the unit's display. 	—
There are already markers. RAM	<ul style="list-style-type: none"> • The unit reads and displays the markers added with a DVD video recorder. You can clear them but reappear when you switch the unit to standby, change the source, or open the disc tray. 	—
Marker numbers I added are different when I call them up. RAM	<ul style="list-style-type: none"> • The unit numbers markers by time so they change when you add and delete them. 	—
Cannot select random or program play.	<ul style="list-style-type: none"> • You cannot select random or program play with some DVD-Video. 	—
Folders deeper than the eighth layer on a data CD are not displayed correctly.	<ul style="list-style-type: none"> • Folders deeper than the eighth layer are displayed as the eighth layer. 	—
You have forgotten your ratings password. Reset all the SETUP settings to Factory Preset.	<ul style="list-style-type: none"> • While stopped and "DVD/CD" is the source, press and hold [■] on the unit and [≥10] on the remote control for about 3 seconds until "Initialized" disappears from the television. Turn the unit off and on again. All settings will return to the default values. 	—
The unit doesn't play the data type (WMA/MP3 or JPEG) selected in the "Mixed Disc—Audio & Stills" in the SETUP menu.	<ul style="list-style-type: none"> • Reload the disc for the setting to be effective. Press [▲ OPEN/CLOSE] to open the tray, then press [▶ DVD/CD] to start play. 	—

Sound

No sound. Distorted sound.	<ul style="list-style-type: none"> • Check the connections. • Turn the volume up. • Turn muting off. • Turn Advanced surround off if it causes distortion. • Switch off the unit, determine and correct the cause, then switch the unit on. Causes include: <ul style="list-style-type: none"> – Shorting (bare wires touching) of positive and negative speaker wires. – Using speakers with an impedance lower than that rated for this unit. – Straining of the speakers through excessive volume or power. – Using the unit in a hot environment without proper ventilation. 	<p>7</p> <p>—</p> <p>28</p> <p>19</p> <p>—</p>
Piercing noise comes from the speakers.	<ul style="list-style-type: none"> • If you have connected this unit to other equipment through the OPTICAL OUT terminal, ensure you have selected the correct settings for “Dolby Digital” and “DTS Digital Surround” in the SETUP menus’ Audio menu. 	31
Effects do not work.	<ul style="list-style-type: none"> • Dialogue enhancer and Advanced surround do not work when the unit is outputting bitstream signals. • Advanced surround does not work if you have changed the play speed. 	—
		23

Picture

Picture distorted.	<ul style="list-style-type: none"> • Some distortion is normal during SEARCH. 	—
No picture.	<ul style="list-style-type: none"> • Check the connection. • Make sure the television is on. • Ensure the television’s video input setting (e.g., VIDEO 1) is correct. 	8
The picture shown on the television is not normal. (The sides of the picture are cut off, the picture is stretched horizontally, or black bands appear at the top and bottom of the screen.)	<ul style="list-style-type: none"> • Go to Video in the SETUP menus, and change “TV Aspect” to suit your television. • Use the television to change the aspect to the correct one. • If your television cannot change the aspect when input is progressive, try changing 4:3 Aspect with the on-screen menu icons. • Ensure that the unit is connected directly to the television, and is not connected through a video cassette recorder. • Connect to the component video (480P) input terminals on a television compatible with this unit’s copy guard system. You cannot view progressive video if your television is not compatible. • Change the size with the variable zoom function. • The images on PAL system DVD-Audio are compressed for display. They may also appear vertically stretched. 	30
		—
		25
There is ghosting when progressive output is on.	<ul style="list-style-type: none"> • Change “Video output mode” to “480I” so “PROGRESSIVE” on the display goes out. This problem is caused by the editing method or material used on DVD-Video, but should be corrected if you use interlace output. 	25
Picture quality is poor.	<ul style="list-style-type: none"> • Check the settings in the On-Screen Menu Icons’ Picture Menu. 	25
The picture on the television disappears or stripes appear on the screen.	<ul style="list-style-type: none"> • Mobile telephone chargers can cause some disturbance. • The location and orientation of the antenna are incorrect. If you are using an indoor antenna, change to an outdoor antenna. • The television antenna wire is too close to the unit. Separate the antenna wire of the television from the unit. 	—
		32
		—
Menus not displayed correctly.	<ul style="list-style-type: none"> • Change the zoom ratio to “×1.00”. • With the on-screen icon menus, change “Subtitle Position” to “0” or change “4:3 Aspect” to “Normal”. 	18
		25

Listening to the radio

Noise is heard. “ST” flickers or doesn’t light. Sound is distorted.	<ul style="list-style-type: none"> • Adjust the position of the FM or AM antenna. • Use an outdoor antenna. 	—
A beat sound is heard.	<ul style="list-style-type: none"> • Turn the television off or separate it from the unit. 	32
A low hum is heard during AM broadcasts.	<ul style="list-style-type: none"> • Separate the antenna from other cables and cords. 	—

Troubleshooting guide

Unit displays

The display is dark.	<ul style="list-style-type: none"> Press and hold [SHIFT] + [DISPLAY] until the display returns to the original brightness. 	28
“DVD NO PLAY”	<ul style="list-style-type: none"> You inserted a disc the unit cannot play; insert one it can. You inserted a blank DVD-RAM. 	5
“DVD NO DISC”	<ul style="list-style-type: none"> You haven't inserted a disc; insert one. You haven't inserted the disc correctly; insert it correctly. 	13
“F61”	<ul style="list-style-type: none"> Check and correct the speaker cord connections. If this does not fix the problem, there is a power supply problem. Consult the dealer. 	7
“DVD U11”	<ul style="list-style-type: none"> Disc is dirty. Wipe it clean. 	5
“ERROR”	<ul style="list-style-type: none"> Incorrect operation performed. Read the instructions and try again. 	—
“DVD H□□” □□ stands for a number.	<ul style="list-style-type: none"> Trouble may have occurred. The number following “H” depends on the status of the unit. <p>Reset procedure: Press [⏻] to switch the unit to the standby mode and then back to ON. Alternatively, press [⏻] to switch the unit to the standby mode, disconnect the AC power supply cord, and then reconnect it.</p> <ul style="list-style-type: none"> If the service numbers fail to clear, note the service number and contact a qualified service person. 	—

Television displays

“Cannot display group xx, picture xx”	<ul style="list-style-type: none"> You are trying to display incompatible pictures. 	—
“The progressive out is set to “Disable””	<ul style="list-style-type: none"> Go to Video in the SETUP menus, and select “Enable” in “Progressive Out (Component)”. 	30
No on-screen display.	<ul style="list-style-type: none"> Go to Display in the SETUP menus, and select “On” for “On-Screen Messages”. 	30
On-Screen Menu Icons not displayed or only partially displayed on the television.	<ul style="list-style-type: none"> Press [▲, ▼] while the rightmost icon is highlighted to move them down. 	23
The disc's menu is displayed in a different language.	<ul style="list-style-type: none"> Go to Disc in the SETUP menus, and select the preferred language for “Menus”. 	30

Product Service

- Damage requiring service**—The unit should be serviced by qualified service personnel if:
 - The AC power supply cord or AC adaptor has been damaged; or
 - Objects or liquids have gotten into the unit; or
 - The unit has been exposed to rain; or
 - The unit does not operate normally or exhibits a marked change in performance; or
 - The unit has been dropped or the cabinet damaged.
- Servicing**—Do not attempt to service the unit beyond that described in these operating instructions. Refer all other servicing to authorized servicing personnel.
- Replacement parts**—When parts need replacing ensure the servicer uses parts specified by the manufacturer or parts that have the same characteristics as the original parts. Unauthorized substitutes may result in fire, electric shock, or other hazards.
- Safety check**—After repairs or service, ask the servicer to perform safety checks to confirm that the unit is in proper working condition.

The servicer will require all components to service your system. Therefore, should service ever be necessary, be sure to bring the entire system.

Product information

For product information or assistance with product operation:

In the U.S.A., contact the Panasonic Customer Call Center at 1-800-211-7262, or e-mail consumerproducts@panasonic.com, or the website (<http://www.panasonic.com>).

In Canada, contact the Panasonic Canada Inc. Customer Care Centre at 1-800-561-5505, or visit the website (www.panasonic.ca), or an authorized Servicentre closest to you.

Maintenance

To clean this unit, wipe with a soft, dry cloth.

- Never use alcohol, paint thinner or benzine to clean this unit.
- Before using chemically treated cloth, read the instructions that came with the cloth carefully.

Before moving the unit, ensure the disc tray is empty.
Failure to do so will risk severely damaging the disc and the unit.

Limited Warranty (U.S.A.)

Panasonic Consumer Electronics Company,
Division of Matsushita Electric Corporation of America
One Panasonic Way Secaucus, New Jersey 07094

Panasonic Sales Company, Division of Matsushita Electric of Puerto Rico, Inc.
Ave. 65 de Infantería, Km. 9.5
San Gabriel Industrial Park, Carolina, Puerto Rico 00985

Panasonic/Technics Audio Products Limited Warranty

Limited Warranty Coverage

If your product does not work properly because of a defect in materials or workmanship, Panasonic Consumer Electronics Company or Panasonic Sales Company (collectively referred to as "the warrantor") will, for the length of the period indicated on the chart below, which starts with the date of original purchase ("warranty period"), at its option either (a) repair your product with new or refurbished parts, or (b) replace it with a new or a refurbished product. The decision to repair or replace will be made by the warrantor.

Product or Part Name	Parts	Labor
Audio Products (except items listed below)	One (1) year	One (1) year
All Audio Racks (cabinets)	Thirty (30) days	Not Applicable
Technics Stand Alone Speakers, Subwoofer Speakers	Three (3) years	Three (3) years
USB Reader-Writer, Personal Computer Card Adapters (in exchange for defective item)	One (1) year	Not Applicable
Accessories: Headphones, Cartridges, Microphones, Adapters	Ninety (90) days	Ninety (90) days
Rechargeable Batteries (in exchange for defective item)	Ten (10) days	Not Applicable
SD Memory Cards, Rechargeable Battery Packs (in exchange for defective item)	Ninety (90) days	Not Applicable

During the "Labor" warranty period there will be no charge for labor. During the "Parts" warranty period, there will be no charge for parts. You must carry-in or mail-in your product during the warranty period. If non-rechargeable batteries are included, they are not warranted. This warranty only applies to products purchased and serviced in the United States or Puerto Rico. This warranty is extended only to the original purchaser of a new product which was not sold "as is". A purchase receipt or other proof of the original purchase date is required for warranty service.

Carry-In or Mail-In Service

For Carry-In or Mail-In Service in the United States call 1-800-211-PANA (1-800-211-7262) or visit Panasonic web site: <http://www.panasonic.com>
For assistance in Puerto Rico call Panasonic Sales Company (787)-750-4300 or fax (787)-768-2910.

Limited Warranty Limits And Exclusions

This warranty ONLY COVERS failures due to defects in materials or workmanship, and DOES NOT COVER normal wear and tear or cosmetic damage. The warranty ALSO DOES NOT COVER damages which occurred in shipment, or failures which are caused by products not supplied by the warrantor, or failures which result from accidents, misuse, abuse, neglect, mishandling, misapplication, alteration, faulty installation, set-up adjustments, misadjustment of consumer controls, improper maintenance, power line surge, lightning damage, modification, or commercial use (such as in a hotel, office, restaurant, or other business), rental use of the product, service by anyone other than a Factory Servicenter or other Authorized Servicer, or damage that is attributable to acts of God.

THERE ARE NO EXPRESS WARRANTIES EXCEPT AS LISTED UNDER "LIMITED WARRANTY COVERAGE". THE WARRANTOR IS NOT LIABLE FOR INCIDENTAL OR CONSEQUENTIAL DAMAGES RESULTING FROM THE USE OF THIS PRODUCT, OR ARISING OUT OF ANY BREACH OF THIS WARRANTY. (As examples, this excludes damages for lost time, travel to and from the servicer, loss of media or images, data or other memory content. The items listed are not exclusive, but are for illustration only.) **ALL EXPRESS AND IMPLIED WARRANTIES, INCLUDING THE WARRANTY OF MERCHANTABILITY, ARE LIMITED TO THE PERIOD OF THE LIMITED WARRANTY.**

Some states do not allow the exclusion or limitation of incidental or consequential damages, or limitations on how long an implied warranty lasts, so the exclusions may not apply to you. This warranty gives you specific legal rights and you may also have other rights which vary from state to state. If a problem with this product develops during or after the warranty period, you may contact your dealer or Servicenter. If the problem is not handled to your satisfaction, then write to the warrantor's Consumer Affairs Department at the addresses listed for the warrantor.

PARTS AND SERVICE WHICH ARE NOT COVERED BY THIS LIMITED WARRANTY ARE YOUR RESPONSIBILITY.

Customer Services Directory

*For Product Information, Operating Assistance, Literature Request, Dealer Locations, and all Customer Service inquiries please contact:
1-800-211-PANA (7262), Monday–Friday 9 am–9 pm; Saturday–Sunday 9 am–7 pm, EST.
or send e-mail:
consumerproducts@panasonic.com
For hearing or speech impaired TTY users, TTY: 1-877-833-8855*

*Web Site: <http://www.panasonic.com>
You can purchase parts, accessories or locate your nearest servicenter by visiting our Web Site.*

Accessory Purchases:

1-800-332-5368 (Customer Orders Only)
For hearing or speech impaired TTY users, TTY: 1-866-605-1277
Panasonic Services Company 20421 84th Avenue South, Kent, WA 98032
(6 am to 5 pm Monday–Friday; 6 am to 10:30 am Saturday; PST)
(Visa, MasterCard, Discover Card, American Express, Check)

*Service in Puerto Rico
Matsushita Electric of Puerto Rico, Inc. Panasonic Sales Company/Factory Servicenter:
Ave. 65 de Infantería, Km. 9.5, San Gabriel Industrial Park, Carolina, Puerto Rico 00985
Phone (787) 750-4300 Fax (787) 768-2910*

Listening caution



Selecting fine audio equipment such as the unit you've just purchased is only the start of your musical enjoyment. Now it's time to consider how you can maximize the fun and excitement your equipment offers. This manufacturer and the Electronic Industries Association's Consumer Electronics Group want you to get the most out of your equipment by playing it at a safe level. One that lets the sound come through loud and clear without annoying blaring or distortion—and, most importantly, without affecting your sensitive hearing.

We recommend that you avoid prolonged exposure to excessive noise.

Sound can be deceiving. Over time your hearing "comfort level" adapts to higher volumes of sound. So what sounds "normal" can actually be loud and harmful to your hearing.

Guard against this by setting your equipment at a safe level BEFORE your hearing adapts.

To establish a safe level:

- Start your volume control at a low setting.
- Slowly increase the sound until you can hear it comfortably and clearly, and without distortion.

Once you have established a comfortable sound level:

- Set the dial and leave it there.

Taking a minute to do this now will help to prevent hearing damage or loss in the future. After all, we want you listening for a lifetime.

For U.S.A.

As an ENERGY STAR® Partner, Panasonic has determined that this product meets the ENERGY STAR® guidelines for energy efficiency.

