

Panasonic®

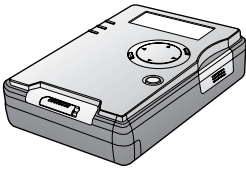

SD Media Storage Operating Instructions

Model No. **SV-PT1PP**



MultiMediaCard™

Before attempting to connect, operate or adjust this product, please read these instructions thoroughly.

For USA assistance, please call: 1-800-272-7033 or send e-mail to: digitalstillcam@panasonic.com

For Canadian assistance, please call: 1-800-561-5505 or visit us at www.panasonic.ca

LSQT0622A

Information For Your Safety

Dear Customer,

We would like to take this opportunity to thank you for purchasing this Panasonic SD Media Storage. Please read these Operating Instructions carefully and keep them handy for future reference.

Information for Your Safety

WARNING

TO REDUCE THE RISK OF FIRE OR SHOCK HAZARD AND ANNOYING INTERFERENCE, USE ONLY THE RECOMMENDED ACCESSORIES AND DO NOT EXPOSE THIS EQUIPMENT TO RAIN OR MOISTURE. DO NOT REMOVE THE COVER (OR BACK); THERE ARE NO USER SERVICEABLE PARTS INSIDE. REFER SERVICING TO QUALIFIED SERVICE PERSONNEL.

Carefully observe copyright laws.

Recording of pre-recorded tapes or discs or other published or broadcast material for purposes other than your own private use may infringe copyright laws. Even for the purpose of private use, recording of certain material may be restricted.

- Please note that the actual controls and components, menu items, etc. of your SD Media Storage may look somewhat different from those shown in the illustrations in these Operating Instructions.
- Other names, company names, and product names printed in these instructions are trademarks or registered trademarks of the companies concerned.

CAUTION

Danger of explosion if battery is incorrectly replaced.

Replace only with the same or equivalent type recommended by the manufacturer.

Dispose of used batteries according to the manufacturer's instructions.

THE SOCKET OUTLET SHOULD BE INSTALLED NEAR THE EQUIPMENT AND SHOULD BE EASILY ACCESSIBLE.

- **Only use the supplied USB cable and Video cable.**
- **Do not open and close the HDD door or remove the card while HDD or SD is operating.**
- **Do not turn this unit upside down when in operation.**

Information For Your Safety

Before Use

FCC Note: (U.S. only)

This equipment has been tested and found to comply with the limits for a Class B digital device, pursuant to Part 15 of the FCC Rules. These limits are designed to provide reasonable protection against harmful interference in a residential installation. This equipment generates, uses, and can radiate radio frequency energy and, if not installed and used in accordance with the instructions, may cause harmful interference to radio communications. However, there is no guarantee that interference will not occur in a particular installation. If this equipment does cause harmful interference to radio or television reception, which can be determined by turning the equipment off and on, the user is encouraged to try to correct the interference by one or more of the following measures:

- Reorient or relocate the receiving antenna.
- Increase the separation between the equipment and receiver.
- Connect the equipment into an outlet on a circuit different from that to which the receiver is connected.
- Consult the dealer or an experienced radio/TV technician for help.

FCC Caution: To assure continued compliance, follow the attached installation instructions and use only shielded interface cables with ferrite cores when connecting to computer or peripheral devices. Any changes or modifications not expressly approved by the party responsible for compliance could void the user's authority to operate this equipment.

Trade Name: Panasonic
Model No.: SV-PT1
Responsible party:
Matsushita Electric Corporation of America One Panasonic Way, Secaucus, NJ 07094
Support Contact: Panasonic Consumer Electronics Company 1-800-272-7033

This device complies with Part 15 of the FCC Rules. Operation is subject to the following two conditions: (1) This device may not cause harmful interference, and (2) this device must accept any interference received, including interference that may cause undesired operation.

This Class [B] digital apparatus complies with Canadian ICES-003.

Cet appareil numérique de la classe [B] est conforme à la norme NMB-003 du Canada.

Panasonic SV-PT1



Tested To Comply
With FCC Standards

FOR HOME OR OFFICE USE

End User License Agreement

Before opening the CD-ROM package, please read the following.

End User License Agreement

You ("licensee") are granted a license for the Software defined in this End User License Agreement ("Agreement") on condition that you agree to the terms and conditions of this Agreement. If Licensee does not agree to the terms and conditions of this Agreement, promptly return the Software to Matsushita Electric Industrial Co., Ltd. ("Matsushita"), its distributors or dealers from which you made the purchase.

Article 1 License

Licensee is granted the right to use the software, including the information recorded or described on the CD-ROM, instruction manuals, and any other media provided to Licensee (collectively "software"), but all applicable rights to patents, copyrights, trademarks and trade secrets in the Software are not transferred to Licensee.

Article 2 Use by a Third Party

Licensee may not use, copy, modify, transfer or allow any third party, whether free of charge or not, to use, copy or modify the Software, except as expressly provided for in this Agreement.

Article 3 Restrictions on Copying the Software

Licensee may make a single copy of the Software in whole or in part, in machine-readable form, solely for back-up purpose. Licensee must include, in such copy of the software, the same copyright notice as included in the software.

Article 4 Computer

Licensee may use the Software only on one computer, and may not use it on more than one computer. The Software may not be transferred or transmitted to, or shared with, or accessed by other computers over or through computer networks and/or by other means.

Article 5 Reverse Engineering, Decompiling or Disassembly

Licensee may not reverse engineer, decompile, or disassemble the Software, except to the extent either of them is permitted under law or regulation of the country where Licensee resides. Matsushita, or its distributors or dealers will not be responsible for any defects in the Software or damage to Licensee caused by Licensee's reverse engineering, decompiling, or disassembly of the Software.

Article 6 Indemnification

The Software is provided "AS-IS" without warranty of any kind, either expressed or implied, including, but not limited to, warranties of non-infringement, merchantability and/or fitness for a particular purpose. Further, Matsushita does not warrant that the operation of the Software will be uninterrupted or error free. Matsushita or any of its distributors or dealers will not be liable for any damage suffered by Licensee arising from or in connection with Licensee's use of the Software.

Article 7 Export Control

Licensee agrees not to export or re-export to any country the Software in any form without the appropriate export licenses under regulations of the country where Licensee resides, if necessary.

Article 8 Termination of License

The right granted to Licensee hereunder will be automatically terminated if Licensee contravenes any of the terms and conditions of this Agreement. In this event, Licensee must destroy the Software and related documentation together with all the copies thereof at Licensee's own expense.

Table of Contents

Before Use		Before Use	
Information For Your Safety	2		
End User License Agreement	4		
Things You Should Know	7		
Operating Precautions	8		
• Main Unit and Battery	8		
• Data Protection and PC Card HDD	9		
• ScanDisk/CheckDisk	9		
Before Using			
• Compatible Card	10		
• Folder Structure	10		
• Copying and Backup	11		
Selecting Modes [Copy/TV/PC]	13		
Index Of Controls	14		
Carrying the Unit		Copy Mode	
• Attaching the Hand Strap	15		
• Using the Carrying Case	15		
Recharging the Battery Pack	16		
Inserting the Card	17		
Turning the Power On	18		
• HDD SAFETY Switch	18		
• Remaining Battery Life Display	18		
Copy Mode			TV Mode
Display Indicator	19		
Menus	20		
Copying	21		
Formatting Cards			
• Format the SD Cards	22		
• Format the PC Card HDD	23		
TV Mode		PC Mode	
TV Mode Setup			
• Setup (Connections)	24		
TV Mode Functions (Initial Screen)	25		
Display Information			
• Displayable Image Formats	26		
• Folders and Files	26		
Image Display			
• Viewing Images in the Index	27		
• Using the Sub Menu	27		
Album	28		
Slide Show		For Your Information	
• Performing Slide Show	29		

Table of Contents

Slide Show Settings

- Selecting Images 30
- Setting Screen Transition Effects/Speed 31

Presentation

- Performing Presentation 32
- Selecting Presentation Content 33

Editing

- Deleting Images (DELETE) 34
- Copying Images (COPY) 35
- Protecting Images (PROTECT) 36
- How to Select Images 37

Full Screen Playback

- Selecting Images 38
- Displaying the Sub Menu 39
- Enlarging an Image (ZOOM) 39
- Rotating an Image (ROTATE) 40
- Processing Image Color (COLOR EFFECT) 41
- Displaying Image Information (PROPERTIES) 41

PC Mode

PC Mode Setup

- System Requirements 42
- Setup (Connections) 42
- Installing the USB Driver 43

Operation with the PC

- File Operations 44
- Disconnecting Unit from PC 45

Using the Applications

- Installation 46
- Presentation File Creation 47

Other

- Uninstalling JPEG Addin Software 48
- Reinstalling the Device Driver 48
- HDD SAFETY Switch Operation 49

For Your Information

- Warning and Instruction Displays 50
- Reset Function 52
- Before Requesting Service 53
- Specifications 55
- Accessory Order Form 57
- Request for Service Notice 58
- Customer Services Directory 59
- Limited Warranty (U.S.A. only) 60

Things You Should Know

Main Features

- This unit is a compact, lightweight portable media storage unit.
- The generous 5 GB HDD allows ample storage for your still images.
- Stored images can be viewed and edited (delete, copy, etc.) on a TV at home or elsewhere.
- This unit can serve as an external drive by connecting the USB port to your PC.
- Still images can be played back from a variety of cards *1 and copied to an SD Memory Card.

*1 Each type of card requires a compatible adaptor.

Accessories

- Battery Pack
(CGA-S301A1)

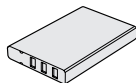

- PC Card HDD
(RP-PH005A)

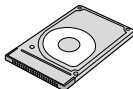

- Video Cable
(LSEC0003)



- AC Adaptor
(VSK0626C)



- USB Cable
(LSEC0004)



- Carrying Case
(LSFC0019)

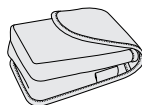

- PC Card HDD Case
(LSFC0020)



- CD-ROM
(VFF0181)

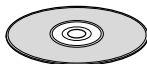

- Hand Strap
(VFC3803)



Operating Precautions

Carefully read these precautions prior to use and strictly observe them during unit operation. Failure to do so may result in product malfunction or damage. Also, disregarding these precautions could cause damage to, or loss of, data stored within the media.

- Do not leave this unit in direct sunlight, inside tightly closed vehicles, in extremely hot or cold places, or near heaters or air conditioners. Avoid rapid temperature changes.
- Operate unit well away from magnetic or electromagnetic wave sources (e.g. microwave ovens, TVs, game devices, portable telephones, etc.) as stored data may be lost or distorted.
- Do not let volatile substances, such as insecticides, come in contact with this unit as it could seriously damage the unit's exterior finish.
- Do not allow this unit to remain in dusty locations. If dust enters this unit, request an inspection from the retail store where this unit was purchased.
- Ensure that this unit is protected from vibration and impact. Do not swing or drop this unit.
- Do not place objects on top of this unit and do not drop objects onto this unit.
- Do not attempt to twist or apply excess pressure to this unit.
- Do not use this unit's jacks for purposes other than those specifically designated for each jack. Always ensure that the cables are properly connected.
- Do not insert foreign objects into this unit. The battery and the storage media are the only objects that may be inserted into this unit.
- This unit should be powered-up and operated at least once every 6 months.
- After each use, turn off the power and unplug the electrical cord from the outlet.
- Prior to performing maintenance, always unplug the electrical cord from the outlet and remove the battery from this unit. Do not use benzene, thinners or alcohol to clean this unit. These chemicals may cause deterioration, distortion and discoloration of the case. To clean this unit, first use a soft, dry cloth to wipe off any dust. If this unit is extremely dirty, dilute a neutral dishwashing detergent with water, moisten a clean cloth with this detergent mixture, remove any excess liquid from the cloth, then wipe this unit clean. Finally, dry this unit with a soft, dry cloth.

Precautions Pertaining to the Battery

Caution:

- Charge only with specified charger.
- Charge the Battery within an ambient temperature range of 50 F (10 °C) and 86 F (30 °C).
- The Battery may be warm after charging or just after use. This is normal.
- Do not use an insufficiently charged or worn out Battery.
- If charging is done in extreme low or high temperatures, Battery charge time increases.

Safety precautions:

- Do not place the Battery near, or dispose of in fire.
- Do not directly connect (short circuit) the positive (+) and negative (-) terminals.
- Never attempt to disassemble or reassemble the Battery.

To avoid damage to the Battery:

- Do not drop or jar the Battery.
- Use the Battery with specified models only.
- If the Battery is used in extremely high temperatures, a safety device will automatically prevent operation.

To ensure longer battery life:

- **While not in use, remove Battery from the unit and AC Adaptor and store in a cool, dark, dry place.** If you leave the Battery in the unit or on the AC Adaptor, the Battery will no longer be rechargeable.
- Keep the Battery terminals clean.

U.S.A. CONSUMERS: ATTENTION:



A lithium ion/polymer battery that is recyclable powers the product you have purchased. Please call 1-800-8-BATTERY for information on how to recycle this battery.

Card Data Protection

(Refer to page 10 for details on compatible cards.)

- Do not unplug the AC adaptor or disconnect the USB cable connecting a PC while this unit is in operation.
- Do not remove the card while it is being accessed.
- Be sure the card does not contain important data before formatting it. Formatting irreversibly deletes all data stored on the card.
- Do not touch the terminals on the back of the Memory Card.
- Electrical interference, electrostatic discharges and malfunctions of the unit or card may all result in damage to the card or data loss. It is recommended that any important data also be backed up on a PC.
- Stored data should be periodically backed up as a protection against data corruption, data loss or device malfunction. Please note that our company shall not accept any liability for damage or loss of stored data.
- SD Memory Cards, Memory Sticks, Smart Media Cards and some CF Cards (when a PC Card Slot is used) include a write-protect switch. When this switch is set to the "LOCK" position, it will not be possible to write data to or delete data from the Memory Card or format Memory Card.

Handling the PC Card HDD

The PC Card HDD is a very small, high-precision hard disk drive. Be particularly careful when handling this drive. Strictly observe the following to avoid HDD malfunction, damage, or data loss.

- Do not subject the PC Card HDD to excessive vibration and strong impacts.
- Do not use the unit in areas of extreme temperature differences (where temperature changes more than 15 °C in one hour). If the unit is suddenly moved from a cold place to a warm place or vice versa, or if a room is quickly heated in wintertime or quickly cooled in summertime, or if a cooler blows directly on the unit, etc., condensation (dew) may form. Using the unit in this condition may cause serious damage to the HDD. If condensation occurs, turn the unit power off and remove the PC Card HDD. Then leave this way for about 4 hours until the ambient temperature equalizes. After confirming condensation is no longer present, you may use the unit.
- Do not twist the PC Card HDD or press down on the label surface, and do not write on the PC Card HDD using a pen with a hard tip, as these actions may damage the PC Card HDD. When holding the PC Card HDD, always hold it by the outside edges.
- Do not remove the label that is attached to the PC Card HDD. If this label is removed, you may not be eligible for warranty service or other services.
- Before removing the PC Card HDD from its special carrying case, make sure that the side of the case labeled "PC Card HDD" is facing upward. If the case cover is opened and the labeled side is not facing upward, the PC Card HDD may fall out and be damaged.
- Always use the special carrying case to carry the PC Card HDD.
- Please note that our company shall not accept any liability for damage or loss of data stored within the PC Card HDD due to inappropriate handling.

ScanDisk

("CheckDisk" for Windows 2000/XP users)

- Do not subject the PC Card HDD to excessive vibration or strong impacts. Also, do not turn off the power supply or remove the card from the unit while it is in operation, otherwise data may be corrupted. If a problem occurs, immediately use the computer's ScanDisk/CheckDisk function to check the media contents. (It takes several hours for ScanDisk/CheckDisk to finish checking the PC Card HDD.) It is recommended that you then make a backup of the data on the media. See page 42 on how to connect the unit to a computer. Refer to your computer manual regarding ScanDisk/CheckDisk function.

Before Using

- Photographs and printed materials may not be used except for personal and private applications without authorization from the copyright owner.
- **SD**: SD logo is a trademark.
- Microsoft®, Windows® and PowerPoint® are registered trademarks of Microsoft in the United States and other countries.
- Other product names, trade names and company used in this manual are trademarks or registered trademarks of their respective owners.
- Any unauthorized copying or reproduction of the software from this product or distribution of the software over a network is strictly prohibited.
- In this manual, "Memory Card" is used to refer to SD Memory Card and MultiMediaCard. In addition, "Card" is also used to refer to Memory Cards, the PC Card HDD and other types of PC Cards.
- In this manual, the name "Windows 98SE" shall refer to "Microsoft® Windows® 98 SECOND EDITION".
- In this manual, the name "Windows 2000" shall refer to "Microsoft® Windows® 2000 Professional".
- In this manual, the name "Windows Me" shall refer to "Microsoft® Windows® Millennium Edition".
- In this manual, the name "Windows XP" shall refer to "Microsoft® Windows® XP Home Edition" or "Microsoft® Windows® XP Professional".

Compatible Card

The following types of card can be used in this unit :

PC Card Slot

- PC Card HDD (2 GB, 5 GB)
- SD Memory Card*
- MultiMediaCard*
- Microdrive*
- Memory Stick*
- Smart Media*
- CF Card*

*Requires an ATA-compatible PCMCIA TYPE II adaptor for use, sold separately.

SD Memory Card Slot

- SD Memory Card
- MultiMediaCard

Folder Structure

Digital cameras that are compliant with DCF specifications use folders with a specific structure. The following diagram shows an example of the folder structure. If these folders are deleted, or if a folder name or file name is changed, the data may no longer be readable by a digital camera.

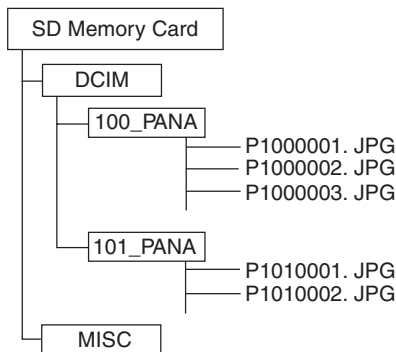

DCIM Folder

The digital camera creates this folder automatically.

100_PANA Folder

Folder names consist of a 3-digit folder number which is followed by five arbitrary characters. Digital camera images are stored within these folders.

P1000001.JPG: DCF File

File names consist of four arbitrary characters followed by a 4-digit file number. DCF files are image files (normally JPEG files) that have been taken by a digital camera. (Other file extensions such as TIF or THM may also be used.)

MISC Folder

The MISC folder contains the DPOF configuration files that add print/slide information to the images.

Copying and Backup

Copying: Memory Card -> PC Card HDD

When copying from a Memory Card to the PC Card HDD, create a folder entitled "CARD****" for each copy and save Memory Card data into this folder. When BACKUP is ON, the "CARD****" folder mentioned above is created in the "BACKUP" folder of the PC Card HDD available space is reduced by half. See page 20 on how to turn the BACKUP function ON and OFF.

Memory Card

PC Card HDD

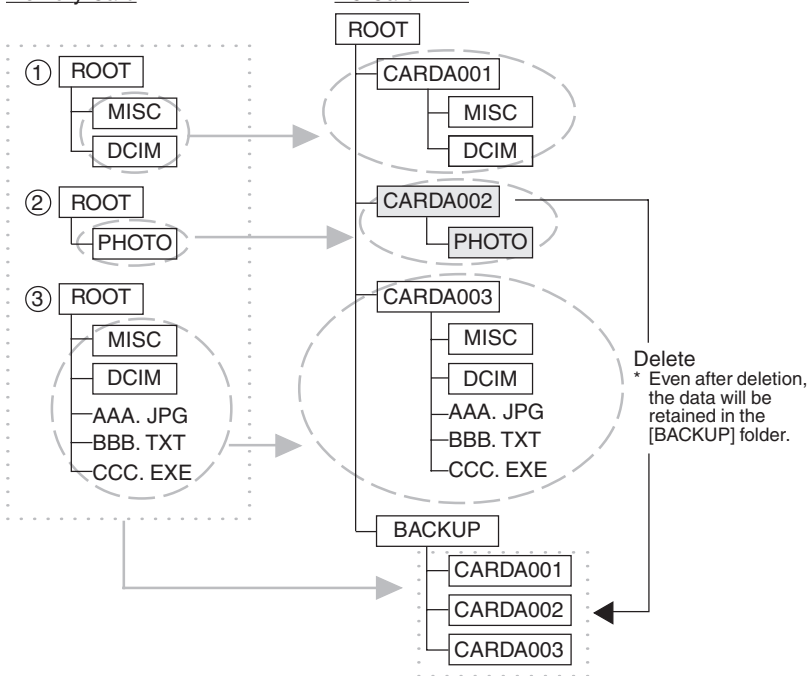

See next page on how to copy from PC Card HDD to a Memory Card.

- Note -

- The contents of the BACKUP folder cannot be checked during TV mode. Use the computer to check the contents at this time.
- Secure data files (audio files that include copyright restrictions) will not be copied.
- The **** portion of the "CARD****" folder name is assigned automatically in numerical order within the range of "A001~A999, B001~Z999". Because of this, please do not change the file names yourself.

Before Using

Copying and Backup (Continued)

Copying: PC Card HDD -> Memory Card

The folder entitled "CARD****" will disappear and data will be copied according to the file structure rules.

PC Card HDD

Memory Card

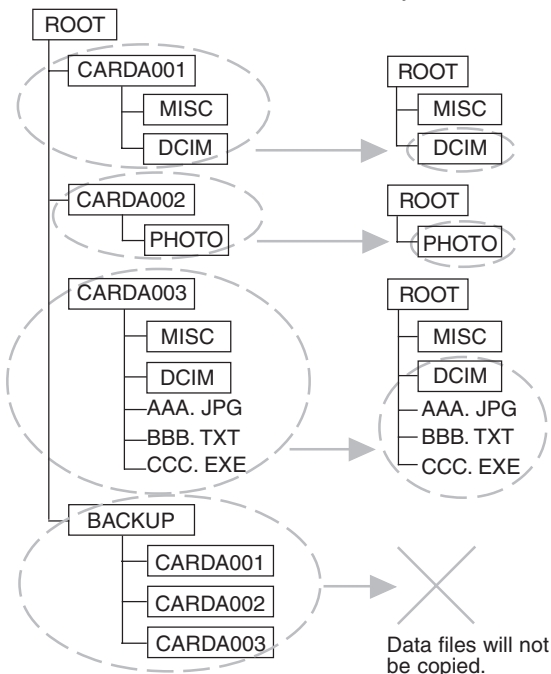

- Note -

- BACKUP folder contents, not displayable in TV mode, can be copied/edited/ deleted on a computer.
- Secure data files (including copyrighted audio files) will not be copied.
- When copying data to a Memory Card, reset the DPOF settings on devices, such as digital cameras, digital video cameras, etc. that allow you to do so. See the device manual.
- If no MISC folder has been created on the card to which the data will be copied, the MISC folder will also be copied.
- When copying a DCIM folder name, e.g. "100_PANA", and that name already exists on the card, change the name to "101_PANA" before copying.
- If an overwrite operation is about to occur in a folder other than the DCIM folder, a message asking the user to confirm the overwrite operation will be displayed.

Copying: Memory Card <=> PC Card

When copying from a PC Card to a Memory Card or vice versa, the data can be copied directly.

Memory Card

PC Card

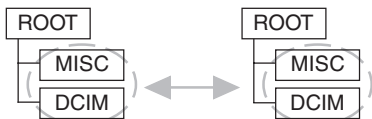

- This operation is possible for all types of cards except the PC Card HDD.

Selecting Modes

Copy Mode (pp. 19~23)

Copy mode is used to copy data from the inserted card to another card. In addition, you can press MENU to carry out operations such as checking the card storage capacity, making backup and TV format settings and formatting cards.

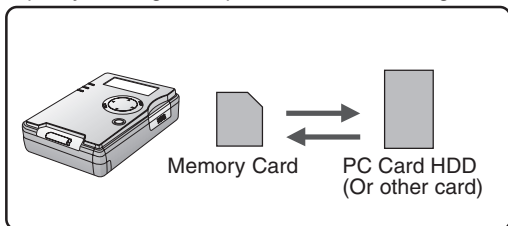

TV Mode (pp. 24~41)

In TV mode, you can connect the unit to a TV and then carry out playback and edit operations (such as copying, deleting, protecting, zooming, rotating and enhancing colors) for the data stored on a card while viewing the data on a TV screen.

* Only JPG, TIF, and MOV type files can be displayed. Other files require the unit to be in PC Mode.

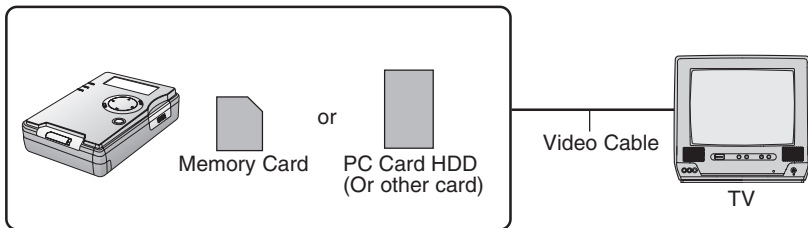

PC Mode (pp. 42~49)

In PC mode, the unit is connected to a computer using a supplied USB cable, allowing the unit to function as an external disk drive. The data on the card inside the unit can then be edited (copied and deleted, etc.), and the accessory software application can be used to create files for presentations.

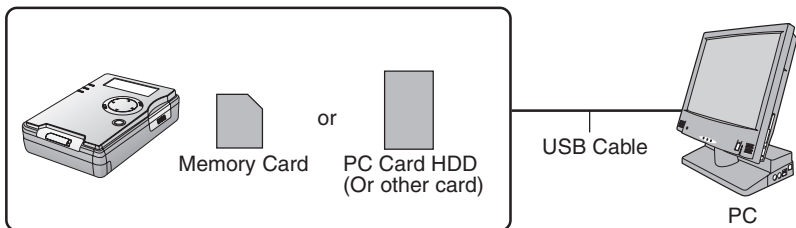

Index Of Controls

Front View

Hand Strap Attachment Pin

Attach hand strap here.
(p. 15)



POWER Lamp

Lights when power is ON. Flashes during battery recharge.

SD Lamp

Lights when SD Memory Card or MultiMediaCard is accessed.

HDD Lamp

Lights when PC Card HDD or PC Card is accessed.

CANCEL Button

Cancels Slide Show and presentations.

RESET Function

Press CANCEL and STANDBY simultaneously for 5 seconds to reset unit.
(p. 52)

Liquid Crystal Display

The LCD indicates the current operating (TV, Copy) mode.

- In Copy mode, displays battery level, data transfer progress, and various menus. (pp. 18-23)
- With USB cable connection, displays card selection options. (p. 44)

Cursor Buttons

(▲▼◀▶)

Moves the cursor up, down, left and right.

MENU Button

Displays/Clears menu.

SD Memory Card Slot

Open to insert/remove SD Memory Card or MultiMediaCard. (p. 17)

STANDBY Button

Press this button for approx. 2 seconds to turn power ON/OFF.

SET Button

Executes selected operation.

PC Card HDD (PC Card) Slot

Slide lever and open cover to insert/remove PC Card HDD or PC Card. (p. 17)

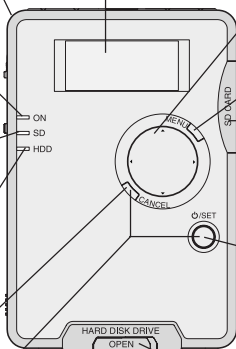

Left Side View

HDD SAFETY (ON/OFF) Switch

Turns HDD SAFETY function ON/OFF. (p. 18)

COPY/TV MODE Switch

Switches between Copy and TV operating mode. (pp. 19, 24)

Battery Compartment

Holds the battery.



End View

USB Terminal

By connecting this unit to a PC with the supplied USB cable, it can function as an external drive. (pp. 42-49)

S/V Output Connector

You can use the supplied video cable to connect this unit to the S-Video or Video terminals of a TV to view images. (p. 24)

Connector Cover

Protects the connectors.

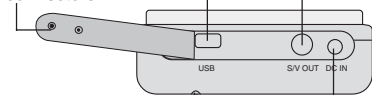

HDD SAFETY Detection Switch

This switch pops out if the unit is lifted up. In this case, the HDD and all operations stop. (p. 18)

DC Input Connector (Power Supply)

This unit can be supplied with external power by connecting the AC adaptor (supplied) to this connector. (pp. 16, 24, 42)

Carrying the Unit

Before Use

Attaching the Hand Strap

1 Insert strap end loop into gap of Attachment Pin.

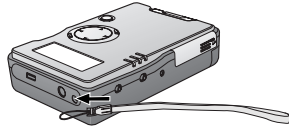

2 Thread opposite end through the end loop and pull strap tight in the direction of arrow.

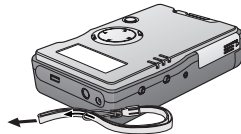

Caution

- This unit is a precision device. When carrying this unit, ensure that it does not swing excessively. Do not drop this unit or subject it to strong impacts.

Using the Carrying Case

1 Open the carrying case.

2 Insert this unit into the lower compartment.

3 Insert the PC Card HDD case into the upper compartment with the "PC Card HDD" mark facing upward.

4 Close the carrying case.

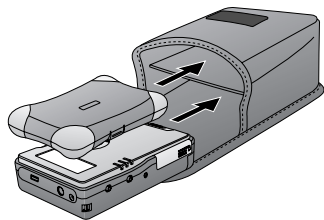

Caution

- When transporting the unit, always turn off the power and insert the PC Card HDD into its case and then place the case inside the carrying case.

Recharging the Battery Pack

The battery pack can be recharged right inside this unit using the supplied AC adaptor. **Unit power must be turned OFF before recharging. Charging will stop if unit power is turned on.**

- 1** Slide the battery cover slightly to the right and swing open.



- 2** Insert the battery (labeled side up) all the way into the battery compartment.

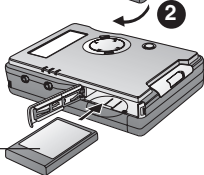

To remove the Battery :
Use your fingertip to push down on the catch.

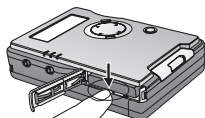

Catch



- 3** Close the cover.

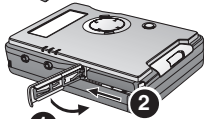

- 4** Connect the DC plug of the AC adaptor to unit's DC IN terminal, then the AC adaptor into a wall outlet.

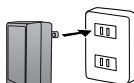
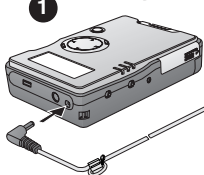

- The POWER Lamp flashes during recharging.

Caution

- Remove battery if unit will not be used for a long period.
- Do not install/remove battery or plug in or unplug the AC adaptor with unit power ON. This may cause unit damage or loss of data.
- Do not unplug AC adaptor while recharging.

- 5** Recharge is complete when POWER Lamp goes out.

- A fully charged battery, given a temperature of 20 °C with 60 % humidity, will give about 80 minutes of operating time. (Operating time may depend on the conditions of usage.)

POWER Lamp Indications During Charging

During normal charging, the POWER Lamp flashes in approx. 1-second intervals. Charging usually finishes in about 90 minutes. However, if the lamp flashes faster or slower than this (or if POWER Lamp goes out before charging is finished), it means a problem has occurred. The flashing speed can tell you what the problem may be. See below.

If you believe a problem has occurred, contact your nearest Servicerenter.

Flashing rapidly (approx. 0.5-second intervals):

- Possible problem with the unit or battery or the AC adaptor.

Flashing slowly (approx. 6 second intervals):

- Temperature of the battery or its surroundings is too high or low, or the battery is over-discharging. Charging can still continue under these conditions, but will take longer than normal.

Lamp is OFF (charging is not yet finished):

- There may be a problem with the AC adaptor.

Inserting the Card

Set **STANDBY** to **OFF** when inserting or removing a Card.

Before Use

SD Memory Card Slot

- 1 Push up slightly on card door to swing open.

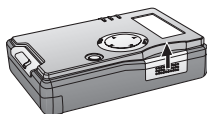

To remove Card :
Open card door.
Press in lightly on card then release.

- 2 Insert the Memory Card (labeled side up, cropped corner right) and hold in place until you hear a click.

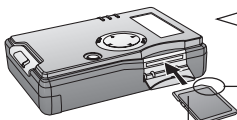

cropped corner

- 3 Close the lid.

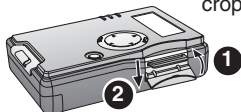

PC Card Slot

- 1 Slide the lever to open the cover.

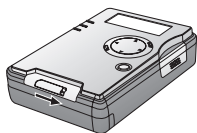

- 2 Insert the PC Card HDD or PC Card all the way into the slot.

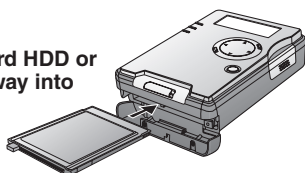

To remove Card :
Press **EJECT TAB** twice.

- 3 Close the cover.

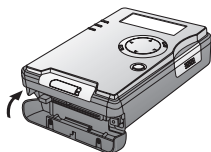

Caution

- Always insert card in the correct direction. Failure to do so may result in damage to the card and this unit.
- The PC Card HDD and Memory Card are precision devices. Do not subject them to excessive pressure or strong impacts.
- If the card door does not close completely, remove the card, check insertion orientation, and reinsert. Also, confirm that **EJECT TAB** was firmly pressed.

Turning the Power On

In case of a power outage, the unit utilizes the supplied battery as a backup in order to protect the unit and the card data. If you are using the AC adaptor, insert a sufficiently charged battery before turning on the power. The unit cannot be used if only the AC adaptor is used.

1 Insert the battery and connect the AC adaptor. (p. 16)

- The unit can be operated using only the battery, but when using PC mode, the AC adaptor must be connected, otherwise the unit will not turn on.

2 Place unit on a flat, level surface.

- If this is not done, the HDD SAFETY Switch may prevent the unit from operating. (See below.)

3 Press STANDBY for approx. 2 seconds.

- The power comes on (POWER Lamp lights) and the unit cycles through each operating mode in sequence. (p. 13)

To turn this unit off :

Press STANDBY for approx. 2 seconds.

– Note –

- If using the unit on battery power only, the power will turn off automatically if no unit operations are carried out for 5 minutes, in order to conserve battery power.
- The power cannot be turned off while the HDD SAFETY Detection Switch has been activated. (See below.)

HDD SAFETY Switch

Important: Keep unit on flat, level surface while in use. If the unit is lifted up or placed on a surface that is not flat and level, the PC card HDD operation will be stopped by the HDD SAFETY Switch to protect it from damage.

- If the unit receives a strong impact, the PC Card HDD data may be corrupted. It is advisable to keep this switch ON. (ON is the default setting.)
- If the HDD SAFETY Detection Switch, located under the unit, is activated, unit operation will be stopped and a warning message will appear on the TV screen and unit LCD. In this case, place unit on a flat, level surface. Normal operation will resume. Any copy operations resume from precise point where copying was interrupted.
- If the HDD SAFETY Detection Switch is activated while the unit is connected to a PC, "SAFETY MODE PUT IT DOWN" will appear on the unit LCD. Copy operation in progress at this time will be suspended, and computer errors may also occur.

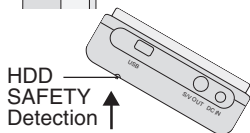
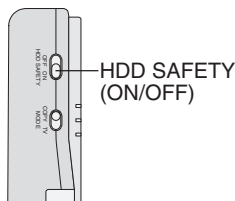

HDD stops and all operations are interrupted.

Remaining Battery Life Display



When the BATT. □□□ and the battery icon  start flashing, all buttons, except power off, are inoperable. Connect the AC adaptor or recharge the battery. If the battery completely runs down during copying, the copying is stopped and power is shut off. It may not be possible to play back the data that was being copied at this time.

It is advisable to fully charge the battery before using the unit. (p. 16)

Copy Mode (Display Indicator)

In Copy mode, data can be copied from one card to another. You can also check card storage capacity, make backups, set TV formats, and format cards. If unit is on battery power only, power shuts off automatically if you perform no operation for 5 minutes to conserve battery.

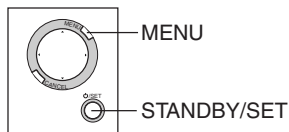
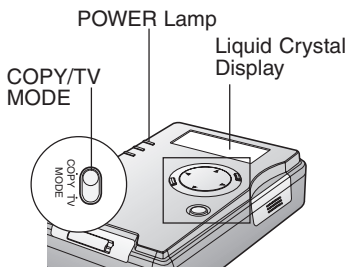

Copy Mode

Displaying Menu (Indicator Flowchart)

Follow these steps to display menus in COPY mode.

- 1 Set COPY/TV MODE to "COPY".
- 2 Insert a Card. (p. 17)
- 3 Turn on this unit. (p. 18)

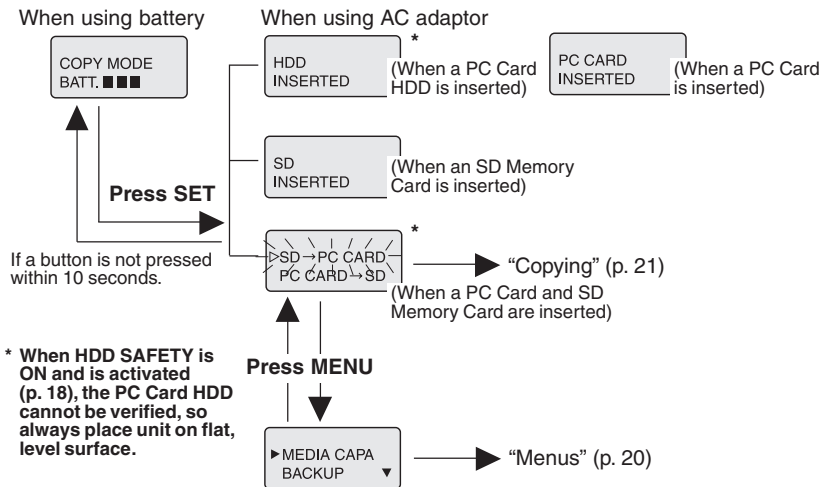

- Note -

- Any cards that utilize adaptors other than the accessory PC Card HDD adaptor are displayed as "PC CARD".

Copy Mode (Menus)

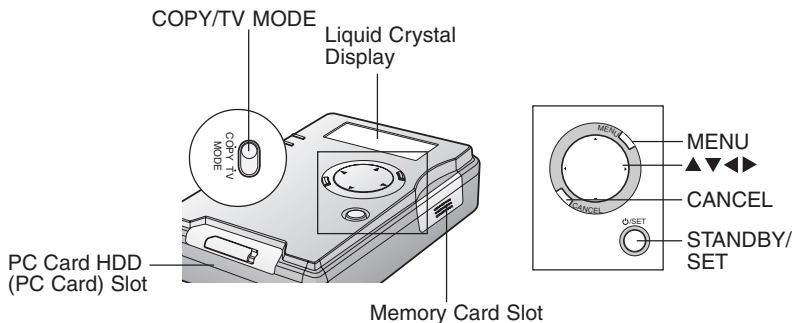

• Card Storage Capacity Check (MEDIA CAPACITY)

This lets you confirm card storage capacity.

- PC Card HDD available space is approx. 4.6 GB.

USED	1.5GB	(Example)
FREE	3.1GB	

• BACKUP (BACKUP ON/OFF)

Set to ON, a backup folder containing your data is automatically created when copying. Useful where data may become accidentally deleted or corrupt. Backup folder contents are not displayed in TV mode. A computer can be used to copy, edit, and delete files. (This unit is factory shipped set to "OFF".)

• TV Format Selection (NTSC/PAL)

This unit can be set to the TV format used in your country (NTSC or PAL). NTSC is the TV format used in countries, such as the United States, Canada and Japan, and PAL is used in some European countries and Oceania.

• Formatting Cards (SD-FORMAT) (HDD-FORMAT)

Formatting a card irreversibly erases all contained data.

1 Display the menu as described on page 19.

- Press MENU again to exit.



2 Press ▲▼ to select a menu item, then press SET.

- Refer to above for details on menus.
- Refer to pages 22 and 23 for details on formatting.

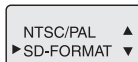

3 Press ▲▼ to select a function, then press SET.

- Selection flashes until SET is pressed.

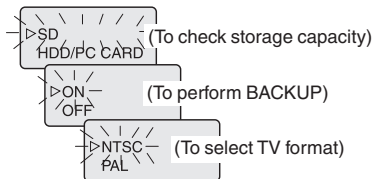

To make other settings:

Press MENU to return to Step 2.

Copy Mode (Copying)

All the data can be copied from a Memory Card to the PC Card HDD (PC Card) in a single operation. Also, data within specific folders can be copied from the PC Card HDD (PC Card) to a Memory Card by selecting the desired folders to be copied. **Be sure both a PC Card HDD (PC Card) and a Memory Card are inserted.**

1 Display the Copy menu. (p. 19)

- Press MENU to display the menu. (p. 20)

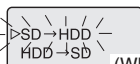

(When a PC Card HDD and SD Memory Card are inserted)

2 Press ▲▼ to select the desired menu item, then press SET.

If "HDD -> SD", press ▲▼, then SET to select a folder.

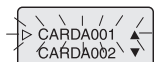

3 Press ▲▼ to select "YES", then press SET.

- After menu selection is made, card capacity is checked. If "NO CAPACITY" is displayed, Copy menu will reappear. Replace card with one containing sufficient space, then repeat these steps from the beginning.



Caution

- Never remove a card from the unit while copying is in progress.

Copying will be performed.

- Refer to "Copying and Backup" (pp. 11, 12) for data copy details.
- If existing data is to be overwritten, the message at right appears. To overwrite, press SET. To cancel, press CANCEL.



Example: SD -> HDD

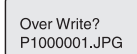

Copy completed!

- Press any button redisplay Copy menu in Step 1.

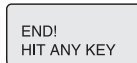

To cancel copy in progress:

1. Press CANCEL.
2. Press ▲▼ to select "YES" then press SET to execute.



- Note -

- If "SD -> HDD" has been selected, a "CARD****" folder will be created on the HDD, and the data will be copied into that folder. If a card other than a PC Card HDD is inserted, copy will be done in the folder structure of the Memory Card used.
- When copying from HDD -> SD, only the "CARD****" folder on the HDD can be copied.
- When unit is on battery power only, not pressing a button for 10 seconds changes display to show battery life remaining. Press SET to resume previous operation.
- Copying cannot be done if Memory card is write-protected.
- Secure data (including files with WMA, SA1 and MP3 extensions) will not be copied.
- If copy is canceled in progress, data copied to that point will remain on the destination card. If this data is unwanted, select TV or PC mode and delete it.

Formatting Cards

Normally you need not format (initialize) the SD Memory Card and PC Card HDD. An SD Memory Card that has been formatted to FAT32* specifications cannot be used, so transfer any important data to a PC, then format the card on this unit.

Format the SD Memory Card

1 Display the menu. (p. 19)

- See page 20 for menu details.

▶ MEDIA CAPA
BACKUP ▼

2 Press ▲▼ to select "SD-FORMAT", then press SET.

NTSC/PAL ▲
▶ SD-FORMAT ▼

3 Press ▲▼ to select "YES", then press SET.

- Selected item flashes until SET is pressed.
- Press MENU to redisplay menu.

▶ YES ◀
NO

4 Press ▲▼ to select "YES", then press SET.

- To cancel format, select "NO".

FORMAT? ▶ YES
NO

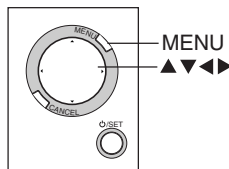
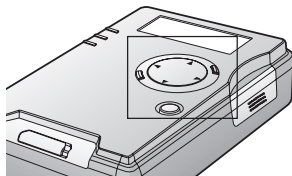

* If an SD Memory Card formatted to FAT 32 specifications is inserted, "CAN'T USE FAT32 SDCARD" will be displayed followed by a format confirmation message.

– Note –

- If "FORMAT ERROR" is displayed, remove the SD Memory Card and reinsert it. Then, repeat formatting procedure. If error reoccurs, the SD Memory Card may be damaged.
- SD Memory Card can also be formatted on some digital cameras. Refer to digital camera manual.

Caution regarding SD Memory Card Formatting

* SD Memory Cards formatted under Windows XP may be FAT 32 format because FAT 32 is the default format selected for this OS. This unit and many digital camera types do not support FAT 32. A FAT 32 formatted SD Memory Card should be reformatted on this unit or a digital camera.

Formatting Cards

Format the PC Card HDD

The product numbers for cards that can be formatted using the unit are given below. Card product numbers not listed cannot be formatted (as of Oct. 1, 2002).

Matsushita
•RP-PH005A

Toshiba
•PAMHD002
•PAMHD005

Melco
•RHDC-2G
•RHDC-5G

**Io Data
Devices**
•PCHDT-2Gt
•PCHDT-5Gt

Logitech
•LPM-HD2G
•LPM-HD5G

Kingston
•DP-PCM2/
2GB
•DP-PCM2/
5GB

1 Display the menu. (p. 19)

- See page 20 for menu details.



2 Press ▲▼ to select "HDD-FORMAT", then press SET.

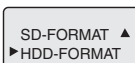

3 Press ▲▼ to select "YES", then press SET.

- Selected item flashes until SET is pressed.
- Press MENU to redisplay menu.



4 Press ▲▼ to select "YES", then press SET.

- To cancel format, select "NO".

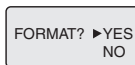

Copy Mode

Caution regarding PC Card HDD Formats

- Formatting a PC Card HDD with this unit must be done in Copy mode, not PC mode (USB connection). However, if the disk has multiple partitions created on a device, such as a notebook PC, formatting on this unit will restore the disk to a single partition (factory default). To avoid this, use the same device used previously to format the card.
- Windows 95/98 has a FDISK.EXE utility for managing disk partitions, but it must never be used to partition a PC Card HDD. Otherwise, the storage capacity of the PC Card HDD will be reported incorrectly, and it will no longer work properly. Also, do not use Windows 95/98 to format a PC Card HDD that contains multiple partitions or data in other partitions of the disk may become corrupted, and any saved data may become unusable.
- Only the first partition of a multi partition disk created on a separate device, such as a notebook PC will be recognized.
- Also avoid formatting other types of PC Cards using PC mode (USB connection), otherwise the format may not be mutually recognizable by the computer and the unit, or data corruption may occur. Always use the unit to format PC Cards.

Caution regarding Formatting

- **When a card is formatted, all data saved on the card is irreversibly deleted.** Check the card storage capacity and any data stored on the card, then copy important data to another drive or card before formatting. Also, since some files types can only be displayed on a PC, use a PC to check card contents.
- When using this unit to format cards, use only the correct type of card. Always check card storage capacity and any stored data before formatting.

TV Mode (Setup)

You can view DSC photos and PC presentation files on a TV when it is connected to this unit. Refer to next page for available functions in TV Mode.

Setup (Connections)

1 Connect the Video Cable.

- Connect this unit to either the S-Video or the video input terminal of your TV.

2 Turn on the TV and set it to VIDEO mode.

- See your TV manual.

3 Insert the Card into the unit. (p. 17)

4 Set COPY/TV MODE to "TV".



5 Insert the battery and connect the AC adaptor. (p. 16)

6 Turn on this unit. (p. 18)

- If unit is on battery power only, power shuts off automatically if no operation is done for 5 minutes to conserve battery.

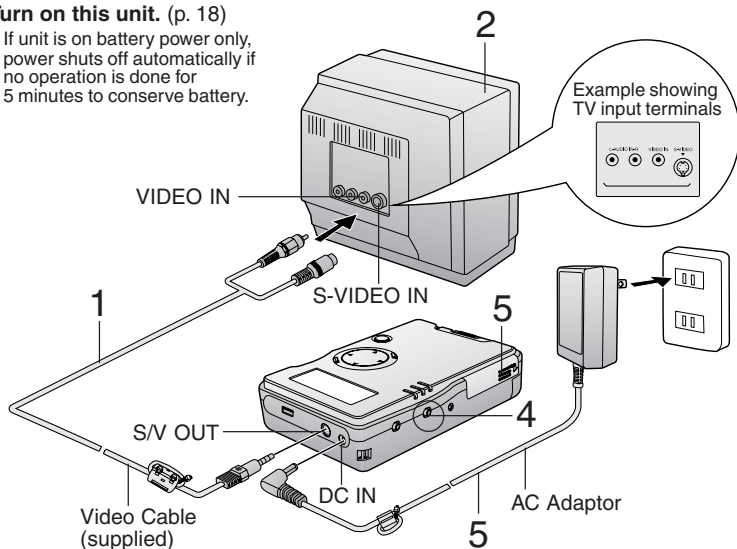

Caution

- The USB cable must be disconnected from the unit to use TV Mode. Otherwise the unit switches to PC Mode automatically.
- Always power down this unit before inserting/removing the card.

TV Mode (TV Mode Functions)

Initial Screen

The screen below is displayed when a card is inserted. If “NO CARD” appears, confirm that a card is correctly inserted.

Menu Area

Card Selection

Choose card type, HDD/PC Card • SD Memory Card. Press ▲▼◀▶ to select card for display, then press SET.

IMAGE DISPLAY

Image files stored on the card are displayed in the Index Area. They can be searched by image date. (p. 27) Images can be shown full screen, and you can use the zoom, rotate, add color effects, image information, and delete functions. (pp. 38~41)

ALBUM

Index area images can be displayed in a 6 or 9-image album screen. (p. 28) Also, when a single image is selected, you can use the functions as described in IMAGE DISPLAY, above.

SLIDE SHOW

You can set screen transition effects and speeds for a Slide Show. (pp. 29~31)

PRESENTATION

This function allows presentations to be performed. (pp. 32, 33) Using the included JPEG Addin Software, PowerPoint data created on a PC can be converted into JPEG files and used for presentations. (pp. 46, 47)

EDIT

You can delete, copy, and protect image files. (pp. 34~37)

Folder Hierarchy Indicator

- When folders are opened within the index, the number of these icons will increase to indicate the level within the hierarchy.

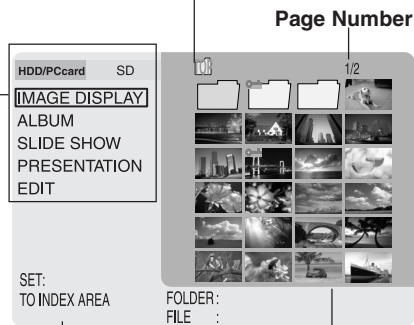

Folder/File Name Area

- Names of selected files and folders are displayed here.

Message Area

- Operation prompts are displayed here.

Index Area

- Folders and files are displayed here.

– Note –

- See page 26 regarding displayable images, folders, and files.

TV Mode (Display Information)

Displayable Image Formats

Images of the following formats can be displayed.

- DCF format 1.1 compliant
- Baseline JPEG format Y Cb Cr (compressed format)
(Sampling ratios 4:4:4, 4:2:0, 4:2:2, 4:1:1)
(80 x 60 ~ 5120 x 3840 pixels)
- TIFF format RGB (RGB 8 bit non-compressed)
(This image format takes longer to be displayed.)
- The first image from Motion JPEG (QuickTime format) files with a mov extension

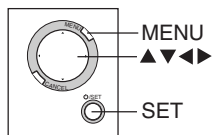
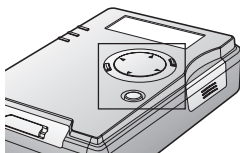





– Note –

- JPEG files altered and saved on a PC as “grayscale” format cannot be displayed.
- Some parts of an image may not be displayed or the image may be displayed on a smaller scale depending on the size of the image.

Folders and Files

Folders and files that are displayed in the Index Area (p. 25) are described in the table below. Refer to page 10 for details on the folder structure.

	Folder	Blue	Folder contains displayable images.
		Pink	Folder contains presentation files (“PRES_****”).
		Gray	Folder contains no displayable images.
 	JPEG File TIFF File	TIFF files take longer to be displayed in full screen and Slide Show. In some cases, only TIFF icons appear in index or album displays. Some files may not be displayed, or may be displayed on a smaller scale.	
	MOV File	These are files with moving images or still images with audio content. Only the first frame of a moving image is displayed. Rotated images cannot be saved.	
	Protect	Protected folders and files (p. 36) cannot be deleted.	

– Note –

File and folder names will not be displayed correctly if...

- more than 8 characters are used.
- spaces and special symbols are used. Use care when changing file and/or folder names.

TV Mode (Image Display)

Viewing Images in the Index

- 1 Press **▲▼◀▶** to select the card used, then press **SET**.
- 2 Select "IMAGE DISPLAY", then press **SET**.
 - Index Area is displayed with cursor at first position.
- 3 Press **▲▼** to scroll to other index pages if necessary.

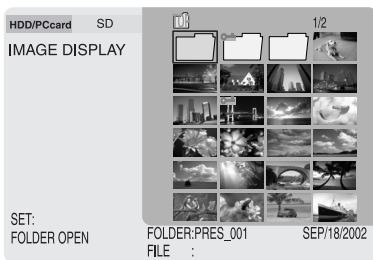

To view folder contents:

Press **▲▼◀▶** to move cursor to a folder, then press **SET**.

– Note –

- To display images in full screen, move cursor over a file and press **SET**. (p. 38)

Using the Sub Menu

- 1 Move cursor over the Index Area and press **MENU**.
- 2 Press **▲▼** to select the item (refer to the section below), then press **SET**.

SEARCH (DATE)

This searches through the folders and files in the Index Area by date. To search for files within folders, display the images within the folder and then start the search.

SEARCH (DATE)
START DATE [JAN] / 01 / 2002
▲▲◀▶: SELECT
[SET]: GO

- a Press **▲▼** to select the year, then press **◀▶** to move the cursor to the next item. Now repeat to select month and day.
- b Press **SET**.
 - A search begins for files created on or after the specified date. Results are displayed in the index in order beginning with the oldest dated file.
 - To clear search results, select "RETURN TO MENU".

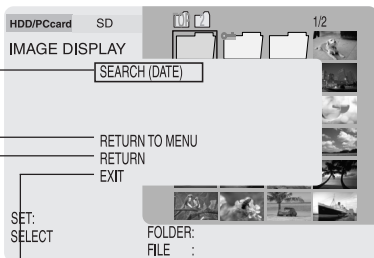

EXIT

Returns the index display to the first level of the hierarchy and moves the cursor to the Main Menu.

RETURN

Returns the display back one step in the hierarchy.

RETURN TO MENU

Returns the cursor to the Main Menu.

– Note –

- Pressing **MENU** with Sub Menu displayed removes the Sub Menu.
- Normally, files and folders are displayed in the Index Area in order beginning with the most recent date.

TV Mode (Album)

Images in the index can be displayed on a TV screen in groups of 6 or 9 at a time, like a photo album.

- 1 Press ▲▼** to select “ALBUM”, then **press SET**.
 - Only images in the Index Area can be displayed as an album. Images in a folder must first be displayed in the index. (p. 27)
- 2 Press MENU.**
 - The menu screen will be displayed.
- 3 Press ▲▼** to select “6 IMAGES” or “9 IMAGES”, then **press SET**.

To go to next or previous pages:

Press ► for next page.

Press ◀ for previous page.

To return to Index Area:

- a Press MENU.**

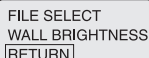

FILE SELECT
WALL BRIGHTNESS
RETURN

- b Press ▼** and select “RETURN”, then **press SET**.

- To display an image in full screen, select “FILE SELECT”, then move cursor over the image and press SET. (p. 38)

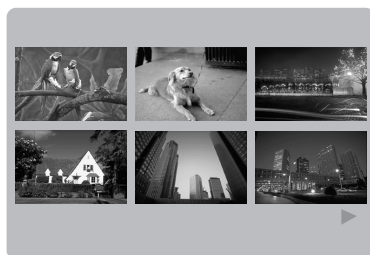
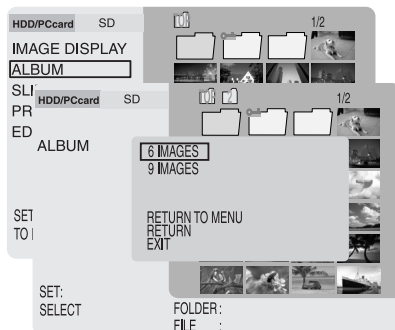

(When “6 IMAGES” is selected.)

Selecting the Background Brightness

When viewing images in Album, Full Screen (p. 38) or Slide Show (p. 29) mode on an HDTV monitor, the monitor’s “Fill-Mode” may affect the image. If brightness is compromised, follow the steps below.

- 1 Select Album display, then press MENU.**
- 2 Press ▲▼** to select “WALL BRIGHTNESS”, then **press ►**.
- 3 Press ▲▼** to select “GRAY 1”, “GRAY 2” or “GRAY 3”, and then **press SET**.
 - If using a normal TV, use the “BLACK” setting.



TV Mode (Slide Show)

You can display selected images as a Slide Show in a variety of transition effects and speeds.

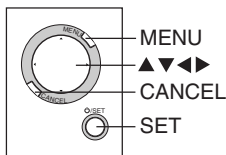
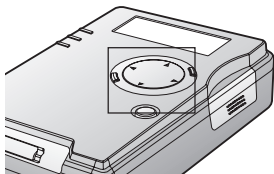

Performing Slide Show

1 Press **▲▼** to select "SLIDE SHOW", then press **SET**.

- Only images in the Index Area are displayed as a Slide Show. Images in a folder must first be displayed in the index. (p. 27)

2 Press **MENU**.

3 Press **▲▼** to select "SLIDE SETUP".

- "SELECT" → (p. 30)
- "EFFECT" → (p. 31)
- "SPEED" → (p. 31)

4 Press **▲▼** to select "START", then press **SET**.

- Slide Show begins. It ends after the last image.

To pause the Slide Show:

Press **SET**.

- **(||)** is displayed in top, left corner of screen.
- Press **SET** again to resume Slide Show.
- When the number of saved files is great, it may take time to go into Pause/Stop mode.

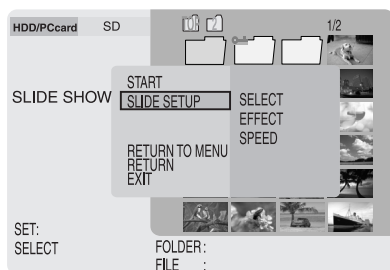
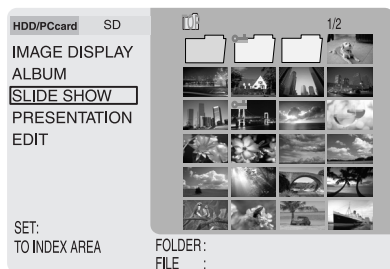

To stop the Slide Show:

Press **CANCEL**.

TV Mode

– Note –

- The Sub Menu will disappear if MENU is pressed while the Sub Menu is displayed.
- Selecting "RETURN TO MENU" will redisplay the Main Menu. Selecting "RETURN" changes the display back one level. Selecting "EXIT" returns display to first level of hierarchy (p. 27).
- It may not be possible to display some types of TIFF files during album display.
- It will take a longer time to display TIFF files during Slide Show.

TV Mode (Slide Show Settings)

The SLIDE SETUP setting allows you to specify which images to display in a Slide Show. (p. 29)

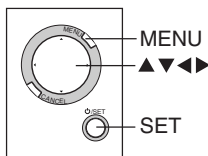
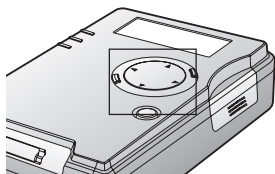

Selecting Images

Specify the images in the index to be included in the Slide Show. If you wish to include all images in the index, this procedure is not necessary.

1 Do Steps 1~3 on page 29. In Step 3, press **▶** to select "SELECT".

2 Press **SET**.

- The cursor will move to the beginning of the index.

3 Press **▲▼◀▶** to select an image, then press **SET**.

- Pressing SET again to cancel selection.
- "●" appears at the bottom, right corner of a selected image.
- Repeat Step 3 until all images for the Slide Show are selected. Images will be displayed in the order selected.
- Images in a folder must first be displayed in the index for selection. (p. 27)

4 Press **MENU** when selection is complete.

5 Press **◀▶** to select "YES", "CONTINUE" or "CANCEL", then press **SET**.

- YES** : To exit setup.
- CONTINUE** : To continue selection.
- CANCEL** : To cancel image selection.

6 Press **◀** to return to "SLIDE SETUP".

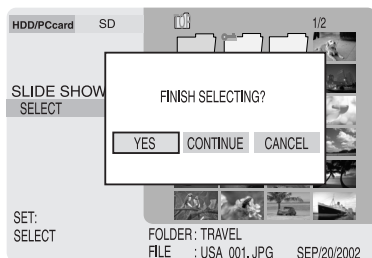
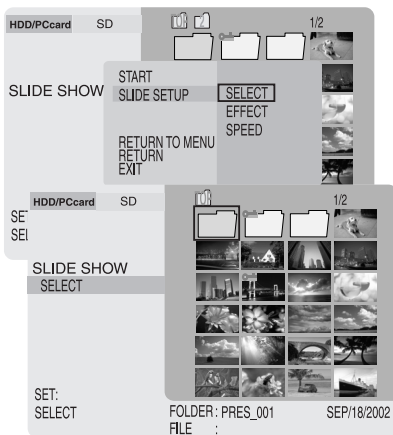

TV Mode (Slide Show Settings)

Setting Screen Transition Effects

- 1 Do Steps 1~3 on page 29. In Step 3, press **▶** to select "SELECT".
- 2 Press **▲▼** to select "EFFECT", then press **SET**.
- 3 Press **▲▼** for desired transition effect, then press **SET**.
 - **NORMAL** : images change one by one.
 - **WIPE** : images change from top to bottom.
 - **SPLIT** : images change from middle to each side.
 - **BLIND** : images change in a window blind fashion.
- 4 Press **◀** to return to "SLIDE SETUP".

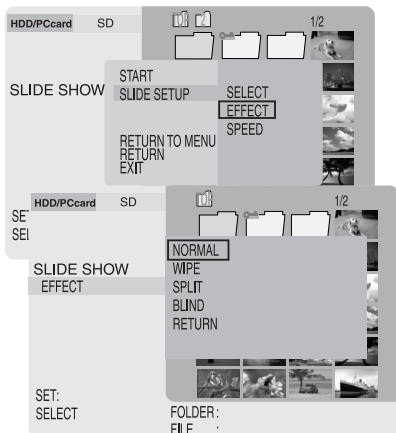

Setting Screen Transition Speed

- 1 Do Steps 1~3 on page 29. In Step 3, press **▶** to select "SELECT".
- 2 Press **▲▼** to select "SPEED", then press **SET**.
- 3 Press **▲▼** for desired transition speed, then press **SET**.
 - **FAST** : images change every 2 seconds.
 - **NORMAL** : images change every 5 seconds.
 - **SLOW** : images change every 10 seconds.

* If larger file size images are included, display takes longer and transition time may exceed the selected setting.
- 4 Press **◀** to return to "SLIDE SETUP".

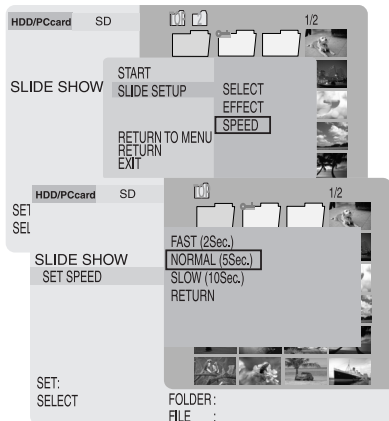

– Note –

- The Sub Menu will disappear if MENU is pressed while the Sub Menu is displayed.
- Selecting "RETURN TO MENU" will redisplay the Main Menu.
Selecting "RETURN" changes the display back one level.
Selecting "EXIT" returns display to first level of hierarchy (p. 27).
- If "RETURN" is selected or MENU is pressed from the "EFFECT" or "SPEED" menu, the display returns to the previous sub menu.

TV Mode (Presentation)

Microsoft PowerPoint data created on a PC can be converted into JPEG files using the supplied JPEG Addin Software and then presented on the TV. See pages 46 and 47 on how to create presentation files.

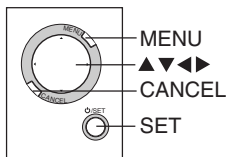
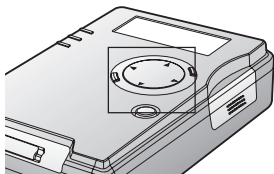

Performing Presentation

1 Press **▲▼** to select “PRESENTATION”, then **press SET**.

- Make sure a folder (pink) containing presentation files exists in the index.

2 Press **MENU**.

3 Press **▲▼** to select “START”, then **press SET**.

- Only folders containing presentation files will be displayed in the Index Area.
- To customize presentation data, press **MENU** again, then select “SET CONTENTS”. (p. 33)

4 Press **▲▼◀▶** to select a folder, then **press SET**.

- The first slide is displayed.

To display the next slide:

Press **▶**.

- Pressing **◀** displays previous slide.

To exit presentation:

Press **CANCEL**.

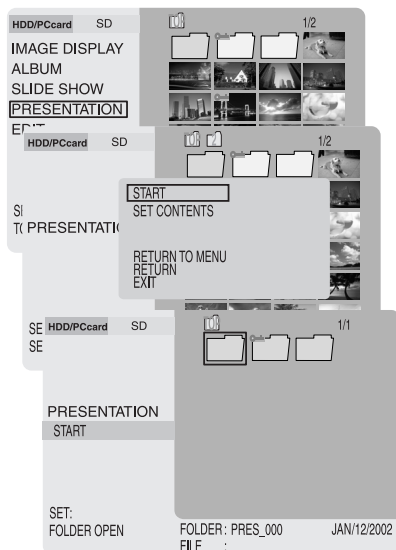

– Note –

- Selecting “RETURN TO MENU” will redisplay the Main Menu. Selecting “RETURN” changes the display back one level. Selecting “EXIT” returns display to first level of hierarchy (p. 27).
- Slides will be presented in the order they were selected. You can confirm presentation files and the order in the index. This data is stored on the unit until selections are deleted. (p. 33)
- Only folders entitled “PRES_****” (last 3 digits “****” are variable) are recognized as presentation folders. If you change the folder name on a PC, only change the last 3 digits, otherwise, it will not be recognized.

TV Mode (Presentation)

Selecting Presentation Content

You can select specific slides from the index to be displayed. If you wish to include all images in the index, this procedure is not necessary.

- 1 Do Steps 1~3 on page 32. In Step 3, select "SET CONTENTS", then press SET.**
- 2 Press ▲▼◀▶ to select a folder, then press SET.**
 - Folder contents will be displayed.
- 3 Press ▲▼ to select "SLIDE SELECT", then press SET.**
 - Selecting "RETURN" displays previous slide.
- 4 Press ▲▼◀▶ to select a slide, then press SET.**
 - Pressing SET again cancels selection.
 - "●" appears at bottom, right corner of a selected slide.
 - Repeat Step 4 until all slides to be displayed are selected. Presentation will be in the order slides were selected.
- 5 Press MENU when selection is complete.**
- 6 Press ◀▶ to select "YES", "CONTINUE" or "CANCEL", then press SET.**
 - YES** : To finish selection.
 - CONTINUE**: To continue selection.
 - CANCEL** : To cancel selection and return to menu.

To unselect images:

Press ▲▼ to select "RELEASE", then press SET.

- The selected images are returned to their original state.

To preview the presentation contents (REHEARSAL):

Press ▲▼ to select "REHEARSAL", then press SET.

- Each slide will appear approx. 2 seconds.
- Pressing CANCEL will cancel this operation.
- Pressing SET will pause this operation.
- When the number of saved files is great, it may take time to go into Pause/Stop mode.

- 7 Press ▲▼ to select "RETURN", then press SET.**
 - To proceed with presentation, return to Step 3 on page 32.

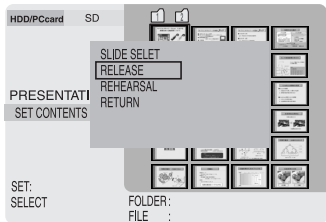
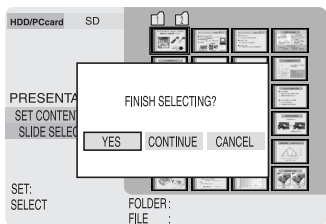
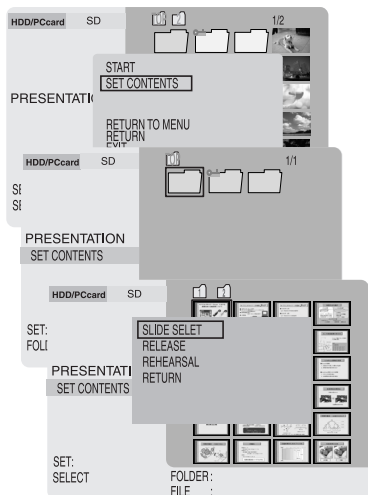

TV Mode (Editing)

You can delete images from a card, copy data from one card to another, and protect data from being deleted accidentally.

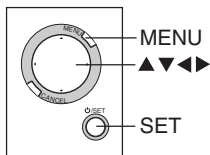
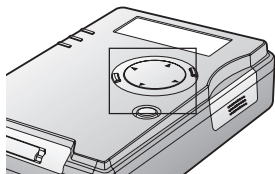

Deleting Images (DELETE)

- 1** Press ▲▼ to select "EDIT", then press SET.
- 2** Press MENU.
 - The Menu screen will be displayed.
- 3** Press ▶ to move the cursor to the right. Press ▲▼ to select "SELECT" or "ALL", then press SET.
 - **SELECT** : To select specific images and folders to be deleted.
 - **ALL** : To delete all images/folders displayed in the index. Those not displayed are not deleted.
 - Protected images cannot be deleted unless protection is canceled. (p. 36)
 - To select a file within a folder, it must first be displayed in the index. (p. 27)

For "select delete", follow "How to Select Images" instructions on page 37.

- 4** Press ◀▶ to select "YES", then press SET.
 - The selected images will be deleted.
 - To cancel the operation, select "NO".

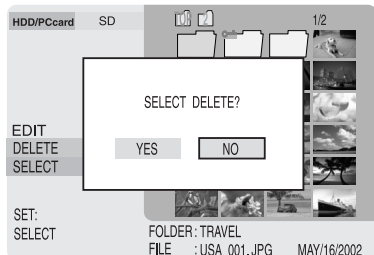
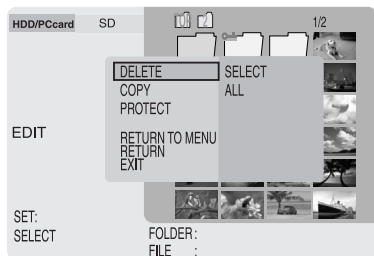
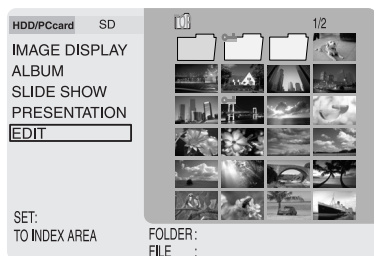

(Example: when selecting "SELECT")

TV Mode (Editing)

Copying Images (COPY)

Copy data from one card to another. A card to receive copied data must be inserted.

1 Press ▲▼ to select “EDIT”, then press SET.

2 Press MENU.
• The Menu screen will be displayed.

3 Press ▲▼ to select “COPY”, then press ► to move the cursor to the right.

4 Press ▲▼ to select “SELECT” or “ALL”, then press SET.

- **SELECT** : To select specific images and folders to be copied*.
- **ALL** : To copy* all images/folders displayed in the index.

* When a folder is copied, all contents including non-image files are copied.
• To select a file within a folder, it must first be displayed in the index. (p. 27)

For “select copy”, follow “How to Select Images” instructions on page 37.

5 Press ◀▶ to select “YES”, then press SET.
• Images are copied to the other card.
• To cancel the operation, select “NO”.

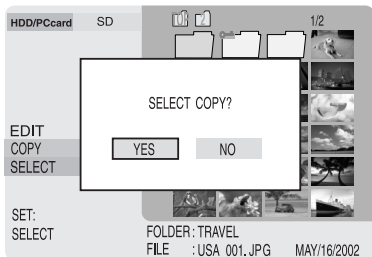
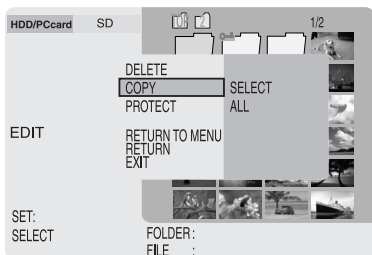
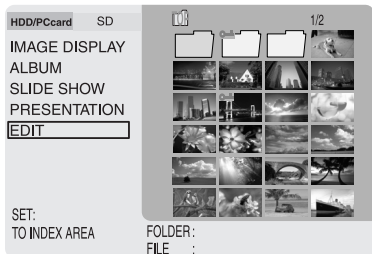

(Example: when selecting “SELECT”)

– Note –

- The Sub Menu will disappear if MENU is pressed while the Sub Menu is displayed.
- Selecting “RETURN TO MENU” will redisplay the Main Menu.
Selecting “RETURN” changes display back one level.
Selecting “EXIT” returns display to first level of hierarchy (p. 27).
- “ALL” selection deletes all files within a folder, so check folder contents before proceeding.
Files/folders not displayed are not deleted.
- Gray folders contain no displayable files and cannot be deleted.
- Any files with the same first eight characters in their file names as those selected will be copied or deleted as well.

TV Mode (Editing)

Protecting Images (PROTECT)

Important file data can be protected from accidental deletion.

- 1** Press **▲▼** to select “EDIT”, then press **SET**.
- 2** Press **MENU**.
 - The Menu screen will be displayed.
- 3** Press **▲▼** to select “PROTECT”, then press **▶** to move the cursor to the right.
- 4** Press **▲▼◀▶** to select “SELECT” or “ALL”, then press **SET**.
 - **SELECT** : To select specific images and folders to protect*.
 - **ALL** : To protect* all images/folders displayed in the index.

* When a folder is protected, all contents, including non-image files, are protected.

For “select protect”, follow “How to Select Images” instructions on page 37.

- 5** Press **◀▶** to select “SET”, then press **SET**.
 - The image or folder will be protected.
 - A “key” icon appears in the upper, left corner of the image.
 - To cancel protection of an image, select “RELEASE”.

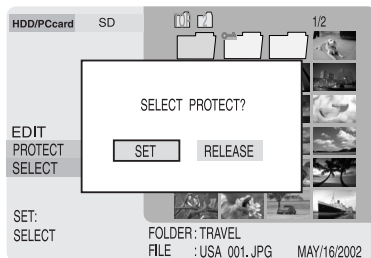
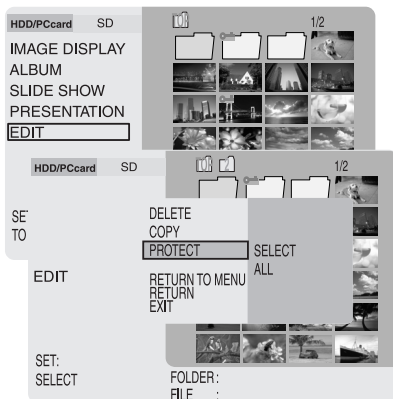

– Note –

- The Sub Menu will disappear if MENU is pressed while the Sub Menu is displayed.
- Selecting “RETURN TO MENU” will redisplay the Main Menu. Selecting “RETURN” changes display back one level. Selecting “EXIT” returns display to first level of hierarchy (p. 27).
- Any files with the same first eight characters in their file names as those selected will be protected as well.

TV Mode (Editing)

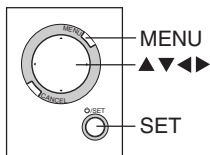
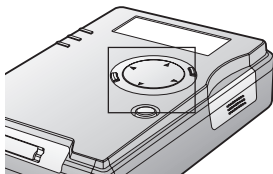

How to Select Images

Select image files for the DELETE, COPY, and PROTECT functions. The example screens below depict deleting an image.

1 Press **▲▼◀▶** to select an image, then **press SET**.

- Pressing SET again cancels selection.
- **●** appears in the bottom, right corner of the selected image.
- Repeat Step 1 until all desired images are selected.

2 Press **MENU** when image selection is finished.

- Pressing MENU again resumes selecting operation.

3 Press **◀▶** to select "YES", "CONTINUE" or "CANCEL", then **press SET**.

- **YES** : To finish selection.
- **CONTINUE** : To continue selection.
- **CANCEL** : To cancel selection and return to menu.

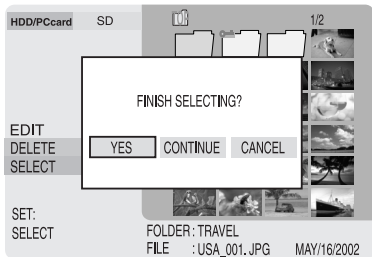
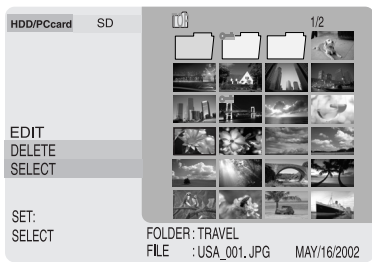

TV Mode (Full Screen Playback)

When in image display or album mode, you can view an image full screen. Also, you can use zoom, rotate, add color effects, display image information, and delete the image.

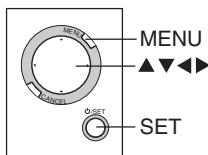
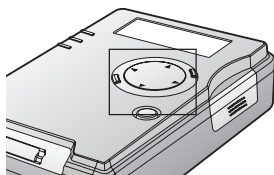

Selecting Images

Display an Image (from the index)

- 1 Display the index. (p. 27)
- 2 Press **▲▼◀▶** to select a file, then press **SET**.
 - Image is displayed in full screen.

To display the next image:

- Press **▶** to display next image in the current index.
- Press **◀** for previous image.



Display an Image (from an album)

- 1 Display an album. (p. 28)
- 2 Press **MENU**.

FILE SELECT
WALL BRIGHTNESS
RETURN
- 3 Press **▲▼** to select "FILE SELECT" then press **SET**.

To display the next image:

- Press **▶** to display next image in the current album.
- Press **◀** for previous image.



TV Mode (Full Screen Playback)

Displaying the Sub Menu

With a full screen index or album image displayed, you can zoom, rotate, add color effects, and display image information.

Press MENU to display the sub menu for function selection.

- Selecting "RETURN", then pressing SET redisplay the index or album.
- Sub menu functions are described on pages 39-41.

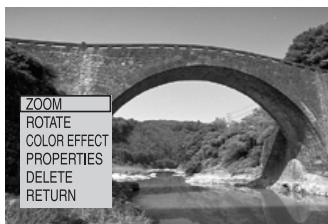

Before operating any function, press MENU for Sub Menu.

Enlarging an Image (ZOOM)

Images can be displayed 2 or 4 times their normal size.

- 1** Press **▲▼** to select "ZOOM" from the sub menu, then **press SET**. (Refer to the above section.)
- 2** Press **▲▼** to select "X 2" or "X 4", then **press SET**.
- 3** Press **▲▼◀▶** to select an area for zooming, then **press SET**.
 - To enlarge a X2 image to X4, press MENU and select "X4", then press SET. Now, repeat Step 3.
 - You can change the viewing area in a zoomed image with **▲▼◀▶**.



To return image to normal size:

Select "RETURN" from the zoom menu, then press SET.

- Repeat above if image is X4.

To delete the image:

- a** Select "DELETE" from the zoom menu, then press SET.
- b** Press **◀▶** to select "YES", then press SET.

- Note -

- Selecting "RETURN" redisplay previous menus, one by one.
- To temporarily exit the sub menu, press MENU. Pressing MENU again displays the menu previous to the one just exited.
- Some images appear grainy when enlarged.

TV Mode (Full Screen Playback)

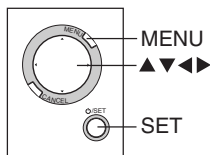
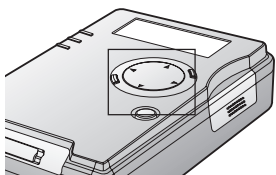

Rotating an Image (ROTATE)

- 1** Press **▲▼** to select "ROTATE" from the sub menu, then **press SET**.
(p. 39)
- 2** Press **◀▶** to select "LEFT" or "RIGHT", then **press SET**.
 - **LEFT** : image is rotated 90° counterclockwise.
 - **RIGHT** : image is rotated 90° clockwise.

To save rotated images:

Select "SAVE" from the rotate menu, then press SET.

- Image will hereafter be displayed in the saved form.

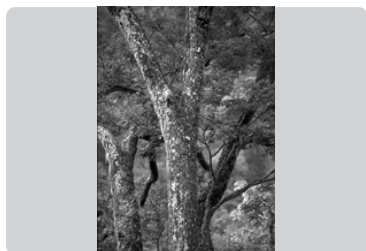

(When "LEFT" is selected)

– Note –

- Selecting "RETURN" redisplayes previous menus, one by one.
- To temporarily exit the sub menu, press MENU. Pressing MENU again displays the menu previous to the one just exited.
- MOV files and some other types of rotated image files cannot be saved.

TV Mode (Full Screen Playback)

Processing Image Color (COLOR EFFECT)

You can change the image color.

1 Press **▲▼** to select “COLOR EFFECT” from the sub menu, then press **SET**. (p. 39)

2 Press **▲▼** to select “B/W” or “SEPIA”, then press **SET**.

- The image color will change.
- Selecting “RETURN”, then pressing **SET** restores image's original coloration.



Displaying Image Information (PROPERTIES)

File name, date, and size are always displayed on all full screen images.

1 Press **▲▼** to select “PROPERTIES” from the sub menu then press **SET**. (p. 39)

- When a single image is displayed in a full screen, the image information will remain constantly displayed.
- Once this setting is made, information will appear on any image displayed in full screen while the unit is on. Properties is canceled when unit is turned off.

To cancel properties display:

Repeat the above procedure.



PC Mode (Setup)

By connecting this unit to a PC via the supplied USB cable, it can be utilized as an external drive.

System Requirements

System requirements are shown below.

Compatible PC Models	• PC / AT compatible (PCs with USB port)
OS Compatibility	• Windows®98SE • Windows®2000 • Windows®Me • Windows®XP

PC must come factory equipped with a USB port and preinstalled with one of the OS listed above.

- For Windows 98SE, a CD-ROM drive is required to install the driver.
- If more than one USB device is connected to a PC, or if a USB hub or USB extension cable is used, correct operation is not guaranteed.

Setup (Connections)

- 1 Turn on the PC and start Windows.**
- 2 Install a fully charged battery, then connect AC adaptor, then turn this unit on. (p. 18)**
- 3 Connect unit to PC with supplied USB cable.**
 - PC begins automatic hardware detection. Messages displayed depend on OS used.
 - Windows 98SE requires a dedicated driver. See next page for the driver install procedure.

Caution

- Connect USB cable correctly, referring to the  symbol on the PC USB port. For more on USB connection, see your PC manual.
- **For PC connection, a fully charged battery must be installed, followed by the AC adaptor.** Without a battery installed, power will not be supplied. It is recommended that you charge the battery fully before use.
- Never disconnect USB cable or AC adaptor during communication between the unit and PC. Otherwise, operation will terminate abnormally. If this happens, restart the PC, immediately run ScanDisk/CheckDisk, and make a backup of data. (p. 9) Data integrity cannot be guaranteed, even if this procedure is followed, so always place the unit on a stable, level surface, and never disconnect USB cable or AC adaptor during use. Refer to page 49 for what to do if the HDD SAFETY is activated.
- Always start up the computer before connecting the USB cable.

- Note -

- With USB cable connection, PC may take longer to detect this unit. During this period, no operations can be performed from the PC.

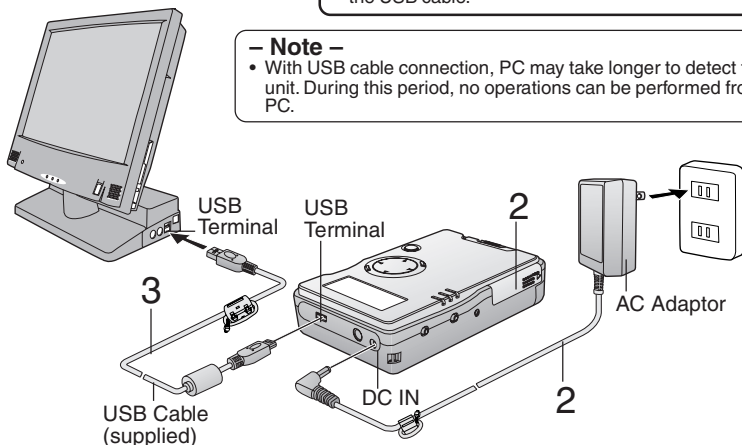

PC Mode (USB Driver)

Installing the USB Driver

- 1** Make connections following “Setup (Connections)” steps on page 42.
 - The “Add New Hardware Wizard” screen is displayed.
- 2** Insert the supplied CD-ROM into the PC’s CD-ROM drive.
- 3** In the “This wizard searches for new drivers for.” dialog box, click on **1** [Next].
- 4** With “Search for the best drive for your device. [Recommended]” checked, click on **2** [Next].
- 5** With “CD-ROM drive” checked, click on **3** [Next].
 - Uncheck the [Floppy disk drives] box.
- 6** In the “Windows driver file search for the device.” dialog box, click on **4** [Next].
 - A file copy / driver information database will be created.
- 7** With “Windows has finished installing the software that your new hardware device requires” displayed, click on **5** [Finish].

(Only for Windows 98SE)

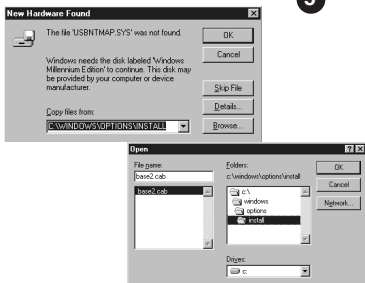
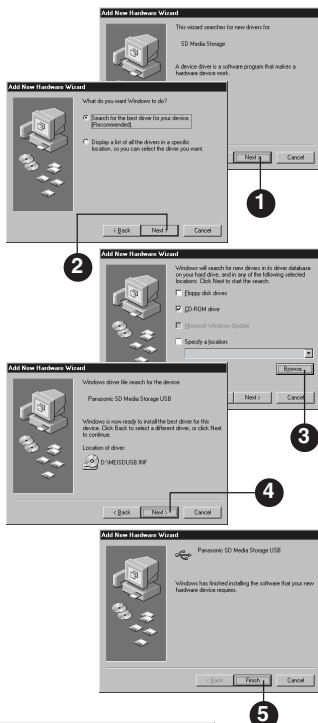

If using Windows Me:

Depending on the PC, a message window, such as the one on the right, may appear during automatic recognition. If so, click [Browse], select the c:\windows\options\install folder from the drop down list, then click [OK]. Afterwards, confirm that path “c:\windows\options\install” appears in the “Copy to (C)” box in the top window, then click [OK].

– Note –

- Selecting [Return] redisplayes previous menus, one by one.
- Once the USB driver is installed successfully, it need not be installed again for USB connection.
- After installation, double-click the “ My Computer” icon and confirm that a “Removable Disk” icon was added to the drive icon list.

PC Mode (Operation with the PC)

When this unit is connected to a PC using the USB Cable provided (p. 42), it will be recognized as a Removable Disk. You can then copy, move, delete, and display files on this unit the same as with a normal disk drive.

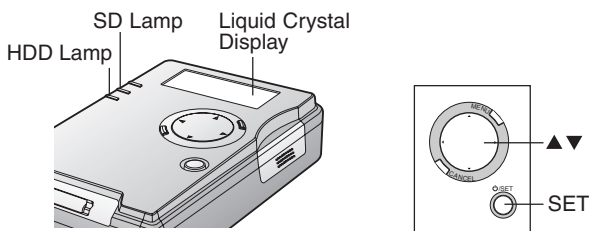

File Operations

1 Make connections following “Setup (Connections)” steps on page 42.

2 Select and change to another card.

- With a USB cable connected, selecting another card will terminate communication with the PC. Do Steps 1~4 of “Disconnecting Unit from PC” on page 45, then proceed with the following operation.

Press **▲▼** to select “SD” or “HDD (PC Card)”, then press **SET**.

- While the SD or HDD lamp is flashing, “CANNOT CHANGE SLOT” is displayed and operation is not possible. After the lamp goes out, press SET again. (Liquid Crystal Display)

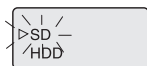

3 Double-click [My Computer], then double-click [Removable Disk].

- Files contained on the card will be displayed and normal PC operations can be done.
- If no removable disk is found, refer to “Reinstalling the Device Driver” on page 48.

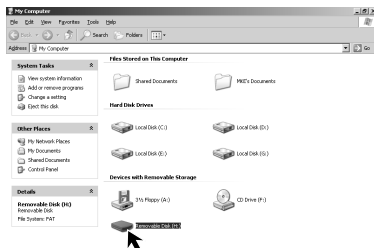

– Note –

- Drive letters (e.g. “H:”) and method of opening My Computer may vary depending on the PC.
- With USB cable connected, the “Removable Disk” icon will not appear while the SD or HDD Lamp flashes as the PC checks the connection. Check for the icon once the indicator goes out. It may take several minutes for the PC to recognize the PC Card HDD device.

PC Mode (Operation with the PC)

Disconnecting Unit from PC

- 1 Confirm SD and HDD Lamps are out and card is not being accessed.
- 2 Click on  [Safety Remove Hardware] icon in the desktop task tray.
- 3 Select [USB Mass Storage Device] and click [Stop].
 - For Windows Me, "Unplug or eject hardware" will be displayed.
 - The message "Stop a Hardware device" will be displayed.
 - If this unit is disconnected from the PC while an application is running, an error message may appear. In this case, close the application, then disconnect the unit.
- 4 Click on [OK].
 - The USB cable can now be safely disconnected and the unit removed.
- 5 Disconnect the USB Cable from the PC.

Caution

- Never unplug USB cable while the card in this unit is being accessed. This may damage the unit and the data. Always follow above procedure when removing USB cable.
- With Windows 98SE, there is no special "Safety Remove Hardware" operation. If using Windows 98SE, do not repeatedly remove and connect the unit or repeatedly switch the computer to standby or off while the unit is connected.
- PC Card HDD can be directly inserted into Card Slot of a PC and used as a disk drive. However, always click on the PC card icon (Step 2 above) when removing the PC Card HDD.

– Note –

- Messages displayed by your PC may vary.

To change the Card:

Do Steps 1~4 of "Disconnecting Unit from PC" above, then change the card following step 2 on page 44.

To replace the Card:

Do Steps 1~5 of "Disconnecting Unit from PC" above. Then, after first turning unit power off, replace the card following the procedure on page 17.

To turn unit power off while PC is connected:

Do Steps 1~5 of "Disconnecting Unit from PC" above, then turn unit power off.

PC Mode (Using the Applications)

The included CD-ROM contains a “JPEG Addin Software” application which converts Microsoft PowerPoint data created on a PC into JPEG files and creates a presentation folder (p. 47) for TV screen presentation (pp. 32, 33).

- Recommended for use with a 300 MHz or higher CPU (or equivalent CPU) and at least 128 MB of memory. Also, Microsoft® PowerPoint® 97/2000/2002 must be installed prior to use.

Installation

- 1 Turn on the PC and start Windows.
- 2 Load included CD-ROM into PC CD-ROM drive.
 - CD-ROM folder opens automatically. If not, open from [My Computer].

- 3 In the [Setup] folder, double-click on [Setup.exe].
 - The setup program will be executed.
 - If PowerPoint has not been installed, a warning is displayed. Click [OK], then install PowerPoint.

- 4 Click on [Next].

- 5 Confirm installation destination, then click on [Next].
 - To install into another folder, click on [Browse] and select a folder.

- 6 Click on [Finish].
 - If you do not want to restart the computer right away, select “No, I will restart my computer later.”

- 7 Be sure CD-ROM access light is out before removing the CD-ROM.
 - This completes installation.

- 8 Start PowerPoint confirming that the icon, right, is added.
 - When PC restarts, if a message, such as “Please install a JPEG filter” appears, install “JPEG File Interchange Format Import” provided with PowerPoint.

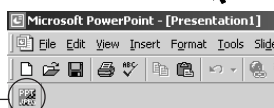
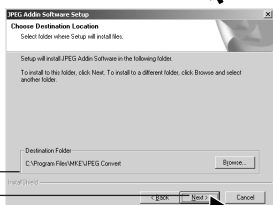

– Note –

- The way to open folders, shape of “Setup.exe” icon, double or single clicking, and PC messages vary according to the PC and OS used.

PC Mode (Using the Applications)

Presentation File Creation

- 1 Install JPEG Addin Software (p. 46), then start PowerPoint on the PC.
- 2 Select [Open] from [File] menu to open a PowerPoint file for JPEG conversion.
- 3 Connect PC using supplied USB cable. (p. 42)
- 4 Click  in the upper, left corner. (p. 46)
 - If "Drive not found." appears, click [OK].
- 5 Select "Removable Disk" as the save destination.
 - Select "SD" or "HDD (PC Card)" as the save destination, then specify the drive to be recognized as the removable disk drive corresponding to the connected unit. (p. 44)

To change an image name:

 - Type in a five-character alphanumeric name.
Do not use spaces or special symbols.
 - Default name is "sheet".

To change the image size:

 - Certain TV types may cut off image edges when displayed on the screen. Thus, the default image size value is set at 90%. To enlarge, select 100%.

About flicker reduction processing:

 - Images are processed to reduce TV screen flicker. It is advisable to leave this option checked.
- 6 Click on [Create].
 - Conversion of PowerPoint files to JPEG files is started. Afterward, "It was created." is displayed.
- 7 Click on [OK].
- 8 Check the created folder.
 - a Confirm that a save destination folder was created on the PC.
 - b Disconnect the USB cable correctly. (p. 45)
 - c Switch to TV mode and confirm the folder color is pink. (pp. 24~26)

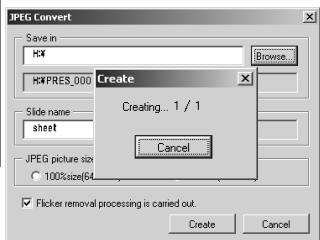
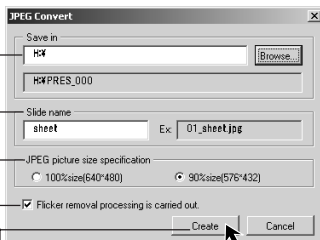

Caution

- Only folders entitled "PRES_****" (last 3 digits "****" are variable) are recognized as presentation folders. If you change the folder name on a PC, only change the last 3 digits. Otherwise it will not be recognized.
- For Windows 98SE/Me, a limited number of JPEG files can be created. If an error occurs during conversion, restart the PC, then repeat this operation. The number of files that can be converted will vary depending on PC environment, such as the number of open applications and the number of resident programs.

PC Mode (Other)

Uninstalling JPEG Addin Software

For Windows XP, log in with the same username used when software was installed.

- 1 Click “Start”, “Settings”, and “Control Panel”.**
 - For Windows XP, Click “Start” and “Control Panel”.
- 2 Double-click “Add/Remove Programs”.**
 - For Windows XP, click “Add or Remove Programs”.
 - A list of the programs that are currently installed will be displayed.
- 3 Select “JPEG Addin Software”, then click [Add/Remove].**
 - For Windows Me/XP, click [Change/Remove].
- 4 Click on [OK].**
 - The JPEG Addin Software will then be uninstalled.
 - To cancel, click [Cancel].

Reinstalling the Device Driver (Windows 98SE/Me)

If the unit device cannot be found on the PC, it may be due to incorrect device driver installation. Reinstall the driver as follows.

- 1 Right-click the My Computer icon, and then select “Properties”.**
 - The “System Properties” screen will be displayed.
- 2 Click the “Device Manager” tab.**
- 3 Select “Panasonic SD Media Storage USB”, then click [Remove].**
- 4 Click on [OK].**
- 5 Click on [Refresh].**
 - The Add New Hardware Wizard will start. Refer to page 43 for details on installing the driver.

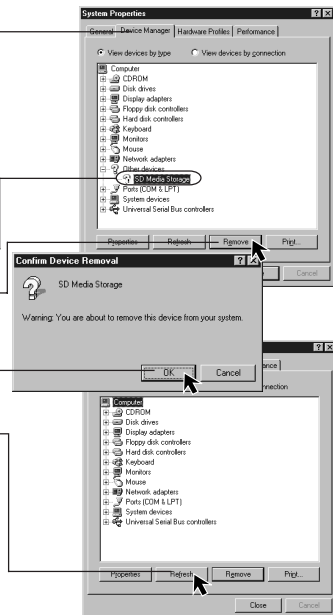

HDD SAFETY Switch Operation

When using a USB connection, place the unit device on a flat, level surface. If the HDD SAFETY switch is activated, carry out the following remedies.

● For Windows 98SE/Me

If the HDD SAFETY Detection Switch is activated while a PC Card HDD is being accessed, the PC screen goes blue and the following message appears.

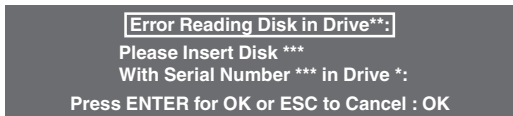

- a “SAFETY MODE PUT IT DOWN” appears on the unit LCD. **Make sure that the unit is always placed on a flat, level surface.**
- b When the unit LCD changes to “SD” or “HDD” selection screen, and the HDD Lamp starts flashing, **press [Enter]**.
- The PC screen will turn black momentarily and the unit will then continue the operation that was in progress before the switch was activated. Wait for a short period while the HDD Lamp flashes. If the HDD Lamp stays off and the PC screen does not return to its previous state, press [Enter] once more. If this has no effect, disconnect the USB cable and restart the computer.
 - After processing is complete, check that the required operation has completed normally. Repeat the operation if necessary.

● For Windows 2000/XP

If the HDD SAFETY Detection Switch is activated while the PC Card HDD is being accessed in PC mode, the following message may appear.

[For Windows 2000]

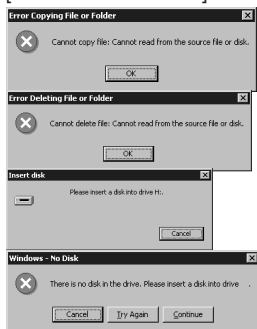

[For Windows XP]

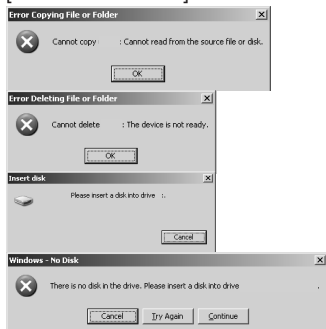

Place the unit on a flat, level surface, and then click [OK], [Cancel], [Try Again] or [Continue].

- Processing will be interrupted, so repeat the operation.

– Note –

- If the HDD SAFETY switch was activated while the PC Card HDD was being accessed, it is advisable to run ScanDisk/CheckDisk on the computer. (p. 9)

Warning and Instruction Displays

Copy Mode (Liquid Crystal Display)

Indications	Condition
PLEASE INSERT BATT.	Insert battery. Power will not turn on without battery inserted.
NO CARD	Insert the card.
NO DATA	No data is stored on the card.
INIT ERROR	An error has occurred during initialization of the HDD/PC Card. Turn off the power, then reinsert the card. If error occurs again, format the card (p. 23), then reinsert it. If error still occurs, card may be damaged.
FORMAT ERROR	An error occurred during card formatting. Re-insert card and format again. (pp. 22, 23)
NO CAPACITY	Insufficient free space on the copy destination disk. Delete unnecessary files, or insert a card with sufficient free space.
CARD PROTECT	The card is protected. Cancel the protection to resume operation. Refer to documentation provided with the card.
COPY ERROR HIT ANY KEY	An error occurred during copying. Press any key, then reset the unit (p. 52), or turn the power off, then back on again and repeat copying operation.
SAFETY MODE PUT IT DOWN	The HDD SAFETY Detection Switch has activated and the HDD has stopped for protection. Place the unit on a flat, level surface.
CAN'T USE FAT32 SDCARD	SD Memory Cards formatted to FAT32 specifications cannot be used. "Format?" will be displayed. Transfer desired files to PC, then format the card. (pp. 22, 23)
CAN'T COPY SECURE FILES	Secure data files (audio files that include copyright restrictions) cannot be copied.
BATTERY LOW	The battery is spent. Copy operation will stop and power will turn off. Recharge the battery.
COPY CANCEL BATTERY LOW	The battery is spent. The copy operation will be canceled and the power will turn off. Then recharge the battery.
PC CARD CAN'T FORMAT	The PC Card cannot be formatted.

Warning and Instruction Displays

PC Mode (Liquid Crystal Display)

Indications	Condition
CONNECT AC	Connect the AC adaptor.
CANNOT CHANGE SLOT	Selection cannot be changed between a PC Card HDD/PC Card and an SD Memory Card during data transfer between the unit and a PC. Wait for transfer to finish, then make your selection.
INSERT BATT.	Insert the battery.
DISCONNECT USB ↓ PULL OUT USB CABLE	Data transmission was interrupted. Disconnect the USB cable. Check that the battery and AC adaptor are connected correctly, then reconnect the USB cable.
MODE CHANGE PLEASE WAIT	The mode is being changed. Please wait a moment.
POWER OFF PLEASE WAIT	After processing is finished, the power will turn off.
SAFETY MODE PUT IT DOWN	The HDD SAFETY Detection Switch has activated and the HDD has stopped for protection. Place the unit on a flat, level surface.

TV Mode (TV Screen Display)

Indications	Condition
NO CARD	Insert a card.
NO DATA	There is no data on the card or in the folder.
INITIALIZE ERROR	An error has occurred during HDD/PC Card initialization. Turn power off, then reinsert the card. If error is repeated, format the card (p. 23) and reinsert it. If error persists, card may be damaged.
FORMAT ERROR	An error occurred during formatting of the card. Reinsert the card and then reformat it. (pp. 22, 23)
NO IMAGE FILE	There are no JPEG or TIFF files in the folder that can be displayed.
NO CAPACITY	Insufficient free space on the copy destination disk. Delete unnecessary files, or insert a card with sufficient free space.
COPIED EXCEPT SECURE FILES	Secure data files (audio files that include copyright restrictions) cannot be copied.

(Continued on next page.)

Warning and Instruction Displays

TV Mode (TV Screen Display)

Indications	Condition
COPY ERROR	The specified operation did not execute correctly. Reset the unit (see below), or turn power off, then back on and repeat the operation.
DELETE ERROR	
PROTECT ERROR	
CAN'T READ SETTING FILE	
CAN'T DISPLAY	An image file could not be displayed. The file is corrupt or the format is incompatible.
FOR HDD SAFETY PUT UNIT DOWN	The HDD SAFETY Detection Switch has activated and the HDD has stopped for protection. Place the unit on a flat, level surface.
THIS FILE ISN'T EXIF CAN'T SAVE THIS FILE	Rotated images cannot be saved.
NO SUPPORT FAT32 SD CARD	SD Memory Cards that have been formatted to FAT32 specifications cannot be used.
CANNOT SELECT	Folders cannot be selected for Slide Show. Open a folder, then select files.
BATTERY LOW	The battery is spent. Operation will be canceled and power will turn off. Recharge the battery.
COPY CANCEL BATTERY LOW	The battery is spent. Copy operation will stop and power will turn off. Recharge the battery.
NOT SELECTED	The operation timed out due to no selection during a Slide Show, presentation, copying, deleting or file protecting operation. Repeat the selection.
BATTERY LOW PLEASE POWER OFF	Battery level is getting low. Turn off the power and recharge the battery.
DELETE EXCEPT PROTECT AND CAN'T VIEW FILE	Protected files and files that cannot be displayed cannot be deleted.
CARD IS WRITE PROTECTED	Card or file is protected. To continue the operation, remove the protection.

Reset Function

If an error occurs during an operation and the unit no longer works, reset the unit as follows.

Press CANCEL and STANDBY simultaneously for 5 seconds.

- Unit is reset. Try operation again.

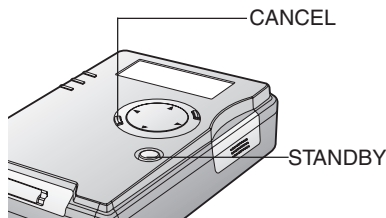

Before Requesting Service

If a problem should arise, you may be able to correct it yourself using the corrections listed below. If the problem persists, contact your nearest Servicer.

Symptom	Correction
Unit does not power up...	<ul style="list-style-type: none">• Be sure the battery and AC adaptor are connected properly.• Use a fully recharged battery.• Press STANDBY for at least 2 seconds.
Power is on, but unit turns off after a short period...	<ul style="list-style-type: none">• Use a fully recharged battery.• Always recharge battery within specified temperature range. Battery will not recharge at low temperatures under 23 F (-5 °C).
Power turns off automatically...	<ul style="list-style-type: none">• If powering unit with battery only, power will shut off if no operation is performed for 5 minutes. Turn unit back on.
Unit will not turn off...	<ul style="list-style-type: none">• Power will not turn off while files are being read or copied. Turn unit off after SD/HDD access Lamp goes out.• Power will not turn off when HDD SAFETY Detection Switch is activated. Place unit on flat, level surface, then turn off the power.
Copying cannot be performed...	<ul style="list-style-type: none">• Insert card correctly.• Be sure copy destination has sufficient free space. Delete unnecessary data to free up space.• If HDD SAFETY Detection Switch was activated, place unit on flat, level surface.• Secure data files (audio files that include copyright restrictions) cannot be copied.• If the SD Memory Card write-protect switch is set to "LOCK", data cannot be overwritten.
Files and folders cannot be located...	<ul style="list-style-type: none">• In Copy or TV mode, when an SD Memory Card is copied to a PC Card HDD, copied data will be placed in a folder entitled, "CARD****". Open this folder and confirm data was copied.• If all or selected data in a "CARD****" folder is copied to an SD Memory Card, the "CARD****" folder disappears and data is copied according to file structure rules. See "Copying and Backup" section on page 12.

(Continued on next page.)

Before Requesting Service

Symptom	Correction
No images are displayed, even though this unit is connected to a TV...	<ul style="list-style-type: none">• Set COPY/TV MODE to "TV."• Connect video cable properly.• Set TV input to Video. See TV manual.• The USB cable must be disconnected to view images on a TV.• Confirm that TV format is NTSC from Copy mode.
Images cannot be displayed...	<ul style="list-style-type: none">• Insert card correctly.• Files with extensions other than .JPG, .TIF and .MOV, and files that contain corrupt data, cannot be displayed.• To view images within folders, open a folder, then select .JPG, .TIF, and .MOV files.• Some files take longer to display.
Video images cannot be played back...	<ul style="list-style-type: none">• Only the first frame of QuickTime format data can be displayed.
Data cannot be read or written using USB connection...	<ul style="list-style-type: none">• When the USB cable is connected, ensure that the battery has been installed then connect the AC adapter.• Connect USB cable properly.• Select a read or write destination card.
PC Card HDD data cannot be read or written...	<ul style="list-style-type: none">• Correctly install PC Card HDD in this unit.• If HDD SAFETY Detection Switch was activated, place unit on flat, level surface.• The PC Card HDD is a precision hard disk drive. If it is dropped or receives a strong impact, malfunction, damage, and loss of stored data could occur. If read/write errors occur or operation is abnormal, a backup should be performed immediately, using the ScanDisk/CheckDisk function.
Insufficient free space on card...	<ul style="list-style-type: none">• Confirm card capacity on a PC as some data on the card cannot be displayed using this unit.• If Backup is set to on, available space is reduced by half.
No presentation folders can be found...	<ul style="list-style-type: none">• For a PC Card HDD, be sure specified saving destination name is in the form of "CARD****".• Do not change folders to unrecognizable names.
Computer does not start up...	<ul style="list-style-type: none">• Be sure USB cable is not connected to the unit.

Specifications

Power Supply:	DC 4.8 V (AC Adaptor) / DC 3.7 V (Battery)
Power Consumption:	2.2 W (AC Adaptor) (peak 3.4 W) 2.2 W (Battery) (peak 2.9 W)
Compatible Memory Cards	
SD Card Slot:	SD Memory Card, MultiMediaCard
PC Card Slot:	PC Card HDD (2 GB, 5 GB) SD Memory Card * MultiMediaCard * CF Card* Smart Media* Memory Stick* Microdrive (340 MB, 1 GB)* * Each type of Memory Card requires a compatible adaptor.
Copyable Data:	All files and folders except secure files (audio files that include copyright restrictions)
Image Playback Formats:	Baseline JPEG, TIFF (RGB 8 bit non-compressed) and the first screen of Motion JPEG files (QuickTime)
Image Sizes:	80 x 60 ~ 5120 x 3840 pixels
Copy Functions	
Copy Mode:	Copying of all data from SD Memory Card (MultiMediaCard) -> PC Card HDD (PC Card) Copying of selected folders from PC Card HDD (PC Card) -> SD Memory Card (MultiMediaCard)
TV Mode:	Copying of all data and selected files and folders from SD Memory Card (MultiMediaCard) -> PC Card HDD (PC Card) Copying of all data and selected folders from PC Card HDD (PC Card) -> SD Memory Card (MultiMediaCard)
Playback Functions:	Image Playback Thumbnail display (4 x 6 display) Album display (6 images or 9 images display) Slide Show (automatic display) Rotation, enlargement (x2, x4) Presentation
Delete Functions:	Selective deletion of files or folders, and deletion of all files and folders
Protection Functions:	PC card HDD protection using HDD SAFETY Detection Switch File backup protection File protection against accidental deletion

Specifications

Video Output:	Composite Output : NTSC format / PAL format, 1 V p-p, 75 ohm S-Output : Y and C signals, NTSC format / PAL format, 1 V p-p, 75 ohm
Dimensions:	73 (W) x 25.8 (H) x 107.5 (D) mm 2-14/16 (W) x 1 (H) x 4-4/16 (D) inch
Weight:	5.63 oz / 160 g (Not including PC Card HDD and battery pack)
Operating Weight:	8.8 oz / 250 g
Operating Temperature:	32 F ~ 95 F (0 °C ~ 35 °C)
Operating Humidity:	10 % ~ 80 %
Battery Life:	Continuous use Approx. 80 minutes in Copy mode Approx. 80 minutes in TV mode
PC Interface:	USB1.1
OS Compatibility:	Windows 98SE, Windows 2000, Windows Me, Windows XP
Compatible PC Models:	IBM PC / AT compatible models

AC Adaptor (VSK0626C)

Power Supply:	110 - 240 V AC 50 / 60 Hz
Input Capacity:	0.12 A
Output:	4.8 V DC

Weight:	2.11 oz / 60 g
Dimensions:	50 (W) x 26 (H) x 70 (D) mm 1-15/16 (W) x 1 (H) x 2-12/16 (D) inch

Battery Pack (CGA-S301A1)

Maximum Voltage:	4.2 V
Nominal Voltage:	3.7 V
Rated Capacity:	1000 mAh

Weight:	0.98 oz / 28 g
Dimensions:	35 (W) x 7 (H) x 53 (D) mm 1-6/16 (W) x 2-12/16 (H) x 2-1/16 (D) inch

PC Card HDD (RP-PH005A)

Capacity:	5 GB
Input Voltage:	3.3 V / 5V
Interface:	PCMCIA Type II

Weight:	1.93 oz / 55 g
Dimensions:	54 (W) x 5 (H) x 86 (D) mm 2-2/16 (W) x 1-15/16 (H) x 3-6/16 (D) inch

Accessory Order Form

Please photocopy this form when placing an order.

1. SD Media Storage Model # _____

2. Items Ordered

Accessory #	Description	Price Each	Quantity	Total Price
Subtotal				
Your State & Local Sales Tax				
Shipping & Handling				6.95
Total Enclosed				

3. Method of payment (check one)

- Check or Money Order enclosed (NO C.O.D.SHIPMENTS)
- VISA Credit Card # _____
- MasterCard Expiration Date _____
- Discover Customer Signature _____

Make Check or Money Order to: PANASONIC ACCESSORIES

(Please do not send cash)

4. Shipping information (UPS delivery requires complete street address)

Ship To:

Mr.

Mrs.

Ms. _____

First

Last

Phone #:

Day ()

Street Address

Night ()

City

State

Zip

TO OBTAIN ANY OF OUR SD MEDIA STORAGE ACCESSORIES YOU CAN DO ANY OF THE FOLLOWING:

VISIT YOUR LOCAL PANASONIC DEALER

OR

CALL PANASONIC'S ACCESSORY ORDER LINE AT 1-800-332-5368

[6 AM-5 PM M-F, 6 AM-10:30 AM SAT, PACIFIC TIME]

OR

MAIL THIS ORDER TO: PANASONIC SERVICES COMPANY ACCESSORY
ORDER OFFICE

20421 84th Avenue South Kent, WA. 98032

Request for Service Notice

Please photocopy this form when making a request for service notice.

Request for Service Notice: (USA Only)

In the unlikely event this product needs service.

- Please include your **proof of purchase**.
(Failure to do so will delay your repair.)
- To further speed your repair, please provide an explanation of what is wrong with the unit and any symptom it is exhibiting.

Mail this completed form and your Proof of Purchase along with your unit to:
Panasonic Services Company
1705 N. Randall Road
Elgin, IL. 60123-7847
Attn: SD Media Storage Repair

Customer Services Directory

(For USA Only)

*For Product Information, Operating Assistance, Literature Request, Dealer Locations, and all Customer Service inquiries please contact:
1-800-272-7033, Monday-Friday 8:30am-8pm EST.*

Web Site: <http://www.panasonic.com>

You can purchase parts, accessories or locate your nearest servicer by visiting our Web Site.

Accessory Purchases:

1-800-332-5368 (Customer Orders Only)

Panasonic Services Company 20421 84th Avenue South, Kent, WA 98032

(6 am to 5 pm Monday - Friday; 6 am to 10:30 am Saturday; PST)

(Visa, MasterCard, Discover Card, American Express, Check)

Product Repairs

Centralized Factory Servicer

Panasonic Services Company

MAIL TO : 1705 N. Randall Road,
Elgin, IL 60123-7847

Attention: SD Media Storage Repair

Please carefully pack and ship, prepaid and insured, to the Elgin Centralized Factory Servicer. Customer's in Puerto Rico, please ship or carry in to location below ("Service in Puerto Rico").

Service in Puerto Rico

Matsushita Electric of Puerto Rico, Inc. Panasonic Sales Company/ Factory Servicer:

Ave. 65 de Infanteria, Km. 9.5, San Gabriel Industrial Park, Carolina, Puerto Rico 00985

Phone (787) 750-4300 Fax (787) 768-2910

As of August 2002

Limited Warranty (For USA Only)

PANASONIC CONSUMER
ELECTRONICS COMPANY,
DIVISION OF MATSUSHITA
ELECTRIC CORPORATION OF
AMERICA, One Panasonic Way
Secaucus, New Jersey 07094

PANASONIC SALES COMPANY,
DIVISION OF MATSUSHITA
ELECTRIC OF PUERTO RICO INC.
Ave. 65 de Infanteria, Km. 9.5 San
Gabriel Industrial Park Carolina,
Puerto Rico 00985

Panasonic SD Products Limited Warranty

Limited Warranty Coverage

If your product does not work properly because of a defect in materials or workmanship, Panasonic Consumer Electronics Company or Panasonic Sales Company (collectively referred to as “the warrantor”) will, for the length of the period indicated on the chart below, which starts with the date of original purchase (“warranty period”), at its option either (a) repair your product with new or refurbished parts, or (b) replace it with a new or a refurbished product. The decision to repair or replace will be made by the warrantor.

Product or Part Name	Labor	Parts
SD Multi A/V Device, SD Printer, SD Media Storage (Except items listed below)	One (1) year	Ninety (90) days
CMOS Camera Assembly	Six (6) months	Ninety (90) days
Rechargeable Battery Pack, SD Memory Card, AC Adaptor, USB Reader-Writer (in exchange for defective item)	Ninety (90) days	N/A

During the “Labor” warranty period there will be no charge for labor. During the “Parts” warranty period, there will be no charge for parts. You must carry-in or mail-in your product during the warranty period. If non-rechargeable batteries are included, they are not warranted. This warranty only applies to products purchased and serviced in the United States or Puerto Rico. This warranty is extended only to the original purchaser of a new product which was not sold “as is”. A purchase receipt or other proof of the original purchase date is required for warranty service.

Carry-In or Mail-In Service

For Carry-In or Mail-In Service in the United States call 1-800-272-7033.

For assistance in Puerto Rico call Panasonic Sales Company (787)-750-4300 or fax (787)-768-2910.

Limited Warranty Limits And Exclusions

This warranty ONLY COVERS failures due to defects in materials or workmanship, and DOES NOT COVER normal wear and tear or cosmetic damage. The warranty ALSO DOES NOT COVER damages which occurred in shipment, or failures which are caused by products not supplied by the warrantor, or failures which result from accidents, misuse, abuse, neglect, mishandling, misapplication, alteration, faulty installation, set-up adjustments, misadjustment of consumer controls, improper maintenance, power line surge, lightning damage, modification, or commercial use (such as in a hotel, office, restaurant, or other business), rental use of the product, service by anyone other than a Factory Servicenter or other Authorized Servicer, or damage that is attributable to acts of God.

NOT LIABLE FOR INCIDENTAL OR CONSEQUENTIAL DAMAGES RESULTING FROM THE USE OF THIS PRODUCT, OR ARISING OUT OF ANY BREACH OF THIS WARRANTY.

(As examples, this excludes damages for lost time, travel to and from the servicer, or loss of images, data or other memory content) The items listed are not exclusive, but are for illustration only.) **ALL EXPRESS AND IMPLIED WARRANTIES, INCLUDING THE WARRANTY OF MERCHANTABILITY, ARE LIMITED TO THE PERIOD OF THE LIMITED WARRANTY.**

Some states do not allow the exclusion or limitation of incidental or consequential damages, or limitations on how long an implied warranty lasts, so the exclusions may not apply to you.

This warranty gives you specific legal rights and you may also have others rights which vary from state to state. If a problem with this product develops during or after the warranty period, you may contact your dealer or Servicenter. If the problem is not handled to your satisfaction, then write to the warrantor's Consumer Affairs Department at the addresses listed for the warrantor.

PARTS AND SERVICE WHICH ARE NOT COVERED BY THIS LIMITED WARRANTY ARE YOUR RESPONSIBILITY.

**Panasonic Consumer Electronics Company,
Division of Matsushita Electric Corporation of America**
One Panasonic Way Secaucus, New Jersey 07094

**Panasonic Sales Company ("PSC"),
Division of Matsushita Electric of Puerto Rico, Inc.**
Ave. 65 de Infantería, Km. 9.5 San Gabriel Industrial Park Carolina,
Puerto Rico 00985

Panasonic Canada Inc.
5770 Ambler Drive, Mississauga, ON, L4W 2T3



Printed in Japan
LSQT0622A
S0103A0