

Panasonic®

Facsimile

Panafax® UF-755

Model No. UF-755

User's Guide

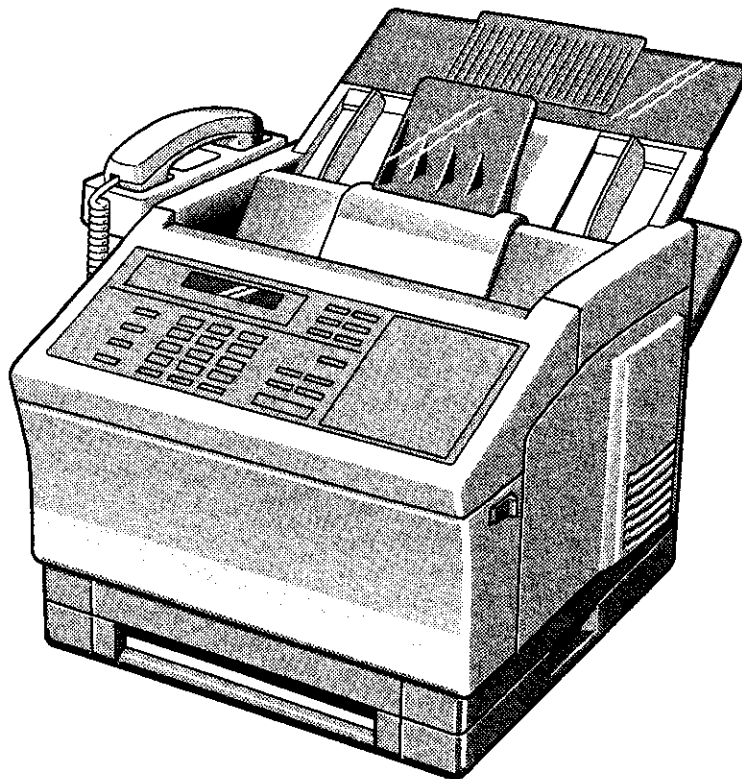

English

IMPORTANT INFORMATION

When requesting information, supplies, or service always refer to the model and serial number of your machine. The model and serial number's plate (Main Name Plate) is located on the machine as shown below. For your convenience, space is provided below to record the information you may need in the future.

Model No. UF-755 _____

Serial No. _____

Date of Purchase _____

Dealer _____

Address _____

Telephone Number
() - _____

Supplies Telephone Number
() - _____

Service Telephone Number
() - _____

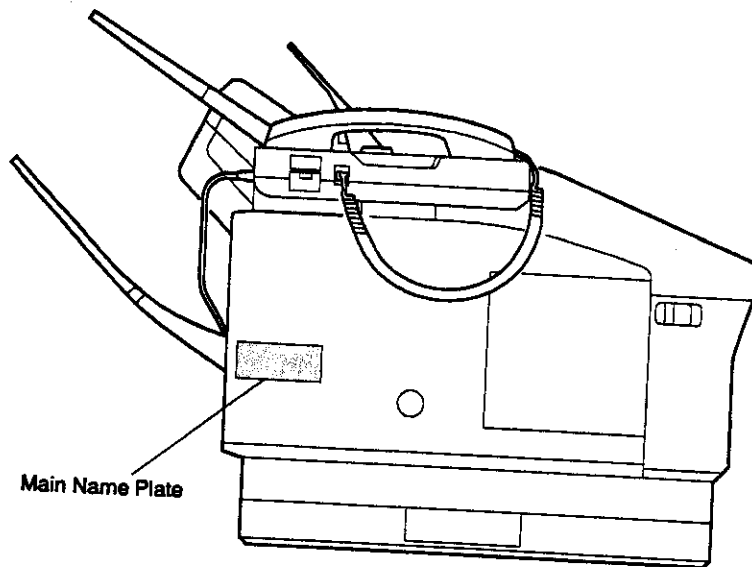

Copyright © 1993 by Matsushita Graphic Communication Systems, Inc.
All rights reserved. Printed in Japan.

The contents of this User's Guide are subject to change without notice.

Table of Contents

1	GETTING TO KNOW YOUR MACHINE	
	Introduction	5
	External View	7
	Control Panel	8
	Function Key	10
2	INSTALLING YOUR MACHINE	
	Safety Information	11
	Main Unit and Accessories	13
	Installing Accessories	14
	Installing Toner Cartridge	16
	Loading Recording Paper	18
	Paper Specifications	18
	How to Load Recording Paper	18
	Connecting the Telephone Line Cord and Power Cord	20
	Setting the Dialling Method (Tone or Pulse)	22
	Adjusting Volume	23
	Setting Monitor Volume	23
	Setting Ringer Volume	23
	User Parameters	24
	Setting the Date and Time	24
	Setting Your LOGO	25
	Setting Your Character ID	26
	Setting Your ID Number (Fax Telephone Number)	27
3	PROGRAMMING YOUR MACHINE	
	One-Touch/Abbreviated Dialling Numbers	29
	Entering One-Touch/Abbreviated Dialling Numbers	29
	Changing or Erasing One-Touch/Abbreviated Dialling Numbers	31
	Printing Out a Directory Sheet	33
	Customizing Your Machine	34
	Setting Fax Parameters	34
	Fax Parameter Table	35
4	BASIC OPERATIONS	
	Loading Documents	39
	Documents You Can Send	39
	Documents You Cannot Send	39
	How to Load Documents	40
	Basic Transmission Settings	41
	Original (Contrast)	41
	Resolution	41
	Halftone	42
	Verification Stamp	42
	Communication Journal (COMM. JOURNAL)	43

Sending Documents	44
Memory Transmission	44
Manual Number Dialling	45
One-Touch Dialling	46
Abbreviated Dialling	47
Directory Search Dialling	48
Multi-Station Transmission (Broadcasting)	49
Direct Transmission (ADF Transmission)	50
Off-Hook Dialling	50
On-Hook Dialling	51
Manual Number Dialling	52
One-Touch Dialling	53
Abbreviated Dialling	54
Directory Search Dialling	55
Transmission Reservation	56
Memory Transmission Reservation (Dual Access)	56
Direct Transmission Reservation (Priority Transmission Reservation)	57
Redialling	58
Automatic Redialling	58
Manual Redialling	58
Receiving Documents	59
Automatic Reception	59
Manual Reception	59
Print Reduction	60
Selecting the Print Reduction Mode	60
Receiving Oversize Documents	61
Substitute Memory Reception	62
Making Copies	63
Using the Machine's Telephone	64
Making a Regular Call	64
Making Voice Contact after Sending/Receiving	64
Answering a Voice Contact Request	64

5 ADVANCED FEATURES

Timer Controlled Communications	65
Deferred Transmission	65
Deferred Polling	66
Polling	67
Setting Polling Password	67
Preparing to be Polled	68
To Poll Documents from Another Station	69
Program Keys	70
Setting for Deferred Transmission	70
Setting for Normal Polling	71
Setting for Deferred Polling	72
Setting for Group Dialling	73
Setting for One-Touch Key	74
Changing or Erasing Program Key Settings	75

File Edit Mode	76
Printing a File List	76
Changing Start Time or Station of a File	77
Deleting File	78
Printing Out a File	79
Adding Documents into a File	80
Retry an Incomplete File	81
Fax Access Code	82
Setting the Fax Access Code	82
Operating Your Machine with Fax Access Code	82
Receive To Memory	83
Setting the RCV To Memory Password	83
Setting RCV To Memory	83
Printing Out Documents	84

6 NETWORKED FEATURES

Selective Reception	85
Setting Selective Reception	85
Password Communications	86
General Description	86
Compatibility with Other Machines	86
Setting Password Transmission	87
Setting Password Reception	88
Using Password Transmission	89
Using Password Receiving	89
Confidential Mailbox and Confidential Network Communications	90
Confidential Mailbox	90
Compatibility with Other Machines	90
Sending a Confidential Document to a Remote Station's Mailbox	91
Polling a Confidential Document from a Remote Station's Mailbox	92
Receiving a Confidential Document to Your Machine's Mailbox	93
Storing Confidential Document in Your Machine's Mailbox	94
Printing Out Confidential Document from Your Machine's Mailbox	95
Deleting a Confidential Document Stored in Your Machine's Mailbox	96
Confidential Network Communications (Via a Center Station)	97
Compatibility with Other Machines	98
Setting Up Your Machine for Confidential Network Communications	98
Relayed Transmission	101
General Description	101
Compatibility with Other Machines	101
Relay Network	102
Setting Up Your Machine for Relayed Transmission	104
Sending a Document by Relayed Transmission	108
Printouts and Reports	109

7 PRINTOUT JOURNALS AND LISTS

Journals and Lists	111
32 Transaction Journal	111
Individual Transmission Journal (IND. XMT JOURNAL)	111
Communication Journal (COMM. JOURNAL)	114
One-Touch/Abbreviated and Directory Search List	116
Program List	119
FAX Parameter List	120
Power Failure Report	121
Directory Sheet (see page 33)	
Memory File List (see page 76)	

8 PROBLEM SOLVING

Troubleshooting	123
If You Have Any of These Problems	123
Information Codes	125
Clearing Recording Paper Jam	127
Clearing a Document Jam	128
Cleaning the Document Scanning Area	129
Cleaning the Printer Roller	130
Adjusting the Automatic Document Feeder (ADF)	131
Verification Stamp	132
Checking the Telephone Line	133

9 APPENDIX

Specifications	135
Recording Paper Specifications	137
Options and Supplies	138
Installing Memory Card	139
Glossary	140
Index	145

QUICK GUIDE

Thank you very much for purchasing the Panafax **UF-755**.

The **UF-755** is one of the most advanced models in the Panafax family of G3 compatible, desktop facsimile machines.

Some of its many features are

- 1. Plain Paper Printing** Plain paper printing means you can easily write on received documents with a pen or pencil. Documents do not curl, making filing easier. In addition, plain paper does not fade, making it ideal for long term storage of important documents.
- 2. Quick Scanning** The **UF-755** Quick Scan speeds up the fax process by scanning and storing documents into memory in about 3 seconds per page. This means that you no longer have to wait around until a transmission is completed before retrieving your documents.
- 3. Easy Maintenance** Maintenance requires only changing a toner cartridge, making it quicker and easier than with other types of plain paper fax machines.
- 4. Memory Function** A standard image memory feature allows you to store up to 28 standard pages into the document memory. After the **UF-755** stores your documents, it can send them to selected station(s) automatically. You do not have to wait until the transmission ends before retrieving your originals.
- 5. Dual Access Operation** The **UF-755** can reserve the next transmission even during reception or memory transmission. It can also receive during document storage.
- 6. 64 level Panasonic Super Gray Scale** The **UF-755** offers a 64-level Super Gray Scale using Error Diffusion technology. Switching to this mode assures clear, realistic reproduction of photographs and text, brochures, and illustrations.
- 7. Panasonic Super Smoothing** The **UF-755** incorporate's a new sophisticated Image processing technology to enhance the print quality of an ordinary received fax image by smoothing out the curving edge of a character to reproduce a high quality document.
- 8. Selective Reception** To prevent unwanted faxes being received by comparing the ID Number of the transmitting machine with the telephone number stored in the built-in automatic telephone dialer.

With a little practice, anyone can learn how to use the most popular features of the **UF-755**.

This User's Guide will help you to use your **UF-755** quickly and easily. The Table of Contents shows where to find information on each feature. Although we recommend that you review each section briefly, it will only be necessary to read the sections that contain the feature(s) you will be using.

This page is intentionally left blank.

External View

1

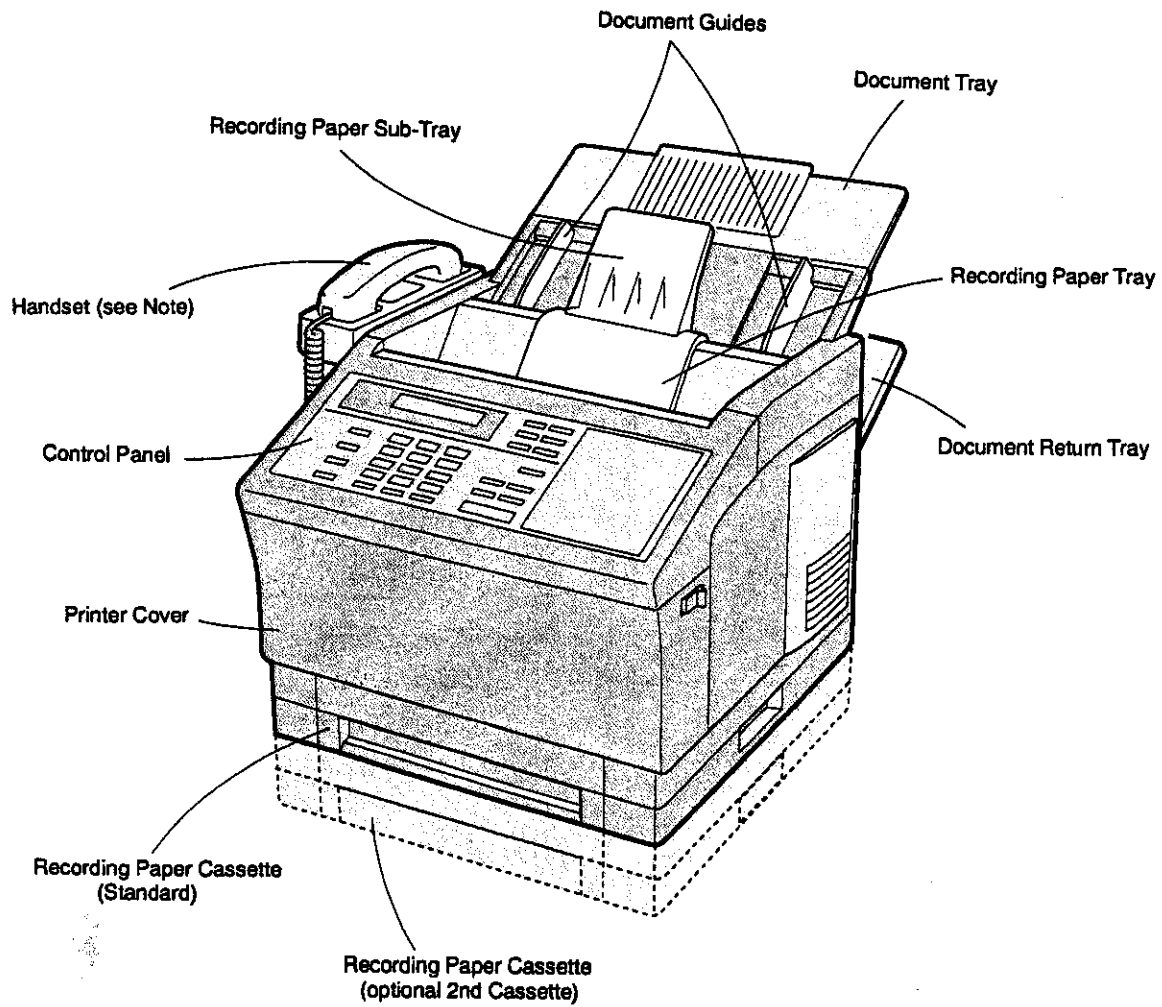

! *Note: For some countries, the handset is not attached because of the country's regulation or specification.*

Control Panel

ORIGINAL < Used to set Normal, Light, or Dark. (see page 41) Also serves as an arrow key (<) to move the cursor over recorded numbers and characters.

RESOLUTION > Used to set Standard, Fine, Super-Fine. (see page 41) Also serves as an arrow key (>) to move the cursor over recorded numbers and characters.

HALFTONE Provides OFF, QUALITY or FAST settings for halftone documents. (see page 42)

STAMP Used to turn the verification stamp ON or OFF. (see page 42)

ON LINE Blinks when the machine is transmitting a document or receiving.

PAPER JAM Lamp Blinks when a recording paper jam occurs. (see page 127)

NO TONER Lamp Blinks when the toner has run out. (see page 16)

NO PAPER Lamp Blinks when recording paper cassette is empty or not installed. (see page 18)

LCD Display
Indicates date and time or the current operation

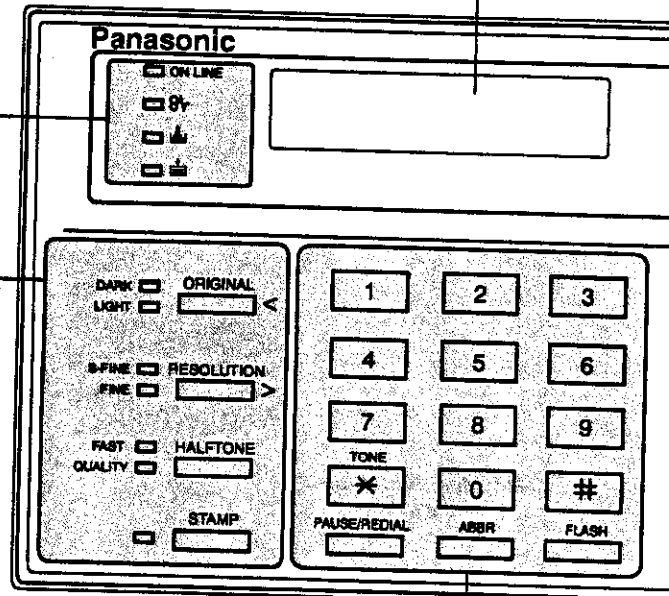

1 2 3
4 5 6
7 8 9
*** 0 #** Used for Manual Number Dialling, recording phone numbers, and selecting functions.

⌘ TONE Used to temporarily change Dialling Mode to Tone when Pulse mode is set.

⌘ PAUSE/REDIAL Used to enter a pause when recording or dialling a telephone number, or to redial the last dialed number. (see page 58)

⌘ ABBR Used to start Abbreviated Dialling. (see page 47 and 54)

⌘ FLASH Used to access some features of your PBX.

⌘ STOP Used to cancel operations. When it is pressed, the machine will return to standby.

⌘ TEL/DIAL Used to start On-Hook Dialling or to make voice contact request. (see page 51 and 64)

MONITOR VOL + CLEAR Used to erase the previously entered input. Also used to adjust monitor volume. (see page 23)

Control Panel

1

MANUAL RCY 	Used to select either manual reception or automatic reception. (see page 59)	 (Scroll Keys)	Used for followings. <ul style="list-style-type: none"> • Search station name for Directory Search Dialling • Confirm entered station for multi-station communication. • Confirm current communication modes (e. g. Page number, ID, Dialed Telephone number) when unit is on line. • Select functions.
DIRECTORY SEARCH 	Used to search for a station name (see page 48 and 55)		
MEMORY 	Used to select either memory or direct ADF communication. (see page 44 to 55)		
FUNCTION 	Used to start or select the function and sub-functions. These functions are explained in detail on the next page.		

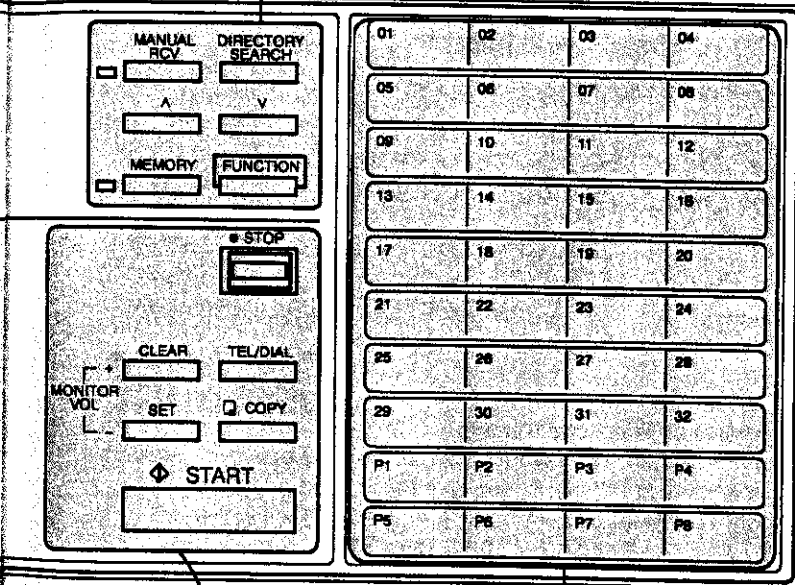

One-Touch Keys (01-32)
Used for One-Touch Dialling. (see page 46 and 53)

Program Keys (P1-P8)
Used to record long dialling procedures or Group Dialling Number keys. (see page 70 to 75)

Character Keys
The One-Touch Keys and Program Keys also serve as character and symbol input keys which are used to record your LOGO and station name. The character key template is printed on the panel under the directory sheet cover.

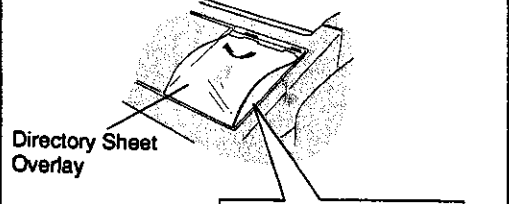

MONITOR VOL L -	Used to set operations. Also used to adjust monitor volume. (see page 23)
	Used to make photo copies. (see page 63)
	Used to start operations.

01	A	02	B	03	C	04	D
05	E	06	F	07	G	08	H
09	I	10	J	11	K	12	L
13	M	14	N	15	O	16	P
17	Q	18	R	19	S	20	T
21	U	22	V	23	W	24	X
25	Y	26	Z	27	A	28	A
29	O	30	O	31	C	32	S
P1	/	P2	/	P3	/	P4	/
P5	AE	P6	/	P7	SPACE	P8	UPPER/TOWER

Note: Whenever One-Touch keys are changed to the character key mode (to record your LOGO and station names), use the **UPPER/LOWER** key to switch between upper and lower character set.

Function Key

Any function can be started by first pressing **FUNCTION** and then enter the function number, or by pressing **▲** or **▼** scroll key repeatedly until the desired function appears on the display.

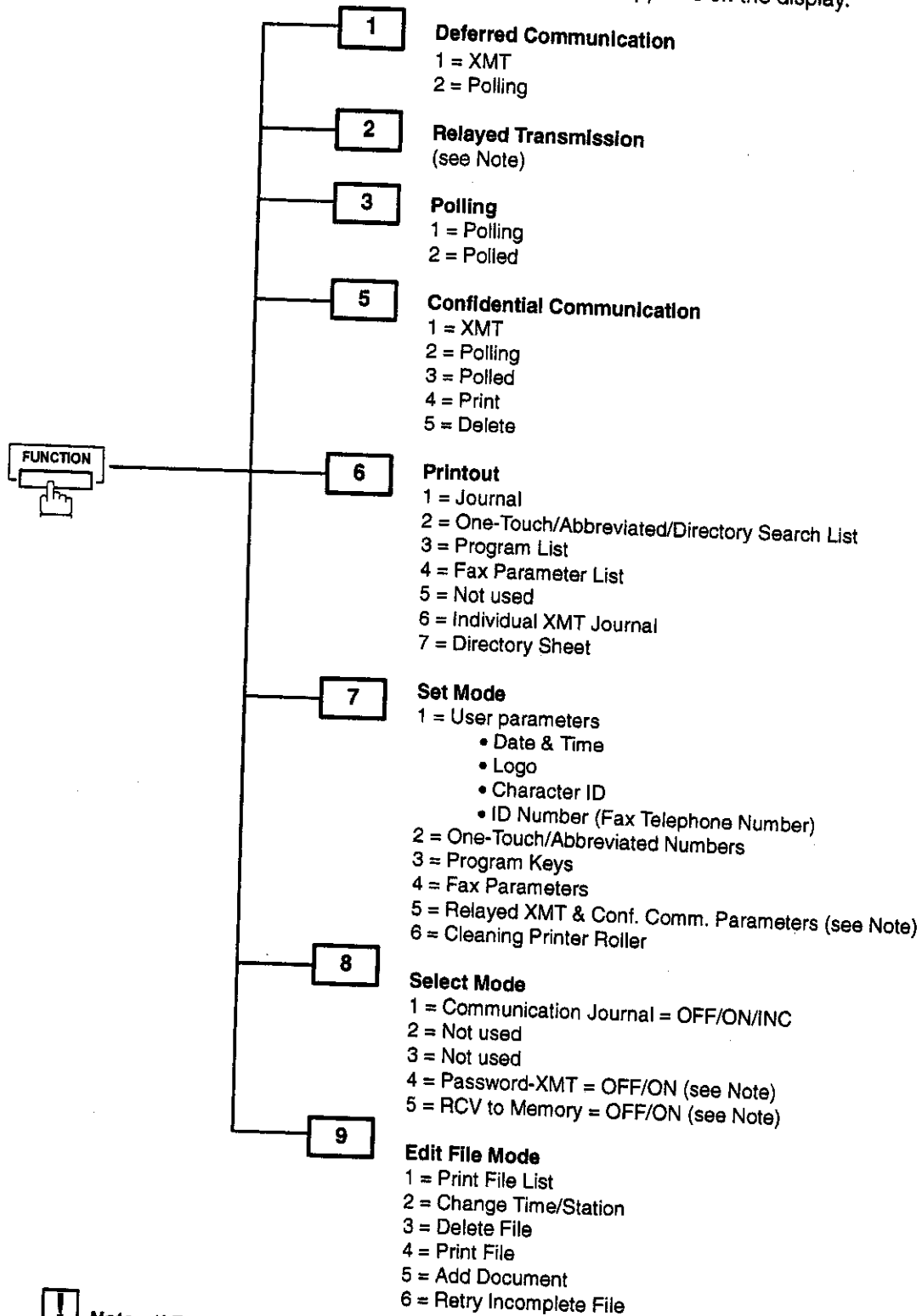

! **Note:** If Fax Parameter is not preset to Valid position, which enables you to use the function, the display will not show the function.

Safety Information

WARNING

denotes a potential hazard that could result in serious injury or death.

- TO PREVENT FIRE OR SHOCK, DO NOT EXPOSE THIS PRODUCT TO RAIN OR ANY TYPE OF MOISTURE.
- TO MINIMIZE THE POSSIBILITY OF SHOCK OR DAMAGE TO THE MACHINE, IT MUST BE PROPERLY GROUNDED.
- THIS PRODUCT CONTAINS HAZARDOUS RADIATION. IF YOU DO NOT FOLLOW THESE INSTRUCTIONS OR USE CONTROLS, MAKE ADJUSTMENTS OR PROCEDURES OTHER THAN THOSE SPECIFIED HEREIN, YOU MAY EXPOSE YOURSELF TO HAZARDOUS RADIATION.
- WHEN YOU OPERATE THIS EQUIPMENT, THE SOCKET-OUTLET SHOULD BE NEAR THE EQUIPMENT AND BE EASILY ACCESSIBLE.
- MAKE SURE THAT THE MACHINE IS INSTALLED IN A SPACIOUS OR WELL-VENTILATED ROOM SO AS NOT TO INCREASE THE AMOUNT OF OZONE IN THE AIR. SINCE OZONE IS HEAVIER THAN AIR, IT IS RECOMMENDED THAT AIR AT FLOOR LEVEL BE VENTILATED.
- PLUG POWER SUPPLY CORD INTO ORDINARY AC OUTLET BEFORE CONNECTING TELEPHONE LINE CORD. DISCONNECT TELEPHONE LINE CORD BEFORE UNPLUGGING POWER SUPPLY CORD FROM AC OUTLET.
- DISCONNECT THE EQUIPMENT IMMEDIATELY SHOULD IT EVER SUFFER PHYSICAL DAMAGE WHICH RESULTS IN THE INTERNAL PARTS BECOMING ACCESSIBLE IN NORMAL USE. IN THIS INSTANCE USERS SHOULD HAVE THE EQUIPMENT REPAIRED OR DISPOSE OF.
- IF THE POWER SUPPLY CORD AND/OR TELEPHONE LINE CORD OF THIS EQUIPMENT ARE DAMAGED, THEY MUST BE REPLACED BY THE SPECIAL CORDS SUPPLIED BY AN AUTHORIZED PANASONIC SERVICE CENTRE.

CAUTION

- 1 When you know that a thunderstorm is coming, we recommend that you:
 - (1) Unplug the telephone line cord from the phone jack.
 - (2) Turn off the power and unplug the power supply cord from the AC outlet.
- 2 This equipment may not necessarily provide for the effective hand-over of a call to or from a telephone connected to the same line.
- 3 The operation of this equipment on the same line as telephones or other equipment with audible warning devices or automatic ring detectors will give rise to bell tinkle or noise and may cause false tripping of the ring detector. Should such problems occur, the user is not to contact telecom (telephone company) faults service.

Safety Information

CAUTION

denotes hazards that could result in minor injury or damage to the machine.

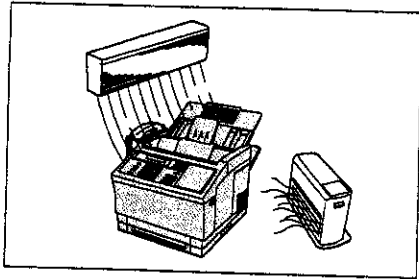

Do not install the machine near heating or air conditioning unit.

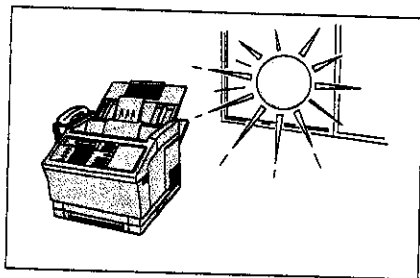

Avoid exposure to direct sunlight.

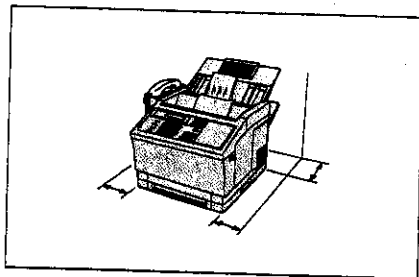

Install the machine on a flat surface, leave at least 10 cm of space between the machine and other objects.

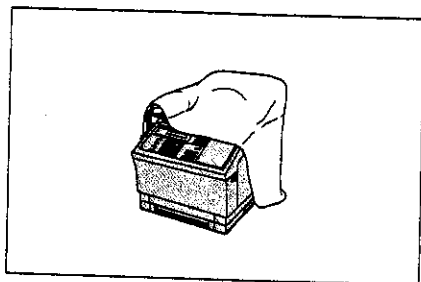

Do not block the ventilation openings.

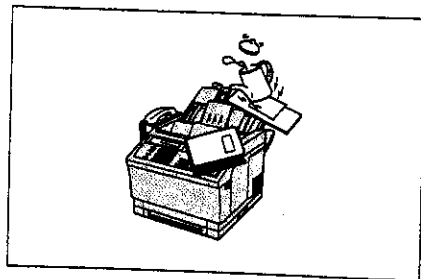

Do not place heavy objects, or spill liquids on the machine.

Main Unit and Accessories

Unpack the carton and check that you have all accessories illustrated.

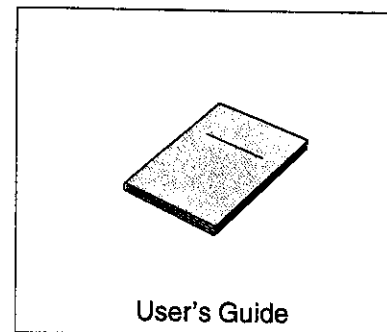
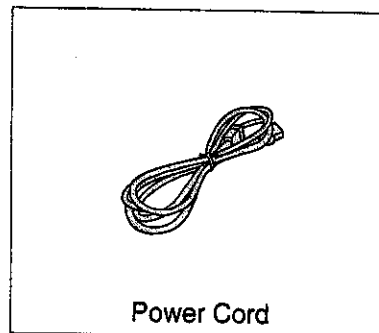
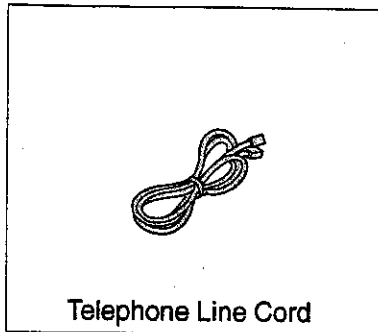
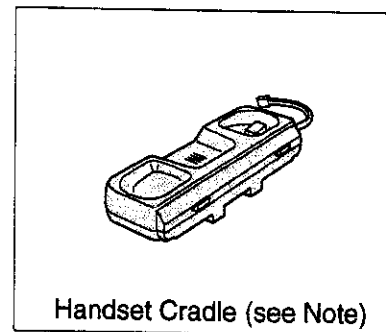
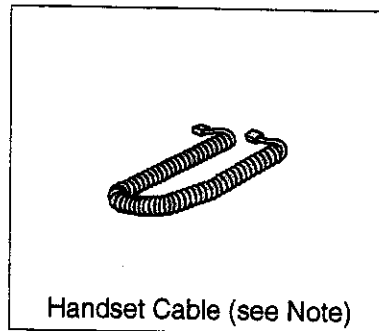
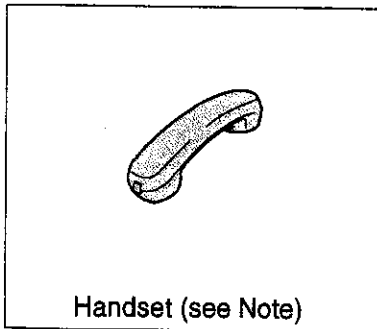
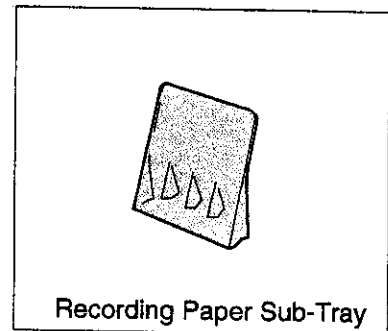
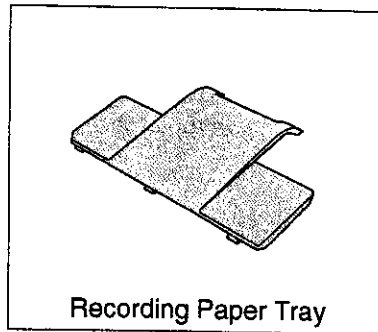
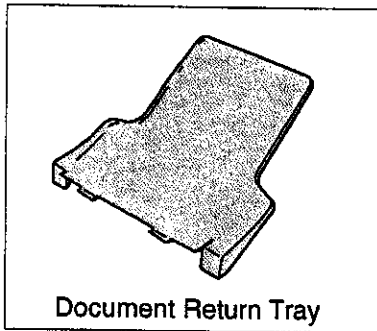
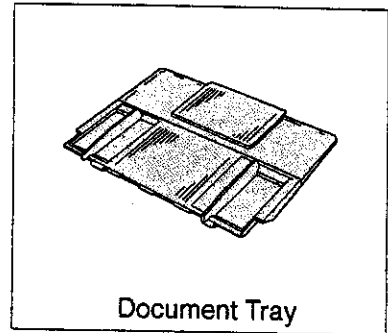
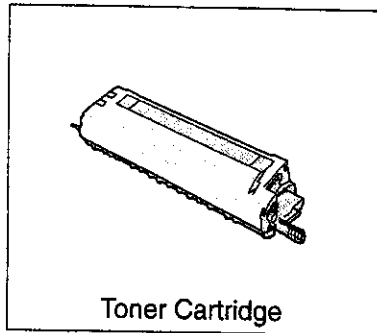
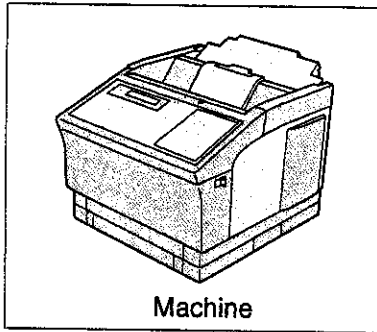

! **Note:** For some countries, these accessories are not attached because of the country's regulation or specification.

Installing Accessories

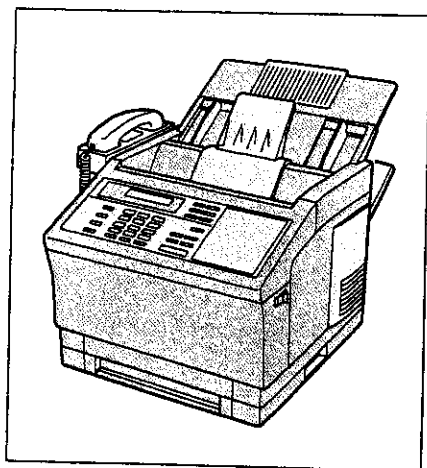

Final Installed View

Recording Paper Tray

Insert the projections into the square holes on the top of the machine.

Recording Paper Sub-Tray

Hook the bosses into the holes on the top of the machine.

Document Tray

Insert the projections into the square holes on the top of the machine.

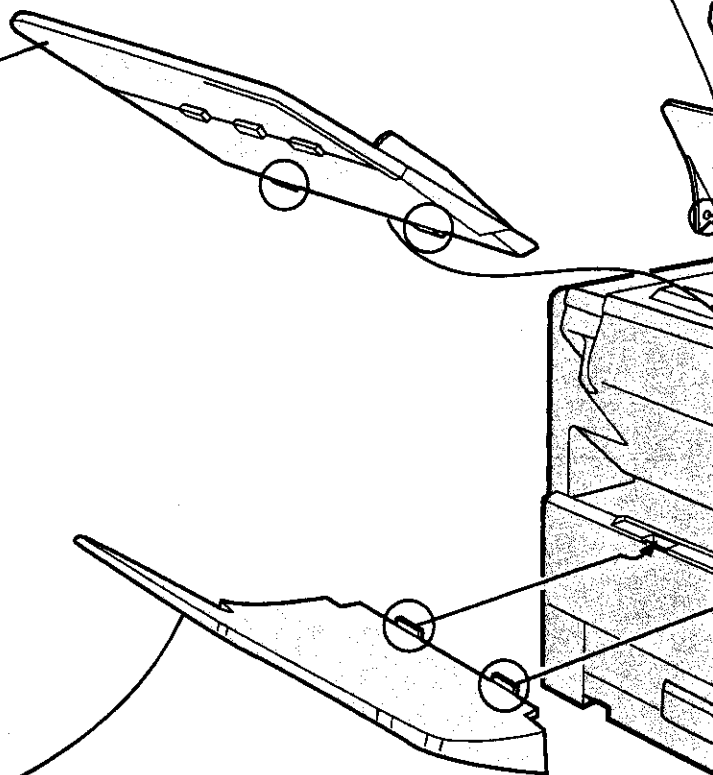

Document Return Tray

Hook the projections into the square holes on the rear of the machine.

Installing Accessories

2

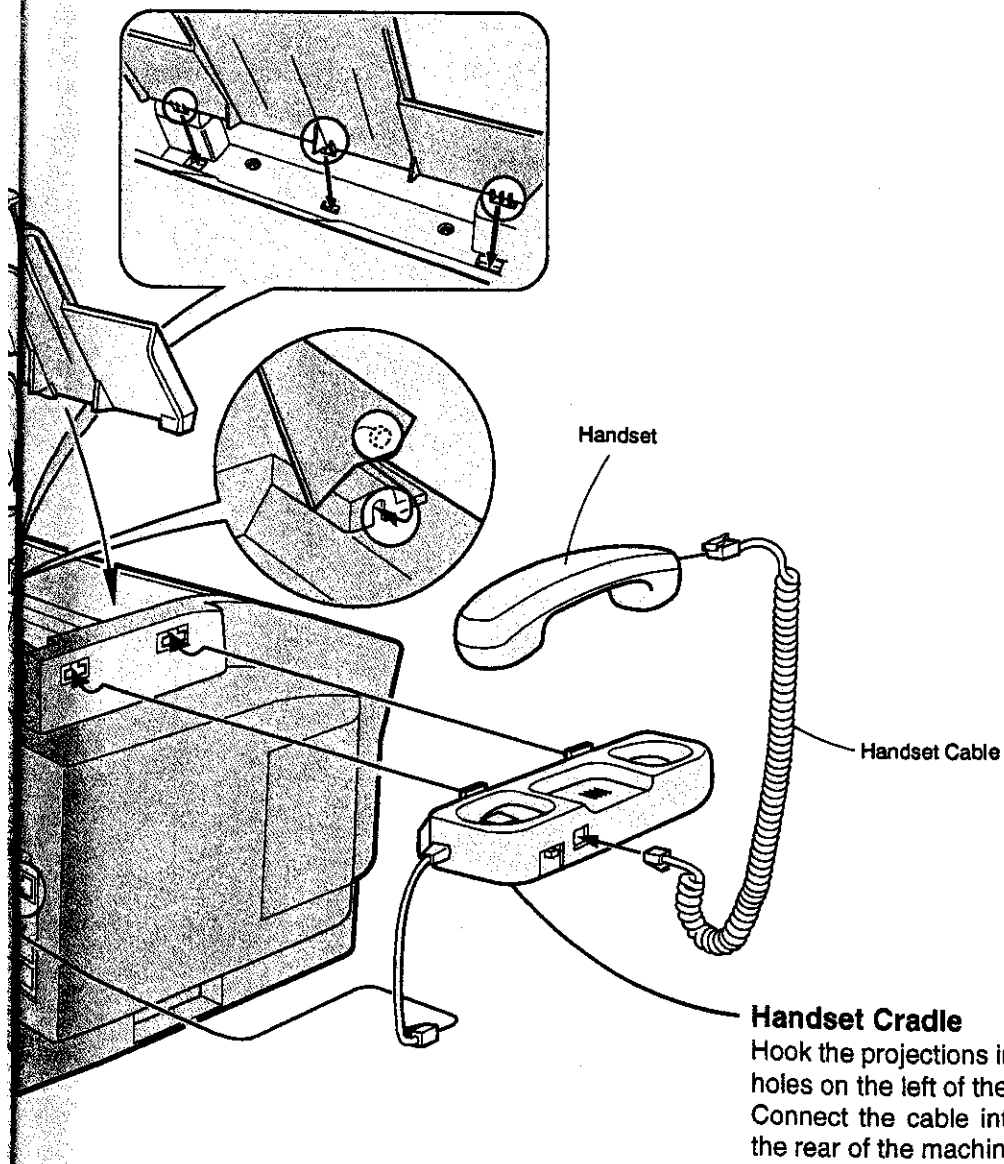

Installing Toner Cartridge

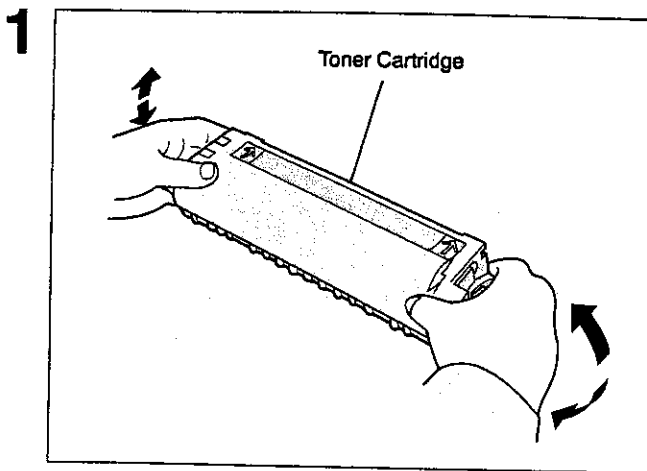

Unpack the Toner Cartridge and rock it back and forth as shown for 5 or 6 times to even the toner inside.

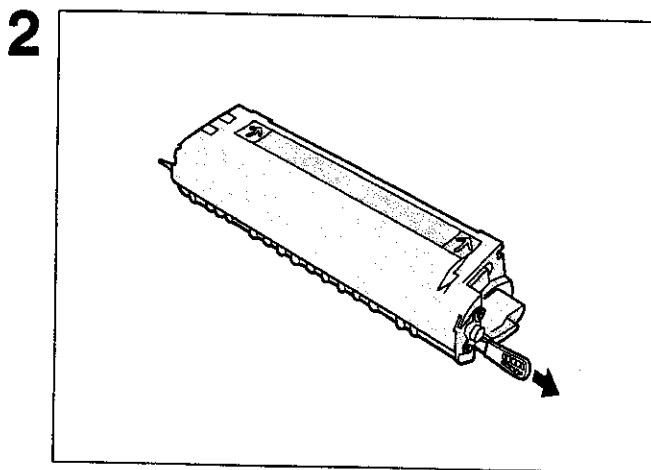

Remove the orange protective tab with seal.

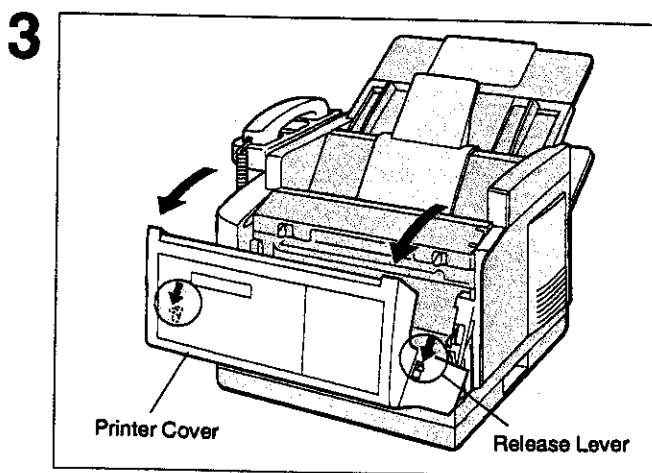

Pull the release lever on both sides to open the printer cover.

Installing Toner Cartridge

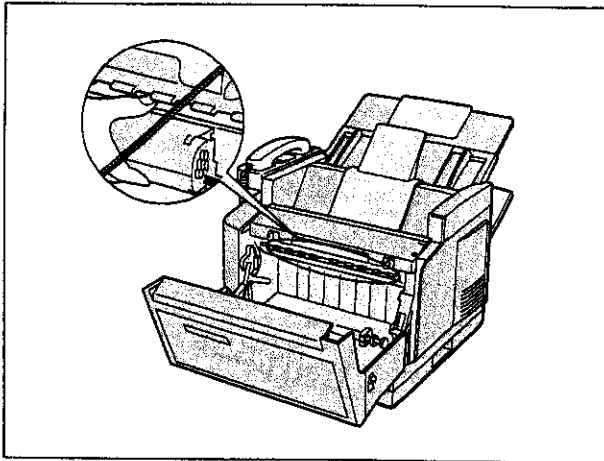

⚠ CAUTION

Be careful not to touch the high temperature heat roller (red) in the machine when installing and removing the toner cartridge.

2

4

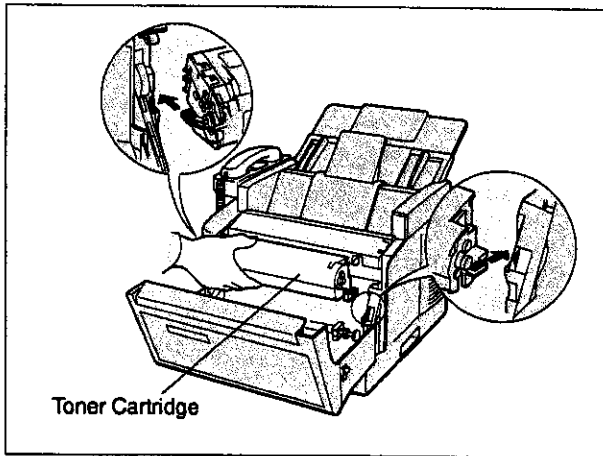

Align the arrow on both sides as shown and insert the toner cartridge into the machine.

5

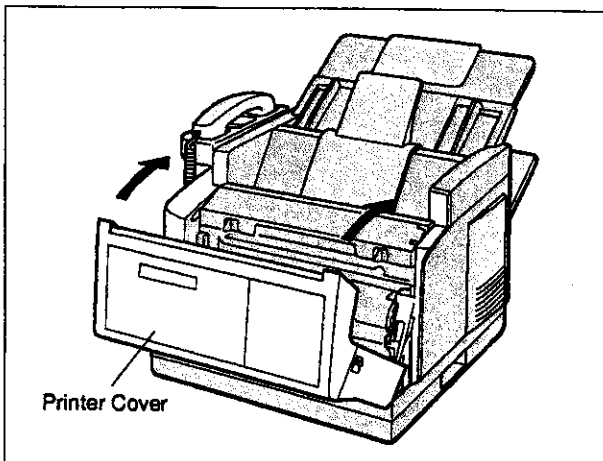

Close the printer cover firmly with both hands.

Loading Recording Paper

Paper Specifications

In general, most bond papers will produce excellent results. Most photocopy papers will also work very well. There are many "name" and "generic" brands of paper available. We recommend that you test various papers until you obtain the results you are looking for. For detailed recommended paper specifications, see page 137.

How to Load Recording Paper

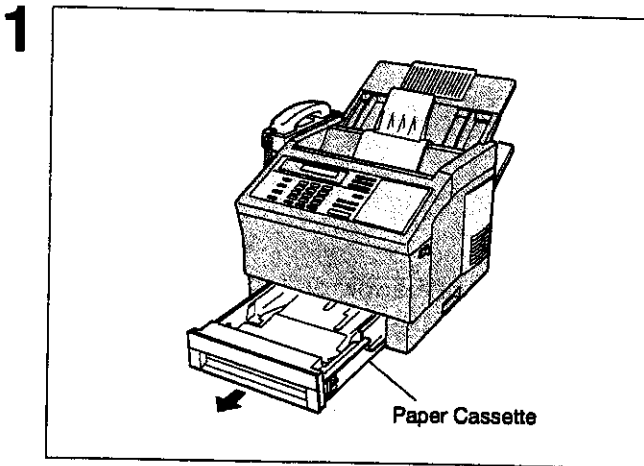

Remove the recording paper cassette from the machine.

Caution: To prevent dropping the cassette, hold it by the front and side while pulling it out.

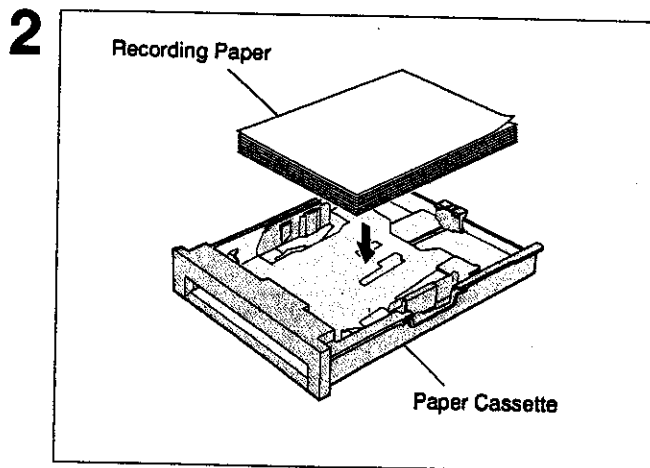

Load the paper into the paper cassette.

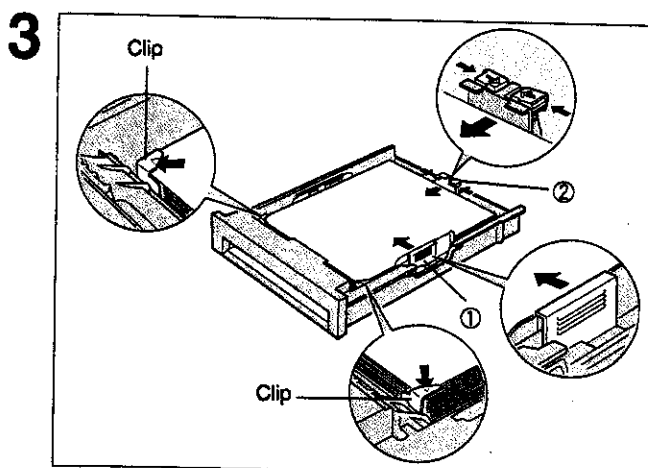

① Adjust the Paper Width Guide.

② Adjust the Paper Length Guide.

Caution: Make sure that the paper does not exceed over the clips of the paper cassette. You can load about 250 sheets with standard weight paper (20 lb. or 74 g/m²).

Loading Recording Paper

4

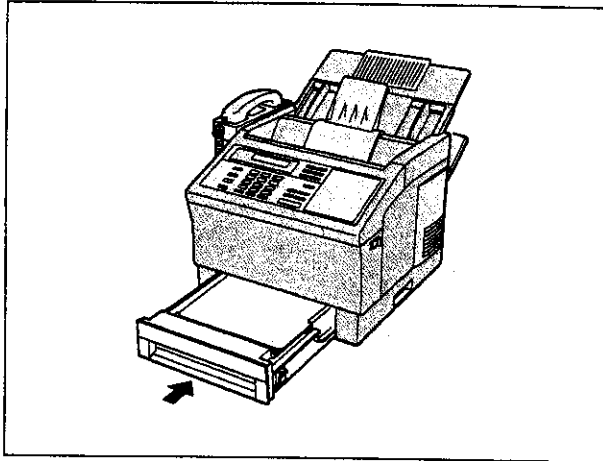

Re-install the paper cassette into the machine.

2

Connecting the Telephone Line Cord and Power Cord

■ Telephone Line Cord

Plug one end of the telephone line cord into the telephone jack supplied by the telephone company and the other end into the LINE jack on the rear of the machine.



■ Power Cord

Plug one end of the power cord into an ordinary AC outlet and the other end into the receptacle on the rear of the machine.

Warning : This apparatus must be properly grounded through an ordinary AC outlet.

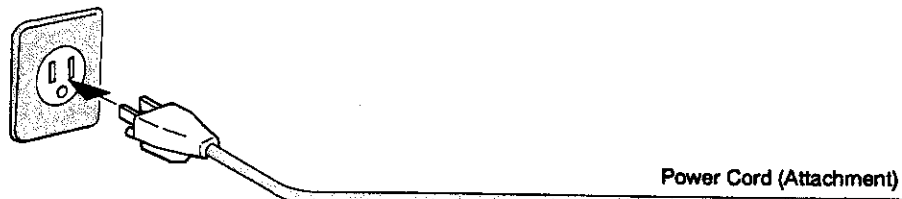

- !** **Note:**
1. When you turn the power switch ON, the ADF Protective Sheet will be ejected automatically.
 2. Your machine uses little power and you should keep it ON at all times. If the power is turned OFF for too long, the contents of the memory will be lost.
 3. Your machine has 2 separate rechargeable batteries to preserve the memory contents in case of a short term power failure. One for the machine parameters (such as LOGO, ID Number, Auto-dialer Telephone Number, etc.) which can back up for 10 days and the other one for the document memory, which can back up for 1 hour when fully charged.
 4. The built-in rechargeable batteries requires 48 hours to be fully charged in the machine.

Connecting the Telephone Line Cord and Power Cord

■ Power Switch

After connecting all cords, turn the power switch ON.

2

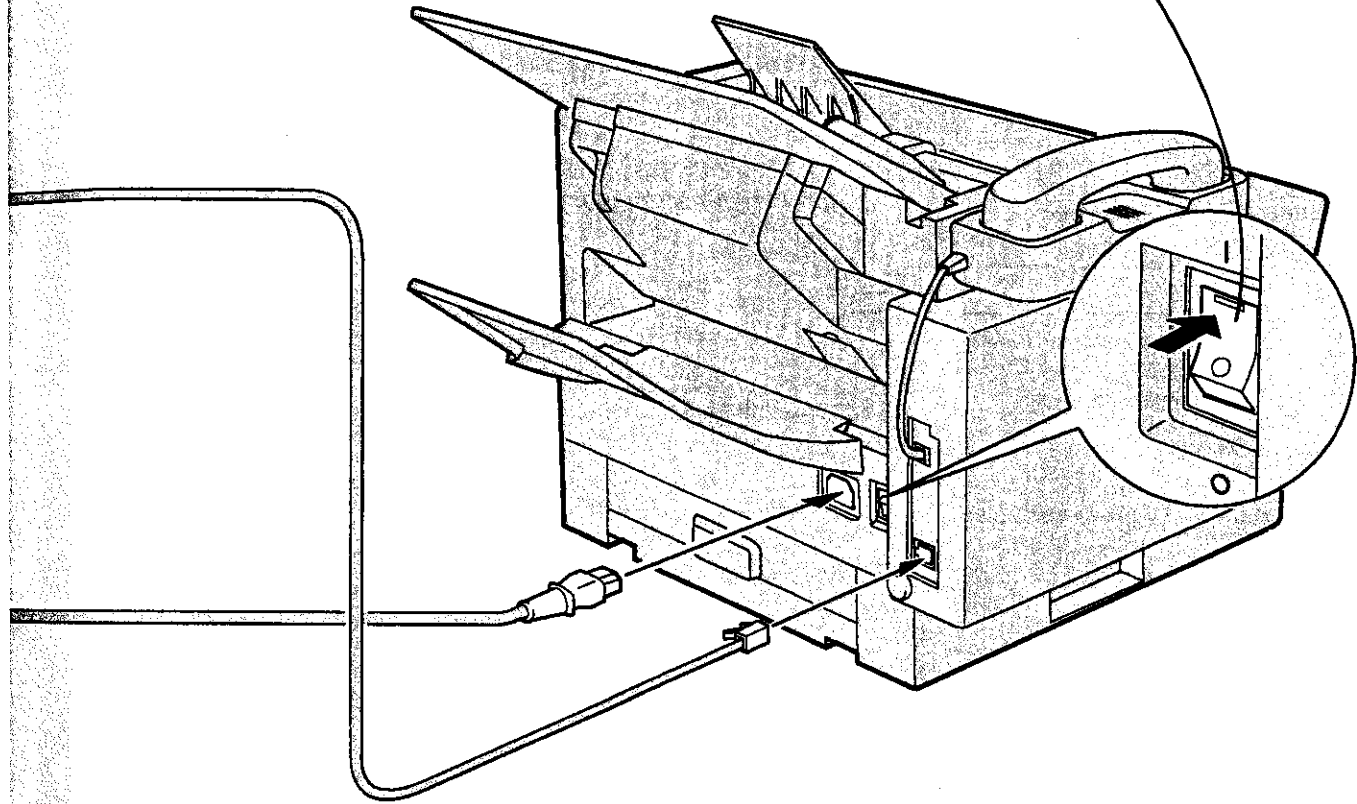

Setting the Dialling Method (Tone or Pulse)

Your machine can operate with either of two dialling methods (Tone or Pulse), depending on the type of telephone line you are connected to. If you need to change the dialling method to Tone or Pulse, follow the procedure below.

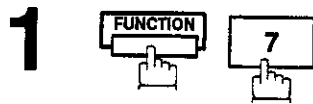

SET MODE (1-6)
ENTER NO. OR ^ V



FAX PARAMETER (01-53)
NO. = ■

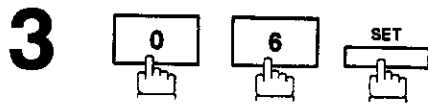

06 DIALLING METHOD
2:TONE

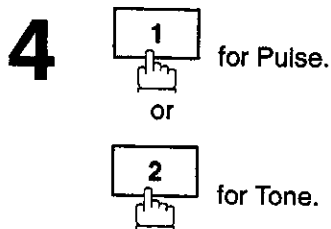

06 DIALLING METHOD
1:PULSE

OR

06 DIALLING METHOD
2:TONE

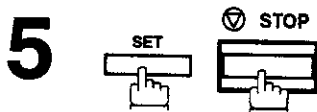

Adjusting Volume

You can adjust the monitor volume and ringer volume on your machine. The built-in speaker enables you to hear the dial tone, dialling signals, and busy tone. The ringer sounds when your machine receives a call.

Setting Monitor Volume

You can adjust the volume by using both **CLEAR** and **SET**.
The following describes the method of using **CLEAR** and **SET**.

- 

1 You will hear the dial tone through the speaker.

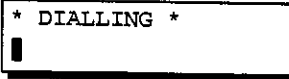

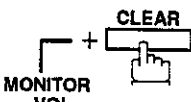
- 2**

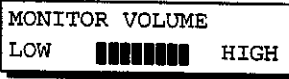
 repeatedly to raise the volume.

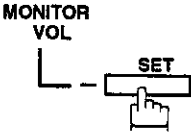

or

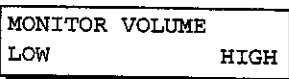
 repeatedly to lower the volume.

- 

3

Setting Ringer Volume

The ringer volume is located on the upper left of the handset cradle. Move the switch to a desired position, either high, low or off.

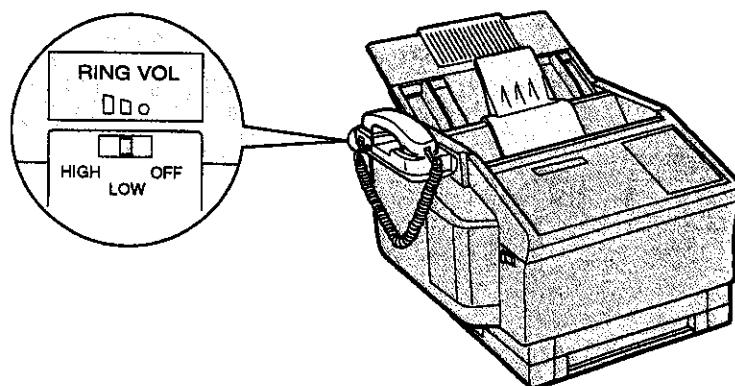

! **Note:** You can also adjust the volume of the key touch tone and the volume of the buzzer in Fax Parameter No. 10 (KEY/BUZZER VOLUME). (see page 35)

User Parameters

Your facsimile machine has several basic settings (User Parameters) to help you keep records of the documents you send or receive. For example, the built-in clock keeps the current date and time, and your LOGO and ID Number help to identify you when you send or receive documents.

If a power failure occurs, a built-in battery will back up this information for up to 10 days when it is fully charged.

Setting the Date and Time

At standby the display will show the date and time. Once the standby display is set, it will automatically be updated.



SET MODE (1-6)
ENTER NO. OR ^ V

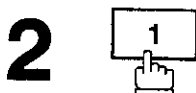

1:USER PARAMETERS?
PRESS SET TO SELECT

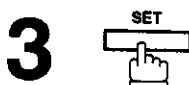

DATE & TIME
1-01-0000 00:00

4 Enter the new date and time.

Ex:

0	8		
1	2		
1	9	9	3
1	5	0	0

 Date : 08th
Month : December
Year : 1993
Time : 3:00 PM

DATE & TIME
08-12-1993 15:00

If you make a mistake, use the < ORIGINAL and > RESOLUTION to move the cursor to the incorrect number and enter the new number over it.

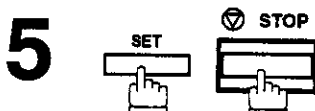

Setting Your LOGO

When you send a document, your LOGO appears on the top of the copy printed out at the other station. The LOGO helps to identify you to someone who receives your document.



```
SET MODE      (1-6)
ENTER NO. OR ^ V
```

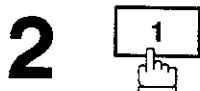

```
1:USER PARAMETERS?
PRESS SET TO SELECT
```



```
LOGO
█
```

4 Enter your LOGO (max. 25 characters and digits) by using the Character keys (see page 9).

Ex: P A N A S O N I C

```
LOGO
PANASONIC █
```

If you make a mistake, use < ORIGINAL and > RESOLUTION to move the cursor to the incorrect character and enter the new character over it. If more than 19 characters are entered, the left side characters will scroll off the display.

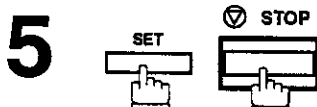

User Parameters

Setting Your Character ID

If the remote machine has a Character ID capabilities, when you are sending or receiving, your Character ID will appear on the remote machine's display and the remote machine's Character ID will appear on your display.



SET MODE (1-6)
ENTER NO. OR ^ V

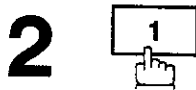

1:USER PARAMETERS?
PRESS SET TO SELECT



CHARACTER ID
█

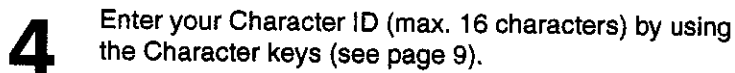

Ex: H E A D SPACE O F F I C E

If you make a mistake, use < ORIGINAL and > RESOLUTION to move the cursor to the incorrect character and enter the new character over it.

CHARACTER ID
HEAD OFFICE█

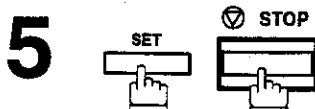

! *Note: The special characters of Å, å, Ä, ä, Ö, ö, Ü, ü, Æ, è and é cannot be used for Character ID.*

User Parameters

2

Setting Your ID Number (Fax Telephone Number)

If the remote machine does not have a Character ID but it has an ID Number, when sending or receiving, your ID Number will appear on the remote machine's display and their ID Number will appear on your display.

We suggest you use your facsimile telephone number as your ID number, but you may use any number up to 20 digits long.

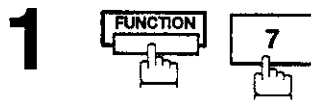

SET MODE (1-6)
ENTER NO. OR A V

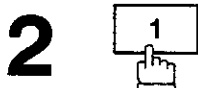

1:USER PARAMETERS?
PRESS SET TO SELECT

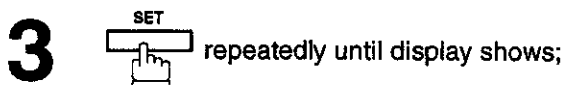

ID NO.

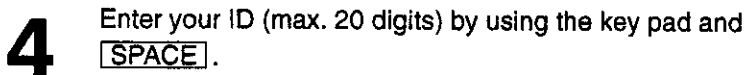

Ex: **2 0 1 SPACE 5 5 5**
SPACE 1 2 1 2

ID NO.
201 555 1212

If you make a mistake, press **CLEAR** to erase the number then reenter the correct number.

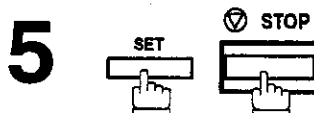

! **Note:** 1. You may use ***** to enter a "+" character at the beginning of the ID number to indicate the following digit(s) for your country code.

Ex: +1 201 555 1212 +1 for U.S.A. country code.
+81 3 111 2345 +81 for Japan country code.

2. For some countries, this feature is not available depending on the country's regulation.
The display may not show this feature.

This page is intentionally left blank.

One-Touch/Abbreviated Dialling Numbers

Entering One-Touch/Abbreviated Dialling Numbers

One-Touch and Abbreviated Dialling are two fast ways of dialling full telephone numbers. To use these dialling methods, you must first store the telephone number using the following procedure.

To enter a One-Touch key, follow these steps below

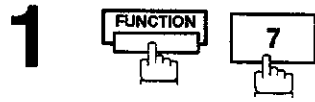

SET MODE (1-6)
ENTER NO. OR A V

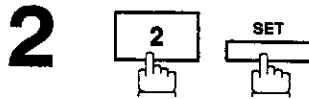

1: ONE-TOUCH
2: ABBR. NO.

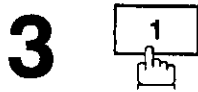

ONE-TOUCH< >
PRESS ONE-TOUCH KEY

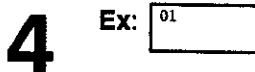

ONE-TOUCH<01> TEL.
█

5 Enter the telephone number.
(up to 36 digits including pauses and spaces)

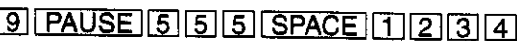
Ex: 

ONE-TOUCH<01> TEL.
9-555 1234█

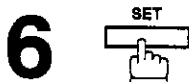



ONE-TOUCH<01> NAME
█

7 Enter the station name using character keys
(up to 15 characters).

Ex: 

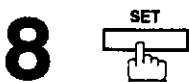
ONE-TOUCH<01> NAME
SALES DEPT.█



To record another number, repeat step 4 to 8.
To return to standby, press .

ONE-TOUCH< >
PRESS ONE-TOUCH KEY

3

One-Touch/Abbreviated Dialling Numbers

To set an Abbreviated Dialling Number, follow these steps below



SET MODE (1-6)
ENTER NO. OR ^ V



1: ONE-TOUCH
2: ABBR. NO.

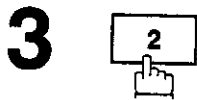

ABBR[]
ENTER ABBR. NO.

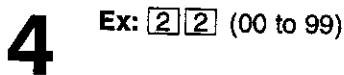

ABBR[22] TEL.
|

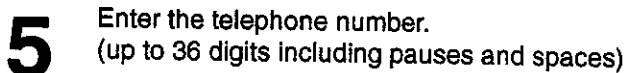

Ex:

ABBR[22] TEL.
9-555 2345|

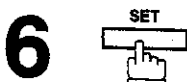

ABBR[22] NAME
|

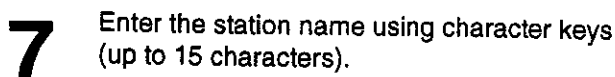

Ex:

ABBR[22] NAME
ACCOUNTING DEPT|

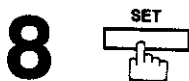

To record another number, repeat step 4 to 8.
To return to standby, press .

ABBR[]
ENTER ABBR. NO.

- !** **Note:**
1. If you require a special access number to get an outside line, enter it first and then press . A hyphen "-" is displayed for pause.
 2. Use to enter a space between the numbers to make it easier to read.
 3. The built-in battery can back up One-Touch/ABBR. Numbers up to 10 days when a power failure occurs.
 4. If you are using Pulse dialling and you wish to change to Tone dialling in the middle of dialling, press (represented by a "/>). The dialling method will be changed from Pulse to Tone after dialling the digit "/).
 5. You can search an unused One-Touch key or ABBR. number by pressing or in step 3 or 4.

One-Touch/Abbreviated Dialling Numbers

Changing or Erasing One-Touch/Abbreviated Dialling Numbers

If you have to change or erase any of the One-Touch/Abbreviated dialling numbers, follow the steps below.

To change the settings of a One-Touch/ABBR. dialling number

1



```
1:ONE-TOUCH
2:ABBR. NO.
```

2

Select 1 for One-Touch Dialling number
Select 2 for ABBR. Dialling Number

Ex:

```
ONE-TOUCH< >
PRESS ONE-TOUCH KEY
```

3

Enter the station you wish to change

Ex:

```
ONE-TOUCH<07> TEL.
9-555 1234
```

4



then enter a new telephone number.(see Note 1 and 2)

Ex:

```
ONE-TOUCH<07> TEL.

```

5



```
ONE-TOUCH<07> TEL.
999 3456
```

6



then enter a new station name.(see Note 1 and 3)

Ex:

```
ONE-TOUCH<07> NAME
PANASONIC
```

7



To return to standby, press .

```
ONE-TOUCH<07> NAME

```

```
ONE-TOUCH<07> NAME
PANAFAX
```

```
ONE-TOUCH< >
PRESS ONE-TOUCH KEY
```



Note: 1. Use or to move the cursor, then enter the correct number over the incorrect number.

2. Use to insert a space between the numbers you set. If the telephone number has full digit (36 digits), cannot be used to insert a space.

3. cannot be used to insert a space in setting of the station name.

4. If the One-Touch/Abbreviated dialling number has been used for a communication reservation, the settings cannot be changed or erased until the communication has finished.

To change or erase the settings, cancel the communication first by File Edit Mode (see page 76).

3

One-Touch/Abbreviated Dialling Numbers

To erase the settings of One-Touch/ABBR. Dialling number



1:ONE-TOUCH
2:ABBR. NO.

2 Select 1 for One-Touch Dialling number
Select 2 for ABBR. Dialling Number

Ex:

ONE-TOUCH< >
PRESS ONE-TOUCH KEY

3 Enter the station you wish to erase

Ex:

ONE-TOUCH<01> TEL.
9-555 4567

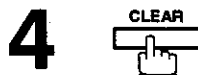

ONE-TOUCH<01> TEL.
█

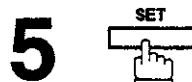

To return to standby, press .

ONE-TOUCH< >
PRESS ONE-TOUCH KEY

One-Touch/Abbreviated Dialling Numbers

Printing Out a Directory Sheet

After programming a one-touch dialling number, you can print out the directory sheet which includes the first 10 characters of each station name. Cut along the dotted line and place it over the One-Touch key under the Directory Sheet Cover. To print out a directory sheet, follow these steps below.

1



PRINT OUT (1-7)
ENTER NO. OR ^ V

2

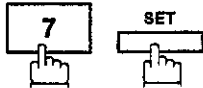

* PRINTING *
DIRECTORY SHEET

Your machine prints out the directory sheet.

*****-DIRECTORY SHEET-***** DATE 08-DEC-1993 ***** TIME 12:00*****

01	02	03	04
SALES DEPT	ENG. DEPT	ABC	
05	06	07	08
09	10	11	12
13	14	15	16
17	18	19	20
21	22	23	24
25	26	27	28
29	30	31	32
P1	P2	P3	P4
P5	P6	P7	P8

dotted line

-PANASONIC-

*****-HEAD OFFICE -**** -201 555 1212- *****

Directory Sheet Cover

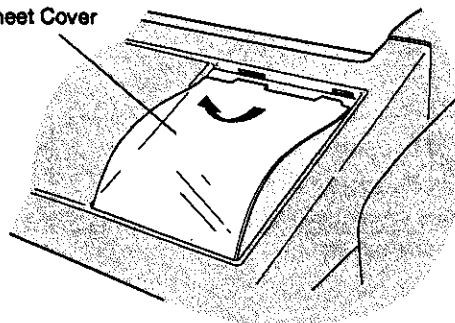

Customizing Your Machine

Your facsimile machine has a variety of adjustable Fax Parameters. These parameters, listed in the Parameter Table, are preset for you and do not need to be changed. If you do want to make a change, read the table carefully. Some parameters, such as the Resolution, Original, and Verification Stamp parameters, can be temporarily changed by simple key operations just before a transmission is made. When the transmission ends, however, these parameters return to their preset values (Home position). Other parameters can only be changed by the procedure described below.

Setting Fax Parameters

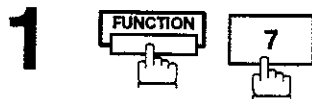

SET MODE (1-6)
ENTER NO. OR ^ V



FAX PARAMETER (01-53)
NO. = █

3 Enter Fax Parameter number from the Parameter Table (see pages 35 to 37).

Ex: for ORIGINAL

FAX PARAMETER (01-53)
NO. = 01

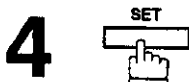

01 ORIGINAL
1: NORMAL

5 Enter the new setting value.

Ex: for LIGHT

01 ORIGINAL
2: LIGHT

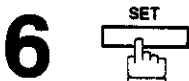

To set another parameter, press to return to step 3, or, to return to standby, press .

02 RESOLUTION
1: STANDARD

- !** **Note:** 1. To scroll the Fax Parameters in Step 2 or 4, press or .
2. To print out a Fax Parameter List, see page 120.
3. The built-in battery when fully charged can back up the Fax Parameter settings for up to 10 days when a power failure occurs.

Customizing Your Machine

Fax Parameter Table

3

No.	Parameter	Setting Number	Setting	Comments
01	ORIGINAL	1	Normal	Setting home position of the ORIGINAL key.
		2	Light	
		3	Dark	
02	RESOLUTION	1	Standard	Setting home position of the RESOLUTION key.
		2	Fine	
		3	S-Fine	
04	STAMP	1	Off	Setting home position of the STAMP key. To select the stamp function when document is stored in memory (see FaxParameter No. 28).
		2	On	
06	DIALING METHOD	1	Pulse	Selecting dialling method.
		2	Tone	
07	HEADER PRINT	1	Inside	Selecting printing position of the header. Inside : Inside TX copy area. Outside : Outside TX copy area. No print : Header is not printed.
		2	Outside	
		3	No print	
08	HEADER FORMAT	1	Logo, ID No.	Selecting header format.
		2	From To	
09	RCV'D TIME PRINT	1	Invalid	Selecting whether or not the machine prints received time, page no, and remote ID on bottom of each received page.
		2	Valid	
10	KEY/BUZZER VOLUME	1	Off	Selecting the volume of the Key/Buzzer tone.
		2	Soft	
		3	Loud	
12	COMM. JOURNAL	1	Off	Selecting home position of printout mode for COMM. Journal Off/Always/Inc. only Off : No printout Always : Always prints out Inc. only : Printout when communication has failed.
		2	Always	
		3	Inc. only	
13	AUTO JOURNAL	1	Invalid	Selecting whether or not the machine prints the journal automatically after every 32 transaction.
		2	Valid	
14	FILE ACCEPTANCE JOURNAL	1	Invalid	Selecting whether or not the machine prints the file acceptance journal. If you set this parameter to valid, the journal will be printed out after entering any communications using memory.
		2	Valid	

Continued on the next page.

Customizing Your Machine

No.	Parameter	Setting Number	Setting	Comments
22	SUBSTITUTE RCV	1	Invalid	Selecting whether or not the machine receives to memory when recording paper runs out, toner runs out or recording paper jammed.
		2	Valid	
24	PRINT REDUCTION	1	Fixed	Selecting print reduction mode. Fixed: Reduce document according to setting of Parameter No. 25.
		2	Auto	Auto: Reduce document according to the length of received documents.
25	REDUCTION RATIO	70	70%	Selecting fixed print reduction ratio from 70% to 100%. This parameter functions only when fixed print reduction is selected on fax parameter no. 24.
		---	---	
		100	100%	
26	POLLING PASSWORD		(----	Setting a 4-digit password for secured polling.
27	POLLED FILE SAVE	1	Invalid	Selecting whether or not the machine retains the polled document in memory even after the document is polled once.
		2	Valid	
28	STAMP AT MEM. XMT	1	Invalid	Selecting whether or not the machine stamps the original documents when storing the documents into memory.
		2	Valid	
31	INCOMPLETE FILE SAVE	1	Invalid	Selecting whether or not the machine retains the document in memory if the document is not successfully transmitted or polled.
		2	Valid	
32	COPY REDUCTION	1	Invalid	Selecting whether or not the machine performs copy reduction in accordance with the setting of Parameter No. 24 and 25.
		2	Valid	
33	XMT REDUCTION	1	Invalid	Selecting whether or not the machine performs reduction when the transmitting document is wider than the recording paper used at the receiving machine.
		2	Valid	
34	POWER SAVE TIMER	--	Start-Time	To reduce the power consumption of the machine in standby, select the time period to turn off the high temperature fuser unit when the printer is idle. Up to 1 minute delay will be required to warm up again before the next printing starts.
		--	End-Time	
37	RCV TO MEMORY		(----	Enter a 4-digit password used to print out the received document in memory by F8-5 (RCV TO MEMORY). When F8-5 is set to On, this parameter will not be shown on the LCD display. (see page 83)
38	FAX ACCESS CODE		(----	Enter a 4-digit Fax Access Code to secure the machine from unauthorized use. (see page 82)
41	RELAY XMT REQUEST	1	Invalid	Selecting whether or not the machine performs Relay XMT Request. (see page 101)
		2	Valid	
42	CONF. FAX PARAMETER	1	Invalid	Selecting whether or not the machine performs Confidential Network Communication. (see page 97)
		2	Valid	

Continued on the next page.

Customizing Your Machine

No.	Parameter	Setting Number	Setting	Comments
43	CONF. POLLED FILE SAVE	1	Invalid	Selecting whether or not the machine saves the confidential polled file even after the file is polled once.
		2	Valid	
44	PASSWORD XMT	1	Off	Setting a 4-digit XMT-Password and selecting whether or not the machine performs and checks the XMT-Password of the receiving station when transmitting. (see page 86).
		2	On	
45	PASSWORD RCV	1	Off	Setting a 4-digit RCV-Password and selecting whether or not the machine performs and checks the RCV-Password of the transmitting station when receiving. (see page 86)
		2	On	
46	SELECT RCV	1	Invalid	Selecting whether or not the machine performs selective reception. (see page 85)
		2	Valid	
48	TELEPHONE LINE	1	PSTN	Selecting the type of line connected.
		2	PBX	
49	PSTN ACCESS CODE		0---	Setting PSTN Access Code. (max. 4 digits)
50	FLASH KEY	1	Earth	Selecting to use FLASH on control panel either as Earth key or Flash key.
		2	Flash	
52	DIAGNOSTIC PASSWORD		(----	Setting the password for Remote Diagnostic Mode. Please ask your Panasonic Authorized Dealer for details.
53	OPTION MEMORY	-	-	Display the amount of base and option memory installed. (Base Memory + Option Memory)

3



- Note:**
1. The contents of Fax Parameter may differ depending on the each country's regulation or specification.
 2. The standard settings are printed on the Fax Parameter List. To print out Fax Parameter List, see page 120.

This page is intentionally left blank.

Loading Documents

Documents You Can Send

In general, your machine will send any document printed on Letter or Legal size paper.

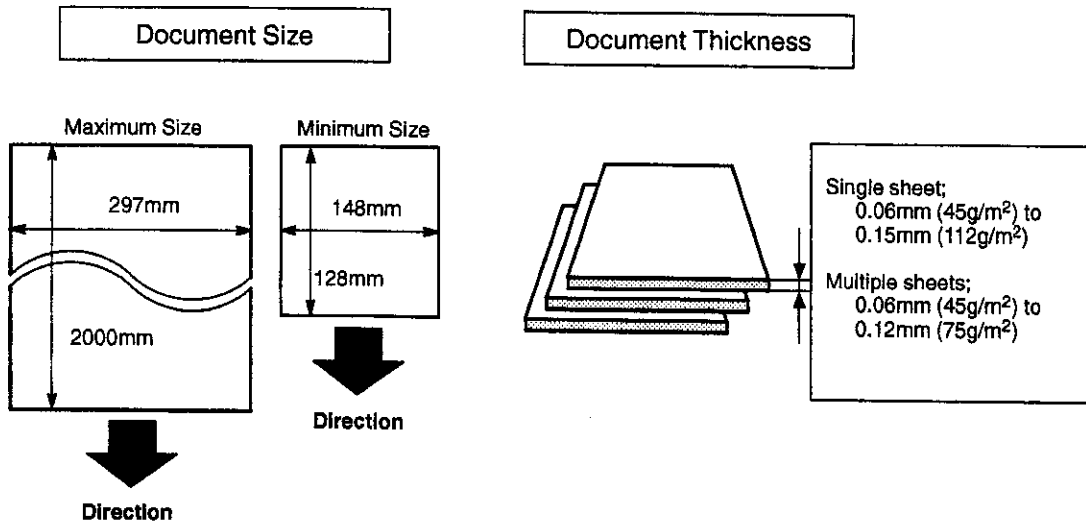

4

Documents You Cannot Send

You must never try to send documents that are

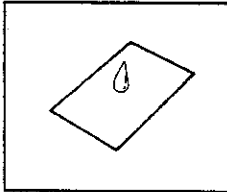
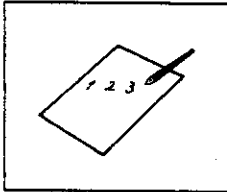
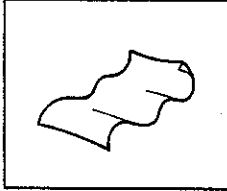
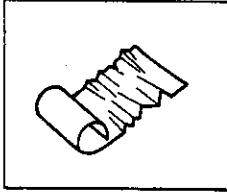
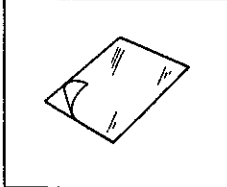
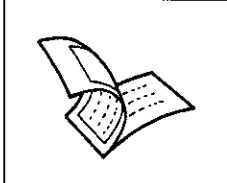
 <p style="text-align: right; margin-right: 5px;">Wet</p>	 <p style="text-align: right; margin-right: 5px;">Covered with wet ink or paste</p>
 <p style="text-align: right; margin-right: 5px;">Too thin (e.g., onionskin, airmail paper, pages from some magazines, etc.)</p>	 <p style="text-align: right; margin-right: 5px;">Wrinkled, curled or folded</p>
 <p style="text-align: right; margin-right: 5px;">Coated (e.g., glossy paper, etc.)</p>	 <p style="text-align: right; margin-right: 5px;">Chemically processed (e.g., pressure-sensitive paper, carbon-coated paper, etc.) or made of cloth or metal</p>

To transmit these kinds of documents, make a photocopy first and then transmit the copy instead.

Loading Documents

How to Load Documents

1. Be sure the document(s) is free of staples, paper clips and is not torn, greasy or covered by foreign objects.
2. Place the document(s) **FACE DOWN** on the Automatic Document Feeder (ADF) until the leading edge placed into the machine stops.
If you are sending multiple pages, make sure that **the bottom sheet enters first**. You can also **stack up to 50 PAGES** (see Note 1) on the ADF at one time. If you have more than 50 pages, wait until transmission or storing in memory starts as pages feed through, place any remaining pages on top of the last page in the feeder.
3. Adjust the Document Guides to center the document on the ADF.

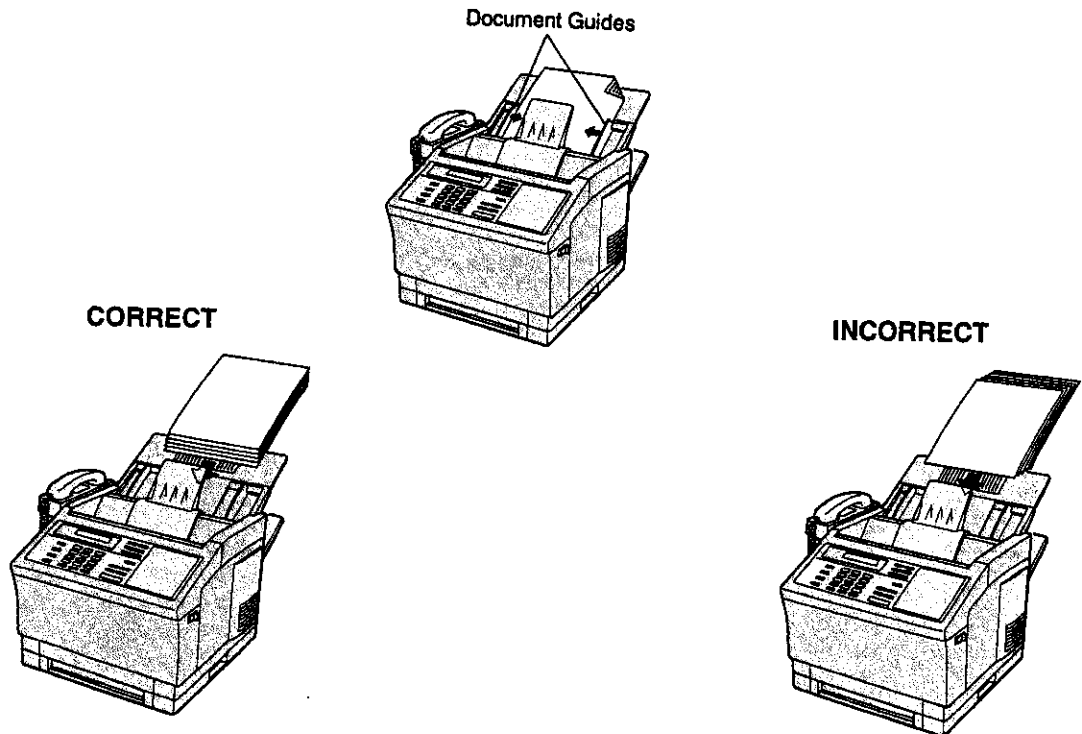

When you set a document on the ADF, the display message will change from date and time (standby) to **DOCUMENT SET**. You can now change basic transmission settings, or begin the dialling procedure.

DOCUMENT SET
ENTER STATION(S) 00%

! **Note:** 1. The document limitation to send multiple pages is as follows.

	Document Size	Document Thickness
Up to 30 pages	Up to A3 size	0.06 mm (45 g/m ²) to 0.12 mm (75 g/m ²)
Up to 50 pages	A4 size	0.12 mm (75 g/m ²)

2. Transmitting documents longer than 356 mm requires user's assistance.
3. When transmitting documents longer than A4 size, please extend the sub-tray as shown below.

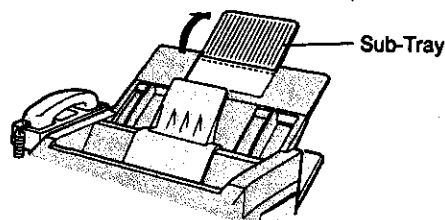

Basic Transmission Settings

You can temporarily change the transmission settings either before or after you place document on the ADF. These settings are as follows;

- Original (Contrast)
- Resolution
- Halftone
- Stamp
- Communication Journal

After your document has been sent, your machine will automatically return to the preset settings.

Original (Contrast)

Your machine is preset to **Normal** contrast. If you have to send a document with light print contrast, you may get better results by changing the setting to **Light**. If you have to send a document with dark print contrast, change the setting to **Dark**.

Press **ORIGINAL** to:

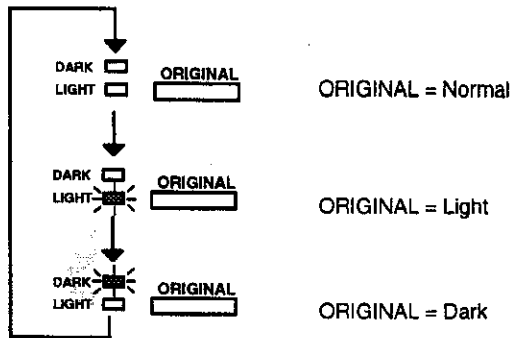

! *Note: To change the preset Contrast position, change the setting of Fax Parameter No. 01, see page 35.*

Resolution

Your machine is preset to **Standard** resolution, which is suitable for most documents. Use **Fine** or **Super Fine** for detailed documents.

Press **RESOLUTION** to:

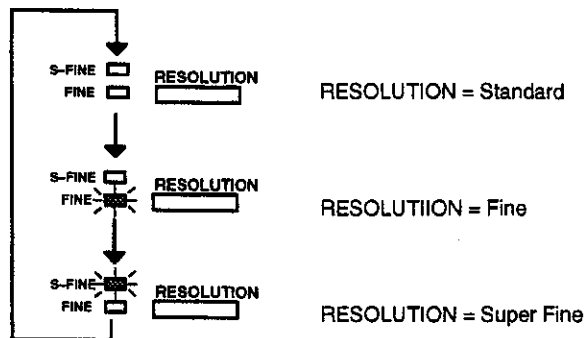

! *Note: To change the preset Resolution position, change the setting of Fax Parameter No. 02, see page 35.*

Basic Transmission Settings

Halftone

The Halftone setting is useful when sending photographs or illustrations with gray tones. Your machine is preset to HALFTONE = Off. You can select either Fast mode or Quality mode.

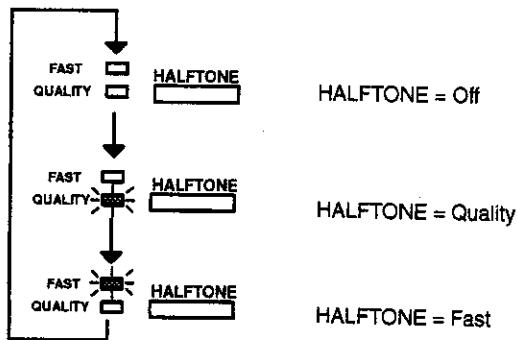

! **Note:** When you select HALFTONE to FAST or QUALITY, your machine will automatically select **Fine Resolution**.

Verification Stamp

The Verification Stamp helps you to confirm successful transmissions by stamping the bottom of each successfully transmitted page with a small ⊗ mark.

Press **STAMP** to:

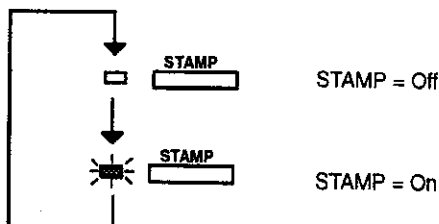

! **Note:** 1. When you store document in memory, the Verification Stamp will not function.
If you wish to enable the use of the Verification Stamp when storing document in memory, change the setting of Fax Parameter No. 28, see page 36.
2. To change the preset Verification Stamp position, change the setting of Fax Parameter No. 04, see page 35.

Basic Transmission Settings

Communication Journal (COMM. JOURNAL)

A Communication Journal lets you verify if the transmission was successful. You can select the condition to print out the communication Journal as follows.

When you set COMM. JOURNAL = OFF,
When you set COMM. JOURNAL = ON,

a Communication Journal will not be printed out.

a Communication Journal is printed out automatically after every communication.

When you set COMM. JOURNAL = INC.,

a Communication Journal is printed out automatically only if the communication has failed.

4

1



SELECT MODE (1-5)
ENTER NO. OR ^ V

2

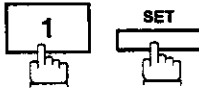

COMM. JOURNAL=INC
1:OFF 2:ON 3:INC

3

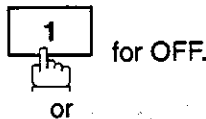

COMM. JOURNAL=OFF
1:OFF 2:ON 3:INC

or

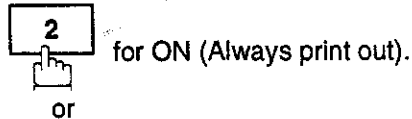

COMM. JOURNAL=ON
1:OFF 2:ON 3:INC

or



COMM. JOURNAL=INC
1:OFF 2:ON 3:INC

4



! Note: To change the preset Comm. Journal position, change the setting of Fax Parameter No. 12, see page 35.

Sending Documents

You can choose either Memory Transmission or Direct Transmission.

Use Memory Transmission if:

- You want to send the same document to multiple stations.
- You have to retrieve the document immediately.

Use Direct Transmission if:

- The memory is full.
- You want to send the document after talking with the other party.

Memory Transmission

Your machine quickly stores the document into the machine's memory. Then, starts to dial the telephone number.

If the transmission fails, your machine will re-transmit the remaining unsuccessful page(s) automatically.

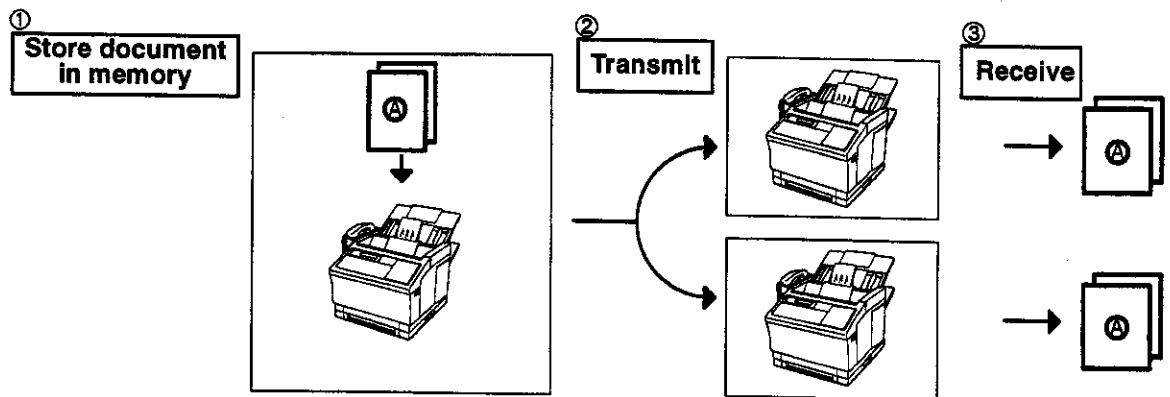

! **Note:** 1. The File Number of the document being stored is shown at the upper right corner of the display while storing the document. It is also printed on the Communication Journal (COMM. JOURNAL), 32 Transaction Journal and File List. The percentage of memory used is shown on the lower right corner of the display after each page is stored.

```
* STORE *      NO.003
          PAGES=02  10%
```

```
* STORE * COMPLETED
TOTAL PAGES=05  30%
```

2. If a memory overflow occurs while storing documents into memory, the machine will prompt on the display, whether to start transmitting those pages which are successfully stored or to cancel the transmission. Press **1** to cancel; press **2** to transmit. See Specifications, page 136 for the image memory capacity.

```
MEMORY OVERFLOW
INFO. CODE=870
```

3. An Information Code will be displayed if the transmission has failed or no answer at the receiving side after the last automatic redial. The document stored for this transmission will be erased from the memory automatically and the transmission is marked "INC" (incomplete) on the Communication Journal (COMM. JOURNAL). If you need to retain the incomplete documents even after the last redial, change Fax Parameter No. 31 (INC. FILE SAVE) to Valid in advance. (see page 36)

```
15 PAGES COMPLETED
DELETE? 1:YES 2:NO
```

```
INCOMPLETE
INFO. CODE=XXX
```

To retry the incomplete documents, refer to page 81.

4. When a power failure occurs, your machine will retain the document information stored in the memory for up to 1 hour, when the battery is fully charged.

Sending Documents

Manual Number Dialling (Memory Transmission)

To dial the telephone number manually using the keypad, follow the steps below.

1



Set document(s) face down.

DOCUMENT SET
ENTER STATION(S) 00%

2



Make sure that the MEMORY lamp is on.
If not, press **MEMORY** to set "On".

3

Enter a telephone number from the keypad.

Ex: **5 5 5 1 2 3 4**

TEL. NO.
5551234

4

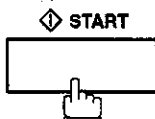

The document is stored into memory with a file number.
Then starts to dial the telephone number.

* STORE * NO.002
PAGES=01 05%

* STORE * COMPLETED
TOTAL PAGES=05 25%

* DIALLING *
5551234

4



Note: 1. If you need a special access number to get an outside line, dial it first then press **PAUSE** to insert a pause (represented by a "-") before dialling the full number.

Ex: **9 PAUSE 5551234**

2. If you are using Pulse dialling and you wish to change to Tone dialling in the middle of dialling, press

TONE (represented by a "r").

The dialling mode will be changed from Pulse to Tone after dialling the digit "r".

3. To stop the transmission, press **STOP**.

The display shows;

COMMUNICATION STOP?
1: YES 2: NO

Press **1** to stop the transmission. The document you stored will be erased automatically.

If you do not want to erase the documents, change the setting of Fax Parameter No. 31 (INC. FILE SAVE) to Valid in advance.(see page 36)

Sending Documents

One-Touch Dialling (Memory Transmission)

One-Touch Dialling allows you to dial a full number by pressing a single key. To set One-Touch keys, see page 29.

1  Set document(s) face down.

```
DOCUMENT SET
ENTER STATION(S) 00%
```

2  **MEMORY**
Make sure that the MEMORY lamp is on.
If not, press **MEMORY** to set "On".

3 Press a One-Touch key.

Ex:

```
ONE-TOUCH
<01> (Station name)
```

4  **START**
The document is stored into memory with a file number.
Then starts to dial the telephone number.

```
* STORE *      NO.002
      PAGES=01  05%
```

```
* STORE * COMPLETED
TOTAL PAGES=05  25%
```

Sending Documents

Abbreviated Dialling (Memory Transmission)

Abbreviated dialling is a speedy way to dial a frequently dialed telephone number by preprogram the telephone number in the built-in auto-dialer with a 2-digit abbreviated code. To program an abbreviated dialling number, see page 30.

1  Set document(s) face down.

DOCUMENT SET
ENTER STATION(S) 00%

2  Make sure that the MEMORY lamp is on.
If not, press **MEMORY** to set "On".

3 Press **ABBR** then enter a 2-digit code.
Ex: **ABBR** **1** **0**

ABBR
[10](Station name)

4  The document is stored into memory with a file number.
Then starts to dial the telephone number.

* STORE * NO.002
PAGES=01 05%

* STORE * COMPLETED
TOTAL PAGES=05 25%

4

Sending Documents

Directory Search Dialling (Memory Transmission)

Directory Search dialling allows you to dial a full telephone number by searching the station name entered in One-Touch keys or Abbreviated Dialling Numbers.

1



Set document(s) face down.

```
DOCUMENT SET
ENTER STATION(S) 00%
```

2



Make sure that the MEMORY lamp is on.
If not, press **MEMORY** to set "On".

3



```
ENTER LETTER(S)
```

4

Enter full station name or part of a station name from character key (see page 9).

Ex: **P A N A** for searching **PANASONIC**

```
ENTER LETTER(S)
PANA
```

5

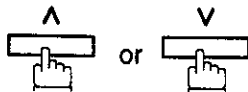

repeatedly until display shows the station name you want to send to.

```
DIRECTORY SEARCH
[15] PANASONIC
```

6



The document is stored into memory with a file number.
Then starts to dial the telephone number.

```
* STORE *      NO.002
      PAGES=01  05%
```

```
* STORE * COMPLETED
TOTAL PAGES=05  25%
```

Sending Documents

Multi-Station Transmission (Broadcasting)

If you have to send a same document to multiple stations, you can save time in feeding the document by using memory transmission. That is, you can store the document into memory and then send it to the station(s) automatically.

1



Set document(s) face down.

```
DOCUMENT SET
ENTER STATION(S) 00%
```

4

2



Make sure that the MEMORY lamp is on.
If not, press **MEMORY** to set "On".

3

Dial by any combination of the following methods.

- Manual Number Dialling (Up to 12 stations)
- One-Touch Dialling
- Abbreviated Dialling
- Directory Search Dialling.

(For details, see page 45 to 48.)

Ex:

ABBR

```
ONE-TOUCH
<01>(Station name)
```

```
ABBR          STNS=002
[10](Station name)
```

(When entering a station for Manual Number Dialling or Directory Search Dialling, press **SET** after each station is entered.)

4



The document is stored into memory with a file number.
Then starts to dial the telephone number in sequence.

```
* STORE *      NO.001
          PAGES=01  01%
```

```
* STORE * COMPLETED
TOTAL PAGES=05  25%
```



Note: You can review the stations you entered in step 3 before storing your document into memory by pressing **^** or **v**. Press **CLEAR** to clear an entered station show on display if needed.

Sending Documents

Direct Transmission (ADF Transmission)

If the machine's memory is full or you wish to send the document after talking with the other party, use Direct Transmission.

Off-Hook Dialling

For Off-Hook Dialling, follow these steps

1



Set document(s) face down.

DOCUMENT SET
ENTER STATION(S) 00%

2

Lift the handset of your external telephone and dial the telephone number from the keypad.

Ex:

3

When you hear the voice of the other party, tell the other party to prepare to receive a document.

Then, when you hear a beep, press and hang up the handset.

ON LINE * XMT *
5551234



Note: To stop the transmission, press .

The display shows;

COMMUNICATION STOP?
1: YES 2: NO

Press to stop the transmission.

Sending Documents

On-Hook Dialling

For On-Hook Dialling, follow these steps

1



Set document(s) face down.

DOCUMENT SET
ENTER STATION(S) 00%

2



You will hear dial tone through the monitor speaker.

* DIALLING *

3

Dial the telephone number from the keypad.

Ex:

Machine will start sending automatically.

* DIALLING *
5551234

ON LINE * XMT *
5551234

4



Note: 1. If you need a special access number to get an outside line, dial it first then press **PAUSE** to enter a pause (represented by a "-") before dialling the full number.

Ex: 9 PAUSE 5551234

2. If you are using Pulse dialling and you wish to change to Tone dialling in the middle of dialling, press **TONE** (represented by a "/").

The dialling mode will be changed from Pulse to Tone after dialling the digit "/".

3. To stop the transmission, press **STOP**.

The display shows;

COMMUNICATION STOP?
1: YES 2: NO

Press **1** to stop the transmission.

4. When you hear the voice of the other party through the monitor speaker in step 3, lift the handset of your external telephone and press **STOP** and tell the other party to prepare to receive a document. Then, when you hear a beep, press **START**.

Sending Documents

Manual Number Dialling (ADF Transmission)

To dial the telephone number manually, follow the steps below.

1  Set document(s) face down.

DOCUMENT SET
ENTER STATION(S) 00%

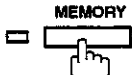
2  Make sure that the lamp goes off.

3 Enter a telephone number from the keypad.

Ex:

PRESS START TO DIAL
5551234

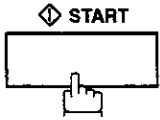
4  Your machine starts to dial the telephone number.

* DIALLING *
5551234

! **Note:** 1. If you need a special access number to get an outside line, dial it first then press **PAUSE** to enter a pause (represented by a "-") before dialling the full number.
Ex: **9 PAUSE 5551234**

2. If you are using Pulse dialling and you wish to change to Tone dialling in the middle of dialling, press **TONE** (represented by a "/").
The dialling mode will be changed from Pulse to Tone after dialling the digit "/".

3. To stop the transmission, press **STOP**.
The display shows;

COMMUNICATION STOP?
1: YES 2: NO

Press **1** to stop the transmission.

4. If you hear the voice of the other party through the monitor speaker after last step, lift the handset of your external telephone and press **STOP** and **1** to stop the communication. Then press **STOP** to stop the alarm. When you hear the beep after telling the other party to prepare to receive the document, press **START** to start fax communication.

Sending Documents

One-Touch Dialling (ADF Transmission)

One-Touch Dialling allows you to dial a full number by pressing a single key. To set One-Touch keys, see page 29.

1



Set document(s) face down.

DOCUMENT SET
ENTER STATION(S) 00%

4

2

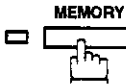

Make sure that the lamp goes off.

3

Press a One-Touch key.

Ex:

The display will show the One-Touch number and station name. The full number (e.g. 9-555 1234) will then be dialed.

ONE-TOUCH
<01> (Station name)

* DIALLING *
9-555 1234



Note: 1. To stop the transmission, press **STOP**.

The display shows;

COMMUNICATION STOP?
1: YES 2: NO

Press **1** to stop the transmission.

2. If you hear the voice of the other party through the monitor speaker after last step, lift the handset of your external telephone and press **STOP** and **1** to stop the communication. Then press **STOP** to stop the alarm. When you hear the beep after telling the other party to prepare to receive the document, press **START** to start fax communication.

Sending Documents

Abbreviated Dialling (ADF Transmission)

Abbreviated dialling is a speedy way to dial a frequently dialed telephone number by preprogram the telephone number in the built-in auto-dialer with a 2-digit abbreviated code. To program an abbreviated dialling number, see page 30.

1



Set document(s) face down.

DOCUMENT SET
ENTER STATION(S) 00%

2

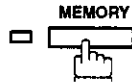

Make sure that the lamp goes off.

3

Press **ABBR** and a 2-digit code.

Ex: **ABBR** **10**

The display will show the ABBR number and station name. The full number (e.g. 9-555 1234) will then be dialed.

ABBR
[10] (Station name)

* DIALLING *
9-555 1234

! **Note:** 1. To stop the transmission, press **STOP**.

The display shows;

COMMUNICATION STOP?
1: YES 2: NO

Press **1** to stop the transmission.

2. If you hear the voice of the other party through the monitor speaker after last step, lift the handset of your external telephone and press **STOP** and **1** to stop the communication. Then press **STOP** to stop the alarm. When you hear the beep after telling the other party to prepare to receive the document, press **START** to start fax communication.

Sending Documents

Directory Search Dialling (ADF Transmission)

Directory Search dialling allows you to dial a full telephone number by searching the station name entered in One-Touch keys or Abbreviated dialling numbers.

1



Set document(s) face down.

DOCUMENT SET
ENTER STATION(S) 00%

2

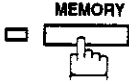

Make sure that the lamp goes off.

3



ENTER LETTER(S)
█

4

Enter full station name or part of a station name from character key (see page 9).

Ex: **P A N A** for searching **PANASONIC**

ENTER LETTER(S)
PANA█

5

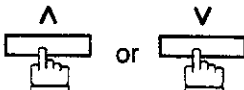

repeatedly until display shows the station name you want to send to.

DIRECTORY SEARCH
[10] PANASONIC

6

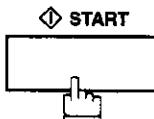

The full number (e.g. 9-555 1234) will be dialed.

* DIALLING *
9-5551234█

4



Note: 1. To stop the transmission, press **STOP**.

The display shows;

COMMUNICATION STOP?
1: YES 2: NO

Press **1** to stop the transmission.

2. If you hear the voice of the other party through the monitor speaker after last step, lift the handset of your external telephone and press **STOP** and **1** to stop the communication. Then press **STOP** to stop the alarm. When you hear the beep after telling the other party to prepare to receive the document, press **START** to start fax communication.

Sending Documents

Transmission Reservation

You can do the following while sending a document from memory or receiving a document.

- Reserve next transmission into memory for up to 10 different documents.
- Reserve a priority transmission.

Memory Transmission Reservation (Dual Access)

If your machine is on-line busy transmitting from memory, receiving or printing received documents, you can reserve transmission by the following procedure.

- 1** Your machine is on-line, the ON LINE lamp is blinking or printing received documents.

```
ON LINE * MEM.XMT *  
ID:(Identification)
```

```
ON LINE * RCV *  
ID:(Identification)
```

```
* PRINTING *  
MEMORY RCV'D DOC
```

```
DOCUMENT SET  
ENTER STATION(S) 00%
```

- 2**  Set document(s) face down.

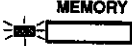
- 3**  Make sure that the MEMORY lamp is on.
If not, press **MEMORY** to set "On".

- 4** Dial by any combination of the following methods.
- Manual Number Dialling (Up to 12 stations total in all files)
 - One-Touch Dialling
 - Abbreviated Dialling
 - Directory Search Dialling
- (For details, see pages 45 to 48.)

Ex:

(When entering a station for Manual Number Dialling or Directory Search Dialling, press **SET** after each station is entered.)

```
ONE-TOUCH  
<01>(Station name)
```

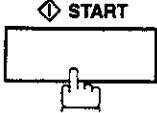
- 5**  Your machine will store the document into memory.

```
* STORE * NO.005  
PAGES=01 01%
```

```
* STORE * COMPLETED  
TOTAL PAGES=05 25%
```

! **Note:** To cancel the memory transmission reservation, see page 78.

Sending Documents

Direct Transmission Reservation (Priority Transmission Reservation)

If you are in a rush to send an urgent document, however there are many files in the memory, use Direct Transmission Reservation to send the urgent document. The urgent document will be sent immediately after the current communication is finished.

Note that you cannot send the documents to multiple stations.

To reserve your machine for sending the urgent documents

- 1 Your machine is on-line, the ON LINE lamp is blinking or printing received documents.

```
ON LINE * MEM.XMT *  
ID:(Identification)
```

```
ON LINE * RCV *  
ID:(Identification)
```

```
* PRINTING *  
MEMORY RCV'D DOC
```

```
DOCUMENT SET  
ENTER STATION(S) 00%
```

2



Set document(s) face down.

3

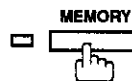

Make sure that the lamp goes off.

4

Dial a number by using any of following.

- Manual Number Dialling and press **START**
- One-Touch Dialling
- Abbreviated Dialling
- Directory Search Dialling and press **START**
(For details, see pages 52 to 55.)

Ex:

You can reserve sending an urgent document to a single station only.

A message "DIRECT XMT RESERVED" will be shown on the display.

```
ONE-TOUCH  
<01>(Station name)
```

```
DIRECT XMT RESERVED  
<01>(Station name)
```

To cancel the direct transmission reservation

- 1 Make sure the document is on the ADF.

2

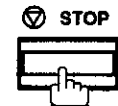

3

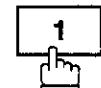

and then remove the document from ADF.

```
DIRECT XMT RESERVED  
<01>(Station name)
```

```
CANCEL XMT RESERVE ?  
1:YES 2:NO
```

4

Sending Documents

Redialling

Automatic Redialling

If the line is busy or there is no answer, your machine will redial the number up to 5 times at 3 minutes interval. During that time, a message will appear as shown to the right.

WAITING TO DIAL
(Telephone number)

- If the line is still busy after the last try, a message will appear as shown to the right and your machine will print out a COMM. Journal depending on the setting of Fax Parameter No. 12.

INCOMPLETE
INFO. CODE=630

- When transmitting from memory and there is no answer after the last try, the stored document will be automatically erased. If you wish to retain the document in memory even if the transmission failed, change the setting of Fax Parameter No. 31 (INC. FILE SAVE) to Valid (see page 36). To retry an incomplete document.(see page 81)

Manual Redialling

You can also redial the last dialed number manually by pressing the **REDIAL** key.

To redial the last dialed number through memory

1



Set document(s) face down.
Make sure that the MEMORY lamp is on.

DOCUMENT SET
ENTER STATION(S) 00%

2



3

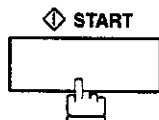

The document is stored into memory with a file number.
Then dials the last dialed number.

TEL NO.
5551234

* STORE * NO.002
PAGE=01 01%

To redial the last dialed number through ADF

1



Set document(s) face down.

2



3



Your machine starts to dial the last dialed number.

* DIALLING *

* DIALLING *
5551234

Receiving Documents

Your machine is provided with both automatic and manual reception modes. The selection of either reception mode is made by using **MANUAL RCV** key.

Automatic Reception

Your machine will receive documents automatically if the **MANUAL RCV** lamp is off.

To set automatic reception

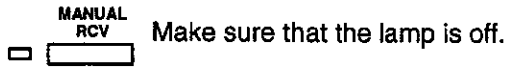

Manual Reception

You may wish to receive documents manually if you use the telephone line in your office primarily as a personal telephone and occasionally for your facsimile machine.

To set manual reception

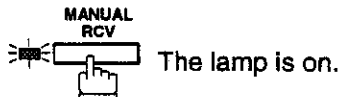

08-DEC-1993 15:00
MANUAL RCV 00%

To receive documents manually

1 When the telephone rings, lift the handset. If you hear a beep, the sound tells you that someone wants to send a document.

2 Remove any documents from the ADF.

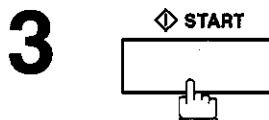

Your machine starts receiving the document.

ON LINE * RCV *

4 Hang up the telephone.

Receiving Documents

Print Reduction

This machine can use Letter, Legal or A4 size plain paper for recording. Sometimes, oversized documents sent to you by the other parties cannot be printed within a single page. When this occurs, the document will be divided into separate pages.

This machine is equipped with a Print Reduction function to solve this problem. You may select the most appropriate setting from the selections described below.

1. Automatic Reduction

Each page of a received document is first stored in memory. Based on the document length, your machine will automatically calculate the suitable reduction ratio (70% to 100%) to print the entire document on a single page. If the received document is extremely long (over 39% longer than the recording paper), the document will be divided into separate pages and printed with no reduction.

2. Fixed Reduction

You can predetermine the reduction ratio from 70% to 100% in 1% steps. The document you received will be reduced to this ratio regardless of the size.

Selecting the Print Reduction Mode

Set Fax Parameters as shown below. (see page 36)

1. To set Automatic Reduction mode.

(1) No. 24 Print Reduction set to "Auto".

2. To set Fixed Reduction mode.

(1) No. 24 Print Reduction set to "Fixed".

(2) No. 25 Reduction Ratio set to any number between 70% through 100%. (see Note)

Ex: A4 to A4 – 96%

A4 to Letter – 90%

Letter to Letter – 96%

Legal to Letter – 75%

 **Note:** If sending side is set to print the header on outside of the copy area, more reduction ratio will be required.

Receiving Documents

Receiving Oversize Documents

If received document is extremely long (over 39% longer than the recording paper), the document will be divided into separate pages. When printing on separate pages, the bottom 10mm of first page will be overlapped on top of the next page.

Transmitted Document

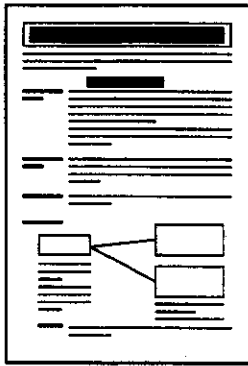

Received Document

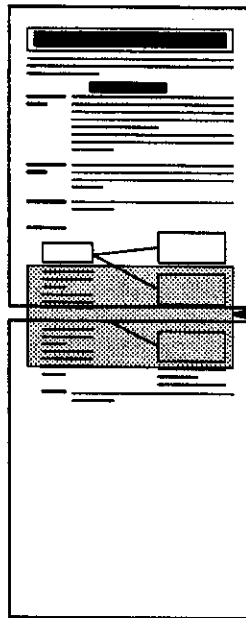

Overlap print.
10 mm

The receiving document is divided into two sheets with overlap printing.



Note: If the reduction method is set to Automatic Reduction mode, the document is printed out with no reduction when printing out separate pages. If the reduction method is set to Fixed Reduction mode, the document is printed out by the ratio you set in Fax Parameter No. 25.

Receiving Documents

Substitute Memory Reception

If the recording paper runs out or jams or if the toner runs out during reception, the machine automatically starts receiving document into its image data memory. Stored documents are printed automatically after replacing the recording paper or toner cartridge.

- 1** When the machine finishes the memory reception and there is no recording paper or toner, an Information Code appears on the display.

NO RECORDING PAPER
INFO. CODE=010

OUT OF TONER
INFO. CODE=041

- 2** Install recording paper (see page 18) or replace the toner cartridge (see page 16).

The machine will automatically start printing the document stored in the memory.

* PRINTING *
MEMORY RCV'D DOC

- !** **Note:**
- 1. If the memory overflows, the machine will stop receiving and release the communication line. The document(s) stored in the memory up to that moment will be printed out automatically.*
 - 2. When a power failure occurs, your machine will retain the document information stored in the memory for up to 1 hour, when the battery is fully charged.*
 - 3. If you wish to turn off the substitute reception function, change the setting of Fax Parameter No. 22 to "Invalid" (see page 36).*

Making Copies

Your machine has a copy function which can make single or multiple copies. When copying, your machine will automatically select Fine resolution.

1



Set document(s) face down.

DOCUMENT SET
ENTER STATION(S) 00%

2



* COPY *
NO. OF COPY=1

3

Enter the number of copies.

Ex:

* COPY *
NO. OF COPY=10

4



* STORE * NO.005
PAGES=01 01%

* STORE * COMPLETED
TOTAL PAGES=05 25%

* COPY *
NO. OF COPY=01/10

The machine stores the document, then prints the copies.



Note: 1. The copy will be reduced automatically depending on the length of original document. If you wish to disable reduction function in copy mode, change the setting of Fax Parameter No. 32 (COPY REDUCTION) to "Invalid" (see page 36).

2. Super Fine resolution is not available when copying.



Using the Machine's Telephone

Making a Regular Call

[Note : This feature is only available from the handset of facsimile machine.]

You can use the handset on your machine to make regular calls. To do so, lift the handset and dial the full number just as you would using an ordinary telephone. If you wish, you can also use the One-Touch/ABBR. Number dialling.

- 1** Remove the document from the ADF.
- 2** Lift the handset.
- 3** Dial a number by using one of the following methods.
 - Manual Number Dialling
 - One-Touch Dialling
 - Abbreviated Dialling
 - Directory Search Dialling

Ex:

* PHONE OFF HOOK *

ONE-TOUCH
<02> (Station name)

* DIALLING *
555 1234

Making Voice Contact after Sending/Receiving

You may want to talk to the other person over the telephone after sending or receiving documents. To do so, perform Step 1 while the machine is still sending or receiving.

When sending

ON LINE * XMT *
ID: (Identification)

ON LINE * XMT * TEL
ID: (Identification)

ON LINE * XMT * TEL
OPERATOR CALLING

When receiving

ON LINE * RCV *
ID: (Identification)

ON LINE * RCV * TEL
ID: (Identification)

ON LINE * RCV * TEL
OPERATOR CALLING

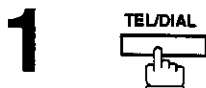

When sending/receiving is over, you will hear a signal (ringing) through the monitor speaker.

- 2** Lift the fax handset or your extension phone and press to talk.

Answering a Voice Contact Request

When you hear a signal (ringing) through the monitor speaker, it means you are receiving a voice contact request. Follow the above Step 2 to talk.

Timer Controlled Communications

You can send a document to one or multiple stations at any preset time within the next 24 hours. Up to 10 built-in timers can be set for deferred transmission and deferred polling.

Deferred Transmission

1



Set document(s) face down.

DOCUMENT SET
ENTER STATION(S) 00%

2



DEFERRED COMM. NO.=
1:XMT 2:POLLING

3

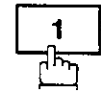

DEFERRED XMT
START TIME | :

4

Enter start time using the keypad.
(Use a 4-digit, 24-hour clock)

Ex: (11:30 p.m.) and

DEFERRED XMT
ENTER STATION(S)

5

Dial by any combination of the following methods.

- Manual Number Dialling (Up to 12 stations)
- One-Touch Dialling
- Abbreviated Dialling
- Directory Search Dialling

Ex:

(When entering a station for Manual Number Dialling or Directory Search Dialling, press after each station is entered.)

ONE-TOUCH
<02>(Station name)

6

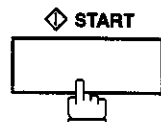

to store documents into the memory.

* STORE * NO.002
PAGES=01 05%

* STORE * COMPLETED
TOTAL PAGES=05 30%



- Note:**
1. If you enter a wrong number in Step 4, press then re-enter the right number.
 2. To change or cancel the Deferred Communication settings, see page 75.
 3. If you reserved the deferred transmission without storing into memory, the display shows "TIMER" on the upper right corner after pressing in last step.

Timer Controlled Communications

Deferred Polling

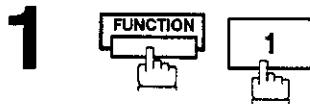

DEFERRED COMM. NO. = **1**
1: XMT 2: POLLING



DEFERRED POLLING
PASSWORD = **■■■■**

3 Enter a 4-digit polling password.
Ex: **9 8 7 6** and **SET**

DEFERRED POLLING
START TIME **■** :

4 Enter start time using the keypad.
(Use a 4-digit, 24-hour clock)

Ex: **0 3 3 0** (3:30 a.m.) and **SET**

DEFERRED POLLING
ENTER STATION(S)

5 Dial by any combination of the following methods.
• Manual Number Dialling (Up to 12 stations)
• One-Touch Dialling
• Abbreviated Dialling
• Directory Search Dialling and press **SET**

Ex: **10**

(When entering a station for Manual Number Dialling or Directory Search Dialling, press **SET** after each station is entered.)

ONE-TOUCH
<10> (Station name)

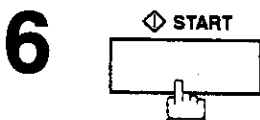

* STORE * NO.001

- !** **Note:** 1. If you enter a wrong number in Step 3, press **CLEAR**, then re-enter the right number.
2. To change or cancel the Deferred Communication settings, see page 75.

Polling

Polling means calling other station(s) to retrieve a document. The other station must know in advance that you will call and must have a document set on the ADF or stored in the memory. You may need to set a polling password, shared by the other station, to ensure security.

Setting Polling Password

If the polling password does not match with the polled station, your polling request will be refused automatically.

To set the polling password, follow the steps below.

1



SET MODE (1-6)
ENTER NO. OR ^ V

2

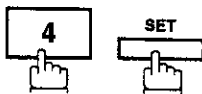

FAX PARAMETER(01-53)
NO. =

3



26 POLLING PASSWORD
■■■■

4

Enter a 4-digit polling password.

Ex: 1 2 3 4

26 POLLING PASSWORD
1234

5

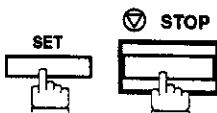

- Note:**
1. Polling might not function with all fax machines. We suggest you attempt a trial polling before you actually poll important documents.
 2. If a password is not set in the polled station, you may poll the other station even though your machine has a password.

Polling

Preparing to be Polled

In order to let other stations poll your machine, you must prepare your machine with a document stored in memory. Be sure to set the polling password before storing the document into memory. After being polled, the documents stored in the memory will be erased automatically.

1



Set document(s) face down.

```
DOCUMENT SET
ENTER STATION(S) 00%
```

2



```
POLLING NO.=
1:POLLING 2:POLLED
```

3



```
POLLED
PASSWORD=1234
```

4

Enter a 4-digit polling password.(see Note 3)

Ex: 4 3 2 1

```
POLLED
PASSWORD=4321
```

5

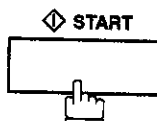

The document(s) will be stored into memory.

```
* STORE * NO.015
PAGES=01 01%
```

```
* STORE * COMPLETED
TOTAL PAGES=05 24%
```



- Note:**
1. You can still send or receive documents even when set to be polled.
 2. Only 1 polled file can be stored in memory. If you need to add document into the same polled file, see page 80.
 3. If you have set the polling password in Fax Parameter No. 26, the password will appear on the display. You can still change the password temporarily by overwriting it with a new one.

To Poll Documents from Another Station

The following procedure lets you poll a document from one or multiple stations (up to 152 stations). Be sure to set the polling password before polling (see page 67).

1



POLLING NO. =
1: POLLING 2: POLLED

2



POLLING
PASSWORD=1234

3

Enter a 4-digit polling password. (see Note 2)

Ex:

POLLING
PASSWORD=1111

4



POLLING
ENTER STATION(S)

5

Dial by any combination of the following methods.

- Manual Number Dialling (Up to 12 stations)
- One-Touch Dialling
- Abbreviated Dialling
- Directory Search Dialling

Ex: and

(When entering a station for Manual Number Dialling or Directory Search Dialling, press after each station is entered.)

ABBR
[10] (Station name)

6

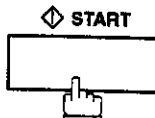

* STORE * NO.001

* DIALLING *
[10] (Station name)

! **Note:** 1. You can review the entered stations in step 5 by pressing or key, press to erase the displayed station as needed.

2. If you have set the polling password in Fax Parameter No. 26, the password will appear on the display. You can still change the password temporarily by overwriting it with a new one.

5

Program Keys

Your fax machine has special Program Keys. These keys are useful if you frequently need to send or poll the same group of stations. You can use these keys to store a sequence of stations to be polled, a deferred transmission or polling sequence, an additional One-Touch key or a One-Touch group key.

Setting for Deferred Transmission

To set a Program Key for deferred transmission



PROGRAM [P]
PRESS PROGRAM KEY

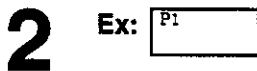

PROGRAM [P1] NO. =
1:PROG 2:ONE-TOUCH

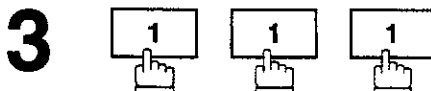

PROGRAM [P1]
START TIME | :



Ex: (11:30 p.m.) and

PROGRAM[P1]
ENTER STATION(S)

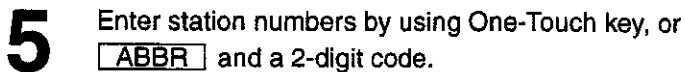

Ex:

You may use the or keys to review the entered station(s) before going to next step. If you find an error, press to erase the displayed station.

ONE-TOUCH
<02>(Station name)

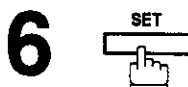

PROGRAM [P1] NAME
|

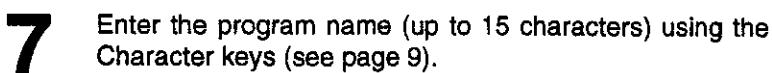

Ex: PROG.A and

PROGRAM [P]
PRESS PROGRAM KEY

You can now set other Program Keys by repeating the procedures from Step 2, or return to standby by pressing .

Program Keys

Setting for Normal Polling

To set a Program Key for normal polling



```
PROGRAM [ P ]  
PRESS PROGRAM KEY
```

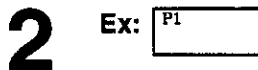

```
PROGRAM [P1] NO.=  
1:PROG 2:ONE-TOUCH
```

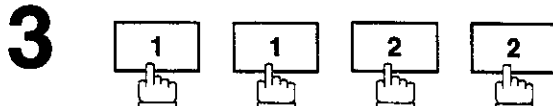

```
POLLING  
PASSWORD=
```



Ex: and

The polling password appears if it has been previously set.

```
PROGRAM[P1]  
ENTER STATION(S)
```

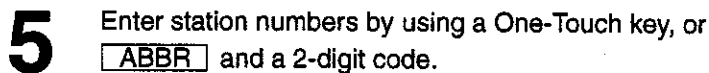

Ex:

You may use the or keys to review the entered station(s) before going to the next step. If you find an error, press to erase the displayed station.

```
ONE-TOUCH  
<02>(Station name)
```

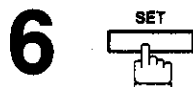

```
PROGRAM [P1] NAME  
|
```

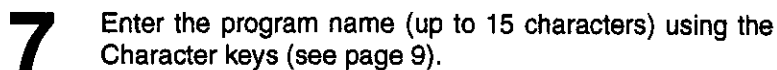

Ex: PROG.A and

```
PROGRAM [ P ]  
PRESS PROGRAM KEY
```

You can now set other Program Keys by repeating the procedures from Step 2, or return to standby by pressing .

5

Program Keys

Setting for Deferred Polling

To set a Program Key for deferred polling



PROGRAM [P]
PRESS PROGRAM KEY



PROGRAM [P1] NO. =
1:PROG 2:ONE-TOUCH

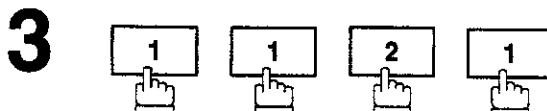

DEFERRED POLLING
PASSWORD=

4 Enter a 4-digit polling password.



PROGRAM [P1]
START TIME :

The polling password appears if it has been previously set.

5 Enter the starting time.

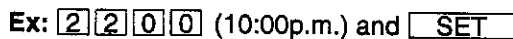

PROGRAM[P1]
ENTER STATION(S)

6 Enter the station numbers by using One-Touch Key, or ABBR and a 2-digit code.

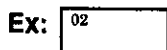

ONE-TOUCH
<02>(Station name)

You may use the \wedge or \vee keys to review the entered station(s) before going to next step. If you find an error, press CLEAR to erase the displayed station.

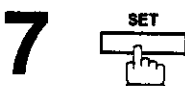

PROGRAM [P1] NAME
|

8 Enter the program name (up to 15 characters) using the Character keys (see page 9).



PROGRAM [P]
PRESS PROGRAM KEY

You can now set other Program Keys by repeating the procedures from Step 2, or return to standby pressing STOP.

Program Keys

Setting for Group Dialling

To set a Program Key for Group Dialling

1

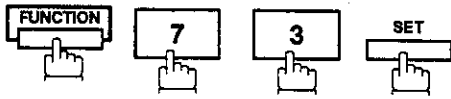

```
PROGRAM [ P ]  
PRESS PROGRAM KEY
```

2

Ex: P1

```
PROGRAM [P1] NO.=  
1:PROG 2:ONE-TOUCH
```

3

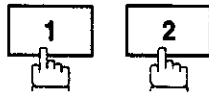

```
PROGRAM[P1]  
ENTER STATION(S)
```

4

Enter the station numbers by using One-Touch Key, or **ABBR** and two-digit code.

Ex: 02 and **ABBR** 3 8

You may use the **^** or **v** keys to review the entered station(s) before going to next step. If you find an error, press **CLEAR** to erase the displayed station.

```
ONE-TOUCH  
<02>(Station name)
```

```
ABBR STNS=002  
[38](Station name)
```

5



```
PROGRAM [P1] NAME  
|
```

6

Enter the program name (up to 15 characters) using the Character keys (see page 9).

Ex: PROG.A and **SET**

```
PROGRAM [ P ]  
PRESS PROGRAM KEY
```

You can now set other Program Keys by repeating the procedures from Step 2, or return to standby by pressing **STOP**.

5

Program Keys

Setting for One-Touch Key

To set a Program Key for One-Touch Key

1

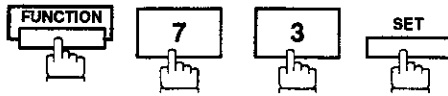

PROGRAM [P]
PRESS PROGRAM KEY

2

Ex: P1

PROGRAM [P1] NO.=
1:PROG 2:ONE-TOUCH

3



PROGRAM [P1] TEL.
|

4

Enter a telephone number (up to 36 digits including pauses and spaces).

Ex: 9 PAUSE 5 5 5 SPACE
1 2 3 4

PROGRAM [P1] TEL.
9-555 1234

5



PROGRAM [P1] NAME
|

6

Enter the station name (up to 15 character) using the Character keys (see page 9).

Ex: PROG.A and SET

PROGRAM [P]
PRESS PROGRAM KEY

You can now set other Program Keys by repeating the procedures from Step 2, or return to standby by pressing STOP.

Program Keys

Changing or Erasing Program Key Settings

To change the settings in a Program Key, follow the procedure on setting Program Keys on pages 70 to 74.

- Start time or station(s) for deferred transmission
- Station(s) for normal polling
- Start time or station(s) for deferred polling
- Station(s) for group dialling
- Telephone number and station name for One-Touch key

To erase the settings in a Program Key

1



```
SET MODE      (1-6)
ENTER NO. OR ^ V
```

2

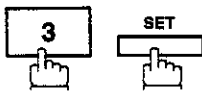

```
PROGRAM [ P ]
PRESS PROGRAM KEY
```

3

Press the Program key you want to erase.

Ex: P1

```
PROGRAM[P1]   NO.=1
1:PROG 2:ONE-TOUCH
```

4



```
PROGRAM [P1] NO.=1
1:PROG 2:ONE-TOUCH
```

5



You can now erase other Program Keys by repeating the procedures from Step 3, or return to standby by pressing

STOP.

```
PROGRAM [ P ]
PRESS PROGRAM KEY
```

5

File Edit Mode

Your machine has a document image memory which enables you to reserve memory transmission, memory deferred transmission, memory polling and so on.

After reserving the communications in memory, you may need to change the settings of the communications while it is still in memory. This section describes how to use the file editing features.

Printing a File List

The contents of the communication settings may have to be modified or deleted. To verify the contents, follow these steps below to print out a file list.

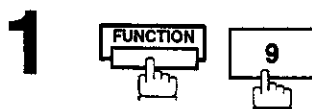

```
EDIT MODE      (1-6)
ENTER NO. OR A V
```

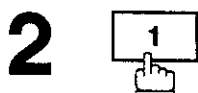

```
1:PRINT FILE LIST?
PRESS SET TO PRINT
```

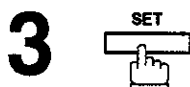

```
* PRINTING *
FILE LIST
```

Sample File List

```
***** -FILE LIST- ***** DATE 08-DEC-1993 ***** TIME 12:00 *****
```

(1) FILE No.	(2) COMM. TYPE	(3) CREATE TIME	(4) START TIME	(5) PAGE	(6) DESTINATION(S)
001	DEFERRED XMT	08-DEC 18:20	20:30	001	{01},{02},{03},<01> 555 1234
002	MEM. DEF. XMT	08-DEC 18:20	22:30	003	{11},{12},{13},{16},{17}
003	RCV TO MEMORY	07-DEC 22:00		002	
004	CONF. MAIL	08-DEC 03:15		005	

```
(7)
-PANASONIC
***** -HEAD OFFICE - ***** 201 555 1212- *****
(9) (8)
```

Explanation of Contents

- | | |
|------------------------------|-------------------------------------------------------------------------------------------|
| (1) File number | :If the file is now being executed, a "*" is indicated on the left of the file number. |
| (2) Communication type | |
| (3) Stored date/time | :Date/time that these files were stored. |
| (4) Executing time | :If the file is Timer Controlled Communication, the start time is printed in this column. |
| (5) Number of stored page(s) | |
| (6) Destination | :ABBR. No./One-Touch No./Manual Dialling No. |
| (7) Own LOGO | :Up to 25 characters |
| (8) Own ID number | :Up to 20 digits |
| (9) Own Character ID | :Up to 16 characters |

File Edit Mode

Changing Start Time or Station of a File

Follow these steps to change the start time and/or stations in a communication file.

1



```
EDIT MODE      (1-6)
ENTER NO. OR ^ V
```

2

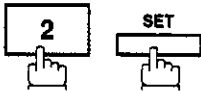

```
CHANGE TIME/STN
FILE NO.=■■■
```

3

Enter the file number you want to change.

Ex: 0 0 1

```
CHANGE TIME/STN
FILE NO.=001
```

4



```
DEFERRED XMT
START TIME    20:30
```

5

Enter a new start time.

Ex: 0 6 0 0 (6:00 AM)
(If you do not have to change the time, skip to step 6.)

```
DEFERRED XMT
START TIME    06:00
```

6



```
TEL NO.
5551234
```

7

To delete station(s), press or key until the station you want to delete appears. Then press **CLEAR**.

or

Enter the station(s) you want to add.

Ex: 02

```
DEFERRED XMT
ENTER STATION(S)
```

8

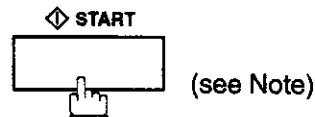

```
ONE-TOUCH
<02>(Station name)
```

! **Note:** If you edit the file that is saved for a incomplete file, after pressing **START** in step 8, your machine will prompt you to execute the file immediately or not.
The display shows;

```
RETRY INCOMP. FILE?
1: YES 2: NO
```

Press **1** to execute the file immediately.

5

File Edit Mode

Deleting File

Follow these steps to delete the file in memory.

1



```
EDIT MODE      (1-6)
ENTER NO. OR ^ V
```

2

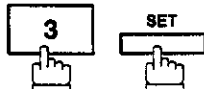

```
DELETE FILE
FILE NO.=■■■
```

3

Enter the file number you want to delete.

Ex:

```
DELETE FILE
FILE NO.=001
```

4



```
* DELETING *
FILE NO.=001
```

File Edit Mode

Printing Out a File

Follow these steps to print the contents of the communication file.

1



```
EDIT MODE      (1-6)
ENTER NO. OR ^ V
```

2



```
PRINT FILE
FILE NO. =■■■
```

3

Enter the file number you want to print.

Ex:

```
PRINT FILE
FILE NO. =001
```

4



Your machine will print the file. The document will remain in memory even after printing of the file.

```
* PRINTING *
PAGE=001/003
```

5

! *Note: Your machine cannot print the same file while it is being sent.*

File Edit Mode

Adding Documents into a File

Follow these steps to add documents into the file.

1



Set document(s) face down.

```
DOCUMENT SET
ENTER STATION(S) 00%
```

2

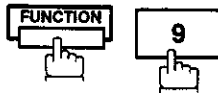

```
EDIT MODE      (1-6)
ENTER NO. OR ^ V
```

3

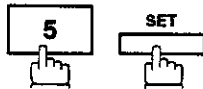

Enter the file number you want to add documents.

Ex: 0 0 1

```
ADD DOCUMENT
FILE NO.=■■■
```

```
ADD DOCUMENT
FILE NO.=001
```

4



Your machine will start storing the document into the file.

```
* STORE *      NO.001
PAGES=01      10%
```

Retry an Incomplete File

If a memory communication has been unsuccessful due to a busy line or no answer, the document you stored is automatically erased from memory after the last redial.

If you need to retain the document even if the communication failed, change the setting of Fax Parameter No. 31 (INC. FILE SAVE) to Valid in advance. (see page 36)

To retry the incomplete file, print a File List to check the file number (see page 76). Then, follow these steps below.

1



EDIT MODE (1-6)
ENTER NO. OR ^ V

5

2

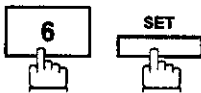

RETRY INCOMP. FILE
FILE NO.=■■■

3

Enter the file number you want to retry.

Ex: 0 0 1

RETRY INCOMP. FILE
FILE NO.=001

4



Your machine will retry the file and starts dialling immediately.

* DIALLING *

Fax Access Code

The Fax Access Code prevents an unauthorized user from operating the machine. Once a 4-digit Fax Access Code is registered, no one can operate the machine without entering the correct access code. Automatic Receiving, however, is always available. After you complete any operation, such as mode setting or transmission, and the display returns to standby, you have to reenter the access code in order to use the machine again. Registering the Fax Access Code does not affect the use of the machine in any other way.

Setting the Fax Access Code

1   SET MODE (1-6)
ENTER NO. OR ^ V

2   FAX PARAMETER (01-53)
NO. = █

3    38 FAX ACCESS CODE
████

4 Enter a 4-digit Fax Access Code.
Ex: 1 2 3 4 38 FAX ACCESS CODE
1234

5   38 FAX ACCESS CODE
1234

! **Note:** To erase the Fax Access Code, enter Access Code and press SET and follow the procedure above to step 3, then press CLEAR SET and STOP.

Operating Your Machine with Fax Access Code

1 Enter the Fax Access Code.
Ex: 1 2 3 4 08-DEC-1993 15:00
ACCESS CODE=█

08-DEC-1993 15:00
ACCESS CODE=1234

2  08-DEC-1993 15:00
00%
Now you can operate the machine using normal procedures.

Receive To Memory

This feature is used to secure all received documents by storing them into the memory. To print out the document from memory, the authorized operator must enter the correct password.

Setting the RCV To Memory Password

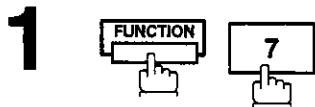

SET MODE (1-6)
ENTER NO. OR ^ V



FAX PARAMETER (01-53)
NO. =

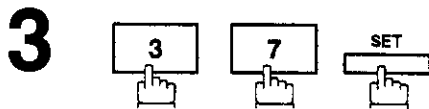

37 RCV TO MEMORY

4 Enter a 4-digit RCV to Memory Password.

Ex:

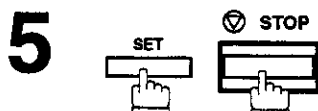

37 RCV TO MEMORY
1234

5

Setting RCV To Memory

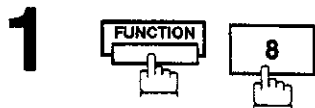

SELECT MODE (1-5)
ENTER NO. OR ^ V



RCV TO MEMORY=OFF
1:OFF 2:ON 3:PRINT



RCV TO MEMORY=ON
1:OFF 2:ON 3:PRINT

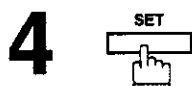

08-DEC-1993 15:00
<RCV TO MEMORY>

- !** **Note:** 1. When the memory overflows, the machine will stop receiving and release the line. The machine will not answer the next incoming call until there is space available in the memory.
2. We recommend that optional memory be installed when this function is used. See page 136 for Image Memory Capacity.

Receive To Memory

Printing Out Documents

After receiving a document with Receive To Memory feature, the following message will appear on the display.

MESSAGE IN MEMORY
<RCV TO MEMORY>

To print the document, follow these steps below.

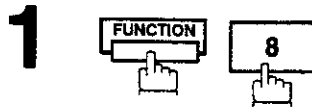

SELECT MODE (1-5)
ENTER NO. OR ^ V

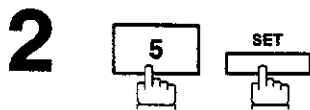

RCV TO MEMORY=ON
1:OFF 2:ON 3:PRINT



RCV TO MEMORY=PRINT
1:OFF 2:ON 3:PRINT

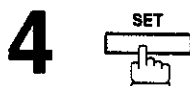

INPUT PASSWORD 

5 Enter the password to print the documents.
(see Note 1)

Ex:

INPUT PASSWORD
1234

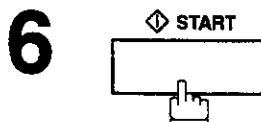

Machine will start to print the documents.

* PRINTING *
MEMORY RCV'D DOC

- !** **Note:** 1. If the password has not been set, your machine will not prompt you to enter the password. The documents will be printed immediately after pressing in step 4.
2. Once you set RCV TO MEMORY feature to On, the password cannot be changed (Fax Parameter No. 37 will not be shown on the LCD display). If you wish to change the password, set RCV TO MEMORY feature to Off first. Then change the password (see page 83).

Selective Reception

Your machine has a special feature, Selective Reception, which can prevent the receiving of unnecessary documents (i.e. junk fax, direct mail, etc.).

Before receiving the document, the last 4 digits of the ID Number received from the sending machine will be compared with the last 4 digits of the telephone number programmed in each One-Touch or Abbreviated station. When a match is found, your machine will start receiving the document. If a match is not found, your machine will cancel the reception and an Information Code 406 will be recorded on the Journal.

Setting Selective Reception

1



SET MODE (1-6)
ENTER NO. OR ^ V

2

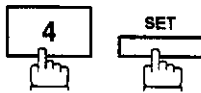

FAX PARAMETER (01-53)
NO. =

3



46 SELECT RCV
1: INVALID

4



46 SELECT RCV
2: VALID

5



6



- Note:**
1. When the Selective Reception is set, your machine can receive from only the 140 stations which are programmed in the built-in auto-dialer.
 2. If your ID number has not been set, your machine might not be able to receive from some models. To set your ID number, see page 27.

Password Communications

General Description

Password Communications, including Password Transmission and Password Reception will prevent your machine from sending a fax to a wrong station or receiving a fax from unauthorized stations. You can set Password Transmission and Password Reception independently, or both together.

To use Password Transmission, you must set a 4-digit transmission password in advance. The password must be shared with other compatible Panafax machine(s). If the transmission password in your machine does not match the transmission password in the other compatible Panafax machine(s), the transmission will fail. You can select password transmission by setting Function 8-4, PASSWORD-XMT to **ON** when you send a document.

To use Password Reception, you must set a 4-digit receiving password in advance. The password must be shared with the other compatible Panafax machine(s). If the password in your machine does not match the receiving password in the other compatible Panafax machine(s), the reception will fail. Once you set password reception and set the parameter to **ON**, it stays until you change the setting to **OFF**.

Compatibility with Other Machines

You can only use password transmission and reception with another Panafax compatible machine(s) listed below.

Model	Special Settings
UF-160	
UF-160M	
UF-170	
UF-260	
UF-270	
UF-270M	
UF-280M	
UF-300	Required.
UF-312	Please refer to the individual User's Guide of each model.
UF-322	
UF-650	
UF-733	
UF-750	
UF-750D	
UF-755	
UF-766	

Password Communications

Setting Password Transmission

To set transmission password and parameter,

1



SET MODE (1-6)
ENTER NO. OR ^ V

2

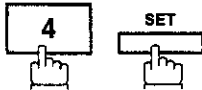

FAX PARAMETER (01-53)
NO. =

3



44 PASSWORD-XMT

4

Enter a 4-digit Transmission Password.

Ex: and press

44 PASSWORD-XMT
1:OFF 1234

5

for OFF (password is not checked)
or

for ON (password is checked)

44 PASSWORD-XMT
1:OFF 1234

or

44 PASSWORD-XMT
2:ON 1234

6



6

- Note:**
- You can change the setting temporarily by using FUNCTION 8-4 (PASSWORD-XMT) for each transmission. See page 89 for details.
 - To change the password, press in step 4. Then re-enter the new one.

Password Communications

Setting Password Reception

To set receiving password and parameter,

1   SET MODE (1-6)
ENTER NO. OR ^ V

2   FAX PARAMETER(01-53)
NO. = █

3    45 PASSWORD-RCV
████

4 Enter a 4-digit Receiving Password.

Ex: 1 2 3 4 and press SET



45 PASSWORD-RCV
1:OFF 1234

5  for OFF (password is not checked)
or

45 PASSWORD-RCV
1:OFF 1234

 for ON (password is checked)

45 PASSWORD-RCV
2:ON 1234

6  

- !** **Note:** 1. Once you set the parameter, you cannot select the parameter, **OFF** or **ON**, for each reception. It is always **OFF** or **ON** until you change the setting.
2. To change the password, press CLEAR in step 4. Then re-enter the new one.

Password Communications

Using Password Transmission

To use Password Transmission, you can select PASSWORD-XMT OFF or ON for each Transmission by following the procedure below.

1



Set document(s) face down.

DOCUMENT SET
ENTER STATION(S) 00%

2



SELECT MODE (1-5)
ENTER NO. OR ^ V

3

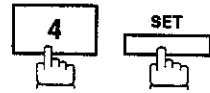

PASSWD-XMT=OFF
1:OFF 2:ON

4

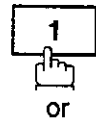

for OFF (password is not checked)

or



for ON (password is checked)

PASSWD-XMT=OFF
1:OFF 2:ON

or

PASSWD-XMT=ON
1:OFF 2:ON

5



DOCUMENT SET
ENTER STATION(S) 00%

6

Dial by any combination of the following methods.

- Manual Number Dialling (Up to 12 stations)
 - One-Touch Dialling
 - Abbreviated Dialling
 - Directory Search Dialling
- (For details, see page 45 to 48.)

Ex:

ONE-TOUCH
<01>(Station name)

(When entering a station for Manual Number Dialling or Directory Search Dialling, press after each station is entered.)

If your machine's Transmission Password coincides with the other station's Transmission Password, your machine starts sending the document.

When transmission is completed, PASSWORD-XMT returns to standard setting (OFF or ON).

Using Password Receiving

There is no additional operation required once you set the parameter following the procedure on the previous page. The parameter, OFF or ON, cannot be selected for each reception. It is always OFF or ON until you change the setting.

6

Confidential Mailbox and Confidential Network Communications

Your machine is equipped with two Confidential Communication features which ensure that the Confidential information you send is received by only the person with the correct confidential code.

Confidential Mailbox

The confidential mailbox feature can be used as a mailbox to communicate with other compatible models using a 4-digit confidential code. The Confidential Mailbox feature receives document(s) with a confidential code into memory. These documents can only be printed by the person who has the correct confidential code.

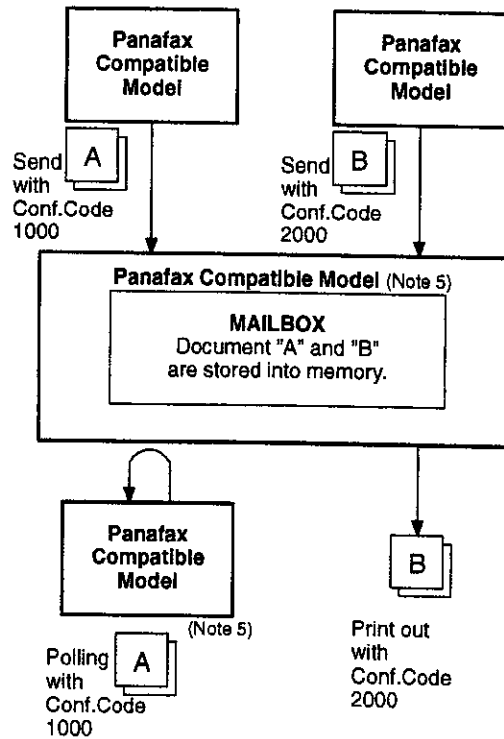

Figure 1: Confidential Mailbox

Compatibility with Other Machines

Table 1 shows a list of compatible Panafax model which has the Confidential Mailbox feature. It also shows whether or not special settings are required.

Table 1: Confidential Mailbox Requirement

Compatible Model	Special Settings
UF-280M UF-733 UF-312 UF-755 UF-322 UF-766	Not Required.



- Note:**
1. If your machine receives two confidential faxes with same confidential code, both documents are stored together in the same confidential mailbox.
 2. Up to 10 Mailbox files can be stored in memory. So, you can receive the confidential fax using 10 different confidential codes.
 3. If the memory overflows, the machine will stop receiving and release the line.
 4. We recommend that optional memory be installed when this function is used. See page 136 on Image Memory Capacity.
 5. If a confidential faxes was received in the mailbox of UF-733, you cannot poll those document. The UF-733 is designed to print out the received confidential document locally only.

Confidential Mailbox and Confidential Network Communications

Sending a Confidential Document to a Remote Station's Mailbox

1



Set document(s) face down.

DOCUMENT SET
ENTER STATION(S) 00%

2

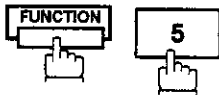

CONF. COMM. (1-5)
ENTER NO. OR ^ V

3

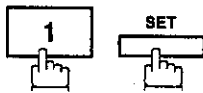

CONFIDENTIAL XMT
CONF. CODE=■■■■

4

Enter a 4-digit Confidential Code.

Ex:

CONFIDENTIAL XMT
CONF. CODE=2233

5



CONFIDENTIAL XMT
ENTER STATION

6

Dial the telephone number by pressing either:

- Manual Number Dialling
- One-Touch Dialling
- Abbreviated Dialling
- Directory search Dialling

Ex:

ONE-TOUCH
<01>(Station name)

7



If necessary, inform the receiving person and tell them the Confidential Code.

6



Note: If the receiving station has a Network Password, you must set the same password, shared by the receiving station, to send confidential fax. (see page 99 and 100)

Confidential Mailbox and Confidential Network Communications

Polling a Confidential Document from a Remote Station's Mailbox

After you have been informed that someone has transmitted a confidential document to a remote station's mailbox, you can poll the confidential document from the remote station in the following way.

1  

2  

3 Enter a 4-digit Confidential Code.
Ex: 

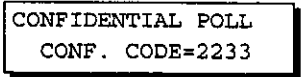

4  

5 Dial the telephone number by pressing either:

- Manual Number Dialling
- One-Touch Dialling
- Abbreviated Dialling
- Directory search Dialling

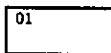
Ex: 

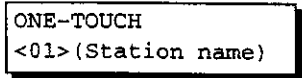

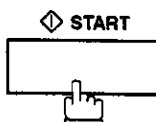
6 

 **Note:** The confidential file will be erased automatically at the center station after being polled.

Confidential Mailbox and Confidential Network Communications

Receiving a Confidential Document to Your Machine's Mailbox

No special setting is required, your machine comes with this feature ready to use. Your machine receives a confidential fax the same way it receives a normal fax message. When receiving the confidential fax, the display shows following message and printing out CONF. RCV REPORT.

MESSAGE IN MAILBOX

Sample CONF. RCV Report

```
***** -CONF.RCV REPORT- ***** DATE 08-DEC-1993 ***** TIME 12:00 *****P.01
** NOTICE OF CONFIDENTIAL DOCUMENT HELD **
(1)      (2)      (3)      (4)
FILE NO. RECEIVED FROM    PAGES    TIME RECEIVED
040      PANA FAX      001      08-DEC 12:00
                        -PANASONIC
***** -HEAD OFFICE -***** 201 555 1212- *****
```

Explanation of Contents

- | | |
|----------------------------------|-----------------------------|
| (1) File number | :001 to 255 |
| (2) Received remote station's ID | :Character ID or Numeric ID |
| (3) Number of pages received | |
| (4) Received time | |



- Note:**
1. If your machine receives two confidential faxes with same confidential code, both documents are stored together in the same confidential mailbox.
 2. Your machine has 10 confidential mailboxes. So, you can receive the confidential fax using 10 different confidential codes.
 3. If the memory overflows, the machine will stop receiving and release the line.
 4. You can verify whether the unit has received a confidential fax by printing out the File List (see page 76).

6

Confidential Mailbox and Confidential Network Communications

Storing Confidential Document in Your Machine's Mailbox

Use the following procedure to store a document in a confidential mailbox in your machine. Once the confidential document is stored in your machine, it can be polled by the other machine.

1



Set document(s) face down.

```
DOCUMENT SET
ENTER STATION(S) 00%
```

2



```
CONF. COMM. (1-5)
ENTER NO. OR ^ V
```

3



```
CONFIDENTIAL POLLED
CONF. CODE=■■■■
```

4

Enter a 4-digit Confidential Code.

Ex:

```
CONFIDENTIAL POLLED
CONF. CODE=2233
```

5



The document will be stored into memory.
If necessary, inform the receiving party of the confidential document and tell them the confidential code needed to poll the document.

```
* STORE * NO.002
PAGE=01 01%
```



Note: The confidential file will be erased automatically after being polled.
If you wish to retain the confidential file even after being polled, change the setting of Fax Parameter No. 43 (CONF. POLLED FILE SAVE) to "Valid".

Confidential Mailbox and Confidential Network Communications

Printing Out Confidential Document from Your Machine's Mailbox

After you have been notified that someone has transmitted a confidential document to your machine's mailbox, use the following procedure to print out the confidential document.

1



CONF. COMM. (1-5)
ENTER NO. OR ^ V

2



PRINT CONF. FILE
CONF. CODE=■■■■

6

3

Enter Confidential Code of the document you want to print out.

Ex: 2 2 3 3

PRINT CONF. FILE
CONF. CODE=2233

4



The machine will print out the confidential documents.

* PRINTING *
MEMORY RCV'D DOC



Note: The confidential file will be erased automatically after being printing out even when the setting of Fax Parameter No. 43 (CONF. POLLED FILE SAVE) was changed to "Valid".



Confidential Mailbox and Confidential Network Communications



Deleting a Confidential Document Stored in Your Machine's Mailbox

If your memory becomes full, or you just want to clean out your confidential document, you may delete one or more confidential fax stored in your machine using the following procedure.

There are two type of confidential file deletion, one is to delete file by Confidential Code, and others is to delete all confidential files in memory.

To delete file using Confidential Code



1   CONF. COMM. (1-5)
ENTER NO. OR ^ V

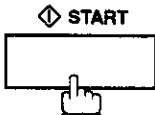

2   DELETE CONF. FILE
CONF. CODE=■■■■

3 Enter a 4-digit Confidential Code.
Ex: 2 2 3 3 DELETE CONF. FILE
CONF. CODE=2233

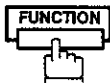
4  * DELETING *
CONF. CODE=2233

To delete all confidential file in memory

1   CONF. COMM. (1-5)
ENTER NO. OR ^ V

2   DELETE CONF. FILE
CONF. CODE=■■■■

3  DELETE ALL CONF.
FILES? 1: YES 2: NO

4  * DELETING *
ALL CONF. FILES

Confidential Mailbox and Confidential Network Communications

Confidential Network Communications (Via a Center Station)

The Confidential Network Communication requires a Center Station such as a UF-650 to communicate with other Panafax models which have confidential communication features. First the Initial Sending Station sends a confidential document to the Center Station together with a Confidential Code. The document will remain in the center station's memory until polled by End Receiving Station. In the example given in figure 2, the End Receiving Station must know the Confidential code attached to the document.

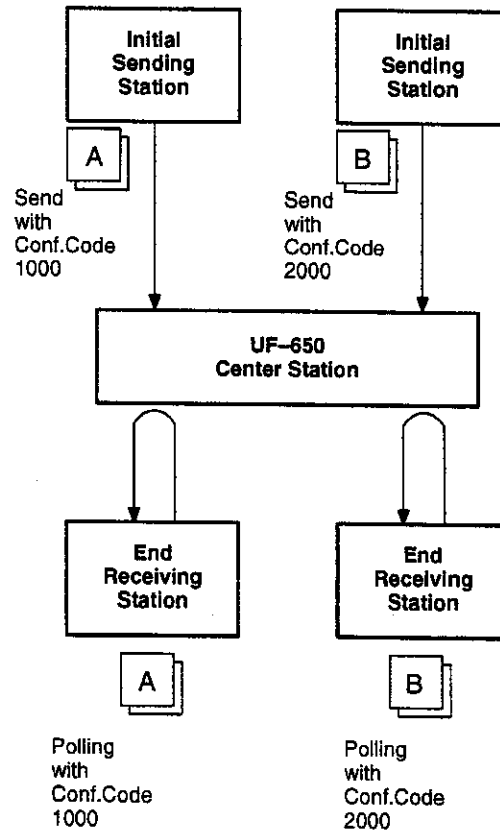

Figure 2: Sending Confidential Faxes via Center Station

If a UF-650 or UF-620 is the Center Station, more than one document can be stored in the same memory file using the same Confidential Code. That is, you can keep adding faxes to the file, just like putting mail in a mailbox, until the memory is full. If a UF-640 is the Center Station, you cannot add a fax to the file which has the same Confidential Code attached with a file already stored in the memory. Whichever station you use, you can create more than one file, each with a different Confidential Code.

The stored confidential document will be available to be polled by the end receiving station.

Once you have polled or printed the confidential document from the Center Station, the document is automatically erased from the Center Station's memory.

6

Confidential Mailbox and Confidential Network Communications

Compatibility with Other Machines

Table 1 shows how your machine fits in with the compatibility requirements of the different kinds of facsimile stations which make up a Network for Confidential Communications. It also shows whether or not special settings are required.

Table 1: Confidential Communication Requirement

Station	Compatible Model	Special Settings
Initial Sending Station	Panafax 145 Panafax 155 UF-140 UF-150 UF-160, UF-160M UF-170, PD-170E UF-250, UF-260 UF-270, UF-270M, UF-280M UF-300, UF-312, UF-322 UF-620, UF-640, UF-650 UF-733, UF-750, UF-750D UF-755, UF-766	Required. Please refer to the individual User's Guides of each machine.
Confidential Center Station	UF-620, UF-640, UF-650	
End Receiving Station	Panafax 145 Panafax 155 UF-140 UF-150 UF-160, UF-160M UF-170, PD-170E UF-250, UF-260 UF-270, UF-270M, UF-280M UF-300, UF-312, UF-322 UF-620, UF-640, UF-650 UF-733, UF-750, UF-750D UF-755, UF-766	

Setting Up Your Machine for Confidential Network Communications

To use Confidential Communications, you must first preset the Confidential Communication Fax Parameter described below. Then, every time you actually send a Confidential Fax you must set a Confidential Code.

1. Confidential Communication Fax Parameter

This switches the Confidential Communications function to Invalid/Valid.

2. Own Telephone Number

The full telephone number should be entered.

3. Network Password and Polling Password

You may use Network Password and Polling Password to prevent outside facsimile(s) from using the Confidential Communication network. The same password must be provided to all the machines inside the network.

4. Confidential Code

A 4-digit code must be assigned to each Confidential Fax you send. It identifies the fax when it is stored in the Relay Station. The receiving person must know the code in order to poll the fax from the Relay Station.

Confidential Mailbox and Confidential Network Communications

To set the Fax Parameter for Confidential Network Communication

1



SET MODE (1-6)
ENTER NO. OR ^ V

2

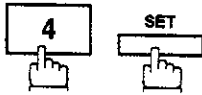

FAX PARAMETER(01-53)
NO. =

3

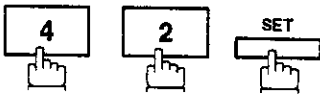

42 CONF. FAX PARA.
1:INVALID

4



42 CONF. FAX PARA.
2:VALID

5

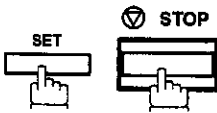

6

Confidential Mailbox and Confidential Network Communications

To set your own Telephone Number and Network Password

1



SET MODE (1-6)
ENTER NO. OR ^ V

2

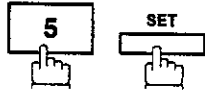

OWN TELEPHONE NO.

3

Enter your telephone number (max. 36 digits).

Ex: 1 SPACE 2 1 2 SPACE
1 1 1 SPACE 1 2 3 4

OWN TELEPHONE NO.
1 212 111 1234

4



NETWORK PASSWORD

5

Enter a 4-digit Network Password.

Ex: 9 9 9 9

NETWORK PASSWORD
9999

6



Relayed Transmission

General Description

Relayed Transmission is a feature which can save you time and transmission costs if you need to send the same document to several facsimile stations at the same time. This is especially true if the transmissions are long distance.

To use Relayed Transmission, you must be part of a "Relay Network" built around a "Relay Station". That is, when you send a document by Relayed Transmission, you actually send it to a Relay Station together with instructions to relay it to one or more end receiving station(s).

The Relay Station first receives the document in its memory and then relays it to the end receiving station(s).

Example:

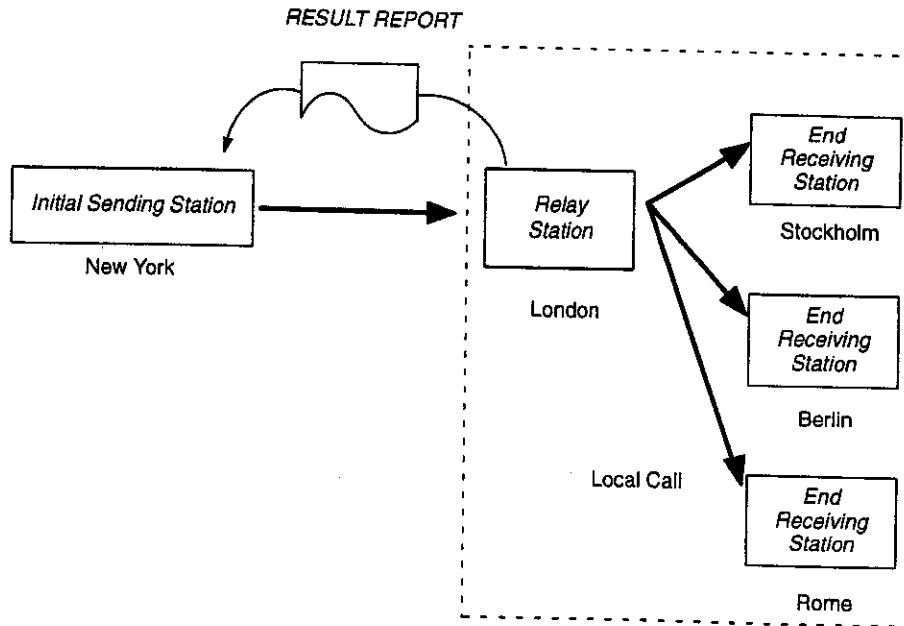

6

! **Note:** The number of end receiving stations that can be reached by a Relayed Transmission is limited by the memory capacity of the initial sending machine; i.e., your machine cannot make a Relayed Transmission to more than 140 end receiving stations. This is enough, however, to allow more than one Relay Network to be set up.

Compatibility with Other Machines

Table 1 shows the kind of facsimile machines which can make up a Relay Network used for Relayed Transmission. Note that your machine can serve as an Initial Sending Station or End Receiving Station.

Table 1: Relay Network Compatibility Requirements

Station	Compatible Model	Special Settings
Initial Sending Station	UF-150 UF-300 UF-766 UF-160 UF-312 UF-160M UF-322 UF-170 UF-620 UF-750 UF-640 UF-250 UF-650 UF-260 UF-733 UF-270 UF-750 UF-270M UF-750D UF-280M UF-755	Required. Please refer to the individual User's Guides of each machine.
Relay Station	UF-620 UF-650 UF-640	
End Receiving Station	CCITT G3/G2 Compatible machines	Not required.

Relayed Transmission

Relay Network

A Relay Network is basically a group of facsimiles programmed to communicate with each other via a Relay Station. In this case, the word programmed means that certain numbers have been stored in the memory of each machine. These numbers, also called parameters, are needed to identify the machines in the network.

Since your machine can only serve as an Initial Sending Station or End Receiving Station in a Relay Network, it is assumed that you will not have to establish the network yourself. All you have to do is follow the set up procedure described here, and certain instructions provided by the network organizer (usually the person controlling the Relay Station). You should know, however, what kind of network you are going to connect to, and how it works. A sample network is shown in figure 1.

Figure 1 shows a sample network as seen from New York. London and Singapore are Relay Stations connected to New York. Viewed from New York, Stockholm, Berlin, Rome, Tokyo, Hong Kong, Wellington and Sydney are End Receiving Stations.

With this simple network using two Relay Stations, you can send a document with one operation to any combination of stations in the network via the London Relay Station and/or Singapore Relay Station. If New York only transmits to one station, for example, then the document will go directly to the station or indirectly via the Relay Station depending on the One Station XMT Parameter you preset.

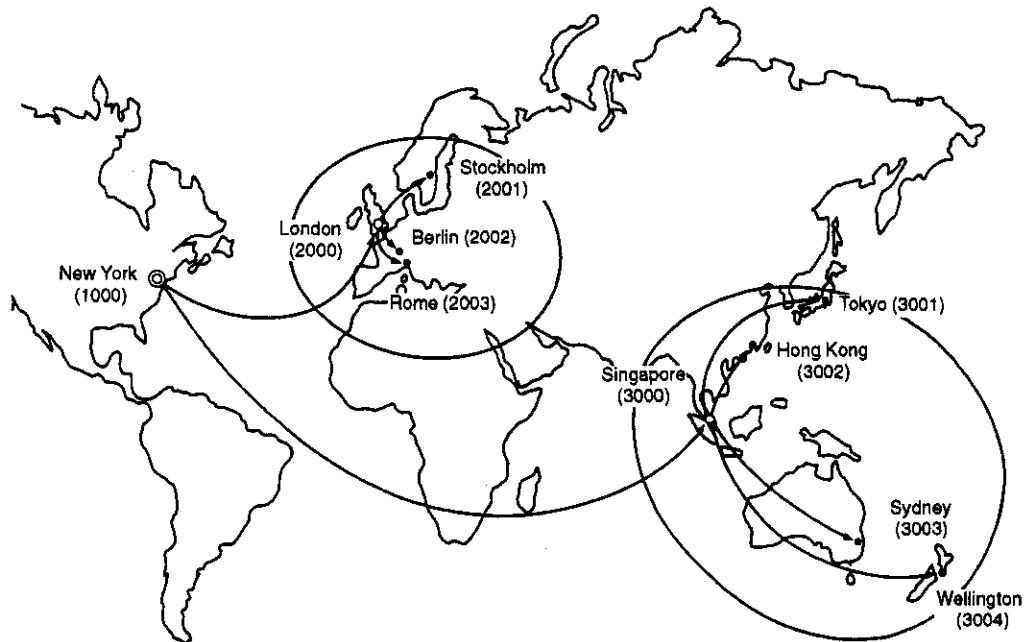

Figure 1: Sample Network

Relayed Transmission

Table 2, 3 and 4 are sample settings for a Sample Network.

Table 2: Sample Parameter and Abbreviated Dialling Number Table for New York

Telephone Number : 212 111 1234
 Network Address : 1000
 Relay Address : 10

One-Touch/ ABBR No.	Station Name	Telephone Number	Relay Address	Relay Station Yes/No	Network Address	One Station XMT
01	London	44 71 111 1234	20	Yes	2000	Direct
02	Stockholm	46 8 111 1234	20	No	2001	Direct
03	Berlin	49 611 111 1234	20	No	2002	Direct
04	Rome	39 6 111 1234	20	No	2003	Direct
05	Singapore	65 111 1234	30	Yes	3000	Direct
06	Tokyo	81 33 111 1234	30	No	3001	Direct
07	Hong Kong	852 4 111 1234	30	No	3002	Direct
08	Sydney	61 2 111 1234	30	No	3003	Direct
09	Wellington	64 4 111 1234	30	No	3004	Direct

Table 3: Sample Parameter and Abbreviated Dialling Number Table for London

Telephone Number : 71 111 1234
 Network Address : 2000
 Relay Address : 20

One-Touch/ ABBR No.	Station Name	Telephone Number	Relay Address	Relay Station Yes/No	Network Address	One Station XMT
01	Stockholm	46 8 111 1234	20	No	2001	Direct
02	Berlin	49 611 111 1234	20	No	2002	Direct
03	Rome	39 6 111 1234	20	No	2003	Direct
04	New York	1 212 111 1234	10	No	1000	Direct
05	Singapore	65 111 1234	30	Yes	3000	Direct
06	Tokyo	81 33 111 1234	30	No	3001	Direct
07	Hong Kong	852 4 111 1234	30	No	3002	Direct
08	Sydney	61 2 111 1234	30	No	3003	Direct
09	Wellington	64 4 111 1234	30	No	3004	Direct

Table 4: Sample Parameter and Abbreviated Dialling Number Table for Singapore

Telephone Number : 65 111 1234
 Network Address : 3000
 Relay Address : 30

One-Touch/ ABBR No.	Station Name	Telephone Number	Relay Address	Relay Station Yes/No	Network Address	One Station XMT
01	New York	1 212 111 1234	10	No	1000	Direct
02	London	44 71 111 1234	20	Yes	2000	Direct
03	Stockholm	46 8 111 1234	20	No	2001	Direct
04	Berlin	49 611 111 1234	20	No	2002	Direct
05	Rome	39 6 111 1234	20	No	2003	Direct
06	Tokyo	81 33 111 1234	30	No	3001	Direct
07	Hong Kong	852 4 111 1234	30	No	3002	Direct
08	Sydney	61 2 111 1234	30	No	3003	Direct
09	Wellington	64 4 111 1234	30	No	3004	Direct

Relayed Transmission

Setting Up Your Machine for Relayed Transmission

To set up your machine for Relayed Transmission, use the procedures on the following pages to set the parameters listed below. Some parameters (e.g., Relayed XMT FAX Parameter) are only set once, but others must be set separately for each station in the Relay Network.

1. Relayed XMT Request FAX Parameter

This switches the Relayed XMT Request function to Valid or Invalid.

2. Own Telephone Number

The full telephone number to which the machine is connected should be entered for Relay Station send back Result Report.

3. Own Network Address

A 4-digit Own Network Address should be entered for Relay Station send back Result Report.

4. Network Password

A 4-digit number which prevents unauthorized (outside) stations from accessing the Relay Station and using its memory. Every Relay requesting and Relay stations in the network should set the same Network Password.

5. One-Touch/ABBR Numbers

The One-Touch or ABBR number you set must represent the fax number of a particular station in the network as seen from your station.

1) Network Address

End Receiving Station telephone numbers set in an Initial Sending Station may be different from the numbers set in a Relay Station. To send a fax to an End Receiving Station via a Relay Station each station in the network must be identified with a certain code which does not vary depending on where you call from. The code is the Network Address, which consists of a 4-digit number and is assigned to a One-Touch/ABBR number.

2) Relay Address

A 2-digit number which identifies the Relay Station your machine will use. Your machine may be connected to more than one Relay Station in parallel, but when you use Relayed XMT Request your machine will only send documents to the Relay Station identified by the Relay Address.

3) Relay Station Parameter (Yes/No)

Set "Yes" if the particular station you are recording is a Relay Station. If you are connected to more than one Relay Station in series, set "Yes" only for the first Relay Station.

4) One Station XMT (Relay/Direct) Parameter

If you send a document to only one End Receiving Station, you can set your machine to transmit directly to that station, without going through the Relay Station, by selecting "No". Set "Yes" if you always want to go through the Relay Station.

Relayed Transmission

To set the Relayed XMT FAX Parameters;

1

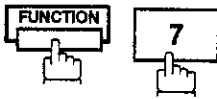

SET MODE (1-6)
ENTER NO. OR ^ V

2

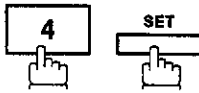

FAX PARAMETER (01-53)
NO. =

3

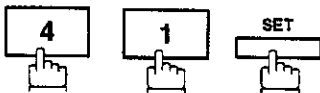

41 RELAY XMT REQUEST
1: INVALID

4



41 RELAY XMT REQUEST
2: VALID

5

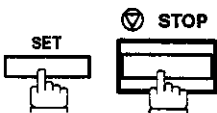

6

To set your own Telephone Number, own Network Address and Network Password;

1



SET MODE (1-6)
ENTER NO. OR ^ V

2

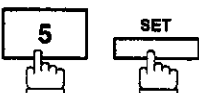

OWN TELEPHONE NO.
|

3

Enter your telephone number (max. 36 digits).

Ex: **1** SPACE **2** **1** **2** SPACE
1 **1** **1** SPACE **1** **2** **3** **4**
and press **SET**

OWN NETWORK ADDRESS
||||

Continued on the next page.

Relayed Transmission

4 Enter your 4-digit Network Address.

Ex: and press

NETWORK PASSWORD
■■■■

5 Enter your 4-digit Network Password.

Ex: and press

OWN TELEPHONE NO.
1 212 111 1234

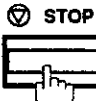
6  STOP

To set a One-Touch/ABBR. Dialling Number, Network Address, Relay Station Parameter (Yes/No) and One Station XMT (Relay/Direct) Parameter;

1

SET MODE (1-6)
ENTER NO. OR ^ V

2

1:ONE-TOUCH
2:ABBR. NO.

3

ONE-TOUCH< >
PRESS ONE TOUCH KEY

4 Ex:

ONE-TOUCH<01> TEL.
|

Continued on the next page.

Relayed Transmission

5 Enter the telephone number.

Ex: and press

```
ONE-TOUCH<01>  NAME
|
```

6 Enter the station name.

Ex: and press

```
ONE-TOUCH<01>
NETWORK ADDRESS=||||
```

7 Enter a 4-digit Network Address.

Ex: and press

```
ONE-TOUCH<01>
RELAY ADDRESS=||
```

8 Enter a 2-digit Relay Address.

Ex: and press

```
ONE-TOUCH<01>  NO.=2
RELAY STN?     1:Y 2:N
```

9 If the recorded station is the Relay Station, press .
If not, press .

Ex:

10 In case the station you have just recorded will be used for one-station transmission, you can preset the transmission route.

- 1: For transmission via the Relay Station
- 2: For direct transmission

Ex:

Repeat step 4 through 10 to enter the numbers for other stations, or return to standby by pressing .

Print out a list of One-Touch/ABBR number or Directory Search List to confirm that you have recorded everything correctly. For the printout operation, refer to page 116.

```
ONE-TOUCH<01>  NO.=1
1-STN RELAY?  1:Y 2:N
```

```
ONE-TOUCH< >
PRESS ONE TOUCH KEY
```

6

Relayed Transmission

Sending a Document by Relayed Transmission

Once you have recorded all the necessary parameters in your machine in accordance with the Relay Network you belong to, you can send a document to two or more stations in the network system, automatically, using the procedure below.

1



Set document(s) face down.

```
DOCUMENT SET
ENTER STATION(S) 00%
```

2



```
RELAYED XMT
ENTER STATION(S)
```

3

Dial by any combination of these.

- One-Touch Dialling
- Abbreviated Dialling
- Directory Search Dialling

Ex: and

(When entering a station for Directory Search Dialling, press after each station is entered.)

```
ONE-TOUCH
<01>(Station name)
```

```
ABBR          STNS=002
[27](Station name)
```

4

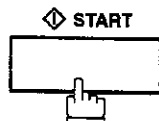

The document is stored into memory and your machine starts to dial the number of the Relay Station and sends the document.

```
* STORE *      NO.001
                PAGES=01  01%
```

After the Relay Station finishes its transmission to the End Receiving Stations, your machine prints out a RELAY XMT RESULT REPORT sent back by the Relay Station.



Note: You cannot use manual number dialling in step 3.

Relayed Transmission

Printouts and Reports

When you use Relayed Transmission, your machine will print the following two reports to help you check and keep track of your faxes.

1. Relay XMT Report (COMM. JOURNAL)

When your machine finishes transmitting to the Relay Station, it will print a COMM. Journal when the Fax Parameter No. 12 is set to "2", this tells you whether the transmission was successful or not.

2. Result Report

When the Relay Station finishes transmitting your fax document to the End Receiving Station(s) in your network, it will print a RELAY XMT RESULT REPORT, it tells you what it did and whether it was successful or not.

6



Note: *If you transmit via more than one Relay Station, you will receive a separate Result Report.*

Relayed Transmission

Sample Result Report (Relay XMT Result)

```

(1)
12-AUG-1993 12:10 FROM LONDON TO NEW YORK P.001/001

***** -RESULT REPORT- ***** DATE 12-AUG-1993 ***** TIME 12:10 ***** P.1
(2)
MODE = RELAYED TRANSMISSION
(3) (6) (7)
REQUEST REC'V TIME=12-AUG 11:40 START=12-AUG 12:00 END=12-AUG 12:10
NUMBER OF PAGE(S) = 01 (4)
FILE NO. = 045 (5)

**** REQUESTING STATION ** (8)
- NEW YORK -
TELEPHONE NUMBER = 212 111 1234
NETWORK ADDRESS = 1000

(9) (10) (11) (12) (13)
NO. COM DESTINATION(S) PAGE(S) RLY STN

01 OK 2000 LONDON 001/001
02 OK 2001 STOCKHOLM 001/001
03 OK 2002 BERLIN 001/001
04 INC 2003 ROME 000/001

**RELAY STATION **(14)
- LONDON -
TELEPHONE NUMBER = 44 71 111 1234
RELAY ADDRESS= 20
NETWORK ADDRESS= 2000

- LONDON -
***** - 44 71 111 1234 - *****
TOTAL P.01

```

Explanation of Contents

- (1) Relay Station's Header Print
- (2) Indication of transmission mode
- (3) The time when the relay request was received
- (4) Number of pages received relay request
- (5) File number of the received relay request file
- (6) The time when the Relay Station starts sending Relay Faxes
- (7) The time when the Relay Station ends sending Relay Faxes
- (8) Initial Sending Station's information (LOGO, Telephone number and Network Address)
- (9) Communication number
- (10) Communication result : "OK" indicates that the transmission was successful.
"R-OK" indicates that the transmission to the Relay Station was successful.
"INC" indicates that the transmission was not completed.
- (11) Station name
- (12) Number of pages transmitted/number of pages received Relay Request
- (13) Another Relay Station's Relay Address/Network Address (If transferred to another Relay Station)
- (14) Relay Station's information (LOGO, Telephone number and Network Address)

Journals and Lists

To help you maintain records of the documents you sent and received, as well as lists of the numbers you record, your facsimile machine is equipped to print the following journals and lists: 32 Transaction Journal, Individual Transmission Journal, Communication Journal, One-Touch/ABBR. No. List, Program List, Fax Parameter List, Power Failure Report and File List.

32 Transaction Journal

The "Journal" is a record of the last 32 transaction (a transaction is recorded each time you send or receive a document). It is printed out automatically after every 32 transaction, but you can print it manually using the following procedure:

1	 	<div style="border: 1px solid black; padding: 2px; width: fit-content;">PRINT OUT (1-7) ENTER NO. OR ^ V</div>
2		<div style="border: 1px solid black; padding: 2px; width: fit-content;">1: JOURNAL? PRESS SET TO PRINT</div>
3		<div style="border: 1px solid black; padding: 2px; width: fit-content;">* PRINTING * JOURNAL</div>

7

! *Note: If you wish to disable the automatic print out of the 32 Transaction Journal, change the setting of Fax Parameter No. 13 to "Invalid". (See page 35)*

Individual Transmission Journal (IND. XMT JOURNAL)

An Individual Transmission Journal contains information on the latest transmission.

1	 	<div style="border: 1px solid black; padding: 2px; width: fit-content;">PRINT OUT (1-7) ENTER NO. OR ^ V</div>
2		<div style="border: 1px solid black; padding: 2px; width: fit-content;">6: IND. XMT JOURNAL? PRESS SET TO PRINT</div>
3		<div style="border: 1px solid black; padding: 2px; width: fit-content;">* PRINTING * IND. XMT JOURNAL</div>

Journals and Lists

Sample Individual Transmission Journal (IND. XMT JOURNAL)

```

***** -IND.XMT JOURNAL- ***** DATE 08-DEC-1993 ***** TIME 12:00 *****
(1)  DATE/TIME      = 08-DEC-1993 09:00
(2)  JOURNAL No.   = 21
(3)  COMM.RESULT    = OK
(4)  PAGE(S)       = 001
(5)  DURATION      = 00:00'16
(6)  FILE No.      =
(7)  MODE          = TRANSMISSION
(8)  DESTINATION   = [01] / 37 /ABCDEFG
(9)  RECEIVED ID   =
(10) RESOLUTION    = STD

                                (11)
                                -PANASONIC
***** -HEAD OFFICE   -***** - 201 555 1212- *****
                                (13)                                (12)

```

7

Explanation of Contents

- (1) Transmitted date and time
- (2) Journal number
- (3) Communication result : "OK" indicates that the transmission was successful.
"S-OK" indicates that **STOP** was pressed during transmission.
3-digit information code (see page 125) appears when there was a problem.
- (4) Number of pages transmitted or received : The 3-digit number is the number of pages successfully transmitted or received. When the documents are stored into memory, two three-digit numbers will appear. The first 3-digit number represents the number of pages successfully transmitted. The second 3-digit number represents the total number of pages that were attempted to be transmitted.
- (5) Duration of communication
- (6) File number : 001 to 255 (When the communication is stored into memory, a file number is assigned for each communication.)
- (7) Type of communication : Transmission or memory transmission
- (8) Destination : If a One-Touch or **ABBR** was used for the transmission:
One-Touch or ABBR. No./Telephone Number/Recorded.Name
If not : Telephone number
- (9) Received remote station's ID : Character ID/ID number
- (10) Resolution : "STD" means standard resolution
"FINE" means fine resolution
"S-FINE" means super fine resolution
- (11) Own LOGO : Up to 25 characters
- (12) Own ID number : Up to 20 digits
- (13) Own Character ID : Up to 16 characters

Journals and Lists

Communication Journal (COMM. JOURNAL)

The Communication Journal (COMM. JOURNAL) lets you verify if transmission or polling was successful or not. You may select the printout condition (Off/On/Inc. only) in Function 8-1, see page 35.

Sample COMM. JOURNAL

```
*****-COMM. JOURNAL- *****DATE 08-DEC-1993 ***** TIME 12:00 ***** P.01

(1)
MODE = MEMORY TRANSMISSION
FILE NO. = 079 (4)

(2)
START=08-DEC 11:50

(3)
END=08-DEC 12:00

(5) (6) (7) (8) (9) (10) (11) (12)
NO. COM ABBR/NTWK STATION NAME/ PAGES PRG.NO. PROGRAM NAME RLY STN
TELEPHONE NO.

001 OK [01] SERVICE DEPT. 001/001
002 OK [02] SALES DEPT. 001/001
003 OK [03] ACCOUNTING DEPT. 001/001
004 INC [X] 021 111 1234 000/001

(13)
-PANASONIC

*****-HEAD OFFICE -***** 201 555 1212- *****
(15) (14)

THE SLEREXE COMPANY LIMITED
SAPORS LANE . BOOLE . DORSET . BH 25 8 ER
TELEPHONE BOOLE (945 13) 51617 - TELEX 123456

Our Ref. 350/PJC/EAC 18th January, 1972.

Dr. P.N. Cundall,
Mining Survaye Ltd
```

... of print density,
cause the photocell to generate an analogous electrical video signal.
This signal is used to modulate a carrier, which is transmitted to a
remote destination over a radio or cable communications link.

At the remote terminal, demodulation reconstructs the video
signal, which is used to modulate the density of print produced by a
printing device. This device is scanning in a raster scan synchronised
with that at the transmitting terminal. As a result, a facsimile
copy of the subject document is produced.

Probably you have uses for this facility in your organisation.



Yours sincerely,

Phil.

P.J. CROSS
Group Leader - Facsimile Research

Journals and Lists

Explanation of Contents

- (1) Indication of communication mode
- (2) Starting time of communication
- (3) Ending time of communication
- (4) File number
- (5) Communication number : 001 to 255 (When the communication is stored into memory, a file number is assigned for each communication.)
- (6) Communication result : "OK" indicates that the transmission was successful.
"R-OK" indicates that the transmission to the Relay Station was successful.
"INC" indicates that the transmission was not completed.
In this case, the machine will print out this report attached with the first page of your document as shown on the sample printout.
- (7) Abbreviated number or  mark :  mark indicates dialed by direct number dial.
- (8) Recorded name in One-Touch, ABBR. or direct dialing number
- (9) Number of pages transmitted or received : The 3-digit number is the number of pages successfully transmitted or received.
When the documents are stored into memory, two 3-digit numbers will appear. The first 3-digit number represents the number of pages successfully transmitted. The second 3-digit number represents the total number of pages that were attempted to be transmitted.
- (10) Program key number
- (11) Recorded name in the Program key
- (12) Relay Station's ABBR. NO./Network Address
- (13) Own LOGO : Up to 25 characters
- (14) Own ID number : Up to 20 digits
- (15) Own Character ID : Up to 16 characters



Journals and Lists

One-Touch/Abbreviated and Directory Search List

To print a One-Touch/Abbreviated Number and Directory Search List of the telephone numbers you have stored.

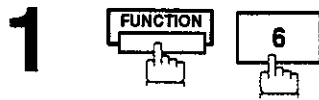

PRINT OUT (1-7)
ENTER NO. OR ^ V



2:ONE-TCH/ABBR LIST?
PRESS SET TO PRINT

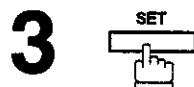

1:ONE-TOUCH/ABBR.NO.
2:DIR. SEARCH

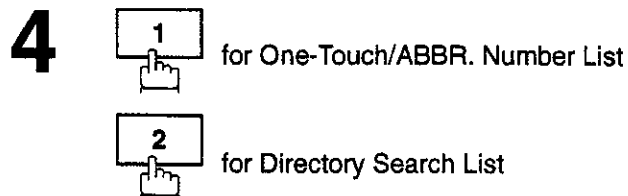

* PRINTING *
ONE-TOUCH/ABBR. LIST

* PRINTING *
DIR. SEARCH LIST

Journals and Lists

Sample One-Touch List

```
*****-ONE-TOUCH LIST- ***** DATE 08-DEC-1993 ***** TIME 12:00 ***** P.01
```

(1) ONE-TOUCH	(2) STATION NAME	(3) TELEPHONE NO.	(8) NETWORK ADRS	(9) RELAY STN.	(10) RELAY ADRS	(11) ONE STN XMT
<01>	SERVICE DEPT.	121 555 1234	2000	YES	20	DIRECT
<02>	SALES DEPT.	222 666 2345	2001	NO	20	DIRECT
<03>	ACCOUNTING DEPT	313 333 3456	2002	NO	20	DIRECT

(see Note)

NO. OF STATIONS = 03 (4)

```
OWN TELEPHONE NO.=12345678 (12)
OWN NETWORK ADDRESS=1000 (13)
NETWORK PASSWORD=9999 (14)
```

(see Note)

(5)
-PANASONIC -

```
*****-HEAD OFFICE -**** - 201 555 1212- *****
(7) (6)
```

Sample ABBR. Number List

```
*****-ABBR. NO. LIST- ***** DATE 08-DEC-1993 ***** TIME 12:00 ***** P.01
```

ABBR NO.	STATION NAME	TELEPHONE NO.	NETWORK ADRS	RELAY STN.	RELAY ADRS	ONE STN XMT
[01]	ENG. DEPT.	888 555 1234	3000	YES	30	DIRECT
[02]	PURCHASE DEPT.	999 666 2345	3001	NO	30	DIRECT
[03]	REGULATION DEPT	777 333 3456	3002	NO	30	DIRECT

(see Note)

NO. OF STATIONS = 03

```
OWN TELEPHONE NO.=12345678
OWN NETWORK ADDRESS=1000
NETWORK PASSWORD=9999
```

(see Note)

-PANASONIC -

```
*****-HEAD OFFICE -**** - 201 555 1212- *****
```



Note: These information will be printed if the setting of Fax Parameter No.41 (RELAYED XMT REQUEST) or No. 42 (CONF. PARAMETER) is set to "Valid".

Journals and Lists

Sample Directory Search List

```

***** -DIR. SEARCH LIST- ***** DATE 08-DEC-1993 ***** TIME 12:00 ***** P.01

```

(15)	(2)	(1)	(3)	(8)	(9)	(10)	(11)
	NAME	ABBR NO. / ONE-TOUCH	TELEPHONE NO.	NETWORK ADRS	RELAY STN.	RELAY ADDR	ONE STN XMT
[A]	ACCOUNTING DEPT	<03>	313 333 3456	2002		20	DIRECT
[E]	ENG. DEPT.	[01]	888 555 1234	3000	YES	30	DIRECT
[P]	PURCHASE DEPT	[02]	999 666 2345	3001		30	DIRECT
[R]	REGULATION DEPT	[03]	777 333 3456	3002		30	DIRECT
[S]	SERVICE DEPT.	<01>	121 555 1234	2000	YES	20	DIRECT
	SALES DEPT.	<02>	222 666 2345	2001		20	DIRECT

(see Note)

NO. OF STATIONS = 06 (4)

OWN TELEPHONE NO.=12345678 (12)
OWN NETWORK ADDRESS=1000 (13)
NETWORK PASSWORD=9999 (14)

(see Note)

(5)
-PANASONIC -

```

***** -HEAD OFFICE - *****
(7) 201 555 1212- (6)

```

! **Note:** These information will be printed if the setting of Fax Parameter No. 41 (RELAYED XMT REQUEST) or No. 42 (CONF. PARAMETER) is set to "Valid".

Explanation of Contents

- | | |
|----------------------------------------------------------------|------------------------------------------------------|
| (1) One-Touch number or Abbreviated number | : <nn> = One-Touch number, [nn] = Abbreviated number |
| (2) Station name recorded in the machine | : Up to 15 characters |
| (3) Telephone number recorded in the machine | : Up to 36 digits |
| (4) Number of recorded One-Touch and ABBR. numbers | |
| (5) Own LOGO | : Up to 25 characters |
| (6) Own ID number | : Up to 20 digits |
| (7) Own Character ID | : Up to 16 characters |
| (8) Network Address | : Four-digit |
| (9) Relay Station | : Yes/No |
| (10) Relay Address | : Two-digit |
| (11) One Station XMT | : Relay/Direct |
| (12) Own telephone number | : Up to 36 digits |
| (13) Own Network Address | : Four-digit |
| (14) Network Password | : Four-digit |
| (15) The first letter of station name recorded in your machine | |

Journals and Lists

Program List

To print a Program List of the Dialling Patterns that you have previously entered into the Program Keys.

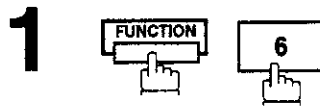

PRINT OUT (1-7)
ENTER NO. OR ^ V



3:PROGRAM LIST?
PRESS SET TO PRINT

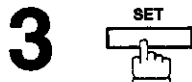

* PRINTING *
PROGRAM LIST



Sample Program List

```
*****-PROGRAM LIST- ***** DATE 08-DEC-1993 ***** TIME 12:00 ***** P.01
```

(1) PROGRAM	(2) PROGRAM NAME	(3) TYPE	(4) TIMER	(5) ABBR. NOS.
[P1]	TIMER XMT	XMT	12:00	[01]
[P2]	TIMER POLL	POLL	19:00	[02]
[P3]	PROG. A	POLL	----	[01], [02]
[P4]	PROG. B	ABBR/GRP	----	[01], [02], [03]
			(6) -PANASONIC	
*****-HEAD OFFICE		----	201 555 1212-	*****
(8)			(7)	

Explanation of Contents

- (1) Program key : P1 to P8
- (2) Program name : Up to 15 characters
- (3) Type of communication : "XMT" indicates transmission.
"POLL" indicates polling.
"ABBR/GRP" indicates that the Program key is programmed as a group key.
"ONE-TOUCH" indicates that the Program key is programmed as a One-Touch key.
- (4) Timer : Indicates the starting time.
"----" indicates that the Program key contains "non-deferred" program.
- (5) Numbers recorded in the program : One-Touch/ABBR. numbers
- (6) Own LOGO : Up to 25 characters
- (7) Own ID number : Up to 20 digits
- (8) Own Character ID : Up to 16 characters

Journals and Lists

FAX Parameter List

To print out a FAX Parameter List:

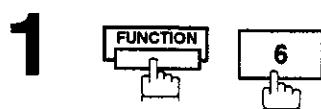

PRINT OUT (1-7)
ENTER NO. OR ^ V



4:FAX PARA LIST?
PRESS SET TO PRINT

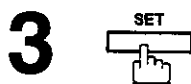

* PRINTING *
FAX PARAMETER LIST

Sample FAX Parameter List

```
***** -FAX PARAMETER LIST- ***** DATE 08-DEC-1993 ***** TIME 20:00 *****
```

(1) PARAMETER NUMBER	(2) DESCRIPTION	(3) SELECTION	(4) CURRENT SETTING	(5) STANDARD SETTING
01	ORIGINAL (HOME)	(1:Normal 2:Light 3:Dark)	1	1
02	RESOLUTION (HOME)	(1:Standard 2:Fine 3:S-Fine)	2	1
04	STAMP (HOME)	(1:Off 2:On)	1	1
(((((
46	SELECT RCV	(1:Invalid 2:Valid)	1	1
51	REMOTE DIAGNOSTIC	(1:Invalid 2:Valid)	1	1
53	OPTION MEMORY		(512K+None) (6)	
		(7) -PANASONIC		
***** -HEAD OFFICE		***** -	201 555 1212-	*****
(9)			(8)	

Explanation of Contents

- | | |
|-----------------------------------------------------------------------------------------------------------------------------------------------------------------------------------------------------|--------------------------------------------------------|
| (1) Parameter number | (5) Standard setting : Factory preset standard setting |
| (2) Description : "(HOME)" means home position setting. | (6) Memory sizes : (Base memory + option memory) |
| (3) Selection | (7) Own LOGO : Up to 25 characters |
| (4) Current setting : "----" indicates code or password is not set. When the code or password is set, it is shown in parenthesis. When RCV To Memory Password is set, ■■■■ is shown in parenthesis. | (8) Own ID number : Up to 20 digits |
| | (9) Own Character ID : Up to 16 characters |

Power Failure Report

This unit has a built-in rechargeable battery installed to retain the document information for up to 1 hour when a power failure occurs.

However, if the battery system has problems, the document information might be lost. In this case, a Power Failure Report will be printed automatically for each file separately, after the Power is turned ON again. This report is not printed if there were no files in the memory.

Sample Power Failure Report

```

*****-PWR FAILURE REP- ***** DATE 08-DEC-1993 ***** TIME 12:00 ***** P.01
POWER FAILURE OCCURRED

MODE = MEMORY TRANSMISSION (1)
FROM    *** 08-DEC-1993 10:00'24 *** (2)
TO      *** 08-DEC-1993 12:00'26 *** (3)

FOLLOWING FILE HAS BEEN LOST.

(4)      (5)      (6)      (7)      (8)      (9)      (10)
FILE NO.  ABBR./NTWK  STATION NAME/  PAGES  PRG.NO.  PROGRAM NAME  RLY STN
          TELEPHONE NO.

001      [04]    ENGINEERING DEPT.  000/005

                               (11)
                               -PANASONIC

*****-HEAD OFFICE  -**** -      201 555 1212- *****
          (13)                (12)
    
```

7
=

Explanation of Contents

- (1) Communication mode
- (2) Power failure date and time
- (3) Power return date and time
- (4) File number : 001 to 255.
- (5) One-Touch number, ABBR. number and network address if entered : <nn> = One-Touch number, [nn] = Abbreviated number
- (6) Station name in the One-Touch/ABBR. key or telephone number
- (7) Number of pages stored : The first three-digit number represents the number of pages successfully transmitted. The second three-digit number represents the number of pages stored into memory.
- (8) Program key : P1 to P8
- (9) Program name
- (10) Relay station : If this file is stored for relayed transmission, the ABBR. number and network address of relay station is printed in the column.
- (11) Own LOGO : Up to 25 characters
- (12) Own ID number : Up to 20 digits
- (13) Own Character ID : Up to 16 characters

This page is intentionally left blank.

Troubleshooting

If You Have Any of These Problems

Mode	Symptom	Action	Page
During Installation Problem	The display is blinking	Battery discharged completely. This may happen at first installation. After setting the clock, the blinking will stop.	--
During Transmission Problems	Document doesn't feed/multiple feed	<ol style="list-style-type: none"> 1. Check that your document is free of staples and paper clips, and that it is not greasy or torn. 2. Check that your document is the right type to send through a fax machine by consulting the list on "Documents You Cannot Send". If your document has the characteristics listed, make a photocopy of your document and send the copy instead. 3. Check that the document is loaded properly. 4. Adjust the ADF Pressure Plate. 	39 40 131
	Document jam	The information code 031 will appear on the display if the document becomes jammed.	128
	Does not stamp	<ol style="list-style-type: none"> 1. Check if Stamp LED is lit. 2. Check Fax parameter No. 04 and No. 28 settings. 	42 35,36
	Stamp too light	Replace stamp or refill ink.	132
Transmission Copy Quality Problems	Vertical lines on the transmitted document	Check own copy quality. If copy is OK, your machine has no problem, report to receiving party that they have a problem. If copy is NG, clean the Document Scanning Area.	129
	Transmitted document is blank	<ol style="list-style-type: none"> 1. Make sure the document is set face down. 2. Check own copy quality. If copy is OK, your machine has no problem, report to receiving party that they have a problem. 	--
During Reception Problems	No recording paper	The information code 010 will appear on the display if the paper runs out.	18
	Recording paper jam	The information code 001, 002 or 003 will appear on the display if the paper gets jammed.	127
	Recording paper doesn't advance into machine	Make sure that there is paper in the Paper Cassette. Follow instructions for loading paper.	18
	Recording paper doesn't eject after printing	Check to see if the recording paper is jammed inside of the machine.	127
	Document auto reduction doesn't work	Check Print Reduction settings.	60
	Out of toner	The information code 041 will appear on the display if the Toner Cartridge runs out of toner.	16

811

Troubleshooting

Mode	Symptom	Action	page
Print Copy Quality Problems	Vertical lines printing on the received document	Printout a Journal report (e.g. FUNCTION, 6, 1 and SET) and check quality to make sure if your machine has trouble or not. If Journal report quality is OK, your machine has no problem, report to sending party that they have a problem. If copy is NG, replace the Toner Cartridge.	111 16
	Fuzzy print	1. Make sure you are using the correct paper for the best possible print quality. 2. Try reversing the recording paper to the other side.	137
	Missing dots or lines/inconsistent darkness within print	1. Make sure you are using the correct paper for the best possible print quality. 2. Replace the Toner Cartridge.	137 16
Print Copy Quality Problems	Fading print	The Toner Cartridge may be running out of toner. Replace the Toner Cartridge.	16
	Faint print	You may need to choose a different paper for the best possible print quality.	137
Communication Problems	No dial tone	1. Check the connection of telephone line. 2. Check the telephone line.	133
	No auto answer	1. Check the connection of telephone line. 2. Check Reception mode setting. 3. Check if machine is printing a report. (e.g.: 32 Transaction Journal, Fax Parameter List). If machine is printing a report, machine cannot receive until printing is completed. 4. If the printed document is 32nd Transaction, machine will usually print the 32 Transaction Journal automatically after printing out the document. In this case, machine cannot receive until the 32 Transaction Journal has been printed.	59
	Cannot transmit or receive	An information code will be shown on the display. Refer to the information code table to find out the trouble.	125
No Unit Operation	No unit operation	To reset the machine, turn-off the Power Switch for a few second then turn-on again.	

Troubleshooting

Information Codes

When something unusual occurs, the display may show one of the Information Codes below. These will help you to identify and correct the problem.

Info. Code	Meaning	Action	Page
001/002 003	Recording paper jam.	Remove jammed paper.	127
010	No recording paper.	Load the paper.	18
011	Recording Paper Cassette is not installed properly.	Install the Recording Paper Cassette.	--
017	Paper Length Guide of paper cassette is not set properly.	Check the position of Paper Length Guide.	18
030	Document misfeeding.	1. Reload the document properly. 2. Remove document jam. 3. Adjust ADF.	40 128 131
031	Document paper is too long or jammed. Document length exceeds 78.8 inches (2 meters).	1. Reload the document properly. 2. Remove document jam.	40 128
041	Out of toner.	Replace the Toner Cartridge.	16
045	Toner Cartridge is not installed.	Install the Toner Cartridge.	16
060	Printer Cover is opened.	Close the Printer Cover.	--
061	ADF Door (Document Return Guide) is opened.	Close the ADF Door.	--
400	During initial handshake, receiving station did not respond or communication error occurred.	1. Check with other party. 2. Reload the document and send again.	--
401	Remote station required a Receiving Password to receive the document. Remote station does not have Confidential Mailbox.	Check the remote station.	--
402	During initial handshake, communication error occurred.	Reload the document and send again.	--
403	No polling capability at the remote side.	Ask remote side to set "POLLED=ON".	--
404/405	During initial handshake, communication error occurred.	Reload the document and send again.	--
406	Transmission Password does not match. Receiving Password does not match. Received from an unauthorized station in Selective Reception mode.	Check the password or the telephone number in One-Touch or Abbreviated station.	85 87 88
407	No confirmation from the receiving station for the previous page sent.	Wait a few minutes and send again.	--
408/409	Remote side confirmation of previous page is illegible.	Wait a few minutes and send again.	--
411	Polling password does not match.	Check polling password.	67
412	No data from the transmitting side.	Check with the other party.	--
414	Polling password does not match.	Check polling password.	67
415	Polling transmission error.	Check polling password.	67

8
11
22

Troubleshooting

Info. Code	Meaning	Action	Page
416/417 418/419	Received data has too many errors.	Check with the other party.	--
420	Machine goes to receiving mode, but receives no command from the transmitting side.	1. Remote side misdial. 2. Check with the other party.	--
422/427	Interface is incompatible.	Check with the other party.	--
430/434	Communication error occurred while receiving.	Check with the other party.	--
436/490	Received data has too many errors.	Check with the other party.	--
456	<ul style="list-style-type: none"> • Unit received a confidential document or was requested to be polled of a confidential document under any of following conditions. <ol style="list-style-type: none"> 1) Memory does not have enough space to receive the confidential document. 2) Confidential Mailbox file is full (10 files). 3) While printing received document. • Unit was requested to relay a document. 	<ol style="list-style-type: none"> 1. Printout File List then check the contents. 2. Wait a moment until finishing the printing. 	76
492/493 494	Communication error occurred while receiving.	Check with the other party.	--
495	Telephone line disconnected.	Check with the other party.	--
540/541 542 543/544	Communication error occurred while transmitting.	<ol style="list-style-type: none"> 1. Reload the document and send again. 2. Check with the other party. 	--
550	Telephone line disconnected.	Check with the other party.	--
552/553 554/555	Communication error occurred while receiving.	Check with the other party.	--
623	No document was on the ADF.	Reload the document and send again.	--
630	Redial was not successful due to a busy line or no response from the called station.	Reload the document and send again.	--
631	During dialling, STOP was pressed.	Reload the document and send again.	--
634	Redial was not successful due to a busy line or no response from the called station.	Reload the document and send again.	--
638	Power failure occurred during the communication.	Check the power cord and plug.	20
870	Memory overflow occurred while storing documents into memory for transmission.	Transmit documents without storing into memory. Order additional memory option.	50
879	Memory overflow occurred while receiving documents into memory. Receiving documents with data that is greater than the memory size.	Check recording paper and toner cartridge.	16 18
975	DRAM parity error. The document information in memory is lost.	<ol style="list-style-type: none"> 1. Unit will print out a Power Failure Report. 2. Resend the lost document. 	121

Clearing Recording Paper Jam

If the recording paper becomes jammed in the machine, the display will show an Information Code 001, 002 or 003.

To clear the jam, Info. Code 001

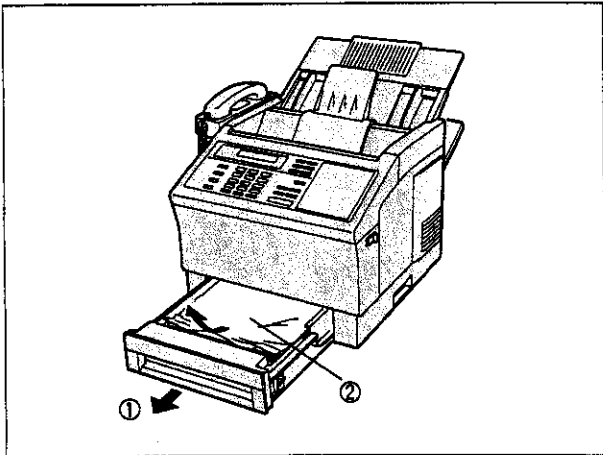

- ① Remove the Paper Cassette.

Caution: To prevent dropping the cassette, hold it by the front and side while pulling it out.

- ② Remove the jammed or wrinkled paper and reload the recording paper into the paper cassette.

Caution: Make sure paper does not exceed over the clips on the paper cassette.

- ③ Open the Printer Cover then close it.

To clear the jam, Info. Code 002

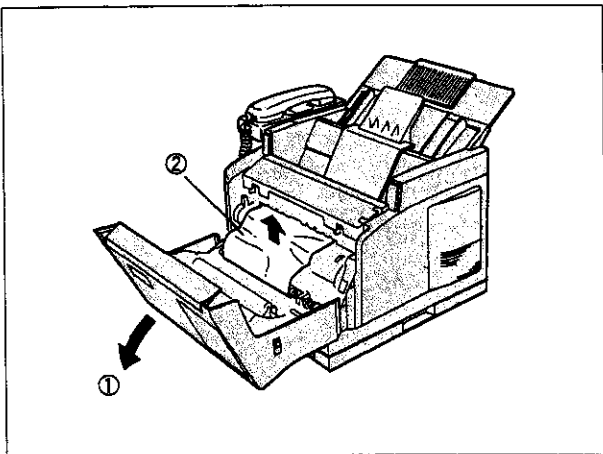

- ① Open the Printer Cover.

- ② Remove the jammed paper.

To clear the jam, Info. Code 003

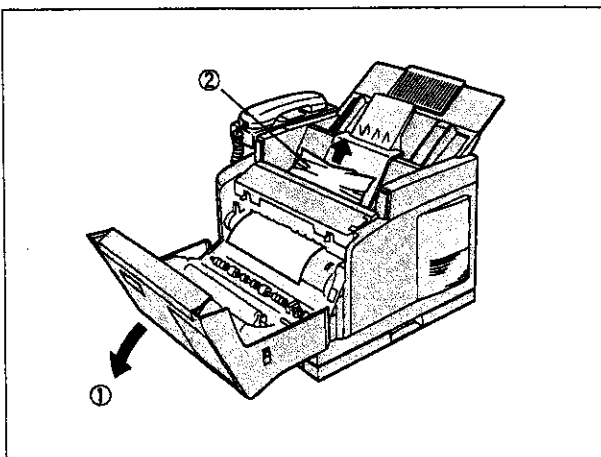

- ① Open the Printer Cover.

- ② Remove the jammed paper.

Troubleshooting

Clearing a Document Jam

If a document becomes jammed in the machine, the display will show the Information Code 031.

To clear the jam

1

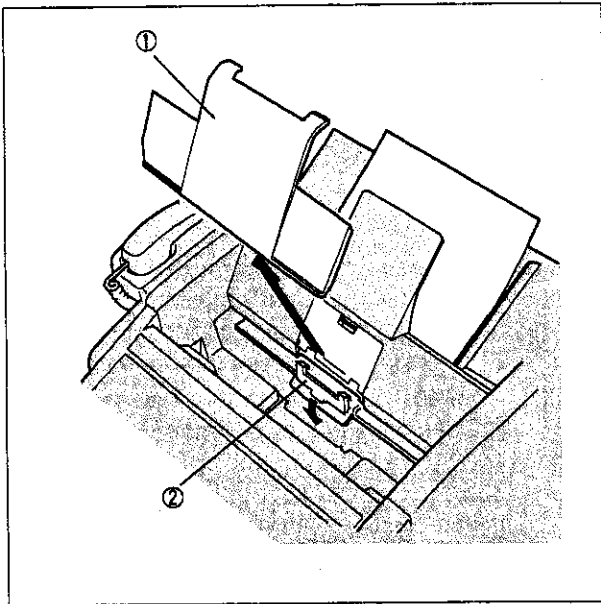

① Remove the Recording Paper Tray.

② Open the Document Return Guide.

2

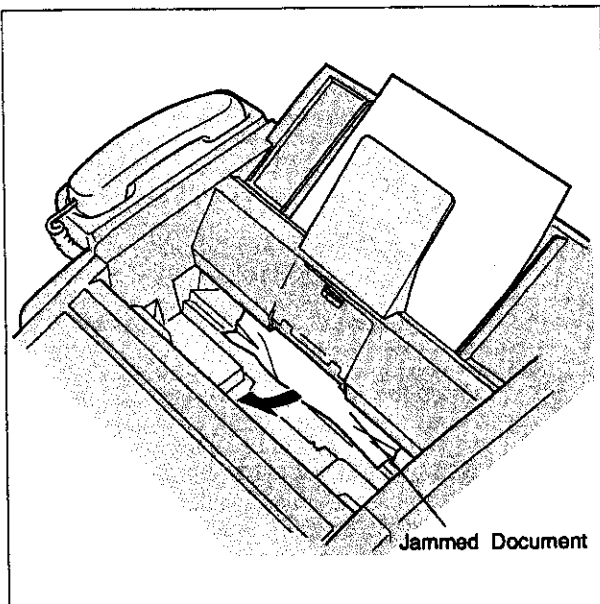

Remove the jammed document.

Cleaning the Document Scanning Area

If the receiving party reports that the received documents were black, or contained black lines, try making a copy on your unit to verify. If the copy is black or has black lines, the document scanning area is probably dirty and must be cleaned.

To clean the scanning area

1

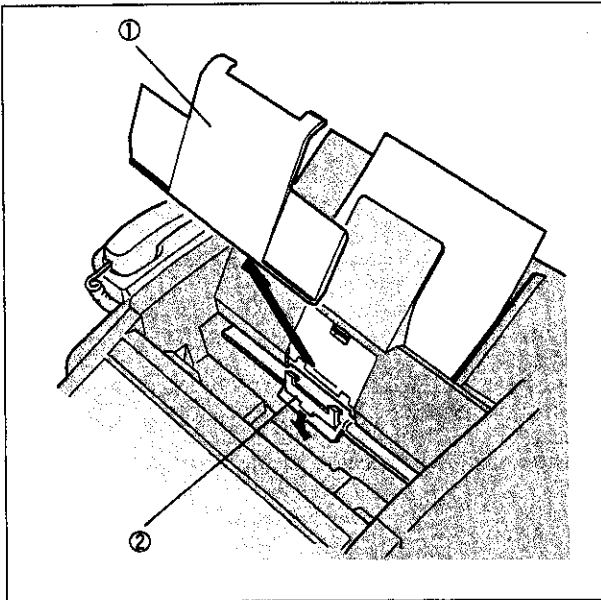

① Remove the Recording Paper Tray.

② Open the Document Return Guide.

2

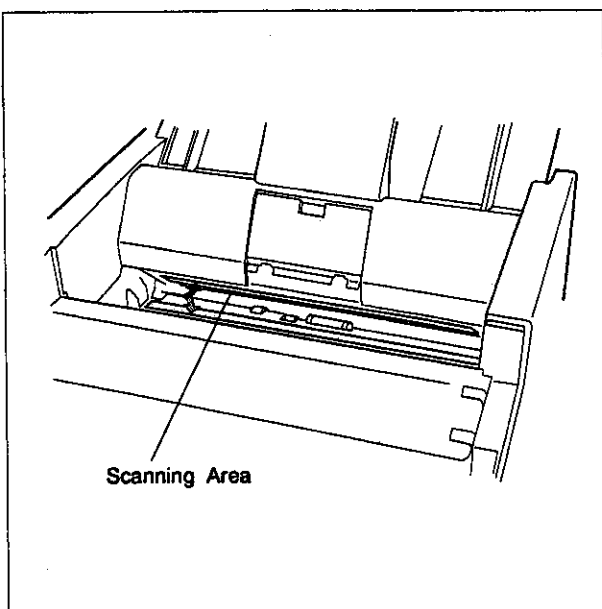

Wipe the scanning area gently with a soft cloth or gauze wet with ethyl alcohol. Be sure to use a clean cloth, the scanning area can be easily scratched.

8
||
xx

Troubleshooting

Cleaning the Printer Roller

If you find toner on the back of the recording paper, the printer roller in the fuser unit is probably dirty.

To clean the printer roller



SET MODE (1-6)
ENTER NO. OR ^ V



PLEASE WAIT FOR
PRINT OUT TEST CHART

Machine will print out 3 pages of the Cleaning Chart.

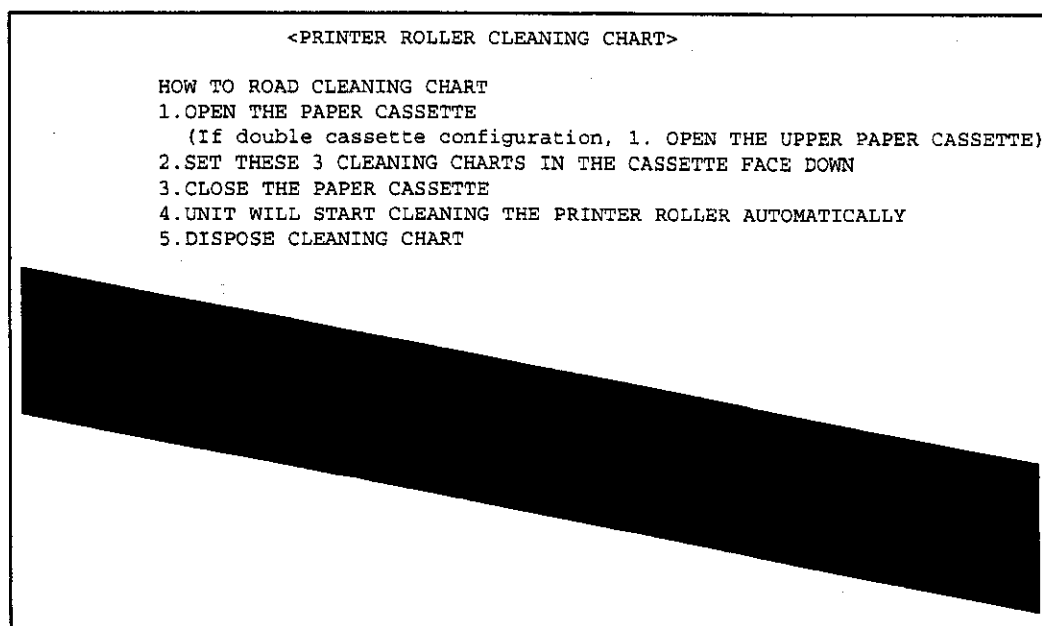

After printing the Cleaning Chart, the following message will appear.

LOAD CHART IN PAPER
CASSETTE FACE DOWN

3 Remove the paper cassette from the machine. Then, load the Cleaning Chart into the cassette face down. (See Note)

4 Re-install the paper cassette. Machine will automatically feed out the charts in order to clean the printer roller.

* CLEANING *
PRINTER ROLLER

* CLEANING *
COMPLETED

 **Note:** If you have installed the optional 2nd cassette, load the Cleaning Chart into the upper cassette.

Adjusting the Automatic Document Feeder (ADF)

If document misfeeding occurs frequently, we suggest you to adjust the ADF.

To adjust the ADF,

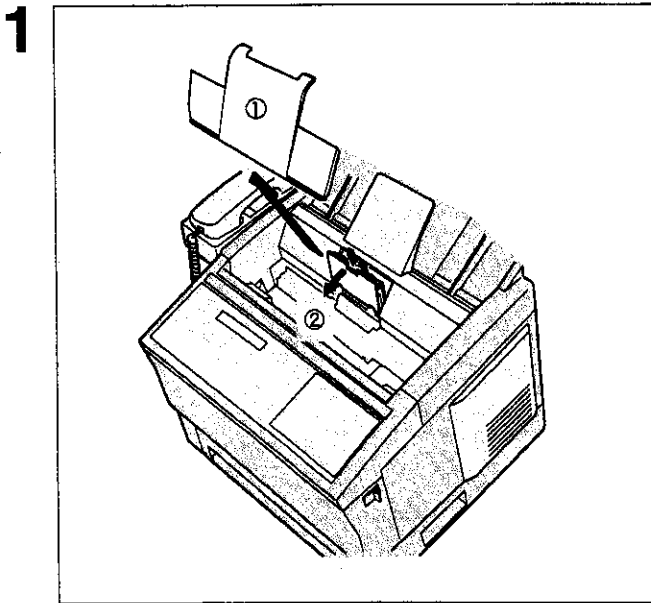

① Remove the Recording Paper Tray.

② Open the ADF Cover.

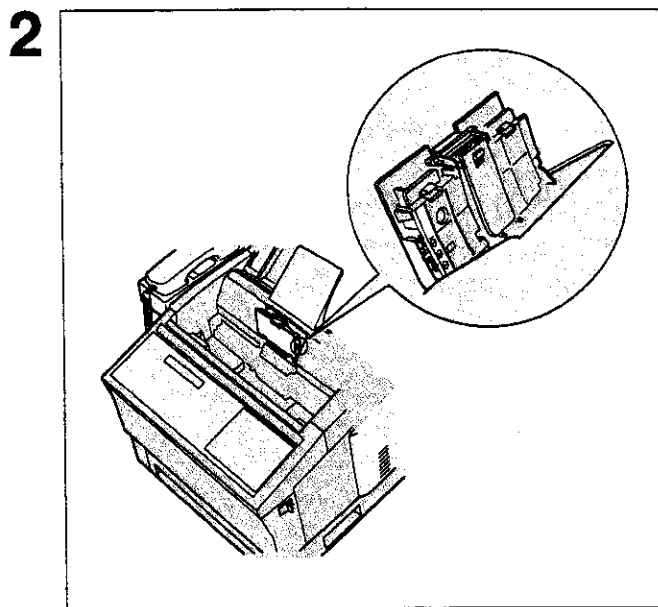

Slide the green Pressure Adjusting Lever to the desired position depends on the condition.

Position	Condition
1	To prevent no feed trouble
2	Standard position
3	To prevent multiple feed trouble



Troubleshooting

Verification Stamp

The Verification Stamp contains ink. When the stamp mark appears faded or hard to see, the stamp should be replaced or refilled with ink.

To remove the stamp

1

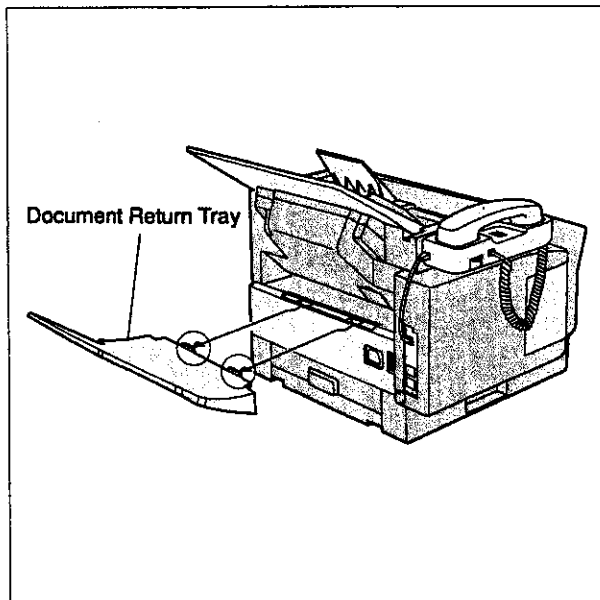

Remove the Document Return Tray.

2

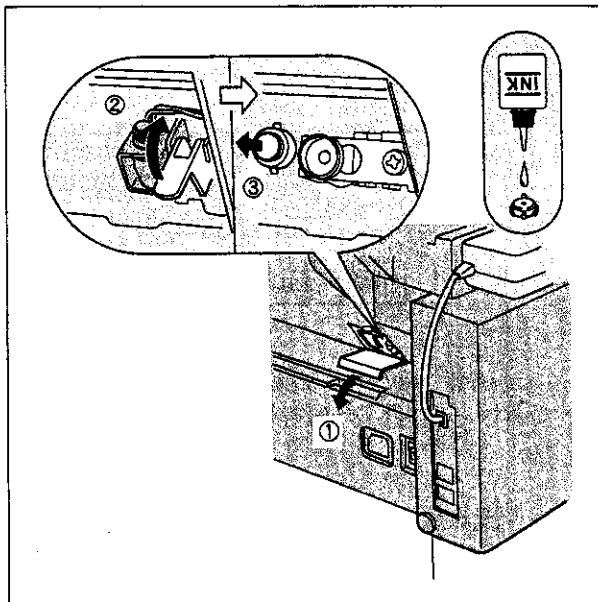

① Open the Stamp Cover.

② Rotate the Stamp Assembly upward.

③ Remove the Stamp. Replace the stamp with a new one or refill the stamp with a few drops of the specified ink into the back of the stamp.



Note: Please contact your local Panasonic dealer to purchase a new stamp. See page 138 for order number.

Checking the Telephone Line

When you do not hear a dial tone through the telephone connected to the machine or when the telephone does not ring (No automatic receive).

1

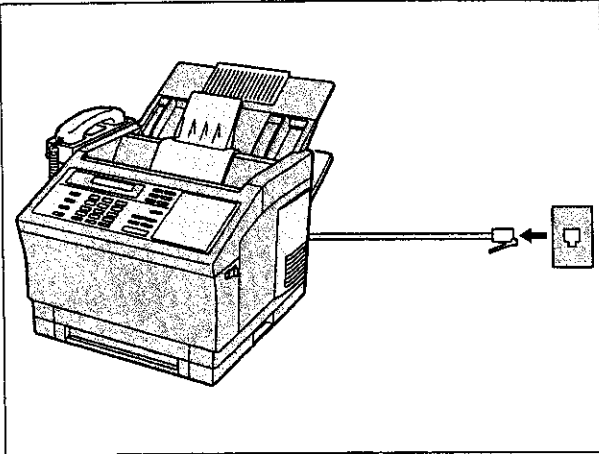

Unplug the Telephone Line Cord from the telephone jack that was supplied by the telephone company.

2

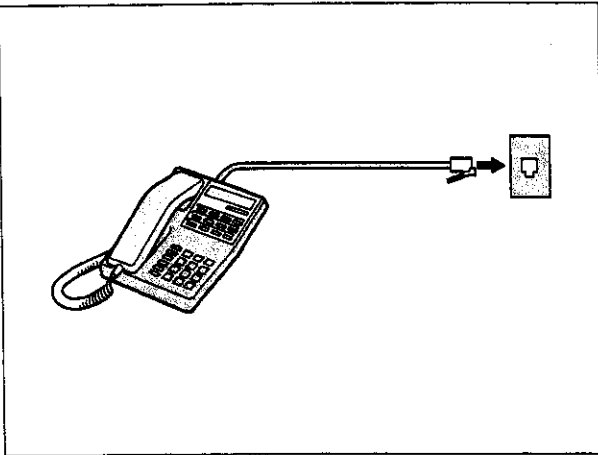

Plug a different regular telephone into the same telephone jack.

3

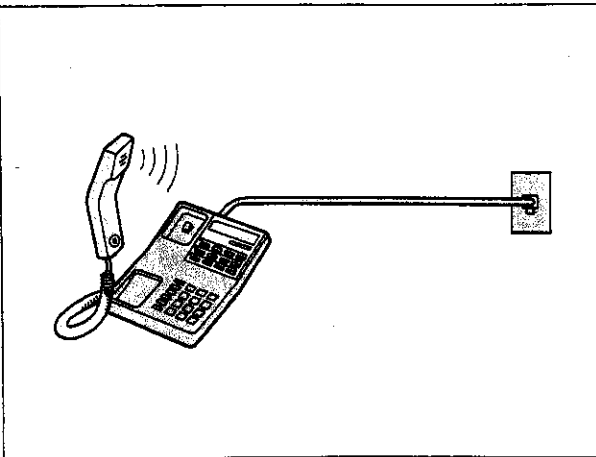

Check for dial tone through the handset. If there is still no dial tone, report it to your local telephone company.

or

Call from another telephone to this number. If the telephone does not ring, report it to your local telephone company.

This page is intentionally left blank.

Specifications

Compatibility	CCITT Group 3									
Scanning Method	Flat bed scanning with CCD type image sensor									
Document Size	Max. : 297 mm x 2000 mm (with operator's assistance) Min. : 148 mm x 128 mm									
Document Thickness	Single sheet : 0.06 mm (45 g/m ²) to 0.15 mm (112 g/m ²) Multiple sheets : 0.06 mm (45 g/m ²) to 0.12 mm (75 g/m ²)									
ADF Capacity (Automatic Document Feeder)	Built-in, up to 50 sheets Note: The document limitation to send multiple pages is as follows.									
	<table border="1"> <thead> <tr> <th></th> <th>Document Size</th> <th>Document Thickness</th> </tr> </thead> <tbody> <tr> <td>Up to 30 pages</td> <td>Up to A3 Size</td> <td>0.06 mm (45 g/m²) to 0.12 mm (75 g/m²)</td> </tr> <tr> <td>Up to 50 pages</td> <td>A4 Size</td> <td>0.12 mm (75 g/m²)</td> </tr> </tbody> </table>		Document Size	Document Thickness	Up to 30 pages	Up to A3 Size	0.06 mm (45 g/m ²) to 0.12 mm (75 g/m ²)	Up to 50 pages	A4 Size	0.12 mm (75 g/m ²)
	Document Size	Document Thickness								
Up to 30 pages	Up to A3 Size	0.06 mm (45 g/m ²) to 0.12 mm (75 g/m ²)								
Up to 50 pages	A4 Size	0.12 mm (75 g/m ²)								
Effective Scanning Width	252 mm									
Recording Method	Laser printer									
Recording Paper	Plain Paper									
Recording Paper Size	Letter / A4 or Legal (with optional Legal Cassette)									
Effective Recording Size	Letter : 211 mm x 273 mm A4 : 205 mm x 291 mm Legal : 211 mm x 350 mm									

Print Margin

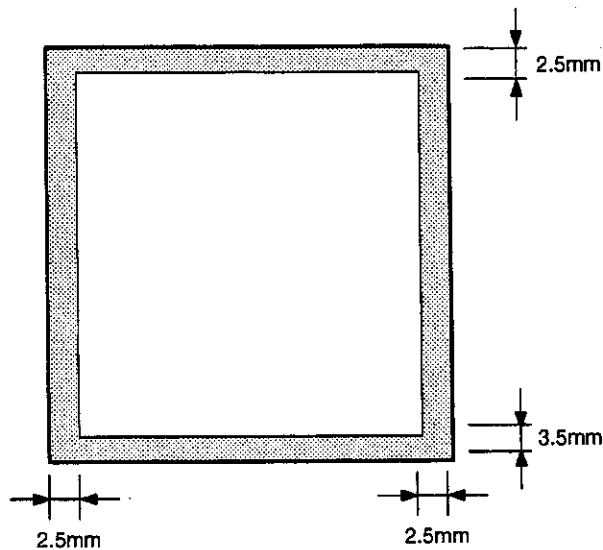

9

Specifications

Recording Paper Capacity	Approx. 250 sheets (using 75 g/m ² paper)
Resolution	Horizontal : 8 pels/mm Vertical : 3.85 lines/mm 7.7 lines/mm 15.4 lines/mm:Transmission only
Coding Scheme	MH, MR, MMR (Conform to CCITT)
Modem Type	CCITT V.17, V.33, V.29, V.27 ter and V.21
Modem Speed	14400, 12000, 9600, 7200, 4800, 2400 and 300 bps
One-Touch/Abbreviated Dialling Memory Capacity	140 stations (including 32 One-Touch keys and 8 Program keys) Each station can register up to 36 digits for each telephone number (including pauses and spaces) and up to 15 characters for each station name
Image Memory Capacity	Approx. 28 pages (Standard base memory) Approx. 88 pages (with optional 1 MB IC Memory Card) Approx. 148 pages (with optional 2 MB IC Memory Card) (Based on CCITT Test Chart No.1 using Standard Resolution)
Power Supply	180-264 VAC, 47-63Hz, Single Phase : 200 V version (90-140 VAC, 47-63Hz, Single Phase : 100 V version)
Power Consumption	Standby : Approx. 15Wh (Power Saver Mode : On) : Approx. 40Wh (Power Saver Mode : Off) [Room temperature : 25°C] Transmission : Approx. 30W Reception : Approx. 450W Copy : Approx. 450W Max : Approx. 450W
Dimensions	423 mm (W) x 434 mm (D) x 311 mm (H) (excluding Projections and optional 2nd Paper Cassette)
Weight	Approx. 16.6 Kg (excluding consumable supplies and options)
Operating Environment	Temperature : 5 to 35°C Relative Humidity : 15 to 70%

Recording Paper Specifications

In general, most bond papers will produce excellent results. Most photocopy papers will also work very well. There are many "name" and "generic" brands of paper available. We recommend that you test various papers until you obtain the results you are looking for.

The following table summarizes the major specifications to consider when selecting white or colored paper.

Basic Weight	60 to 105 g/m ²
Cut Edge Conditions	Cut with sharp blades, no visible frayed edges
Grain	Long grain
Moisture Content	3.7% to 5.3% by weight
Opacity	88% minimum
Packing	Polyaminated moisture-proof ream wrap
Sizes	A4 : 210 mm x 297 mm Letter : 216 mm x 279 mm Legal : 216 mm x 356 mm
Type	Cut sheet



9
11

! **Note:** It is possible that paper could meet all of the specifications listed above and still not print well because of the variations in paper manufacturing. Therefore, we recommend that you test paper thoroughly before purchasing.

Options and Supplies

Please contact your local Panasonic dealer for availability.

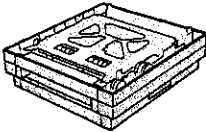
A. Options:

Order No.	Picture	Description
UE-409007		250 sheets Letter / A4 Size Paper Cassette with the Feeder Unit
UE-409010		500 sheets A4 Size Paper Cassette with the Feeder Unit
UE-410006		Expansion IC Memory Card, 1MB
UE-410007		Expansion IC Memory Card, 2MB

B. Supplies:

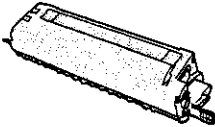
Order No.	Picture	Description
FX-13-2P		Verification Stamp
UG-3204		Toner Cartridge

Installing Memory Card

Before installation begins, make sure that there is no document file stored in the memory. You may confirm by print out a File List (see page 76). When the memory card is installed, the machine will initialize the document memory, all contents stored in the document memory will be lost.

1

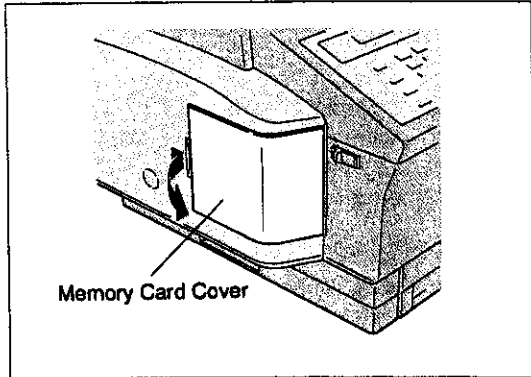

① Turn the Power Switch to the "O" (OFF) position.

② Remove the Memory Card Cover.

2

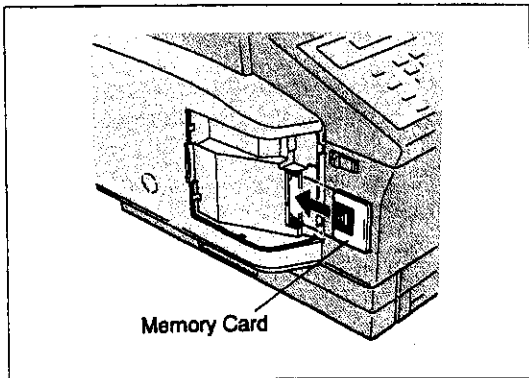

① Insert the Memory Card into the card slot with the Panasonic logo facing out.

② Re-install the Memory Card Cover.

3

Turn the Power Switch to the "I" (ON) position. Print out the Fax Parameter List (see page 120) and confirm the memory size on Fax Parameter No. 53. (see page 37)

9

Glossary

ABBR. No. (Abbreviated Number)	The ability to store full phone numbers into the dialer and then utilizing a short series of keystrokes to speed dial that number in the future.
ADF (Automatic Document Feeder)	The mechanism that delivers a stack of document pages to the scanner one page at a time.
Automatic reception	The mode that allows you to receive fax documents without user intervention.
Auto print reduction	The method of automatically reducing a received document so that it can be printed onto a standard size piece of plain paper. For example, your machine will reduce an incoming legal size page to 75% of its original size so it could fit on a letter size page.
BPS (Bits Per Second)	The amount of data that is transmitted over the phone line. Your machine can start at 14,400 BPS and automatically steps down to 12,000, 9600, 7200, 4800, 2400 BPS depending on the phone line condition and the receiving machine's capabilities.
C.C.I.T.T.	Consultative Committee on International Telegraph and Telephone. This organization has presently developed four groups of industry standards that insure facsimile compatibility.
CCITT Test Chart No.1	An industry standard document that allows comparisons of the transmission speeds and capabilities of facsimile machines.
Character ID	A programmed proprietary code name that allows up to 16 alphanumeric characters identifying your facsimile machine.
Character keys	The keys that are used to enter letters and symbols for various programming functions.
Coding scheme	The data compression method used by facsimile machines. Your machine utilizes Modified Huffman (MH), Modified Read (MR), and Modified Modified Read (MMR) coding schemes.
COMM. JOURNAL	Refers to either the Communication Journal, Relay Transmission Report, or the Confidential XMT Report.
Confidential communication	In a network of facsimile machines, a code can be entered to retrieve a document that is stored in memory of a designated relay station.
Confidential XMT Report	The report that gives you information about the transmission of a confidential documents to a relay station.
DDD (Direct Distance Dialling)	A telephone service that allows unassisted dialling, no operator assistance is required.
Deferred polling	The ability to retrieve documents from other stations at a later time.
Deferred transmission	The ability to send documents to other stations at a later time.
Direct Dialling	The method of dialling where you enter the entire telephone number through the keypad.

Directory Sheet	The list that contains the station names that are programmed into your unit.
DTMF (Dual Tone Multi-Frequency)	Dialling method that sends a different set of frequencies for each digit of the telephone keypad. Commonly refers to touch tone dialling.
ECM (Error Correction Mode)	The ability to correct transmission errors as detected during the transmitting phone call.
End receiving station	In a relay network, the final station designated to receive the document.
FAX Access code	A 4-digit programmable code that prevents unauthorized operation of your Fax.
FAX Parameter List	The list that contains the home FAX parameters settings that you have programmed into your machine.
File	A task that has been stored into the memory of your unit. Examples are deferred transactions.
Fixed print reduction	The method that allows you to determine one reduction rate, such as 75%, for all incoming documents.
FUNCTION	The control panel key that will be utilized to begin an operation or configuration of a feature.
G3 mode (Group 3)	Refers to the standards and transmission capabilities of the current generation of facsimile machines.
Group dialling	The ability to program many telephone numbers into a single station so that many locations can be dialed in sequence utilizing a single keystroke.
HALFTONE	A scanning technique to distinguish levels of gray from black and white. Your machine can detect up to 64 levels of gray in halftone mode.
Handshaking	The exchange of a group of control signals that communicate between the transmitter and receiver. These signals determine the condition at which communication can occur.
Header	A row of information that is transmitted by the sending machine and printed on the top of each page by the receiving unit. This identifies the transmitting unit and information about the transmission, such as time and date.
ID	A programmable address of up to 20 digits identifying your machine.
Image memory capacity	This signifies the amount of memory available in your unit capable of storing pages of documents. All page units of measure are based using the CCITT Test Chart No.1.

Glossary

Individual Transmission Journal	A report that is printed by the transmitting unit stating information regarding the last document transaction.
Information code	A code that is internally generated by your Fax stating a specific operational error or machine failure.
Initial sending station	In a relay network, the station that is originating the document transmission.
Journal	A report that is printed by your unit listing the last 32 transmitting and receiving transactions.
Keypad	A group of numeric keys located on your control panel.
LCD	Liquid Crystal Display. The display area of your machine.
LOGO	Your programmed company name or identification up to 25 alphanumeric characters.
Manual reception	A mode that requires operator intervention to receive an incoming document.
Memory transmission	The documents are scanned into memory before actual connection to the phone line for transmission.
Modem	A device that converts signals from your fax machine into signals that can be transmitted over telephone lines.
Multi-station transmission	The ability to broadcast the same set of documents to a programmed number of locations.
Multi-file transmission	The ability to store many files into your machines memory before actual telephone connection occurs.
Network address	An individual 4-digit addressing number assigned to a One-Touch/Abbreviated number that identifies a particular station in a relay network.
Network password	A 4-digit password assigned to a network address to prevent unauthorized stations from accessing a relay station.
Off-hook dialling	The direct dialling of a telephone number with the handset out of the cradle or "off the hook."
On-hook dialling	The direct dialling of a telephone number with the handset in the cradle or "on the hook."
One-Touch dialling	The ability to dial an entire telephone number by pressing one key.
ORIGINAL	Signifies the scanning sensitivity in terms of lightness and darkness of your original transmitting pages.
Panasonic Super Smoothing	An electronic image enhancement (Panasonic Super Smoothing) that will create a particular pattern for the improvement of copy quality.

Polling	The ability to retrieve a document from another facsimile machine.
Polling password	A 4-digit programmed code that enables the security of a document being polled.
Power Failure Report	A report that contains information on the last transaction that took place during a power outage. (This prints only when the memory back-up battery has been dis-charged.)
Print reduction modes	The methods used to determine how an incoming document will be reduced to print onto the paper loaded in your machine.
Program keys	Keys that are defined for storing a sequence of stations to be dialed or polled.
PSTN	Public Switched Telephone Network. Network of interconnected switching equipment and transmission facilities.
Receiving password	A 4-digit password that is checked before a document is received.
Relay station	A certain type of facsimile machine that can store and forward documents to an end receive station and/or a relay station in another relay network. Your machine can not be used as a relay station.
Relay network	A group of facsimile machines that communicate via a relay station.
Relay Transmission	Sending a document to a relay station, which in turn, sends the document to the end receiving station.
Relay Transmission Report	A report that contains information regarding the last document transmission to a relay station.
Relay address	A 2-digit code that identifies your machine is programmed in a relay network.
RESOLUTION	Relates to the number of dots scanned or printed per certain square. The quality of the image increases as the number of dots per certain square increases.
Selective reception	A function that can be set so that your unit will receive from only those machines programmed into your dialer.
Stored documents	Documents that have been scanned and now are stored in your machine's memory.
Substitute memory reception	Your machine's ability to store an incoming document into its memory, when it runs out of recording paper or toner.
Transmission reservation	The ability to preset a telephone number so that you may reserve a transmission while your unit is performing another function.
Transmission password	A 4-digit password that is checked when a document is transmitted.

Glossary

User parameter

Programmed parameters that provide information to other stations. Examples are logo, character ID, date and time.

Verification stamp

A user selectable transmission verification stamp can be placed on scanned documents that are successfully transmitted.

INDEX

A		I	
ABBR. Number List	117	ID Number	27
Abbreviated Dialing Numbers	29	Image Memory Capacity	136
ADF Capacity	135	IND. XMT JOURNAL	111
Automatic Document Feeder	40	Information Codes	125
Automatic Reception	59	Initial Sending Station	101
Automatic Reduction	60		
C		J	
Character ID	26	Journal	111
Character Key	9		
Communication Journal (COMM. JOURNAL)	43	K	
Confidential Code	90	Key/Buzzer Volume	35
Confidential Communication	90		
Confidential Mailbox	90	L	
Copy	63	Loading Document	39
		LOGO	25
D		M	
Date and Time	24	Memory Transmission	44
Deferred Polling	66	Monitor Volume	23
Deferred Transmission	70	Multi-Station Transmission	49
Dialing Method (Tone or Pulse)	22		
Dimensions	136	N	
Directory Sheet	33	Network Address	104
Document Jam	128	Network Password	104
Document Misfeeding	131		
Document Return Tray	13	O	
Document Size	135	Off-Hook Dialing	50
Document Thickness	135	On-Hook Dialing	51
		One-Touch Dialing Numbers	29
F		One-Touch Key	29
Fax Access Code	82	One-Touch List	117
Fax Parameter List	120	Operating Environment	136
Fax Parameter Table	35	Option Memory	138
File List	76	Original (Contrast)	41
Fixed Reduction	60	Own Network Address	104
Function Key List	10	Own Telephone Number	104
G		P	
Group Dialing	73	Password Communication	86
		Password Reception	86
H		Password Transmission	86
Halftone	42	Polling	67
Handset	14	Polling Password	67
Handset Base	14	Power Consumption	136
		Power Failure Report	121
		Pressure Adjusting Lever	131
		Print Margin	135
		Print Reduction	60
		Print Reduction Ratio	60

Program Keys	70
Program List	119

R

Receive To Memory	83
Receiving Password	88
Recording Paper Jam	127
Recording Paper Specification	137
Relay Address	104
Relay Network	101
Relay Station	101
Relay Station Parameter	104
Relay XMT Report (COMM. JOURNAL)	109
Relayed Transmission	101
Resolution	136
Result Report	109
Ringer Volume	23

S

Selective Reception	85
Substitute Reception	62

T

Timer Controlled Communications	65
Toner Cartridge	13, 16
Transmission Password	87
Transmission Reservation	56

U

User Parameter	24
----------------------	----

V

Verification Stamp	42, 132
Voice Contact	64

W

Weight	136
--------------	-----