

# Contents

## CHAPTER 1. BEFORE USING TXT8026

<b>BEFORE USING</b> .....	3
INSIDE THE PACKAGE.....	3
HANDSET DESCRIPTION.....	3
KEY DESCRIPTIONS.....	4
DISPLAY INDICATORS.....	4
INSTALL BATTERY.....	5
REMOVE BATTERY.....	5
CHARGING YOUR BATTERY.....	5
BATTERY HANDLING INFORMATION.....	6

## CHAPTER 2. BASIC OPERATION

<b>BASIC OPERATION</b> .....	8
TURNING THE PHONE ON/OFF.....	8
ACCESSING THE MENU.....	8
USING THE WIDGETS MENU.....	8
MENU SUMMARY.....	10
MAKING A CALL.....	11
ANSWERING CALLS.....	11
MISSED CALL NOTIFICATION.....	11
WAIT/PAUSE FEATURE.....	11
ANSWERING A CALL.....	12
3-WAY CALLING.....	12
CALL WAITING FUNCTION.....	12
CALLING A NUMBER FROM CONTACTS.....	12
ADJUSTING VOLUME.....	12
ADJUSTING THE CALL VOLUME.....	12
CALLER ID FUNCTION.....	12
VIBRATE ON/OFF MODE.....	13
SPEAKERPHONE MODE.....	13
USING AUTO KEYPAD LOCK FUNCTION.....	13
AVAILABLE OPTIONS DURING A CALL.....	13
MAKING AN EMERGENCY CALL.....	14
USING THE microSD CARD.....	14

## CHAPTER 3. MEMORY FUNCTION

<b>MEMORY FUNCTION</b> .....	16
STORING A PHONE NUMBER.....	16
ENTERING LETTERS, NUMBERS & SYMBOLS.....	18
ONE, TWO-TOUCH DIALING.....	18

## CHAPTER 4. MENU FUNCTION

<b>RECENT CALLS</b> .....	20
RECENT CALLS.....	20
MISSED CALLS.....	20
RECEIVED CALLS.....	20
DIALED CALLS.....	21
BLOCKED CALLS.....	21
ALL CALLS.....	22
CALL TIMERS.....	22
<b>CONTACTS</b> .....	23
NEW ENTRY.....	23
LIST ENTRIES.....	23
MESSAGE GROUPS.....	23
GROUPS.....	25
SPEED DIALS.....	25
MY NAME CARD.....	26
<b>CAMERA</b> .....	27
CAMERA.....	27
<b>BROWSER</b> .....	28
STARTING BROWSER.....	28
MOBILE WEB MENU.....	28
<b>GAMES &amp; APPS</b> .....	30
STARTING GAMES & APPS.....	30

DOWNLOADING APPLICATIONS.....	30
DOWNLOADING MELODIES/WALLPAPERS.....	30
APPLYING MELODIES/WALLPAPERS.....	30
CHECKING DATA FOLDER MEMORY.....	30
DELETE APPLICATION.....	30

<b>TOOLS/UTILITIES</b> .....	31
CALCULATOR.....	31
CALENDAR.....	31
ALARM CLOCK.....	32
WORLD CLOCK.....	33
NOTEPAD.....	33
STOP WATCH.....	34
VOICE COMMANDS.....	34
VOICE COMMANDS SETTINGS.....	36
VOICE COMMANDS INFO.....	37
VOICE MEMO.....	37

<b>MEDIA GALLERY</b> .....	38
SOUND BOX.....	38
PICTURE BOX.....	38
MP3 BOX.....	38

<b>SETTINGS</b> .....	39
SOUND SETTINGS.....	39
DISPLAY SETTINGS.....	41
PHONE SETTINGS.....	42
CALL SETTINGS.....	44
MEMORY.....	45
BLUETOOTH.....	45
PHONE INFO.....	47

## CHAPTER 5. MESSAGES MENU

<b>MESSAGES</b> .....	49
WHEN A NEW MESSAGE ARRIVES.....	49
NEW MESSAGE.....	49
VOICEMAIL.....	50
INBOX.....	51
SENT.....	51
DRAFTS.....	52
SETTINGS.....	52
ERASE.....	53

## CHAPTER 6. SAFETY AND WARRANTY

<b>SAFETY</b> .....	55
SAFETY INFORMATION FOR WIRELESS HANDHELD PHONES.....	55
SAFETY INFORMATION FOR FCC RF EXPOSURE.....	57
SAR INFORMATION.....	57
HEARING AID COMPATIBILITY (HAC) FOR WIRELESS TELECOMMUNICATIONS DEVICES.....	57
FDA CONSUMER UPDATE.....	58
AVOID POTENTIAL HEARING LOSS.....	60
FCC COMPLIANCE INFORMATION.....	61
<b>WARRANTY</b> .....	62
12 MONTH LIMITED WARRANTY.....	62

# Before Using TXT8026



**This chapter provides important information about using the TXT8026 including:**

- Inside the package
- Handset descriptions
- Key descriptions
- Display indicators
- Install battery
- Remove battery
- Charging your battery
- Battery handling information

# Before Using

## INSIDE THE PACKAGE

This package should include all items pictured below.

If any are missing or different, immediately contact the retailer where you purchased the phone.



Handset



Standard Battery



User Guide

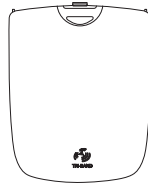

Battery Cover

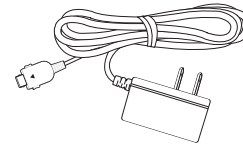

Wall Charger

## HANDSET DESCRIPTION

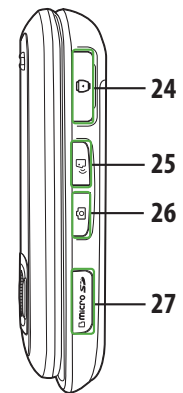
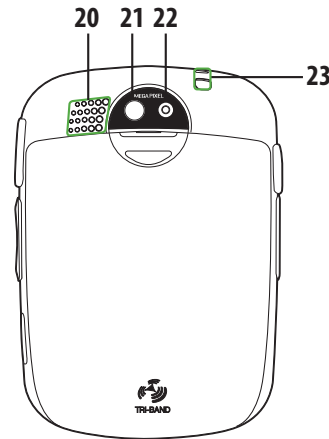
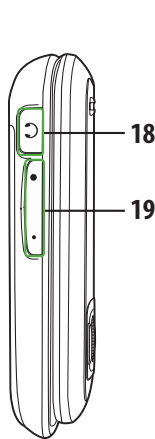
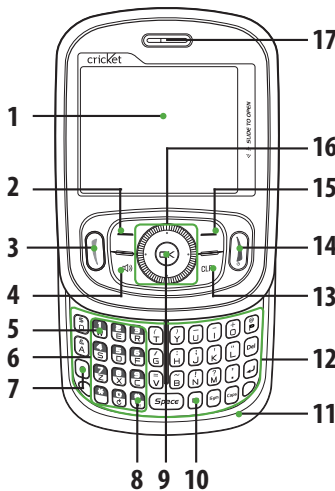

1. Display Screen
2. Menu/Left Soft Key
3. SEND Key
4. Speakerphone Key
5. Voicemail Key
6. Dialing Keypad
7. Mode Change Key

8. Vibrate Mode Key
9. OK Key
10. My Messaging Key
11. Microphone
12. QWERTY Keyboard
13. CLR Key
14. END Key















15. Contacts/Right Soft Key
16. Directional Key
17. Earpiece
18. Headset Jack
19. Volume Keys
20. External Speaker
21. Self-Portrait Mirror

22. Camera Lens
23. Wrist Strap Eyelet
24. Charging / Data Jack
25. AVR Key
26. Camera Key
27. microSD Card Slot











# Before Using













## KEY DESCRIPTIONS

The following list correlates to the previous page's phone illustration.

1. **Display Screen:** This screen displays all the information needed to operate your phone.
2. [  ] **Menu/Left Soft Key:** Press to display the Main menu or access the function listed above the key.
3. [  ] **SEND Key:** Press to make or receive a call. From idle mode, press to access the All Calls list.
4. [  ] **Speakerphone Key:** Press to turn Speakerphone On or Off.
5. [  ] **Voicemail Key:** Press and hold to automatically dial your voicemail system.
6. **Dialing Keypad:** In idle mode, press to enter phone numbers.
7. [  ] **Mode Change Key:** Allows you to change between entering numbers and letters.
8. [  ] **Vibrate Mode Key:** Press and hold to activate Vibrate mode.
9. [  ] **OK Key:** Allows you to accept choices when navigating through a menu.
10. [  ] **My Messaging Key:** Press to access the My Messages Menu.
11. **Microphone:** Allows the other caller to hear you clearly when you are speaking to them.
12. **QWERTY Keyboard:** Press to enter numbers, letters, and characters using a full QWERTY keypad interface.
13. [  ] **CLR Key:** When entering a phone number or text, press to delete a single space or character. Press and hold to delete entire words. Press this key once in a menu to go back one level. In WAP applications mode, press to retrieve the last URL or press and hold to retrieve the home page URL. During download mode, press to cancel the download.
14. [  ] **END Key:** Press to turn the phone on/off, end a call or browser session and/or return to idle mode.
15. [  ] **Contacts/Right Soft Key:** Press to display Contacts or to access the function listed above the key.
16. [  ] **Directional Key:** The Directional Key allows you to scroll through phone menu options or Widgets menu options.
17. **Earpiece:** The earpiece allows you to hear the other caller.
18. **Headset Jack:** Plug in the Headset Connector here to use a headset.
19. [  ] **Volume Keys:** Allows you to adjust the master volume in idle mode or adjust the voice volume during a call.
20. **External Speaker:** Music, Ringtones and Sounds are played through the speaker.
21. **Self-Portrait Mirror:** Displays your reflection when taking pictures.
22. **Camera Lens:** The lens of your built-in camera.
23. **Wrist Strap Eyelet:** Accessory eyelet (optional straps and lanyards - purchased separately).
24. **Charging/Data Jack:** Plug in the Wall Charger or USB Cable here.
25. [  ] **AVR Key:** In idle mode, press to activate "Nuance VSuite 3.2".
26. [  ] **Camera Key:** Press to access Camera Viewfinder mode.
27. **microSD Card Slot:** You can insert a microSD™ memory card here to increase memory capacity.

## DISPLAY INDICATORS

Icon	Icon Descriptions
	<b>1X Signal Strength:</b> 1X service is available.
	<b>Airplane Mode:</b> Transmitting and receiving information is restricted.
	<b>Roaming:</b> The phone is outside of the home service area.
	<b>Voice Privacy:</b> Indicates Voice Privacy mode is active.
	<b>Data Call:</b> Data Session in progress.
	<b>Dormant:</b> Phone is in a dormant state during a data call. Phone reverts to Dormant mode when there hasn't been activity on a page for some time — the connection is still active and you can make and receive calls.
	<b>No Service:</b> Phone cannot receive a signal from the system.
	<b>TTY:</b> TTY mode is active.
	<b>Voice Call:</b> A call is in progress. * No icon indicates the phone is in idle mode.
	<b>GPS Icon:</b> Location Service of your phone is Location On.
	<b>Bluetooth:</b> Indicates Bluetooth power is on.

Icon	Icon Descriptions
	<b>Bluetooth Active:</b> Indicates Bluetooth Active mode.
	<b>Bluetooth Connected:</b> Indicates Bluetooth Device is connected.
	<b>Bluetooth Discovery:</b> Indicates Bluetooth Discovery Mode is on.
	<b>Battery Level:</b> Battery charging level — the more blocks, the stronger the charge.
	<b>AVR Active:</b> Voice Commands are ready.
	<b>AVR Listening:</b> Indicates the AVR system is providing you with audible instructions.
	<b>All Sounds Off:</b> Ringer volume is set to off.
	<b>Vibrate Only:</b> Phone will vibrate when call is received.
	<b>Speakerphone:</b> Speakerphone mode is active.
	<b>Message:</b> Indicates you have new message(s).
	<b>Voicemail:</b> Indicates you have voicemail message(s).
	<b>Alarm On:</b> Appears when an alarm is set.

# Before Using

## INSTALL BATTERY

1. Push down the top of the battery cover slot with your finger tip and slide it out to remove from the unit.
2. Slide the battery into the slot located at the bottom of the unit and press until it lays flat in the battery cavity.
3. Replace the battery cover by sliding the battery cover up until it snaps into place.

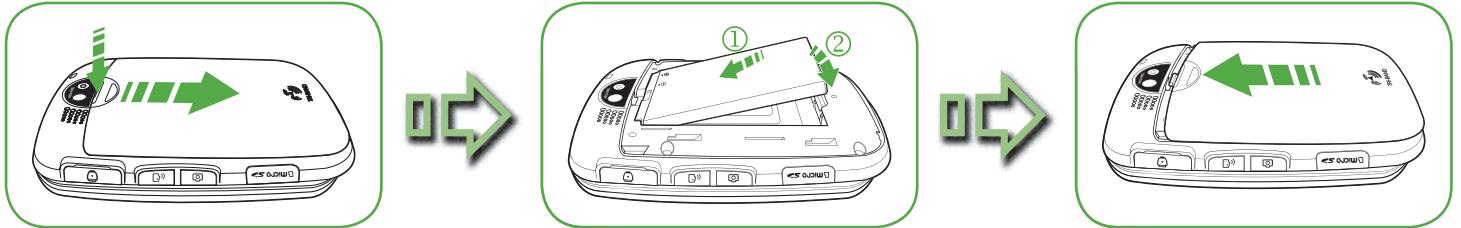

 If the battery is not correctly placed in the compartment, the handset will not turn on and/or the battery may detach during use.

## REMOVE BATTERY

1. To remove the battery cover, push down the top of the battery cover slot with your finger tip and slide the battery cover out from the unit.
2. Push the bottom of battery to upwards while inserting your finger into the slot (1) and remove (2) the battery.
3. Replace the battery cover by sliding the battery cover up until it snaps into place.

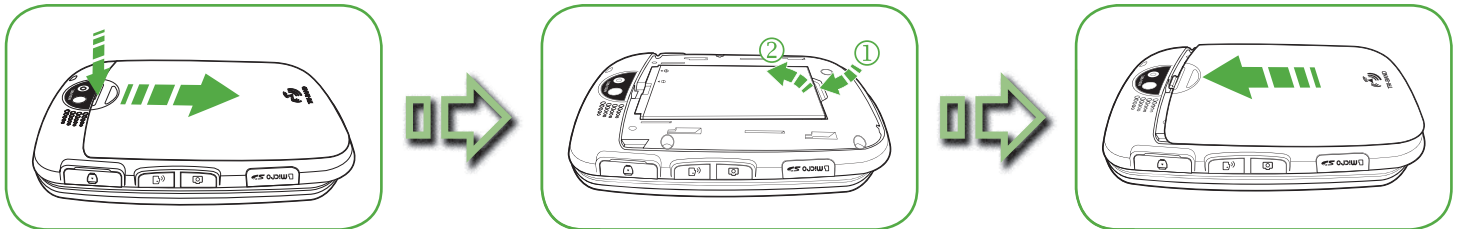

## CHARGING YOUR BATTERY

1. To charge the phone, open the Charging/Data Jack cover on the right side of the phone, and connect the charger adapter. Plug the other end into a standard outlet.
2. To remove the adapter connection, squeeze the adapter's side buttons (1) and pull.

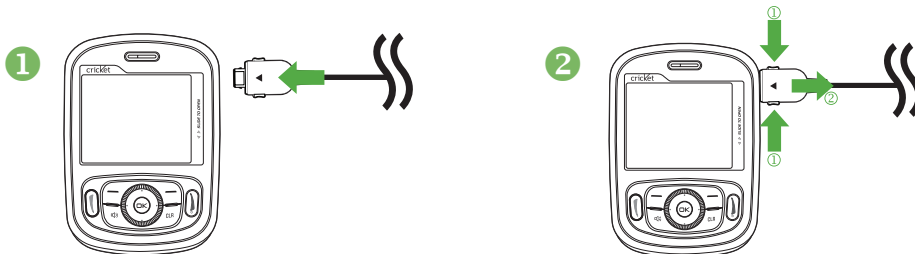

-  When you charge the battery with the phone power off, you will see a charging status screen. You cannot operate the phone until it is powered on.
- The battery is not fully charged at the time of purchase. Fully charge the battery before use.
- It is more efficient to charge the battery with the handset powered off.
- Battery operating time gradually decreases over time.
- If the battery fails to perform normally, you may need to replace the battery.

# Before Using

## BATTERY HANDLING INFORMATION

### DO'S

- Only use the battery and charger approved for use with the TXT8026.
- Only use the battery for its original purpose.
- Try to keep batteries in a temperature between 41 °F (5 °C) and 95 °F (35 °C).  
If the battery is stored in temperatures above or below the recommended range, give it time to warm up or cool down before using.
- Completely drain the battery before recharging.
- Store the discharged battery in a cool, dark, and dry place.
- Purchase a new battery when its operating time gradually decreases after fully charging.
- Properly dispose of the battery according to local laws.

### DON'TS

- Don't attempt to disassemble the battery – it is a sealed unit with no serviceable parts.
- Don't accidentally short circuit the battery by carrying it in your pocket or purse with other metallic objects such as coins, clips and pens.  
This may critically damage the battery.
- Don't leave the battery in extremely hot or cold temperatures. Otherwise, it could significantly reduce the capacity and lifetime of the battery.
- Don't dispose of the battery by placing into a fire.



# Basic Operation

## 2

**This chapter addresses and explains the basic features of your phone including:**

- Turning the phone on/off
- Accessing the menu
- Using the widgets menu
  - Menu summary
- Making a call
- Answering calls
- Missed call notification
- Wait/Pause feature
- Answering a call
  - 3-Way calling
- Call waiting function

- Calling a number from contacts
  - Adjusting volume
- Adjusting the call volume
- Caller ID function
- Vibrate on/off mode
- Speakerphone mode
- Using auto keypad lock function
- Available options during a call
- Making an emergency call
- Using the microSD card

# Basic Operation

## TURNING THE PHONE ON/OFF

### TURNING THE PHONE ON

1. Press and hold the END Key  until your display turns on and the tone sounds.

-  If "Enter Lock Code" appears on the display, enter your 4-digit lock code to unlock your phone.
- The default lock code is the last 4 digits of your mobile telephone number.





### TURNING THE PHONE OFF

1. Press the OK Key  [OK] to unlock the keypad, then press and hold the END Key  until your display turns off.

-  Immediately change or recharge the battery when "BATTERY LOW" appears on the display. Memory may possibly be damaged if the phone turns off due to the battery completely draining.
- Turn the phone off before removing or replacing the battery. If the phone is on, unsaved data may be lost.

## ACCESSING THE MAIN MENU

















Your phone can be customized via the menu. Each function can be accessed by scrolling with the Directional Key  or by pressing the number that corresponds with the menu item.

- To access the menu in idle mode, press the OK Key  [OK] to unlock the keypad, then press the Left Soft Key  [Menu].
- To scroll through the menu, press the Directional Key  up, down, left or right.
- To return to the previous page, press the CLR Key . To exit the current menu and return to the idle mode, press the END Key .

## USING THE WIDGETS MENU

The Widget scroll menu (located at the left of the Idle screen) provides quick access to Widget features (features like Horoscope, Storefront, My Account, Personalize, Weblinks, Weather, News, My Teams and Stocks) and keeps them organized and always accessible.

1. From idle mode, press the Directional Key  up or down to scroll through the Widgets Menu, then press the OK Key  [OK] to select the feature.

Widget Menu Icon	Widget Menu Descriptions
	<b>Horoscope:</b> View your daily horoscope.
	<b>Storefront:</b> Download your favorite Graphics, Ringtones, Themes and even Ringback tones.
	<b>My Account:</b> This option provides you with account specific information such as Balance Due, Date Due, Last Payment, Last Date and Flex Bucket.
	<b>Personalize:</b> You can Add, Delete, Change and Move from your Widgets Menu.
	<b>Weblinks:</b> Access Web services menu.
	<b>Weather:</b> Check out the current forecast in your city.
	<b>News:</b> Instantly access breaking news and top stories.
	<b>My Teams:</b> Get your favorite breaking sports news.
	<b>Stocks:</b> Access your favorite stocks information.
	<b>Browser Shortcut:</b> From idle mode, press the Directional Key  left to launch Browser.
	<b>Messages Shortcut:</b> From idle mode, press the Directional Key  right to access Messages Menu.
	<b>Information Sub Menu:</b> Select  to minimize information screen. Select  to refresh information. Select  to launch Browser and then setting to Personalize features.



# Basic Operation

2. The selected Widget menu will be displayed. The Widget menu icon is displayed on the left hand side of the display.
3. To scroll through the Widget sub options, press the Directional Key (⊙) up, down, left or right, then press the OK Key (OK).
4. To return to the previous step, press the CLR Key (CLR). To exit the current Widget sub menu and return to the idle mode, press the END Key (END) or press the Directional Key (⊙) up, down, left or right to select icon (↓). Press the OK Key (OK).

## Examples:



## ADD NEW WIDGET MENU ITEMS

1. From idle mode, press the Directional Key (⊙) up or down to select the Personalize Icon, then press the OK Key (OK) [OK].
2. Press the Directional Key (⊙) right to select the Configure Widgets option, then press the OK Key (OK) [OK].
3. Press the Directional Key (⊙) left or right to select Add shortcut + location, then press the OK Key (OK).
4. Press the Directional Key (⊙) up or down to scroll to the Widgets Catalog list.
5. Select the feature to add, then press the OK Key (OK).
6. Press the Directional Key (⊙) up or down to select the Add [Features Name], then press the OK Key (OK).

## REPLACE WIDGET MENU ITEM

1. From idle mode, press the Directional Key (⊙) up or down to select the Personalize Icon, then press the OK Key (OK) [OK].
2. Press the Directional Key (⊙) right to select the Configure Widgets option, then press the OK Key (OK) [OK].
3. Press the Directional Key (⊙) left or right to select the feature you want to replace.
4. Press the Directional Key (⊙) up or down to select Change, then press the OK Key (OK).
5. Press the Directional Key (⊙) up or down to scroll through the Widgets Catalog list.
6. Select the feature to replace, then press the OK Key (OK).
7. Press the Directional Key (⊙) up or down to select the Change to [Features Name], then press the OK Key (OK).

 The default Widget Menu items - Personalize, My Account and Storefront - cannot be Replaced.

## MOVE WIDGET MENU ITEM

1. From idle mode, press the Directional Key (⊙) up or down to select the Personalize Icon, then press the OK Key (OK) [OK].
2. Press the Directional Key (⊙) right to select the Configure Widgets option, then press the OK Key (OK) [OK].
3. Press the Directional Key (⊙) left or right to select the feature you want to move.
4. Press the Directional Key (⊙) up or down to select Move, then press the OK Key (OK).
5. Press the Directional Key (⊙) left or right to scroll to change the position.
6. Press the Directional Key (⊙) up or down to select Place, then press the OK Key (OK).

 The default Widget Menu items - Personalize, My Account and Storefront - cannot be Moved.

# Basic Operation

## REMOVE WIDGET MENU ITEMS

1. From idle mode, press the Directional Key (⊖) up or down to select the **Personalize** Icon, then press the OK Key (OK) [OK].
2. Press the Directional Key (⊖) right to select the **Configure Widgets** option, then press the OK Key (OK) [OK].
3. Press the Directional Key (⊖) left or right to select the feature you want to remove.
4. Press the Directional Key (⊖) up or down to select **Delete**, then press the OK Key (OK) [OK].
5. A confirmation window appears.
6. Press the Directional Key (⊖) up or down to select **Delete**, then press the OK Key (OK) [OK].

 The default Widget Menu items - Personalize, My Account and Storefront - cannot be Deleted.

## MENU SUMMARY

Main Menu	2 <sup>ND</sup> DEPTH	3 <sup>RD</sup> DEPTH	Main Menu	2 <sup>ND</sup> DEPTH	3 <sup>RD</sup> DEPTH
1. Recent Calls	<ol style="list-style-type: none"> <li>1. Missed Calls</li> <li>2. Received Calls</li> <li>3. Dialed Calls</li> <li>4. Blocked Calls ("Blocked Calls" appears only when the restriction for Incoming Calls is set.)</li> <li>5. All Calls</li> <li>6. Call Timers</li> </ol>		7. Tools/Utilities	<ol style="list-style-type: none"> <li>4. World Clock</li> <li>5. Notepad</li> <li>6. Stop Watch</li> <li>7. Voice Commands</li> <li>8. Voice Memo</li> </ol>	
2. Messages	<ol style="list-style-type: none"> <li>1. New Message</li> <li>2. Voicemail</li> <li>3. Inbox</li> <li>4. Sent</li> <li>5. Drafts</li> <li>6. Settings</li> <li>7. Erase</li> </ol>	<ol style="list-style-type: none"> <li>1. Text Message</li> <li>2. Picture Message</li> <li>1. Notification</li> <li>2. Entry Mode</li> <li>3. Auto Save</li> <li>4. Auto Erase</li> <li>5. Auto Receive</li> <li>6. Quick Text</li> <li>7. Voicemail #</li> <li>8. Callback #</li> <li>9. Signature</li> <li>1. Erase Inbox</li> <li>2. Erase Drafts</li> <li>3. Erase Sent</li> <li>4. Erase All</li> </ol>	9. Settings	<ol style="list-style-type: none"> <li>1. Sound Settings</li> <li>2. Display Settings</li> <li>3. Phone Settings</li> <li>4. Call Settings</li> <li>5. Memory</li> <li>6. Bluetooth</li> <li>7. Phone Info</li> </ol>	<ol style="list-style-type: none"> <li>1. Ringer Volume</li> <li>2. Call Sounds</li> <li>3. Msg Sounds</li> <li>4. Service Alerts</li> <li>5. Power On/Off</li> <li>6. Open/Close Sound</li> <li>7. Key Tone</li> <li>1. My Banner</li> <li>2. Backlight Duration</li> <li>3. Contrast</li> <li>4. Wallpaper</li> <li>5. Screensaver</li> <li>6. Menu Type</li> <li>1. Airplane Mode</li> <li>2. Language</li> <li>3. Menu Readout</li> <li>4. Message Readout</li> <li>5. Location</li> <li>6. Security</li> <li>1. Answer Options</li> <li>2. Auto Retry</li> <li>3. TTY Mode</li> <li>4. One Touch Dial</li> <li>5. Voice Privacy</li> <li>6. DTMF</li> <li>1. Save Options</li> <li>2. Internal Memory</li> <li>3. External Memory</li> <li>1. New Device</li> <li>1. My Number</li> <li>2. SW Version</li> </ol>
3. Contacts	<ol style="list-style-type: none"> <li>1. New Entry</li> <li>2. List Entries</li> <li>3. Message Groups</li> <li>4. Groups</li> <li>5. Speed Dials</li> <li>6. My Name Card</li> </ol>				
4. Camera	<ol style="list-style-type: none"> <li>1. Take a Picture</li> <li>2. Picture Gallery</li> </ol>				
5. Browser	<ol style="list-style-type: none"> <li>1. Connect Web</li> </ol>				
6. Games & Apps	<ol style="list-style-type: none"> <li>1. Games &amp; Apps</li> </ol>				
7. Tools/Utilities	<ol style="list-style-type: none"> <li>1. Calculator</li> <li>2. Calendar</li> <li>3. Alarm Clock</li> </ol>				

# Basic Operation

## MAKING A CALL

1. Slide out the QWERTY keyboard and from idle mode enter the phone number (include the area code if needed). Press the SEND Key .

-  To erase one digit at a time press the CLR Key .
-  To erase the entire number, press and hold the CLR Key .
- When you place or receive a call from phone numbers stored in your Contact list with an entry name, the name will be displayed.

2. To end a call, press the END Key .

-  If you activate the "Auto Retry" function, the phone will automatically re-dial the number (Refer to [page 44](#)).
- You can also place calls using Voice-Activated Dialing. Please refer to [page 34](#) for more details.

## ANSWERING CALLS

1. When your phone rings or vibrates, press the SEND Key  to answer the incoming call. (Depending on your phone's settings, you may also answer incoming calls by opening the phone or by pressing any key.)

-  When you place or receive a call from phone numbers stored in your Contact list with an entry name, the name will be displayed.

2. To ignore incoming calls, press the Right Soft Key  [Ignore].

If you want to turn off the call ringtone or vibration, press the Left Soft Key  [Quiet].



3. To end a call, press the END Key .

-  In "Auto Answer" mode, a call is automatically answered after a preset number of ring tones (Refer to [page 44](#)).





## MISSED CALL NOTIFICATION

When an incoming call is not answered, the Missed Call logo appears on the display.

### TO DISPLAY THE MISSED CALL ENTRY FROM THE NOTIFICATION SCREEN:

- Highlight the entry "View Now" and press the OK Key .  
To view the Missed Call entries later, highlight the entry "View Later" and press the OK Key .
- To dial the phone number, press the SEND Key .

### TO DISPLAY A MISSED CALL ENTRY FROM IDLE MODE:

- From idle mode, press the OK Key  [OK] to unlock the keypad, press the Left Soft Key  [Menu], then select "Recent Calls" menu.
- Slide out the QWERTY keyboard, then press "1. Missed Calls".
- Highlight the entry you wish to view, then press the OK Key  [OK].
- To dial the phone number, press the SEND Key .

## WAIT/PAUSE FEATURE





Pauses are used for automated systems (i.e., voice mail or calling cards). Insert a pause after a phone number and then enter another group of numbers. The second set of numbers is dialed automatically after the pause. This feature is useful for dialing into systems that require a code.

### HARD PAUSE (P)

The phone stops dialing until you press the OK Key  [SEND] to advance to the next number.



### 2 SEC PAUSE (T)

The phone waits 2 seconds before sending the next string of digits automatically.

- Slide out the QWERTY keyboard, and from idle mode enter the phone number.
- Press the Right Soft Key  [Options].
- Press the Directional Key  up or down to select the pause type, then the OK Key  [OK]. "2 Sec Pause/Hard Pause".
- Enter additional number(s) (pin number or credit card number).
- Press the SEND Key  to dial or the Left Soft Key  [Save].



# Basic Operation

## ANSWERING A CALL

1. If your phone is set to "Slide Open" for "Answer Options," simply open the phone to answer a call. If your phone is set to "Any Key" for "Answer Options," press any key to answer a call. If your phone is set to "Auto Answer" for "Answer Options," calls are answered automatically with a 5 second delay. If your phone is set to "Send Key" for "Answer Options," only press the SEND Key  to answer a call. For information on how to set your Answer Options, see [page 44](#).
2. To end a call, press the END Key .

## 3-WAY CALLING



With 3-Way Calling, you can talk to two people at the same time. When using this feature, the normal airtime rates will be applied for each of the two calls.

1. Slide out the QWERTY keyboard, enter the phone number you wish to call, then press the SEND Key .
2. Once you have established the connection, enter the second phone number you wish to call, then press the SEND Key  again.
3. When you're connected to the second party, press the SEND Key  again to begin your 3-Way call.







 If one of the people you called hangs up during your call, you and the remaining caller stay connected. If you initiated the call and are the first to hang up, all three calls are disconnected.







## CALL WAITING FUNCTION

If you are on a call and you receive another incoming call, you will hear two beeps and the caller's phone number will appear on the display. With Call Waiting, you may put the active call on hold while you answer the other incoming call. To use Call Waiting:

1. To answer another call while on the phone, press the SEND Key . This places the first call on hold. To switch back to the first caller, press the SEND Key  again.



## CALLING A NUMBER FROM CONTACTS

1. From idle mode, press the OK Key  [OK] to unlock the keypad, then press the Right Soft Key  [Contacts].
2. Press the Directional Key  up or down to select the Contacts entry then press the OK Key  [VIEW].
3. Press the Directional Key  up or down to select the phone number.
4. Press the SEND Key  to place the call.

 Pressing the Directional Key  up or down to select the "LIST ENTRIES" and then pressing the Send Key  will automatically dial the Default Number of the Contact entry. If multiple numbers are saved in the "LIST ENTRIES", press the Directional Key  up or down to select the "LIST ENTRIES" and then press the Directional Key  left or right to select the number you want to dial. Then, press the Send Key .



## ADJUSTING VOLUME

To adjust the master volume:

1. From idle mode, press the OK Key  [OK] to unlock the keypad, then press the Volume Keys  up or down.
2. Select one of the following options and press the OK Key  [SET] to save it.
  - Silent
  - Vibrate On
  - Level 1 ~ Level 5

 Press the Volume Keys  up or down to adjust Earpiece volume during a call.

## ADJUSTING THE CALL VOLUME

To adjust the earpiece volume during a call, press the Volume Keys  up or down. Press the Volume Keys  up to increase the volume level and the Volume Keys  down to decrease the level. In idle mode, you can also adjust the ringer volume by following the same steps.



## CALLER ID FUNCTION

Caller ID displays the number of the person calling when your phone rings. If the caller's identity is stored in Contacts, the name appears on the screen. The Caller ID is stored in the Recent Calls Menu.

# Basic Operation



## VIBRATE ON/OFF MODE

Vibrate Mode mutes key tones and activates an alert for an incoming call or message. To activate Vibrate Mode:

1. From idle mode, slide out the QWERTY keyboard, then press and hold the # Key .
2. To disable Vibrate Mode, from the idle screen press and hold the # Key  again.



## SPEAKERPHONE MODE

The Speakerphone feature lets you hear audio through the speaker and talk without holding the phone.

1. To activate the Speakerphone in idle mode or while on a call, press the Speakerphone Key . Conversely, press the Speakerphone Key  again to deactivate the Speakerphone.

## USING AUTO KEYPAD LOCK FUNCTION

To lock/unlock the keypad:

1. When the Slide is closed, the Side Keys and the Directional Key  are locked. To unlock them, press any key, "Press ok to unlock keypad" displays, then press the OK Key  [OK].

 You can also open the slide to unlock the keypad.

## AVAILABLE OPTIONS DURING A CALL

During a phone call, you can access the following features by pressing the Right Soft Key  [Options]:

### MUTE/UNMUTE

If you press Mute during a call, the person you are speaking with cannot hear you or any sounds from your side of the conversation. However, you can still hear them.

1. Press the Left Soft Key  [Mute/Unmute].

### TEXT MESSAGE

To send a Text Message (SMS) during a call:

1. Press the Right Soft Key  [Options], slide out the QWERTY keyboard, and press "1. Text Message".

### CONTACTS

To view your Contacts list during a call:

1. Press the Right Soft Key  [Options], slide out the QWERTY keyboard, and press "2. Contacts".

### RECENT CALLS

To view your Recent Calls list during a call:

1. Press the Right Soft Key  [Options], slide out the QWERTY keyboard, and press "3. Recent Calls".

### CONNECT BLUETOOTH

To access the Bluetooth menu during a call:

1. Press the Right Soft Key  [Options], slide out the QWERTY keyboard, and press "4. Connect Bluetooth".

 If an Audio device is connected, "To Phone/To Headset" is displayed in the options menu instead of "Bluetooth".

### SPEAKER PHONE ON/OFF

To activate the Speakerphone during a call:

1. Press the Right Soft Key  [Options], slide out the QWERTY keyboard, and press "5. Speaker Phone On/Off".



# Basic Operation

## MAKING AN EMERGENCY CALL

The 911 feature automatically places the phone in the Emergency Call Mode when you dial the preprogrammed emergency number, 911. It also operates in Lock Mode and out of the service area.

### 911 IN LOCK MODE

To make an Emergency Call in Lock Mode:

1. Slide out the QWERTY keyboard, enter "911", then press the SEND Key (📞).
2. The call connects.
3. The phone maintains Emergency Mode for 5 minutes. When the call ends, the phone returns to Lock Mode.

### 911 USING ANY AVAILABLE SYSTEM

To make an Emergency Call using any available system:

1. Slide out the QWERTY keyboard, enter "911", then press the SEND Key (📞).
2. The call connects.
3. The phone will stay in Emergency Mode for 5 minutes. While the phone is in Emergency Mode, the phone can receive an incoming call from any available system or you can make outgoing calls even in Emergency Callback Mode. In this case, making a call can automatically end the Emergency Callback Mode.

 The 911 call does not appear in the Recent Call list.

## USING THE microSD CARD

The microSD card stores sounds, images, photos, music, and other files.

 The microSD card is sold separately and is not included with your phone.

### INSTALLING THE microSD CARD

To install a microSD card:

1. With the microSD card slot opened and the gold contacts facing down, insert the microSD card into the slot.
2. Push the card in until it clicks into place. "Memory card detected" will appear on the display. Close the microSD card slot.

 To prevent possible damages, please keep microSD card slot closed at all times regardless of whether the microSD card is inserted or not.

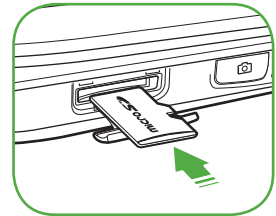

### REMOVING THE microSD CARD

To remove the microSD card:

1. Open the microSD card slot. Use your thumb to press and release the microSD card. It will pop-out allowing you to remove the card.
2. Remove the card and close the microSD card slot.
  - When you insert the microSD card, make sure contact terminals are facing down.
  - Do not remove the microSD card while reading or writing files. Otherwise it could be damaged.



- Only use a microSD card with your TXT8026.
- The microSD cards with more than 4GB storage capacity may cause a decrease in the phone performance.



## HOW IS MUSIC TRANSFERRED?

	Transfer from PC to Handset via USB Cable	Transfer from PC to Handset via Memory card
MP3 Songs	Yes	Yes



# Memory Function



**This chapter addresses memory functions including:**





Storing a phone number  
Entering letters, numbers & symbols  
One, Two-touch dialing

# Memory Function

## STORING A PHONE NUMBER

The Contact List stores up to 1,000 entries.

### ADDING A NEW ENTRY





1. From idle mode, slide out the QWERTY keyboard, then enter the phone number you want to save.
2. Press the Left Soft Key  [Save].
3. Press the Directional Key  up or down to select "New Entry", then press the OK Key  [OK].
4. Press the Directional Key  up or down to select the type of phone number you want to save, then press the OK Key  [OK].  
Mobile/Home/Work/Mobile 2/Fax

 Use Existing Entry to add another phone number to a contact already stored in memory.

5. Enter a name for the phone number (up to 32 characters), then press the OK Key  [SAVE].
6. "Entry saved" appears, then the phone returns to idle mode.







### OPTIONS TO CUSTOMIZE YOUR CONTACTS

Once the basic phone number and name information is stored in your Contacts, you can edit and/or customize the entries.

1. From idle mode, press the OK Key  [OK] to unlock the keypad, press the Right Soft Key  [Contacts], then press the Directional Key  up or down to highlight the Contacts entry you want to edit.
2. Press the Left Soft Key  [Edit] to access the Edit Entry screen.
3. Press the Directional Key up or down to highlight the information field you want to customize. Additional fields include:  
Name/Mobile/Home/Work/E-mail 1/Group/Picture/Ringtone/Mobile 2/Fax/E-mail 2
4. Slide out the QWERTY keyboard, change the data as necessary, then press the OK Key  [SAVE] to save.









### CHANGING GROUPS

To organize your contacts into groups:

1. From idle mode, press the OK Key  [OK] to unlock the keypad, press the Right Soft Key  [Contacts], then press the Directional Key  up or down to highlight an entry.
2. Press the Left Soft Key  [Edit].
3. Press the Directional Key  up or down to highlight "Group".
4. Press the Directional Key  left or right to select the group.  
No Group/Family/Friends/Colleagues/Business
5. Press the OK Key  [SAVE] to save.

### CHANGING THE CALL RINGTONE

To identify who is calling by setting different ringtones for different contacts in your Contact List:

1. From idle mode, press the OK Key  [OK] to unlock the keypad, press the Right Soft Key  [Contacts], then press the Directional Key  up or down to highlight an entry.
2. Press the Left Soft Key  [Edit].
3. Press the Directional Key  up or down to highlight "Ringtone", then press the Right Soft Key  [Add].
4. Press the Directional Key  up or down to select the new ringtone, then press the OK Key  [OK].

 Press the Left Soft Key  [Play] to listen to a highlighted ringtone before you press the OK Key  [OK]. Press the Right Soft Key  [Options], then select "File Info" to display selected ringtone information.

5. Press the OK Key  [SAVE] to save.













# Memory Function







## ADDING OR CHANGING THE PICTURE ID

To select a picture or graphic to assign to a Caller ID:

1. From idle mode, press the OK Key  [OK] to unlock the keypad, press the Right Soft Key  [Contacts], then press the Directional Key  up or down to highlight an entry.
2. Press the Left Soft Key  [Edit].
3. Press the Directional Key  up or down to highlight "Picture", then press the Right Soft Key  [Add].
4. Press the Directional Key  up, down, left or right to select a picture, then press the OK Key  [OK].
5. When completed, press the OK Key  [SAVE] to save.











## ADDING OR CHANGING AN E-MAIL ADDRESS

To enter or add an E-mail address to a Contact entry:







1. From idle mode, press the OK Key  [OK] to unlock the keypad, press the Right Soft Key  [Contacts], then press the Directional Key  up or down to highlight an entry.
2. Press the Left Soft Key  [Edit].
3. Press the Directional Key  up or down to highlight "E-mail 1" or "E-mail 2".
4. Slide out the QWERTY keyboard, enter an E-mail address, then press the OK Key  [SAVE] to save.

## EDITING CONTACT ENTRIES







### ADDING A PHONE NUMBER FROM IDLE MODE

1. From idle mode, slide out the QWERTY keyboard, and then enter the phone number you want to save (up to 32 digits).
2. Press the Left Soft Key  [Save].
3. Press the Directional Key  up or down to highlight "Existing Entry", then press the OK Key  [OK].
4. Press the Directional Key  up or down to highlight the existing Contacts entry, then press the OK Key  [OK].
5. Press the Directional Key  up or down to highlight the phone number type, then press the OK Key  [OK].  
Mobile/Home/Work/Mobile 2/Fax
6. If a phone number is already assigned to the item you selected, press the Left Soft Key  [No] or Right Soft Key  [Yes].  
If nothing is currently assigned to the phone number item, press the OK Key  [OK].
7. "Entry updated" appears, then the phone returns to idle mode.





### ADDING A PHONE NUMBER FROM THE CONTACT LIST SCREEN

1. From idle mode, press the OK Key  [OK] to unlock the keypad, then press the Right Soft Key  [Contacts]. Your Contact entries display alphabetically.
2. Press the Directional Key  up or down to highlight the Contacts entry you want to edit, then press the Left Soft Key  [Edit].
3. Press the Directional Key  up or down to highlight the phone number field you want to add, slide out the QWERTY keyboard, enter the number, then press the OK Key  [SAVE] to save. A confirmation message appears.

### EDITING STORED PHONE NUMBERS

1. From idle mode, press the OK Key  [OK] to unlock the keypad, then press the Right Soft Key  [Contacts]. Your Contact entries display alphabetically.
2. Press the Directional Key  up or down to highlight the Contacts entry you want to edit, then press the Left Soft Key  [Edit].
3. Press the Directional Key  up or down to highlight the phone number.
4. Slide out the QWERTY keyboard, edit the phone number as necessary, then press the OK Key  [SAVE].







### EDITING STORED NAMES

1. From idle mode, press the OK Key  [OK] to unlock the keypad, then press the Right Soft Key  [Contacts]. Your Contact entries display alphabetically.
2. Press the Directional Key  up or down to highlight the Contacts entry you want to edit, then press the Left Soft Key  [Edit].
3. Slide out the QWERTY keyboard, edit the name as necessary, then press the OK Key  [SAVE].





# Memory Function

## DELETING

### DELETING A PHONE NUMBER FROM A CONTACT ENTRY

1. From idle mode, press the OK Key  [OK] to unlock the keypad, then press the Right Soft Key  [Contacts]. Your Contact entries display alphabetically.
2. Press the Directional Key  up or down to highlight the Contact entry, then press the Left Soft Key  [Edit].
3. Press the Directional Key  up or down to highlight the phone number to be deleted.
4. Press and hold the Clear Key  to delete the number.
5. Press the OK Key  [SAVE]. A confirmation message appears.







### DELETING A CONTACTS ENTRY

1. From idle mode, press the OK Key  [OK] to unlock the keypad, then press the Right Soft Key  [Contacts].
2. Press the Directional Key  up or down to highlight the Contact entry to be deleted.
3. Press the Right Soft Key  [Options].
4. Slide out the QWERTY keyboard, then press "3. Erase".
5. Press the Right Soft Key  [Yes]. A confirmation message appears.

## ENTERING LETTERS, NUMBERS & SYMBOLS

Your device has a QWERTY keyboard that provides a superior typing experience on a small handheld device for easy and comfortable input. You can use all of the handset functions with the keyboard either closed or open. When you slide out the keyboard, you have the extra benefit of a full messaging keyboard. Your device has dictionaries for English. The appropriate dictionary is activated automatically when you select a language on your device.

Your device uses the active dictionary to suggest corrections or complete the word you're typing.

1.  **Mode Change Key:** When in a Text entry field and in entry mode, press to change between entering numbers and letters that appear on the same key. Press and hold to lock in numeric mode or text entry mode.
2.  **Space Key:** Press to add a space.
3.  **Symbols Key:** Press to open symbols list.
4.  **Caps Key:** Press to select a letter case for the standard text [Abc] input mode. [Abc], [ABC] and [abc] indicate the standard text input.
5.  **Enter Key:** Press to insert a carriage return.
6.  **Del Key:** When in a Text entry field and in entry mode, press to delete the character to the left of the cursor. Press and hold to delete the entire word or character string that was just entered.
7.  **CLR Key:** When in a Text entry field and in entry mode, press to delete the character to the left of the cursor. Press and hold to delete the entire word or character string that was just entered.

 For best performance in low-light environments, your handset includes a backlight feature that can illuminate both the display and the keyboard so you can keep reading and typing. (Please refer to [page 41](#) for more details on "Backlight Duration".)

## ONE, TWO-TOUCH DIALING

Ideal for frequently dialed numbers, this feature allows Contact entries to be dialed via the keypad with only one or two key presses.

### ONE-TOUCH DIALING:

**1-9:** Slide out the QWERTY keyboard, and then press and hold the number you wish to connect to for more than 1 second.

### TWO-TOUCH DIALING:

**10-20:** Slide out the QWERTY keyboard, and then press the first digit, then press and hold the second digit of the number to dial.

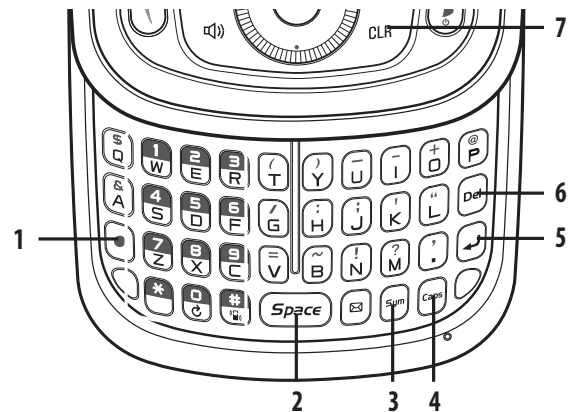

# Menu Function

## 4

**This chapter addresses accessing the menu and using its functions and features to customize your phone.**

- Recent calls
- Missed calls
- Received calls
- Dialed calls
- All calls
- Call timers
- New entry
- List entries
- Message groups
- Groups
- Speed dials
- My name card
- Camera
- Starting Browser
- Mobile Web menu

- Starting Games & Apps
- Downloading Applications
- Downloading melodies/  
wallpapers
- Applying melodies/  
wallpapers
- Checking data folder  
memory
- Delete Application
- Calculator
- Calendar
- Alarm clock
- World clock
- Notepad
- Stop watch



- Voice commands
- Voice commands settings
- Voice commands info
- Voice memo
- Sound box
- Picture box
- MP3 box
- Sound settings
- Display settings
- Phone settings
- Call settings
- Memory
- Bluetooth
- Phone info

# Recent Calls

## RECENT CALLS

The Recent Calls menu is a list of the last phone numbers or Contact entries for calls you placed, accepted or missed. It is continually updated as new numbers are added to the beginning of the list and the oldest entries are removed from the bottom of the list.









### ACCESS AND OPTIONS

1. From idle mode, press the OK Key  [OK] to unlock the keypad, then press the Left Soft Key  [Menu].
2. Press the Directional Key  to select the “Recent Calls” menu.
3. Select a submenu.
  1. Missed Calls
  2. Received Calls
  3. Dialed Calls
  4. Blocked Calls
  5. All Calls
  6. Call Timers

 “Blocked Calls” appears only when the restriction for Incoming Calls is set.

## MISSED CALLS









Displays information about the 90 most recently missed calls. Place a call to a missed call by simply pressing the SEND Key .

1. From idle mode, press the OK Key  [OK] to unlock the keypad, press the Left Soft Key  [Menu], the Directional Key  to select “Recent Calls”, then slide out the QWERTY keyboard and press 1. Missed Calls.
2. Press the Directional Key  up or down to highlight an entry, then:
  - Press the OK Key  [OK] to view the entry.
  - Press the SEND Key  to place a call to the number.
  - Press the Right Soft Key  [Options] to select:
    - Save:** To store the phone number in your Contacts.
    - Prepend:** To add a desired number before the number.  
For example, it is useful when adding “1” for a long distance call. You may save it in Contacts after entering the Prepend.
    - Text Message:** To send a Text message to the Contact.
    - Picture Message:** To send a Picture message to the Contact.
    - Erase All:** To erase all Missed Call entries.
  - Press the Left Soft Key  [Erase] to erase a call listing.

 After 90 missed calls, the oldest call will automatically be erased from the history.

## RECEIVED CALLS

Displays information about the 90 most recently received calls. Place a call to a received call by simply pressing the SEND Key .

1. From idle mode, press the OK Key  [OK] to unlock the keypad, press the Left Soft Key  [Menu], the Directional Key  to select “Recent Calls”, then slide out the QWERTY keyboard and press 2. Received Calls.
2. Press the Directional Key  up or down to highlight an entry, then:
  - Press the OK Key  [OK] to view the entry.
  - Press the SEND Key  to place a call to the number.
  - Press the Right Soft Key  [Options] to select:
    - Save:** To store the phone number in your Contacts.
    - Prepend:** To add a desired number before the number.  
For example, it is useful when adding “1” for a long distance call. You may save it in Contacts after entering the Prepend.
    - Text Message:** To send a Text message to the Contact.
    - Picture Message:** To send a Picture message to the Contact.
    - Erase All:** To erase all Received Call entries.
  - Press the Left Soft Key  [Erase] to erase a call listing.









 After 90 received calls, the oldest call will automatically be erased from the history.



# Recent Calls

## DIALED CALLS









Displays information about the 90 most recently dialed numbers. Place a call to a dialed call by simply pressing the SEND Key .

1. From idle mode, press the OK Key  [OK] to unlock the keypad, press the Left Soft Key  [Menu], the Directional Key  to select "Recent Calls", then slide out the QWERTY keyboard and press 3. [Dialed Calls](#).
2. Press the Directional Key  up or down to highlight an entry, then:
  - Press the OK Key  [OK] to view the entry.
  - Press the SEND Key  to place a call to the number.
  - Press the Right Soft Key  [Options] to select:
    - Save:** To store the phone number in your Contacts.
    - Prepend:** To add a desired number before the number.  
For example, it is useful when adding "1" for a long distance call. You may save it in Contacts after entering the Prepend.
    - Text Message:** To send a Text message to the Contact.
    - Picture Message:** To send a Picture message to the Contact.
    - Erase All:** To erase all Dialed Call entries.
  - Press the Left Soft Key  [Erase] to erase a call listing.

 After 90 dialed calls, the oldest call will automatically be erased from the history.

## BLOCKED CALLS

This menu appears only when the restriction for Incoming Calls is set.

1. From idle mode, press the OK Key  [OK] to unlock the keypad, press the Left Soft Key  [Menu], the Directional Key  to select "Recent Calls", then slide out the QWERTY keyboard and press 4. [Blocked Calls](#).
2. Press the Directional Key  up or down to highlight an entry, then:
  - Press the OK Key  [OK] to view the entry.
  - Press the SEND Key  to place a call to the number.
  - Press the Right Soft Key  [Options] to select:
    - Prepend:** To add a desired number before the number.  
For example, it is useful when adding "1" for a long distance call. You may save it in Contacts after entering the Prepend.
    - Text Message:** To send a Text message to the Contact.
    - Picture Message:** To send a Picture message to the Contact.
    - Erase All:** To erase all Blocked Call entries.
  - Press the Left Soft Key  [Erase] to erase a call listing.









 After 90 blocked calls, the oldest call will automatically be erased from the history. Please refer to [page 43](#) for more details on "Restrict".





# Recent Calls

## ALL CALLS

Displays information about the most recently received, dialed and missed calls.







1. From idle mode, press the OK Key  [OK] to unlock the keypad, press the Left Soft Key  [Menu], the Directional Key  to select "Recent Calls", then slide out the QWERTY keyboard and press 5. All Calls.
2. Press the Directional Key  up or down to highlight an entry, then:
  - Press the OK Key  [OK] to view the entry.
  - Press the SEND Key  to place a call to the number.
  - Press the Right Soft Key  [Options] to select:
    - Save:** To store the phone number in your Contacts.
    - Prepend:** To add a desired number before the number.  
For example, it is useful when adding "1" for a long distance call. You may save it in Contacts after entering the Prepend.
    - Text Message:** To send a Text message to the Contact.
    - Picture Message:** To send a Picture message to the Contact.
    - Erase All:** To erase all All Call entries.
  - Press the Left Soft Key  [Erase] to erase a call listing.

 After the 270th received, dialed or missed calls, the oldest call will automatically be erased from the history.

 **Shortcut:** To view a quick list of all your calls, press the SEND Key  from idle mode.

## CALL TIMERS

Checks the usage time and manages your calls within the limit you set. The 11 timers include (Last Call, All Calls, Received Calls, Dialed Calls, Home Calls, Roaming Calls, Transmit KB, Incoming KB, Total KB, Lifetime Calls, Lifetime Data Counter):

1. From idle mode, press the OK Key  [OK] to unlock the keypad, press the Left Soft Key  [Menu], the Directional Key  to select "Recent Calls", then slide out the QWERTY keyboard and press 6. Call Timers.
2. Press the Directional Key  up or down to highlight a call timer. Call timers include:  
**Last Call/All Calls/Received Calls/Dialed Calls/Home Calls/Roaming Calls/Transmit KB/Incoming KB/Total KB/Lifetime Calls/Lifetime Data Counter**
  - Press the Left Soft Key  [Reset] to reset selected timer.
  - Press the Right Soft Key  [Reset All] to reset all timers.











# Contacts

Entries can be retrieved by name or group.

## NEW ENTRY

To add a new number to your Contact List:









 Using this submenu, the number is saved as a new Contact entry. To save the number into an existing Contact entry, edit the Contact entry.

1. From idle mode, press the OK Key  [OK] to unlock the keypad, press the Left Soft Key  [Menu], the Directional Key  to select "Contacts", then slide out the QWERTY keyboard and press **1. New Entry**.
2. In the Name field, enter the name to add to your Contact List. To change the input mode, press the Left Soft Key  [Abc].
3. Press the Directional Key  down to enter information in other fields for the entry. Fields include:  
**Mobile/Home/Work/E-mail 1/Group/Picture/Ringtone/Mobile 2/Fax/E-mail 2**  
If entering information in a phone number field, press the Right Soft Key  [Options] to select one of the following options:  
**1. Hard Pause/2. 2 Sec Pause**
4. Press the OK Key  [SAVE].

 For additional details on how to add a new Contact entry, see [page 16](#).

## LIST ENTRIES





You can review all the entries stored in your Contact List or quickly find an entry by entering a name or its character string.

1. From idle mode, press the OK Key  [OK] to unlock the keypad, press the Left Soft Key  [Menu], the Directional Key  to select "Contacts", then slide out the QWERTY keyboard and press **2. List Entries**. Or in idle mode, press the Right Soft Key  [Contacts]. The list of names in your Contact List is displayed alphabetically.
2. Enter a name or part of a name in the **Search** field at the bottom of the screen or press the Directional Key  up or down to scroll through your Contact List.
3. To edit the entry, press the Left Soft Key  [Edit]. To view entry details, press the OK Key  [VIEW].
  - By pressing the Right Soft Key  [Options], you can choose from the following:
    - 1. New Entry:** To add a New Phone Number.
    - 2. Prepend:** To add a desired number before the number. For example, it is useful when adding "1" for a long distance call. You may save it in Contacts after entering the Prepend.
    - 3. Erase:** To delete the entry.
    - 4. Text Message:** To create a Text Message.
    - 5. Picture Message:** To create a Picture Message.
    - 6. Erase All:** To delete all Contact entries.
4. To call the selected number, press the SEND Key .





## MESSAGE GROUPS

Allows the user to create a message group with up to 10 phone numbers. The user can add, change, and delete Message Groups.

### TO ADD NEW MESSAGE GROUP



1. From idle mode, press the OK Key  [OK] to unlock the keypad, press the Left Soft Key  [Menu], the Directional Key  to select "Contacts", then slide out the QWERTY keyboard and press **3. Message Groups**.
2. Press the Left Soft Key  [New].
3. Enter a new message group name, then press the OK Key  [SAVE].

### TO ASSIGN PHONE NUMBER TO GROUP







1. From idle mode, press the OK Key  [OK] to unlock the keypad, press the Left Soft Key  [Menu], the Directional Key  to select "Contacts", then slide out the QWERTY keyboard and press **3. Message Groups**.
2. Press the Directional Key  up or down to select the group where you want to add the entry, and then press the Right Soft Key  [Options].
3. Select "Add".









# Contacts

4. Your Contact entries will be displayed in alphabetical order. Select the entry you want to add then press the Left Soft Key  [Mark/Unmark].
5. Press the OK Key  [OK]. "Entry added to message group" will be displayed.









## TO CHANGE GROUP NAME

1. From idle mode, press the OK Key  [OK] to unlock the keypad, press the Left Soft Key  [Menu], the Directional Key  to select "Contacts", then slide out the QWERTY keyboard and press 3. Message Groups.
2. Press the Directional Key  up or down to select the message group you want to rename then press the Right Soft Key  [Options]. The default groups Family, Friends, Colleagues and Business cannot be changed.
3. Select "Rename".
4. Enter the new group name, then press the OK Key  [SAVE].















## ERASE GROUP

1. From idle mode, press the OK Key  [OK] to unlock the keypad, press the Left Soft Key  [Menu], the Directional Key  to select "Contacts", then slide out the QWERTY keyboard and press 3. Message Groups.
2. Press the Directional Key  up or down to select the existing message group name that you want to erase, and then press the Right Soft Key  [Options]. The default groups Family, Friends, Colleagues and Business cannot be erased.
3. Select "Erase". "Erase message group?" will appear on the screen.
4. Press the Right Soft Key  [Yes]. A confirmation message appears.

## TO SEND A TEXT MESSAGE TO A GROUP

1. From idle mode, press the OK Key  [OK] to unlock the keypad, press the Left Soft Key  [Menu], the Directional Key  to select "Contacts", then slide out the QWERTY keyboard and press 3. Message Groups.
2. Press the Directional Key  up or down to select the message group you want to send a message to then press the Right Soft Key  [Options].
3. Press "1. Text Message".
4. Input your message in the Text Field and then press the Right Soft Key  [Options] to select "Read Message", "Save As Draft", "Add Quick Text", "Priority Level" or "Cancel Message".
5. To send the text message, press the OK Key  [SEND] or press the SEND Key .

## TO SEND A PICTURE MESSAGE TO A GROUP

1. From idle mode, press the OK Key  [OK] to unlock the keypad, press the Left Soft Key  [Menu], the Directional Key  to select "Contacts", then slide out the QWERTY keyboard and press 3. Message Groups.
2. Press the Directional Key  up or down to select the message group you want to send a message to then press the Right Soft Key  [Options].
3. Press "2. Picture Message".
4. Under "Text", input your message and then press the Directional Key  down.
5. Under "Picture", press the Left Soft Key  [Add] to select the picture you would like to send then press the OK Key  [OK].
6. Under "Sound", press the Left Soft Key  [Add] to select the sound you would like to send then press the OK Key  [OK].
7. Under "Subject", input a subject and then press the Directional Key  down.
8. Under "Name Card", press the Left Soft Key  [Add] and scroll to My Name Card or Contacts and press the OK Key  [OK]. Select the card or the contact, then press the OK Key  [OK].
9. Press the Right Soft Key  [Options] to select "Preview", "Read Message", "Save As Draft", "Add Quick Text", "Add Slide", "Priority Level", "Remove Picture", "Remove Slide", "Remove Sound", "Remove Name Card" or "Cancel Message".

 These options will vary depending on the message contents chosen.

10. To send the picture message, press the OK Key  [SEND] or press the SEND Key .





# Contacts







## GROUPS

Groups allows you to classify phone entries into groups. The default groups include No Group, Family, Friends, Colleagues and Business and they cannot be erased or renamed.







### TO ADD NEW GROUP

1. From idle mode, press the OK Key  [OK] to unlock the keypad, press the Left Soft Key  [Menu], the Directional Key  to select "Contacts", then slide out the QWERTY keyboard and press 4. [Groups](#).
2. Press the Left Soft Key  [New].
3. Enter a new group name, then press the OK Key  [SAVE].

### TO CHANGE GROUP NAME











1. From idle mode, press the OK Key  [OK] to unlock the keypad, press the Left Soft Key  [Menu], the Directional Key  to select "Contacts", then slide out the QWERTY keyboard and press 4. [Groups](#).
2. Press the Directional Key  up or down to select the group you want to rename then press the Right Soft Key  [Options].
3. Select "Rename".
4. Enter the new group name, then press the OK Key  [SAVE].

### ERASE GROUP

1. From idle mode, press the OK Key  [OK] to unlock the keypad, press the Left Soft Key  [Menu], the Directional Key  to select "Contacts", then slide out the QWERTY keyboard and press 4. [Groups](#).
2. Press the Directional Key  up or down to select the existing group name that you want to erase, then press the Right Soft Key  [Options].
3. Select "Erase". "Erase group?" will appear on the screen.
4. Press the Right Soft Key  [Yes]. A confirmation message appears.







## SPEED DIALS

In idle mode, calls can be placed to numbers stored in speed dial by sliding out the QWERTY keyboard, and pressing & holding the location number on the keypad. For a 2-digit location number, press the first number and then press and hold the second number. Speed Dial 1 is assigned to Voice Mail and cannot be changed.

1. From idle mode, press the OK Key  [OK] to unlock the keypad, press the Left Soft Key  [Menu], the Directional Key  to select "Contacts", then slide out the QWERTY keyboard and press 5. [Speed Dials](#).
2. Press the Directional Key  up or down to highlight the Speed Dial position, or enter the Speed Dial digit, then press the OK Key  [SET].
3. Press the Directional Key  up or down to highlight the entry then press the OK Key  [OK].
4. Press the Directional Key  up or down to highlight the number you wish to select then press the OK Key  [OK].
5. Press the Right Soft Key  [Yes]. A confirmation message appears.

 "Unassigned" appears if the location is available.

### TO ERASE A SAVED SPEED DIAL





1. From idle mode, press the OK Key  [OK] to unlock the keypad, press the Left Soft Key  [Menu], the Directional Key  to select "Contacts", then slide out the QWERTY keyboard and press 5. [Speed Dials](#).
2. Press the Directional Key  up or down to select the Speed Dial entry you want to erase.
3. Press the Left Soft Key  [Erase].
4. Press the Right Soft Key  [Yes]. A confirmation message appears.

# Contacts

## MY NAME CARD









A Name Card with the handset's mobile number automatically appears.

## EDIT MY NAME CARD

1. From idle mode, press the OK Key  [OK] to unlock the keypad, press the Left Soft Key  [Menu], the Directional Key  to select "Contacts", then slide out the QWERTY keyboard and press **6. My Name Card**.
2. Press the Left Soft Key  [Edit].
3. Edit the "My Name Card" options and press the OK Key  [SAVE] to save your changes.

## SEND MY NAME CARD TO ANOTHER BLUETOOTH DEVICE

 Turn on Bluetooth on both devices and turn Discovery Mode to On.

1. From idle mode, press the OK Key  [OK] to unlock the keypad, press the Left Soft Key  [Menu], the Directional Key  to select "Contacts", then slide out the QWERTY keyboard and press **6. My Name Card**.
2. Press the Right Soft Key  [Send].
3. Scroll to "Send by Bluetooth" and press the OK Key  [OK].
4. With New Device selected, press the OK Key  [OK]. The handset will prompt you with the following message on the LCD screen: "Place device you are connecting to in discoverable mode". Press the OK Key  [OK].
5. Scroll to the desired device and press the Left Soft Key  [PAIR].
6. If applicable, the device may prompt you for the Password. Consult the Bluetooth® accessory (sold separately) instructions for the appropriate password (typically 0000 - 4 zeroes). Enter the password and press the OK Key  [OK].
7. The information is then sent via Bluetooth to the receiving device.





# Camera



## CAMERA

### TAKE PICTURE





1. From idle mode, press the OK Key  [OK] to unlock the keypad, press the Left Soft Key  [Menu], the Directional Key  to select "Camera", then slide out the QWERTY keyboard and press **1. Take a Picture**. Or, to access the camera, press the Side Camera Key  when slide is opened.

 When the slide is closed and you press the Side Camera Key , you may get the message that you need to unlock the keypad. Press the OK Key  [OK].

2. Point the camera lens at your subject. You can check the picture framing through the display screen.





- Press the Directional Key  left/right: Zoom Down/Up. (Except 1280X960 mode).
- Pressing the Right Soft Key  [Options], you can choose from the following:
  1. **Self Timer:** To activate the camera's timer function. (Off/3 Seconds/5 Seconds/10 Seconds)
  2. **Image Controls...:**
    - **Brightness:** To adjust brightness up/down(-2, -1, 0, 1, 2).
    - **White Balance:** To select a white tone balance. (Auto/Sunny/Cloudy/Tungsten/Fluorescent)
    - **Color Effect:** To select picture effects. (Normal/Gray/Sepia/Negative)
  3. **Settings...:**
    - **Resolution:** To select a resolution for a picture. (1280x960/640x480/320x240/160x120)
    - **Quality:** To select a picture quality. (High/Medium/Low)
    - **Shutter Sound:** To select a shutter sound. (Default/Say "Cheese"/Ready! 123)

 To view captured images, press the Left Soft Key  [Gallery].







3. Press the Side Camera Key  or press the OK Key  [TAKE] to take the picture.
4. After taking the picture it will be displayed.
  - To save the picture, press the Left Soft Key  [Save].
  - To take another picture without saving the picture you just took, press the Right Soft Key  [Erase].
  - To send the picture to someone, press the OK Key  [SEND].

### PICTURE GALLERY

In My Pictures you can view all the pictures you have taken, store selected images in your phone, delete images and access additional picture options.

1. From idle mode, press the OK Key  [OK] to unlock the keypad, press the Left Soft Key  [Menu], the Directional Key  to select "Camera", then slide out the QWERTY keyboard and press **2. Picture Gallery**.
2. Press the Directional Key  up, down, left or right to select your desired pictures, then press the Right Soft Key  [Options].
3. Select one of the following options:
  - **Set As:** Assigns the selected picture to display for specific tasks. (Wallpaper, Screensaver, Picture ID)
  - **Send:** To send a picture message.
  - **Send Online Album:** To upload selected picture(s) to picture online server.
  - **Rename:** Rename the selected picture.
  - **Lock/Unlock:** Select to lock or unlock the selected picture.
  - **Move:** To move the picture to another location. This only appears when a memory card is inserted.
  - **Erase All:** To erase all the pictures in your phone. (Internal Memory/External Memory)
  - **File Info:** Displays information about the selected picture. (File Name/Date/Time/Resolution/Size)

### TO ERASE THE CURRENT PICTURE

1. From idle mode, press the OK Key  [OK] to unlock the keypad, press the Left Soft Key  [Menu], the Directional Key  to select "Camera", then slide out the QWERTY keyboard and press **2. Picture Gallery**.
2. Press the Directional Key  up, down, left or right to select the picture you want to erase, then press the Left Soft Key  [Erase]. "Erase Picture file?" will appear on your display.
3. Press the Right Soft Key  [Yes]. A confirmation message appears.

# Browser

## STARTING BROWSER

### LAUNCHING MOBILE WEB 2.0

Now you can access news, sports, weather, and e-mail from your TXT8026. Mobile Web 2.0 keeps you updated by providing access to up-to-date information such as news, sports, weather and stock quotes when you subscribe to Internet service with your service provider. Please contact your service provider for a list of available websites and service details.

1. From idle mode, press the OK Key  [OK] to unlock the keypad, press the Left Soft Key  [Menu], the Directional Key  to select "Browser", then slide out the QWERTY keyboard and press **1. Connect Web**.

 **Shortcut:** In idle mode, press the Directional Key  left to access Browser.

## MOBILE WEB MENU

### MOBILE WEB MENU

The Mobile Web menu lists the actions necessary to operate Mobile Web. To access the Mobile Web menu, press the Left Soft Key  [Menu], **Browser, 1. Connect Web**. Or in idle mode, press the Directional Key  left to access Browser.

#### HOME

Returns the user to the home page.

#### BACK

Returns to the previously viewed page.

#### FORWARD

To forward to the next page.

#### GO TO URL

To access the Web site directly by entering the address.

#### REFRESH

To refresh the current page.

#### HISTORY

To view a list of Web pages and Web addresses that you have visited or tried to visit.

#### SHOW URL

To display the URL address of the page to which you are currently connected.

#### MANAGE MEMORY

Select this option to manage the browser memory including:

- **Clear Cache:** Clears the cache.
- **Clear History:** Clears the list of recently visited URLs.
- **Clear Cookies:** Clears saved cookies.
- **Autofill:** Automatically fills in character for browser recognized words.

#### SETTINGS

Select this option to access:

- **Downloads:** Selecting the "Downloads" item allows the user to enable/disable downloading images, background sounds, and object downloads when a URL is accessed.
- **Restart Browser:** Selecting "Restart Browser" causes the history and cache to be cleared and returns the user to the homepage.
- **Scroll Mode:** Selecting "Scroll Mode" from the Settings menu allows the user to select the way text scrolls and the scroll speed.
- **Send Referrer:** When the "Send Referrer" item is selected from the Settings menu, the user can turn on or off sending the referrer URL.
- **Key Press Time Out:** When the "Key Press Timeout" item is selected from the Settings menu, the user can set the key press timeout as fast, medium or slow. Medium is 1.5 seconds, slow 2 seconds and fast is 1 second. The key press timeout is the period of time after which the cursor auto-advances to the next entry position. In most cases, a single key can be used to enter more than one character. Each time the key is pressed the last character of the line is replaced by the next choice for that key. As long as the same key is repressed within key press timeout, the last character cycles between all the choices for the key.

# Browser

- **Connection Time Out:** When the Connection Timeout item is selected from the Settings menu, the user can set the connection timeout. The connection timeout determines how long the browser will wait for a response from the network for a network request.

## ADVANCED

- **About:** Displays the name of the supplier of the Browser and the Browser SW version.
- **Encryption:** Displays the following list of options.
  1. **Authentication:** Gives the option to turn Authentication Caching ON or OFF.
  2. **Root Certificate:** Shows the root security keys for TLS.
  3. **Current Certificate:** Shows the current site security key for TLS (if applicable).

## EXIT







To exit Mobile Web, select  or press the END Key  to exit out of the Browser and return to idle mode.









# Games & Apps

Your phone provides a unique feature -Games & Apps- that enables you to download melody ringtones, wallpapers, games and more from your network to your phone. Please contact your service provider for the availability of these services.

## STARTING GAMES & APPS

1. From idle mode, press the OK Key  [OK] to unlock the keypad, press the Left Soft Key  [Menu], the Directional Key  to select "Games & Apps", then slide out the QWERTY keyboard and press 1. Games & Apps.
2. When three or more icons appear on the screen, select an application with the Directional Key .
3. To start the application, press the OK Key .
4. To end the application, press the END Key . The phone will return to the idle mode.

## DOWNLOADING APPLICATIONS

1. From idle mode, press the OK Key  [OK] to unlock the keypad, press the Left Soft Key  [Menu], the Directional Key  to select "Games & Apps", then slide out the QWERTY keyboard and press 1. Games & Apps.
2. Select "Games & Apps"  with the Directional Key  then press the OK Key .
3. Select "Catalog" and press the OK Key .
4. The phone will access your service provider's server. Follow the prompt to download applications.

-  To select an option, press the Directional Key  then press the OK Key .
- When a prompt appears, press the OK Key  to proceed or the CLR Key  to cancel.

## DOWNLOADING MELODIES/WALLPAPERS









Before downloading melody ringtones and wallpapers, you need to download the dedicated downloader. Please contact your service provider for details.

## APPLYING MELODIES/WALLPAPERS

Downloaded melody ringtones apply to several functions including the incoming call alert, new text message alert, alarm clock and scheduler alarm. Downloaded wallpapers apply to the idle mode.











## CHECKING DATA FOLDER MEMORY

Downloaded melody ringtones, wallpapers and applications are saved to the data folder in your phone.

1. From idle mode, press the OK Key  [OK] to unlock the keypad, press the Left Soft Key  [Menu], the Directional Key  to select "Games & Apps", then slide out the QWERTY keyboard and press 1. Games & Apps.
2. Select "Settings" with the Directional Key  then press the OK Key .
3. Select "Manage Apps" with the Directional Key  then press the OK Key .
4. To exit, press the END Key .

## DELETE APPLICATION



















Downloaded melody ringtones, wallpapers and applications are saved to the data folder in your phone.

1. From idle mode, press the OK Key  [OK] to unlock the keypad, press the Left Soft Key  [Menu], the Directional Key  to select "Games & Apps", then slide out the QWERTY keyboard and press 1. Games & Apps.
2. Select "Settings" with the Directional Key  then press the OK Key .
3. Select "Manage Apps" with the Directional Key  then press the OK Key .
4. Select the application to be erased with the Directional Key  then press the OK Key .
5. Select "Remove" then press the OK Key .
6. Select "Yes" then press the OK Key .

# Tools/Utilities

























## CALCULATOR

The Calculator allows you to perform simple mathematical calculations. To access the calculator:





1. From idle mode, press the OK Key  [OK] to unlock the keypad, press the Left Soft Key  [Menu], the Directional Key  to select "Tools/Utilities", then slide out the QWERTY keyboard and press **1. Calculator**.
2. Follow the instructions below to calculate  $8 \times 6 \div 4 - 2.5 = 9.5$ 
  - Input 8 and then press the Directional Key  right.
  - Input 6 and then press the Directional Key  left.
  - Input 4 and then press the Directional Key  down.
  - Input 2 and then press the  to input (.).
  - Press 5.
  - Then press the OK Key  and you will see the answer (9.5).
3. To reset, press the Left Soft Key  [Clear].
  - Directional Key  right : X, Directional Key  down : -, Directional Key  left : ÷, Directional Key  up : +, \* Key  : ., Left Soft Key  : Clear, OK Key  : =.
  - To change the displayed number from positive (+) to negative (-) and vice versa, press # Key .
  - Press the Right Soft Key  [Operator] to use parenthesis "1. (," "2. )" and "3. Exponent".

## CALENDAR

The Calendar tool provides easy and convenient access to your schedule. Simply store your appointments and your phone will alert you to them.

1. From idle mode, press the OK Key  [OK] to unlock the keypad, press the Left Soft Key  [Menu], the Directional Key  to select "Tools/Utilities", then slide out the QWERTY keyboard and press **2. Calendar**.
2. Press the Directional Key  up, down, left or right to highlight the scheduled day.
3. Press the Left Soft Key  [New].
4. The Appointment field is highlighted. Enter the name of the event. Press the Directional Key  down to set the other fields for the event:
  - **Schedule:** Use the keypad to enter an appointment in your schedule.
  - **Start Time:** Use the keypad to set a start time and press the Left Soft Key  for "am/pm".
  - **End Time:** Use the keypad to set an end time and press the Left Soft Key  for "am/pm".
  - **Reminder:** Press the Directional Key  left or right to select an alert time interval option.  
0 Minute/5 Minutes/10 Minutes/15 Minutes
  - **Start Date:** Use the keypad to change or enter the start date.
  - **Recurrence:** Press the Directional Key  left or right to set the recurrence of the event (Daily, Weekly, Monthly, Yearly). For each recurrence setting, press the Directional Key  down to set the "By Count" field. For "Daily", set the number of days. For "Weekly", you can press the Directional Key  left or right to select "By Count" or "By Day". Then press the Directional Key  down again to make the set-ting - for "By Count", enter the number of weeks. For "By Day", press the Directional Key  left or right to select a day of the week. For "Monthly", set "By Count" the number of months, or press the Directional Key  right to set "By Day/Month". For "Yearly", set "By Day/Month".
  - **End Date:** Use the keypad to change or enter the end date.
  - **Time Zones:** If the Time Zone needs to be adjusted, press the Left Soft Key  [Set]. Press the Directional Key  up or down to select a new time zone then press the OK Key  [OK].  
OFF/EST/EDT/CST/CDT/MST/MDT/PST/PDT/AKST/AKDT/HAST/HADT/GMT/UTC
  - **Alert:** Press the Left Soft Key  [Set] to select a new ringtone. Press the Directional Key  up or down to highlight a ringtone then press the OK Key  [OK].  
Press the Left Soft Key  [Play/Stop] to preview a ringtone.
  - **Vibrate:** Press the Directional Key  left or right to set "On" or "Off"
5. Press the OK Key  [SAVE] to save it. The date of the event will be marked on your calendar.







## VIEW PLAN LIST

1. From idle mode, press the OK Key  [OK] to unlock the keypad, press the Left Soft Key  [Menu], the Directional Key  to select "Tools/Utilities", then slide out the QWERTY keyboard and press **2. Calendar**.
2. Press the Directional Key  up, down, left or right to choose the event then press the OK Key  [VIEW].









# Tools/Utilities

## ERASE SAVED EVENT













1. From idle mode, press the OK Key  [OK] to unlock the keypad, press the Left Soft Key  [Menu], the Directional Key  to select "Tools/Utilities", then slide out the QWERTY keyboard and press 2. **Calendar**.
2. Press the Directional Key  up, down, left or right to choose the event then press the OK Key  [VIEW].
3. Press the Left Soft Key  [Erase], then press the Right Soft Key  [Yes].

## ERASE PASSED EVENT







1. From idle mode, press the OK Key  [OK] to unlock the keypad, press the Left Soft Key  [Menu], the Directional Key  to select "Tools/Utilities", then slide out the QWERTY keyboard and press 2. **Calendar**.
2. Press the Directional Key  up, down, left or right to choose the event then press the OK Key  [VIEW].
3. Press the Right Soft Key  [Options], "6. **Erase Passed**", then press the Right Soft Key  [Yes].

## ALARM CLOCK







The Alarm Clock tool allows you to set up to three alarms. When you set an alarm, the current time is displayed at the top of the screen. When the alarm goes off, Alarm 1 (or 2 or 3, as applicable) will be displayed on the LCD screen and the alarm will sound.

1. From idle mode, press the OK Key  [OK] to unlock the keypad, press the Left Soft Key  [Menu], the Directional Key  to select "Tools/Utilities", then slide out the QWERTY keyboard and press 3. **Alarm Clock**.
2. Press the Directional Key  up or down to highlight an Alarm (1, 2 or 3), then press the OK Key  [OK].
3. The setting field will be highlighted. Press the Directional Key  down to select alarm options.
  - **Alarm:** Press the Directional Key  left or right to select "On" or "Off".
  - **Time:** Use the keypad to set a time for the alarm and press the Left Soft Key  for "am/pm".
  - **Frequency:** Press the Directional Key  left or right to select a setting for the alarm (**Once, Daily, Mon - Fri, Weekends**).
  - **Ringer:** Press the Left Soft Key  [Set] to select the alert tone you wish to set. Press the Left Soft Key  [Play/Stop] to preview a ringtone.  
Press the OK Key  [OK] to make your selection.
4. To save an alarm setting, press the OK Key  [SAVE].





## TURN ON/OFF THE ALARM SETTING

1. From idle mode, press the OK Key  [OK] to unlock the keypad, press the Left Soft Key  [Menu], the Directional Key  to select "Tools/Utilities", then slide out the QWERTY keyboard and press 3. **Alarm Clock**.
2. Press the Directional Key  up or down to highlight an Alarm (1, 2 or 3), then press the Right Soft Key  [Options].
3. Select "Turn On/Turn Off" then press the OK Key  [OK].

## RESET THE ALARM SETTING

1. From idle mode, press the OK Key  [OK] to unlock the keypad, press the Left Soft Key  [Menu], the Directional Key  to select "Tools/Utilities", then slide out the QWERTY keyboard and press 3. **Alarm Clock**.
2. Press the Directional Key  up or down to highlight an Alarm (1, 2 or 3), then press the Right Soft Key  [Options].
3. Select "Reset", then press the Right Soft Key  [Yes].

## RESET ALL ALARM SETTINGS

1. From idle mode, press the OK Key  [OK] to unlock the keypad, press the Left Soft Key  [Menu], the Directional Key  to select "Tools/Utilities", then slide out the QWERTY keyboard and press 3. **Alarm Clock**.
2. Press the Right Soft Key  [Options].
3. Select "Reset All", then press the Right Soft Key  [Yes].























# Tools/Utilities

## WORLD CLOCK

To display the time and date in pre-programmed cities:





1. From idle mode, press the OK Key  [OK] to unlock the keypad, press the Left Soft Key  [Menu], the Directional Key  to select "Tools/Utilities", then slide out the QWERTY keyboard and press 4. **World Clock**.
2. Press the Left Soft Key  [Cities] to access the CITIES LIST. Press the Directional Key  up or down to select the city, then press the OK Key  [OK]. Or, press the Directional Key  up, down, left, or right to select your city using the world map.
3. The world map appears with the city, its date, and time.

## DST (DAYLIGHT SAVING TIME) SETTING

1. In World Clock mode, press the Right Soft Key  [DST] to set the DST options. Press the Directional Key  left or right to select "City" and then press the Directional Key  down.
2. Press the Directional Key  left or right to turn DST (Daylight Savings Time) "On" or "Off". Press the Directional Key  down.
3. Under "Start Date", use the keypad to change or enter the start date and then press the Directional Key  down.
4. Under "Start Time", use the keypad to set a start time and press the Left Soft Key  for "am/pm" and then press the Directional Key  down.
5. Under "End Date", use the keypad to change or enter the end date and then press the Directional Key  down.
6. Under "End Time", use the keypad to set a end time and press the Left Soft Key  for "am/pm".
7. To save a DST setting, press the OK Key  [SAVE].

## NOTEPAD

Your phone includes an internal notepad that can be used to compose and store reminders and notes. To create a note:

1. From idle mode, press the OK Key  [OK] to unlock the keypad, press the Left Soft Key  [Menu], the Directional Key  to select "Tools/Utilities", then slide out the QWERTY keyboard and press 5. **Notepad**.
2. Press the Left Soft Key  [New] to write a new note. When you are done, press the OK Key  [SAVE].

## VIEW SAVED MEMO

To view a saved memo:

1. From idle mode, press the OK Key  [OK] to unlock the keypad, press the Left Soft Key  [Menu], the Directional Key  to select "Tools/Utilities", then slide out the QWERTY keyboard and press 5. **Notepad**.
2. Press the OK Key  [VIEW] to view a selected Note.

## ERASE SAVED MEMO

To erase a saved memo:

1. From idle mode, press the OK Key  [OK] to unlock the keypad, press the Left Soft Key  [Menu], the Directional Key  to select "Tools/Utilities", then slide out the QWERTY keyboard and press 5. **Notepad**.
2. Press the Right Soft Key  [Options], then select "Erase".
3. Press the Right Soft Key  [Yes].

## ERASE ALL SAVED MEMOS

To erase all saved memos:

1. From idle mode, press the OK Key  [OK] to unlock the keypad, press the Left Soft Key  [Menu], the Directional Key  to select "Tools/Utilities", then slide out the QWERTY keyboard and press 5. **Notepad**.
2. Press the Right Soft Key  [Options], then select "Erase All".
3. Press the Right Soft Key  [Yes].





# Tools/Utilities

## STOP WATCH







Simultaneously times up to eight different events. To operate the stop watch:

1. From idle mode, press the OK Key  [OK] to unlock the keypad, press the Left Soft Key  [Menu], the Directional Key  to select "Tools/Utilities", then slide out the QWERTY keyboard and press 6. **Stop Watch**.

### TO MEASURE A TIME PERIOD

1. To start the stop watch, press the OK Key  [START].
2. To pause it, press the OK Key  [STOP].
3. To resume it, press the OK Key  [START].
4. To reset it, press the Right Soft Key  [Reset].

### TO TIME UP TO EIGHT EVENTS AT ONCE



1. To start the stop watch, press the OK Key  [START].
2. To stop a time period and continue measuring another one, press the Left Soft Key  [Lap].
3. To stop the second and continue measuring a third one, press the Left Soft Key  [Lap].
4. To measure up to eight time periods, repeat the above steps.
5. To stop the stop watch, press the OK Key  [STOP].
6. To review the results, press the Left Soft Key  [View].
7. To return to the stop watch, press the OK Key  [OK].
8. To reset it, press the Right Soft Key  [Reset].

## VOICE COMMANDS

Your phone is equipped with an AVR (Advanced Voice Recognition) feature. This feature allows you to make calls or use the phone's functions by simply using your voice. All you have to do is talk into the phone, and the phone will recognize your voice and complete tasks by itself.

1. From idle mode, press the OK Key  [OK] to unlock the keypad, press the Left Soft Key  [Menu], the Directional Key  to select "Tools/Utilities", then slide out the QWERTY keyboard and press 7. **Voice Commands**.

 **Shortcut:** In idle mode, press and hold the Side AVR Key  to access the Voice Commands menu.

2. The phone displays the Voice Commands menu and prompts you to say the name of the command you want to use. To complete your task, simply follow the voice prompts. You can speak the name of the command after you hear a beep.
3. Select one of the following options by pressing the Directional Key  up or down, press the OK Key  .
  - **Call <Name or #>**
  - **Send Text <Name or #>**
  - **Send Picture <Name or #>**
  - **Lookup <Name>**
  - **Go To <Menu>**
  - **Check <Item>**
4. When it recognizes one of these commands, the phone launches the associated application. If the phone does not hear a command within approximately eight seconds, AVR mode will turn itself off.

### CALL <NAME OR #>

Use the Call command to voice dial a name from your Contact list or a phone number. When dialing a number, pronounce each digit, but do not pause noticeably between the digits.

1. You will hear "Say a command" and the Voice Commands menu will be displayed.
2. If calling a contact from your list, say Call <Name>. Your phone will ask you to confirm the name you said. Say "Yes" if it was repeated correctly. That phone number will be dialed. If there is more than one number saved for that Contacts, you will be asked to confirm which number to dial.

**Examples:** - Call Tom Smith, - Call 617 555-1212, - Call Bob Carson's mobile, - Call Dee Harper at Home.

# Tools/Utilities

## SEND TEXT <NAME OR #>

Use the Send command to send a text message to a specified name or number.

1. You will hear “Say a command” and the Voice Commands menu will be displayed.
2. Say “Send Text <Name or #>”.

**Examples:** - “Send Text to Dee Harper’s Mobile”, - “Send Text Tom Smith”, - “Send Text to Tom Smith’s Mobile”, - “Send Text to 617 555-1212”.

## SEND PICTURE <NAME OR #>

Use the Send command to send a picture message to a specified name or number.

1. You will hear “Say a command” and the Voice Commands menu will be displayed.
2. Say “Send Picture <Name or #>”.

**Examples:** - “Send Picture to Dee Harper’s Mobile”, - “Send Picture Tom Smith”, - “Send Picture to Tom Smith’s Mobile”, - “Send Picture to 617 555-1212”.

## LOOKUP <NAME>

Use the Lookup command to retrieve and display information for any name stored in your Contact list.

1. You will hear “Say a command” and the Voice Commands menu will be displayed.
2. Say “Lookup <Name>”.

**Examples:** - Lookup Tom Jones.

3. The View Entry page will be displayed for that entry name.

## GO TO <MENU>

Use the Go To command to open an application on your phone. You can say “Go To” by itself and be prompted to say the application name, or you can skip the prompt by saying “Go To” followed by the application name.

1. You will hear “Say a command” and the Voice Commands menu will be displayed.
2. Say “Go To” followed immediately by one of the following items:

- Recent Calls
- Messages
- Contacts
- Camera
- Browser
- Games & Apps
- More Options (Tools & Utilities, Media Gallery, Settings)

## CHECK <ITEM>

The Check command lets you check status information for your phone. You can say “Check” to see and hear all status information.

1. You will hear “Say a command” and the Voice Commands menu will be displayed.
2. Say “Check” followed immediately by one of the following items:

- Status
- Voicemail
- Messages
- Missed Calls
- Time
- Signal Strength
- More Options (Network, Battery, My Phone Number, Volume)









# Tools/Utilities

## VOICE COMMANDS SETTINGS







### CONFIRMATION

When the phone does not recognize your voice command, it will ask you to repeat your voice command. If it does not recognize the name or number, it will display a list of up to three choices and speak each one in turn. You can control how often the phone asks you to confirm the recognized name or number.

1. From idle mode, press the OK Key  [OK] to unlock the keypad, press the Left Soft Key  [Menu], the Directional Key  to select "Tools/Utilities", then slide out the QWERTY keyboard and press 7. **Voice Commands**.
2. Press the Right Soft Key  [Settings], "1. Confirmation".
3. Select "Automatic", "Always Confirm" or "Never Confirm" by pressing the Directional Key  up or down, then press the Left Soft Key  [OK]. To view help for Confirmation, press the Right Soft Key  [Help].

### ADAPTATION

Voice Command is speaker independent, which means that no training or adaptation is required. Some users with heavy accents or unusual voice characteristics may find difficulty in achieving high accuracy with speaker independent Voice Command, so the Adapt Voice feature allows users to dramatically improve the recognition accuracy through adaptation. Users who get acceptable recognition accuracy will find no additional benefit to performing the Adapt Voice adaptation.







1. From idle mode, press the OK Key  [OK] to unlock the keypad, press the Left Soft Key  [Menu], the Directional Key  to select "Tools/Utilities", then slide out the QWERTY keyboard and press 7. **Voice Commands**.
2. Press the Right Soft Key  [Settings], "2. Adaptation".
3. Scroll to select "1. Adapt Voice" or "2. Reset Voice" and press the Left Soft Key  [Select]. To view help for Adaptation, press the Right Soft Key  [Help].
  - **Adapt Voice:** Requires that you make recordings of your voice to customize the voice recognitions system. It will take a few minutes.
  - **Reset Voice:** Once you finish the adaptation process, you can reset the adaptation to the factory default settings.

 **Reset Voice** menu option only appears after you finish the **Adapt Voice** process.

4. Wait for the beep, and then repeat the sentences using a normal tone of voice.
5. When you finished with a full session, you will reach a screen that reads **Adaptation complete**.







### AUDIO MODES

You can control the level of audio guidance provided by the system. In Prompt Mode (the default), the system prompts for required information. In Readout Mode, the system prompts for required information and reads out the contents of the screen. In Expert Mode, audio guidance is provided by beeps only.

1. From idle mode, press the OK Key  [OK] to unlock the keypad, press the Left Soft Key  [Menu], the Directional Key  to select "Tools/Utilities", then slide out the QWERTY keyboard and press 7. **Voice Commands**.
2. Press the Right Soft Key  [Settings], "3. Audio Modes".
3. Select "Expert Mode", "Prompt Mode" or "Readout Mode" by pressing the Directional Key  up or down, then press the Left Soft Key  [OK]. To view help for Audio Modes, press the Right Soft Key  [Help].



### SPEAKERPHONE

You can control how the system uses the speakerphone. Select Always On to have outgoing audio play through the speakerphone. Select Always Off to have outgoing audio play through the internal speaker. Select Automatic to use the speakerphone setting of the phone.

1. From idle mode, press the OK Key  [OK] to unlock the keypad, press the Left Soft Key  [Menu], the Directional Key  to select "Tools/Utilities", then slide out the QWERTY keyboard and press 7. **Voice Commands**.
2. Press the Right Soft Key  [Settings], "4. Speakerphone".
3. Select "Automatic", "Always On" or "Always Off" by pressing the Directional Key  up or down, then press the Left Soft Key  [OK]. To view help for Speakerphone, press the Right Soft Key  [Help].

### ABOUT





To view your voice recognition software information:

1. From idle mode, press the OK Key  [OK] to unlock the keypad, press the Left Soft Key  [Menu], the Directional Key  to select "Tools/Utilities", then slide out the QWERTY keyboard and press 7. **Voice Commands**.
2. Press the Right Soft Key  [Settings], "5. About".

# Tools/Utilities





3. The "Nuance VSuite 3.2" version appears.
4. To return to the previous page, press the Right Soft Key  [Back].

## VOICE COMMANDS INFO

1. From idle mode, press the OK Key  [OK] to unlock the keypad, press the Left Soft Key  [Menu], the Directional Key  to select "Tools/Utilities", then slide out the QWERTY keyboard and press 7. [Voice Commands](#).
2. Press the Left Soft Key  [Tutorial].
3. Voice Commands menu information appears.
4. To return to the previous page, press the Left Soft Key  [Skip].









## VOICE MEMO

Voice Memo allows you to record a reminder message that can be up to 60 seconds. To record a memo:

1. From idle mode, press the OK Key  [OK] to unlock the keypad, press the Left Soft Key  [Menu], the Directional Key  to select "Tools/Utilities", then slide out the QWERTY keyboard and press 8. [Voice Memo](#).
2. Press the Left Soft Key  [New] to recording a new voice memo. When finished, press the Left Soft Key  [Save].

## PLAY SAVED VOICE MEMO

To play a saved voice memo:







1. From idle mode, press the OK Key  [OK] to unlock the keypad, press the Left Soft Key  [Menu], the Directional Key  to select "Tools/Utilities", then slide out the QWERTY keyboard and press 8. [Voice Memo](#).
2. Press the Directional Key  up or down to select the saved Voice Memo you want to play, then press the OK Key  [PLAY].
3. To stop playing the Voice Memo, press OK Key  [PAUSE]. When the Voice Memo is paused, press OK Key  [PLAY] to play the Voice Memo continuously.
4. Press the Right Soft Key  [Options] to choose from the following:
  1. **Rename:** Rename the selected voice memo.
  2. **Erase:** Erase the selected voice memo.
  3. **Lock/Unlock:** Select to lock or unlock the selected voice memo.
  4. **Erase All:** Erase all the saved voice memo.
  5. **Send:** To send a MMS message.



# Media Gallery

## SOUND BOX







This menu displays the list of downloaded ringtones and recorded voice memos.

1. From idle mode, press the OK Key  [OK] to unlock the keypad, press the Left Soft Key  [Menu], the Directional Key  to select "Media Gallery", then slide out the QWERTY keyboard and press 1. Sound Box.
2. Press the Right Soft Key  [Options] to choose from the following:  
1. Send/2. Send Online Album/3. Set As/4. Rename/5. Lock/Unlock/6. Move/7. Erase All/8. File Info
3. Scroll through the downloaded sounds to display the sound you want to send. Press the Right Soft Key  [Options], then select "1. Send". Press the OK Key .

 Since you can't Send or Move a DRM file, the Send/Move options will not appear when working with this type of file.

## PICTURE BOX

This menu displays the list of pictures taken with the Camera.

1. From idle mode, press the OK Key  [OK] to unlock the keypad, press the Left Soft Key  [Menu], the Directional Key  to select "Media Gallery", then slide out the QWERTY keyboard and press 2. Picture Box.
2. Press the Right Soft Key  [Options] to choose from the following:  
1. Set As/2. Send/3. Send Online Album/4. Rename/5. Lock/Unlock/6. Move/7. Erase All/8. File Info
3. Scroll through the downloaded images to display the image you want to send. Press the Right Soft Key  [Options], then select "2. Send". Press the OK Key .

## MP3 BOX

This menu appears when using a micro SD card. To play music through your phone, copy downloaded music from your PC to the card then insert the card into your phone.

1. From idle mode, press the OK Key  [OK] to unlock the keypad, press the Left Soft Key  [Menu], the Directional Key  to select "Media Gallery", then slide out the QWERTY keyboard and press 3. MP3 Box.
2. Press the Right Soft Key  [Options] to choose from the following:  
1. Setting: To select music file playback options. (1. Normal, 2. Repeat, 3. Repeat All, 4. Shuffle)/2. Set As/3. Mark All/Unmark All/4. Erase/5. Erase All/6. File Info

 When setting an MP3 file from a microSD card as a ringtone (Options -> Set As -> Ringtone), the MP3 file will be moved to the internal memory and will not appear on the MP3 Box list any more. You can see the saved MP3 file on the ringtone list (Settings -> Sound Settings -> Call Sounds -> Call Ringtone).

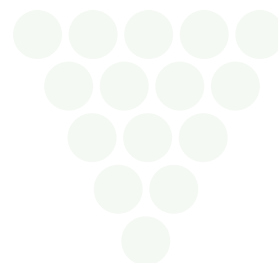





# Settings

## SOUND SETTINGS

### RINGER VOLUME

To adjust the ringer volume:

1. From idle mode, press the OK Key  [OK] to unlock the keypad, press the Left Soft Key  [Menu], the Directional Key  to select "Settings", then slide out the QWERTY keyboard and press 1. [Sound Settings](#), 1. [Ringer Volume](#).
2. Press the Directional Key  up, down, left or right to select one of the following settings, then press the OK Key  [SET].  
[Silent/Vibrate On/Level 1 ~ Level 5](#)







 Press the Left Soft Key  [Play/Stop] to play/stop sound.

### CALL SOUNDS





To set ringtones for types of incoming calls:

1. From idle mode, press the OK Key  [OK] to unlock the keypad, press the Left Soft Key  [Menu], the Directional Key  to select "Settings", then slide out the QWERTY keyboard and press 1. [Sound Settings](#), 2. [Call Sounds](#).

### CALL RINGTONE

1. From idle mode, press the OK Key  [OK] to unlock the keypad, press the Left Soft Key  [Menu], the Directional Key  to select "Settings", then slide out the QWERTY keyboard and press 1. [Sound Settings](#), 2. [Call Sounds](#), 1. [Call Ringtone](#).
2. Press the Directional Key  up or down to select a ringtone, then press the OK Key  [OK] to save the sound.  
To play the ringtone, press the Left Soft Key  [Play/Stop].

### CALL VIBRATE









1. From idle mode, press the OK Key  [OK] to unlock the keypad, press the Left Soft Key  [Menu], the Directional Key  to select "Settings", then slide out the QWERTY keyboard and press 1. [Sound Settings](#), 2. [Call Sounds](#), 2. [Call Vibrate](#).
2. Press the Directional Key  up or down to select "On" or "Off", then press the OK Key  [OK].

### MSG SOUNDS









To select a ringer type for Incoming messages:

1. From idle mode, press the OK Key  [OK] to unlock the keypad, press the Left Soft Key  [Menu], the Directional Key  to select "Settings", then slide out the QWERTY keyboard and press 1. [Sound Settings](#), 3. [Msg Sounds](#).

### TXT MESSAGE

1. From idle mode, press the OK Key  [OK] to unlock the keypad, press the Left Soft Key  [Menu], the Directional Key  to select "Settings", then slide out the QWERTY keyboard and press 1. [Sound Settings](#), 3. [Msg Sounds](#), 1. [TXT Message](#).
2. Select "Tone", "Vibrate" or "Reminder" by pressing the Directional Key  up or down and then select one of the following options by pressing the Directional Key  up or down:
  - **Tone:** Ringtones or select your desired ringer type by pressing the Directional Key  up or down. Press the Left Soft Key  [Play/Stop] to play/stop sound.
  - **Vibrate:** Select "On" or "Off".
  - **Reminder:** Select "Once", "Every 2 Minutes", "Every 15 Minutes" or "Off".
3. To save, press the OK Key  [OK].









### PIX MESSAGE

1. From idle mode, press the OK Key  [OK] to unlock the keypad, press the Left Soft Key  [Menu], the Directional Key  to select "Settings", then slide out the QWERTY keyboard and press 1. [Sound Settings](#), 3. [Msg Sounds](#), 2. [Pix Message](#).
2. Select "Tone", "Vibrate" or "Reminder" by pressing the Directional Key  up or down and then select one of the following options by pressing the Directional Key  up or down:
  - **Tone:** Ringtones or select your desired ringer type by pressing the Directional Key  up or down. Press the Left Soft Key  [Play/Stop] to play/stop sound.
  - **Vibrate:** Select "On" or "Off".
  - **Reminder:** Select "Once", "Every 2 Minutes", "Every 15 Minutes" or "Off".
3. To save, press the OK Key  [OK].









# Settings

## VOICEMAIL MSG

1. From idle mode, press the OK Key  [OK] to unlock the keypad, press the Left Soft Key  [Menu], the Directional Key  to select "Settings", then slide out the QWERTY keyboard and press 1. [Sound Settings](#), 3. [Msg Sounds](#), 3. [Voicemail MSG](#).
2. Select "Tone", "Vibrate" or "Reminder" by pressing the Directional Key  up or down and then select one of the following options by pressing the Directional Key  up or down:
  - **Tone:** Ringtones or select your desired ringer type by pressing the Directional Key  up or down. Press the Left Soft Key  [Play/Stop] to play/stop sound.
  - **Vibrate:** Select "On" or "Off".
  - **Reminder:** Select "Once", "Every 2 Minutes", "Every 15 Minutes" or "Off".
3. To save, press the OK Key  [OK].





## SERVICE ALERTS

To set any of the three Alert options to either On or Off:

1. From idle mode, press the OK Key  [OK] to unlock the keypad, press the Left Soft Key  [Menu], the Directional Key  to select "Settings", then slide out the QWERTY keyboard and press 1. [Sound Settings](#), 4. [Service Alerts](#).
2. Press the Directional Key  up or down to select one of the following options, then press the OK Key  [OK].
  - **Roam:** Alerts you with the Enhanced Roaming Indicator (ERI) sound when the phone is outside of the home service area.
  - **Minute Beep:** Alerts you every minute during a call.
  - **Call Connect:** Alerts you when a call is connected.
3. Press the Directional Key  up or down to select "On" or "Off", then press the OK Key  [OK].





## POWER ON/OFF

To set the phone to sound a tone when the phone is powered on/off:

1. From idle mode, press the OK Key  [OK] to unlock the keypad, press the Left Soft Key  [Menu], the Directional Key  to select "Settings", then slide out the QWERTY keyboard and press 1. [Sound Settings](#), 5. [Power On/Off](#).
2. Press "1. [Power On Tone](#)" or "2. [Power Off Tone](#)".
3. Press the Directional Key  up or down to select "On" or "Off", then press the OK Key  [OK].





## OPEN/CLOSE SOUND

To set the Open/Close Sound to either On or Off:

1. From idle mode, press the OK Key  [OK] to unlock the keypad, press the Left Soft Key  [Menu], the Directional Key  to select "Settings", then slide out the QWERTY keyboard and press 1. [Sound Settings](#), 6. [Open/Close Sound](#).
2. Press the Directional Key  up or down to select "On" or "Off", then press the OK Key  [OK].

## KEY TONE

To set the keypad tone:

1. From idle mode, press the OK Key  [OK] to unlock the keypad, press the Left Soft Key  [Menu], the Directional Key  to select "Settings", then slide out the QWERTY keyboard and press 1. [Sound Settings](#), 7. [Key Tone](#).
2. Adjust the volume by pressing the Directional Key  up, down, left or right, then press the OK Key  [OK] to save the setting.  
[Silent/Level 1 ~ Level 5](#)

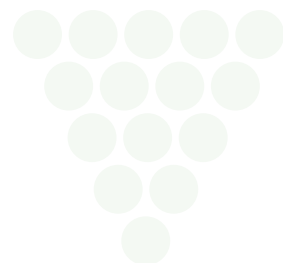







# Settings

## DISPLAY SETTINGS

Allows you to customize the display.





### MY BANNER

The text greeting can be up to 16 characters and is displayed on your phone's screen in idle mode.

1. From idle mode, press the OK Key  [OK] to unlock the keypad, press the Left Soft Key  [Menu], the Directional Key  to select "Settings", then slide out the QWERTY keyboard and press **2. Display Settings, 1. My Banner.**
2. Enter your banner text (up to 16 characters), then press the OK Key  [OK].

### BACKLIGHT DURATION





To set the duration for backlight illumination for the Main Screen and Keypad:

1. From idle mode, press the OK Key  [OK] to unlock the keypad, press the Left Soft Key  [Menu], the Directional Key  to select "Settings", then slide out the QWERTY keyboard and press **2. Display Settings, 2. Backlight Duration.**
2. Press "**1. Display**" or "**2. Keypad**".
3. Press the Directional Key  up or down to select one of the following settings, then press the OK Key  [OK].  
**7 Seconds/15 Seconds/30 Seconds/Always On/Always Off**

 Even if "Always On" is selected for the Backlight setting, the backlight will turn off when the phone is closed.



### CONTRAST

To adjust the display contrast:

1. From idle mode, press the OK Key  [OK] to unlock the keypad, press the Left Soft Key  [Menu], the Directional Key  to select "Settings", then slide out the QWERTY keyboard and press **2. Display Settings, 3. Contrast.**
2. Press the Directional Key  up or down to select one of the following settings, then press the OK Key  [OK].  
**Level 1 ~ Level 5**







### WALLPAPER

To choose the kind of background to be displayed on the phone:

1. From idle mode, press the OK Key  [OK] to unlock the keypad, press the Left Soft Key  [Menu], the Directional Key  to select "Settings", then slide out the QWERTY keyboard and press **2. Display Settings, 4. Wallpaper.**
2. Select an available screen, then press the OK Key  [OK]. To view the image, press the Left Soft Key  [View].





### SCREENSAVER

To set the screensaver to be displayed on the phone in idle mode:

1. From idle mode, press the OK Key  [OK] to unlock the keypad, press the Left Soft Key  [Menu], the Directional Key  to select "Settings", then slide out the QWERTY keyboard and press **2. Display Settings, 5. Screensaver.**
2. Press "**1. Time Setting**".
3. Press the Directional Key  up or down to select one of the following settings, then press the OK Key  [OK].  
**Off/5 Seconds/10 Seconds/20 Seconds/30 Seconds**
4. Press "**2. Screensaver**".
5. Select an available screensaver, then press OK Key  [OK]. To view the image, press the Left Soft Key  [View].

### MENU TYPE

To change Main Menu layout and type:





1. From idle mode, press the OK Key  [OK] to unlock the keypad, press the Left Soft Key  [Menu], the Directional Key  to select "Settings", then slide out the QWERTY keyboard and press **2. Display Settings, 6. Menu Type.**
2. Press the Directional Key  up or down to select "**Graphic Type**" or "**List Type**", then press the OK Key  [OK].

# Settings

## PHONE SETTINGS





### AIRPLANE MODE

In Airplane Mode, all menu functions can be accessed except making calls, receiving calls, data connection and Bluetooth®. Activating Airplane Mode will disable all wireless communications. In Airplane Mode, services that support Location On functions like Chaperone are temporarily disabled.

1. From idle mode, press the OK Key  [OK] to unlock the keypad, press the Left Soft Key  [Menu], the Directional Key  to select "Settings", then slide out the QWERTY keyboard and press **3. Phone Settings, 1. Airplane Mode**.
2. Press the Directional Key  up or down to select "On" or "Off", then press the OK Key  [OK].





### LANGUAGE

To set the bilingual feature to either English or Español:

1. From idle mode, press the OK Key  [OK] to unlock the keypad, press the Left Soft Key  [Menu], the Directional Key  to select "Settings", then slide out the QWERTY keyboard and press **3. Phone Settings, 2. Language**.
2. Press the Directional Key  up or down to select "English" or "Español", then press the OK Key  [OK].





### MENU READOUT

To turn the Menu Readout on/off:





1. From idle mode, press the OK Key  [OK] to unlock the keypad, press the Left Soft Key  [Menu], the Directional Key  to select "Settings", then slide out the QWERTY keyboard and press **3. Phone Settings, 3. Menu Readout**.
2. Press the Directional Key  up or down to select "On" or "Off", then press the OK Key  [OK].

### MESSAGE READOUT

To turn the Message Readout on/off:

1. From idle mode, press the OK Key  [OK] to unlock the keypad, press the Left Soft Key  [Menu], the Directional Key  to select "Settings", then slide out the QWERTY keyboard and press **3. Phone Settings, 4. Message Readout**.
2. Press the Directional Key  up or down to select "On" or "Off", then press the OK Key  [OK].

### LOCATION

1. From idle mode, press the OK Key  [OK] to unlock the keypad, press the Left Soft Key  [Menu], the Directional Key  to select "Settings", then slide out the QWERTY keyboard and press **3. Phone Settings, 5. Location**.
2. Press the Directional Key  up or down to select one of the following settings, then press the OK Key  [OK].
  - **E911 Only:** Your location will be hidden from the network and applications, except for 911.
  - **Location On:** Your location is now available to the network.







### SECURITY

The Security menu allows you to electronically secure the phone.

 The default lock code is the last 4 digits of your mobile telephone number.

### LOCK MODE









This setting specifies whether the phone should be locked whenever it is turned on. Lock Mode prevents the unauthorized use of your phone. Once the phone is locked, it is in restricted mode until the Lock Code is entered. You can still make emergency calls. You can modify the Lock Code using the new Lock code within the Security menu.

1. From idle mode, press the OK Key  [OK] to unlock the keypad, press the Left Soft Key  [Menu], the Directional Key  to select "Settings", then slide out the QWERTY keyboard and press **3. Phone Settings, 6. Security**.
2. Enter the four-digit Lock Code, then press the OK Key  [OK]. The default lock code is the last 4 digits of your mobile telephone number.
3. Press "1. Lock Mode".
4. Press the Directional Key  up or down to select one of the following settings, then press the OK Key  [OK].
  - **Lock Now:** Phone is locked.
  - **Unlocked:** Phone is unlocked.
  - **On Power Up:** Phone will lock when it is turned on.

# Settings









## RESTRICT

Set the restriction for incoming and outgoing calls.

1. From idle mode, press the OK Key  [OK] to unlock the keypad, press the Left Soft Key  [Menu], the Directional Key  to select "Settings", then slide out the QWERTY keyboard and press 3. Phone Settings, 6. Security.
2. Enter the four-digit Lock Code, then press the OK Key  [OK]. The default lock code is the last 4 digits of your mobile telephone number.
3. Press "2. Restrict".
4. Press the Directional Key  up or down to select "Incoming Calls" or "Outgoing Calls", then press the OK Key  [OK].
5. Press the Directional Key  up or down to select "Allow All", "Contacts Only" or "Block All", then press the OK Key  [OK].

## EDIT CODES

To set a new Lock Code:

1. From idle mode, press the OK Key  [OK] to unlock the keypad, press the Left Soft Key  [Menu], the Directional Key  to select "Settings", then slide out the QWERTY keyboard and press 3. Phone Settings, 6. Security.
2. Enter the four-digit Lock Code, then press the OK Key  [OK]. The default lock code is the last 4 digits of your mobile telephone number.
3. Press "3. Edit Codes".
4. Press the Directional Key  up or down to select "Phone Only" or "Calls & Services", then press the OK Key  [OK].
  - **Phone Only:** Allows you to edit the lock code for "Security". The default lock code is the last 4 digits of your mobile telephone number.
  - **Calls & Services:** Allows you to edit the lock code for "Restrict". The default lock code is 0000.
5. If "Phone Only" is selected, enter the new four-digit code in the "New Code" field. Enter the new four-digit code again in the "Confirm Code" field and press the OK Key  [OK].
6. If "Calls & Services" is selected, enter the current lock code in the "Actual Code" field. Enter the new four-digit code in the "New Code" field. Enter the new four-digit code again in the "Confirm Code" field and press the OK Key  [OK].







# Settings

## CALL SETTINGS

### ANSWER OPTIONS

To determine how to handle an answered call:





1. From idle mode, press the OK Key  [OK] to unlock the keypad, press the Left Soft Key  [Menu], the Directional Key  to select "Settings", then slide out the QWERTY keyboard and press 4. Call Settings, 1. Answer Options.
2. Press the Directional Key  up or down to select one of the following settings, then press the OK Key  [OK].  
Slide Open/Any Key/Auto Answer/Send Key



- When the phone is closed, the Auto Answer Mode will not function, except when a headset is connected.
- The Auto Answer Mode will function after about five seconds.





### AUTO RETRY

To set the length of time the phone waits before automatically redialing a number when the attempted call fails:

1. From idle mode, press the OK Key  [OK] to unlock the keypad, press the Left Soft Key  [Menu], the Directional Key  to select "Settings", then slide out the QWERTY keyboard and press 4. Call Settings, 2. Auto Retry.
2. Press the Directional Key  up or down to select one of the following settings, then press the OK Key  [OK].  
Off/7 Seconds/10 Seconds





### TTY MODE

You can attach a TTY device to your phone enabling you to communicate with parties also using a TTY device. A phone with TTY support is able to translate typed characters to voice. Voice can also be translated into characters and then displayed on the TTY.

1. From idle mode, press the OK Key  [OK] to unlock the keypad, press the Left Soft Key  [Menu], the Directional Key  to select "Settings", then slide out the QWERTY keyboard and press 4. Call Settings, 3. TTY Mode.
2. Press the Directional Key  up or down to select one of the following settings, then press the OK Key  [OK].  
TTY Full/TTY + Talk/TTY + Hear/TTY Off

### ONE TOUCH DIAL

To initiate a speed dial call by holding down the speed dial digit:





1. From idle mode, press the OK Key  [OK] to unlock the keypad, press the Left Soft Key  [Menu], the Directional Key  to select "Settings", then slide out the QWERTY keyboard and press 4. Call Settings, 4. One Touch Dial.
2. Press the Directional Key  up or down to select "On" or "Off", then press the OK Key  [OK].



If One Touch Dial is disabled, Speed Dial numbers designated in your Contacts will not function.





### VOICE PRIVACY

To turn the voice privacy feature On or Off:

1. From idle mode, press the OK Key  [OK] to unlock the keypad, press the Left Soft Key  [Menu], the Directional Key  to select "Settings", then slide out the QWERTY keyboard and press 4. Call Settings, 5. Voice Privacy.
2. Press the Directional Key  up or down to select "On" or "Off", then press the OK Key  [OK].

### DTMF

To set the Key Tone length and touch tone playback speed:







1. From idle mode, press the OK Key  [OK] to unlock the keypad, press the Left Soft Key  [Menu], the Directional Key  to select "Settings", then slide out the QWERTY keyboard and press 4. Call Settings, 6. DTMF.
2. Press the Directional Key  up or down to select "Normal" or "Long", then press the OK Key  [OK].
  - **Normal:** Sends out a tone for a fixed period of time even if you continue to press the key.
  - **Long:** Sends out a continuous tone for the duration the key is pressed and held.

# Settings

## MEMORY



### SAVE OPTIONS

To select whether to save to Internal Memory or to External Memory when saving a file:

1. From idle mode, press the OK Key  [OK] to unlock the keypad, press the Left Soft Key  [Menu], the Directional Key  to select "Settings", then slide out the QWERTY keyboard and press **5. Memory, 1. Save Options**.
2. Press the OK Key  [OK] to select "1. Picture".
3. Press the Directional Key  up or down to select "Internal Memory" or "External Memory", then press the OK Key  [OK].

### INTERNAL MEMORY

To check the available Internal Memory capacity, used capacity, and total capacity:

1. From idle mode, press the OK Key  [OK] to unlock the keypad, press the Left Soft Key  [Menu], the Directional Key  to select "Settings", then slide out the QWERTY keyboard and press **5. Memory, 2. Internal Memory**.
2. Press the OK Key  [OK] to return to the previous screen.

### EXTERNAL MEMORY

To check the available External Memory capacity, used capacity, and total capacity:

 Memory card must be inserted into the phone to perform these functions.

1. From idle mode, press the OK Key  [OK] to unlock the keypad, press the Left Soft Key  [Menu], the Directional Key  to select "Settings", then slide out the QWERTY keyboard and press **5. Memory, 3. External Memory**.
2. Press the OK Key  [OK] to return to the previous screen.



## BLUETOOTH

Bluetooth technology connectivity enables wireless connections between electronic devices. If connected with a Bluetooth Handsfree device, you can use your phone more freely. Since devices with Bluetooth connectivity communicate using radio waves, your phone and the other device do not need to be in direct line-of-sight. The two devices only need to be within 10 meters (30 feet) of each other. The connection can be subject to interference from obstructions such as walls or other electronic devices. This device is compliant with Bluetooth specification 2.0, supporting the following profiles: HSP V1.0 (headset profile), AVRCP V1.0 (stereo profile), HFP V1.5 (handsfree car kit profile) and File Transfer. To ensure interoperability between other devices supporting Bluetooth technology, use approved enhancements for this model. Check with the manufacturers of other devices to determine their compatibility with this phone. There may be restrictions on using Bluetooth technology in some locations. Check with your local authorities or service provider. If you want more information on this function, visit the Bluetooth Technology organization Web site: <https://www.bluetooth.org/>.

 **Important:** Features using Bluetooth technology or allowing such features to run in the background while using other features, increase the demand on battery power and reduce the battery life.

### BLUETOOTH ON/OFF

To toggle Bluetooth® power On/Off:

1. From idle mode, press the OK Key  [OK] to unlock the keypad, press the Left Soft Key  [Menu], the Directional Key  to select "Settings", then slide out the QWERTY keyboard and press **6. Bluetooth**.
2. Press the Right Soft Key  [Options].
3. Press "1. Power On/Off".











 If Bluetooth power is not on, you will be prompted to turn it on in order to proceed.

4. Press the Directional Key  up or down to select "On" or "Off", then press the OK Key  [OK]. A Confirmation window appears.

# Settings



## NEW DEVICE

Pairing is the process that allows the handset to locate, establish and register a 1-to-1 connection with the target device.







1. Follow the Bluetooth® accessory instructions to set the device to pairing mode.
2. From idle mode, press the OK Key  [OK] to unlock the keypad, press the Left Soft Key  [Menu], the Directional Key  to select “Settings”, then slide out the QWERTY keyboard and press 6. **Bluetooth**. Press the OK Key  [OK] or select “1. New Device”.
3. If the Bluetooth® power is switched off, the following message will appear on the LCD screen: “Turn bluetooth power on?”. Press the Right Soft Key  [Yes].
4. The handset will prompt you with the following message on the LCD screen: “Place device you are connecting to in discoverable mode”. Press the OK Key  [OK].
5. The device will appear in the “New Device” menu. Press the Directional Key  up or down to select the device you wish to pair to, then press the Left Soft Key  [Pair]. Before pairing to the device, press the Right Soft Key  [Info] to view the device information.
6. The handset will prompt you for the password. Consult the Bluetooth® accessory (sold separately) instructions for the appropriate password (typically “0000”—4 zeroes). Enter the password, then press the OK Key  [OK].

 You do not need to input the password for pairing when the password of the Bluetooth® Headset or hands-free kit is 0000.

7. Once connected, you will see the device listed in the Bluetooth and the Bluetooth® device connected icon will appear at the top of the LCD screen when connected to the Bluetooth® device. You can also check out the connection with an Arrow icon on the Bluetooth.

-  • In the Bluetooth, you can disconnect the connected device with an icon by pressing the OK Key  [Drop]. Conversely, you can reconnect by pressing the OK Key  [OK] again.
- When an audio device is connected, you can select another device and the connection is automatically transferred from that audio device to the other one.
  - If multiple devices are displayed, select the devices you want to connect.

## OPTIONS





1. From idle mode, press the OK Key  [OK] to unlock the keypad, press the Left Soft Key  [Menu], the Directional Key  to select “Settings”, then slide out the QWERTY keyboard and press 6. **Bluetooth**.
2. Press the Directional Key  up or down to select the paired device.
3. Press the Right Soft Key  [Options].
4. Press the Directional Key  up or down to select one of the following options, then press the OK Key  [OK].
  - **Remove Device:** Removes a device from the pairing list.
  - **Rename Device:** Renames a paired device.
  - **Service Discovery:** To search for the services that the selected device supports.
  - **Send Name Card:** Send name cards stored in Contacts to a selected device.
  - **Send Picture:** Send photos stored in Picture Gallery to a selected device.
  - **Send Ringtone:** Send sound files stored in Sound Box to a selected device.
  - **Get Name Card:** Get name cards from the selected device.
  - **Device Info:** Displays device information.

-  • If “Send Picture” is selected, FILE TRANSFER supports jpg(jpeg), gif, bmp and png file formats.
- If “Send Ringtone” is selected, FILE TRANSFER supports mp3, mid, qcp, aac and pmd file formats.
  - Received mp3, mid, qcp, aac, pmd files are saved in the Sound Box.

## SETTINGS

### MY PHONE NAME

To edit the Bluetooth® name of your phone:

1. From idle mode, press the OK Key  [OK] to unlock the keypad, press the Left Soft Key  [Menu], the Directional Key  to select “Settings”, then slide out the QWERTY keyboard and press 6. **Bluetooth**.
2. Press the Right Soft Key  [Options].
3. Press “2. My Phone Name”.
4. Use the numeric keypad to enter a new custom name.
5. Press the OK Key  [OK] to save and exit.

# Settings

## DISCOVERY MODE

To set whether your device is able to be searched for by other Bluetooth® devices in the area:







1. From idle mode, press the OK Key  [OK] to unlock the keypad, press the Left Soft Key  [Menu], the Directional Key  to select “Settings”, then slide out the QWERTY keyboard and press **6. Bluetooth**.
2. Press the Right Soft Key  [Options].
3. Press “**3. Discovery Mode**”.

 If Bluetooth power is not on, you will be prompted to turn it on in order to proceed.

4. Press the Directional Key  up or down to select “On” or “Off”, then press the OK Key  [OK].







## SUPPORTED PROFILES

To view brief descriptions of the profiles supported by the phone:

1. From idle mode, press the OK Key  [OK] to unlock the keypad, press the Left Soft Key  [Menu], the Directional Key  to select “Settings”, then slide out the QWERTY keyboard and press **6. Bluetooth**.
2. Press the Right Soft Key  [Options].
3. Press “**4. Supported Profiles**”.
4. Press the Directional Key  up or down to select one of the following profiles, then press the OK Key  [VIEW].  
**Headset/Handsfree/Stereo/Object Push/File Transfer**

## AUTO PAIR HANDSFREE



To set Auto Pair Handsfree On/Off:

1. From idle mode, press the OK Key  [OK] to unlock the keypad, press the Left Soft Key  [Menu], the Directional Key  to select “Settings”, then slide out the QWERTY keyboard and press **6. Bluetooth**.
2. Press the Right Soft Key  [Options].
3. Press “**5. Auto Pair Handsfree**”.
4. Press the Directional Key  up or down to select “On” or “Off”, then press the OK Key  [OK].

## PHONE INFO

### MY NUMBER

To view your phone number:

1. From idle mode, press the OK Key  [OK] to unlock the keypad, press the Left Soft Key  [Menu], the Directional Key  to select “Settings”, then slide out the QWERTY keyboard and press **7. Phone Info, 1. My Number**.
2. The following information appears:  
**Mobile Device Number (MDN)/Mobile Identifications Number (MIN)/Cricket**

### SW VERSION

1. From idle mode, press the OK Key  [OK] to unlock the keypad, press the Left Soft Key  [Menu], the Directional Key  to select “Settings”, then slide out the QWERTY keyboard and press **7. Phone Info, 2. SW Version**.
2. Displays the **Software Version/Hardware Version/PRL Version/Browser Version/Brew Version**.
3. Press the OK Key  [OK] to return to the previous screen.



# Messages Menu



**This chapter addresses Voicemail, Text, Picture Messages functions including:**

When a new message arrives

New message

Voicemail

Inbox

Sent

Drafts

Settings

Erase



# Messages

## WHEN A NEW MESSAGE ARRIVES









1. The following display appears when a new message arrives.
2. To display the message, select "View" and then press the OK Key  [OK].



## NEW MESSAGE









 **Shortcut:** In idle mode, press the Directional Key  right to access Messages Menu.

### TEXT MESSAGE

1. From idle mode, press the OK Key  [OK] to unlock the keypad, press the Left Soft Key  [Menu], the Directional Key  to select "Messages", then slide out the QWERTY keyboard and press **1. New Message**.
2. Press "**1. Text Message**".
3. Under "To", input the phone number and then press the OK Key  [OK].
  - By pressing the Right Soft Key  [Add], you can choose from the following:
    - 1. From List Entries:** Search for a phone number which is stored in the Contact list.
    - 2. Recent Calls:** Search for a phone number which is stored in the recent calls list.
    - 3. Message Groups:** Search the message groups stored in the Contact list.
    - 4. To List Entries:** Save the number or email you've entered to the Contact list, when you enter the number.
4. Under "Text", input a new Text message. When completed, press the OK Key  [SEND].
  - By pressing the Right Soft Key  [Options], you can choose from the following:
    - 1. Read Message:** To readout already written sentences in Text message.
    - 2. Save As Draft:** To save the Text message.
    - 3. Add Quick Text:** Inserts already written sentences in Text message.
    - 4. Priority Level:** Select "High" or "Normal" by pressing the Directional Key  up or down.
    - 5. Cancel Message:** To cancel message.

 If one of the fields is inserted in the Text message field, the message is saved in the draft box.

### PICTURE MESSAGE

1. From idle mode, press the OK Key  [OK] to unlock the keypad, press the Left Soft Key  [Menu], the Directional Key  to select "Messages", then slide out the QWERTY keyboard and press **1. New Message**.
2. Press "**2. Picture Message**".
3. Under "To", input the phone number and then press the OK Key  [OK].
  - By pressing the Right Soft Key  [Add], you can choose from the following:
    - 1. From List Entries:** Search for a phone number which is stored in the Contacts list.
    - 2. Recent Calls:** Search for a phone number which is stored in the Recent Calls list.
    - 3. Message Groups:** Search the message groups stored in the Contact list.
    - 4. To List Entries:** Save the number or email you've entered to the Contact list, when you enter the number.
    - 5. Online Album:** To send Picture message by using Online Address.
4. Under "Text", input a New Picture Message and then press the Directional Key  down.
5. Under "Picture", you can only insert/remove one picture. Press the Left Soft Key  [Add] to select the picture you would like to send then press the OK Key  [OK].

# Messages

- Under "Sound", you can only insert/remove one sound. Press the Left Soft Key [Add] to select the sound you would like to send then press the OK Key [OK].
- Under "Subject", input a subject and then press the Directional Key down.
- Under "Name Card", you can only insert/remove one name card. Press the Left Soft Key [Add] and scroll to "My Name Card" or "Contacts" and press the OK Key [OK]. Select the name card or the contact and press the OK Key [OK].
- Press the Right Soft Key [Options] to access the following:
  - Preview:** To preview a written Picture Message.
  - Read Message:** To readout already written sentences in Text message.
  - Save As Draft:** To save the Picture Message.
  - Add Quick Text:** Inserts already written sentences in Picture Message.
  - Add Slide:** To add another message.
  - Priority Level:** Select "High" or "Normal" by pressing the Directional Key up or down.
  - Remove Picture:** To remove inserted picture from the Picture field.
  - Remove Slide:** To remove inserted Slide Message.
  - Remove Sound:** To remove inserted sound from the Sound field.
  - Remove Name Card:** To remove inserted name card from the Name Card field.
  - Cancel Message:** To cancel message.
- To send the Picture message, press the OK Key [SEND].

 If one of the fields is inserted in Picture Message field, the message is saved in the draft box.

## VOICEMAIL

New voicemail alerts are sent via an SMS text message. These messages indicate how many new and urgent voicemails are in your voicemail box. Open the text message to view the number of new voice messages in your voicemail. If a caller leaves a callback number, this number will also be sent via an SMS text message. Displays the number of voice mails and accesses them by pressing and holding the SEND Key.

### TO ACCESS YOUR VOICE MAILBOX

- To dial voice mail directly, slide out the QWERTY keyboard and then press \* Key, 9 Key, 9 Key and then the SEND Key. Or, from idle mode, press the OK Key [OK] to unlock the keypad, press the Left Soft Key [Menu], the Directional Key to select "Messages", then slide out the QWERTY keyboard and press 2. Voicemail then the SEND Key.
- Follow the prompts to enter your lock code and retrieve your messages.

 If you hear your own system greeting when you dial \*VM ( ), press to interrupt it and follow the prompts to enter your lock code.

### VOICE MAIL SETUP (If calling from a touch-tone phone, enter your wireless number)

- Press \* Key, 9 Key, 9 Key and then the SEND Key.
- If you hear a greeting, press to proceed.

 You will be charged airtime for using your wireless phone to set-up or retrieve voice mail. Toll and/or long distance charges may also apply.

- Follow the prompts to personalize your lock code, greeting and mailbox options.

### VOICE MAIL SETUP (To access your voice mail from outside the network or from a touch-tone phone, enter your wireless number)

- Press \* Key, 9 Key, 9 Key and then the SEND Key.
- If you hear a greeting, press to proceed.

 You will be charged airtime for using your wireless phone to set-up or retrieve voice mail. Toll and/or long distance charges may also apply.



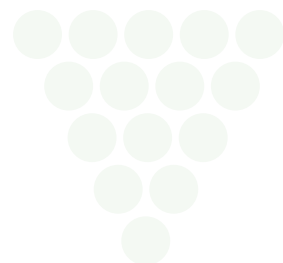





- Enter your lock code and press.



# Messages

## INBOX

The Inbox manages received Text, Picture, Voice messages. To access:

1. From idle mode, press the OK Key  [OK], press the Left Soft Key  [Menu], the Directional Key  to select "Messages", then slide out the QWERTY keyboard and press 3. **Inbox**.
2. Select a message and then press the OK Key  [OK]. The message is displayed. To delete a message, press the Left Soft Key  [Erase], then press the Right Soft Key  [Yes]. Before selecting a message, you can erase all inbox messages at once. To erase all inbox messages, press the Right Soft Key  [Options], select "Erase All", and then press the Right Soft Key  [Yes].

### MESSAGE ICON REFERENCE



Read



Priority





MMS Read



Unread











MMS Unread

3. With the message opened, press the Right Soft Key  [Options] to access the following:
  - **Play Again:** To play a received Picture message.
  - **Forward:** Select to forward the Text or Picture message.
  - **Save Picture (MMS Picture):** Select to save a picture to the "Picture Box" folder.
  - **Save As Ringtone (MMS Sound):** Select to save a sound to the "Sound Box" folder.
  - **Save Sound (MMS Sound):** Select to save a sound to the "Sound Box" folder.
  - **Read Message:** To readout sentences in received message.
  - **Save Quick Text:** Select to save received text msg to "Quick Text".
  - **To List Entries:** Select to save number to Contact List.
  - **Lock/Unlock:** Select to lock or unlock the Text or Picture message.
  - **Message Info:** Select to show received Text/Picture message information.
4. To reply to the sender, press the OK Key  [REPLY], then select "Text Message" or "Picture Message".

 Please refer to page 49 and 50 for more details on both "Text Message" and "Picture Message".

## SENT

Manages text and picture messages already sent or waiting to be sent.

1. From idle mode, press the OK Key  [OK], press the Left Soft Key  [Menu], the Directional Key  to select "Messages", then slide out the QWERTY keyboard and press 4. **Sent**.
2. Select a message and then press the OK Key  [OK]. The message is displayed. To delete a message, press the Left Soft Key  [Erase], then press the Right Soft Key  [Yes]. Before selecting a message, you can erase all sent messages at once. To erase all sent messages, press the Right Soft Key  [Options], select "Erase All", and then press the Right Soft Key  [Yes].

### MESSAGE ICON REFERENCE



Sent



Priority





Incomplete Delivery



Delivered



Sent Failed







3. With the message opened, press the Right Soft Key  [Options] to access the following:
  - **Play Again:** Select to play sent MMS message.
  - **Forward:** Select to forward the Text or Picture message.
  - **Lock/Unlock:** Select to lock or unlock the Text or Picture message.
  - **Read Message:** To readout sentences in sent message.
  - **Save Quick Text:** Select to save sent text msg to "Quick Text".
  - **To List Entries:** Select to save number to Contact List.
  - **Erase:** To delete the sent message.
  - **View Name Card:** To view the name card in sent message.
  - **Message Info:** Select to show sent Text/Picture message information.
4. To resend a sent Text or Picture message, press the OK Key  [RESEND].



# Messages

## DRAFTS

Draft Folder contains any draft messages or saved messages. If message composition is interrupted by receiving another message, the message of the current composition is automatically saved in the drafts folder.

1. From idle mode, press the OK Key  [OK] to unlock the keypad, press the Left Soft Key  [Menu], the Directional Key  to select "Messages", then slide out the QWERTY keyboard and press 5. Drafts.
2. Select a message and then press the OK Key  [EDIT]. The message is displayed.
3. To delete a message, press the Left Soft Key  [Erase], then press the Right Soft Key  [Yes].





### MESSAGE ICON REFERENCE

 MMS Drafts       SMS Drafts       Priority

4. Press the Right Soft Key  [Options] to access the following:
  - **Send:** Select to send a selected message.
  - **Lock/Unlock:** Select to lock or unlock the Text or Picture message.
  - **To List Entries:** Select to save number to Contact List.
  - **Erase All:** To erase all drafts messages.



## SETTINGS

To configure message settings:

1. From idle mode, press the OK Key  [OK] to unlock the keypad, press the Left Soft Key  [Menu], the Directional Key  to select "Messages", then slide out the QWERTY keyboard and press 6. Settings.
2. Press the Directional Key  up or down to highlight one of the settings below, then press the OK Key  [OK] to select it:

### NOTIFICATION

Allows you to choose how you are notified when you receive messages.

1. Select "Msg. & Icon" or "Icon Only" by pressing the Directional Key  up or down then press the OK Key  [OK].
  - **Msg. & Icon:** The notification message and icon displayed when you receive messages.
  - **Icon Only:** Only the notification icon displayed when you receive messages.



### ENTRY MODE

Sets an Entry Mode as a default.

1. Select "Abc", "ABC" or "123" by pressing the Directional Key  up or down then press the OK Key  [OK].



### AUTO SAVE

To view a saved memo:



1. Select "On", "Off" or "Prompt" by pressing the Directional Key  up or down then press the OK Key  [OK].
  - **On:** All sent messages saved in the Sent box.
  - **Off:** All sent messages not saved in the Sent box.
  - **Prompt:** "Yes", "No" dialogue box displayed after sent message.

### AUTO ERASE

Automatically erases inbox messages when new messages arrive.

1. Select "On" or "Off" by pressing the Directional Key  up or down then press the OK Key  [OK].
  - **On:** Oldest read message erased from inbox automatically when Inbox is full.
  - **Off:** Oldest read message not erased from inbox automatically when Inbox is full.





### AUTO RECEIVE

1. Select "On" or "Off" by pressing the Directional Key  up or down then press the OK Key  [OK].
  - **On:** Picture message downloaded automatically.
  - **Off:** Picture message must be retrieved from the inbox or at new Picture Message prompt.

# Messages

## QUICK TEXT

To edit the Quick Text you have saved:

1. Select a message from the list then press the OK Key  [EDIT].
2. To add a new Quick Text, press the Right Soft Key  [New]. Enter the new text then press the OK Key  [SAVE].
3. To erase a saved Quick Text, press the Left Soft Key  [Erase], then press the Right Soft Key  [Yes].



## VOICEMAIL #

To enter a new voicemail number or edit voicemail number.

1. Enter a new voicemail number or edit voicemail number then press the OK Key  [OK].

## CALLBACK #

Edits a default callback number so that the recipient can callback or reply.

1. Select "On" or "Off" by pressing the Directional Key  up or down then press the OK Key  [OK].
2. If "On" is selected, input a new callback number then press the OK Key  [OK].



## SIGNATURE

Create a signature that can be automatically inserted at the end of all Text and Picture messages.

1. To deactivate Signature function, select "None".
2. To input a "Signature", select "Custom". Enter your signature in the text box then press the OK Key  [OK].

## ERASE

To erase all messages stored in your Inbox, Drafts or Sent folders:

1. From idle mode, press the OK Key  [OK] to unlock the keypad, press the Left Soft Key  [Menu], the Directional Key  to select "Messages", then slide out the QWERTY keyboard and press 7. Erase.
  - Press "1. Erase Inbox" to erase all messages or only read messages stored in the Inbox folder.
  - Press "2. Erase Drafts" to erase all messages stored in the Drafts folder.
  - Press "3. Erase Sent" to erase all messages stored in Sent folder.
  - Press "4. Erase All" to erase all messages stored in the Inbox, Sent and Drafts folders.

 Locked messages cannot be erased.

2. Press the Right Soft Key  [Yes]. A confirmation message appears.



# Safety and Warranty



**This chapter addresses the safety guidelines and precautions to follow when operating your phone. Before operating your phone, please be aware of all the safety details. This chapter contains the terms and conditions of services and the warranty for your phone. Please review them thoroughly.**

Safety information for wireless handheld phones  
Safety information for FCC RF exposure  
SAR information  
Hearing Aid Compatibility (HAC) for wireless telecommunications devices  
FDA consumer update  
Avoid potential hearing loss.  
FCC compliance information  
12 month limited warranty

# Safety

## SAFETY INFORMATION FOR WIRELESS HANDHELD PHONES

 READ THIS INFORMATION BEFORE USING YOUR HANDHELD PORTABLE CELLULAR TELEPHONE

### EXPOSURE TO RADIO FREQUENCY SIGNALS

Your wireless handheld portable telephone is a low power radio transmitter and receiver. When it is ON, it receives and also sends out radio frequency (RF) signals.

In August 1996, the Federal Communications Commissions (FCC) adopted RF exposure guidelines with safety levels for handheld wireless phones. Those guidelines are consistent with the safety standards previously set by both U.S. and international standards bodies:

ANSI C95.1 (1992) \*

NCRP Report 86 (1986) \*

ICNIRP (1996) \*

Those standards were based on comprehensive and periodic evaluations of the relevant scientific literature. For example, over 120 scientists, engineers, and physicians from universities, government health agencies, and industry reviewed the available body of research to develop the ANSI Standard (C951).

The design of your phone complies with the FCC guidelines (and those standards).

1\* : American National Standards Institute.

2\* : National Council on Radiation protection and measurements.

3\* : International Commission on Nonionizing Radiation Protection.

### ANTENNA SAFETY

Use only the supplied or an approved replacement antenna. Unauthorized antennas, modifications, or attachments could impair call quality, damage the phone, or result in violation of FCC regulations. Please contact your local dealer for replacement antenna.

Do not use the phone with a damaged antenna. If a damaged antenna comes into contact with the skin, a minor burn may result. Please contact your local dealer for replacement antenna.

### DRIVING SAFETY

Talking on the phone while driving is extremely dangerous and is illegal in some states. Remember, safety comes first. Check the laws and regulations on the use of phones in the areas where you drive. Always obey them. Also, if using your phone while driving, please:

- Give full attention to driving. Driving safely is your first responsibility.
- Use hands-free operation, if available.
- Pull off the road and park before making or answering a call, if driving conditions so require.

If you must use the phone while driving, please use one-touch, speed dialing, and auto answer modes.

An airbag inflates with great force. DO NOT place objects, including both installed or portable wireless equipment, in the area over the airbag or in the air bag deployment area. If in-vehicle wireless equipment is improperly installed and the air bag inflates, serious injury could result.

 **WARNING:** Failure to follow these instructions may lead to serious personal injury and possible property damage.

### ELECTRONIC DEVICES

Your wireless handheld portable telephone is a low power radio transmitter and receiver. When it is ON, it receives and also sends out radio frequency (RF) signals.

Most modern electronic equipment is shielded from RF energy. However, certain electronic equipment may not be shielded against the RF signals from your wireless phone. Therefore, use of your phone must be restricted in certain situations.

### PACEMAKERS

The Health Industry Manufacturers Association recommends that a minimum separation of six (6") inches be maintained between a handheld wireless phone and a pacemaker to avoid potential interference with the pacemaker. These recommendations are consistent with the independent research by and recommendations of Wireless Technology Research. Persons with pacemakers:

- ALWAYS keep the phone more than six inches from your pacemaker when the phone is turned on.
- Do not carry the phone in a breast pocket.
- Use the ear opposite the pacemaker to minimize the potential for interference.
- If you have any reason to suspect that interference is taking place, turn your phone OFF immediately.

### HEARING AIDS

Some digital wireless phones may interfere with some hearing aids. In the event of such interference, you may want to consult your service provider (or call the customer service line to discuss alternatives).

# Safety

## OTHER MEDICAL DEVICES

If you use any other personal medical device, consult the manufacturer of your device to determine if they are adequately shielded from external RF energy. Your physician may be able to assist you in obtaining this information.

Turn your phone OFF in healthcare facilities when any regulations posted in these areas instruct you to do so. Hospitals or healthcare facilities may be using equipment that could be sensitive to external RF energy.

## VEHICLES

RF signals may affect improperly installed or inadequately shielded electronic systems in motor vehicles. Check with the manufacturer or its representative regarding your vehicle. You should also consult the manufacturer of any equipment that has been added to your vehicle.

## POSTED FACILITIES

Turn your phone OFF where posted notices so require.

## OTHER SAFETY GUIDELINES

### AIRCRAFT

FCC regulations prohibit using your phone while in the air. Turn your phone OFF before boarding an aircraft. Always request and obtain prior consent and approval of an authorized airline representative before using your phone aboard an aircraft. Always follow the instructions of the airline representative whenever using your phone aboard an aircraft, to prevent any possible interference with airborne electronic equipment.

### BLASTING AREAS

To avoid interfering with blasting operations, turn your phone OFF when in a "blasting area" or in areas posted: "Turn off two-way radio." Obey all signs and instructions.

### POTENTIALLY EXPLOSIVE ATMOSPHERES

Turn your phone OFF when in any area with a potentially explosive atmosphere and obey all signs and instructions. Sparks in such areas could cause an explosion or fire resulting in bodily injury or even death.

Areas with a potentially explosive atmosphere are often, but not always, clearly marked. They include fueling areas such as gas stations; below deck on boats; fuel or chemical transfer or storage facilities; vehicles using liquefied petroleum gas (such as propane or butane); areas where the air contains chemicals or particles, such as grain, dust, or metal powders; and any other area where you would normally be advised to turn off your vehicle's engine.

## ELECTRONIC DEVICES

Your Handheld Portable Telephone is a high quality piece of equipment. Before operating, read all instructions and cautionary markings on (1) AC/DC Travel Adaptor (2) Battery and (3) Product Using Battery.

Failure to follow the directions below could result in serious bodily injury and/or property damage due to battery liquid leakage, fire or rupture.

- DO NOT use this equipment in an extreme environment where high temperature or high humidity exists.
- DO NOT abuse the equipment. Avoid striking, shaking or shocking. When not using, lay down the unit to avoid possible damage due to instability.
- DO NOT expose this equipment to rain or spilled beverages.
- DO NOT use unauthorized accessories.
- DO NOT disassemble the phone or its accessories. If service or repair is required, return unit to an authorized PCD Personal Communications cellular service center. If unit is disassembled, the risk of electric shock or fire may result.
- DO NOT short-circuit the battery terminals with metal items etc.





# Safety

## SAFETY INFORMATION FOR FCC RF EXPOSURE

 WARNING! READ THIS INFORMATION BEFORE USING

### CAUTIONS

In August 1996 the Federal Communications Commission (FCC) of the United States with its action in Report and Order FCC 96-326 adopted an updated safety standard for human exposure to radio frequency electromagnetic energy emitted by FCC regulated transmitters. Those guidelines are consistent with the safety standard pre-viously set by both U.S. and international standards bodies. The design of this phone complies with the FCC guidelines and these international standards.

### BODY-WORN OPERATION

This device was tested for typical body-worn operations with the back of the phone kept 20 mm. from the body. To maintain compliance requirements, use only belt-clips, holsters or similar accessories that maintain a 20 mm separation distance between the user's Body and the back of the phone, including the antenna. The use of belt-clips, holsters and similar accessories should not contain metallic components in its assembly. The use of accessories that do not satisfy these requirements may not comply with FCC RF exposure requirements, and should be avoided.

 For more information about RF exposure, please visit the FCC website at [www.fcc.gov](http://www.fcc.gov).

## SAR INFORMATION

 THIS MODEL PHONE MEETS THE GOVERNMENT'S REQUIREMENTS FOR EXPOSURE TO RADIO WAVES.

Your wireless phone is a radio transmitter and receiver. It is designed and manufactured not to exceed the emission limits for exposure to radiofrequency (RF) energy set by the Federal Communications Commission of the U.S. Government. These limits are part of comprehensive guidelines and establish permitted levels of RF energy for the general population. The guidelines are based on standards that were developed by independent scientific organizations through periodic and thorough evaluation of scientific studies. The standards include a substantial safety margin designed to assure the safety of all persons, regardless of age and health.

The exposure standard for wireless mobile phones employs a unit of measurement known as the Specific Absorption Rate, or SAR. The SAR limit set by the FCC is 1.6 W/kg. \* Tests for SAR are conducted with the phone transmitting at its highest certified power level in all tested frequency bands. Although the SAR is determined at the highest certified power level, the actual SAR level of the phone while operating can be well below the maximum value. This is because the phone is designed to operate at multiple power levels so as to use only the power required to reach the network. In general, the closer you are to a wireless base station antenna, the lower the power output.

Before a phone model is available for sale to the public, it must be tested and certified to the FCC that it does not exceed the limit established by the government adopted requirement for safe exposure. The tests are performed in positions and locations (e.g., at the ear and worn on the body) as required by the FCC for each model. The highest SAR value for this model phone when tested for use at the ear is 1.3 W/Kg and when worn on the body, as described in this user guide, is 0.57 W/Kg. (Body-worn measurements differ among phone models, depending upon available accessories and FCC requirements). While there may be differences between the SAR levels of various phones and at various positions, they all meet the government requirement for safe exposure.

The SAR testing for Body-worn operation was performed with a belt clip that provided a 20 mm separation. The User's Manual indicates that any holsters/clips used with this device should contain no metallic components.

The FCC has granted an Equipment Authorization for this model phone with all reported SAR levels evaluated as in compliance with the FCC RF exposure guidelines. SAR information on this model phone is on file with the FCC and can be found under the Display Grant section of <http://www.fcc.gov/oet/ea> after searching on PP4ELVISPLUS. Additional information on Specific Absorption Rates (SAR) can be found on the Cellular Telecommunications Industry Association (CTIA) web-site at <http://www.wow-com.com>.

\* In the United States and Canada, the SAR limit for mobile phones used by the public is 1.6 watts/kg (W/kg) averaged over one gram of tissue. The standard incorporates a sub-stantial margin of safety to give additional protection for the public and to account for any variations in measurements.

## HEARING AID COMPATIBILITY (HAC) FOR WIRELESS TELECOMMUNICATIONS DEVICES

### PCD'S COMMITMENT

PCD believes that all of our customers should be able to enjoy the benefits of digital wireless technologies. We are committed to providing a selection of compatible devices for our customers who wear hearing aids.

THIS PHONE HAS A HAC RATING OF M4

### WHAT IS HEARING AID COMPATIBILITY?

The Federal Communications Commission has implemented rules and a rating system designed to enable people who wear hearing aids to more effectively use these wireless telecommunications devices. The standard for compatibility of digital wireless phones with hearing aids is set forth in American National Standard Institute (ANSI) standard C63.19. There are two sets of ANSI standards with ratings from one to four (four being the best rating): an "M" rating for reduced interference making it easier to hear conversations on the phone when using the hearing aid microphone, and a "T" rating that enables the phone to be used with hearing aids operating in the telecoil mode thus reducing unwanted background noise.

# Safety

## HOW WILL I KNOW WHICH WIRELESS PHONES ARE HEARING AID COMPATIBLE?

The Hearing Aid Compatibility rating is displayed on the wireless phone box.



A phone is considered Hearing Aid Compatible for acoustic coupling (microphone mode) if it has an "M3" or "M4" rating. A digital wireless phone is considered Hearing Aid Compatible for inductive coupling (telecoil mode) if it has a "T3" or "T4" rating.

## HOW WILL I KNOW IF MY HEARING AID WILL WORK WITH A PARTICULAR DIGITAL WIRELESS PHONE?

You'll want to try a number of wireless phones so that you can decide which works the best with your hearing aids.

You may also want to talk with your hearing aid professional about the extent to which your hearing aids are immune to interference, if they have wireless phone shielding, and whether your hearing aid has a HAC rating.

### For more information about hearing aids and digital wireless phones:

- FCC Hearing Aid Compatibility and Volume Control – <http://www.fcc.gov/cgb/dro/hearing.html>
- Hearing Loss Association of America – <http://www.hearingloss.org/learn/cellphonetech.asp>
- CTIA – <http://www.accesswireless.org/hearingaid/>
- Gallaudet University, RERC – <http://tap.gallaudet.edu/voice>

## FDA CONSUMER UPDATE



### U.S. FOOD AND DRUG ADMINISTRATION - CENTER FOR DEVICES AND RADIOLOGICAL HEALTH CONSUMER UPDATE ON WIRELESS PHONES

#### 1. Do wireless phones pose a health hazard?

The available scientific evidence does not show that any health problems are associated with using wireless phones. There is no proof, however, that wireless phones are absolutely safe. Wireless phones emit low levels of radiofrequency energy (RF) in the microwave range while being used. They also emit very low levels of RF when in the stand-by mode. Whereas high levels of RF can produce health effects (by heating tissue), exposure to low level RF that does not produce heating effects causes no known adverse health effects. Many studies of low level RF exposures have not found any biological effects. Some studies have suggested that some bio-logical effects may occur, but such findings have not been confirmed by additional research. In some cases, other researchers have had difficulty in reproducing those studies, or in determining the reasons for inconsistent results.

#### 2. What is FDA's role concerning the safety of wireless phones?

Under the law, FDA does not review the safety of radiation-emitting consumer products such as wireless phones before they can be sold, as it does with new drugs or medical devices. However, the agency has authority to take action if wireless phones are shown to emit radiofrequency energy (RF) at a level that is hazardous to the user. In such a case, FDA could require the manufacturers of wireless phones to notify users of the health hazard and to repair, replace or recall the phones so that the hazard no longer exists. Although the existing scientific data do not justify FDA regulatory actions, FDA has urged the wireless phone industry to take a number of steps, including the following:

- Support needed research into possible biological effects of RF of the type emitted by wireless phones;
- Design wireless phones in a way that minimizes any RF exposure to the user that is not necessary for device function; and
- Cooperate in providing users of wireless phones with the best possible information on possible effects of wireless phone use on human health.

FDA belongs to an interagency working group of the federal agencies that have responsibility for different aspects of RF safety to ensure coordinated efforts at the federal level. The following agencies belong to this working group:

- National Institute for Occupational Safety and Health
- Environmental Protection Agency
- Federal Communications Commission
- Occupational Safety and Health Administration
- National Telecommunications and Information Administration

The National Institutes of Health participates in some inter-agency working group activities, as well. FDA shares regulatory responsibilities for wireless phones with the Federal Communications Commission (FCC). All phones that are sold in the United States must comply with FCC safety guidelines that limit RF exposure. FCC relies on FDA and other health agencies for safety questions about wireless phones. FCC also regulates the base stations that the wireless phone networks rely upon. While these base stations operate at higher power than do the wireless phones themselves, the RF exposures that people get from these base stations are typically thousands of times lower than those they can get from wireless phones. Base stations are thus not the subject of the safety questions discussed in this document.

### 3. What kinds of phones are the subject of this update?

The term “wireless phone” refers here to hand-held wireless phones with built-in antennas, often called “cell,” “mobile,” or “PCS” phones. These types of wireless phones can expose the user to measurable radiofrequency energy (RF) because of the short distance between the phone and the user’s head. These RF exposures are limited by Federal Communications Commission safety guidelines that were developed with the advice of FDA and other federal health and safety agencies. When the phone is located at greater distances from the user, the exposure to RF is drastically lower because a person’s RF exposure decreases rapidly with increasing distance from the source. The so-called “cordless phones,” which have a base unit connected to the telephone wiring in a house, typically operate at far lower power levels, and thus produce RF exposures far below the FCC safety limits.

### 4. What are the results of the research done already?

The research done thus far has produced conflicting results, and many studies have suffered from flaws in their research methods. Animal experiments investigating the effects of radiofrequency energy (RF) exposures characteristic of wireless phones have yielded conflicting results that often cannot be repeated in other laboratories. A few animal studies, however, have suggested that low levels of RF could accelerate the development of cancer in laboratory animals.

However, many of the studies that showed increased tumor development used animals that had been genetically engineered or treated with cancer-causing chemicals so as to be predisposed to develop cancer in the absence of RF exposure. Other studies exposed the animals to RF for up to 22 hours per day. These conditions are not similar to the conditions under which people use wireless phones, so we don’t know with certainty what the results of such studies mean for human health. Three large epidemiology studies have been published since December 2000. Between them, the studies investigated any possible association between the use of wireless phones and primary brain cancer, glioma, meningioma, or acoustic neuroma, tumors of the brain or salivary gland, leukemia, or other cancers. None of the studies demonstrated the existence of any harmful health effects from wireless phone RF exposures. However, none of the studies can answer questions about long-term exposures, since the average period of phone use in these studies was around three years.

### 5. What research is needed to decide whether RF exposure from wireless phones poses a health risk?

A combination of laboratory studies and epidemiological studies of people actually using wireless phones would provide some of the data that are needed. Lifetime animal exposure studies could be completed in a few years. However, very large numbers of animals would be needed to provide reliable proof of a cancer promoting effect if one exists. Epidemiological studies can provide data that is directly applicable to human populations, but 10 or more years’ follow-up may be needed to provide answers about some health effects, such as cancer. This is because the interval between the time of exposure to a cancer-causing agent and the time tumors develop - if they do - may be many, many years. The interpretation of epidemiological studies is hampered by difficulties in measuring actual RF exposure during day-to-day use of wireless phones. Many factors affect this measurement, such as the angle at which the phone is held, or which model of phone is used.

### 6. What is FDA doing to find out more about the possible health effects of wireless phone RF?

FDA is working with the U.S. National Toxicology Program and with groups of investigators around the world to ensure that high priority animal studies are conducted to address important questions about the effects of exposure to radiofrequency energy (RF). FDA has been a leading participant in the World Health Organization International Electromagnetic Fields (EMF) Project since its inception in 1996. An influential result of this work has been the development of a detailed agenda of research needs that has driven the establishment of new research programs around the world. The Project has also helped develop a series of public information documents on EMF issues. FDA and the Cellular Telecommunications & Internet Association (CTIA) have a formal Cooperative Research and Development Agreement (CRADA) to do research on wireless phone safety. FDA provides the scientific oversight, obtaining input from experts in government, industry, and academic organizations. CTIA-funded research is conducted through contracts to independent investigators. The initial research will include both laboratory studies and studies of wireless phone users. The CRADA will also include a broad assessment of additional research needs in the context of the latest research developments around the world.

### 7. How can I find out how much radiofrequency energy exposure I can get by using my wireless phone?

All phones sold in the United States must comply with Federal Communications Commission (FCC) guidelines that limit radiofrequency energy (RF) exposures. FCC established these guidelines in consultation with FDA and the other federal health and safety agencies. The FCC limit for RF exposure from wireless telephones is set at a Specific Absorption Rate (SAR) of 1.6 watts per kilogram (1.6 W/kg). The FCC limit is consistent with the safety standards developed by the Institute of Electrical and Electronic Engineers (IEEE) and the National Council on Radiation Protection and Measurement. The exposure limit takes into consideration the body’s ability to remove heat from the tissues that absorb energy from the wireless phone and is set well below levels known to have effects. Manufacturers of wireless phones must report the RF exposure level for each model of phone to the FCC. The FCC website (<http://www.fcc.gov/oet/rfsafety>) gives directions for locating the FCC identification number on your phone so you can find your phone’s RF exposure level in the online listing.

### 8. What has FDA done to measure the radiofrequency energy coming from wireless phones?

The Institute of Electrical and Electronic Engineers (IEEE) is developing a technical standard for measuring the radiofrequency energy (RF) exposure from wireless phones and other wireless handsets with the participation and leadership of FDA scientists and engineers. The standard, “Recommended Practice for Determining the Spatial-Peak Specific Absorption Rate (SAR) in the Human Body Due to Wireless Communications Devices: Experimental Techniques,” sets forth the first consistent test methodology for measuring the rate at which RF is deposited in the heads of wireless phone users. The test method uses a tissue-simulating model of the human head. Standardized SAR test methodology is expected to greatly improve the consistency of measurements made at different laboratories on the same phone. SAR is the measurement of the amount of energy absorbed in tissue, either by the whole body or a small part of the body. It is measured in watts/kg (or milliwatts/g) of matter. This measurement is used to determine whether a wireless phone complies with safety guidelines.

# Safety

## 9. What steps can I take to reduce my exposure to radiofrequency energy from my wireless phone?

If there is a risk from these products—and at this point we do not know that there is—it is probably very small. But if you are concerned about avoiding even potential risks, you can take a few simple steps to minimize your exposure to radiofrequency energy (RF). Since time is a key factor in how much exposure a person receives, reducing the amount of time spent using a wireless phone will reduce RF exposure.

- If you must conduct extended conversations by wireless phone every day, you could place more distance between your body and the source of the RF, since the exposure level drops off dramatically with distance.

For example, you could use a headset and carry the wireless phone away from your body or use a wireless phone connected to a remote antenna. Again, the scientific data do not demonstrate that wireless phones are harmful. But if you are concerned about the RF exposure from these products, you can use measures like those described above to reduce your RF exposure from wireless phone use.

## 10. What about children using wireless phones?

The scientific evidence does not show a danger to users of wireless phones, including children and teenagers. If you want to take steps to lower exposure to radiofrequency energy (RF), the measures described above would apply to children and teenagers using wireless phones. Reducing the time of wireless phone use and increasing the distance between the user and the RF source will reduce RF exposure. Some groups sponsored by other national governments have advised that children be discouraged from using wireless phones at all. For example, the government in the United Kingdom distributed leaflets containing such a recommendation in December 2000. They noted that no evidence exists that using a wireless phone causes brain tumors or other ill effects. Their recommendation to limit wireless phone use by children was strictly precautionary; it was not based on scientific evidence that any health hazard exists.

## 11. What about wireless phone interference with medical equipment?

Radiofrequency energy (RF) from wireless phones can interact with some electronic devices. For this reason, FDA helped develop a detailed test method to measure electromagnetic interference (EMI) of implanted cardiac pacemakers and defibrillators from wireless telephones. This test method is now part of a standard sponsored by the Association for the Advancement of Medical Instrumentation (AAMI). The final draft, a joint effort by FDA, medical device manufacturers, and many other groups, was completed in late 2000. This standard will allow manufacturers to ensure that cardiac pacemakers and defibrillators are safe from wireless phone EMI. FDA has tested hearing aids for interference from handheld wireless phones and helped develop a voluntary standard sponsored by the Institute of Electrical and Electronic Engineers (IEEE). This standard specifies test methods and performance requirements for hearing aids and wireless phones so that no interference occurs when a person uses a “compatible” phone and a “compatible” hearing aid at the same time. This standard was approved by the IEEE in 2000. FDA continues to monitor the use of wireless phones for possible interactions with other medical devices. Should harmful interference be found to occur, FDA will conduct testing to assess the interference and work to resolve the problem.

## 12. Where can I find additional information?

For additional information, please refer to the following resources:

- FDA web page on wireless phones (<http://www.fda.gov/cellphones>)
- Federal Communications Commission (FCC) RF Safety Program (<http://www.fcc.gov/oet/rfsafety>)
- International Commission on Non-Ionizing Radiation Protection (<http://www.icnirp.de>)
- World Health Organization (WHO) International EMF Project (<http://www.who.int/emf>)
- National Radiological Protection Board (UK) (<http://www.hpa.org.uk/radiation/>)

## AVOID POTENTIAL HEARING LOSS.

Prolonged exposure to loud sounds (including music) is the most common cause of preventable hearing loss. Some scientific research suggests that using portable audio devices, such as portable music players and cellular telephones, at high volume settings for long durations may lead to permanent noise-induced hearing loss. This includes the use of headphones (including headsets, earbuds and Bluetooth® or other wireless devices). Exposure to very loud sound has also been associated in some studies with tinnitus (a ringing in the ear), hypersensitivity to sound and distorted hearing. Individual susceptibility to noise-induced hearing loss and other potential hearing problems varies.

The amount of sound produced by a portable audio device varies depending on the nature of the sound, the device, the device settings and the headphones. You should follow some commonsense recommendations when using any portable audio device:

- Set the volume in a quiet environment and select the lowest volume at which you can hear adequately.
- When using headphones, turn the volume down if you cannot hear the people speaking near you or if the person sitting next to you can hear what you are listening to.
- Do not turn the volume up to block out noisy surroundings. If you choose to listen to your portable device in a noisy environment, use noise-cancelling headphones to block out background environmental noise.
- Limit the amount of time you listen. As the volume increases, less time is required before your hearing could be affected.
- Avoid using headphones after exposure to extremely loud noises, such as rock concerts, that might cause temporary hearing loss. Temporary hearing loss might cause unsafe volumes to sound normal.
- Do not listen at any volume that causes you discomfort. If you experience ringing in your ears, hear muffled speech or experience any temporary hearing difficulty after listening to your portable audio device, discontinue use and consult your doctor.

# Safety

## YOU CAN OBTAIN ADDITIONAL INFORMATION ON THIS SUBJECT FROM THE FOLLOWING SOURCES:

### **American Academy of Audiology**

11730 Plaza American Drive, Suite 300

Reston, VA 20190

Voice: 800-AAA-2336, 703-790-8466

Email: [info@audiology.org](mailto:info@audiology.org)

Internet: [www.audiology.org](http://www.audiology.org)

### **National Institute on Deafness and Other Communication Disorders National Institutes of Health**

31 Center Drive, MSC 2320

Bethesda, MD USA 20892-2320

Voice: (301) 496-7243

Email: [nidcdinfo@nidcd.nih.gov](mailto:nidcdinfo@nidcd.nih.gov)

Internet: <http://www.nidcd.nih.gov/health/hearing>

### **National Institute for Occupational Safety and Health**

Hubert H. Humphrey Bldg.

200 Independence Ave., SW

Washington, DC 20201

Voice: 1-800-CDC-INFO (1-800-232-4636)

Internet: <http://www.cdc.gov/niosh/topics/noise/default.html>

## FCC COMPLIANCE INFORMATION

This device complies with Part 15 of FCC Rules. Operation is subject to the following two conditions:

(1) This device may not cause harmful interference, and (2) This device must accept any interference received. Including interference that may cause undesired operation.

### INFORMATION TO THE USER

This equipment has been tested and found to comply with the limits for a Class B digital device pursuant to Part 15 of the FCC Rules. These limits are designed to provide reasonable protection against harmful interference in a residential installation. This equipment generates, uses, and can radiate radio frequency energy and, if not installed and used in accordance with the instructions, may cause harmful interference to radio communications. However, there is no guarantee that interference will not occur in a particular installation. If this equipment does cause harmful interference to radio or television reception, which can be determined by turning the equipment off and on, the user is encouraged to try to correct the interference by one or more of the following measures:

- Reorient or relocate the receiving antenna. Increase the separation between the equipment and receiver.
- Connect the equipment into an outlet of a circuit different from that to which the receiver is connected.
- Consult the dealer or an experienced radio/TV technician for assistance.

 **CAUTION:** Changes or modification not expressly approved by the party responsible for Compliance could void the user's authority to operate the equipment. Connecting of peripherals requires the use of grounded shielded signal cables.



# Warranty

## 12 MONTH LIMITED WARRANTY

PCD Personal Communications (the Company) warrants to the original retail purchaser of this PCD Personal Communications handheld portable cellular telephone, that should this product or any part thereof during normal consumer usage and conditions, be proven defective in material or workmanship that results in product failure within the first twelve (12) month period from the date of purchase, such defect(s) will be repaired or replaced (with new or rebuilt parts) at the Company's option, without charge for parts or labor directly related to the defect(s).

The antenna, keypad, display, rechargeable battery and battery charger, if included, are similarly warranted for twelve (12) months from date of purchase.

This Warranty extends only to consumers who purchase the product in the United States or Canada and it is not transferable or assignable.

This Warranty does not apply to:

- (a) Product subjected to abnormal use or conditions, accident, mishandling, neglect, unauthorized alteration, misuse, improper installation or repair or improper storage;
- (b) Product whose mechanical serial number or electronic serial number has been removed, altered or defaced.
- (c) Damage from exposure to moisture, humidity, excessive temperatures or extreme environmental conditions;
- (d) Damage resulting from connection to, or use of any accessory or other product not approved or authorized by the Company;
- (e) Defects in appearance, cosmetic, decorative or structural items such as framing and non-operative parts;
- (f) Product damaged from external causes such as fire, flooding, dirt, sand, weather conditions, battery leakage, blown fuse, theft or improper usage of any electrical source.

The Company disclaims liability for removal or reinstallation of the product, for geographic coverage, for inadequate signal reception by the antenna or for communications range or operation of the cellular system as a whole.

When sending your wireless device to PCD Personal Communications for repair or service, please note that any personal data or software stored on the device may be inadvertently erased or altered. Therefore, we strongly recommend you make a back up copy of all data and software contained on your device before submitting it for repair or service. This includes all contact lists, downloads (i.e. third-party software applications, ringtones, games and graphics) and any other data added to your device. In addition, if your wireless device utilizes a SIM or Multimedia card, please remove the card before submitting the device and store for later use when your device is returned, PCD Personal Communications is not responsible for and does not guarantee restoration of any third-party software, personal information or memory data contained in, stored on, or integrated with any wireless device, whether under warranty or not, returned to PCD Personal Communications for repair or service.

To obtain repairs or replacement within the terms of this Warranty, the product should be delivered with proof of Warranty coverage (e.g. dated bill of sale), the consumer's return address, daytime phone number and/or fax number and complete description of the problem, transportation prepaid, to the Company at the address shown below or to the place of purchase for repair or replacement processing. In addition, for reference to an authorized Warranty station in your area, you may telephone in the United States (800) 229-1235, and in Canada (800) 465-9672 (in Ontario call 416-695-3060).

THE EXTENT OF THE COMPANY'S LIABILITY UNDER THIS WARRANTY IS LIMITED TO THE REPAIR OR REPLACEMENT PROVIDED ABOVE AND, IN NO EVENT, SHALL THE COMPANY'S LIABILITY EXCEED THE PURCHASE PRICE PAID BY PURCHASER FOR THE PRODUCT.

ANY IMPLIED WARRANTIES, INCLUDING ANY IMPLIED WARRANTY OF MERCHANTABILITY OR FITNESS FOR A PARTICULAR PURPOSE, SHALL BE LIMITED TO THE DURATION OF THIS WRITTEN WARRANTY. ANY ACTION FOR BREACH OF ANY WARRANTY MUST BE BROUGHT WITHIN A PERIOD OF 18 MONTHS FROM DATE OF ORIGINAL PURCHASE. IN NO CASE SHALL THE COMPANY BE LIABLE FOR AN SPECIAL CONSEQUENTIAL OR INCIDENTAL DAMAGES FOR BREACH OF THIS OR ANY OTHER WARRANTY, EXPRESS OR IMPLIED, WHATSOEVER. THE COMPANY SHALL NOT BE LIABLE FOR THE DELAY IN RENDERING SERVICE UNDER THIS WARRANTY OR LOSS OF USE DURING THE TIME THE PRODUCT IS BEING REPAIRED OR REPLACED.

No person or representative is authorized to assume for the Company any liability other than expressed herein in connection with the sale of this product.

Some states or provinces do not allow limitations on how long an implied warranty lasts or the exclusion or limitation of incidental or consequential damage so the above limitation or exclusions may not apply to you. This Warranty gives you specific legal rights, and you may also have other rights, which vary from state to state or province to province.

**IN USA:** PCD Personal Communications 555 Wireless Blvd. Hauppauge, NY 11788 (800) 229-1235

**IN CANADA:** PCD Canada Company 5535 Eglinton Avenue West Suite# 234 Toronto, ON M9C 5K5 (800) 465-9672

