

EM-70B

E-Menu

User's Manual

Table of Contents

Preface	1
Copyright	1
Safety Information	1
Regulatory Statement	2
SAR Information	2
Federal Communications Commission Statement	2
RF Exposure Information (SAR)	3
WEEE Notice	3
FCC Regulations	4
About this Manual	4
Getting Started	5
Introduction	5
Features	5
Accessories	5
Package Contents	5
Optional Accessories	5
Tablet Components	6
Top and Front	6
Back and Bottom	7
Installing the SD Card	8
Installing the SIM Card (Optional)	8
Charging the Battery	9
Powering On the Tablet	10
Sleep Mode	10
Unlocking the Screen	11
Initial Settings	11
Connecting to Network	11
Using Wi-Fi Connection	11
Using Data Network Connection	12
Using the Tablet	13
Understanding the Interface	13
The Home Screen	13
Status and Notifications	14
Managing the Home Screen	15
Using the Applications	16
Typing on the Keyboard	16
Searching for Items	17
Opening Applications	17
Killing Tasks	17
Using Tags	18
Activating NFC	18
Scanning Tags	18
Sharing Tags	18

Using ES File Explorer	19
Managing Files and Folders	20
Changing the Tablet Settings	21
Settings Menu	21
Managing Wireless and Network Settings	22
Connecting to Wireless Networks	22
Connecting to Bluetooth Devices	22
Setting Up VPN	23
Changing Basic Settings	23
Sound	23
Display	24
Date and Time	24
Changing Language and Keyboard Settings	25
Changing the Device Language	25
Managing Keyboard Settings	25
Using the User Dictionary	26
Managing Storage Space	27
Erasing Storage Card Content	27
Removing the Storage Card	27
Managing Accounts	28
Adding Exchange Accounts	28
Adding Google Accounts	28
Syncing Accounts	28
Removing Accounts	29
Advanced Settings	30
Location and Security	30
Power Manager	30
Privacy	31
Applications	31
Accessibility	31
About the Device	31
Using Optional Accessories	32
Dock Cradle	32
Parts and Functions	32
Docking the Tablet	32
Making Connections	33
MSR Module	34
Appendix	35
Troubleshooting	35
Specifications	36

Preface

Copyright

Copyright © 2012. All rights reserved.

No part of this user manual may be reproduced, transmitted, stored in a retrieval system, or translated into any language, in any form or by any means, without permission from the manufacturer.

Google, the Google logo, Android, the Android logo and Tags are trademarks of Google Inc.

ES File Explorer is a trademark of EStrong's Inc.

Wi-Fi is a registered trademark of the Wireless Fidelity Alliance.

microSD is a trademark of SD Card Association.

Bluetooth and the Bluetooth logo are trademarks owned by Bluetooth SIG, Inc.

Java, JME and all other Java-based marks are trademarks or registered trademarks of Sun Microsystems, Inc. in the United States and other countries.

All other products use in this device and trademarks mentioned herein are trademarks or registered trademarks of their respective owners.

Safety Information

Read the following safety information before using your device.

- Use only the power adapter provided by the manufacturer. Use of unauthorized accessories may void your warranty.
- Avoid using the device near electromagnetic sources such as TVs, radios, and microwave ovens.
- Unplug the power adapter from the wall outlet during lightning storms to avoid electric shock or fire.
- Do not expose the device to direct sunlight.
- Do not use harsh chemicals or detergents to clean your device.
- Do not handle the device with wet hands while it is being charged. This may cause an electric shock or serious damage to the device.
- Do not store your device in temperatures higher than 60°C.
- The operating temperature for this device is from 10°C to 55°C.
- Do not use the device on board an aircraft.

Regulatory Statement

SAR Information

THIS MOBILE DEVICE MEETS GUIDELINES FOR EXPOSURE TO RADIO WAVES. Your mobile device is a radio transmitter and receiver. It is designed not to exceed the limits for exposure to radio waves recommended by international guidelines. These guidelines were developed by the independent scientific organization ICNIRP and include safety margins designed to assure the protection of all persons, regardless of age and health.

The exposure guidelines for mobile devices employ a unit of measurement known as the Specific Absorption Rate or SAR. The SAR limit stated in the ICNIRP guidelines is 2.0 W/kg averaged over 10 grams of tissue. Tests for SAR are conducted using standard operating positions with the device transmitting at its highest certified power level in all tested frequency bands. The actual SAR level of an operating device can be below the maximum value because the device is designed to use only the power required to reach the network. That amount changes depending on a number of factors such as how close you are to a network base station. The highest SAR value under the ICNIRP guidelines for use of the device at the body is 0.403 W/kg. Use of device accessories and enhancements may result in different SAR values. SAR values may vary depending on national reporting and testing requirements and the network band. The device could be used with a separation distance of 0 cm to the human body.

Federal Communications Commission Statement

This device complies with Part 15 of the FCC Rules. Operation is subject to the following two conditions: (1) This device may not cause harmful interference, and (2) this device must accept any interference received, including interference that may cause undesired operation.

This device has been tested and found to comply with the limits for a Class B digital device, pursuant to Part 15 of the FCC Rules. These limits are designed to provide reasonable protection against harmful interference in a residential installation. This device generates, uses, and can radiate radio frequency energy and, if not installed and used in accordance with the instructions, may cause harmful interference to radio communications. However there is no guarantee that interference will not occur in a particular installation if this device does cause harmful interference to radio or television reception, which can be determined by turning the device off and on, the user is encouraged to try to correct the interference by one or more of the following measures:

- Reorient or relocate the receiving antenna.- Increase the separation between the equipment and receiver.
- Connect the equipment into an outlet on a circuit different from that to which the receiver connected.- Consult the dealer or an experienced radio/TV technician for help.

Changes or modifications not expressly approved by the party responsible for compliance could void the user's authority to operate the equipment.

RF Exposure Information (SAR)

This device meets the government's requirements for exposure to radio waves.

This device is designed and manufactured not to exceed the emission limits for exposure to radio frequency (RF) energy set by the Federal Communications Commission of the U.S. Government. The exposure standard employs a unit of measurement known as the Specific Absorption Rate, or SAR. The SAR limit set by the FCC is 1.6W/kg. Tests for SAR are conducted using standard operating positions accepted by the FCC with the EUT transmitting at the specified power level in different channels.

The highest SAR value for the device as reported to the FCC is 0.75 W/kg when placed next to the body.

The FCC has granted an Equipment Authorization for this device with all reported SAR levels evaluated as in compliance with the FCC RF exposure guidelines. SAR information on this device is on file with the FCC and can be found under the Display Grant section of www.fcc.gov/oet/ea/fccid after searching on FCC ID: NDPEM-70B.

This device is compliance with SAR for general population /uncontrolled exposure limits in ANSI/IEEE C95.1-1999 and had been tested in accordance with the measurement methods and procedures specified in OET Bulletin 65 Supplement C.

WEEE Notice

The WEEE logo on the product or on its box indicates that this product must not be disposed of or dumped with your other household waste. You are liable to dispose of all your electronic or electrical waste equipment by relocating over to the specified collection point for recycling of such hazardous waste. Isolated collection and proper recovery of your electronic and electrical waste equipment at the time of disposal will allow us to help conserve natural resources. Moreover, proper recycling of the electronic and electrical waste equipment will ensure safety of human health and environment. For more information about electronic and electrical waste equipment disposal, recovery, and collection points, please contact your local city center, household waste disposal service, shop from where you purchased the equipment, or manufacturer of the equipment.



FCC Regulations:

15.19(a)(3):

This device complies with part 15 of the FCC Rules. Operation is subject to the following two conditions: (1) This device may not cause harmful interference, and (2) this device must accept any interference received, including interference that may cause undesired operation.

15.105(b):

NOTE: This equipment has been tested and found to comply with the limits for a Class B digital device, pursuant to part 15 of the FCC Rules. These limits are designed to provide reasonable protection against harmful interference in a residential installation.

This equipment generates, uses and can radiate radio frequency energy and, if not installed and used in accordance with the instructions, may cause harmful interference to radio communications.

However, there is no guarantee that interference will not occur in a particular installation. If this equipment does cause harmful interference to radio or television reception, which can be determined by turning the equipment off and on, the user is encouraged to try to correct the interference by one or more of the following measures:

- Reorient or relocate the receiving antenna.
- Increase the separation between the equipment and receiver.
- Connect the equipment into an outlet on a circuit different from that to which the receiver is connected.
- Consult the dealer or an experienced radio/ TV technician for help

Changes or modifications not expressly approved by the party responsible for compliance could void the user's authority to operate the equipment.

About this Manual

The content in this manual is as accurate as possible. However, due to continuous product improvements, some contents and specifications may have been changed since this manual was written. In this case, take the actual device as basis.

No part of this user manual may be reproduced, transmitted, stored in a retrieval system, or translated into any language, in any form or by any means, without a written permission from the manufacturer.

Information is subject to change without prior notice.

Getting Started

Introduction

Congratulations on your purchase of the Enterprise Tablet. This Enterprise Tablet is a stylish commercial tablet that uses the latest ARM technology supporting mobile work input to ensure a high processing performance. Equipped with the energy-efficient Freescale ARM CPU in an Android system, the Enterprise Table provides the highest usability matching various industrial needs.

Designed for use in the field, logistics, retail and restaurants, the Enterprise Tablet improves profitability and customer satisfaction.

Features

- Auto Rotation Display
- Light Weight
- Dust and Spill Resistant
- Flexible OS Android 2.3
- Integrated RFID Module 13.56 Mhz
- Dock Cradle
- Cradle with Second Battery (optional)
- SIM Card Slot (optional)
- Expandable with WCDMA module / Mini PCI-e (optional)

Accessories

Package Contents

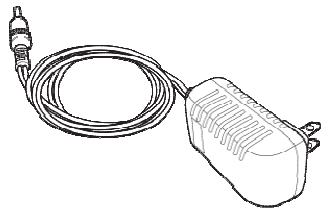
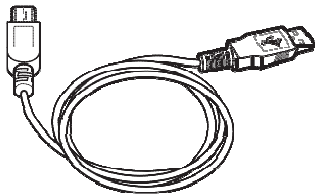
	
Power Adaptor	USB Cable

Optional Accessories

- Dock Cradle
- MSR Module
- Bar Code Reader
- WCDMA / Mini PCI-e

Tablet Components

Top and Front

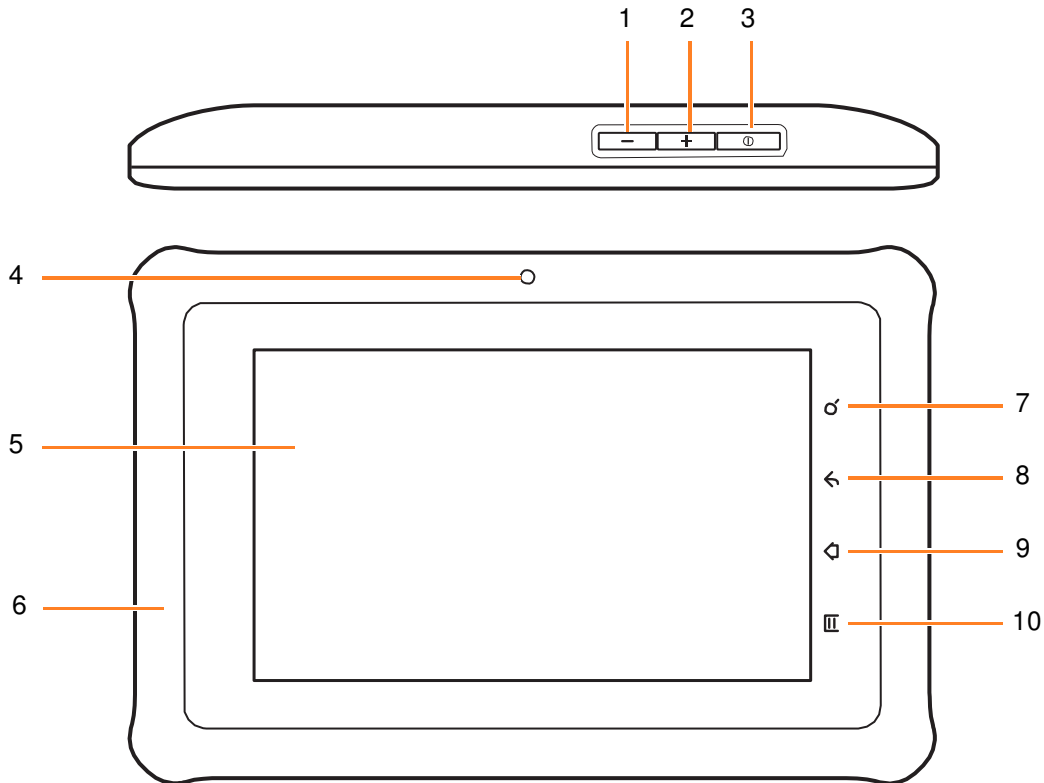

No.	Item	Description
1	Volume Down	Press to decrease volume.
2	Volume Up	Press to increase volume.
3	Power Button	<ul style="list-style-type: none"> • Press and hold for 2 seconds to turn the device on or off. • Press to turn the screen backlight on or off.
4	Status LED	Indicates the power and charging status: <ul style="list-style-type: none"> • Red: Battery is charging. • Green: Device power is on. • Off: Device power is off.
5	Touch Screen	<ul style="list-style-type: none"> • Displays the screen output. • Touch and drag items on the screen to provide user input.
6	Protective Case	Protects the tablet from drops and rough-handling.
7	Search Key	Touch to search device applications and contacts or search the Internet.
8	Back Key	Touch to return to the previous screen or menu.
9	Home Key	Touch to return to the Home screen.
10	Menu Key	Touch to open the menu of the current application.

Back and Bottom

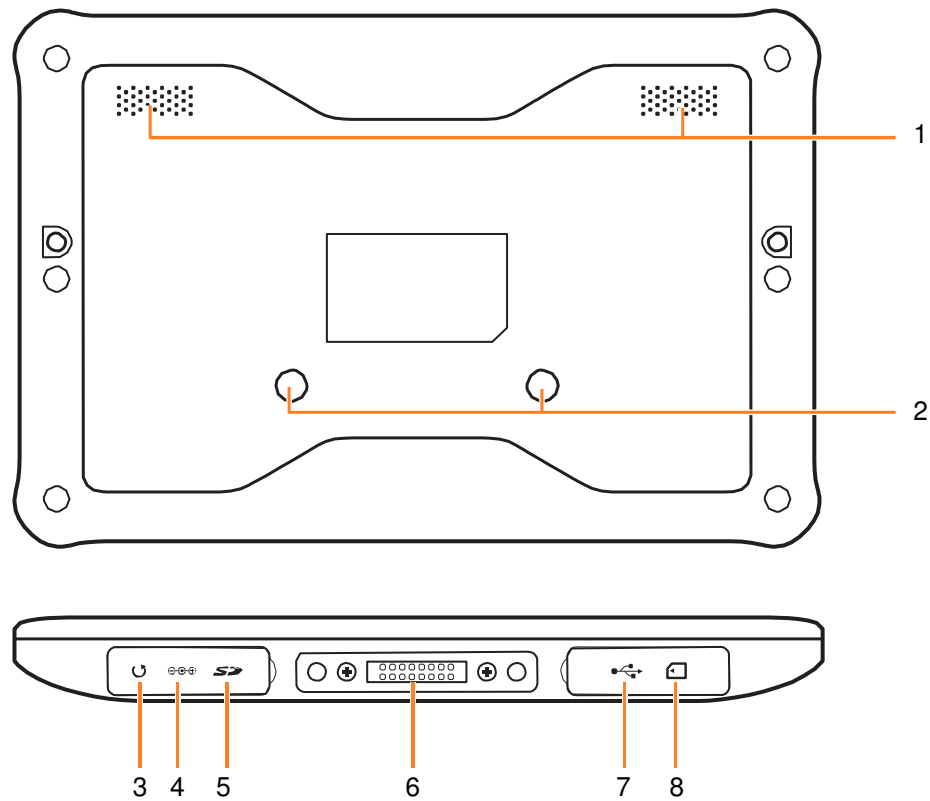

No.	Item	Description
1	Speakers	Emits audio output.
2	Cradle Guide	Aligns to the dock cradle (optional accessory).
3	Reset Button	Insert a pointed object to reset the device to its factory defaults.
4	Power Jack	Connects to the power adaptor.
5	SD Card Slot	Houses the microSD card.
6	Cradle Contacts	Connects to the dock cradle (optional accessory).
7	USB Port	Connects to a mini USB cable for data transfer purposes.
8	SIM Card Slot (optional)	Houses the SIM card.

NOTE: Items 3~5 and 7~8 are housed under the protective caps. The dock cradle and SIM card slot are optional items.

Installing the SD Card

Install a compatible microSD™ card to add more storage space to save your files.

To install the microSD™ card:

1. Open the left side protective cap.
2. Insert the microSD™ card with the gold contacts facing the front of the device.
3. Push the microSD™ card until it clicks into place.
4. Close the protective cap.

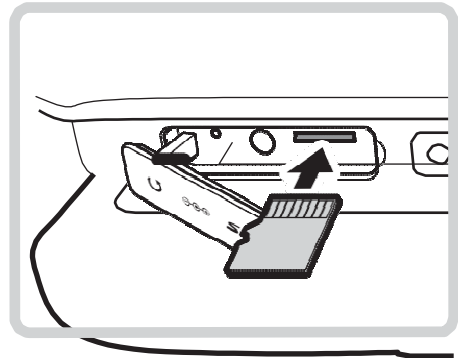

To remove the microSD™ card:

Before removing the microSD™ card, properly unmount the card from the Settings menu (Settings > Storage > Unmount EXTSD card). When the device displays “SD card safe to remove”, then do the following to remove the card:

1. Open the protective cap.
2. Push the microSD™ card to eject it from the slot.
3. Pull the microSD™ card out from the slot.
4. Close the protective cap.

NOTE: Removing the card without properly unmounting it may cause data loss. Do not remove the card while downloading or saving files.

Installing the SIM Card (Optional)

NOTE: The SIM Card slot is not available in all models.

To install the SIM card:

1. Open the right side protective cap.
2. Insert the SIM card with the gold contacts facing the front of the device.
3. Push the SIM card until it clicks into place.
4. Close the protective cap.

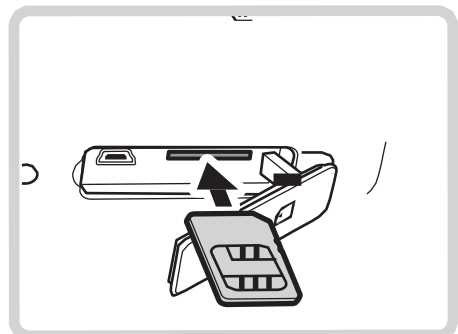

Charging the Battery

1. Open the protective cap.
2. Connect one end of the power adaptor to the power jack of your device.
3. Plug the other end of the power adaptor to the wall outlet to start charging.

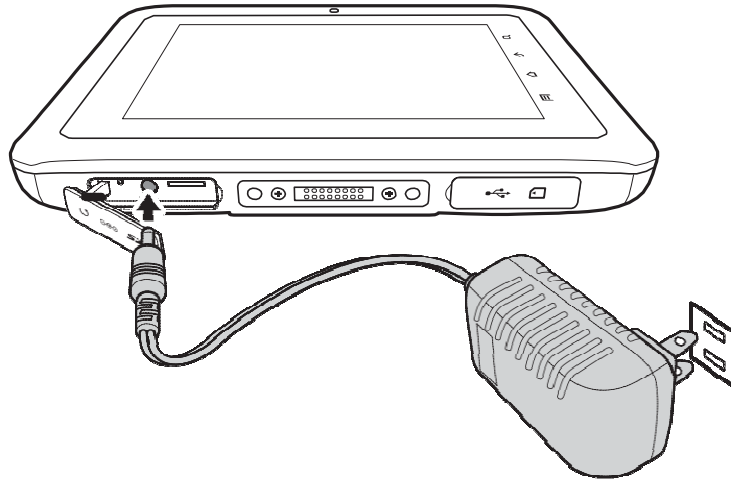

NOTE: Use only the supplied power adaptor to charge the battery. Using other power adaptor not authorized by the manufacturer may damage the device and void the warranty. The device battery can also be charged using the dock cradle (optional, see “Dock Cradle” on page 31).

When the battery is charging:

- The status LED lights red
- When the device is turned on, the  icon is displayed on the top-right corner of the screen.

Powering On the Tablet

To turn on your device:

Press and hold the **Power** button until the status LED lights green.

To turn off your device:

1. Press and hold the **Power** button for at least 3 seconds. The screen below appears.

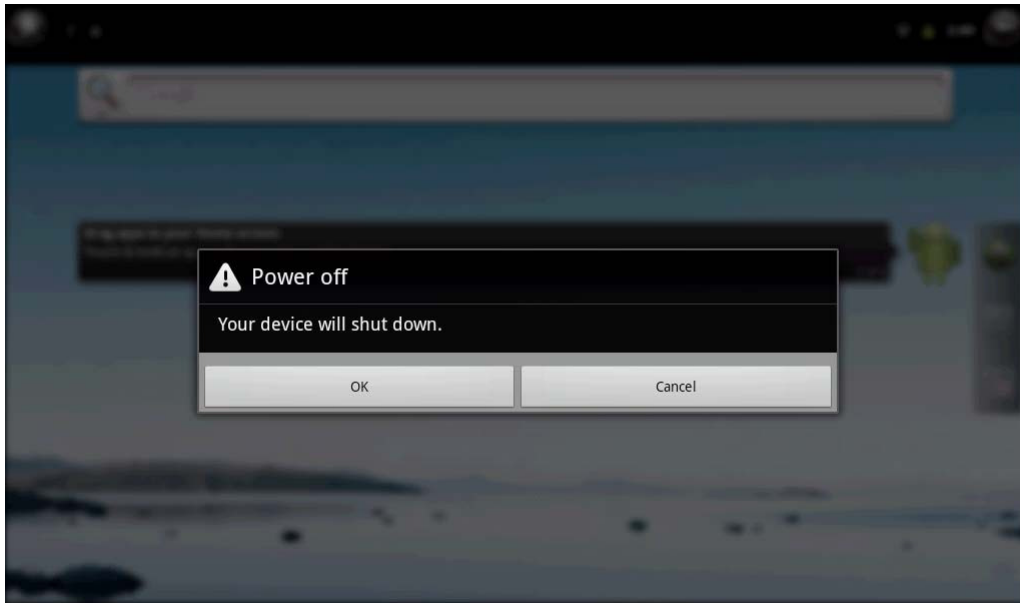

2. Touch **OK** to turn the device off.

Sleep Mode

To save power, put the device to sleep mode when not in use. In sleep mode, the device is in turned on mode but the screen backlight is turned off.

- To put the device to sleep mode, press the **Power** button once. The screen backlight turns off.
- To turn the backlight on, press the **Power** button again.

Unlocking the Screen

By default, the screen is locked after turning the device on or after a period of inactivity. The screen lock time can be set in Setting menu (see “Display” on page 23).

To unlock the screen:

Drag the lock icon upwards.

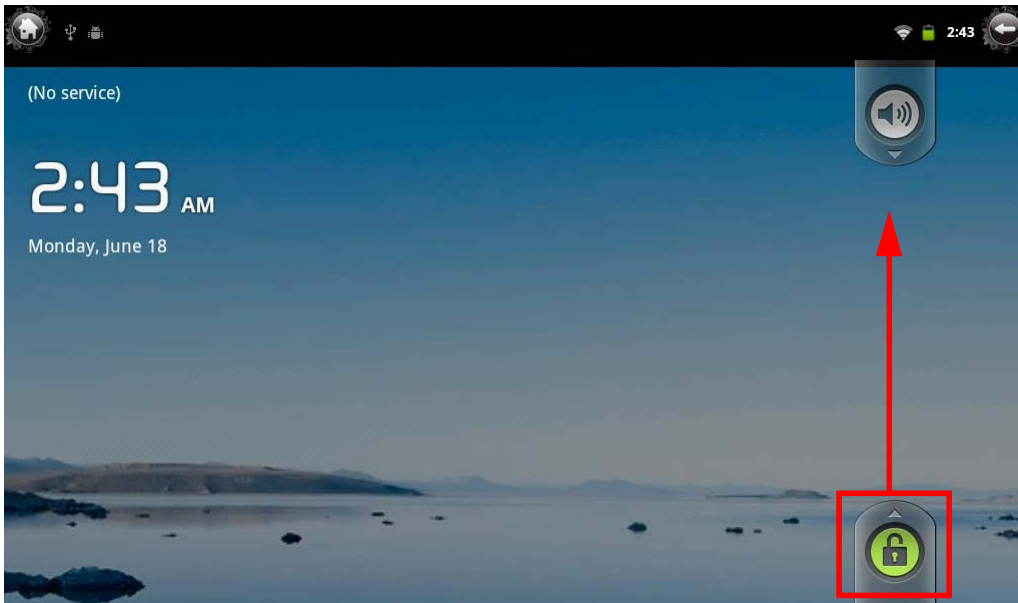



Initial Settings

For first time use, a setup wizard may prompt you for the system date and time, guide you on how to setup email and other options.

Follow the wizard to complete the initial settings of your Tablet PC.

Connecting to Network

Using Wi-Fi Connection

1. On the **Home** Screen, touch  > **Settings**  > **Wireless & networks**.
2. Touch **Wi-Fi** to check the box and enable the Wi-Fi function.
3. Touch **Wi-Fi settings**. The device searches for available networks within range.
4. Touch an available network connection.
5. If prompted, enter the password to connect to the Wi-Fi network, then touch **Connect**.

NOTE: Password entry is required only for first time connection. Once your Tablet PC is connected to a network and Wi-Fi is enabled on your device, the Tablet PC will automatically connect to that network.

Using Data Network Connection

For locations without Wi-Fi connection, install a SIM card to connect to a data network (see “Installing the SIM Card (Optional)” on page 7).

NOTE: Only Tablet PC models with a SIM card slot can use this connection.

Using the Tablet

Understanding the Interface

The Home Screen

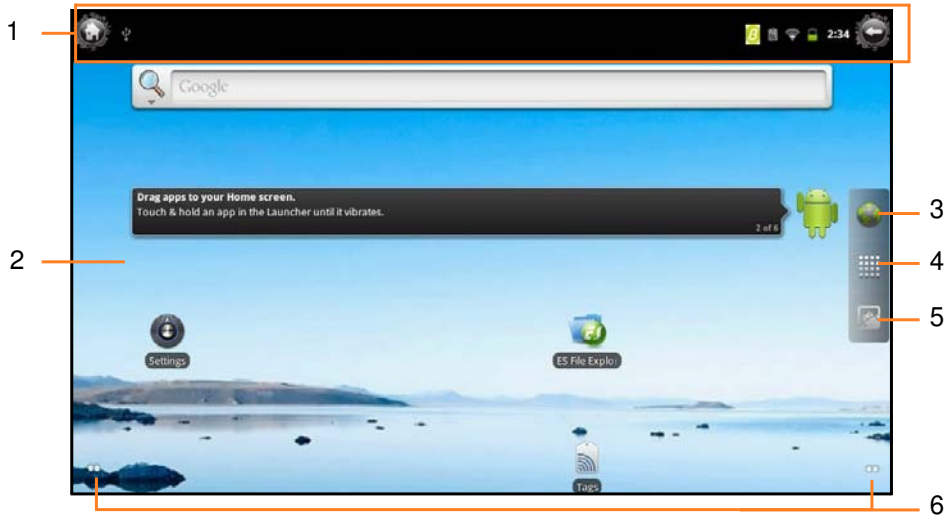

No.	Item	Description
1	Status Bar	Displays status icons and notifications. See “Status and Notifications” on page 13 for more information.
2	Home screen	Main screen display. Touch items on the screen to select an application.
3	Browser icon	Touch to open the Browser application and search the Internet.
4	Application icon	Touch to display all applications installed on your device. See “Opening Applications” on page 16 for more information.
5	Task icon	Touch to close all open applications.
6	Panel Indicator	Indicates how many screen panels are available to the left and to the right of the current panels. Swipe your finger left or right to change panels.

Status and Notifications

The Status Bar always appears on top of the screen and indicates different types of information.



No.	Item	Description
1	Home icon	Touch to return to the Home screen from any application.
2	USB icon	Indicates that the Tablet PC is connected to a computer using the USB cable.
3	Bluetooth icon	Indicates Bluetooth is enabled. “Connecting to Bluetooth Devices” on page 21.
4	Wi-Fi icon	Indicates the Wi-Fi signal strength. This icon appears only if the Tablet PC has Wi-Fi enabled.
5	Time	Displays the system time.
6	Tags icon	Indicates NFC is enabled. See “Using Tags” on page 17.
7	Battery icon	Indicates the battery status.
8	Back icon	Touch to return to the previous screen from any application.

Drag the status bar downwards to display more information.

NOTE: Depending on the current application and available features for your Tablet PC, the icons displayed on the status bar may vary.

Managing the Home Screen

You can add shortcut icons, widgets, and folders on the Home screen and change the wallpaper.

To change the wallpaper:

1. Touch and hold a blank space on the Home screen.
2. A pop up window appears. Touch one of the following:
 - **Gallery:** To use pictures saved on your Tablet PC.
 - **Live wallpapers:** To use pre-installed interactive wallpapers that came with your device.
 - **Wallpapers:** To use preset wallpapers that came with your device.

To add shortcut icons or widgets:

1. Touch and hold a blank space on the Home screen.
2. A pop up window appears. Touch either **Shortcuts** or **Widgets**.
3. Select the application or widget you want to add to the Home screen.

To add folders:

1. Touch and hold a blank space on the Home screen.
2. A pop up window appears. Touch one of the following:
 - **New folder:** To create a folder on the Home screen.
 - **Bluetooth received:** To create a folder to contain items received from a Bluetooth device.
3. Touch and hold the folder name to open the **Rename folder** pop up.
4. Type the desired folder name.
5. Touch **OK** to complete.

To move items:

You can move items from one screen panel to another or rearrange the icons.

1. Touch and hold the item that you want to move until the item is enlarged.
2. Drag and drop the item to the desired location.

To remove items:

1. Touch and hold the item that you want to remove.
2. Drag and drop the item to the trash bin icon  until the item turns red.

Using the Applications

This section covers some basic applications that you can do on your Tablet PC.

Typing on the Keyboard

Your Tablet PC comes with the Android On-Screen Keyboard. Use of the on-screen keyboard is similar to that of an ordinary computer keyboard.

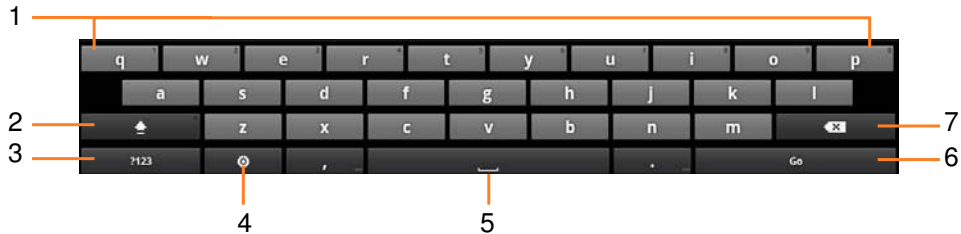

No.	Item	Description
1	Alphanumeric Keys	Touch the keys to enter letters, numbers, and symbols.
2	Shift / Caps Lock Key	Touch to toggle between upper case, lower case, and all caps keyboard.
3	Numeric Key	Touch to toggle between numeric, symbol and alphabet keyboard.
4	Keyboard Settings Key	<ul style="list-style-type: none"> • Touch to access the keyboard settings menu. • Touch and hold to select the input method: Android keyboard or Google Pinyin.
5	Space Bar	Touch to insert a space.
6	Go / Enter Key	The key varies between Go and Enter key depending on the current application. To add a carriage return or finalize an entry.
7	Backspace Key	Touch to delete the previous character.

Searching for Items

Your Tablet PC comes with a Search Bar. You can search for applications on your device or search the Internet using the Search Bar,

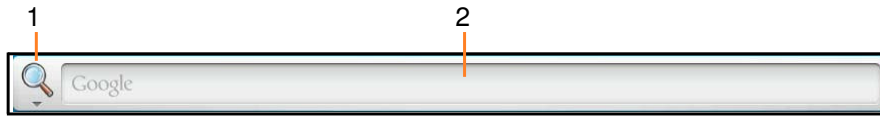

No.	Item	Description
1	Source to Search	Touch to select the source where you want to search: Web , Application , or All .
2	Search Bar	Type the characters/word to search for.

Opening Applications

Your Tablet PC comes with pre-installed applications. On the Home screen, touch . The applications screen appears,

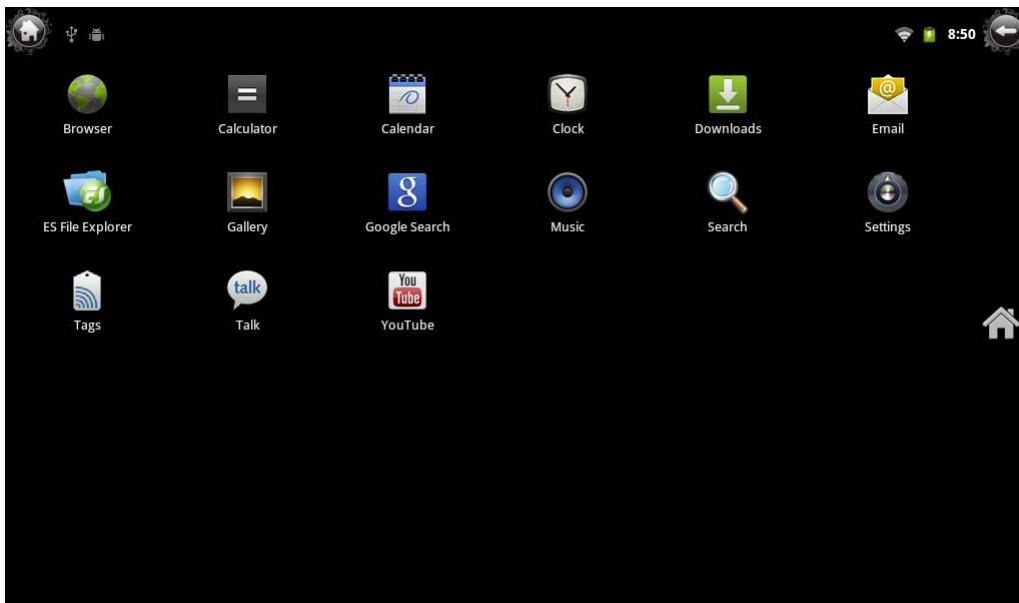

To open an application, touch the application icon.

To access the applications settings or menu, touch .

Killing Tasks

Once an application is opened, it consumes system memory space and may affect the efficiency and response time of your device. Thus, it is recommended to close all applications after using them.



To close all applications or kill all opened tasks, touch . An “All tasks killed” pop up message appears.

Using Tags

Near Field Communication (NFC) technology, otherwise called as Tags contain URLs, pictures, maps location, and any other kinds of information.

Your Tablet PC comes with the Tags application. Use Tags to scan tags, open applications, share, and organize them on your device. Before using Tags, activate the NFC function on your device first.

Activating NFC

1. On the Home screen, touch  > **Settings**  > **Wireless & networks**.
2. Touch **NFC** to check the box and enable the function.

Scanning Tags

1. Unlock the screen (if necessary).
2. Place your Tablet PC next to a tag. Your Tablet PC scans the tag and displays the contents that it collected.
3. Do one of the following:
 - Touch one of the tags to open it in an application that works with its content, such as Browser, Gallery, Maps, etc.
 - Touch **Done** to save the tag.
 - Touch **Delete** to delete the tag.

Sharing Tags

1. On the Tags screen, touch the **My tag** tab.
2. Touch **Add new tag**.
3. Touch the kind of tag you want to add on the pop up window: **Contact**, **URL**, or **Text**.
4. Enter the text, URL or browse for the contact you want to add.
5. Touch **Save** when done. The last saved tag is set as the active tag.
6. Touch the **Share my tag** to allow other devices to read your tag.

Managing Tags

1. Touch and hold a tag content.
2. A pop up window appears. Touch one of the following:
 - **Set as active tag**: To set the tag as the active tag.
 - **Edit tag**: To edit the tag content.
 - **Delete tag**: To delete the tag.
 - **Write to tag**: To add contents to the tag.

Using ES File Explorer

The ES File Explorer allows you to browse files on the microSD card, device internal memory, or browse through files through LAN and FTP servers.

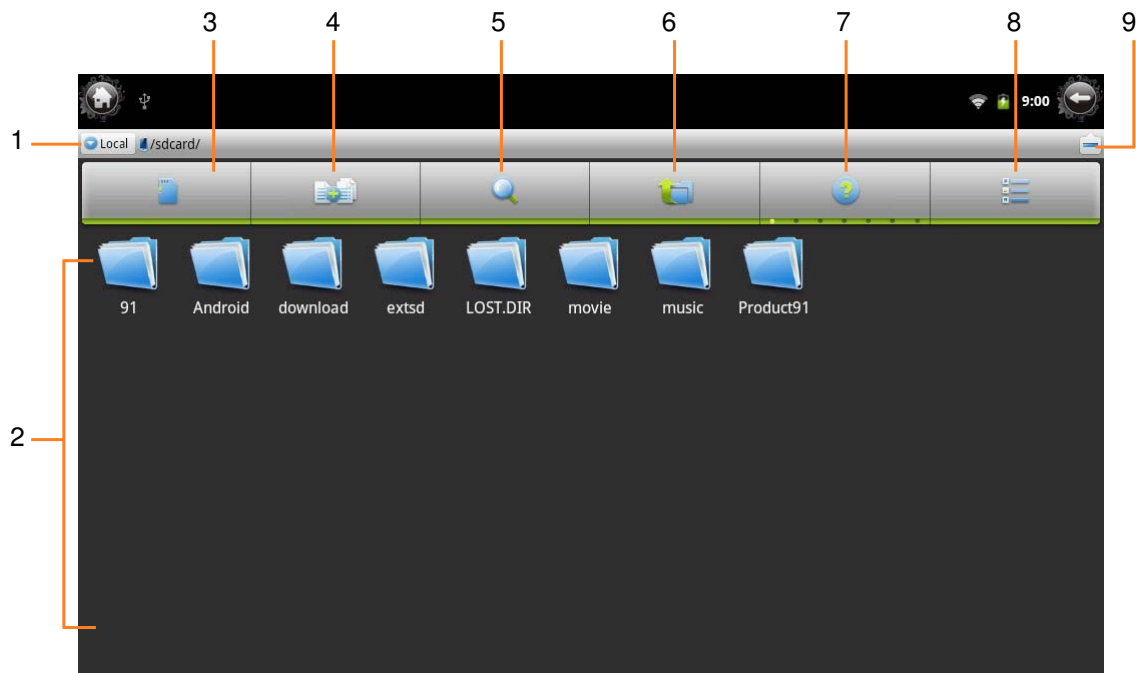

No.	Item	Description
1	Directory	Shows the current directory location.
2	File Organizer	Displays files/folder contents of the current directory. Touch a folder to browse its contents.
3	Root / Home	<ul style="list-style-type: none"> • Touch to toggle between root and home directory. • Touch and hold to manage bookmarks.
4	Multiselect	<ul style="list-style-type: none"> • Touch to enable the multiselect feature. The selected file/folder names turn green. • Touch and hold to use Select All or Select None functions.
5	Search	<ul style="list-style-type: none"> • Touch to search for files or folders. • Touch and hold to sort the files and folders by name, type, size, etc.
6	Return	<ul style="list-style-type: none"> • Touch to go up one level at a time. • Touch and hold to close the application.
7	Help	Touch to view the help contents.
8	Display Mode	<ul style="list-style-type: none"> • Touch to toggle between list mode or thumbnail mode. • Touch and hold to change the font and icon size.

No.	Item	Description
9	Show / Hide Menu	Touch to show or hide the ES File Explorer menu.

Managing Files and Folders

You can use common computer operations such as copy and paste with the ES File Explorer. To do this, perform the following:

1. Touch and hold a file or folder.
2. A pop up window appears. Touch an operation such as **Paste, Cut, Copy, Rename**, etc.

To access more options:



Touch  to bring up the ES File Explorer menu. It contains the following submenu options:

- **Operations:** Touch to use the **Paste, Rename, Delete, Properties** functions.
- **New:** Touch to create a new file, folder, search, or server, etc.
- **Manager:** Touch to access **Task Manager, App Manager, Security Manager, Bookmark Manager**, and **SD Card Analyst**.
- **Show / Hide Tabs:** Displays or hides the location tabs. Available tabs are: **Local, LAN, FTP, Net** (cloud server).
- **Settings:** Touch to access the ES File Explorer settings.
- **More:** Touch to refresh, flip orientation, access Help Center, view software information or exit the application.

NOTE: Available submenu options vary depending on the current path or directory.

Changing the Tablet Settings

This chapter covers information on how to change your Tablet PC settings and customize other options.

To access the Tablet Settings, on the Home screen, touch  > Settings .





Settings Menu

Wireless & networks	Manage Wi-Fi, Bluetooth, VPN, and NFC settings.
Sound	Set volume, screen lock sounds, and mute device.
Display	Set brightness setting, enable auto-rotate screen, animation, and screen timeout options.
Location & security	Set up screen lock, passwords, and secure credential storage.
Applications	Manage running and downloaded applications, applications from unknown sources, and development options.
PowerManager	Manage power manager, battery value, brightness and sound manager.
Accounts & sync	Set up account such as email, calendar, etc. to sync with your Tablet PC.
Privacy	Set back up, restore and reset options.
Storage	View and manage available storage space on the internal and external SD card, and U disk.

Language & keyboard	Select the system language, manage the user dictionary and keyboard settings.
Accessibility	Set accessibility options, if available.
Date & time	Set the system date and time.
About device	View device information such as version, legal information, model name, etc.

Managing Wireless and Network Settings



Connecting to Wireless Networks

1. On the **Home** Screen, touch  > **Settings**  > **Wireless & networks**.
2. Touch **Wi-Fi** to check the box and enable the Wi-Fi function.
3. Touch **Wi-Fi settings**. The device searches for available networks within range.
4. Touch an available network connection.
5. If prompted, enter the password to connect to the Wi-Fi network, then touch **Connect**.

NOTE: Password entry is required only for first time connection. Once your Tablet PC is connected to a network and Wi-Fi is enabled on your device, the Tablet PC will automatically connect to that network.

NOTE: To enable the Tablet PC to notify you when open networks are available, check the **Network notification** box.



Connecting to Bluetooth Devices

1. On the **Home** Screen, touch  > **Settings**  > **Wireless & networks**.
2. Touch **Bluetooth** to check the box and enable the Bluetooth function.
3. Touch **Bluetooth settings**. The following settings are available:
 - **Device name:** This is the name the appears on other Bluetooth devices. Touch to change the device name.
 - **Discoverable:** Touch to check the box and enable other Bluetooth device to see your Tablet PC.
4. Touch Scan for device to search for compatible Bluetooth devices in range.
5. Available devices are listed under **Bluetooth devices**.
6. To connect to a device, touch the device name.
7. Enter the passkey to connect. The passkey you enter must be the same passkey on the other device.

Setting Up VPN

The Tablet PC can be setup to connect to Virtual Private Networks (VPN).



NOTE: Obtain the necessary settings from your network administrator.

1. On the **Home** Screen, touch  > **Settings**  > **Wireless & networks**.
2. Touch **VPN settings**.
3. Touch **Add VPN**.
4. Touch the VPN protocol that you are using, options are:
 - **Add PPTP VPN:** For Point-to-Point Tunneling protocol
 - **Add L2TP VPM:** For Layer 2 Tunneling protocol
 - **Add L2TP/IPSec PSK VPN:** For Pre-shared key based L2TP/IPSec VPN
 - **Add L2TP/IPSec CRT VPN:** For certificate based L2TP/IPSec VPN
5. Touch the options and enter the necessary settings:
 - **VPN name:** Set the VPN name.
 - **Set VPN server:** Set the VPN server.
 - **Enable encryption:** Check to enable encryption.
 - **DNS search domains:** Set the DNS search domain.
6. Touch  > **Save**.

Changing Basic Settings



Sound

To modify the sound settings of your Tablet PC, perform the following:

1. On the **Home** Screen, touch  > **Settings**  > **Sound**.
2. Touch one of the following options:
 - **Silent mode:** Check the box to enable silent mode.
 - **Volume:** Touch to bring up the Volume window. Drag the slider of the type of volume that you want to adjust. Touch **OK** to close the window,
 - **Audible selection:** Check the box to play sound when making screen selections.
 - **Screen lock sounds:** Check the box to play sounds when locking and unlocking the screen.
3. Touch  to return to the Home screen.



Display

To modify the display settings of your Tablet PC, perform the following:

1. On the **Home** Screen, touch  > **Settings**  > **Display**.
2. Touch one of the following options:
 - **Brightness**: Touch to bring up the Brightness window. Drag the slider to adjust the screen brightness, then touch **OK**.
 - **Auto-rotate screen**: Check this box to enable automatic rotation of the screen when changing the screen orientation.
 - **Animation**: Select whether to enable or disable animation on some or all windows.
 - **XEC DLS Control**: Enable or disable XEC DLS control.
 - **Screen timeout**: Select the amount of time until the screen automatically locks and the device goes to sleep mode.
3. Touch  to return to the Home screen.

Date and Time



To modify the date and time settings of your Tablet PC, perform the following:

1. On the **Home** Screen, touch  > **Settings**  > **Date & time**.
2. Touch one of the following options:
 - **Set date**: Touch to bring up the Date window. Touch the + and - keys to adjust the date. When complete, touch **Set**.
 - **Select time zone**: Touch to select the time zone in your location.
 - **Set time**: Touch to bring up the Time window. Touch the + and - keys to adjust the time. When complete, touch **Set**.
 - **Use 24-hour format**: Check this box to display the time in 24-hour format.
 - **Select date format**: Touch to select the date format.
3. Touch  to return to the Home screen.

Changing Language and Keyboard Settings



Changing the Device Language

To change the device language, perform the following:

1. On the **Home** Screen, touch  > **Settings**  > **Language & keyboard**.
2. Touch **Select language**.
3. Touch the desired language.
4. Touch  to return to the Home screen.

Managing Keyboard Settings





By default, your Tablet PC uses the Android keyboard. To manage the keyboard settings, perform the following:

1. On the **Home** Screen, touch  > **Settings**  > **Language & keyboard**.
2. Touch **Android keyboard**.
3. The Android keyboard has the following options:
 - **Vibrate on keypress**: Check to vibrate the device every time a key is pressed.
 - **Sound on keypress**: Check to emit sound every time a key is pressed.
 - **Popup on keypress**: Check to enlarge the keyboard character as the keys are pressed.
 - **Touch to correct words**: Check to enable auto correct words when the word is touched.
 - **Auto-capitalization**: Check to automatically capitalize the first letter of the sentence.
 - **Show settings key**: Select whether to show or hide the settings key on the keyboard.
 - **Input languages**: Select the input languages that you want to use with the keyboard. You can easily switch between these input languages by swiping your finger across the space bar.
 - **Quick fixes**: Check to enable the device to automatically correct common mistakes in typing.
 - **Show suggestions**: Check to display suggested words while typing.
 - **Auto-complete**: Check to automatically insert the highlighted word to complete what you are typing with a press of the spacebar or a punctuation mark.
4. Touch  to return to the Home screen.



Using the User Dictionary

Your Tablet PC has a built-in user dictionary where you can add words to it.



To add words to the dictionary, perform the following:

1. On the **Home** Screen, touch  > **Settings**  > **Language & keyboard**.
2. Touch **User dictionary**.
3. To add words to the dictionary, touch  > **Add**.
4. Type the word you want to add to the dictionary.
5. Touch **OK**.
6. Repeat steps 3 to 5 to add more words.
7. Touch  to return to the Home screen.

To modify a word in the dictionary, perform the following:

1. On the **Home** Screen, touch  > **Settings**  > **Language & keyboard**.
2. Touch **User dictionary**.
3. Touch the word you want to edit.
4. A pop up window appears. Touch **Edit**.
5. Modify the word, then touch **OK**.
6. Repeat steps 3 to 5 to modify more words.
7. Touch  to return to the Home screen.



To delete a word from the dictionary, perform the following:

1. On the **Home** Screen, touch  > **Settings**  > **Language & keyboard**.
2. Touch **User dictionary**.
3. Touch the word you want to delete.
4. A pop up window appears. Touch **Delete**. The word is removed from the dictionary.
5. Repeat steps 3 to 4 to delete more words.
6. Touch  to return to the Home screen.

Managing Storage Space



The Storage settings menu allows you to view the total and available space on your storage devices. Your Tablet PC has three storage sources:

- **SD card:** The internal storage
- **EXTSD card:** The micro SD card
- **U disk**

To view the total and available storage space, touch  from the **Home** screen, then touch **Settings**  > **Storage**.

Erasing Storage Card Content



To erase the contents of your storage card, perform the following:

1. On the **Home** Screen, touch  > **Settings**  > **Storage**.
2. Touch one of the following:
 - **Erase SD card:** To erase the contents of the internal SD card.
 - **Erase EXTSD card:** To erase the contents of the microSD card.
 - **Erase U disk:** To erase the contents of the U disk card.
3. A confirmation message appears. Touch **Erase SD card** to confirm.
4. Touch  to return to the Home screen.

Removing the Storage Card

The external SD (microSD) and U disk cards can be removed from the Tablet PC. However, you must properly unmount the cards to safeguard the storage contents.



To do this, perform the following:

1. On the **Home** Screen, touch  > **Settings**  > **Storage**.
2. Touch one of the following:
 - **Unmount EXTSD card:** To unmount the microSD card.
 - **Unmount U disk card:** To unmount the U disk card.
3. A confirmation message appears on the status bar. Remove the card.
4. Touch  to return to the Home screen.

Managing Accounts

You can synchronize the data, email, calendar and other information of an account with your Tablet PC.

Adding Exchange Accounts

1. On the **Home** Screen, touch  > **Settings**  > **Accounts & sync**.
2. Touch **Add account**.
3. Touch **Corporate**.
4. Enter your **Email address** and **Password**.



NOTE: If you have more than one accounts, check the **Send email from this account by default** box to set the current account as the default account.

5. Touch **Next** to continue.
6. Enter the required information such as **Domain** or **Username**, **Password**, **Server** (for Exchange account), etc.



NOTE: Obtain these information from your network administrator or service provider.

7. Touch **Next** to continue and complete the wizard.
8. Touch  to return to the Home screen.

Adding Google Accounts



1. On the **Home** Screen, touch  > **Settings**  > **Accounts & sync**.
2. Touch **Add account**.
3. Touch **Google**.
4. Touch **Next** to continue.
5. If you already have an existing Google account, touch **Sign in** if you need to create an account, touch **Create**.
6. Follow the on-screen instructions to complete setup.
7. Touch  to return to the Home screen.

Syncing Accounts

1. On the **Home** Screen, touch  > **Settings**  > **Accounts & sync**.
2. Touch to check the type of information you want to sync:
 - **Background data:** To allow applications to sync, send, and receive data at any time.
 - **Auto-sync:** To allow applications to sync automatically.
3. Touch the account to select the type of data to sync.
4. Check the boxes of the data you want to sync, such as **Picasa Web Albums**, **Contacts**, **Calendar**.



5. Touch  to return to the Home screen.

Removing Accounts



1. On the **Home** Screen, touch  > **Settings**  > **Accounts & sync**.
2. Touch the account to you want to remove.
3. Touch **Remove account**.
4. A confirmation message appears. Touch **Remove account** to confirm.
5. Touch  to return to the Home screen.

Advanced Settings



Location and Security

1. On the **Home** Screen, touch  > **Settings**  > **Location & security**.
2. Touch one of the following options:
 - **Set up screen lock:** Set up a pattern, PIN, or password to lock or unlock the screen.
 - **Visible passwords:** Check the box to show the password as you type.
 - **Select device administrators:** Add or remove device administrators.
 - **Use secure credentials:** Allow applications to access secure certificates and other credentials.
 - **Install from SD card:** Install encrypted certificates from SD card.
 - **Set password:** Set or change the credential storage password.
 - **Clear storage:** Clear credential storage of all contents and reset its password.
3. Touch  to return to the Home screen.



Power Manager

1. On the **Home** Screen, touch  > **Settings**  > **PowerManager**.
2. Touch one of the following options:
 - **PowerManager:** Check to activate PowerManager.
 - **Battery value settings:** Select a value wherein the battery will automatically turn off when the battery value is less than the selected value.
 - **Brightness Manager:** Check to automatically turn off backlight when the battery value is less than the selected value.
 - password.
3. Touch  to return to the Home screen.

Privacy

1. On the **Home** Screen, touch  > **Settings**  > **Privacy**.
2. Touch one of the following options:
 - **Back up my data:** Check to back up application data, Wi-Fi passwords, and other settings to Google servers.
 - **Automatic restore:** Check to automatically reinstall applications, and restore backed up settings or other data. Available only when **Back up my data** is enabled.
 - **Factory data reset:** To erase all data on the Tablet PC and reset all settings to its factory default.
3. Touch  to return to the Home screen.

Applications

1. On the **Home** Screen, touch  > **Settings**  > **Applications**.
2. Touch one of the following options:
 - **Unknown sources:** Check to allow installation of non-Market applications.
 - **Manage applications:** Manage and remove installed applications.
 - **Running services:** View and control currently running services.
 - **Storage use:** View storage used by applications.
 - **Battery use:** View applications or services using the battery.
 - **Development:** Set options for application development.
3. Touch  to return to the Home screen.

Accessibility

Accessibility is available only when accessibility related applications are installed on your Tablet PC.

To access Accessibility from the **Home** Screen, touch  > **Settings**  > **Accessibility**.

About the Device

About the Device displays device status, battery use, legal information, model number, Android version, Kernel version, and the build number of your Tablet PC.

To access About the Device from the **Home** Screen, touch  > **Settings**  > **About the Device**.

Using Optional Accessories

Expand the functionality of your Tablet PC using the optional accessories.

Dock Cradle

Parts and Functions

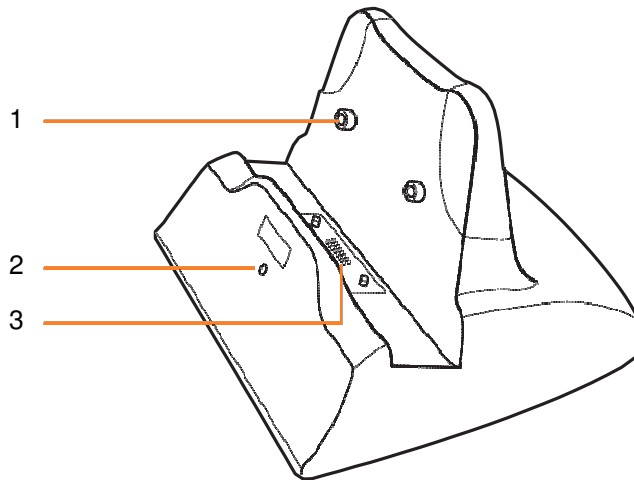

No.	Item	Description
1	Dock Guide	Guides that lock with the Tablet PC.
2	Status LED	Indicates the dock cradle status. Lights red when battery charging is ongoing.
3	Dock Contacts	Connects to the Tablet PC.

Docking the Tablet

Align the dock guides and the gold contacts on the Tablet PC and the dock cradle.

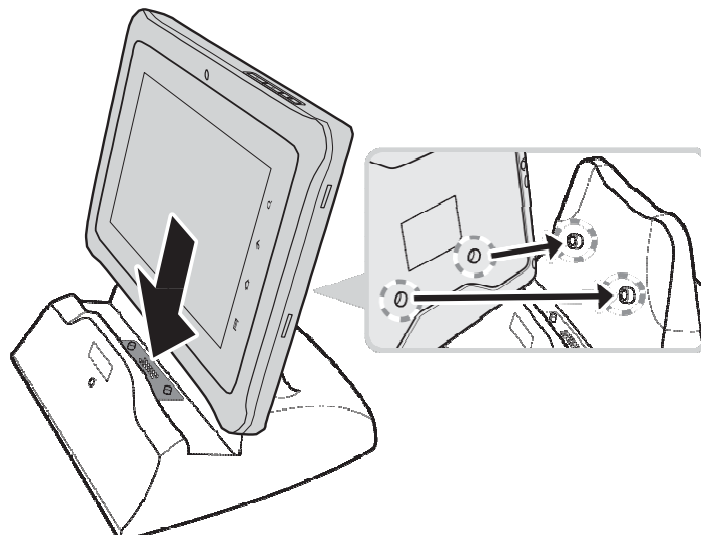

When docked...

- A second battery icon appears on the status bar of the Tablet PC
- The Tablet PC battery is charged when the power adapter is connected to a power outlet.
- Use the connected USB device, such as a keyboard or mouse, through the Tablet PC.

Making Connections

To connect the power:

Connect the dock cradle to a power source to charge the batteries on both the Tablet PC and dock cradle. The Tablet PC battery is charged first. When charging is complete, the second battery, which is embedded in the dock cradle, is charged next.

1. Connect one end of the power adapter to power jack of the dock cradle.
2. Plug the adapter head to a wall outlet.

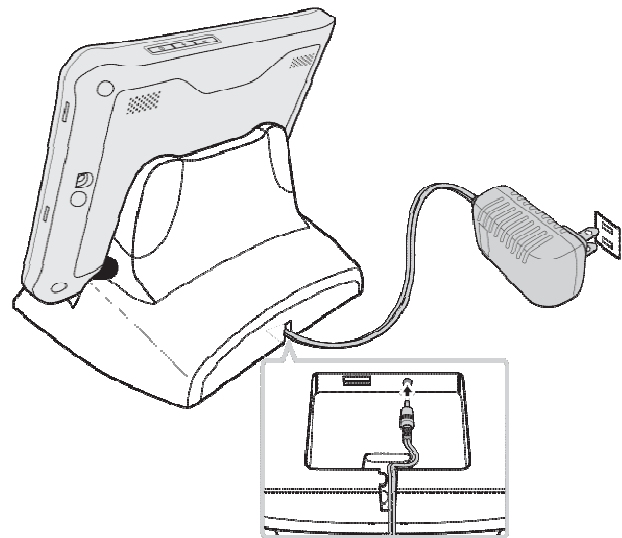

To connect USB devices:

Connect a USB keyboard or USB mouse to the dock cradle and use the USB device to manage the Tablet PC.

1. Connect the USB end of a USB keyboard or mouse to the USB port of the dock cradle.
2. Manage the Tablet PC using the keyboard or mouse just as you would on a computer.

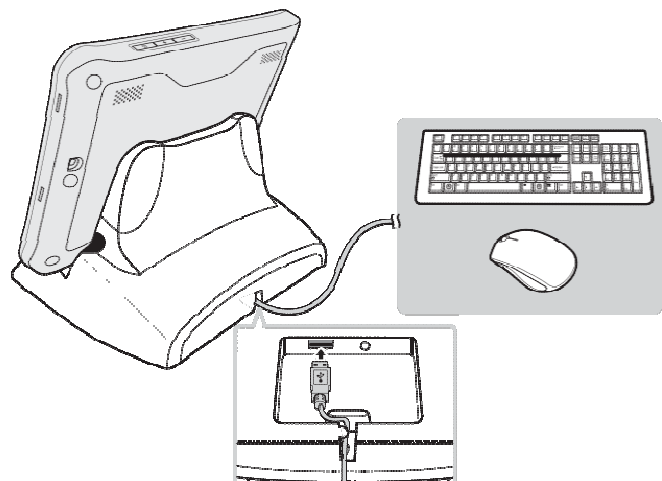

MSR Module

Your Tablet PC is especially designed to expand functionality with an MSR module. Before installing the MSR module, prepare the following tools:

- Screw kit (supplied with MSR module)
- Phillip screwdriver

To install the MSR module:

1. Align the guides on the MSR module through the guides on the right side of the Tablet PC.

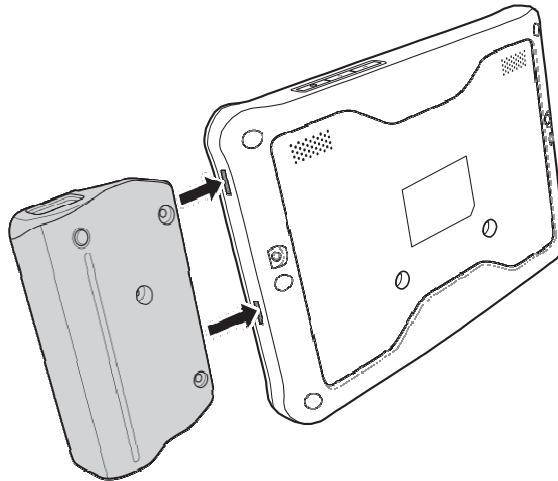

2. Attach a screw to secure the MSR module to the Tablet PC.

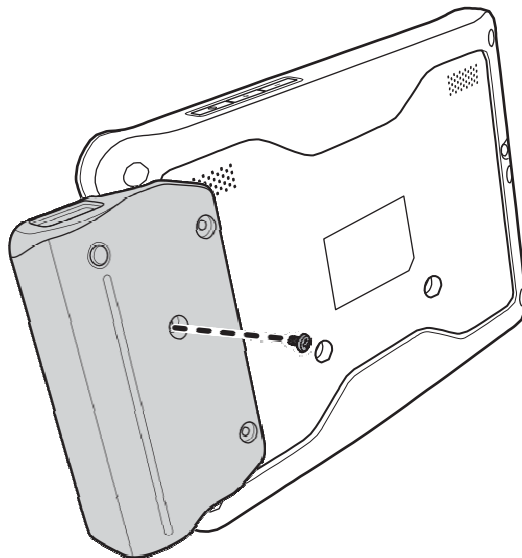

Appendix

Troubleshooting

1. The device powers off automatically.

- The battery power is depleted. Charge the battery.

2. No sound comes out from the Tablet PC.

- Check whether the volume is set to mute. Press the volume keys to adjust volume.
- Check whether the music file is damaged, try another files to test.

3. Cannot copy a file to the microSD card.

- Check whether the microSD card capacity is full.
- Try to delete or move some files to free space.

4. Cannot scan tags.

- Check whether NFC is enabled in **Settings > Wireless Networks**.

5. Cannot connect to the Internet.

- Check whether the Tablet PC is connected to a wireless network.
- If no wireless network is available, try to use the SIM card (if supported by your device model) to use its data network connection.
- The battery may be too low. Network connectivity uses more power. Be sure to charge the battery.

Specifications

EM-70B Specifications	
CPU	Freescale ARM IMX 51 800MHz
Memory	DDR 512MB, NAND Flash 4GB max. 16 GB
Display	Type: High Brightness TFT Colour LCD Capacitive Multitouch
	Size: 7-inch
	Resolution: 1024 x 600
	Brightness: 350 nit
Communication	Wi-Fi 802.11 b/g/n
Expansion	1 x WCDMA Module / Mini PCI-e (optional)
I/O Interface	1 x Mini USB 2.0 PTG 1 x Micro-SD card 1 x DC Jack 1 x Cradle Connector
Storage	Micro SD (SDHC) with eject function, max. 32GB
OS	Android 2.3.3
Temperature	Operating Temperature: 0 ~ 40° C Storage Temperature: -20 ~ 60° C
Humidity	Operating Humidity: 5% ~ 95% Storage Humidity: 5% ~ 95%
LED	1 x LED Power Status (Power / on / off / charging)
Buttons	1 x Power 2 x Volume 1 x Home-button 1 x Menu-button 1 x Back-button
Weight	630 g (approx.) with battery
Others	2 x Audio speaker RFID Module 13.56MHz
Battery	Li-ion 4200mA 1S2P 3.7V, Cradle has second battery Li-ion 4200mA 1S2P 3.7V
Protection Class	IP54 1 1,2 M Drop-Tested

PARTNER