

# OT-110

## User Manual





## Copyright

This publication, including all photographs, illustrations and software, is protected under international copyright laws, with all rights reserved. Neither this manual, nor any of the material contained herein, may be reproduced without written consent of PARTNER Tech Corp.

## Disclaimer

The information in this document is subject to change without notice. The manufacturer makes no representations or warranties with respect to the contents hereof and specifically disclaims any implied warranties of merchantability or fitness for any particular purpose. The manufacturer reserves the right to revise this publication and to make changes from time to time in the content hereof without obligation of the manufacturer to notify any person of such revision or changes.

## Trademark recognition

All product names used in this manual are the properties of their respective owners and are acknowledged.

## Federal Communications Commission Notice

This equipment has been tested and found to comply with the limits for a Class B digital device, pursuant to Part 15 of the FCC Rules. These limits are designed to provide reasonable protection against harmful interference in a residential installation. This equipment generates, uses, and can radiate radio frequency energy and, if not installed and used in accordance with the instructions, may cause harmful interference to radio communications. However, there is no guarantee that interference will not occur in a particular installation. If this equipment does cause harmful interference to radio or television reception, which can be determined by turning the equipment off and on, the user is encouraged to try to correct the interference by one or more of the following measures:

Reorient or relocate the receiving antenna.

Increase the separation between the equipment and the receiver.

Connect the equipment onto an outlet on a circuit different from that to which the receiver is connected.

Consult the dealer or an experienced radio/TV technician for help.

Shielded interconnect cables and a shielded AC power cable must be employed with this equipment to ensure compliance with the pertinent RF emission limits governing this device. Changes or modifications not expressly approved by the system's manufacturer could void the user's authority to operate the equipment.

## Declaration of conformity

This device complies with part 15 of the FCC rules. Operation is subject to the following conditions:

This device may not cause harmful interference, and

This device must accept any interference received, including interference that may cause undesired operation.

## **FCC RF Radiation Exposure Statement**

This Transmitter must not be co-located or operating in conjunction with any other antenna or transmitter.

This equipment complies with FCC RF radiation exposure limits set forth for an uncontrolled environment. This device was tested for handheld operations with the device contacted directly to the human body. To maintain compliance with FCC RF exposure compliance requirements, avoid direct contact to the transmitting antenna during transmitting.

## **SAR information**

The 1g SAR value is measured at IEEE 802.11 b/IEEE 802.11 bg. The Body SAR value of 0.0065 w/kg @1g has been tested with back of the device kept at 0cm away from the body.

## **Taiwan NCC**

Article 12

Without permission granted by the NCC, any company, enterprise, or user is not allowed to change frequency, enhance transmitting power or alter original characteristic as well as performance to a approved low power radio-frequency devices.

Article 14

The low power radio-frequency devices shall not influence aircraft security and interfere legal communications; If found, the user shall cease operating immediately until no interference is achieved.

The said legal communications means radio communications is operated in compliance with the Telecommunications Act.

The low power radio-frequency devices must be susceptible with the interference from legal communications or ISM radio wave radiated devices.

# Revision history

Version 1.0, July 2011

## About this manual

This manual is intended for system administrators who are familiar with setting up a new system and installing programs.

The manual consists of the following sections:

- Chapter 1 Getting Started: This section covers unpacking and checking the package contents, identifying components, charging the battery, installing the microSD card, and powering on the device.
- Chapter 2 Using The Device: This section provides information on how to use the device features.
- Chapter 3 Using The Accessories: This section provides information on how to use the accessories.
- Chapter 4 Installing The Optional Modules: This section provides steps to install and test the optional modules.
- Appendix: The appendix covers troubleshooting, information on having the OT-110 serviced and technical specifications.

# Safety information

Before installing and using the OT-110, take note of the following precautions:

**SAR compliance for body-worn operations requires at least 2 cm of separation between the device and the user's body**

**Request service for damaged products:** Turn off the product, unplug it from the electrical outlet, and request service from a service partner under the following conditions:

- The power cord or plug is damaged.
- Liquid has been spilled into the product.
- An object has fallen into the product.
- The product has been exposed to rain or water.
- The product has been dropped or damaged.
- The product does not operate normally when you follow the operating instructions.

**Avoid hot areas:** The product should be placed away from heat sources such as radiators, heat registers, stoves, and other products (such as amplifiers) that produce heat.

**Allow the product to cool:** Allow the product to cool before removing covers and touching internal components.

**Avoid wet areas:** Never use the product in a wet location.

**Avoid inserting objects into product:** Never insert objects of any kind into slots or other openings in the product.

**Clean the product properly:** Unplug the product from the wall outlet before cleaning it. Do not use liquid cleaners or aerosol cleaners. Use a soft cloth dampened with water for cleaning exterior components, but NEVER apply water directly to the product or to an LCD screen.

**Use the product with approved equipment:** Use your product only with the computers and accessories identified as suitable for use with your product.

**Adjust the volume:** Turn down the volume before using headphones or other audio devices.

**When device will not be used for a long period of time, please remove the battery, and store both device and battery in a cool, dark, and dry place. For storage over a long period of time, please place product in a dry box.**

**SAR compliance for body-worn operations requires at least 2 cm of separation between the device and the user's body.**

## Battery Handling Precaution

- **Do not attempt to disassemble or reconstruct the packs.** The battery has integrated protection circuits and safety functions to avoid danger. If battery is damaged, it may rupture, generate heat, or cause smoke and flame.
- **Do not short circuit battery. Do not** short connect the positive terminal and negative terminal with metals. Never carry or store the battery with metal objects. If the battery is short circuited, excessive large current will flow and generate heat, rupture or flame will occur, and also it will cause heat generation for metals. Please cover the plug with waterproof cap when not using the battery.
- **Do not incinerate or heat the battery.** This will cause the insulator to melt, damage the gas release vent, and cause loss of safety function, or electrolyte ignition. Above mentioned matters will cause battery to rupture, generate heat, or cause smoke and flame.
- **Do not use near high temperature areas.** Do not use or leave battery near fire, stove or heated areas of more than 80°C, to avoid melting of the polymer separator which would cause internal short circuits to occur in individual cells, and cause the battery to rupture, generate heat, or cause smoke and flame.
- **Do not immerse the battery in water, seawater, or get it wet.** This may cause internal short circuits to occur within individual cells, and cause the battery to rupture, generate heat, or cause smoke and flame.
- **Do not charge battery near fire or under the blazing sun.** If the battery protection circuit does not function properly due to high temperature, or it is broken, the battery will be charged at an abnormal current, and abnormal chemical reaction may occur, causing the battery to rupture, generate heat, or cause smoke and flame.
- **Only use the official product charger and observe the charging requirement.** If the battery is charged in unusual conditions, it will cause loss of safety functions, or abnormal chemical reactions, causing the battery to rupture, generate heat, or cause smoke and flame.
- **Do not try to damage the battery.** Do not drive a nail into the battery, strike it with a hammer, or tread on it. The impact will cause leakage, causing the battery to rupture, generate heat, or cause smoke and flame.
- **Do not attempt to solder anything onto the battery.** This will cause the insulator to melt due to heat, or cause the gas release vent to break, causing the battery to rupture, generate heat, or cause smoke and flame.
- **Do not connect battery to a plug socket or car-cigarette plug.** Connecting high voltage to the battery, means excessive current will flow in it, and cause the battery to rupture, generate heat, or cause smoke and flame.
- **Do not use battery for powering other equipment.** If the battery is used for powering other equipment, it will deteriorate its performance and cycle-life. At worst, abnormal current will flow, and cause the battery to rupture, generate heat, or cause smoke and flame.
- **Do not touch a leaked battery directly.** If battery leaks and hands touch leaked electrolyte, wash your hands with soap immediately. If leaked electrolyte gets into your eyes, do not rub them, and wash eyes immediately with fresh water. Consult a doctor immediately.
- **Do not continue to charge over specified time.** If the battery has not finished charging over recommended time, let it stop charging. There is a possibility that the battery might be defective, and continued charging may cause the battery to deform, generate heat, or cause smoke or flame.
- **Do not insert battery into a microwave or high pressure container.** This may cause battery to deform, generate heat, or cause smoke or flame, because of sudden heat, intense pressure, or damage to the sealing condition of the battery.
- **Do not put leaked battery near fire.** If liquid leaks from the battery, or the battery give outs a bad smell, do not leave battery near flammable objects. Otherwise, the electrolyte leaked from battery will catch on fire.

- **Do not use an abnormal battery.** If battery has a bad smell, changes color, deforms, or causes something wrong during usage, remove it from equipment or charger, and do not use. If an abnormal battery is used, it may cause battery to rupture, generate heat, or cause smoke and flame.

  
**WARNING**

***Warning! Batteries may explode if not handled properly. Do not disassemble or dispose of them in fire. Keep them away from children. Follow local regulations when disposing of used batteries.***

  
**警告**

不正確地更換電池會有爆炸的危險。僅可更換為廠商建議的相同電池或相同型式電池。請依據廠商說明書棄置電池。

  
**注意**

用错误型号电池更换会有爆炸危险务必按照说明处置用完的电池。

  
**注意**

正しく交換しないと電池が爆発する危険があります。製造業者の推奨する電池又は同タイプの電池と交換して下さい。使用後の電池を捨てる時は製造業者の指示に従って下さい。

  
**IMPORTANT**

***The battery must be installed before you use the device. Using only adaptor power without battery is not supported by the device. Do not remove the battery during operating.***



# TABLE OF CONTENTS

CHAPTER 1 GETTING STARTED .....	1
Unpacking the OT-110 .....	1
Checking the package contents .....	2
Identifying components .....	4
Charging Cradle .....	8
Setup the OT-110 .....	9
Using the cradle .....	12
Charge the device in cradle .....	12
Charge the battery in cradle .....	12
Changing the battery .....	13
Using microSD cards .....	16
Installing a microSD card .....	16
View the contents of a microSD card .....	18
CHAPTER 2 USING THE DEVICE .....	19
Entering text .....	19
Shortcut menus .....	19
Windows CE help .....	20
Performing a reset .....	20
Opening and closing programs .....	20
Program switch .....	20
Status icons .....	20
Adjusting the volume .....	21
Setting the power schemes .....	22
Changing the device name .....	24
Entering owner information .....	25
Recalibrating the screen .....	27
Setting the date and time .....	28
Using Settings Manager .....	30
PC GetInfomation .....	37
Lock Screen .....	38
Connecting to a WLAN network .....	38
Automatically connect to a WLAN network .....	38
Manually connect to a WLAN network .....	40
Lock SSID .....	41
Specify the IP address and domain name servers (DNS) .....	42
Find your IP address .....	44
Synchronization .....	46
Copy or move files between the computer and OT-110 .....	48

Install and remove programs.....	49
Backup data .....	51
Restore data.....	53
Upgrading Operating System.....	55
<b>CHAPTER 3 USING THE ACCESSORIES .....</b>	<b>57</b>
Attaching the stylus cord.....	57
Attaching the hand strap .....	58
Using the leather pouch .....	59
Attaching the leather pouch cord .....	60
Using the high quality stylus.....	61
<b>CHAPTER 4 INSTALLING THE OPTIONAL MODULES .....</b>	<b>63</b>
Installing the MSR module .....	63
Testing the MSR module .....	64
Installing the RFID reader/writer module.....	66
Testing the RFID reader/writer module .....	67
Installing the Barcode Scanner module .....	69
Testing the Barcode Scanner module .....	70
<b>APPENDIX .....</b>	<b>73</b>
Troubleshooting .....	73
Tips for Troubleshooting.....	73
General Problems .....	73
Having the OT-110 Serviced .....	74
Guidelines for care and maintenance .....	74
Using the device .....	74
Cleaning the device .....	74
Transporting and storing the device.....	74
Specifications.....	75

# CHAPTER 1 GETTING STARTED

This chapter describes the procedures from unpacking the OT-110, to powering it on. The following topics are described.

- Unpacking the OT-110 on page 1
- Checking the package contents on page 2
- Identifying components on page 4
- Charging Cradle on page 8
- Setup the OT-110 on page 9
- Using the cradle on page 12
- Charge the device in cradle on page 12
- Charge the battery in cradle on page 12
- Changing the battery on page 13
- Using microSD cards on page 16
- Installing a microSD card on page 16
- View the contents of a microSD card on page 18

## Unpacking the OT-110

The device and accessories are packed in a cardboard carton with foam padding for protection during shipping.

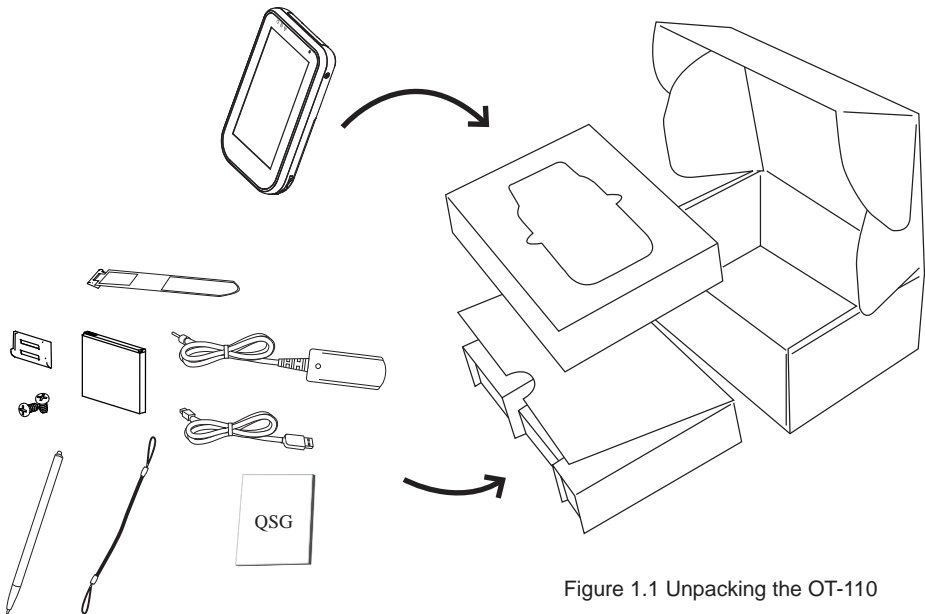
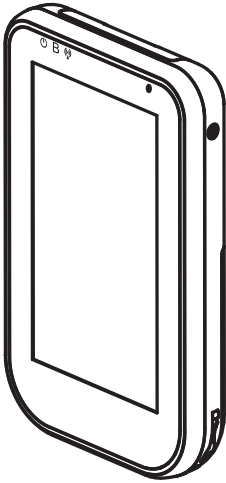

Figure 1.1 Unpacking the OT-110

Carefully unpack the machine and keep the packing materials. If you need to ship it in the future, repack it as shown in Figure 1.1.

# Checking the package contents

After you unpack the device check that the following items are included.



OT-110

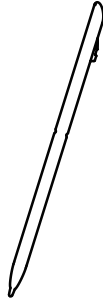

Stylus

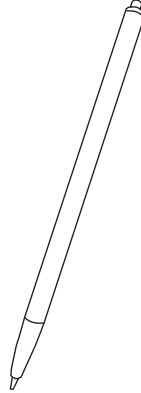

High quality stylus



Quick start guide

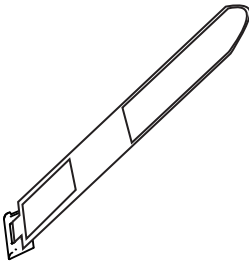

Hand strap

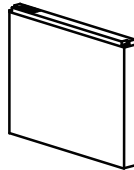

Battery



2 screws



Plastic hinge



Stylus cord



AC adaptor

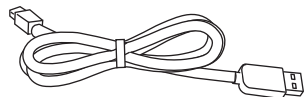

mini-USB to USB cable

Optional

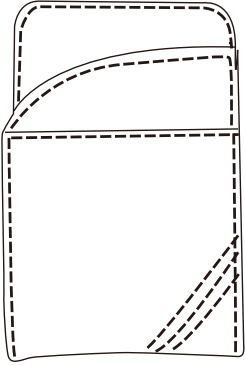

Leather pouch

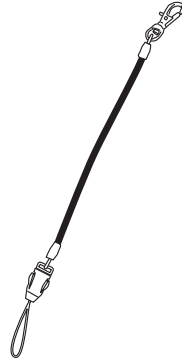

Leather pouch cord

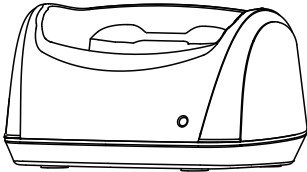

Cradle

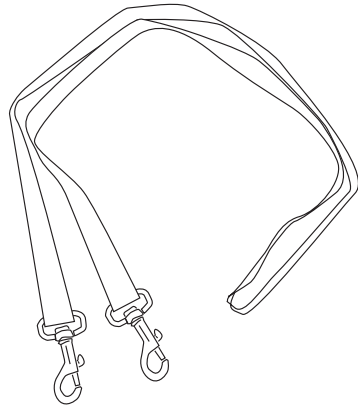

Shoulder strap

If any item is missing or appears damaged, contact your dealer immediately.

# Identifying components

This section describes the parts and connectors on the OT-110.

## Front panel components

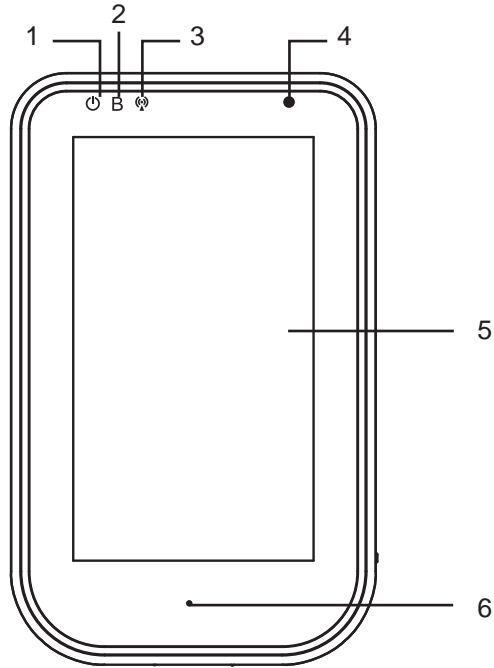

Figure 1.2 Front view

Component	Description
1	Power indicator (Green: charging full, Red: charging)
2	Bluetooth indicator (Blue: Bluetooth is Disabled)
3	WiFi indicator (Green: WiFi is enabled)
4	Light sensor
5	4.3-inch touch screen
6	Microphone

## Top and bottom panel components

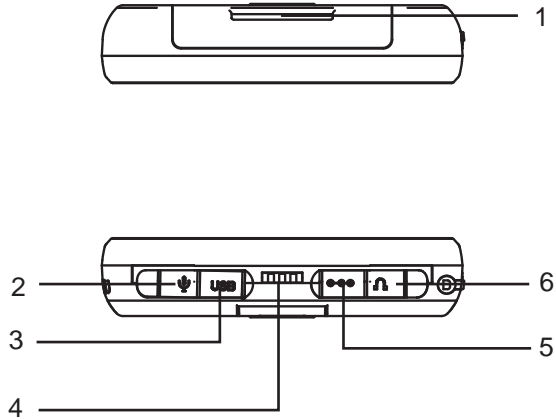

Figure 1.3 Top and bottom view

Component	Description
1	Top hand strap eyelet
2	2.5mm microphone jack
3	Mini-USB port
4	Cradle connector
5	DC power jack
6	3.5mm headphone jack

## Left and right side components

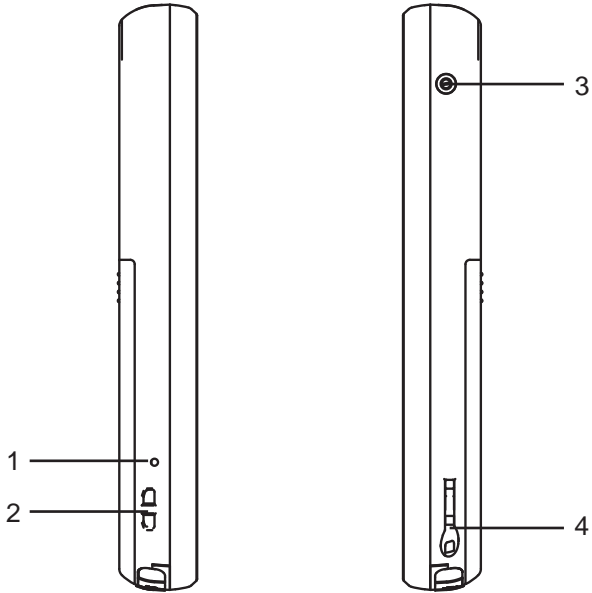

Figure 1.4 Left and right side view

Connector	Description
1	Reset button
2	Leather pouch strap eyelet
3	Power button
4	Stylus dock



## Back panel components

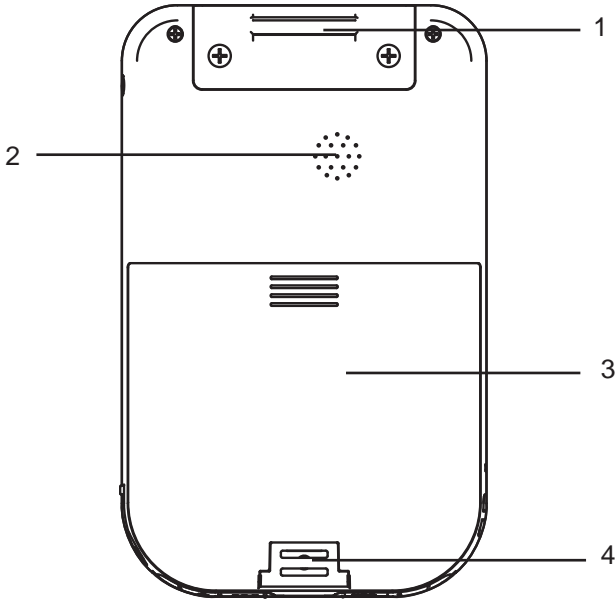

Figure 1.5 Back view

Connector	Description
1	Top hand strap eyelet
2	Speaker
3	Battery cover
4	Bottom hand strap eyelet

# Charging Cradle

This section introduces the charging cradle for the OT-110.

The charging cradle is used to charge the OT-110. A second slot is also available for charging a spare battery.

## Top and front view of the cradle

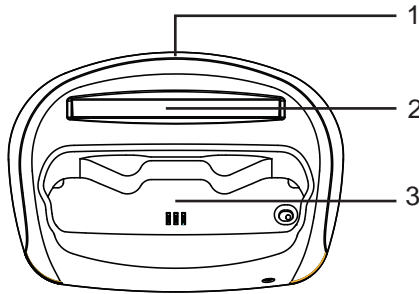

Figure 1.6 Top view of the cradle

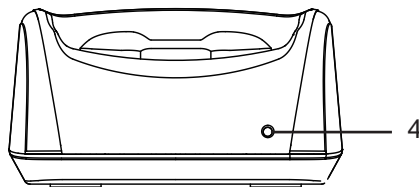

Figure 1.7 Front view of the cradle

Connector	Description
1	DC power connector
2	Battery slot
3	OT-110 socket
4	Battery slot charging indicator

# Setup the OT-110

Refer to the following to setup the OT-110.

1. Remove the battery cover.

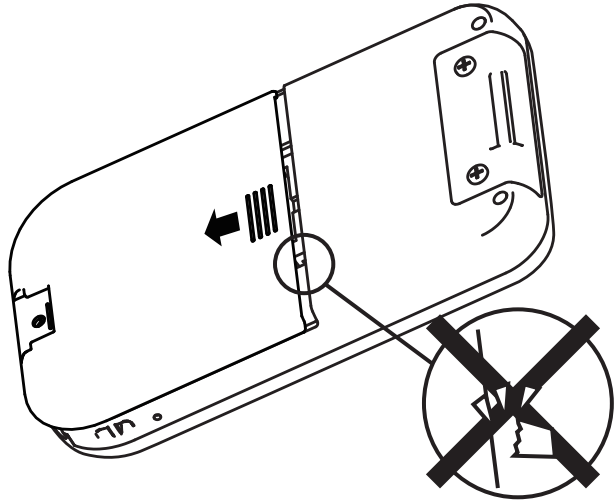

Slide the cover downwards to open.



**CAUTION**

*The battery cover hinge is small and fragile, don't break it by forcing the battery cover off. OT-110 can't be powered on without the hinge.*

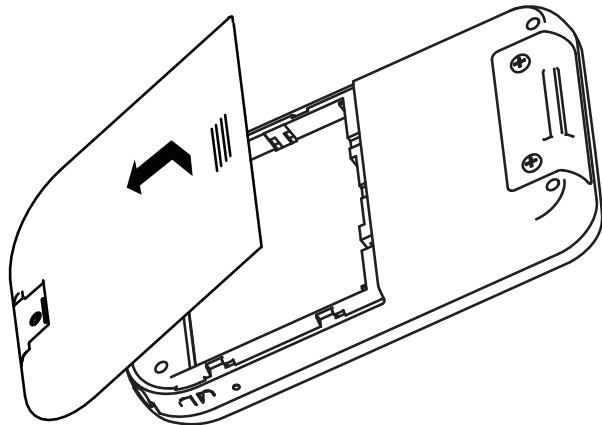

Lift up to remove the battery cover.

2. Install the battery.

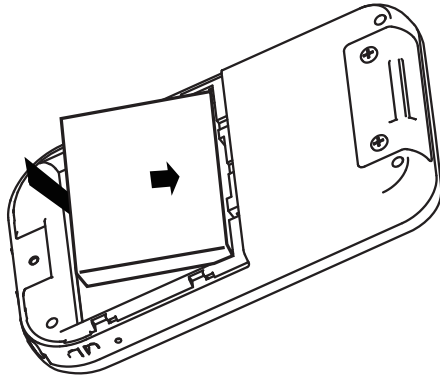

Align the battery connectors on the battery with the pins in the battery compartment and insert the battery.

3. Replace the battery cover and align hinge on the cover to the sensor hole in the battery compartment.

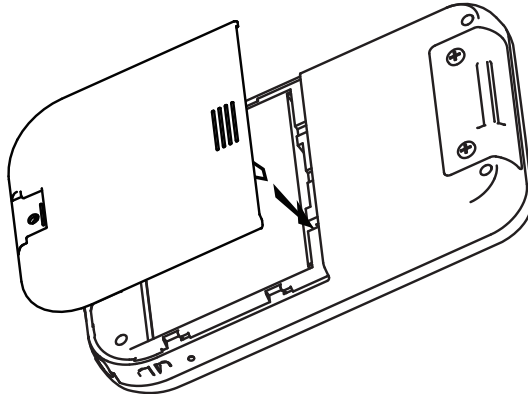

Slide the battery cover back until it locks.

4. Install the screw if required.

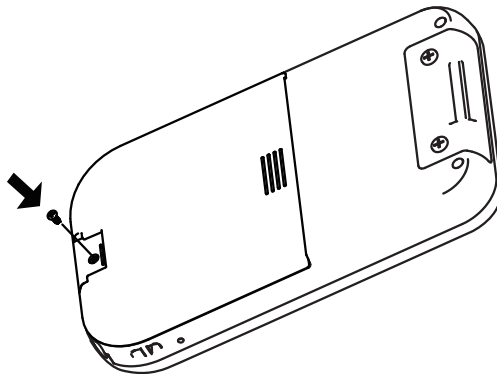

5. Insert the plastic hinge, or attach the hand strap.

(Refer to Chapter 3 - Attaching the hand strap).

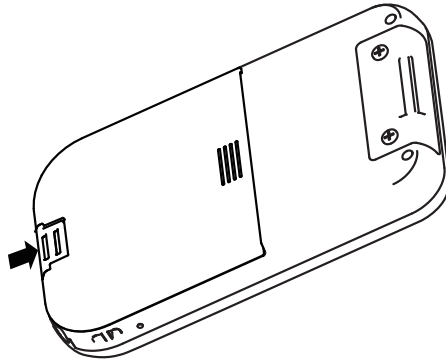

6. Charge the battery.

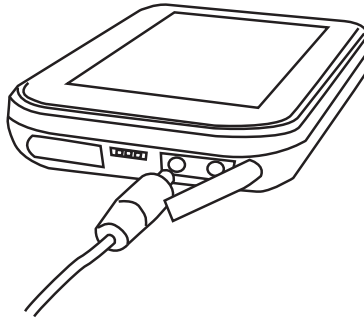

Open the power jack cover. Plug the AC adaptor power cord into an electrical outlet, then connect the DC plug of the adaptor cable to the OT-110. It takes approximately 6 hours to fully charge the battery for the first time. Subsequent charges might take longer.



**To avoid damaging OT-110 or the AC adaptor, make sure all connectors are properly connected.**

7. Use the stylus to press Power Button for three seconds to turn on OT-110.
- To turn off OT-110. Press Power Button for three seconds.

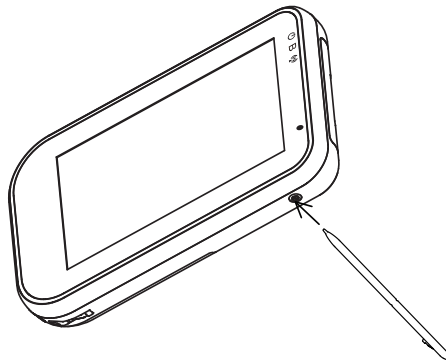

## Using the cradle

The charging cradle allows a more convenient way to charge OT-110. You can charge a spare battery (optional) individually or simultaneously as well.

### Charge the device in cradle

1. Plug the AC adaptor power cord into an electrical outlet, then connect the DC plug of the adaptor cable to the power jack at the back of cradle.
2. Insert OT-110 into the cradle with front of device on same side as front of cradle.
3. When device is inserted into cradle correctly, the Power LED on top left of device should turn red. Device charging is complete when the device Power LED turns green.

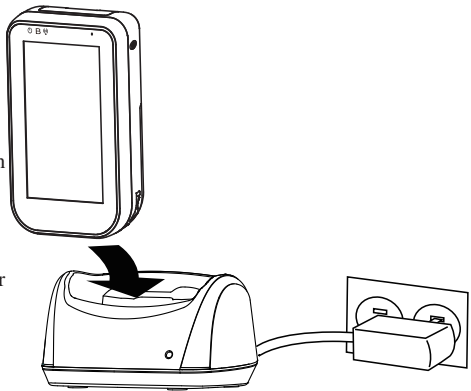

### Charge the battery in cradle

1. Plug the AC adaptor power cord into an electrical outlet, then connect the DC plug of the adaptor cable to the power jack at the back of cradle.
2. Align the battery connectors on the battery with the pins in the second battery slot of the cradle, then install the battery in the direction of the arrow.
3. When battery is inserted into cradle correctly, the battery LED on the cradle should light up red. Battery charging is complete when the battery LED on the cradle turns green.

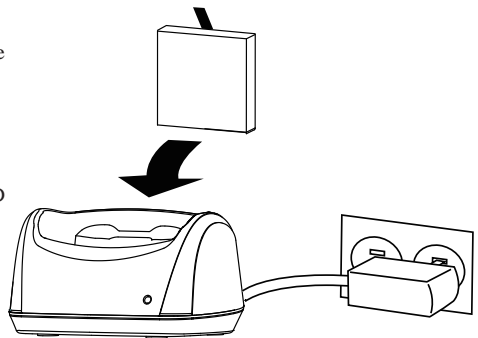

**IMPORTANT**

*To protect and prolong the life of the battery, do not charge it for 24 hours or longer at a time.*



**IMPORTANT**

*If battery is not used, please store in dry area, ideally with storage temperature around 25°C, or within a temperature range of -10°C ~ 30°C to maximize longevity.*



**IMPORTANT**

*Please make sure to perform 3 complete full charge and discharge cycles to get optimal battery capacity. Failure to comply will result in shorter battery lifespan.*

## Changing the battery

Refer to the following to change the battery.

1. Press the Power button to turn off the OT-110.
2. Remove the plastic hinge or the bottom of the hand strap.

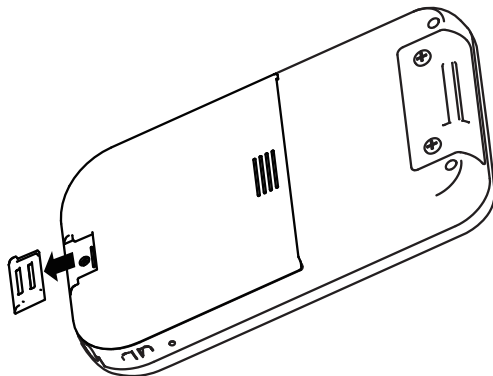

Slide the plastic hinge or hand strap down and away from the battery cover.

3. Remove the screw if the battery cover is locked.

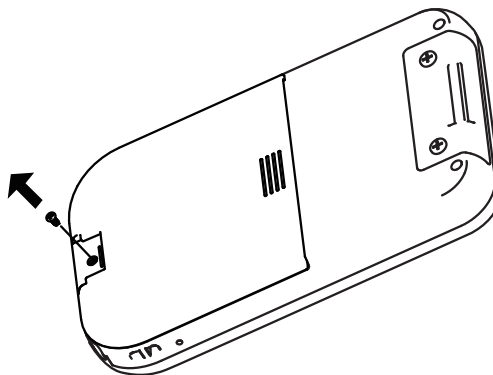

4. Remove the battery cover.

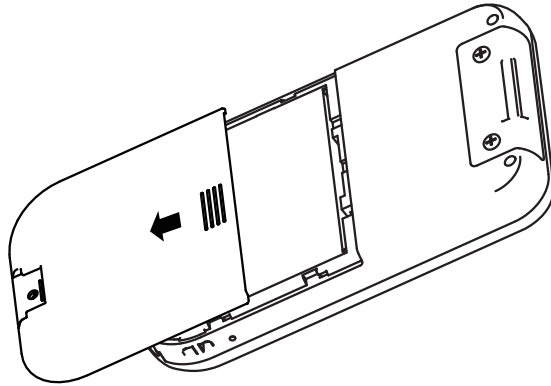

Slide the cover down, then lift up to remove.

5. Remove the battery by pulling on the plastic flap.

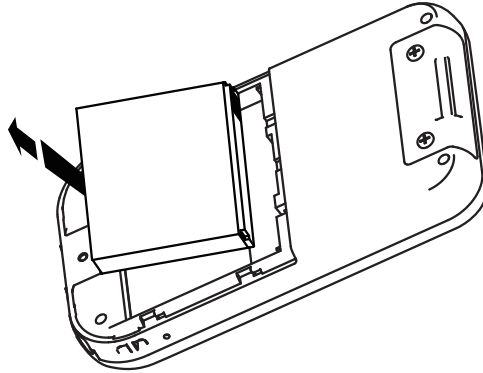

6. Install the new battery.

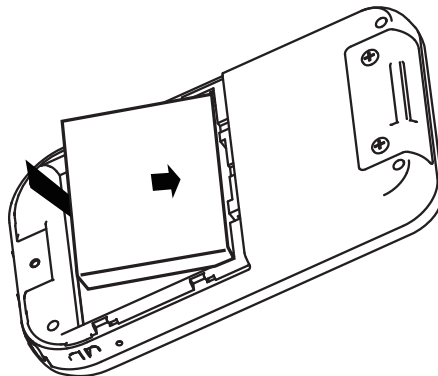

Align the battery connectors on the battery with the pins in the battery compartment and insert the battery.



7. Replace the battery cover by sliding it until it locks.

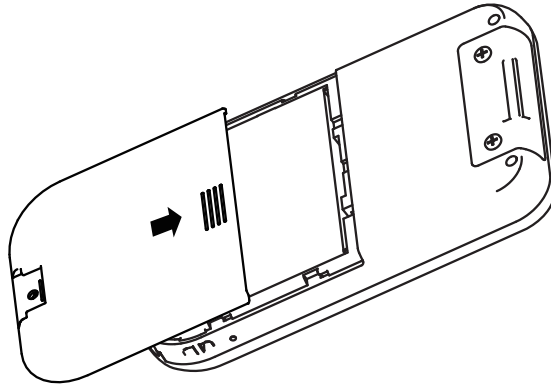

**IMPORTANT**

*Breaking the battery cover hook can cause the device cannot detect the battery installation status. Please follow the step instructions and install the battery cover carefully to avoid device failure.*

8. Reinstall the screw.

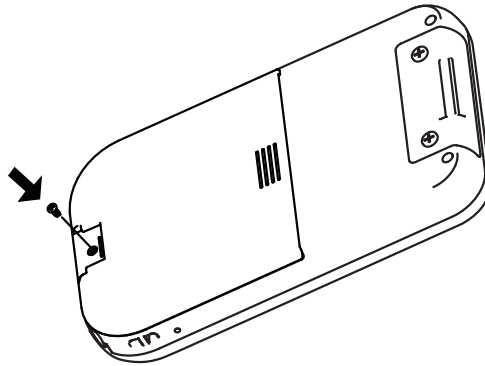

9. Replace the plastic hinge or the bottom of the hand strap.

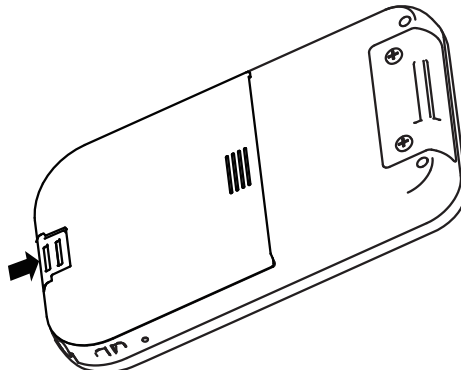

## Using microSD cards

Use microSD cards for:

- Expanding the memory of the OT-110
- Adding functionality

The OT-110 supports SDHC microSD cards.



**NOTE**

*microSD cards must be purchased separately and are not included with the OT-110.*

## Installing a microSD card

Refer to the following to install a microSD card.

1. Press the Power button to turn off the OT-110.
2. Remove the plastic hinge or the bottom of the hand strap.

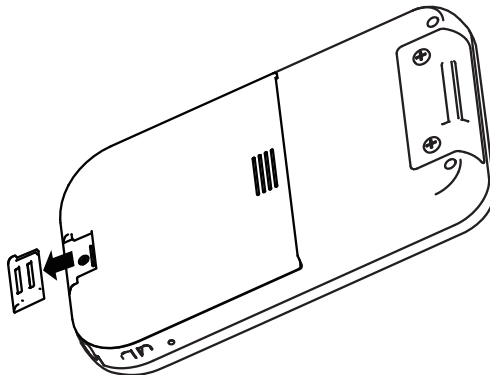

Slide the plastic hinge or hand strap down and away from the battery cover.

3. Remove the screw if the battery cover is locked.

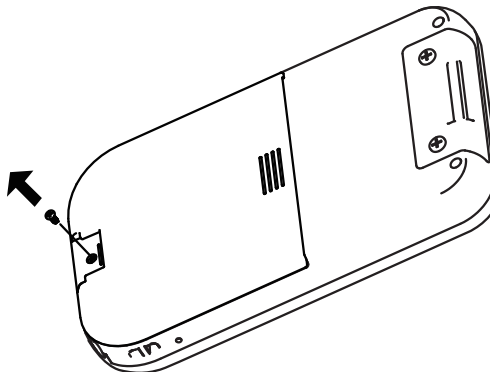

4. Remove the battery cover.

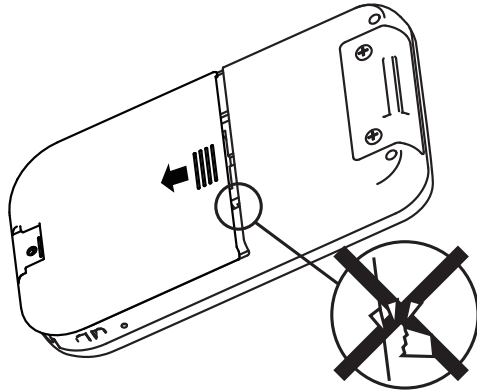

Slide the cover down, then lift up to remove.



**CAUTION**

*The battery cover hinge is small and fragile, don't break it by forcing the battery cover off. OT-110 can't be powered on without the hinge.*

5. Remove the battery by pulling on the plastic flap.

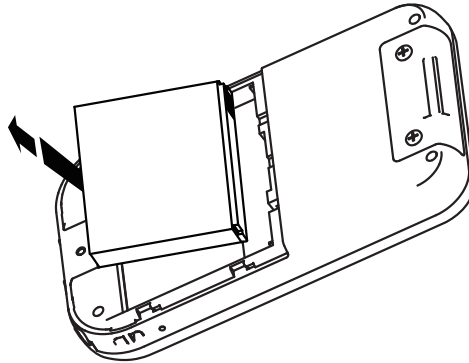

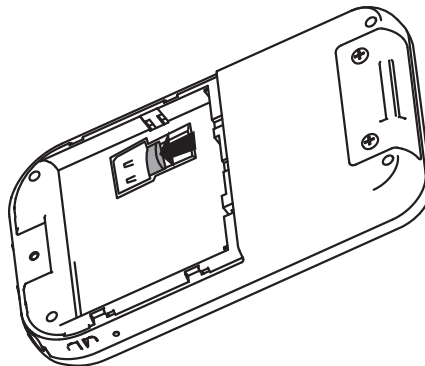

6. Insert the microSD card into the slot with the label facing out and push it until it clicks into place.



## View the contents of a microSD card

Refer to the following to view the contents of a microSD card.

<p>1. Tap  → Programs → Windows Explorer.</p>	 <p>The screenshot shows the Start menu of a Windows Mobile device. The 'Start' button is at the top left. Below it is the 'PARTNER' logo. A Start menu is open, listing various applications. 'Windows Explorer' is highlighted with a red rectangular box at the bottom of the list.</p>
<p>2. Double tap SD Card to see a list of files and folders.</p> <ul style="list-style-type: none"><li>• If the OT-110 does not recognize your MicroSD card, make sure you have firmly pushed the MicroSD card into the slot.</li></ul>	 <p>The screenshot shows the Windows Explorer window. The title bar reads 'File Edit View Go'. The main area displays a list of folders and files: Application Data, Documents and Settings, My Documents, Network, Program Files, SD Card, Temp, Windows, and Control Panel. The 'SD Card' folder is circled in red. The taskbar at the bottom shows 'My Device', a clock at '11:05 AM', and other system icons.</p>

# CHAPTER 2

## USING THE DEVICE

This chapter describes how to use OT-110 features. The following topics are described.

- Entering text on page 19
- Shortcut menus on page 19
- Windows CE help on page 20
- Performing a reset on page 20
- Opening and closing programs on page 20
- Program switch on page 20
- Status icons on page 20
- Adjusting the volume on page 21
- Setting the power schemes on page 22
- Changing the device name on page 24
- Entering owner information on page 25
- Recalibrating the screen on page 27
- Setting the date and time on page 28
- Using Settings Manager on page 30
- PC GetInformation on page 37
- Lock Screen on page 38
- Connecting to a WLAN network on page 38
- Synchronization on page 46
- Copy or move files between the computer and OT-110 on page 48
- Install and remove programs on page 49
- Backup data on page 51
- Restore data on page 53
- Upgrading Operating System on page 55

### Entering text

You can use the Input Panel to enter text. To use the Input Panel, tap the  on the taskbar.



Tap keys on the Input Panel to enter text.

### Shortcut menus

A shortcut menu is displayed when you tap and hold an item. This menu displays the most common commands for the specific item. When the shortcut menu displays, tap the action you want to perform. To close a shortcut menu without performing an action, tap anywhere outside the menu.

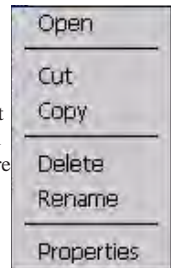

## Windows CE help

Read the help information when you want to learn more about the program by tapping the  on the left top of the program window. The help window will pop-up.

## Performing a reset

A reset stops all running applications, but does not erase any programs, saved data, or registry information.

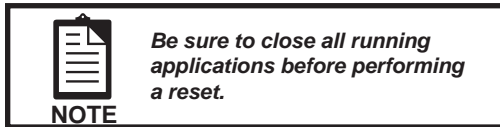

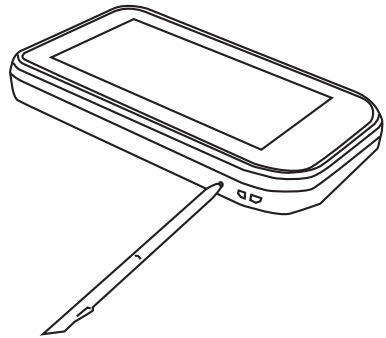

To perform a reset:

1. Locate the recessed Reset button on the device.
2. Use the stylus to lightly press the Reset button.



## Opening and closing programs

You do not need to exit a program to open another or to conserve memory. The system manages memory automatically.

To open a program, tap , and then select the required program from the list. If you do not see the program you want to launch, tap  → Programs.

In most cases, selecting  or **OK** will close an application.



## Program switch



You can use the program switch to quickly select the running program. To use the program switch, tap the  on the taskbar, then tap the program you want on the list.



## Status icons

There are status icons in taskbar. The following table lists the icons and their meanings.

Icon	Status
	Battery charging
	Battery level low
	Battery level critical

Icon	Status
	WLAN connected
	WLAN not connected
	USB connected

# Adjusting the volume

1. Tap  → Settings → Control Panel.



2. Double tap the Volume & Sounds icon.

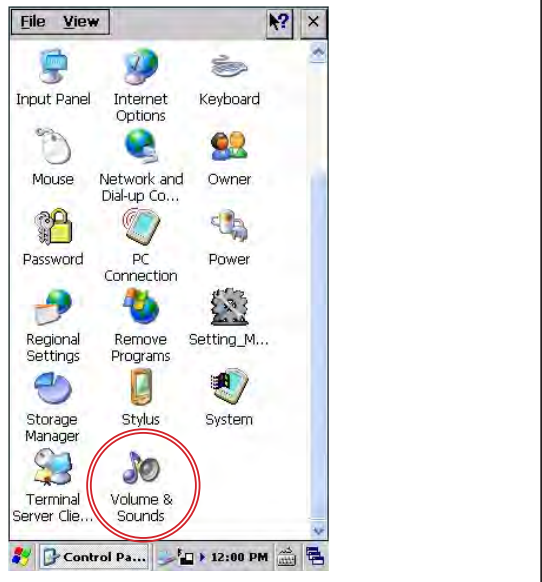

3. Select the Volume tab.
4. Move the system volume slider on the screen to the required volume level.
5. Tap the OK button.

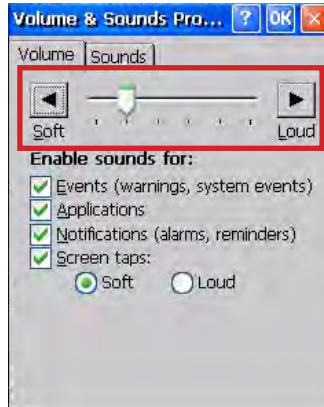

## Setting the power schemes

1. Tap  → Settings → Control Panel.





2. Double tap the Power icon.



3. Select the Schemes tab.

4. Select desired options for entering reduced power states.

5. Tap the OK button.

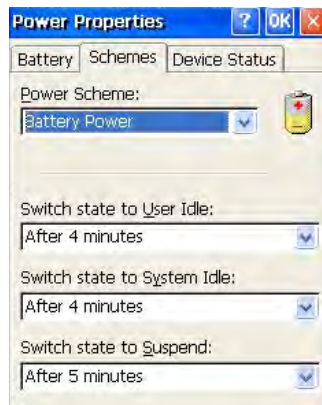



***The time choices represent the amount of time that must pass before the system will switch to the next power conservation state. For example, if “Switch state to System Idle:” is set to “After 4 minutes,” then the system will transition from the User Idle state to the System Idle state after 4 minutes of inactivity.***

# Changing the device name

The device name is used to identify the OT-110 in the following situations:

- Connecting with a computer
- Connecting to a network

Refer to the following to change the device name.

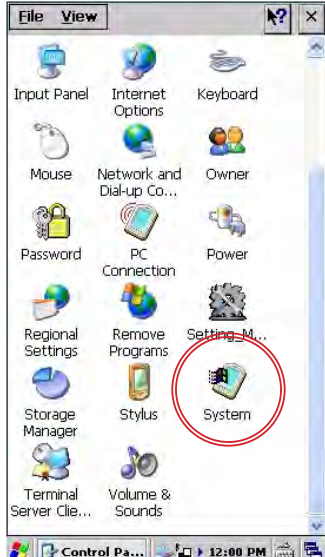
<p>1. Tap  → Settings → Control Panel.</p>	 <p>The screenshot shows the Windows Start menu. At the top is the Internet Explorer icon. Below it is the 'PARTNER' logo. A menu is open, listing 'Programs', 'Favorites', 'Documents', 'Control Panel', 'Network and Dial-up Connections', and 'Taskbar and Start Menu...'. The 'Control Panel' option is highlighted with a red rectangular box. The taskbar at the bottom shows the time as 12:00 PM.</p>
<p>2. Double tap the System icon.</p>	 <p>The screenshot shows the Windows Control Panel window. It contains various system settings icons such as Input Panel, Internet Options, Keyboard, Mouse, Network and Dial-up Connections, Owner, Password, PC Connection, Power, Regional Settings, Remove Programs, Settings Manager, Storage Manager, Stylus, System, Terminal Server Client, and Volume &amp; Sounds. The 'System' icon is circled with a red circle. The taskbar at the bottom shows the time as 12:00 PM.</p>

3. Select the Device Name tab.
4. Enter a name. The device name must begin with a letter, consist of letters from A to Z and numbers from 0 to 9, and should not contain spaces.
5. Tap the OK button.

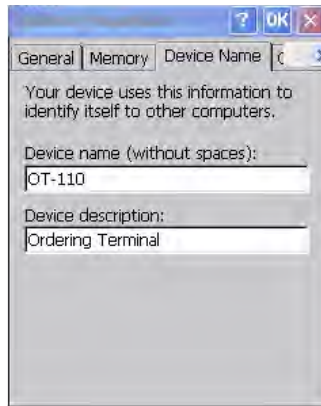

## Entering owner information

Enter your personal information, such as your name and address, so that the OT-110 can be returned to you if it is lost. Refer to the following to enter the information.

1. Tap  → Settings → Control Panel.



2. Double tap the Owner icon.





3. On the Identification tab, enter your personal information.



# Recalibrating the screen

If your stylus seems to be out of sync with the screen, then recalibrate the screen using your stylus.

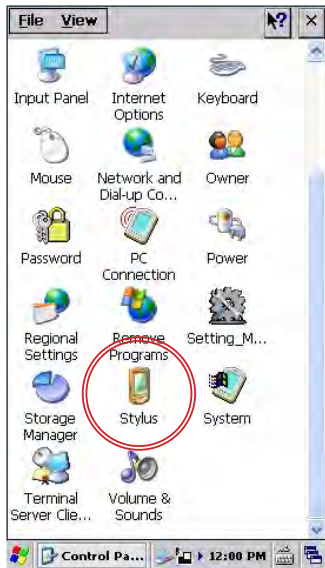
<p>1. Tap  → Settings → Control Panel.</p>	 <p>A screenshot of the Windows Start menu. The 'Control Panel' option is highlighted with a red rectangular box. Other visible options include Programs, Favorites, Documents, Network and Dial-up Connections, Taskbar and Start Menu..., and Suspend. The desktop background features the 'PARTNER' logo.</p>
<p>2. Double tap the Stylus icon.</p>	 <p>A screenshot of the Windows Control Panel window. The 'Stylus' icon is circled with a red circle. Other visible icons include Input Panel, Internet Options, Keyboard, Mouse, Network and Dial-up Co..., Owner, Password, PC Connection, Power, Regional Settings, Remove Programs, Setting_M..., Storage Manager, System, Terminal Server Cle..., and Volume &amp; Sounds.</p>

3. Select the Calibration tab then tap the Recalibrate button.
4. Follow the displayed instructions to recalibrate. Please use the stylus to calibrate the screen for better accuracy.

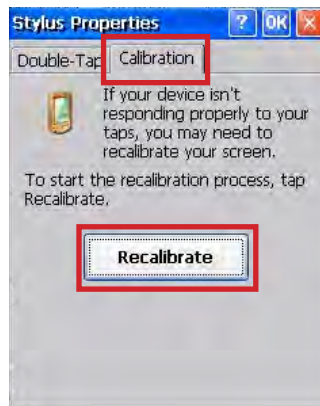

## Setting the date and time

Refer to the following to set date and time.

1. Tap  → Settings → Control Panel.



2. Double tap the Date/Time icon.



3. Change the date or time and select the correct time zone.

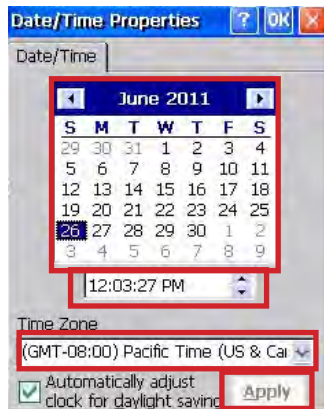

4. Tap the Apply button.



# Using Settings Manager

Settings Manager controls settings for Modules, WLAN, Bluetooth, screen rotation, backlight and vibration.

To enter Settings Manager

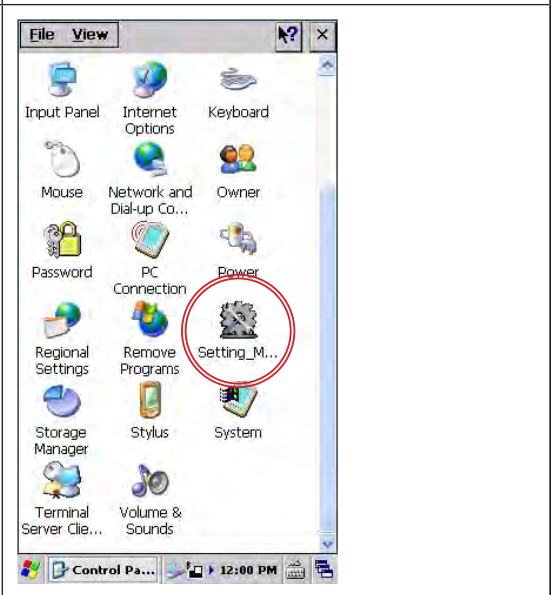
<p>1. Tap  → Settings → Control Panel.</p>	 <p>A screenshot of a Windows XP desktop. The Start menu is open, and the 'Control Panel' option is highlighted with a red rectangle. The desktop background features the 'PARTNER' logo. Other visible icons include Internet Explorer, Programs, Favorites, Documents, Network and Dial-up Connections, and Taskbar and Start Menu... The taskbar at the bottom shows the time as 12:00 PM.</p>
<p>2. Double tap the Setting Manager icon.</p>	 <p>A screenshot of the Windows XP Control Panel window. The window title is 'File View'. The 'Setting Manager' icon, which depicts a gear, is circled in red. Other icons in the window include Input Panel, Internet Options, Keyboard, Mouse, Network and Dial-up Co..., Owner, Password, PC Connection, Power, Regional Settings, Remove Programs, Storage Manager, Stylus, System, Terminal Server Cle..., and Volume &amp; Sounds. The taskbar at the bottom shows the time as 12:00 PM.</p>



## Modules tab

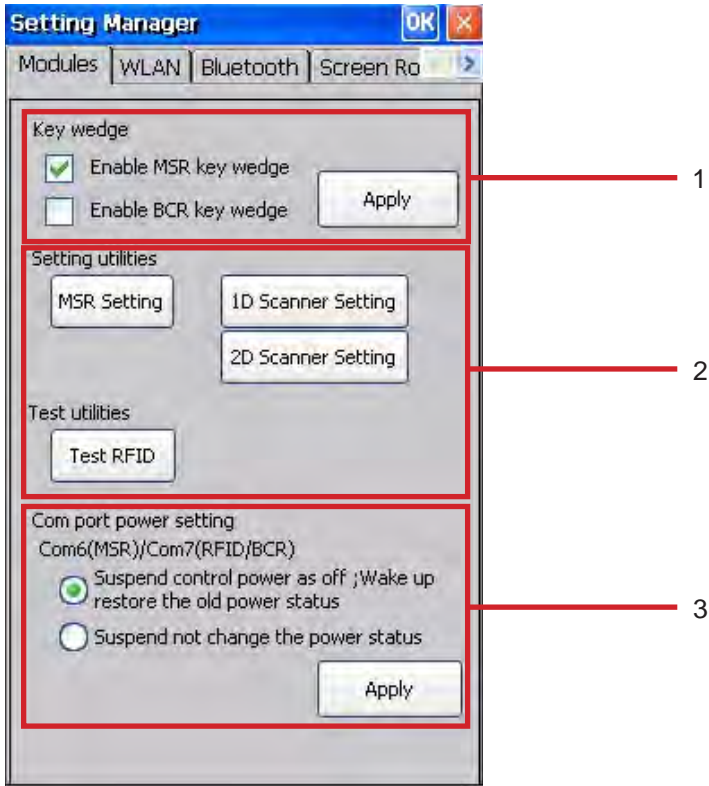

Item	Description
1	Check the box and tap the Apply button to enable MSR/ BCR key wedge mode. Key wedge mode is a software interface lets you to convert MSR/ BCR input data to keystrokes.
2	These button are used to enter the mouldle test utilities. You can use these utilities to test the installed modules.
3	Select the COM port power setting for COM6 (MSR mouldle) and COM7 (RFID/ BCR mouldle), and then tap the Apply button to confirm.

## WLAN tab

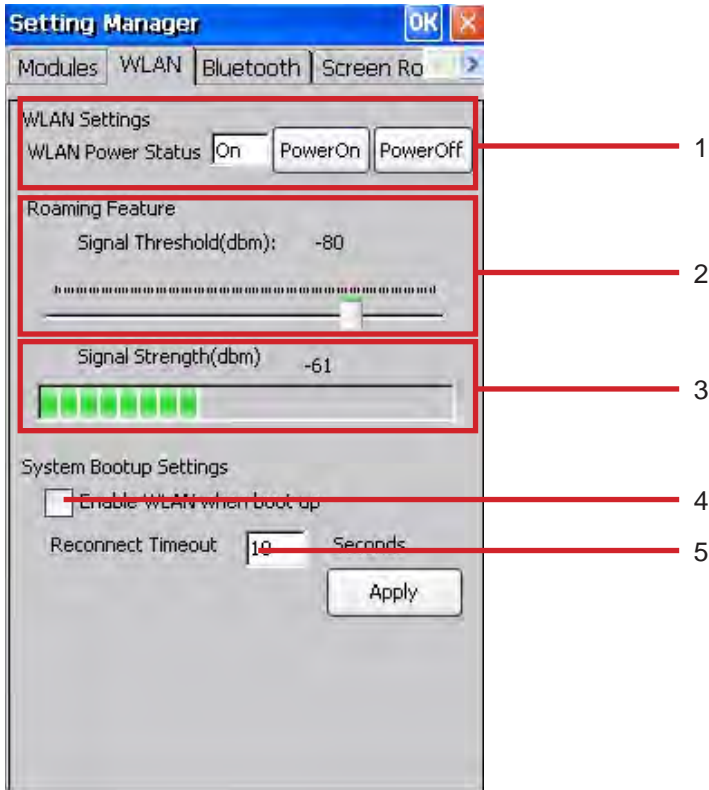

Item	Description
1	This block allows you to turn WLAN on/off.
2	This feature allow you to set the WLAN roaming. When the signal strength of the old access point drops below the threshold setting value, the device will attempt to connect to the new access point.
3	This bar shows the strength of current signal.
4	Check this box to enable WLAN when device boots up.
5	Whenever device attempts to connect to a wireless network and fails, there is a delay before it attempts to connect again. To change this value, please enter a number between 1 and 600 seconds.

## Bluetooth tab

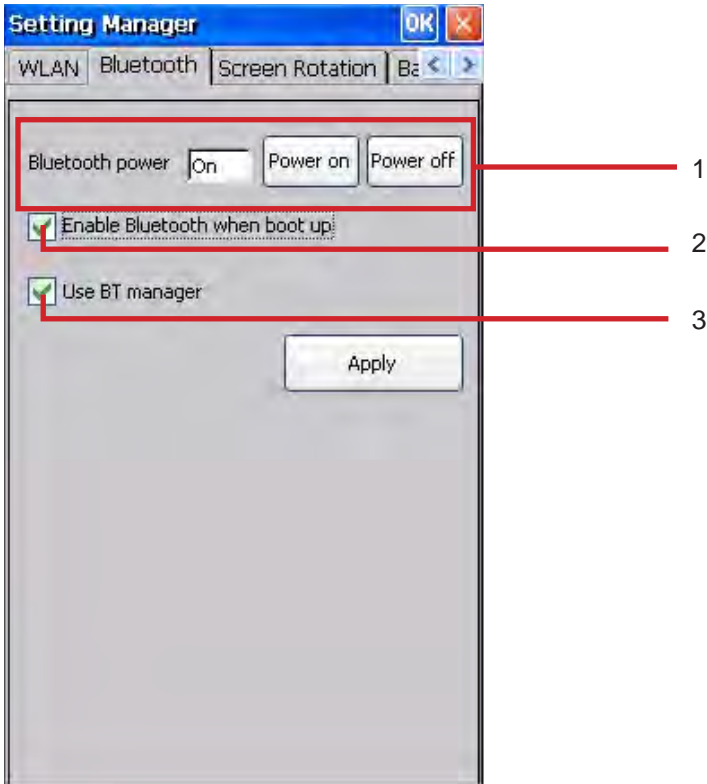

Item	Description
1	This block allows you to turn Bluetooth on/off.
2	Check this box to enable Bluetooth when device boots up.
3	Check this box to use BT manager, and also run BT manager when device boots up. When it is enabled, the BT manager icon will appear on the taskbar. For more information on BT manager, please consult following section "Using BT Manager".

## Screen Rotation tab

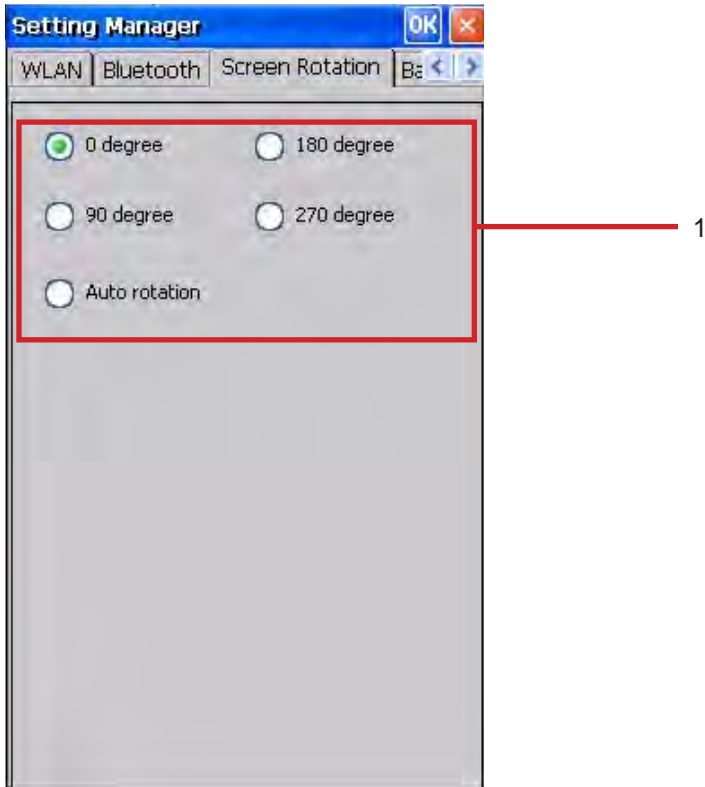

Item	Description
1	Screen rotation can be changed by select the different options (0, 90, 180, 270, Auto). Once Auto Rotation is enabled, the screen will rotate automatically when the device is turned sideways.

## Backlight tab

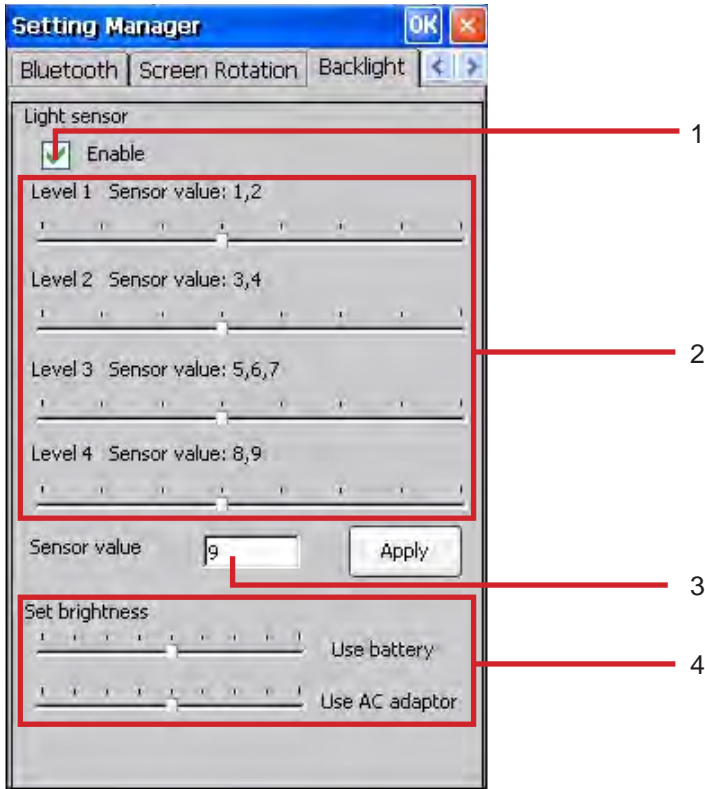

Item	Description
1	Check this box to enable the light sensor.
2	The light sensor has nine values. With this panel you can adjust your backlight levels according to the values.
3	This box shows the current value of the light sensor.
4	These two bars allow you to set screen brightness for battery and AC modes separately.

## Other tab

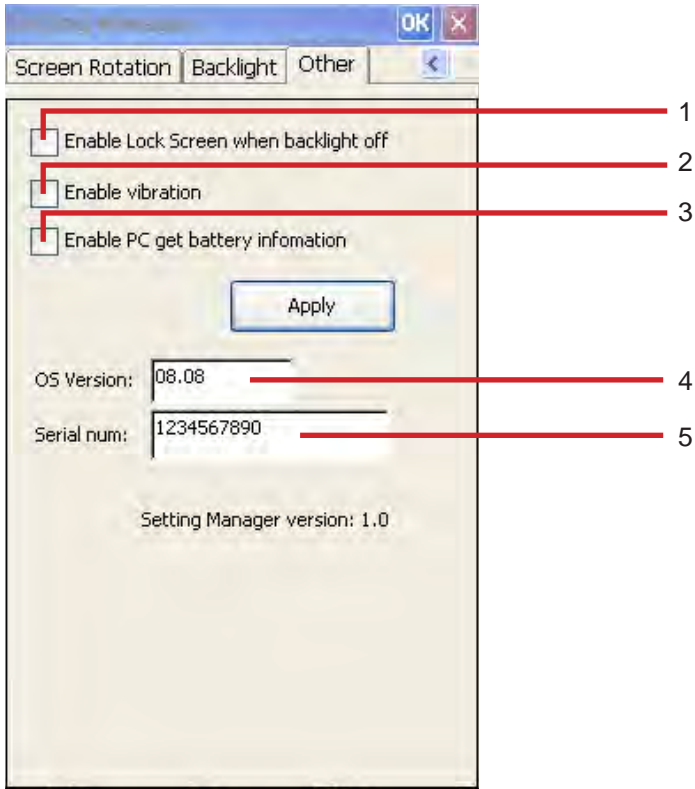

Item	Description
1	Check this box to enable Lock Screen when backlight off.
2	Check this box to enable the vibration feature.
3	Check this box to enable PC get battery information. With this feature you can read the device information from the software application that you have installed in Windows.
4	This box shows the current OS version of the device.
5	This box shows the serial number of the device.

# PC GetInfomation

With PC GetInfomation, administrator can monitor the battery information of devices via network. To use the PC GetInfomation:

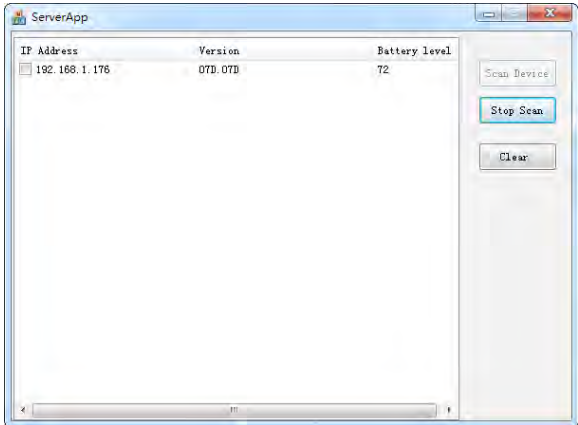
<p>Both your PC and OT-110 must be in the same IP subnet. For example the IP of your PC is 192.168.1.1 and your OT-110 is 192.168.1.2</p> <ul style="list-style-type: none"><li>• Use your OT-110. Check “Enable PC get battery information” on the “Other” tab of the Setting manager, and then tap “Apply”.</li></ul>	
<ol style="list-style-type: none"><li>3. Use your PC. Active PC GetInfomation by double-clicking the ServerApp.exe file.</li><li>4. Click “Scan Device”</li><li>5. The OT-110 Battery Level will be shown on the window.</li></ol>	

# Lock Screen

<p>When activated, Lock Screen will disable audio and lock the screen. User will see the following when touch the screen.</p>	
---	---



# Connecting to a WLAN network

With wireless access, you can connect the device to the Internet. The device can connect to an IEEE 802.11b/g device or connect directly to other WLAN-enabled devices.

## Automatically connect to a WLAN network

When you turn on the WLAN, the device will automatically detect WLAN networks that are broadcasting their signals (SSID network name). If your WLAN network is not set to broadcast SSID, then you have to connect to it manually. Before trying to connect to a WLAN network, determine if authentication information is needed by contacting your network administrator.

To automatically connect to a WLAN network:

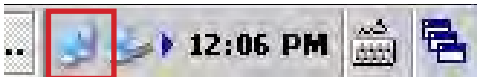
<ol style="list-style-type: none"><li>1. Turn on the WLAN.</li><li>2. Double tap  or  on the taskbar.</li></ol>	
---	---



3. Select the Wireless Information tab.
4. Select an available network.
5. Tap the Connect button.







6. Set the properties. Normally, all settings will be detected automatically. If necessary, you can change settings as follow.
- To use data encryption, select an encryption method from the Encryption list.
  - To use authentication, select the authentication method from the Authentication list.
7. Tap the OK button.



## Manually connect to a WLAN network



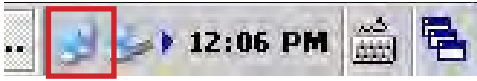

A wireless network can be added manually by entering the settings information to add the network. Contact your network administrator to determine if authentication information is needed before trying to connect to a WLAN network.

To manually connect to a WLAN network:

<ol style="list-style-type: none"> <li>1. Turn on the WLAN.</li> <li>2. Double tap  or  on the taskbar.</li> </ol>	
<ol style="list-style-type: none"> <li>3. Select the Wireless Information tab.</li> <li>4. Tap Add New...</li> </ol>	
<ol style="list-style-type: none"> <li>5. Set the properties.</li> <li>6. Enter the SSID. <ul style="list-style-type: none"> <li>• To use data encryption, select an encryption method from the Encryption list.</li> <li>• To use authentication, select the authentication method from the Authentication list.</li> </ul> </li> <li>7. Tap the OK button.</li> </ol>	 <p>Enter network key if necessary</p>

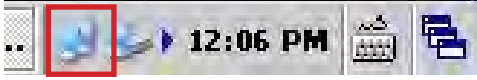

## Lock SSID

SSID Lock allows device to only connect to a defined SSID network. This feature saves time as device no longer searches for available networks, and also saves battery power. Check this box and enter the SSID name of the network device should connect to.

<ol style="list-style-type: none"><li>1. Turn on the WLAN.</li><li>2. Double tap  or  on the taskbar.</li></ol>	
<ol style="list-style-type: none"><li>3. Select the Wireless Information tab.</li><li>4. Select the network.</li><li>5. Tap Lock.</li></ol>	

## Specify the IP address and domain name servers (DNS)

The IP address and name server addresses are automatically assigned if DHCP is enabled on the wireless access point or network server. If your network does not automatically assign the addresses, ask your network administrator for the information and follow the instructions below.

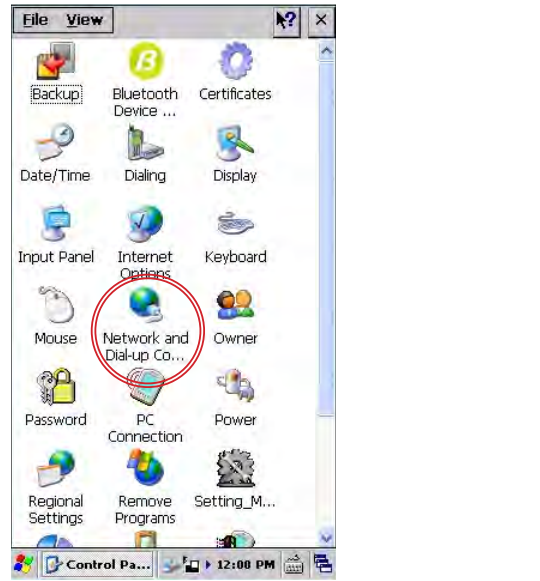
<p>1. Tap  → Settings → Control Panel.</p>	 <p>The screenshot shows a Windows XP desktop environment. At the top left is the Internet Explorer icon. In the center is the 'PARTNER' logo. The Start menu is open, displaying a list of options: Programs, Favorites, Documents, Control Panel (highlighted with a red box), Network and Dial-up Connections, Taskbar and Start Menu..., and Suspend. The system tray at the bottom right shows the time as 12:00 PM.</p>
<p>2. Double tap the Network and Dial-up Connections icon.</p>	 <p>The screenshot shows the Windows XP Control Panel window. The window title is 'File View'. The main area contains a grid of icons for various system settings: Backup, Bluetooth Device, Certificates, Date/Time, Dialing, Display, Input Panel, Internet Options, Keyboard, Mouse, Network and Dial-Up Co... (circled in red), Owner, Password, PC Connection, Power, Regional Settings, Remove Programs, and Setting_M... The system tray at the bottom right shows the time as 12:00 PM.</p>

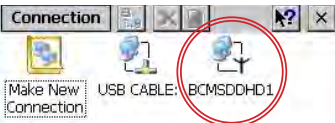
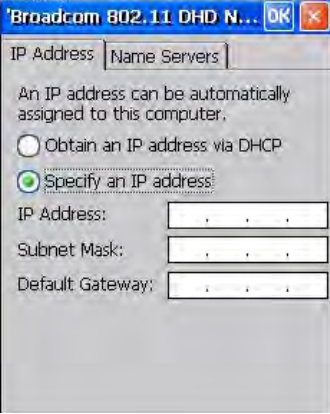
<p>3. Double tap the WLAN connection icon.</p>	
<p>4. Tap <i>Specify an IP address</i>.</p> <p>5. Enter <i>IP address, Subnet Mask, Default Gateway</i>.</p>	
<p>6. Tap the <i>Name Servers</i> tab on top</p> <p>7. Enter the DNS or WINS addresses.</p> <p>8. Tap the OK button.</p>	