

The essential guide Automation and Control

2013



How to find the “Automation and Control” products

> Catalogues

Complete product ranges



Modicon Premium automation platform
Catalogue
May 2012

Signalling Units
Harmony² tower lights, rotating beacons, sound units
Catalogue
May 2012

Control and signalling units Ø 22
Harmony² distribution
Catalogue
January 2013

Variable speed drives Altivar 12
For 3-phase asynchronous motors from 0.38 to 4 kW/0.25 to 5 HP
Catalogue
January 2013

PDF
Adobe

> Essential guides

Selection of the top selling products



The essential guide Automation
2013

The essential guide TeSys Power control and Protection
2013

The essential guide Magelis Human Machine Interfaces
2013

The essential guide Automation and Control
2013

PDF
Adobe

Contents

Operator dialog

- Control and signalling units
- Human Machine Interfaces
- Dialog operator for Explosive atmospheres

1

Automation

- Relays
- Controllers for commercial and industrial machines
- Programmable Automation Controllers (PACs)
- Softwares

2

Motion and Drives

- Soft starters and variable speed drives
- Drives, motors and linear motion axes

3

Motor control

- Motor control components
- Complementary products selection guides

4

Power supplies

- Power supplies
- Transformers

5

Interfaces and I/O

- Distributed Inputs/Outputs
- Distributed I/O with embedded control
- Pre-wired interfaces
- Accessories and Cabling

6

Networks, connectivity and Web servers

- ConneXium cabling system
- AS-Interface cabling system
- Servers and Gateways

7

Machine safety

- Safety chain solutions
- Automation
- Operator dialog
- Motor control

8

Search, visualize, and download

Use your tablet or your PC to quickly access detailed and comprehensive information on all our products



Tablets

Application name: "Automation Library by Schneider Electric"

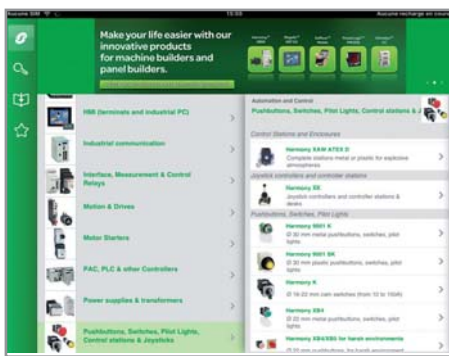

All product ranges displayed by function



Dynamic catalogues (hyperlinks, video, ...)

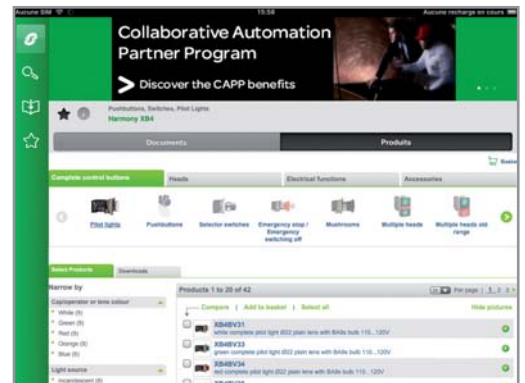

Product selector: dynamic filters to get easily your part number





Personal computer

Path: www.schneider-electric.com > **Products and Services** > Automation and control > Product offer

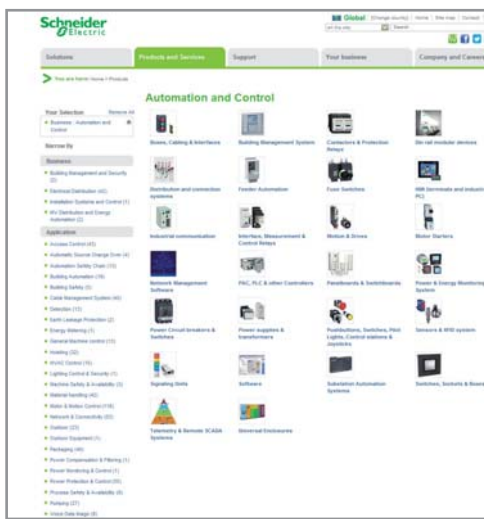

All product ranges displayed by function

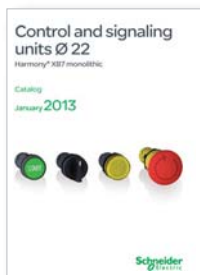
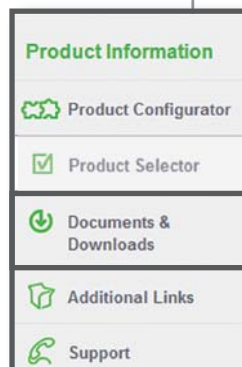
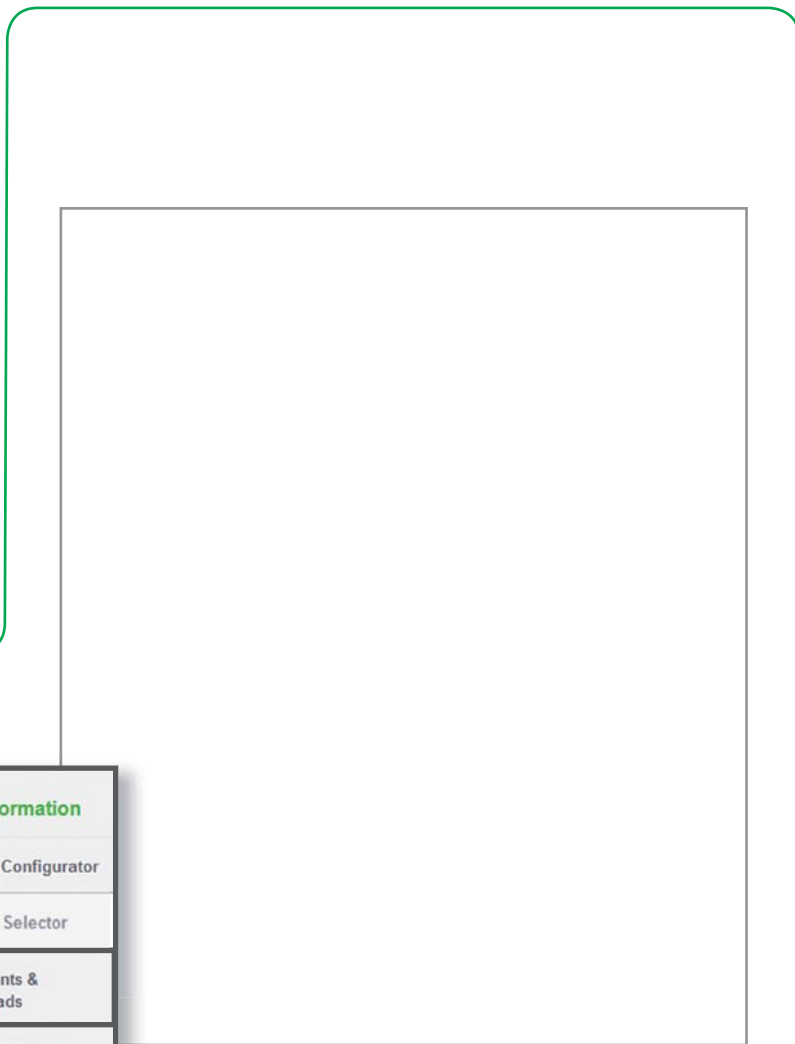

Dynamic catalogues (hyperlinks, video, ...)

Product selector: dynamic filters to get easily your part number

Access product references with adapted tools



Path: www.schneider-electric.com > **Products and Services** > Automation and control > ... > Product offer

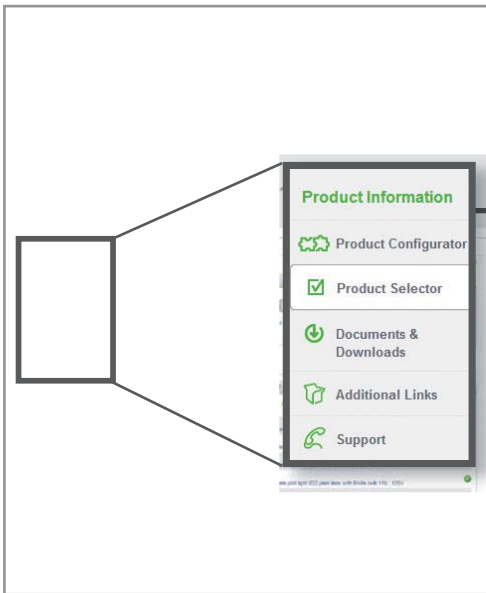

Graphic product configurator
Select the right product with just a few clicks

Dynamic product selector
Visualize product characteristics and dimensions



Product data sheet
with technical characteristics
and dimensions

Dimensions **Technical characteristics**

* Example of research on a product

Documents and downloads
 Visualize and download catalogues,
 technical publications, certificates, etc.

Product Information

- Product Configurator
- Product Selector
- Documents & Downloads
- Additional Links
- Support

Schneider ELECTRIC

Solutions Product and Function Support Your Business Company and Career

Harmony XB4 - Ø 22 mm metal pushbuttons, switches, pilot lights

Product Information

Documents & Downloads

File Name	Size	Download
Harmony XB4 - Ø 22 mm metal pushbuttons, switches, pilot lights	1.2 MB	Download
Harmony XB4 - Ø 22 mm metal pushbuttons, switches, pilot lights	1.2 MB	Download
Harmony XB4 - Ø 22 mm metal pushbuttons, switches, pilot lights	1.2 MB	Download

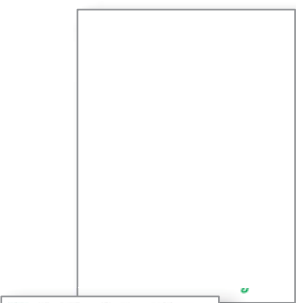

Control and signaling units Ø 22
 Harmony XB7 monolithic

Catalogue
 January 2013

Dynamic catalogues

Essential guides



Certificates

ZB4BC / ZB5AC

Implementation / Mise en œuvre / Utilization

HAZARD OF ELECTRIC SHOCK / RISK OF ELECTRIC SHOCK / PELIGRO DE ELECTROCHOQUE

Electrical equipment should be installed, operated, serviced, and maintained only by qualified personnel. No responsibility is assumed by Schneider Electric for any consequences arising out of the use of the material.

Technical publications



Compare, select, and compile



Path: www.schneider-electric.com > **Products and Services** > Automation and control > ... > Harmony XB4*

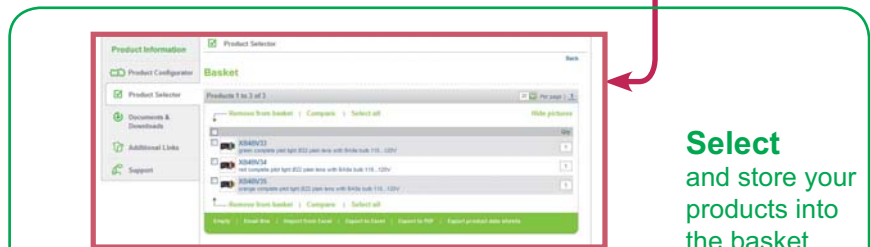
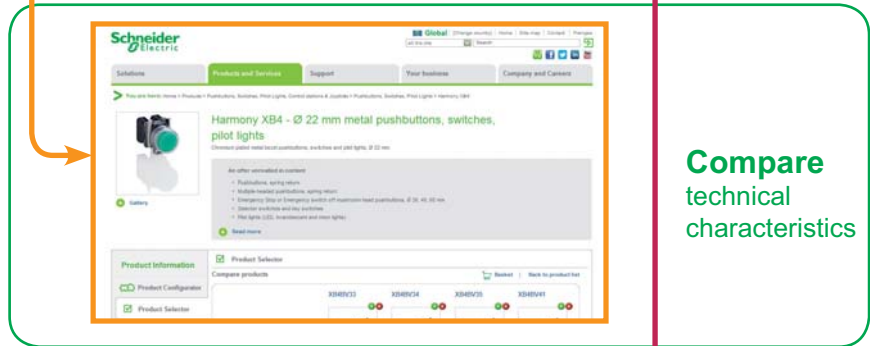
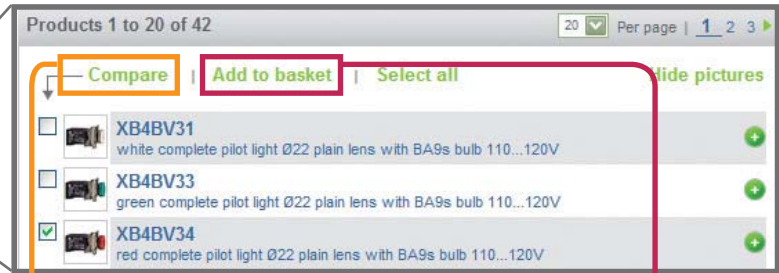
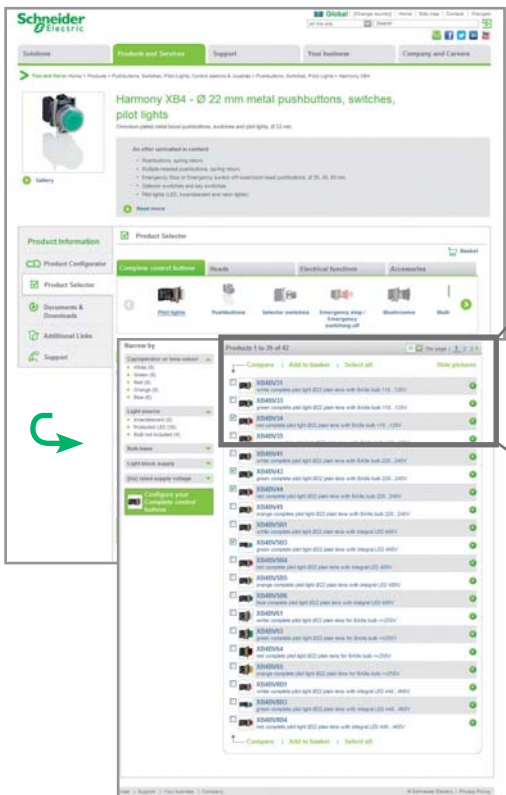

* Example of research on a product

Check the product status, design your equipment



Path: www.schneider-electric.com > **Support** > Product Substitution Tool
Path: www.schneider-electric.com > **Support** > CAD files

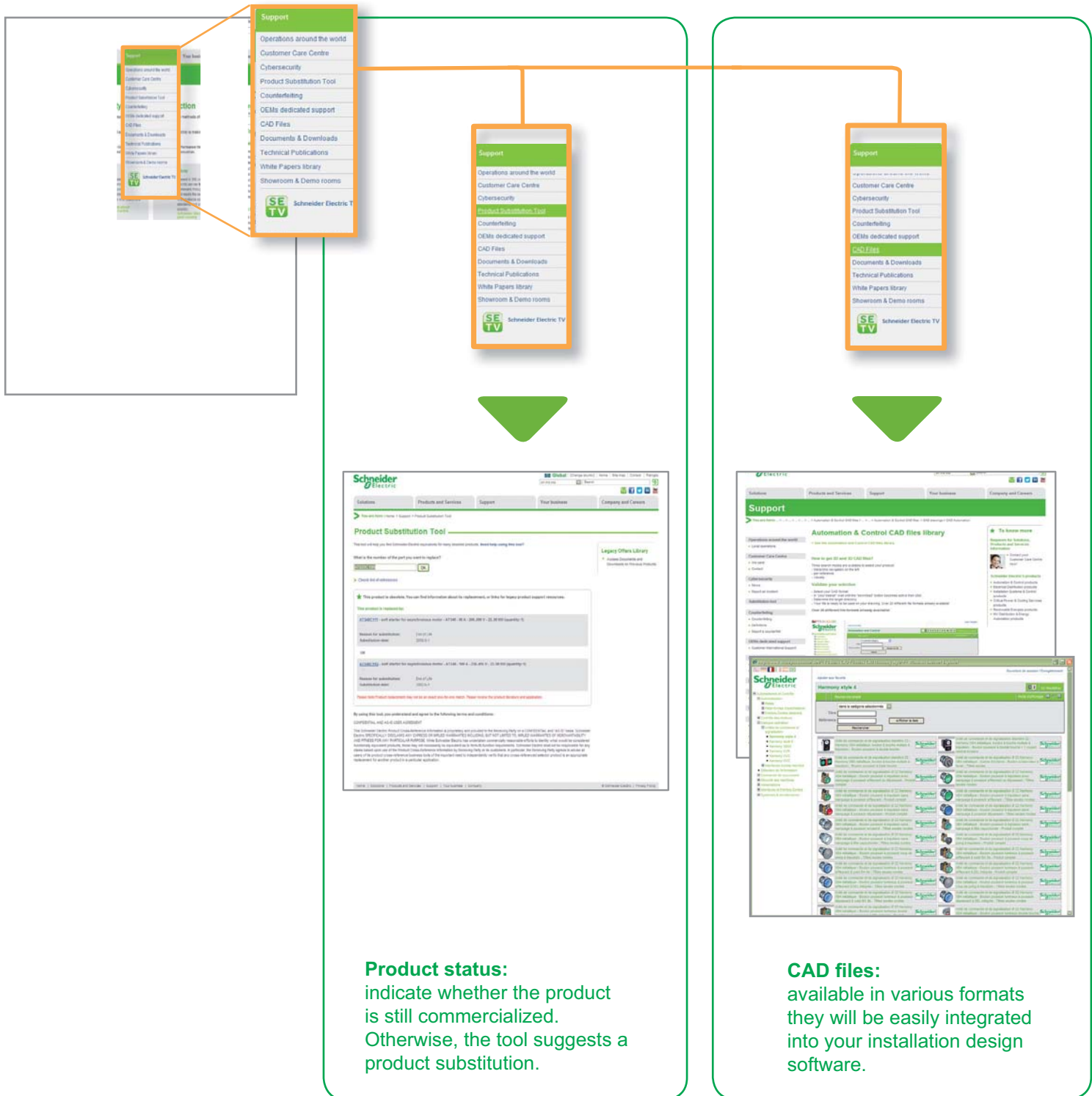

Please note that all references to products and services are just examples.

Innovative and simple products for all **Autom**

Interfaces and I/O

Connectors

Cable-ends, terminal blocs

Interfaces

Plug-in relays, analog converters, discrete interfaces

Pre-wired interfaces, IP20/IP67 distributed I/O

AS-Interface

IP20/IP67 interfaces, cables, repeaters, accessories, addressing and adjustment terminals

Machine safety

Safety monitors and controllers on AS-Interface

Software

Software to design and install AS-Interface system, safety monitors and controllers on AS-Interface programming software

Mounting systems

Enclosures

Wall mounted enclosures
Floor standing enclosures, suite type cubicles
Industrial boxes

Equipment and accessories

Thermal control equipment
Power splitter blocks
Mounting accessories

Power supplies

Power supplies

Switch mode power supplies
Filtered rectified power supplies, transformers

AS-Interface

Power supplies

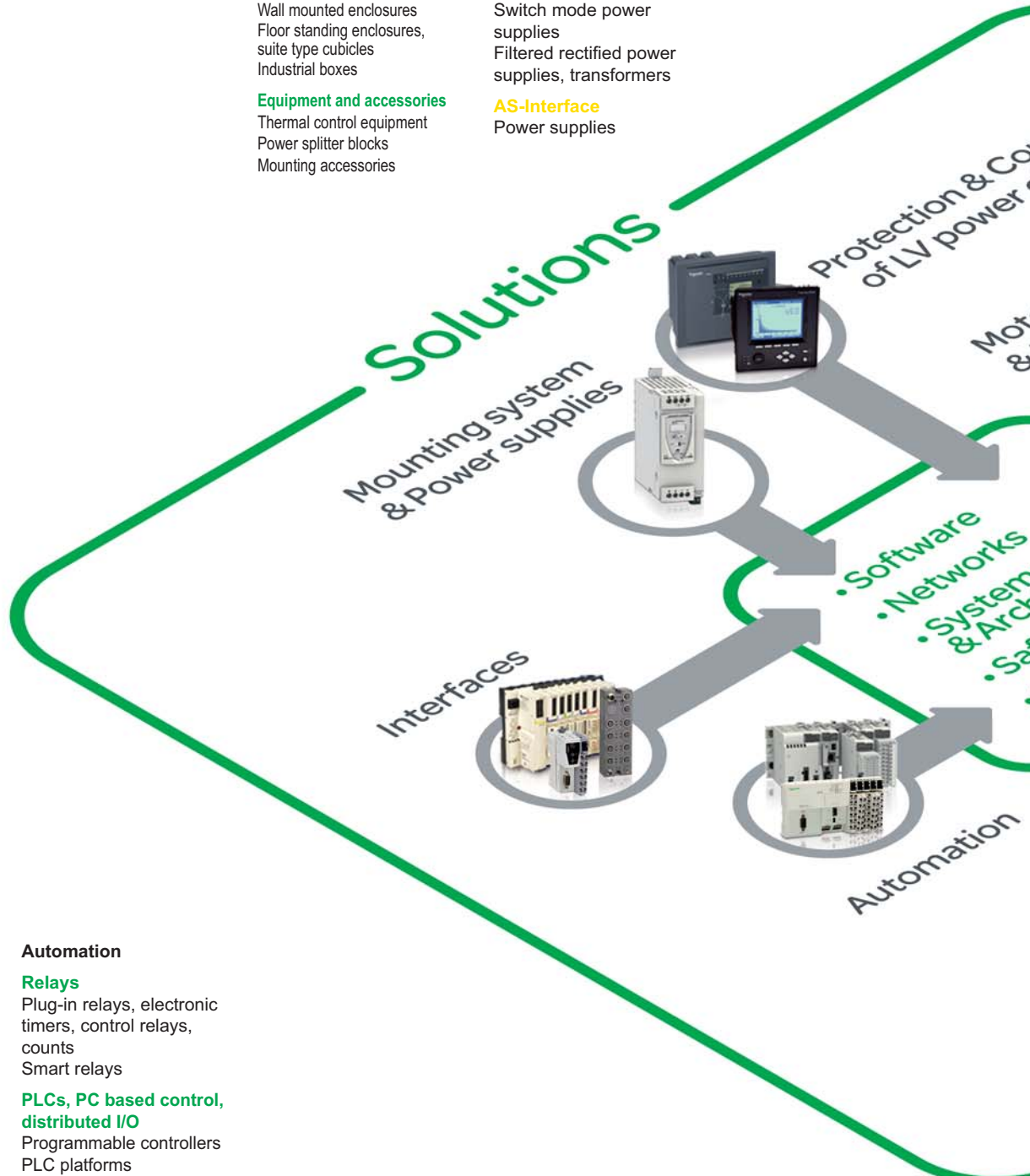

Automation

Relays

Plug-in relays, electronic timers, control relays, counts
Smart relays

PLCs, PC based control, distributed I/O

Programmable controllers
PLC platforms
PC based control
Distributed I/O, I/O controllers

AS-Interface

Master modules for Modicon PLCs

Machine safety

Safety PLCs, controllers and modules

Software

PLCs and safety controllers programming software

Systems and Architectures

Connecting Ethernet devices

Web-enabling PLCs on Ethernet

Application protocols and field buses

ation and Control functions

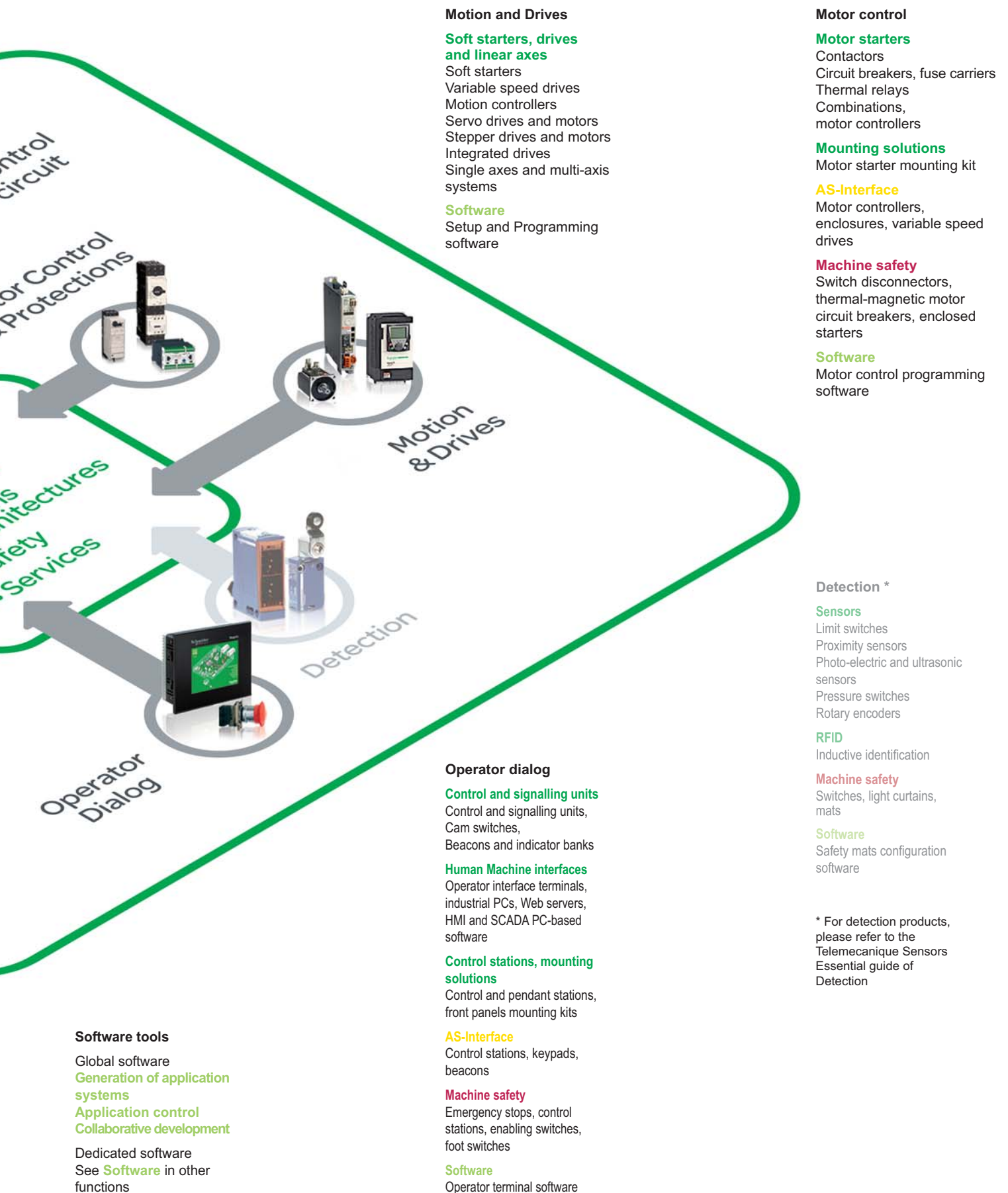

Harmony

Harmony control and signalling products are characterised by their extreme ruggedness, ergonomic design and ease of use, all of which have contributed to their successful application worldwide. The unrivalled depth of the Harmony range provides solutions to meet the diverse needs of your applications.



From the humble pushbutton to the most complex operator dialogue terminal, Schneider Electric is the world's leading supplier of human-machine interface components. Open-ended and highly innovative, the Harmony and Magelis ranges are synonymous with seamless integration and effective configuration solutions in dialogue applications.



HMI Magelis

A comprehensive, rugged, open-ended interface and industrial PC offer to meet your requirements in a wide variety of applications. With its extensive capabilities, Magelis ensures the dependability of your installations.

1 | Operator dialog



This document is a selection
of the top selling products.

For more information:
<http://www.schneider-electric.com>

Control and signalling units

Pushbuttons, switches, pilot lights and control stations

Ø 16, plastic bezel, Harmony XB6	1/2 to 1/4
Ø 8 and 12, pilot lights, Harmony XVL	1/5
Ø 22, metal bezel, Harmony XB4 / Control stations Harmony XAP	1/6 to 1/9
Ø 22, plastic bezel, Harmony XB5 / Control stations Harmony XAL	1/10 to 1/13
Ø 22, plastic bezel, wireless and batteryless, Harmony XB5R	1/14 to 1/15
Ø 22, plastic bezel - Monolithic, Harmony XB7	1/16 to 1/17
Ø 30, metal and plastic bezel, Harmony 9001K, 9001SK	1/18 to 1/20

Cam switches

Harmony K series	1/21 to 1/22
-------------------------------	--------------

Signalling solutions

Ø 40, 60, 100 mm monolithic tower lights, Harmony XVC	1/23
Ø 45 mm monolithic beacons and tower lights, accessories, Harmony XVDLS / XVC	1/24
Ø 70 mm modular tower lights (IP 66), Harmony XVB	1/25
Ø 70 mm modular tower lights (up to IP 54), Harmony XVE	1/26
Ø 45, 50 mm modular tower lights (up to IP 54), Harmony XVM / XVP	1/27
Modular tower lights accessories, Harmony XV	1/28
Ø 84, 106, 120, 130 mm rotating mirror beacons, Harmony XVR	1/29
Accessories for rotating mirror beacons, Harmony XVR	1/30
Electronic alarms and multisound sirens, Harmony XVS	1/30

Components for hoisting applications

Pendant control stations, Harmony XAC	1/31 to 1/32
--	--------------

Human Machine Interfaces

Display units, terminals, industrial PCs

Small Panels, Magelis STO/STU	1/34 to 1/35
Advanced Panels, Magelis GTO and XBT GT / GK / GH / GTW	1/36 to 1/39
HMI Controllers, Magelis XBT GC	1/40
Common accessories including USB accessories	1/41
PC BOX, Magelis BOX PC	1/42
Industrial Display, Magelis iDisplay	1/43
PC Panels, Magelis Panel PC	1/43 to 1/45

Configuration softwares

For Magelis STO/STU, GTO, XBT GT / GK / GH / GTW terminals, BOX PC and Panel PC	
Vijeo Designer	1/46
Vijeo Design'Air (remote control)	1/47

Dialog operator for Explosive atmospheres	1/48 to 1/50
--	--------------

(1):

Voltage	Letter (●)
12...24 V AC/DC (15 mA)	B
48...120 V AC (25 mA)	G
230...240 V AC (25 mA)	M



Illuminated pushbuttons

Type of head		Flush push
Shape of head		rectangular (2)
Degree of protection		IP 65 / Nema 4, 4X, 13 / Class II
Mounting (mm)	panel cut-out mounting centres	$\varnothing 16.2^{+0.2}_0$ 24 x 18 with rectangular head, 18 x 18 with square or circular head
Dimensions (mm)	W x H x D (below head)	24 x 18 x 50 with rectangular head, 18 x 18 x 50 with square or circular head
Connection (3)		Tags for 2.8 x 0.5 Faston connectors or for soldering

Type of push

		Spring return
		Complete products 12 ... 24 V AC/DC
		Products for user assembly

References	Color	Contact	Complete products	Products for user assembly	Products for user assembly	Products for user assembly
	white	NO	XB6DW1B1B	ZB6E●1B (1)	ZB6Z1B	ZB6DW1
		NO + NC	XB6DW1B5B	ZB6E●1B (1)	ZB6Z5B	ZB6DW1
	green	NO	XB6DW3B1B	ZB6E●3B (1)	ZB6Z1B	ZB6DW3
		NO + NC	XB6DW3B5B	ZB6E●3B (1)	ZB6Z5B	ZB6DW3
	red	NC	XB6DW4B2B	ZB6E●4B (1)	ZB6Z2B	ZB6DW4
		NO + NC	XB6DW4B5B	ZB6E●4B (1)	ZB6Z5B	ZB6DW4
	yellow	NO	–	ZB6E●5B (1)	ZB6Z1B	ZB6DW5
		NO + NC	XB6DW5B5B	ZB6E●5B (1)	ZB6Z5B	ZB6DW5

Type of push

			Latching			
References	white	NO	–	ZB6E●1B (1)	ZB6Z1B	ZB6DF1
		NO + NC	XB6DF1B5B	ZB6E●1B (1)	ZB6Z5B	ZB6DF1
	green	NO	XB6DF3B1B	ZB6E●3B (1)	ZB6Z1B	ZB6DF3
		NO + NC	XB6DF3B5B	ZB6E●3B (1)	ZB6Z5B	ZB6DF3
	red	NC	XB6DF4B2B	ZB6E●4B (1)	ZB6Z2B	ZB6DF4
		NO + NC	XB6DF4B5B	ZB6E●4B (1)	ZB6Z5B	ZB6DF4
	yellow	NO	–	ZB6E●5B (1)	ZB6Z1B	ZB6DF5
		NO + NC	–	ZB6E●5B (1)	ZB6Z5B	ZB6DF5



Pilot lights

Type of head		Smooth lens cap
Shape of head		rectangular (2)
		Complete products 12 ... 24 V AC/DC
		Products for user assembly

References	Color	Contact	Complete products	Products for user assembly	Products for user assembly
	white	NO	XB6DV1BB	ZB6E●1B (1)	ZB6DV1
	green	NO	XB6DV3BB	ZB6E●3B (1)	ZB6DV3
	red	NO	XB6DV4BB	ZB6E●4B (1)	ZB6DV4
	yellow	NO	XB6DV5BB	ZB6E●5B (1)	ZB6DV5
	blue	NO	–	ZB6E●6B (1)	ZB6DV6

(1) Basic reference, to be completed by the letter B, G or M indicating the required voltage. See voltage table above.

(2) For products with a square head, replace the letter **D** in the reference by the letter **C** (XB6DW1B1B becomes XB6CW1B1B).

For products with a circular head, replace the letter **D** in the reference by the letter **A** (XB6DW1B1B becomes XB6AW1B1B).

(3) Alternative connection: 1 x 0.5 pins for printed circuit boards.

Contact functions



1

Pushbuttons

Type of head		Flush push			
Shape of head		rectangular (1)			
Degree of protection		IP 65 / Nema 4, 4X, 13 / Class II			
Mounting (mm)	panel cut-out mounting centres	$\varnothing 16.2^{+0.2}_0$			
Dimensions (mm)	W x H x D (below head)	24 x 18 with rectangular head, 18 x 18 with square or circular head			
Connection (2)		24 x 18 x 50 with rectangular head, 18 x 18 x 50 with square or circular head			
Type of push		Tags for 2.8 x 0.5 Faston connectors or for soldering			
		Spring return			
		Complete products	Products for user assembly		
References	white	NO	XB6DA11B	ZB6Z1B	ZB6DA1
		NO + NC	XB6DA15B	ZB6Z5B	ZB6DA1
	black	NO	–	ZB6Z1B	ZB6DA2
		NO + NC	XB6DA25B	ZB6Z5B	ZB6DA2
	green	NO	XB6DA31B	ZB6Z2B	ZB6DA3
		NO + NC	XB6DA35B	ZB6Z5B	ZB6DA3
	red	NO	–	ZB6Z1B	ZB6DA4
		NO + NC	XB6DA45B	ZB6Z5B	ZB6DA4

(1) For products with a square head, replace the letter **D** in the reference by the letter **C** (XB6DA11B becomes XB6CA11B).

For products with a circular head, replace the letter **D** in the reference by the letter **A** (XB6DA11B becomes XB6AA11B).

(2) Alternative connection: 1 x 0.5 pins for printed circuit boards.



Ø 30 mushroom head Emergency stop pushbuttons (3)

Type of head		Trigger action (EN/ISO 13850)				
Shape of head		cylindrical				
Type of push		Turn to release				
		Complete products	Products for user assembly			
References	red	2 NC + 1 NO	XB6AS8349B	ZB6E2B	ZB6Z5B	ZB6AS834
Type of push		Key release, 200				
References	red	2 NC + 1 NO	XB6AS9349B	ZB6E2B	ZB6Z5B	ZB6AS934

(3) Emergency stop trigger action and mechanical latching pushbuttons conform to standards EN/IEC 60204-1 and EN/ISO 13850, to Machinery Directive 2006/42/EC and to standard EN/IEC 60947-5-5.

1



Selector switches and key switches

Type of head		Black handle
Shape of head		rectangular (2)
Degree of protection		IP 66 / Nema 4, 4X, 13 / Class II
Mounting (mm)	panel cut-out mounting centres	Ø 16.2 ^{+0.2} ₀
Dimensions (mm)	W x H x D (below head)	24 x 18 with rectangular head, 18 x 18 with square or circular head
Connection (3)		Tags for 2.8 x 0.5 Faston connectors or for soldering

Type of operator	Black handle		
	Complete products	Products for user assembly	
Number and type of positions	2 positions stay put	2 positions stay put	2 positions spring return to centre
References	NO XB6DD221B NO + NC XB6DD225B	ZB6Z1B ZB6DD22 ZB6Z5B ZB6DD22	ZB6Z1B ZB6DD24 ZB6Z5B ZB6DD24
Number and type of positions	3 positions stay put	3 positions stay put	3 positions spring return to centre
References	NO XB6DD235B	ZB6Z5B ZB6DD23	ZB6Z5B ZB6DD25



Type of operator	Key, n° 200		
	Complete products	Products for user assembly	
Number and type of positions	2 positions stay put	2 positions stay put	2 positions spring return to centre
References	NO + NC XB6DGC5B	ZB6Z5B ZB6DGC	ZB6Z5B ZB6DGB
Number and type of positions	3 positions stay put	3 positions stay put	3 positions spring return to centre
References	NO + NC XB6DGH5B	ZB6Z5B ZB6DGH	ZB6Z5B ZB6DGS

(1):

Voltage	Letter (●)
12...24 V AC/DC (15 mA)	B
48...120 V AC (25 mA)	G
230...240 V AC (25 mA)	M



Illuminated selector switches

Type of operator	Coloured handle		
	Products for user assembly		
Number and type of positions		2 positions stay put	3 positions stay put
References	white ● NO + NC ZB6E●1B (1) ZB6Z5B	ZB6DD02	ZB6YK1
	green ● NO + NC ZB6E●3B (1) ZB6Z5B	ZB6DD02	ZB6YK3
	red ● NO + NC ZB6E●4B (1) ZB6Z5B	ZB6DD02	ZB6YK4

(1) Basic reference, to be completed by the letter B, G or M indicating the required voltage. See voltage table above.

(2) For products with a square head, replace the letter D in the reference by the letter C (XB6DD221B becomes XB6CD221B).

For products with a circular head, replace the letter D in the reference by the letter A (XB6DD221B becomes XB6AD221B).

(3) Alternative connection: 1 x 0.5 pins for printed circuit boards.

(1):

Voltage	Number (●)
5 V (25 mA)	1
12 V (18 mA)	2
24 V (18 mA)	3
48 V (10 mA)	4



1

LED pilot lights		With black bezel		With integral lens cap	
Type of head		Protruding LED, Ø 8 mm		Covered LED, Ø 8 mm	
Degree of protection		IP 40, IP 65 with seal (2)			
Mounting (mm)	panel cut-out	Ø 8.2 mm		Ø 8.2 mm	
	mounting centres	12.5 x 12.5 mm		10.5 x 10.5 mm	
Dimensions (mm)	Ø x Depth (below head)	Ø 12 x 32		Ø 10 x 34	
				Ø 16 x 45	
Connection		Tags (3)		Threaded connectors	
References (1)	green ●	XVLA1●3		XVLA2●3	
	red ●	XVLA1●4		XVLA2●4	
	yellow ●	XVLA1●5		XVLA2●5	
Tightening key		For Ø 8 mm pilot lights		For Ø 12 mm pilot lights	
References		XVLX08		XVLX12	

(1) Basic reference, to be completed by the number 1, 2, 3 or 4 indicating the required voltage. See voltage table above.

(2) For an IP 65 degree of protection, include the seals: XVLZ911 for pilot lights XVLA1●● and XVLA2●●; XVLZ912 for pilot lights XVLA3●●.

(3) Tags for 2.8 x 0.5 Faston connectors or for soldering.

Sub-assemblies & accessories for Ø 16 plastic bezel control and signalling units

















Sub-assemblies		Bodies for pushbuttons and selector switches			Bodies for pilot lights				
Rated operational characteristics, AC-15: Ue = 240 V and Ie = 1.5 A or Ue = 120 V and Ie = 3 A					Consumption				
Positive operation of contacts conforming to IEC/EN 60947-5-1: NC contacts with positive opening operation, positive opening force 20 N					15 mA	12...24 V AC/DC			
					25 mA	48...120 V AC			
					25 mA	230...240 V AC			
		Type of contact	Fixing collar + contacts	Contacts	Pilot light bodies	12 ... 24 V	48 ... 120 V	230 ... 240 V	
References		NO	ZB6Z1B	ZB6E1B	White ●	ZB6EB1B	ZB6EG1B	ZB6EM1B	
		NC	ZB6Z2B	ZB6E2B	Green ●	ZB6EB3B	ZB6EG3B	ZB6EM3B	
		2 NO	ZB6Z3B	–	Red ●	ZB6EB4B	ZB6EG4B	ZB6EM4B	
		2 NC	ZB6Z4B	–	Yellow ●	ZB6EB5B	ZB6EG5B	ZB6EM5B	
		NO + NC	ZB6Z5B	–	Blue ●	ZB6EB6B	ZB6EG6B	ZB6EM6B	
Accessories									
Legend holders		24 x 28 mm (8 x 21 mm legend)			24 x 36 mm (16 x 21 mm legend)				
Blank legend	Background colour	without legend	yellow or white	black or red	without legend	yellow or white	black or red		
References (10)*		ZB6YD20	ZB6YD21	ZB6YD22	ZB6YD30	ZB6YD31	ZB6YD32		
Blank legends for legend holders		8 x 21 mm (24 x 28 mm legend holder)			16 x 21 mm (24 x 36 mm legend holder)				
	Background colour	–	yellow or white	black or red	–	yellow or white	black or red		
References (20)*		–	ZB6Y1001	ZB6Y2001	–	ZB6Y4001	ZB6Y3001		
Ø 45 mm yellow legend for mushroom head Emergency stop pushbutton									
	Marking	Blank, for engraving		EMERGENCY STOP	ARRET D'URGENCE				
References		ZB6Y7001		ZB6Y7330	ZB6Y7130				
	Body/fixing collar	Plate		Tightening tool	Dismantling tool				
		anti-rotation		and slackening, for fixing nut	for removal of contact blocks				
References	ZB6Y009 (10)*	ZB6Y003 (10)*		ZB6Y905 (2)*	ZB6Y018 (5)*				
Protective shutter for pushbuttons and switches				Connector			Blanking plug		
	for rectangular heads	for circular and square heads		Faston, female	IP 65				
References	ZB6YD001	ZB6YA001		ZB6Y004 (100)*	ZB6Y005 (10)*				

* sold in lots of

1





Pushbuttons, spring return

Type of head			Chromium plated circular bezel					
Degree of protection			IP 66 / Nema 4X, 13 / Class I					
Mounting (mm)		panel cut-out	Ø 22.5 (22.4 ^{+0.4} ₀ recommended)					
		mounting centres	30 (horizontal) x 40 (vertical)					
Depth (mm)		below head	43					
Connection (1)			Screw clamp terminals					
Type of push			Flush			Flush, booted		
Unmarked		Products	Complete	For user assembly		Complete	For user assembly	
								
References	black ● NO	XB4BA21	ZB4BZ101	ZB4BA2	XB4BP21	ZB4BZ101	ZB4BP2	
	green ● NO	XB4BA31	ZB4BZ101	ZB4BA3	XB4BP31	ZB4BZ101	ZB4BP3	
	red ● NC	XB4BA42	ZB4BZ102	ZB4BA4	XB4BP42	ZB4BZ102	ZB4BP4	
	yellow ● NO	XB4BA51	ZB4BZ101	ZB4BA5	XB4BP51	ZB4BZ101	ZB4BP5	
	blue ● NO	XB4BA61	ZB4BZ101	ZB4BA6	XB4BP61	ZB4BZ101	ZB4BP6	
Type of push			Flush					
With international marking		Products	Complete	For user assembly				
								
References	green ⓘ NO	XB4BA3311	ZB4BZ101	ZB4BA331	–	–	–	
	red ⓘ NC	XB4BA4322	ZB4BZ102	ZB4BA432	–	–	–	
	white ⓘ NO	XB4BA3341	ZB4BZ101	ZB4BA334	–	–	–	
	black ⓘ NO	XB4BA3351	ZB4BZ101	ZB4BA335	–	–	–	
Type of push			Projecting			Mushroom head, Ø 40 mm		
Unmarked		Products	Complete	For user assembly		Complete	For user assembly	
								
References	black ● NO	–	–	–	XB4BC21	ZB4BZ101	ZB4BC2	
	red ● NC	XB4BL42	ZB4BZ102	ZB4BL4	–	–	–	
Type of push			Double-headed pushbuttons			Triple-headed pushbuttons		
Degree of protection			IP 66 - IP 69K			IP 66 - IP 69K		
With international marking		Products	Complete	For user assembly		Complete	For user assembly	
			(A) 			(B) 		
References	(A) NO + NC	XB4BL73415	ZB4BZ105	ZB4BL7341	–	–	–	
	(B) NO + NC + NO	–	–	–	XB4BA711237	ZB4BZ103 + ZBE102	ZB4BA71123	

(1) Alternative connections: plug-in connector, Faston connectors (6.35 and 2 x 2.8).



Ø 40 mm mushroom head Emergency stop pushbuttons (2)

		Trigger action (EN/ISO 13850)					
Type of push		Push-pull NO + NC					
Unmarked		Products	Complete	For user assembly			
							
References	red ● NO + NC	XB4BT845	ZB4BZ105	ZB4BT84			
Type of push		Turn to release NO + NC					
References	red ● NO + NC	XB4BS8445	ZB4BZ105	ZB4BS844			
Type of push		Key release NO + NC					
References	red ● NO + NC	XB4BS9445	ZB4BZ105	ZB4BS944			

(2) Emergency stop trigger action and mechanical latching pushbuttons conform to standards EN/IEC 60204-1 and EN/ISO 13850, to Machinery Directive 2006/42/EC and to standard EN/IEC 60947-5-5.

Contact functions



1

Selector switches and key switches

Type of head	Chromium plated circular bezel	
Degree of protection	IP 66 / Nema 4X, 13 / Class I	
Mounting (mm)	panel cut-out	Ø 22.5 (22.4 ^{+0.4} ₀ recommended)
	mounting centres	30 (horizontal) x 40 (vertical)
Depth (mm)	below head	43
Connection (1)	Screw clamp terminals	
Type of operator	Handle	

Products		Complete	For user assembly	Complete	For user assembly
Number and type of positions		2 positions stay put	2 positions stay put	2 positions spring return to left	2 positions spring return to left
References	black ● NO	XB4BD21	ZB4BZ101 ZB4BD2	XB4BD41	ZB4BZ101 ZB4BD4
Number and type of positions		3 positions stay put	3 positions stay put	3 positions spring return to centre	3 positions spring return to centre
References	black ● NO + NO	XB4BD33	ZB4BZ103 ZB4BD3	XB4BD53	ZB4BZ103 ZB4BD5



Products		Key, n° 455			
		Complete	For user assembly	Complete	For user assembly
Number and type of positions (2)		2 positions stay put	2 positions stay put	2 positions stay put	2 positions stay put
References	black ● NO	XB4BG21	ZB4BZ101 ZB4BG2	XB4BG41	ZB4BZ101 ZB4BG4
Number and type of positions		2 positions spring return to left	2 positions spring return to left	3 positions stay put	3 positions stay put
References	black ● NO	XB4BG61	ZB4BZ101 ZB4BG6	-	-
	black ● NO + NO	-	-	XB4BG33	ZB4BZ103 ZB4BG3

1



Pilot lights

Type of head		Circular bezel					
Degree of protection		Smooth lens cap					
Mounting (mm)	panel cut-out	IP 66 / Nema 4X, 13 / Class I					
	mounting centres	Ø 22.5 (22.4 ^{+0.4} ₀ recommended)					
Depth	below head	30 (horizontal) x 40 (vertical)					
Connection (1)		43					
Light source		Screw clamp terminals			Integral LED		
		Direct supply for BA 9s bulb (not included)					
	Products	Complete			Complete	For user assembly	
Supply voltage		24 V AC/DC	110...120 V AC	230...240 V AC	250 V max., 2.4 W max.		
References	white	XB4BVB1	XB4BVG1	XB4BVM1	XB4BV61	ZB4BV6	ZB4BV01
	green	XB4BVB3	XB4BVG3	XB4BVM3	XB4BV63	ZB4BV6	ZB4BV03
	red	XB4BVB4	XB4BVG4	XB4BVM4	XB4BV64	ZB4BV6	ZB4BV04
	yellow	XB4BVB5	XB4BVG5	XB4BVM5	XB4BV65	ZB4BV6	ZB4BV05
	blue	XB4BVB6	XB4BVG6	XB4BVM6	–	–	–



Illuminated pushbuttons and selector switches

Type	Flush push, spring return, illuminated pushbuttons						
Light source		Integral LED			Direct supply for BA 9s bulb (not included)		
	Products	Complete			Complete	For user assembly	
Supply voltage		24 V AC/DC	110...120 V AC	230...240 V AC	250 V max., 2.4 W max.		
References	white NO + NC	XB4BW31B5	XB4BW31G5	XB4BW31M5	XB4BW3165	ZB4BW065	ZB4BW31
	green NO + NC	XB4BW33B5	XB4BW33G5	XB4BW33M5	XB4BW3365	ZB4BW065	ZB4BW33
	red NO + NC	XB4BW34B5	XB4BW34G5	XB4BW34M5	XB4BW3465	ZB4BW065	ZB4BW34
	orange NO + NC	XB4BW35B5	XB4BW35G5	XB4BW35M5	XB4BW3565	ZB4BW065	ZB4BW35
	blue NO + NC	XB4BW36B5	XB4BW36G5	XB4BW36M5	–	–	–



Type	Double-headed pushbuttons with LED pilot light (1 flush green push, 1 projecting red push)			Illuminated selector switches (2 position stay put)			
Degree of protection	IP 66 - IP 69K			IP 66			
Light source	Integral LED			Integral LED			
	Products	Complete			Complete		
Supply voltage		24 V AC/DC	110...120 V AC	230...240 V AC	24 V AC/DC	110...120 V AC	230...240 V AC
References	green NO + NC	–	–	–	XB4BK123B5	XB4BK123G5	XB4BK123M5
	red NO + NC	–	–	–	XB4BK124B5	XB4BK124G5	XB4BK124M5
	orange NO + NC	–	–	–	XB4BK125B5	XB4BK125G5	XB4BK125M5
	White NO + NC	XB4BW73731B5	XB4BW73731G5	XB4BW73731M5	–	–	–

(1) Alternative connections: plug-in connector, Faston connectors (6.35 and 2 x 2.8), spring clamp terminal.

Separate components and accessories

1



Electrical blocks (1) (2)

Single contact blocks			Light blocks with integral LED				Light block, direct supply
Rated operational characteristics	AC-15, 240 V - 3 A		Consumption				
Positive operation of contacts conforming to IEC/EN 60947-5-1	NC contacts with positive opening operation		18 mA	24 V AC/DC			
			14 mA	120 V AC			
References (5)*	Screw clamp terminal	Spring clamp terminal	To combine with heads for integral LED				For BA 9s bulb (not included) 250 V max., 2.4 W max.
	NC	ZBE101	ZBE1015	white	ZBVB1	ZBVG1	
	NO	ZBE102	ZBE1025	green	ZBVB3	ZBVG3	ZBVM3
			red	ZBVB4	ZBVG4	ZBVM4	Colour provided by lens
			orange	ZBVB5	ZBVG5	ZBVM5	
			blue	ZBVB6	ZBVG6	ZBVM6	



Diecast metal enclosures

(Zinc alloy, usable depth 49 mm)

	Front face dimensions	1 vertical row				2 vertical rows		
		1	2	3	4	2	4	6
Number of cut-outs	80 x 80 mm	XAPM1201	–	–	–	XAPM1202	–	–
References	80 x 130 mm	–	XAPM2202	XAPM2203	–	–	XAPM2204	–
	80 x 175 mm	–	–	XAPM3203	XAPM3204	–	–	XAPM3206

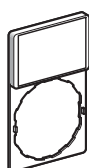
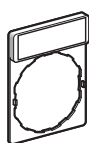

Accessories (2)

Legend holders, 30 x 40 mm, for 8 x 27 mm legends

Marking	Background colour: black or red						white or yellow		
References (10)*	Blank	ZBY2101						ZBY4101	
	International	0 (red background)	ZBY2931	I	ZBY2147	AUTO	ZBY2115	STOP	ZBY2304
	English	OFF	ZBY2312	ON	ZBY2311	START	ZBY2303	–	–
	French	ARRET (red b/grnd)	ZBY2104	ARRET-MARCHE	ZBY2166	MARCHE	ZBY2103	–	–
	German	AUS	ZBY2204	AUS-EIN	ZBY2266	EIN	ZBY2203	–	–
	Spanish	PARADA (red b/grnd)	ZBY2404	PARADA-MARCHA	ZBY2466	MARCHA	ZBY2403	–	–

Legend holders, 30 x 50 mm, for 18 x 27 mm legends

Background colour	black or red						white or yellow		
References (10)*	Blank	ZBY6101						ZBY6102	

Ø 60 mm legend for mushroom head Emergency stop pushbutton

Background colour	yellow				
Marking	Blank	EMERGENCY STOP	ARRET D'URGENCE	NOT HALT	PARADA DE EMERGENCIA
References	ZBY9140	ZBY9330	ZBY9130	ZBY9230	ZBY9430

(1) Alternative connections: plug-in connector, Faston connectors (6.35 and 2 x 2.8), spring clamp terminal.

(2) Electrical blocks and accessories also for use with Harmony XB5 plastic range

* sold in lots of

1



Pushbuttons, spring return

Type of head		Circular bezel							
Degree of protection		IP 66 / Nema 4X, 13 / Class II							
Mounting (mm)		panel cut-out mounting centres Ø 22.5 (22.4 ^{+0.4} ₀ recommended)							
Depth (mm)		30 (horizontal) x 40 (vertical)							
Connection (1)		43 Screw clamp terminals							
Type of push		Flush			Flush, booted				
Unmarked		Products		Complete	For user assembly		Complete	For user assembly	
References		black ● NO	XB5AA21	ZB5AZ101	ZB5AA2	XB5AP21	ZB5AZ101	ZB5AP2	
		green ● NO	XB5AA31	ZB5AZ101	ZB5AA3	XB5AP31	ZB5AZ101	ZB5AP3	
		red ● NC	XB5AA42	ZB5AZ102	ZB5AA4	XB5AP42	ZB5AZ102	ZB5AP4	
		yellow ● NO	XB5AA51	ZB5AZ101	ZB5AA5	XB5AP51	ZB5AZ101	ZB5AP5	
		blue ● NO	XB5AA61	ZB5AZ101	ZB5AA6	XB5AP61	ZB5AZ101	ZB5AP6	
Type of push		Flush							
With international marking		Products		Complete	For user assembly		Complete	For user assembly	
References		green ⓘ NO	XB5AA3311	ZB5AZ101	ZB5AA331	–	–	–	
		red ⓘ NC	XB5AA4322	ZB5AZ102	ZB5AA432	–	–	–	
		white ⓘ NO	XB5AA3341	ZB5AZ101	ZB5AA334	–	–	–	
		black ⓘ NO	XB5AA3351	ZB5AZ101	ZB5AA335	–	–	–	
Type of push		Projecting			Mushroom head, Ø 40 mm				
Unmarked		Products		Complete	For user assembly		Complete	For user assembly	
References		black ● NO	–	–	–	XB5AC21	ZB5AZ101	ZB5AC2	
		red ● NC	XB5AL42	ZB5AZ102	ZB5AL4	–	–	–	
Type of push		Double-headed pushbuttons			Triple-headed pushbuttons				
Degree of protection		IP 66 - IP 69K			IP 66 - IP 69K				
With international marking		Products		Complete	For user assembly		Complete	For user assembly	
References		(A) NO + NC	XB5AL73415	ZB5AZ105	ZB5AL7341	–	–	–	
		(B) NO + NC + NO	–	–	–	XB5AA711237	ZB5AZ103 + ZBE102	ZB5AA71123	

(1) Alternative connections: plug-in connector, Faston connectors (6.35 and 2 x 2.8).



Ø 40 mm mushroom head Emergency stop pushbuttons (2)

Type of push		Trigger action (EN/ISO 13850)							
Unmarked		Products		Complete	For user assembly		Complete	For user assembly	
References		red ● NO + NC	XB5AT845	ZB5AZ105	ZB5AT84	–	–	–	
Type of push		Turn to release NO + NC							
References		red ● NO + NC	XB5AS8445	ZB5AZ105	ZB5AS844	–	–	–	
Type of push		Key release NO + NC							
References		red ● NO + NC	XB5AS9445	ZB5AZ105	ZB5AS944	–	–	–	

(2) Emergency stop trigger action and mechanical latching pushbuttons conform to standards EN/IEC 60204-1 and EN/ISO 13850: to Machinery Directive 2006/42/EC and to standard EN/IEC 60947-5-5.

Contact functions



1

Selector switches and key switches

Type of head		Circular bezel			
Degree of protection		IP 66 / Nema 4X, 13 / Class II			
Mounting (mm)		Ø 22.5 (22.4 ^{+0.4} ₀ recommended)			
Depth (mm)		30 (horizontal) x 40 (vertical)			
Connection (1)		Screw clamp terminals			
Type of operator		Handle			
Products		Complete	For user assembly	Complete	For user assembly
Number and type of positions		2 positions stay put	2 positions stay put	2 positions spring return to left	2 positions spring return to left
References	black ● NO	XB5AD21	ZB5AZ101 ZB5AD2	XB5AD41	ZB5AZ101 ZB5AD4
Number and type of positions		3 positions stay put	3 positions stay put	3 positions spring return to centre	3 positions spring return to centre
References	black ● NO + NO	XB5AD33	ZB5AZ103 ZB5AD3	XB5AD53	ZB5AZ103 ZB5AD5
Type of operator		Key, n° 455			
Number and type of positions (2)		2 positions stay put	2 positions stay put	2 positions stay put	2 positions stay put
References	black ● NO	XB5AG21	ZB5AZ101 ZB5AG2	XB5AG41	ZB5AZ101 ZB5AG4

(2) The symbol  indicates key withdrawal position.

1



Pilot lights

Type of head		Circular bezel Smooth lens cap					
Degree of protection		IP 66 / Nema 4X, 13 / Class II					
Mounting (mm)	panel cut-out	Ø 22.5 (22.4 ^{+0.4} ₀ recommended)					
	mounting centres	30 (horizontal) x 40 (vertical)					
Depth	below head	43					
Connection (1)		Screw clamp terminals					
Light source		Integral LED			Direct supply for BA 9s bulb (not included)		
	Products	Complete			Complete	For user assembly	
Supply voltage		24 V AC/DC	110...120 V AC	230...240 V AC	250 V max., 2.4 W max.		
References	white	XB5AVB1	XB5AVG1	XB5AVM1	XB5AV61	ZB5AV6	ZB5AV01
	green	XB5AVB3	XB5AVG3	XB5AVM3	XB5AV63	ZB5AV6	ZB5AV03
	red	XB5AVB4	XB5AVG4	XB5AVM4	XB5AV64	ZB5AV6	ZB5AV04
	orange	XB5AVB5	XB5AVG5	XB5AVM5	XB5AV65	ZB5AV6	ZB5AV05
	blue	XB5AVB6	XB5AVG6	XB5AVM6	–	–	–



Illuminated pushbuttons and selector switches

Type	Flush push, spring return, illuminated pushbuttons						
Light source		Integral LED			Direct supply for BA 9s bulb (not included)		
	Products	Complete			Complete	For user assembly	
Supply voltage		24 V AC/DC	110...120 V AC	230...240 V AC	250 V max., 2.4 W max.		
References	white NO + NC	XB5AW31B5	XB5AW31G5	XB5AW31M5	XB5AW3165	ZB5AW065	ZB5AW31
	green NO + NC	XB5AW33B5	XB5AW33G5	XB5AW33M5	XB5AW3365	ZB5AW065	ZB5AW33
	red NO + NC	XB5AW34B5	XB5AW34G5	XB5AW34M5	XB5AW3465	ZB5AW065	ZB5AW34
	orange NO + NC	XB5AW35B5	XB5AW35G5	XB5AW35M5	XB5AW3565	ZB5AW065	ZB5AW35
	blue NO + NC	XB5AW36B5	XB5AW36G5	XB5AW36M5	–	–	–



Type	Double-headed pushbuttons with LED pilot light (1 flush green push, 1 projecting red push)			Illuminated selector switches (2 position stay put)		
Degree of protection	IP 66 - IP 69K			IP 66		
Light source		Integral LED			Integral LED	
	Products	Complete			Complete	
Supply voltage		24 V AC/DC	110...120 V AC	230...240 V AC	24 V AC/DC	110...120 V AC 230...240 V AC
References	green NO + NC	–	–	–	XB5AK123B5	XB5AK123G5 XB5AK123M5
	red NO + NC	–	–	–	XB5AK124B5	XB5AK124G5 XB5AK124M5
	orange NO + NC	–	–	–	XB5AK125B5	XB5AK125G5 XB5AK125M5
	white NO + NC	XB5AW73731B5	XB5AW73731G5	XB5AW73731M5	–	–

(1) Alternative connections: plug-in connector, Faston connectors (6.35 and 2 x 2.8), spring clamp terminal.

Separate components and accessories: see page 1/9.

(1):

Number of cut-outs	Number (●)
1	1
2	2
3	3
4	4
5	5



Complete stations with 1 pushbutton, selector switch or key switch

(light grey RAL 7035 base with dark grey RAL 7016 lid)

Degree of protection			IP 65 / Nema 4X and 13 / Class II				
Dimensions (mm)			W x H x D				
Fixing (mm)			2 x Ø 4.3 on 54 mm centres				
Function			1 Start or Stop function			1 Start-Stop function	
Marking			On spring return push			On legend holder and legend below head	
Number and type of pushbutton/selector switch/key switch			1 flush green p/b	1 flush red p/b	1 projecting red p/b	1 2 position stay put selector switch or key switch	
References			NO	I	O - I	O	Key n° 455 (key withdrawal LH pos.)
			XALD102	–	–	–	–
		Start	XALD103	–	–	–	–
			–	–	–	XALD134	XALD144
			–	XALD112	XALD115	–	–

(1) Empty enclosures:

Basic reference: **XALK0●**, replace the ● by the number of cut-outs required (see cut-out table above)



Function			Emergency stop (2) (light grey RAL 7035 base with yellow RAL 1012 lid)			
Number and type of mushroom head pushbutton			1 red Ø 40 head, turn to release		1 red Ø 40 head, key release	
Latching mechanism			Trigger action (EN/ISO 13850)		Trigger action (EN/ISO 13850)	
References			NC	NC + NC	NO + NC	NC + NC + NO
			XALK178	XALK178F	XALK178E	XALK178G
					XALK188	XALK188F
					XALK188E	XALK188G

(2) Emergency stop trigger action and mechanical latching pushbuttons conform to standards EN/IEC 60204-1 and EN/ISO 13850, to Machinery Directive 2006/42/EC and to standard EN/IEC 60947-5-5.



(1) Empty enclosures:

Basic reference: **XALD0●**, replace the ● by the number of cut-outs required (see cut-out table above)

Complete stations with 2 and 3 pushbuttons or 2 pushbuttons + 1 pilot light

(light grey RAL 7035 base with dark grey RAL 7016 lid)

Dimensions (mm)			2-way control stations: 68 x 106 x 62; 3-way control stations: 68 x 136 x 87										
Fixing (mm)			2-way control stations: 2 x Ø 4.3 on 54 x 68 centres; 3-way control stations: 2 x Ø 4.3 on 54 x 98 centres										
Function			Start-Stop functions			2 functions		3 functions					
Marking			On spring return push										
Number and type of pushbutton/pilot light			1 flush green p/b	1 flush green pushbutton	1 flush red p/b	1 flush red pushbutton	1 red pilot light with integral LED	1 flush white p/b	1 flush black p/b	1 flush white p/b	1 flush red p/b	1 Ø 30 red mushroom head p/b	1 flush black p/b
References			NO + NC	I - O	Start - Stop	NO + NO	NO + NC + NO						
			XALD213	XALD363B	XALD363M	–	–	–	–	–	–	–	
			XALD215	–	–	–	–	XALD222	–	–	–	–	
			–	–	–	–	–	–	XALD324	XALD328	–	–	

Accessories		Standard contact blocks			Light blocks with integral LED, colour red	
Description		NO contact	NC contact		24 V AC/DC	230 V AC
References		ZENL111	ZENL121		ZALVB4	ZALVM4

1



Ready to use packs	Panel mounting				Mobile application	
Wireless and batteryless 22mm pushbutton assembled on fixing collar	Plastic head	Metal head	Plastic head	Metal head	Plastic head in handy box	
Caps	1 black cap		1 set of 10 different coloured caps		1 black cap	1 set of 10 different coloured caps
Receiver	Non configurable		Configurable functions: monostable, bistable, stop/start		Non configurable	Configurable functions: monostable, bistable, stop/start
Relay output	1relay output type RT 3A		2 relays output type RT 3A		1relay output type RT 3A	2 relays output type RT 3A
Voltage receiver	24 VDC		24...240 AC/DC		24 VDC	24...240 AC/DC
References	XB5RFB01	XB4RFB01	XB5RFA02	XB4RFA02	XB5RMB03	XB5RMA04

The pushbutton and receiver are factory paired



Transmitter components for wireless and batteryless pushbuttons			Plastic mushroom head	Plastic head	Metal head
Wireless and batteryless pushbuttons including			- a transmitter fitted with fixing collar - a spring return pushbutton head with clipped-in cap		
Reference	Cap colour	White	–	ZB5RTA1	ZB4RTA1
		Black	–	ZB5RTA2	ZB4RTA2
		Green	–	ZB5RTA3	ZB4RTA3
		White I on green background	–	ZB5RTA331	ZB4RTA331
		Red	–	ZB5RTA4	ZB4RTA4
		White O on red background	–	ZB5RTA432	ZB4RTA432
		Yellow	–	ZB5RTA5	ZB4RTA5
		Blue	–	ZB5RTA6	ZB4RTA6
		Black	ZB5RTC2	–	–



Transmitter components for wireless and batteryless rope pull switch	Rope pull switch with wireless and batteryless transmitter
Reference	ZBRP1

Components and accessories



1

Configurable receivers

Description	- 2 buttons (learn, parameter setting) - 6 indicating LEDs (power ON, outputs, signal strength)		
Output function	Monostable	Monostable, bistable	Monostable, bistable, stop/start
Output type	4 PNP outputs 200 mA / 24V	2 relay outputs type RT 3A	
Receiver voltage	24 VDC	24...240 AC/DC	
References	ZBRRC	ZBRRD	ZBRRA



Configurable access point (1)

Description	- 7-segment display - jog dial - 8 indicating LEDs (power ON, functions mode, communication status, signal strength) - external antenna connector and protective plug		
Output function	Monostable		
Output type	2 RS485 for Modbus RS485 serial line	1 slot for communication module ZBRCETH	
Receiver voltage	24...240 AC/DC		
References	ZBRN2	ZBRN1	

(1) Available 1st quarter 2013.













Complementary accessories	Relay antennas		Communication module	Plastic empty boxes		
Description	1 power-ON LED 2 LEDs reception / transmission	1 RF connector	Modbus/TCP protocol 2 RJ45 connectors	Handy, 1 cut-out	1 cut-out	2 cut-outs
Cable length	5m	2m				
Voltage	24...240 AC/DC					
Reference	ZBRA1	ZBRA2 (1)	ZBRCETH (1)	ZBRM01	XALD01	XALD02

(1) Available 1st quarter 2013.

1







Pushbuttons

Type of head		Flush or projecting push	circular	
Degree of protection			IP 65, class II, NEMA type 3 and 12	
Mounting (mm)	panel cut-out mounting centres		Ø 22.4 (0 +0.1) 30 (horizontal) x 40 (vertical)	
Dimensions (mm)	Ø x Depth (below head)		Ø 29 x 41.5 (Ø 40 x 41.5 for Emergency stop)	
Connection			Screw clamp terminals, 1 x 0.34 mm ² to 1 x 1.5 mm ²	
Type of push		Flush, spring return	Flush, push and latching	
References (10)*	white 	NO	XB7NA11	–
		NO + NC	XB7NA15	–
	black 	NO	XB7NA21	XB7NH21
		NO + NC	XB7NA25	XB7NH25
	green 	NO	XB7NA31	XB7NH31
		NO + NC	XB7NA35	XB7NH35
	red 	NC	XB7NA42	–
		NO + NC	XB7NA45	–
	yellow 	NO	XB7NA81	–
	Type of push		Flush, spring return	Projecting, spring return
References	green 	NO	XB7NA3131	–
	red 	NC	–	XB7NL4232
	white 	NO	XB7NA11341	–
	black 	NO	XB7NA21341	–
		NO + NC	XB7NA25341	–



Selector switches and key switches

Type of operator		Black handle		Key, n° 455	
Number and type of positions		2 positions stay put 	3 positions stay put 	2 positions stay put 	3 positions stay put 
References (10)*	NO	XB7ND21	–	XB7NG21	–
	NO + NC	XB7ND25	–	–	–
	2 NO	–	XB7ND33	–	XB7NG33



Ø 40mm Emergency Stop trigger action and mechanical latching pushbuttons (EN/ISO 13850, UL) (1)

Type of push		Turn to release	Push, Pull	Key release (n° 455)
References*	red NC	XB7 NS8442	XB7 NT842	–
	red NO + NC	XB7 NS8445	XB7 NT845	XB7 NS9445
	red 2NC	XB7 NS8444	XB7 NT844	XB7 NS9444

(1) Emergency stop trigger action and mechanical latching pushbuttons conform to standards EN/IEC 60204-1 and EN/ISO 13850, to Machinery Directive 2006/42/EC and to standard EN/IEC 60947-5-5. Please consult your Customer Care Centre for a full explanation of these standards and directives.

* Sold in lots of 10.

Contact functions and light functions

(1):

Supply voltage for integral LED light source only	Letter (●)
24 V AC/DC	B
120 V AC	G
230 V AC	M



Illuminated pushbuttons

Type of head		Projecting push	
		circular	
Degree of protection		IP 65, class II, NEMA type 12	
Mounting (mm)		Ø 22.4 (0 +0.1)	
panel cut-out mounting centres		30 (horizontal) x 40 (vertical)	
Dimensions (mm)		Ø 29 x 41.5, (Ø 40 x 41.5 for Emergency stop)	
Connection		Screw clamp terminals, 1 x 0.34 mm ² to 1 x 1.5 mm ²	
Light source		Integral LED	BA 9s base fitting Incandescent bulb direct supply (bulb not included)
Type of push		Spring return	
References (10)*	green ● NO	XB7NW33●1 (1)	XB7NW3361
	red ● NO	XB7NW34●1 (1)	XB7NW3461
	● NC	XB7NW34●2 (1)	–
	orange ● NO	XB7NW35●1 (1)	–
	blue ● NO	XB7NW36●1 (1)	–
	clear ● NO	XB7NW37●1 (1)	–
	yellow ● NO	XB7NW38●1 (1)	XB7NW3561
Type of push		Push and latching	
References (10)*	green ● NO	XB7NH03●1 (1)	XB7NH0361
	red ● NO	XB7NH04●1 (1)	XB7NH0461
	● NC	XB7NH04●2 (1)	–
	yellow ● NO	XB7NH08●1 (1)	XB7NH0861



Pilot lights (2)

Light source		Integral LED	Ba 9s base fitting incandescent bulb direct supply (bulb not included)	Incandescent bulb direct through resistor (bulb included)
Supply voltage		24VAC/DC or 120VAC or 230...240VAC	6 or 24 V DC, or 130 V AC	230 V AC
References (10)*	clear ●	XB7EV07●P (1)	XB7EV67P	XB7EV77P
	green ●	XB7EV03●P (1)	XB7EV63P	XB7EV73P
	red ●	XB7EV04●P (1)	XB7EV64P	XB7EV74P
	yellow ●	XB7EV05●P (1)	XB7EV65P	XB7EV75P
	blue ●	XB7EV06●P (1)	XB7EV66P	XB7EV76P
	orange ●	XB7EV08●P (1)	XB7EV68P	XB7EV78P

Incandescent bulbs, long life

BA 9s base fitting, Ø 11 mm max., length 28 mm max.

References	6 V (1.2 W)	24 V (2 W)	130 V (2.4 W)
	DL1CB006	DL1CE024	DL1CE130

(1) Basic reference, to be completed by the letter B, G or M indicating the required voltage. See voltage table above.

(2) Alternative connection: 1 x 6.35 and 2 x 2.8 mm Faston connectors.

* sold in lots of 10

1



Pushbuttons, spring return

Type of push		Flush	Projecting	Projecting (high guard)
Colour of push		Multi-colour (set of 7 clip-in coloured caps)		
Degree of protection		IP 66 / Nema 1, 2, 3, 3R, 4, 6, 12 and 13 / Class II		
Mounting (mm)	panel cut-out mounting centres	Ø 31		
Depth below head (mm)		57.2 x 44.5 (with legend 9001KN2●●), 57.2 x 50.8 (with legend 9001KN3●●)		
Connection		Screw clamp terminals		
References	CO	9001KR1UH13	9001KR3UH13	9001KR2UH13
	NO	9001KR1UH5	9001KR3UH5	9001KR2UH5



Mushroom head pushbuttons, latching (1)

Type of push		Push-pull	Emergency switching off	Emergency stop
Degree of protection		Ø 41 mushroom head Ø 35 mushroom head	Ø 35 mushroom head	Ø 40 red mushroom head
Degree of protection		IP 66 / Nema 1, 2, 3, 3R, 4, 6, 12 and 13 / Class II		IP 66 / Nema 1, 2, 3, 3R, 4, 6, 12 and 13 / Class III
Mounting (mm)	panel cut-out mounting centres	Ø 31		
Depth below head (mm)		57.2 x 44.5 (with legend 9001KN2●●), 57.2 x 50.8 (with legend 9001KN3●●)		57,2 x 44,5 (without legend plate), 100 x 100 ((with legend plate 9001KN8330) (2))
Connection		Screw clamp terminals		
References		–	–	9001KR16
	CO	9001KR9R94H13	9001KR9R20H13	–
	NC	9001KR9RH6	9001KR9R20H6	–
	2NO + 2NC	–	–	9001KR16H2
	NO	–	–	9001KR16H13

(1) Mushroom head switching off mechanical latching pushbuttons conform to standard IEC 60364-5-53 and EN/IEC 60947-5-5. Mushroom head Emergency stop trigger action and mechanical latching pushbuttons conforming to standard EN/IEC 60204-1 and EN/ISO 13850, to Machinery directive 2006/42/EC and standard EN/IEC 60947-5-5.
 (2) For yellow circular Emergency Stop legend plates: see page 2/19



Selector switches and key switches

Type of operator		Long black handle	Key, n° 455
Number and type of positions	positions (2)	3 - spring return 2 - stay put 2 - spring return 3 - stay put	2 - stay put
Degree of protection		IP 66 / Nema 1, 2, 3, 3R, 4, 6, 12 and 13 / Class II	
Mounting (mm)	panel cut-out mounting centres	Ø 31	
Depth below head (mm)		57.2 x 44.5 (with legend 9001KN2●●), 57.2 x 50.8 (with legend 9001KN3●●)	
Connection		Screw clamp terminals	
References	NO	–	9001KS11FBH5 9001KS34FBH5 – –
	CO	9001KS53FBH1	– – 9001KS43FBH1 9001KS11K1RH1

(2) The symbol indicates key withdrawal position.

Light functions



1

Pilot lights

Type of head		Smooth lens cap			
Degree of protection		IP 66 / Nema 1, 2, 3, 3R, 4, 6, 12 and 13 / Class II			
Mounting (mm)	panel cut-out	Ø 31			
	mounting centres	57.2 x 44.5 (with legend 9001KN2●●), 57.2 x 50.8 (with legend 9001KN3●●)			
Depth below head (mm)		42			
Connection		Screw clamp terminals			
Type of light block		With high luminosity LED (included)			Incandescent BA 9s bulb (included)
References		24 V AC/DC	48 V AC/DC	120 V AC/DC	230 V AC
	green ●	9001KP35LGG9	9001KP36LGG9	9001KP38LGG9	9001KP7G9
	red ●	9001KP35LRR9	9001KP36LRR9	9001KP38LRR9	9001KP7R9
	yellow ●	9001KP35LYA9	9001KP36LYA9	9001KP38LYA9	9001KP7A9



Illuminated pushbuttons, spring return

Type of head		Spring return flush push			
Degree of protection		IP 66 / Nema 1, 2, 3, 3R, 4, 6, 12 and 13 / Class II			
Mounting (mm)	panel cut-out	Ø 31			
	mounting centres	57.2 x 44.5 (with legend 9001KN2●●), 57.2 x 50.8 (with legend 9001KN3●●)			
Depth below head (mm)		42			
Connection		Screw clamp terminals			
Type of light block		With high luminosity LED (included)			Incandescent BA 9s bulb (included)
References		24 V AC/DC	48 V AC/DC	120 V AC/DC	230 V AC
	green ● CO	9001K3L35LGGH13	9001K3L36LGGH13	9001K3L38LGGH13	9001K2L7RH13
	red ● CO	9001K3L35LRRH13	9001K3L36LRRH13	9001K3L38LRRH13	9001K2L7GH13
	yellow ● CO	9001K3L35LYAH13	9001K3L36LYAH13	9001K3L38LYAH13	9001K2L7AH13



Illuminated Ø 41 mushroom head pushbuttons, latching, high luminosity LED

Degree of protection		IP 66 / Nema 1, 2, 3, 3R, 4, 6, 12 and 13 / Class II			
Mounting (mm)	panel cut-out	Ø 31			
	mounting centres	57.2 x 44.5 (with legend 9001KN2●●), 57.2 x 50.8 (with legend 9001KN3●●)			
Depth below head (mm)		42			
Connection		Screw clamp terminals			
Type of light block		With high luminosity LED (included)			Incandescent BA 9s bulb (included)
		24 V AC/DC	48 V AC/DC	120 V AC/DC	230 V AC/DC
Type of head		2 position, push-pull			
References	red ● CO	9001KR9P35RH13	9001KR9P36RH13	9001KR9P38RH13	9001KR9P7RH13
Type of head		3 position, push-pull (pull: spring return, centre: stay put, push: spring return)			
References	red ● NC + NC late break	9001KR8P35RH25	9001KR8P36RH25	9001KR8P38RH25	9001KR8P7RH25

1



Contact blocks with protected terminals

Type of contact	Single contact blocks	
Connection	Screw clamp terminals	
References	CO	9001KA1
	NO	9001KA2
	NC	9001KA3
	CO, late break	9001KA4
	NC, late break	9001KA5
	NO, early make	9001KA6

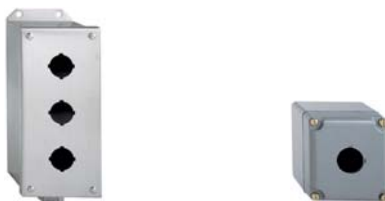

Enclosures

Type	Number of Ø 30 mm cut-outs	NEMA ratings	Reference
Aluminium	1	1, 3, 4, 6, 12, 13	9001KY1
	2	1, 3, 4, 6, 12, 13	9001KY2
	3	1, 3, 4, 6, 12, 13	9001KY3
	4	1, 3, 4, 6, 12, 13	9001KY4
Stainless steel	1	1, 3, 4, 4X, 13	9001KYSS1
	2	1, 3, 4, 4X, 13	9001KYSS2
	3	1, 3, 4, 4X, 13	9001KYSS3



Legends

Legends		44 x 43 mm	57 x 57 mm	Ø 60	Ø 90
Type	Colour of legend	Aluminium black background	Plastic white background	Plastic Yellow background	
Marking	Blank	9001KN200	9001KN100WP	9001KN9100	9001KN8100
	START	9001KN201	9001KN101WP	–	–
	STOP (red background)	9001KN202	9001KN102RP	–	–
	FORWARD	9001KN206	9001KN106WP	–	–
	REVERSE	9001KN207	9001KN107WP	–	–
	RESET	9001KN223	9001KN123WP	–	–
	PULL TO START/ PUSH TO STOP	9001KN379	9001KN179WP	–	–
	EMERGENCY STOP	–	–	9001KN9330	9001KN8330
	ARRET D'URGENCE	–	–	9001KN9330F	9001KN8330F
	PARADA DE EMERGENCIA	–	–	9001KN9330S	9001KN8330S



positions (°)

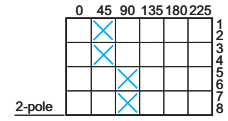
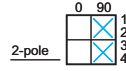
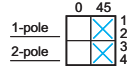

Cam switches, K1 / K2 series

Function	Switches	ON-OFF switches	Stepping switches
Degree of protection front face	45° switching angle IP 65 (1)	90° switching angle IP 65 (1)	with "0" position IP 65 (1)
Conventional thermal current (Ith)	12 A 20 A	12 A 20 A	12 A 20 A
Rated insulation voltage (Ui) conforming to IEC60947-1	690 V	690 V	690 V
Number of positions	2	2	2 + "0" position
Number of poles	2	2	2
Dimensions of front plate (mm)	45 x 45	45 x 45	45 x 45
Front mounting method	Multifixing plate, 45 x 45 mm	K1B002ALH K2B 002ALH	K1B1002HLH K2B 1002HLH
	Plastic mounting plate for Ø 22 mm hole	K1B002ACH K2B 002ACH	K1B1002HCH K2B 1002HCH
		K1D012QLH K2D012QLH	K1D012QCH K2D012QCH



positions (°)

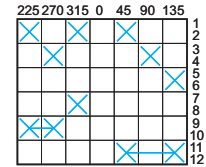
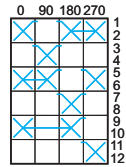
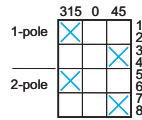

Cam switches, K1 / K2 series

Function	Changeover switches	Ammeter switches	Voltmeter switches
Degree of protection front face	IP 65 (1)	IP 65 (1)	IP 65 (1)
Conventional thermal current (Ith)	12 A 20 A	12 A 20 A	12 A 20 A
Rated insulation voltage (Ui) conforming to IEC60947-1	690 V	690 V	690 V
Number of positions	2 + "0" position	3 + "0" position (3 circuits + "0" position)	6 + "0" position (measurements between 3 phases & N + "0" pos.)
Number of poles	2	4	7
Dimensions of front plate (mm)	45 x 45	45 x 45	45 x 45
Front mounting method	Multifixing plate, 45 x 45 mm	K1D002ULH K2D002ULH	K1F003MLH to be compiled *
	Plastic mounting plate for Ø 22 mm hole	K1D002UCH K2D002UCH	K1F003MCH to be compiled *
		K1F027MLH to be compiled *	K1F027MCH to be compiled *

(1) With seal KZ73 for switch with Multifixing plate, with seal KZ65 for Ø 22 mm hole mounting switches. Seal to be ordered separately.

(*) Please consult your Schneider Electric agency.



positions (°)

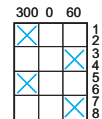
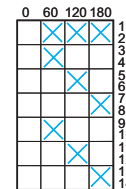
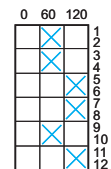

Cam switches with key operated lock, K1 series

Function	Stepping switches	Run switches	Changeover switches + "0" pos.
Degree of protection front face	IP 65	IP 65	IP 65
Conventional thermal current (Ith)	12 A	12 A	12 A
Rated insulation voltage (Ui) conforming to IEC60947-1	690 V	690 V	690 V
Number of positions	2 + "0" position	3 + "0" position	2 + "0" position
Number of poles	3	2	2
Dimensions of front plate (mm)	55 x 100	55 x 100	55 x 100
Colour of handle	red black	red black	red black
Front mounting method	Ø 22 mm hole + Ø 43.5 mm hole	K1G043RZ2 K1G043RZ4	K1D002UZ2 K1D002UZ4

1



positions (°)

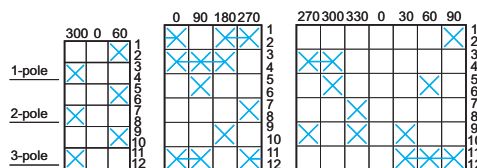
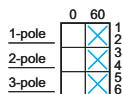

Cam switches, K10 series

Function	Switches			Changeover switches		Ammeter switches	Voltmeter switches			
Degree of protection	front face			with "0" position		IP 65	IP 65			
Conventional thermal current (I _{th})	10 A			10 A		IP 65	IP 65			
Rated insulation voltage (U _i) conforming to IEC60947-1	440 V			440 V		440 V	440 V			
Number of positions	2			2 + "0" position		3 + "0" pos. (1)	6 + "0" pos. (2)			
Number of poles	1	2	3	2	3	3	3			
Dimensions of front plate (mm)	30 x 30			30 x 30		30 x 30	30 x 30			
Front mounting method	By Ø 16 mm or 22 mm hole			K10A001ACH	K10B002ACH	K10C003ACH	K10D002UCH	K10F003UCH	K10F003MCH	K10F027MCH

(1) (3 circuits + "0" position).

(2) (Measurements between 3 phases and N + "0" position).



positions (°)

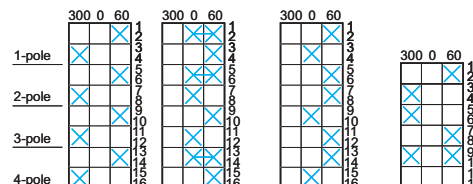
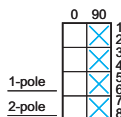
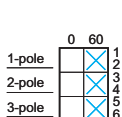

Cam switches, K30 series

Function	Switches	Switches	Changeover	Starting	Starting	Reversing			
Degree of protection	front face		with "0" position	star-delta	2-speed	IP 40			
Conventional thermal current (I _{th})	IP 40	ON-OFF	IP 40	IP 40	IP 40	IP 40			
Conventional thermal current (I _{th})	32 A	32 A	32 A	32 A	32 A	32 A			
Rated insulation voltage (U _i) conforming to IEC60947-1	690 V		690 V	690 V	690 V	690 V			
Number of positions	2	2	3	3	3	3			
Number of poles	3	3	4	3	3	3			
Dimensions of front plate (mm)	64 x 64		64 x 64	64 x 64	64 x 64	64 x 64			
Front mounting method	Multifixing		K30C003AP (3)	K30C003HP (3)	K30D004HP (3)	K30H004UP (3)	K30H001YP (3)	K30H004PP (3)	K30E003WP (3)

(3) To order switches with other thermal current ratings (50, 63, 115, 150 A): replace the number 30 in the reference by 50, 63, 115 or 150 respectively.

Example: a switch with a 32 A current rating, for example K30C003AP, becomes K50 C003AP for a current rating of 50 A.

Accessories for cam switches K1/K2

Rubber seals

For IP 65 degree of protection	For use with heads	with 45 x 45 mm front plate	with 60 x 60 mm front plate	with 45 x 45 mm front plate
		Ø 22 mm hole or 4 hole front mtg.	Ø 22 mm hole or 4 hole front mtg.	multifixing
References*		KZ65	KZ66	KZ73

* Sold in lots of 5.



Ø 40 mm / Up to IP54

Complete, pre-wired tower lights		Steady light			Steady / Flashing light (1)	
Light source (included)		LEDs			LEDs	
Base mount		Base mounting	Support tube mounting, 17 mm		Support tube mounting, 17 mm	
Buzzer		Without buzzer			With buzzer + flashing light	
Degree of protection		up to IP54			up to IP54	
Voltage		24V AC/DC	24V AC/DC	100-240V AC	24V AC/DC	100 - 240V AC
References (2)	Red	XVC4B1K	XVC4B1	XVC4M1 (4)	XVC4B15S	XVC4M15S (4)
	Red / orange	XVC4B2K	XVC4B2	XVC4M2	XVC4B25S	XVC4M25S
	Red / Orange / green	XVC4B3K	XVC4B3	XVC4M3	XVC4B35S	XVC4M35S
	red / orange / green / blue	XVC4B4K	XVC4B4	XVC4M4	XVC4B45S	XVC4M45S
	red / orange / green / blue / Clear	XVC4B5K	XVC4B5	XVC4M5	XVC4B55S	XVC4M55S



Ø 60 mm / Up to IP54

Complete, pre-wired tower lights		Steady light			Steady / Flashing light (1)		
Light source (included)		LEDs			LEDs		
Base mount		Base mounting	Support tube mounting, 22 mm		Support tube mounting, 22 mm	Base mounting	
Buzzer		Without buzzer			With buzzer + flashing light		
Degree of protection		up to IP54			up to IP54		
Voltage		24V AC/DC	24V AC/DC	100-240 V AC (4)	24V AC/DC	100-240 V AC (4)	
References (2)	Red	XVC6B1K	XVC6B1	XVC6M1 (3)	XVC6B15S (3)	XVC6M15S	XVC6M15SK
	Red / orange	XVC6B2K	XVC6B2	XVC6M2 (3)	XVC6B25S (3)	XVC6M25S	XVC6M25SK
	Red / Orange / green	XVC6B3K	XVC6B3	XVC6M3 (3)	XVC6B35S (3)	XVC6M35S	XVC6M35SK
	red / orange / green / blue	XVC6B4K	XVC6B4	XVC6M4 (3)	XVC6B45S (3)	XVC6M45S	XVC6M45SK
	red / orange / green / blue / Clear	XVC6B5K	XVC6B5	XVC6M5 (3)	XVC6B55S (3)	XVC6M55S	XVC6M55SK



Ø 100 mm / Up to IP54

Complete, pre-wired tower lights		Steady / Flashing light (1)					
Light source (included)		LEDs					
Base mount		Base mounting					
Buzzer		Without buzzer			With buzzer + flashing light		
Degree of protection		up to IP54			up to IP54		
Voltage		24V DC (4)	100-240V AC (4)	24VDC (4)	100-240V AC (4)	24VDC (4)	100-240V AC (4)
References (2)	Red	XVC1B1K	XVC1M1K	XVC1B1SK	XVC1M1SK	XVC1B1HK	XVC1M1HK
	Red / orange	XVC1B2K	XVC1M2K	XVC1B2SK	XVC1M2SK	XVC1B2HK	XVC1M2HK
	Red / Orange / green	XVC1B3K	XVC1M3K	XVC1B3SK	XVC1M3SK	XVC1B3HK	XVC1M3HK
	red / orange / green / blue	XVC1B4K	XVC1M4K	XVC1B4SK	XVC1M4SK	-	-
	red / orange / green / blue / Clear	XVC1B5K	XVC1M5K	XVC1B5SK	XVC1M5SK	-	-

(1) Flashing function can be simply selected/programmed by wiring

(2) The colours are listed in the same order as the mounting order of the illuminated units (from top to bottom)

(3) To order products for base mounting, add the letter K to the end of the reference (ex. XVC6M1K)

(4) NPN only

1



Ø 45 mm / IP40

Illuminated beacons XVDLS		Steady light	Flashing light
Light source		Incandescent BA 15d bulb, 5 W max. (not included)	"Flash" discharge tube, 0.5 J
Degree of protection		IP 40	
References (1)	24...230 V AC/DC	XVDLS3●	–
	24 V AC/DC	–	XVDLS6B●
	120 V AC	–	XVDLS6G●
	230 V AC	–	XVDLS6M●

(1) To obtain the complete reference, replace the ● by the number designating the colour as follow: 3 = green , 4 = red , 5 = orange, 6 = blue, 7 = clear, 8 = yellow.

Accessories

XVDLS

Incandescent bulbs, with BA 15d base	Beacons XVDLS		
Description	24 V, 4 W	120 V, 5 W	230 V, 5 W
References	DL1BEBS	DL1BEGS	DL1BEMS



XVC4 / XVC6

Mounting accessories	Tower lights Ø 40 mm, XVC4			Tower lights Ø 60 mm, XVC6		
Description	Support tube mounting			Support tube mounting	Base mounting	Support tube mounting
Diameter (mm)	Ø 90	Ø 84	–	Ø 100	Ø 84	–
For use with	–	–	–	XVC6●●and XVC6●●5S	XVC6●●K and XVC6●●5SK	XVC6B●and XVC6B●5S, XVC6M●and XVC6M●5S
Height to be added (mm)	32	24,5	82	30	21,6	82
References	Metal fixing plate	XVCZ11	–	XVCZ02	XVCZ12	–
	Plastic fixing plate	–	XVCZ01	–	–	–
	Wall mounting bracket	–	–	XVCZ31	–	XVCZ32



XVC1

Mounting accessories	Tower lights Ø 100 mm, XVC1			
Description	Vertical support			
Diameter (mm)	Ø 140	Ø 140	–	–
For use with	XVC1●●K and XVC1●●SK	XVC1●●HK (with siren)	XVC1●●K and XVC1●●SK	XVC1●●HK (with siren)
Height to be added (mm)	300	306	–	–
References	Metal fixing plate (2)	XVCZ13	XVCZ14	–
	Metal fixing bracket	–	–	XVCZ23
				XVCZ24

(2) Chromium plated-steel extension tube



Ø 70 mm / Up to IP66

Illuminated beacons XVBL		Steady light		Flashing light	
Light source		Incandescent BA 15d bulb, 10 W max. (not included)	Protected BA 15d LED (included)	Protected BA 15d LED (included)	"Flash" discharge tube 5 J (2)
Degree of protection		IP 66			
References (1)	12...250 V AC/DC	XVBL3●	–	–	–
	24 V AC/DC	–	XVBL0B●	XVBL1B●	XVBL6B●
	120 V AC	–	XVBL0G●	XVBL1G●	XVBL6G●
	230 V AC	–	XVBL0M●	XVBL1M●	XVBL6M●



Ø 70 mm / Up to IP66

Tower lights XVBC comprising 2 to 5 signalling units (3)		Base units	Steady light		Flashing light	"Flash" light	Audible units (90 db at 1 m)
Light source		–	Incandescent BA 15d bulb, 10 W max. (not included)	Integral protected LED	Integral protected LED	"Flash" discharge tube 5 J (2)	–
Degree of protection		IP 66					
Base unit references		with cover	XVBC21 (4)	–	–	–	–
		without cover	XVBC07 (5)	–	–	–	–
References (2)	12... 230 V AC/DC	–	XVBC3●	–	–	–	–
	24 V AC/DC	–	–	XVBC2B●	XVBC5B●	XVBC6B●	–
	120 V AC	–	–	XVBC2G●	XVBC5G●	XVBC6G●	–
	230 V AC	–	–	XVBC2M●	XVBC5M●	XVBC6M●	–
Audible unit references		12...48 V AC/DC	–	–	–	–	XVBC9B
unidirectional		120...230 V AC	–	–	–	–	XVBC9M

(1) To obtain the complete reference, replace the ● by the number designating the colour as follow: 3 = green , 4 = red , 5 = orange, 6 = blue, 7 = clear, 8 = yellow.

(2) To order a lens unit with a **10 J** discharge tube, replace the number 6 by 8 in the reference (example: **XVBL6B●** becomes **XVBL8B●**).

(3) A tower light comprises: 1 base unit + 1 to 5 signalling units maximum.

(4) For connection on AS-Interface, order base unit **XVBC21A** (side cable entry) or **XVBC21B** (bottom cable entry with M12 connector on flying lead).

(5) For indicator banks with "flash" discharge tube unit.

1



Ø 70 mm / Up to IP54

Illuminated beacons XVEL		Steady light		Flashing light
Light source		Incandescent BA 15d bulb, 5 W max. (not included)	Integral LED	"Flash" discharge tube, 1 J
Degree of protection		IP 42/IP 54 (with sealing kit)		
References (1)	24... 240 V AC/DC	XVEL3●	–	
	24 V AC/DC	–	XVEL2B●	XVEL6B●
	120 V AC	–	XVEL2G●	XVEL6G●
	230 V AC	–	XVEL2M●	XVEL6M●

Ø 70 mm / Up to IP54



Indicator banks XVEC comprising 2 to 5 signalling units (2)		Base units	Steady light		Flashing light	"Flash" light	Audible units (85 db at 1 m)
Light source		–	Incandescent BA 15d bulb, 5 W max. (not included)	Integral LED	Integral LED	"Flash" discharge tube 1 J	–
Degree of protection		IP 42/IP 54 (with sealing kit)					
Base unit references	IP 42	XVEC21	–	–	–	–	–
	IP 54	XVEC21P	–	–	–	–	–
Lens unit references (1)	24...230 V AC/DC	–	XVEC3●	–	–	–	–
	24 V AC/DC	–	–	XVEC2B●	XVEC5B●	XVEC6B●	XVEC9B
	120 V AC	–	–	XVEC2G●	XVEC5G●	XVEC6G●	XVEC9G
	230 V AC	–	–	XVEC2M●	XVEC5M●	XVEC6M●	XVEC9M

(1) To obtain the complete reference, replace the● by the number designating the colour as follow: 3 = green , 4 = red , 5 = orange, 6 = blue, 7 = clear, 8 = yellow.

(2) A tower light comprises: 1 base unit + 1 to 5 signalling units maximum.

Modular tower lights

Ø 45, Ø 50 mm, complete or for customer assembly

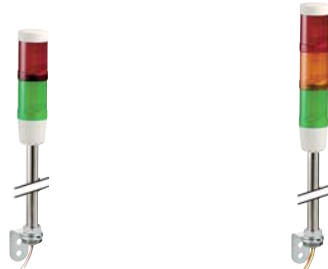

Ø 45 mm / IP42

Complete, pre-wired tower light XVM (1)	2 sig. units + integral buzzer (2)		3 signalling units + integral buzzer (2)				
	Steady light		Steady light		Steady light + flash" (3)		
Light source (included)	Incandescent BA 15d bulb, 5 W max.	BA 15d "Super bright" LED	Incandescent BA 15d bulb, 5 W max.	BA 15d "Super bright" LED	Incandescent BA 15d bulb, 5 W max.	BA 15d "Super bright" LED	
Degree of protection	IP 54		IP 54				
Signalling colours	Red - Green		Red - Orange - Green				
References	24 V AC/DC	XVMB1RGS	XVMB2RGSSB	XVMB1RAGS	XVMB2RAGSSB	XVMB1R6AGS	XVMB2R6AGSSB
	120 V AC/DC (bulb) - 120 V AC (LED)	XVMG1RGS	XVMG2RGSSB	XVMG1RAGS	XVMG2RAGSSB	XVMG1R6AGS	XVMG2R6AGSSB
	230 V AC/DC (bulb) - 230 V AC (LED)	XVMM1RGS	XVMM2RGSSB	XVMM1RAGS	XVMM2RAGSSB	XVMM1R6AGS	XVMM2R6AGSSB

(1) Tower lights XVM are also available as separate components for customised assembly by the user: please refer to www.schneider-electric.com.

(2) To order products without an integral buzzer, delete the letter **S** at the end of the reference (example: XVMB2RGS becomes XVMB2RG, XVMB2RGSSB becomes XVMB2RGSB).

(3) Flash signalling colour: red - 0.8 J.



Ø 50 mm / IP65

Tower lights XVP comprising 2 to 5 signalling units (4), black clamping ring (5)	Base unit	Steady or flashing light signalling	"Flash" light signalling		Audible units (55...85 dB at 1 m)
Light source	–	Incandescent BA 15d bulb, 7 W max. (not included)	"Flash" discharge tube 0.3 J	"Flash" discharge tube 0.6 J	–
Degree of protection	IP 65				
Base unit	with cover XVPC21	–	–	–	–
References (6)	250 V max.	–	XVPC3●	–	–
	24 V AC/DC (flash) - 24 V DC (buzzer)	–	–	XVPC6B●	–
	120 V AC	–	–	–	XVPC6G●
	230 V AC	–	–	–	XVPC6M●
					XVPC09B
					XVPC09G
					XVPC09M

(4) A tower light comprises: 1 base unit + 1 to 5 signalling units maximum.

(5) To order products with a cream clamping ring, add the letter **W** to the end of the reference (example: base unit + green lens unit: XVPC21W + XVPC33W etc.).

(6) To obtain the complete reference, replace the ● by the number designating the colour as follow: 3 = green , 4 = red , 5 = orange, 6 = blue, 7 = clear, 8 = yellow.

1



Bulbs		Beacons and tower lights XVB / XVP (1)			
Type of light source		Incandescent BA 15d base 7 W	Incandescent BA 15d base 10 W (not XVP)	LED (2) BA 15d base	Flashing LED (2) BA 15d base
References	12 V	DL1BEJ	DL1BLJ	–	–
	24 V	DL1BEB	DL1BLB	DL1BDB●	DL1BKB●
	48 V	DL1BEE	DL1BLE	–	–
	120 V	DL1BEG	DL1BLG	DL1BDG●	DL1BKG●
	230 V	DL1BEM	DL1BLM	DL1BDM●	DL1BKM●

(1) Tower lights XVP can be fitted with 5 W incandescent bulbs: see beacons XVDLS / XVE.

(2) To obtain the complete reference, replace the ● by the number designating the colour as follow: 1 = white, 3 = green, 4 = red, 5 = orange, 6 = blue, 8 = yellow.



Bulbs		Tower lights XVM			
Type of light source		Incandescent BA 15d base 5 W	LED (3) BA 15d base	Flashing LED (3) BA 15d base	"Flash" discharge tube, 0.8 Joule BA 15d base
References	24 V	DL1EDBS	DL2EDB●SB	DL1EKB●SB	DL6BB
	120 V	DL1EDGS	DL2EDG●SB	DL1EKG●SB	DL6BG
	230 V	DL1EDMS	DL2EDM●SB	DL1EKM●SB	DL6BM

(3) To obtain the complete reference, replace the ● by the number designating the colour as follows: 1 = white, 3 = green, 4 = red, 6 = blue, 8 = orange.



Mounting accessories		Beacons and tower lights XVB / XVE		Tower lights XVP		Tower lights XVM	
Description		Aluminium tube with integral black plastic fixing base	Plastic tube with integral black plastic fixing base	Aluminium tube with integral black plastic fixing base	Aluminium tube with steel fixing bracket	Aluminium tube with integral cream plastic fixing base	Aluminium tube with steel fixing bracket
Diameter (mm)		Ø 25	Ø 25	Ø 20	Ø 20	Ø 20	Ø 20
Support tubes	60 mm	XVEZ13	–	–	–	–	–
	100 mm	–	–	–	XVPC02T	XVMZ02	XVMZ02T
	112 mm	–	–	XVPC02 (4)	–	–	–
	120 mm	XVBZ02	–	–	–	–	–
	140 mm	–	XVDC02	–	–	–	–
	250 mm	–	–	–	XVPC03T	XVMZ03	XVMZ03T
	260 mm	–	–	XVPC03 (4)	–	–	–
	400 mm	–	–	–	XVPC04T	XVMZ04	XVMZ04T
	410 mm	–	–	XVPC04 (4)	–	–	–
	420 mm	XVBZ03	–	–	–	–	–
Fixing plates,	820 mm	XVBZ04	–	–	–	–	–
	for vertical support	XVBC12		XVPC12 (4)		–	
	for horizontal support	XVBZ01		–		XVMZ06	

(4) To order an aluminium support tube with integral cream fixing base, add the letter **W** to the end of the reference (example: XVPC02W).



Ø 84 / 106 mm

Complete, pre-wired rotating beacons		Ø 84 mm		Ø 106 mm	
Light source (included)		" Super bright " LEDs			
Base mount		3 x Ø 05			
Buzzer		Without buzzer			
Degree of protection		IP23 (IP 65 with accessories)		IP23 (IP 55 with accessories)	
Voltage		12V AC/DC	24V AC/DC	12V AC/DC	24V AC/DC
References	Red	XVR08J04	XVR08B04	XVR10J04	XVR10B04
	Orange	XVR08J05	XVR08B05	XVR10J05	XVR10B05
	Green	XVR08J03	XVR08B03	XVR10J03	XVR10B03
	Blue	XVR08J06	XVR08B06	XVR10J06	XVR10B06



Ø 120 mm

Complete, pre-wired rotating beacons		Ø 120 mm			
Light source (included)		" Super bright " LEDs			
Base mount		3 x M5			
Buzzer		Without buzzer		With buzzer	
Degree of protection		IP23			
Voltage		12V AC/DC	24V AC/DC	12V AC/DC	24V AC/DC
References	Red	XVR12J04	XVR12B04	XVR12J04S	XVR12B04S
	Orange	XVR12J05	XVR12B05	XVR12J05S	XVR12B05S
	Green	XVR12J03	XVR12B03	XVR12J03S	XVR12B03S
	Blue	XVR12J06	XVR12B06	XVR12J06S	XVR12B06S



Ø 130 mm

Complete, pre-wired rotating beacons		Ø 130 mm				
Light source (included)		" Super bright " LEDs				
Base mount		3 x Ø 09				
Buzzer		Without buzzer				
Degree of protection		IP66 - Resistant to vibration		IP66 and IP67		
Voltage		12V DC	24V DC	24V AC/DC	120V AC	230V AC
References	Red	XVR13J04	XVR13B04	XVR13B04L	XVR13G04L	XVR13M04L
	Orange	XVR13J05	XVR13B05	XVR13B05L	XVR13G05L	XVR13M05L

1



Accessories for rotating mirrors		Reflecting prism	Rubber base	Metal angle bracket	Metal fixing plate
To be used for/with		–	Increasing the IP degree	Horizontal support	Horizontal support
Height (mm)		–	–	–	300
References	Ø 84 mm	XVRZR1	XVRZ081	XVCZ23	–
	Ø 106 mm	XVRZR2	XVRZ082	XVCZ23	XVCZ13
	Ø 120 mm	XVRZR3	–	XVCZ23	XVCZ13
	Ø 130 mm	XVRZR3	–	XVR012L	–

Electronic alarms and multisound sirens



Sirens and electronic alarms		Sirens	Multisound sirens pre-wired	Electronic alarms Panel Mount DIN72		Electronic alarms Panel Mount DIN96	
Sound level		106 dB	105 dB	90 dB		96 dB	
Tones		2	43	16		16	
Channels		–	8	4		4	
Degree of protection		IP 53	IP53	IP 54		IP 54	
Colors		White	White	Black	White	Black	White
References	12/24V AC/DC	XVS10BMW	–	XVS72BMB● (1)	XVS72BMW● (1)	XVS96BMB● (1)	XVS96BMW● (1)
	12/24V DC	–	XVS14BMW	–	–	–	–
	120V AC	XVS10GMW	XVS14GMW	–	–	–	–
	230V AC	XVS10MMW	XVS14MMW	–	–	–	–

(1) To obtain a complete reference, replace the ● by the letter as follow: P = PNP, N = NPN (ex. XVS72BMBP)



Type XACA "Pistol grip"			
Degree of protection	IP 65 / Nema 4, 4X / Class II		
Rated operational characteristics	AC 15 (240 V 3 A), DC 13		
Conventional thermal current	lthe	10 A	
Connection	Screw clamp terminals, 1 x 2.5 mm ² or 2 x 1.5 mm ²		
For control of	single-speed motors 		2-speed motors
Dimensions (mm)	W x H x D	52 x 295 x 71 (x 85 with ZA2BS834)	52 x 295 x 71 (x 85 with ZA2BS834)
Number of operators	mechanically interlocked	2	
	Emergency stop	without	ZA2BS834
References		XACA201	XACA2014
			XACA207
			XACA2074



Type XACA			
For control of single-speed motors			
Dimensions (mm)	W x H x D	80 x 314 x 70 (x 90 with ZA2BS834)	80 x 440 x 70 (x 90 with ZA2BS844)
Number of operators	mechanically interlocked between pairs	2	
	Emergency stop	without	ZA2BS834
References		XACA271	XACA2714
			XACA471
			XACA4714



For control of single-speed motors			
Dimensions (mm)	W x H x D	80 x 500 x 70 (x 90 with ZA2BS844)	80 x 560 x 70
Number of operators	mechanically interlocked between pairs	6	
	Emergency stop	without	ZA2BS844
References		XACA671	XACA6714
			XACA871

Empty enclosures type XACA							
Number of ways	2	3	4	5	6	8	12
References	XACA02	XACA03	XACA04	XACA05	XACA06	XACA08	XACA12

Separate components (for mounting in enclosures XACA)

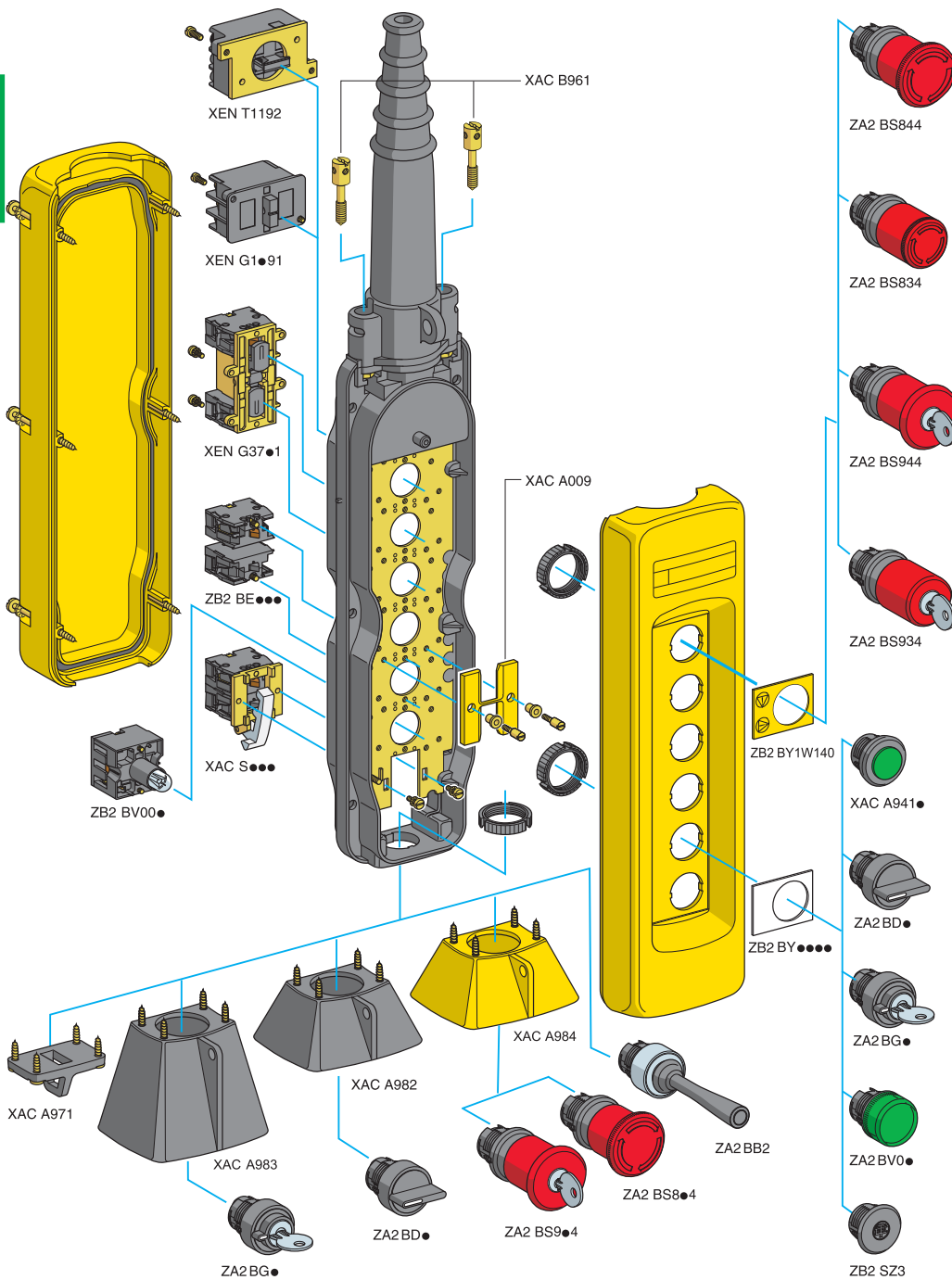

Mushroom head, latching, trigger action (1)		
turn to release	Ø 40	ZA2BS844
	Ø 30	ZA2BS834

Mushroom head, latching, trigger action (1)		
key release	Ø 40	ZA2BS944
	Ø 30	ZA2BS934

Booted operators		
white	●	XACA9411
black	●	XACA9412

Selector switch		
	2 pos. stay put	ZA2BD2
	3 pos. stay put	ZA2BD3

Key switch		
key n° 455	2 pos. stay put	ZA2BG4
	3 pos. stay put	ZA2BG5

Pilot light heads		
white	●	ZA2BV01
green	●	ZA2BV03
red	●	ZA2BV04
yellow	●	ZA2BV05

Pilot light bodies		
direct supply		ZB2BV006
direct supply, through resistor		ZB2BV007

Blanking plug		
with seal and fixing nut		ZB2SZ3

Isolating switch, slow break, for front mounting	
Emergency stop NC+NC+NC with positive opening operation	XENT1192

Contacts blocks for XACA941●	
Single-speed NC+NO	XENG1491
2-speed NC+NO+NO	XENG1191

Double blocks latching, slow break	
Single-speed NO+NO	XENG3781
Single-speed NO+NC	XENG3791

Contact blocks	
Single-speed NO	ZB2BE101
Single-speed NC	ZB2BE102

Contact blocks (for mounting in enclosure base)	
NO	XACS101
NC+NO	XACS105

Protective guard (for base mounted units)	
For selector switch	XACA982/983
For emergency stop pushbutton	XACA984

Legends, 30 x 40 mm	With symbols conforming to NF E 52-124						With text			
References	ZB2BY4901	ZB2BY4903	ZB2BY4907	ZB2BY4909	ZB2BY4913	ZB2BY4915	ZB2BY4930	ZB2BY2303	ZB2BY2304	
								blank		
References	ZB2BY2904	ZB2BY2906	ZB2BY2910	ZB2BY2912	ZB2BY2916	ZB2BY2918	ZB2BY2931	white or yellow background		ZB2BY1W140

(1) Trigger action mechanically latching Emergency stop pushbuttons conform to standards EN/IEC 60204-32, EN/ISO 13850, Machinery directive 2006/42/EC and standard EN/IEC 60947-5-5.

Notes

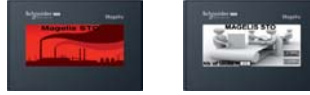

Type		Characteristics					
Display	Touchscreen	3.4" (200 x 80 pixels) Monochrome LCD					
	Backlight	Green, orange, red	White, pink, red	Green, orange, red			
Ambient temperature		0...50 °C					
Memory	Application/Backup	16MB/128KB					
	Extension	No, via USB stick only					
Functions	Real time clock	Access to the PLC real-time clock					
	Variables max.	8000					
Third-party protocols supported		Siemens, Omron, Mitsubishi, Allen-Bradley (Rockwell Automation), ABB					
Communication	Ethernet port	No	No	x1 RJ45	x1 RJ45	No	
	Serial line	RS 232C/RS 485 (COM1)			No	No	Zelio Logic
	USB	USB Type-A (2.0) x 1, USB mini-B (2.0) x 1					
Replaceable Battery		No					
Dimensions	External W x H x D (mm)	117 x 78 x 28					
	Cut-out W x H (mm)	105 x 66					
Supply voltage		24VDC					
Conformity to standards		EN, IEC, UL 508, ISA 12, 12, CSA, Marine Bridge & Deck (1), GOST					
Reference		HMISTO511	HMISTO512	HMISTO531	HMISTO532	HMISTO501	

(1) Except HMISTO53.

Magelis STU with graphic screen



Type		Characteristics			
Display	Touchscreen	3.5": 320 x 240 pixels		5.7", 320 x 240 pixels	
	Type	65,536-color TFT			
Front Face		Standard	Without logotype	Standard	Without logotype
Ambient temperature		0...50 °C			
Memory	Application/Backup	32MB/64KB			
	Extension	No, via USB stick only			
Functions	Real time clock	Access to the PLC real-time clock			
	Variables max.	8000			
Third-party protocols supported		Siemens, Omron, Mitsubishi, Allen-Bradley (Rockwell Automation), ABB			
Communication	Ethernet port	x1 RJ45			
	Serial line	RS 232C/RS 485 (COM1)			
	USB	USB Type-A (2.0) x 1, USB mini-B (2.0) x 1			
Replaceable Battery		No			
Dimensions	External W x H x D (mm)	Front: 98 x 16 x 81		Front: 163 x 17.5 x 129.5	
	Cut-out	Ø22 mm			
Supply voltage		24VDC			
Conformity to standards		EN, IEC, UL 508, ISA 12,12,CSA , Marine Bridge & Deck, GOST			
References		HMISTU655	HMISTU655W	HMISTU855	HMISTU855W

Common accessories for Magelis STO/STU

Serial connection to PLC/Drives (1)	HMI STO/STU	Connector/Physical link	Length	Reference
Twido, Premium, Micro	RJ45 (COM1)	Mini-DIN/RS485	2.5 m	XBT Z9780
M238/M258/M340, ATS, ATV	RJ45 (COM1)	RJ45/RS485	2.5 m	XBT Z9980
ATV, ATS	RJ45 (COM1)	RJ45/RS485	1 m	VW3A8306R10
M340	USB	USB mini-B	1.8 m	BMX XCAUSBH018
Siemens S7, PPI, MPI	RJ4 5 (COM1)	SUBD9/RS485	2.5 m	XBT ZG9721
Rockwell Micro-Logix, DF1-Full Duplex	RJ45 (COM1)	8-way mini-DIN /RS232	2.5 m	XBT Z9733
Rockwell SLC5,	RJ45 (COM1)	SUBD9/RS232	2.5 m	XBT Z9734
Omron, Sysmac FINS (SIO)	RJ45 (COM1)	SUBD9/RS232	2.5 m	XBT Z9743
Mitsubishi FX CPU	RJ45 (COM1)	Mini-DIN 8/RS232	2.5 m	HMIZ950

(1) For the full list of connection accessories, please consult our site <http://www.schneider-electric.com>.

Accessories and spare parts for Magelis STO

Accessories	
Protective sheets	HMIZS60
Communication cable between Zelio Logic SR2/SR3 and HMISTO501	SR2CBL09
Spare parts	
Spring Clips	XBT Z3002
Installation Gasket	HMI ZS50
Set of 5 Power Connectors	HMI ZSPWO

Accessories and spare parts for Magelis STU

Accessories		
Touchscreen size	3.5"	5.7"
Set of 5 Screen Protective Sheets	HMIZS61	HMIZS62
Accessory Kit for HMI STU 655/855, contains: USB standard Type A cable holder; USB mini B cable holder; Anti-rotation Tee; 2 Panel adaptors	HMI ZSU KIT	
Spare parts		
Touchscreen size	3.5"	5.7"
Front face module (without logotype)	HMIS65 (HMIS65W)	HMIS85 (HMIS85W)
Rear CPU module	HMIS5T	
Set of 5 Power Connectors	XBT ZGPWS1	
Kit of 10 display module fixing nuts	ZB5AZ901	
Tightening Wrench	ZB5AZ905	

1



Type		Characteristics (65 536-colour TFT touchscreen)			
		3.5": 320 x 240 pixels		5.7": 320 x 240 pixels	
Degree of protection	Front Face	Standard, IP65			
Conformal coating		No (1)			
Ambient temperature		0...50 °C		0...55 °C	
Memory	Application/Backup	64MB/128KB	96MB/512KB	64MB/128KB	96MB/512KB
	Extension	No, via USB stick only			SD card
Functions	Real time clock	Yes, built-in			
	Variables max.	8000			
Third-party protocols supported		Siemens, Omron, Mitsubishi, Allen-Bradley (Rockwell Automation), ABB			
Communication	Ethernet port	No	x1 RJ45	No	x1 RJ45
	Serial line	RS 232C (COM1) and RS 485 (COM2) (2)			
	USB	USB Type-A (2.0) x 1, USB mini-B (2.0) x 1			
Dimensions	External / Cut-out W x H x D (mm)	132 x 106 x 42 / 118.5 x 92.5		169.5 x 137 x 59.5 / 156 x 123.5	
Conformity to standards		EN, IEC, UL 508, ISA12,12, CSA, ATEX Zone2/22, Marine Bridge & Deck (3), GOST			
Reference	24 VDC	HMI GTO1300	HMI GTO1310	HMI GTO2300	HMI GTO2310

(1) Available on request; (2) COM1 only (RS232C/RS485) in HMI GTO1310; (3) Except GTO●●●5

Accessories

Set of 5 Screen Protective Sheets	HMI ZG60	HMI ZG62
Plastic covers for Harsh Environment (IP67)	HMI ZECOV1	HMI ZECOV2

Magelis XBT GT with 5,7" to 12" touchscreen



Type		Characteristics				
		5.7": 320 x 240 pixels		5.7": 640 x 480 pixels	7.5": 640 x 480 pixels	
Display	Type	4096-color STN	65,536-color TFT	4096-color STN		
Ambient temperature		0...50 °C				
Memory	Application/Backup	16MB/512KB		32MB/512KB		
	Extension	Compact Flash card				
Functions	Real time clock	Yes, built-in				
	Variables max.	8000				
	Multimedia	No		Audio out		
	HMI Controller function	Yes, with CANopen Master extension (programming in SoMachine software)				
Third-party protocols supported		Siemens, Omron, Mitsubishi, Allen-Bradley (Rockwell Automation), ABB				
Communication	Ethernet port	No	x1 RJ45			
	Serial line	RS232/RS422/RS485 (COM1) + RS485 (COM2)				
	Fieldbus extensions	Profibus DP, DeviceNet, Modbus Plus, FIPWAY, FIPIO				
	USB	USB Type-A (1.1) x 1		USB Type-A (1.1) x 2	USB Type-A (1.1) x 1	
Dimensions	External / Cut-out W x H x D (mm)	167.5 x 60 x 135 / 156 x 123.5		215 x 60 x 170 / 204.5 x 159.5		
Conformity to standards		EN, IEC, UL 508, ISA 12,12 (2), CSA, ATEX Zone 2/22 (3), Marine (4), GOST				
Reference	24VDC	XBTGT2220	XBTGT2330	XBTGT2930 (1)	XBTGT2430	XBTGT4230

(1) High-brightness backlight, 1000 cd/m2, (2) Except XBTGT2930, (3) Zone 22 only XBTGT6●●● / 7●●●, (4) Except XBTGT2220/2430 / 2930 / 4230 / 5430

Accessories

Set of 5 Screen Protective Sheets	XBT ZG62	XBT ZG64			
Plastic covers for Harsh Environment (IP67)	XBT ZG70	XBT ZG70	XBT ZG70	XBT ZG70	–



7.0": 800 x 480 pixels	7.5": 640 x 480 pixels	10.4": 640 x 480 pixels	12.1": 800 x 600 pixels	5.7": 320 x 240 pixels	10.4": 640 x 480 pixels	12.1": 800 x 600 pixels
Standard, IP65				Stainless steel, IP66K		
No (1)				Yes		
0...50 °C		0...55 °C				
96MB/512KB						
SD card						
Yes, built-in						
8000						
Siemens, Omron, Mitsubishi, Allen-Bradley (Rockwell Automation), ABB						
x1 RJ45						
RS 232C (COM1) and RS 485 (COM2) (2)						
USB Type-A (2.0) x 1, USB mini-B (2.0) x 1						
218x173x60 / 204.5x159.5		272.5x214.5x57 / 259x201	315x241x56 / 301.5x227.5	213.5x181x59.5 / 195x162.5	316.5x258.5x57 / 298x240	359x285x56 / 340.5x266.5
EN, IEC, UL 508, ISA12,12, CSA, ATEX Zone2/22, Marine Bridge & Deck (3), GOST						
HMI GTO3510	HMI GTO4310	HMI GTO5310	HMI GTO6310	HMI GTO2315	HMI GTO5315	HMI GTO6315

HMI ZG63	HMI ZG64	HMI ZG65	HMI ZG66	HMI ZG62	HMI ZG65	HMI ZG66
HMI ZECOV4	HMI ZECOV4	HMI ZECOV5	HMI ZECOV6	–	–	–



7.5": 640 x 480 pixels	10.4": 640 x 480 pixels	10.4": 800 x 600 pixels	12.1": 800 x 600 pixels	15": 1024 x 768 pixels			
65,536-color TFT							
0...50 °C							
32MB/512KB							
Compact Flash card							
Yes, built-in							
8000							
Audio out		Video in, Audio in/out	Audio out	Video in, Audio in/out	Audio out	Audio out	Video in, Audio in/out
Yes, with CANopen Master extension (programming in SoMachine software)							
Siemens, Omron, Mitsubishi, Allen-Bradley (Rockwell Automation), ABB							
x1 RJ45							
RS232/RS422/RS485 (COM1) + RS485 (COM2)							
Profibus DP, DeviceNet, Modbus Plus, FIPWAY, FIPIO							
USB Type-A (1.1) x 2							
215 x 60 x 170 / 204.5 x 159.5		271 x 57 x 213 / 259 x 201		313 x 56 x 239 / 301.5 x 227.5	395x60x294 / 383.5x282.5		
EN, IEC, UL 508, ISA 12,12 (2) ,CSA, ATEX Zone 2/22 (3) , Marine(4), GOST							
XBTGT4330	XBTGT4340	XBTGT5330	XBTGT5340	XBTGT5430	XBTGT6330	XBTGT6340	XBTGT7340

XBT ZG64	XBT ZG65	XBT ZG66	MPC YK5 0SPS KIT
–	XBT ZG71	XBT ZG71	–

Advanced Panel Magelis XBT GK with touchscreen and keypad

1



Type		Characteristics (65,536-color TFT touchscreen)	
		5.7", 320 x 240 pixels	10.4": 640 x 480 pixels
Data entry	Soft function keys with LED	14	18
	Static function keys with LED	10 + legends	12 + legends
	Service keys / Alphanumeric keys	8 / 12	
	Industrial pointer	Yes	
Ambient temperature		0...50 °C	
Memory	Application/Backup	16MB/512KB	32MB/512KB
	Extension	Compact Flash card	
Functions	Real time clock	Yes, built-in	
	Variables max.	8000	
	HMI Controller function	Yes, with CANopen Master extension (programming in SoMachine software)	
Third-party protocols supported		Siemens, Omron, Mitsubishi, Allen-Bradley (Rockwell Automation), ABB	
Communication	Ethernet port	x1 RJ45	
	Serial line	RS232/RS422/RS485 (COM1) + RS485 (COM2)	
	Fieldbus extensions	Profibus DP, DeviceNet, Modbus Plus, FIPWAY, FIPIO	
	USB	USB Type-A (1.1) x 1	USB Type-A (1.1) x 2
Dimensions	External / Cut-out W x H x D (mm)	220.3 x 265 x 60.3 / 209 x 243	296 x 332 x 72.7 / 285 x 309
Conformity to standards		EN, IEC, UL 508, ISA 12,12 , CSA, GOST	
Reference	24VDC	XBTGK2330	XBTGK5330
Accessories			
Set of 5 Screen Protective Sheets		XBT ZG68	XBT ZG69

Magelis XBT GH with handheld 5.7" touchscreen



Type		Characteristics (65,536-colour TFT touchscreen)		
		5.7", 320 x 240 pixels		
Data entry	Function keys / Operation key	11 / 1 with LED (validation touchscreen)		
Safety components	Key Switch	Yes for ON/OFF	Yes	
	3 positions Enable switch	Yes, OK signal in intermediate position only	Yes	
	Emergency stop	Yes, red with 2 safe contacts and one auxiliary contact	No	
Ambient temperature		0...50 °C		
Memory	Application/Backup	32MB/512KB		
	Extension	Compact Flash card		
Functions	Real time clock	Yes, built-in		
	Variables max.	8000		
Third-party protocols supported		Siemens, Omron, Mitsubishi, Allen-Bradley (Rockwell Automation), ABB		
Communication	USB	USB Type-A (1.1) x 1		
Dimensions	External W x H x D (mm)	224 x 174 x 87.1		
Conformity to standards		EN, IEC, UL 508		
Reference	24VDC	XBT GH2460	XBT GH2460B	
Cable interface		connection with junction box		
Length		3 m	5 m	10 m
Reference		XBTZGHL3	XBTZGHL5	XBTZGHL10
Junction box		connection with PLCs		
Communication		1 SubD9 (RS232 / RS422 - RS 425) serial link, 1 Ethernet RJ45 IEEE 802.3 10/100 T-BASE		
Connection	32 pins connector	Interface cable 3 or 10 m		
	24 pins screw terminals blocks	For 24 V DC supply, state of I/O safety components		
Reference		XBTZGJBOX		

A large number of accessories (cables, memory cards, protective sheets, etc.) is available for the Advanced panels range.



Type		Characteristics		
		Standard 10" IP65	Standard 15" IP65	Stainless steel 15" IP65
Display	16 million-colour TFT touchscreen	10.4", 800x600 pixels	15" (1024 x 768 pixels)	
	Type	16 million-color TFT		16 million-color TFT, Stainless Steel
Ambient temperature		0...50 °C		
CPU		Atom Z510 1,1 Ghz Fanless		
Operating System		Windows Embedded 2009 on 2 GB CF (SLC) storage (1)		
Pre-installed software		Vijeo Designer Run Time unlimited licence, Office & PDF readers, Internet browser, .Net 3.5, Vijeo Citect web client		
Memory	RAM/SRAM (Backup)	1GB/512KB		
	Extension	SD card		
Functions	Real time clock	Yes, built-in		
	Variables max.	12000		
Third-party protocols supported		Siemens, Omron, Mitsubishi, Allen-Bradley (Rockwell Automation), ABB		
Communication	Ethernet port	x2 RJ45		
	Serial line	RS-232C (COM1)		
	USB	USB Type-A (2.0) x 3 (2 bottom side and 1 front side)		USB Type-A (2.0) x 2
Replaceable Battery		Yes		
Dimensions	External W x H x D (mm)	323 x 260 x 72	402 x 301 x 72	
	Cut-out W x H (mm)	303 x 243	383.5 x 282.5	
Conformity to standards		EN, IEC, UL 508, ISA12.12 ,CSA		
Reference	24VDC	HMIGTW5354	HMIGTW7354	HMIGTW7354S

(1) Please, upgrade to 4GB CF to run Intelligent Data Service add on

Accessories			
Set of 5 Screen Protective Sheets	MPC YK2 0SPS KIT	MPC YK5 0SPS KIT	MPC YK5 0SPS KIT
Power line filter for marine certification	–	HMIYLFIMAR11	–

Control extension for XBT GT/GK

Type of module	CANopen Master
Characteristics	Class M10 limited 16 slaves, Standard DS301 V4.02
Reference	XBTZGCANM

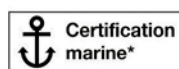

1



Type		Characteristics	
Display	LCD screen size / Resolution	5,7" / QVGA	
	Type	STN monochrome, gray	65536-color TFT
Functions	Representation of variables	Alphanumeric, bitmap, bargraph, gauge, button, light, clock, flashing light, keypad	
	Curves / Alarm logs		
Communication	Control	5 languages IEC	
	Serial link	1 Sub9 (RS 232/RS 422 - RS 485)	
Downloadable protocols	Networks	–	Ethernet, IEEE 802.3 10/100 BASE-T, RJ45
		Mitsubishi (Melsec), Omron (Sysmac), Rockwell Automation (Allen Bradley), Siemens (Sematic) Uni-TE, Modbus, Modbus TCP	
Development software		SoMachine (on Windows XP and Vista)	
Dimensions W x D x H (mm)		207 x 76 x 157	
Compatibility with PLCs		Twido, Modicon TSX Micro, Modicon Premium, Modicon Quantum, Modicon M340	
«Compact Flash» card slot		No	
USB port Host type A		1	1
Built-in Ethernet TCP/IP		No	Yes
Integrated I/O		16I/16O 24 VDC	
Extensions		3 modules TM2 or CANopen module	
Supply voltage		24 VDC	
References	Source Output	XBTGC2120T	XBTGC2330T
	Sink Output	XBTGC2120U	XBTGC2330U

Extensions

Type of module	CANopen Master	
Characteristics	Class M10 limited 16 slaves, Standard DS301 V4.02	
References	XBTZGCCAN	

Type of module	Digitals Inputs / Outputs						
Characteristics	8I 24 VDC Screw terminal	16I 24 VDC Screw terminal	16I 24 VDC HE10	32I 24 VDC HE10	8I 120 VAC Screw terminal	4I 24 VDC 40 Relays Screw terminal	16I 24 VDC 80 Relays Screw terminal
References	TM2DDI8DT	TM2DDI16DT	TM2DDI16DK	TM2DDI32DK	TM2DAI8DT	TM2DMM8DRT	TM2DMM24DRF

Type of module	Digitals Inputs / Outputs					
Characteristics	80 Transistor 24 VDC Screw terminal	160 Transistor 24 VDC HE10	320 Transistor 24 VDC HE10	80 Relays 230 VAC 30 VDC Screw terminal	160 Relays 230 VAC 30 VDC Screw terminal	
References	Source Output	TM2DD08TT	TM2DD016TK	TM2DD032TK	TM2DRA8RT	TM2DRA16RT
	Sink Output	TM2DD08UT	TM2DD016UK	TM2DD032UK	–	–

Type of module	Analog Inputs / Outputs					
Characteristics	2I Current/Voltage	2I Thermocouple	4I Current/Voltage Temperature	8I Current/Voltage	8I Temperature	8I PTC
References	TM2AMI2HT	TM2AMI2LT	TM2AMI4LT	TM2AMI8HT	TM2ARI8LRJ TM2ARI8LT	TM2ARI8HT

Type of module	Analog Inputs / Outputs				
Characteristics	1O Current/Voltage	2O Voltage	2I Current/Voltage 1O Current/Voltage	2I Temperature 1O Current/Voltage	4I Current/Voltage 2O Current/Voltage
References	TM2AMO1HT	TM2AVO2HT	TM2AMM3HT	TM2ALM3LT	TM2AMM6HT



Magelis USB accessories programmable in Vijeo Designer	Monolithic Tower Lights Ø 60 mm lens size, IP 42		Illuminated Switch IP65, Ø 22 mm mounting	Biometric Switch IP65, Ø 22 mm mounting
Description, characteristics	With 3 multi-color LEDs and a clear lens, a 2-tone buzzer (up to 85 dB), with pre-assembled USB cable for easy connection (1), USB cable clamp to ensure firm connection		5 customizable function keys with multi-LED. Soft/static F-keys or alarms acknowledgement.	Manages access to HMI data, levels of authorization, traceability of users and operations. Database management from PC
	Direct base mounting	100 mm aluminium tube mounting + fixing plate		
Compatibility with Magelis	XBT GT/GK/GC; HMI GTO		XBT GT/GK/GC; HMI GTO/GTW; iPC	XBT GT/GK/GC; HMI STU/GTO/GTW; iPC
Reference	XVGU3SWV	XVGU3SHAV	HMIZRA1	XB5S5B2L2

(1) For connection to HMI, use either the Schneider Electric USB cable (BMXXCAUSBH018) or a third-party USB Type A/mini B cable of maximum length 4 m/13.12 ft.

Advanced Panels Accessories			
Type of accessories	Description or function	Type of terminal	Reference
Blank memory cards, industrial grade	Compact Flash 2 GB	XBT GT/GK; HMI GTW	HMIYCF0211
	Compact Flash 4 GB	HMI GTW only	HMIYCF0411
	Compact Flash 8 GB	HMI GTW only	HMIYCF0811
	SD card 4 GB	HMI GTO/GTW	HMI ZSD 4G
Remote USB port for terminals	Enables the USB port to be located remotely on the rear of the XBT terminal on a panel or enclosure door (Ø 21 mm fixing device)	For USB type A port	XBT ZGUSB
		For USB mini-B port	HMI ZSUSBB
USB fastenings Sold in lots of 5	Holds the USB connection in place	GT2**0 / GT4**0	XBT ZGCLP1
		GT5**0 / GT6**0 / GT7**0	XBT ZGCLP2
		XBT GK	XBT ZGCLP3
		HMI GTO/STO (USB type A)	HMI ZGCLP1
		HMI GTO/STO (USB type mini-B)	HMI ZSCLP3
Cables for application transfer - Terminal to PC		USB Type A - PC	XBT ZG935
		USB mini-B - PC	BMX XCAUSBH018
Serial printer cable for XBT GT/GK/GTW terminals and HMI GTO panels			HMI ZURS
Serial link isolation units	RS 232C/RS 485 (COM1) and RS 485 (COM2)	XBT GT2...0 to XBT GT7340; XBT GK;	XBT ZGI232
		HMI GTO	XBT ZGI485
Stylus, Sold in lots of 5			XBT ZGPEN

Connection of Magelis terminals to fieldbuses			
Type of bus/ network	Connection components	Type of terminal	Reference
FIPWAY, FIPIO	USB gateway	XBT GT / GK - HMI GTO	TSXCUSBFIP
Modbus Plus	USB gateway	XBT GT / GK - HMI GTO	XBTZGUMP
		HMIGTW	TSXCUSBMBP
Profibus DP	Car on expansion bus	XBT GT / GK (1)	XBTZGPDP
Device Net	Car on expansion bus	XBT GT / GK (1)	XBTZGDVN

Serial connection from HMI terminals to PLC/Drives (1)				
Type of PLC/Drives	Type of terminal	Connector/ Physical link	Length	Reference
Twido, Premium, Micro	XBT GT / GK - HMI GTO (COM1)	Mini-DIN/RS232		TSX PCX 1031
M238/M258/M340, ATS, ATV	XBT GT / GK - HMI GTO (COM2)	RJ45/RS485	2.5m	XBT Z9980
ATV, ATS	XBT GT / GK - HMI GTO (COM2)	RJ45/RS485	1m	VW3A8306R10
M340	USB	USB mini-B	1.8m	BMX XCAUSBH018
Siemens S7, Simatic MPI	XBT GT / GK - HMI GTO (COM1)	9-way SUB-D/RS232		XBT ZG9292
Siemens S7, Simatic PPI & MPI	XBT GT / GK - HMI GTO (COM2)	9-way SUB-D/RS485		XBT ZG9721
Rockwell, DF1-Full Duplex; Mitsubishi A Link	XBT GT / GK - HMI GTO (COM1)	25-way SUB-D/RS232		XBT ZG9731
XBT ZG9740,	XBT GT / GK - HMI GTO (COM1)	9-way SUB-D/RS232		XBT ZG9740
Mitsubishi FX CPU	XBT GT / GK - HMI GTO (COM1)	Mini-DIN 8/RS232		HMI Z951
Mitsubishi Q Link	XBT GT / GK - HMI GTO (COM1)	9-way SUB-D/RS232		XBT ZG9772
Mitsubishi Q CPU	XBT GT / GK - HMI GTO (COM1)	8-way mini-DIN/RS232		XBT ZG9774

(1) For the full list of connection accessories, please consult our site <http://www.schneider-electric.com>.



1

Box PC Universal

CPU & RAM types	Atom N270 1,6 Ghz Fanless with DDR2 RAM				
PCI Slots	1 PCI		2 (1 PCI + 1 PCIe)		
Operating System	WES 2009		XP PRO SP3		
Storage	CF >= 4Gb (SLC)	Flash disk SSD >= 60Go (5 year warranty)	HDD >= 500Go	Flash disk SSD >= 60Go (5 year warranty)	HDD >= 500Go
Integrated DVD-RW	-				1
Slide-in	1 for storage		1 for storage + 1 for DVD-RW (or for storage with adapter)		
Power supply	24V DC				
Integrated ports	2 Ethernet Gigabit, 5 USB, 2 RS232, 1 DVI				
Optional	Battery-backup*, additional RS232/485 port, additional DVI for Box PC 2 slots, redundant RAID HDD by PCI				
Overall dimensions W x H x D (mm)	82 x 270 x 251		121 x 270 x 251		
Industrial Certifications	CE, UL508 industrial control, cUL, ANSI/ISA 12.12.01 for hazardous locations, Gost, C-Tick				
Marine certification	Germany Loyd with power filter	-	Germany Loyd with power filter	-	
Vijeo Designer	Vijeo Designer Run Time demo. Unlimited licence to be ordered separately (VJDSNRTMPC)				
1GB RAM	HMIBUCND1E01	HMIBUFND1P01	HMIBUHND1P01	HMIBUFND2P01	HMIBUHND2P01
Vijeo Citect Full 500 I/O, 2Gb RAM	-	HMIBUFND17F1		HMIBUFND2PF1	-

Configured iPC service

*Other configurations on request. Please consult our Customer Care Center.



Box PC Performance

CPU & RAM types	Core 2 Duo 2,26 Ghz Fan, with DDR3 RAM				
PCI Slots	2 (1 PCI + 1 PCIe)		5 (2 PCI + 3 PCIe)		
Operating System	Windows 7 64 bits Ultimate				
Storage	Flash disk SSD >= 60Go (5 year warranty)	HDD >= 500Go	Flash disk SSD >= 60Go (5 year warranty)	HDD >= 500Go	
Integrated DVD-RW	1				
Slide-in	1 for storage + 1 for DVD-RW (or for storage with adapter)				
Power supply	24V DC				
Integrated ports	2 Ethernet Gigabit, 5 USB, 2 RS232, 1 DVI				
Optional	Battery-backup*, additional RS232/485 port, additional DVI, redundant RAID HDD by PCI				
Overall dimensions W x H x D (mm)	121 x 270 x 251		217 x 270 x 251		
Industrial Certifications	CE, UL508 industrial control, cUL, ANSI/ISA 12.12.01 for hazardous locations, Gost, C-Tick				
Marine certification	-				
Vijeo Designer	Vijeo Designer Run Time demo. Unlimited licence to be ordered separately (VJDSNRTMPC)				
2Gb RAM	HMIBPFDD2701	HMIBPHDD2701	HMIBPFDD5701	HMIBPHDD5701	
Vijeo Citect Full 500 I/O, 4Gb RAM	HMIBPFDD27F1	-	HMIBPFDD57F1	-	

Configured iPC service

*Other configurations on request. Please consult our Customer Care Center.



	15" touch & keypad	15" touch	15" touch	19" touch
Touchscreen	15" LCD TFT	15" LCD TFT	15" LCD TFT	19" LCD TFT
Resolution	XGA 1024x768	XGA 1024x768	XGA 1024x768	SXGA 1280x1024
Front side port	1 x USB			
Video ports	1 x VGA & 1 x DVI			
Touchscreen ports	1 x USB & 1 x RS 232			
Certification	UL508, CSA	UL508, CSA	UL508, CSA, Marine GL	UL508, CSA
Overall dimensions W x H x D (mm)	483 x 65 x 365	395 x 60 x 294	395 x 60 x 294	460 x 65 x 390
References	AC	MPCNB50NAN00N	MPCYT50NAN00N	MPCYT90NAN00N
	DC	–	–	HMIDID7DT0

PC Panel Magelis Panel PC 10", 15"



	Optimum Panel PC 10"	Optimum Panel PC 15"	Optimum Panel PC 15" with aluminium bezel
Touch screen	10" LCD TFT with LED, IP65	15" LCD TFT with LED, IP65	
Resolution	SVGA 800x600, 16 Million colors	XGA 1024x768, 16 Million colors	
CPU	Atom Z510 1,1 Ghz Fanless		
Operating System	WES 2009		
RAM	1 GB DDR2		
OS storage	CF 2Gb (SLC)	CF 4Gb (SLC)	
User storage	SD card		
Power supply	24V DC		
Intergated ports	2 x Ethernet Gigabit, 1 USB front + 2 USB, 1 RS232		2xEthernet Gigabit, 2xUSB, 1xRS232
Overall dimensions W x H x D (mm)	323 x 260 x 72	402 x 301 x 72	
Industrial Certifications	CE, UL508 industrial control, cUL, ANSI/ISA 12.12.01 for hazardous locations, Gost, C-Tick, IP65 Nema 4X indoor		ATEX II 3 gas and dust zone 2/22 et EN1672-2 (Food processing machines) FDA 21 CFR 177.2006 (US standard Flat seals).
Marine certification	Germany Loyd with power filter		
Software	Office & PDF readers, Internet browser, .Net 3.5, Vijeo Designer RT demo (Unlimited licence to be ordered separately VJDSNRTMPC), Vijeo Citect web client		
Part number	HMIPWC5D0E01	HMIPWC5D0E01A	HMIPWC7D0E01 HMIPV7D0E01

Configured iPC service

*Other configurations on request. Please consult our Customer Care Center.



Panel PC Universal 15"

Touch screen	15" LCD TFT with LED backlight, IP65, same cut-out than legacy				
Resolution	XGA 1024x768, 16 Million colors				
CPU & RAM types	Atom N270 1,6 Ghz Fanless with DDR2 RAM				
PCI Slots	-				2 (1 PCI + 1 PCIe)
Operating System	WES 2009	XP PRO SP3			
Storage	CF >= 4Go (SLC)	Flash disk SSD >= 60Go (5 year warranty)	HDD >= 500Go	Flash disk SSD >= 60Go (5 year warranty)	HDD >= 500Go
Integrated DVD-RW	-				1
Slide-in	1 for storage				1 for storage + 1 for DVD-RW (or for storage with adapter)
Integrated ports	2 Ethernet Gigabit, 1 front USB + 4 USB, 2 RS232, 1 DVI				
Optional	Battery-backup*, additional RS232/485 port*				+ redundant RAID HDD by PCI
Overall dimensions W x H x D (mm)	402 x 301 x 104				402 x 301 x 153
Industrial Certifications	CE, UL508 industrial control, cUL, ANSI/ISA 12.12.01 for hazardous locations, Gost, C-Tick,				
Marine certification	Germany Loyd with power filter	-			
Vijeo Designer	Vijeo Designer Run Time demo. Unlimited licence to be ordered separately (VJDSNRTMPC)				
1GB RAM - DC power supply	HMIPUC7D0E01	HMIPUF7D0P01	HMIPUH7D0P01	-	HMIPUH7D2P01
Vijeo Citect Lite 1200 I/O, 2Gb RAM - DC	-	HMIPUF7D0PL1	-	-	-
1Gb RAM - AC power supply	-	HMIPUF7A0P01	HMIPUH7A0P01	HMIPUF7A2P01	HMIPUH7A2P01
Vijeo Citect Full 500 I/O, 2Gb RAM - AC	-	-	-	HMIPUF7A2PF1	-

Configured iPC service

*Other configurations on request. Please consult our Customer Care Center.



Panel PC Performance 15"

Touch screen	15" LCD TFT with LED backlight, IP65, same cut-out than legacy				
Resolution	XGA 1024x768, 16 Million colors				
CPU & RAM types	Core 2 Duo 2,26 Ghz Fan, with DDR3 RAM				
PCI Slots	-				2 (1 PCI + 1 PCIe)
Operating System	Windows 7 64 bits Ultimate				
Storage	Flash disk SSD >= 60Go (5 year warranty)	HDD >= 500Go	Flash disk SSD >= 60Go (5 year warranty)	HDD >= 500Go	
Integrated DVD-RW	-				1
Slide-in	1 for storage				1 for storage + 1 for DVD-RW (or for storage with adapter)
Integrated ports	2 Ethernet Gigabit, 1 front USB + 4 USB, 2 RS232, 1 DVI				
Optional	Battery-backup*, add. RS232/485 port*				+ redundant RAID HDD by PCI
Overall dimensions W x H x D (mm)	402 x 301 x 118				402 x 301 x 168
Industrial Certifications	CE, UL508 industrial control, cUL, ANSI/ISA 12.12.01 for hazardous locations, Gost, C-Tick,				
Vijeo Designer	Vijeo Designer Run Time demo. Unlimited licence to be ordered separately (VJDSNRTMPC)				
2Gb RAM - DC power supply	HMIPPF7D0701	HMIPPH7A0701	-	HMIPPH7D2701	
2Gb RAM - Battery back-up interface - DC	-	-	-	HMIPPH7B2701	
Vijeo Citect Full 500 I/O, 4Gb RAM - DC	HMIPPF7D07F1	-	-	-	
2Gb RAM - AC power supply	-	HMIPPH7D0701	HMIPPF7A2701	HMIPPH7A2701	
Vijeo Citect Full 500 I/O, 4Gb RAM - AC	-	-	HMIPPF7A27F1	-	

Configured iPC service

*Other configurations on request. Please consult our Customer Care Center.



Panel PC Universal 19"

19" LCD TFT with LED backlight, IP65				
SXGA 1280x1024, 16 Million colors				
Atom N270 1,6 Ghz Fanless with DDR2 RAM				
–				2 (1 PCI + 1 PCIe)
WES 2009	XP PRO SP3			
CF =< 4Gb (SLC)	Flash Disk =<32Go (SSD SLC)	HDD =<250Go	Flash Disk =<32Go (SSD SLC)	HDD =<250Go
–				1
1 for storage				1 for storage + 1 for DVD-RW (or for storage with adapter)
2 Ethernet Gigabit, 1 front USB + 4 USB, 2 RS232, 1 DVI				
Battery-backup*, additional RS232/485 port*			+ redundant RAID HDD by PCI	
480 x 380 x 114			480 x 380 x 153	
CE, UL508 industrial control, cUL, ANSI/ISA 12.12.01 for hazardous locations, Gost, C-Tick, Germany Loyd with power filter				
Vijeo Designer Run Time demo. Unlimited licence to be ordered separately (VJDSNRTMPC)				
HMIPUC9D0E01	HMIPUF9D0P01	HMIPUH9D0P01	–	HMIPUH9D2P01
–	HMIPUF9D0PF1	–	–	–
–	–	HMIPUH9A0P01	HMIPUF9A2P01	HMIPUH9A2P01
–	–	–	HMIPUF9A2PF1	–

*Other configurations on request. Please consult our Customer Care Center.



Panel PC Performance 19"

19" LCD TFT with LED backlight, IP65				
SXGA 1280x1024, 16 Million colors				
Core 2 Duo 2,26 Ghz Fan, with DDR3 RAM				
–				2 (1 PCI + 1 PCIe)
Windows 7 64 bits Ultimate				
Flash Disk =<32Go (SSD SLC)	HDD =<250Go	Flash Disk =<32Go (SSD SLC)	HDD =<250Go	
–				1
1 for storage				1 for storage + 1 for DVD-RW (or for storage with adapter)
2 Ethernet Gigabit, 1 front USB + 4 USB, 2 RS232, 1 DVI				
Battery-backup*, add. RS232/485 port*			+ redundant RAID HDD by PCI	
480 x 380 x 129			480 x 380 x 168	
CE, UL508 industrial control, cUL, ANSI/ISA 12.12.01 for hazardous locations, Gost, C-Tick, Vijeo Designer Run Time demo. Unlimited licence to be ordered separately (VJDSNRTMPC)				
HMIPPF9D0701	HMIPPH9D0701	–	HMIPPH9D2701	
–	–	–	–	
HMIPPF9D07F1	–	–	–	
–	HMIPPH9A0701	HMIPPF9A2701	HMIPPH9A2701	
–	–	HMIPPF9A27F1	–	

*Other configurations on request. Please consult our Customer Care Center.

Vijeo Designer configuration software enables creation of automated system control operator dialogue applications for Magelis STO/STU, XBT GT, GK, GTW, GH, GTO terminals, Box PC and Panel PC.

Configuration

Vijeo Designer configuration software enables fast, simple processing of operator dialogue projects thanks to its ergonomics, developed around 6 configurable windows.

It also offers comprehensive application management tools:

- . Project creation (one or several targets).
- . Recipe editor
- . User action list (eg. script) for application adaptability.
- . Vectorial graphic library for more attractive graphic screens.
- . Simulation mode for simple design office application testing.
- . High-performance graphic editor for simple block diagram creation (over 30 animated preconfigured generic objects).
- . Data sharing (up to 300 variables on 8 terminals).
- . Management of 40 alphabets with the opportunity to have 15 languages per application and dynamic change.
- . Programmable controller database sharing (Unity Pro, PL7, Concept, TwidoSoft, ProWORX, ModSoft), process variables or operators actions
- . Advanced traceability function (periodic, at event or on request).
- . Event-triggered e-mail function
- . Over 35 third party protocols
- . Printing function
- . Multilingual software : English, French, German, Italian, Spanish, Portuguese and Simplified Chinese.

The Vijeo Designer Limited Edition, free access allows you to configure the Magelis STO/STU.

Industrial intelligence option: Intelligent Data Service

Intelligent Data Service (IDS) is an extension of Vijeo Designer for the PC (Magelis or standard PC) which supports the implementation of control solutions for one or a number of terminals (up to 8). This extension offers total traceability. Both process variables and operator actions are tracked so that the right decisions can be made at the right time (Industrial Business Intelligence). Powerful Data can be collected from multiple terminals via Ethernet without impairing HMI reaction times.

Flexible Various storage methods are supported, CSV file can be read directly in MS Excel, recording in user-defined format in an SQL database or secure IDV (Intelligent Data Vault) files to ensure compatibility with the requirements of 21 CFR Part 11.

Intelligent Data Service Report Printing option

Intelligent Data Service (IDS) Report Printing is an extension of Intelligent Data Service for the PC (Magelis or Standard PC).

This extension allows you to create new reports "from scratch" and link them to IDS data.

In addition to editing functions, IDS Report Printing allows you to preview the report before printing, print it or save it to file on disk.

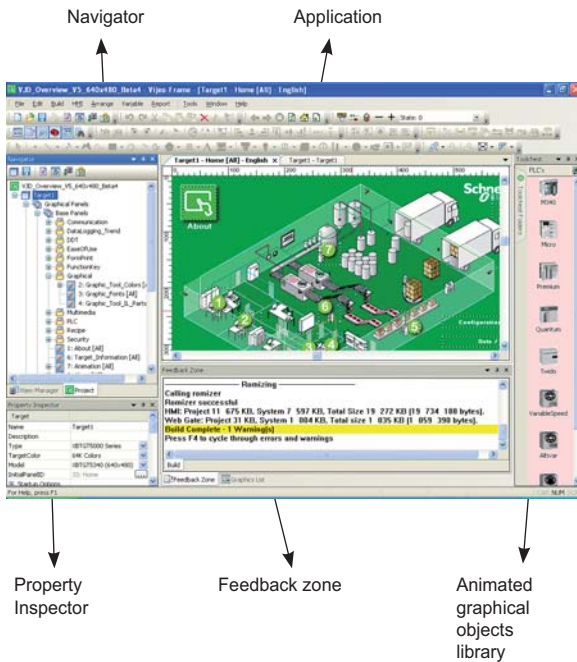



Vijeo Designer



Vijeo Designer IDS

Selection guide for Vijeo Designer

Number of licences	Composition	References
Single (1)	No cable With USB cable	VJDSNDTGSV●●M VJDSUDTGSV●●M
Group (3)	No cable	VJDGNDTGSV●●M
Team (10)	No cable	VJDTNDTGSV●●M
Facility (Unlimited)	No cable	VJDFNDTGSV●●M

The software is supplied on DVD and runs under Windows® XP and Windows 7.

●● represent the version number.

Run Time on Magelis iPC

Single (1)	VJDSNRTMPC
------------	------------

Run Time Intelligent Data Service

Single (1)*	VJDSNTRCKV●●M
-------------	---------------

* Need a registered Run Time for Magelis iPC

Run Time Intelligent Data Service Report Printing

Single (1)*	VJDSNTRPR●●M
-------------	--------------

* Need a registered Run Time for Intelligent Data Service

Remote access

Vijeo Design'Air is Schneider Electric's application for Android and iOS tablets and smartphones. This feature enables you to remotely connect to an HMI terminal over a WiFinetwork and have a graphical view of the HMI terminal on your tablet and smartphone.

> HMI AUTO-DETECT

Vijeo Design'Air scans and detects available on HMI terminals on a nearby network

> REMOTE MONITORING

Vijeo Design'Air connects tablets and smartphones to HMI terminals, and allows remote viewing and controlling of HMI projects at run time.

> ADVANCED SCREEN

Vijeo Design'Air takes advantage of the advanced graphic and multi-touch capabilities of tablets and smartphones and applies it to the automation industry.



Vijeo Design'Air

What is an explosive atmosphere according to the Directive?

It is the mixing with air, in atmospheric conditions, of flammable substances in the form of gas, vapour, mist or dust which, in the event of combustion, spreads throughout the non burning mix.

1

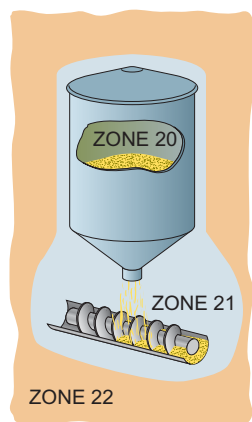

Implementation of European Directives

> Directive 99/92/EC

This requires that a risk analysis be performed for all industrial processes.

If there is any risk of an explosion:

- the zones are defined and physically identified,
- the installation is classified by governing bodies.

> Directive 94/9/EC

This requires certification of the products in accordance with the classification of the zones of use.

> Dust zones

- Zone 20: area where an explosive atmosphere exists in the form of combustible clouds of dust in the air, either permanently, for long periods or frequently.
- Zone 21: area where an explosive atmosphere exists in the form of combustible clouds of dust in the air during normal operation occasionally.
- Zone 22: area where an explosive atmosphere in the form of combustible clouds of dust in the air is unlikely to occur during normal operation but, if it does occur, it is only for a short period.



Small Panel Magelis XBT N with matrix screen (1)



Type		Characteristics				
Conformity		Directive ATEX 94/9/CE, EN 60079-15, EN 50281-1-1 + A1, IEC 61241-0, EN 61241-1				
Zone D (dust)		22				
EC type examination certificate number / marking		INERIS 05ATEX3016X / II 3 G D EEx nA nC IIC T5 - Ex tD A22 IP65 T100°C				
Display	Capacity	2 lines, 20 characters		1 to 4 lines, 5 to 20 characters		
	Type	Back-lit LCD green		Back-lit LCD 3 colours green, orange, red	Back-lit LCD green	
Data entry		Via keypad with 8 keys (4 customizable keys)				
Function	Representation of variables	Alphanumeric				
	Alarm log	No	Yes	Yes	Yes	Yes
Communication	Serial link	1 RJ45 (RS 232 - RS 485)		1 Sub-D25 (RS 232 - RS 485)		
Downloadable protocols		Uni-TE, Modbus Master		Uni-TE, Modbus Master, Siemens, Rockwell, Omron, Mitsubishi		
Development software		Vijeo Designer Lite (on Windows 2000 and XP)				
Overall dimensions W x H x D (mm)		132 x 37 x 74				
Compatibility with PLCs		Twido, Modicon TSX Micro, Modicon Premium, Modicon M340		Twido, Modicon TSX Micro, Modicon Premium, Modicon Quantum, Modicon Momentum, Modicon M340		
Supply voltages		5 VDC or PLC power supply		24 VDC		
References		XBTN200	XBTN400	XBTN410	XBTN401	XBTNU400

(1) Except XBTN200: alphanumeric screen.



Type		Characteristics				
Conformity		Directive ATEX 94/9/CE, EN 60079-15, EN 61241-0, EN 61241-1, EN 60079-0 (1)				
Zone D (dust)		22				
EC type examination certificate number / marking		INERIS 06ATEX3024X / INERIS 08ATEX3024X / INERIS 06ATEX3024X / INERIS 08ATEX3024X / INERIS 08ATEX3024X /  II 3 G D EEx nA nC IIC T4 - Ex tD A22 IP64 T135°C				
Display	LCD screen size	3.8"				
	Type	STN monochrome, amber or red			TFT colour	
Functions	Representation of variables	Alphanumeric, bitmap, bargraph, gauge, button, light, clock, flashing light, keypad				
	Curves / Alarm logs	Yes, with log / Yes, incorporated				
Communication	Serial link	1 RJ45 (RS 232 - RS 485)				
	Networks	-		Ethernet, IEEE 802.3 10 BASE-T, RJ45	Ethernet, IEEE 802.3 10/100 BASE-T, RJ45	
Downloadable protocols		Mitsubishi (Melsec), Omron (Sysmac), Rockwell Automation (Allen Bradley), Siemens (Simatic) Uni-TE, Modbus, Modbus TCP				
Development software		Vijeo Designer VJD●●●TG●V●●M (on Windows Vista, XP and 2000)				
Overall dimensions W x H x D (mm)		130 x 41 x 104				
Compatibility with PLCs		Twido, Modicon TSX Micro, Modicon Premium, Modicon Quantum, Modicon M340				
«Compact Flash» card slot		No				
USB port		-	1	-	1	1
Built-in Ethernet TCP/IP		No		Yes		
Supply voltage		24 VDC				
References		XBTGT1100	XBTGT1105	XBTGT1130	XBTGT1135	XBTGT1335

(1) Does not take effect for XBTGT1100 and XBTGT1130

Magelis XBT GT with 5.7" touchscreen



Type		Characteristics				
Conformity		Directive ATEX 94/9/CE, EN 60079-15, EN 61241-0, EN 61241-1				
Zone D (dust)		22				
EC type examination certificate number / marking		INERIS 06ATEX3024X /  II 3 G D EEx nA nC IIB T3 - Ex tD A22 IP64 T200°C				
Display	LCD screen size	5.7"				
	Type	Back-lit STN, monochrome blue black and white		STN, colour 4096 colours	TFT, colour 65536 colours	
Functions	Representation of variables	Alphanumeric, bitmap, bargraph, gauge, button, light, clock, flashing light, keypad				
	Curves / Alarm logs	Yes, with log / Yes, incorporated				
Communication	Serial link	1 Sub-D9 (RS 232/RS 422 - RS 485) + 1 RJ45 (RS 485)				
	Networks	-		Ethernet, IEEE 802.3 10/100 BASE-T, RJ45	Ethernet, IEEE 802.3 10/100 BASE-T, RJ45	
Downloadable protocols		Mitsubishi (Melsec), Omron (Sysmac), Rockwell Automation (Allen Bradley), Siemens (Simatic) Uni-TE, Modbus, Modbus TCP/IP				
Development software		Vijeo Designer VJD●●●TG●V●●M (on Windows Vista, XP and 2000)				
Overall dimensions W x H x D (mm)		167.5 x 60 x 135				
Compatibility with PLCs		Twido, Modicon TSX Micro, Modicon Premium, Modicon Quantum, Modicon M340, Modicon Momentum				
«Compact Flash» card slot		No	Yes			
USB port		1				
Video in		No				
Built-in Ethernet TCP/IP		No	No	Yes	No	Yes
Supply voltage		24 VDC				
References		XBTGT2110	XBTGT2120	XBTGT2130	XBTGT2220	XBTGT2330

1



Type		Characteristics										
Conformity		Directive ATEX 94/9/CE, EN 60079-15, EN 61241-0, EN 61241-1										
Zone D (dust)		22										
EC type examination certificate number / marking		INERIS 06ATEX3024X / II 3 G D EEx nA nC IIB T4 - Ex tD A22 IP64 T135°C					INERIS 06ATEX3024X / II 3 D Ex tD A22 IP64 T135°C					
Display	LCD screen size	7.5"			10.4"			12.1"		15"		
	Type (colour)	STN	TFT	TFT	STN	TFT	TFT	TFT	TFT	TFT		
	Number of colours	4096	65536	65536	4096	65536	65536	65536	65536	65536		
Functions	Representation of variables	Alphanumeric, bitmap, bargraph, gauge, button, light, clock, flashing light, keypad										
	Curves / Alarm logs	Yes, with log / Yes, incorporated										
Communication	Serial link	1 Sub-D9 (RS 232/RS 422 - RS 485) + 1 RJ45 (RS 485)										
	Networks	Ethernet, IEEE 802.3 10/100 BASE-T, RJ 45										
Downloadable protocols		Mitsubishi (Melsec), Omron (Sysmac), Rockwell Automation (Allen Bradley), Siemens (Sematic) Uni-TE, Modbus, Modbus TCP/IP										
Development software		Vijeo Designer VJD●●●TG●V●●M (on Windows Vista, XP and 2000)										
Overall dimensions W x H x D (mm)		215 x 60 x 170			313x56x239		271 x 57 x 213		313 x 56 x 239		395x60x294	
Compatibility with PLCs		Twido, Modicon TSX Micro, Modicon Premium, Modicon Quantum, Modicon M340										
«Compact Flash» card slot		Yes										
USB port		1	1	1	2	2	2	2	2	2	2	
Video in		No	No	Yes	No	No	Yes	No	Yes	Yes	Yes	
Built-in Ethernet TCP/IP		Yes										
Supply voltage		24 VDC										
References		XBTGT4230	XBTGT4330	XBTGT4340	XBTGT5230	XBTGT5330	XBTGT5340	XBTGT6330	XBTGT6340	XBTGT7340		

Notes

Zelio

Designed for hard-wired logic control applications to complement PLCs when performing simple functions such as counting, measurement and control, the single-function products in the Zelio range of relays offer optimum results.

Designed for the management of simple automation systems, Zelio Logic smart relays provide a real alternative to solutions based on cabled logic or specific cards.



2

The challenges of industrial competitiveness mean that control systems are now present in all fields of application. To meet your requirements, Schneider Electric has a very comprehensive offer of automation products, for all sectors of activity. Benefit from high performance, efficient and environmentally friendly products that are designed to reduce your energy costs and increase the safety of personnel and equipment.



Modicon

From the simplest machine to the smartest industrial process, Modicon automation platforms improve performance, quality and profitability for your installations. Conforming to international standards and simple to set up, the Modicon range integrates seamlessly into any control system.

2 | Automation



This document is a selection
of the top selling products.

For more information:
<http://www.schneider-electric.com>

2

Relays

Electromechanical plug-in relays, Zelio Relay	2/2 to 2/4
Solid-state relays, Zelio Relay	2/5
Measurement and control relays, Zelio Control	2/6 to 2/10
Counters, Zelio Count	2/11
Timing relays, Zelio Time	2/12 to 2/13
Analog interface, Zelio Analog	2/14 to 2/15

Controllers (PLC) for commercial machines

Smart relays, Zelio Logic : 10 to 40 I/O	2/16 to 2/17
Programmable controllers, Twido : 10 to 100 I/O 1µs per Instruction	2/18 to 2/19

Controllers (PLC and PAC) for industrial machines

Logic controllers, Modicon M238 : 20 to 248 I/O, 0.3 µs per Instruction	2/20 to 2/21
Logic controllers, Modicon M258 : 42 to 2400 I/O, 0.022 µs per Instruction	2/22 to 2/23
Motion controllers, Modicon LMC058 : 42 to 2400 I/O, 4 synchronized Axis in 2ms	2/24
I/O expansion modules for Modicon M238, M258 and LMC058	2/21 and 2/23
HMI controllers, Magelis XBTGC : 18 to 96 I/O	2/25
Drive controller, Altivar IMC : 1000 instructions in 942 µs Web Server, CANopen, PLCopen	2/26

Programmable Automation Controllers (PACs)

Mid range PLC Modicon M340 : for industrial process and infrastructure	2/28 to 2/37
Large PLC Modicon Premium : for discrete or process applications and high availability solutions	2/38 to 2/45
Large PLC Modicon Quantum : for process applications and high availability solutions	2/46 to 2/53

Software

Programming software, Zelio Soft 2	2/17
Programming software, Twido Suite	2/19
Machine programming software, SoMachine	2/27
Configuration software, Unity Pro	2/54 to 2/55
Programming software, PL7, Concept, ProWORX32	2/56 to 2/57
SCADA software, Vijeo Citect	2/58
Reporting software, Vijeo Historian	2/59



Type of relay	Interface relays RSB			Miniature relays RXM			
Contact characteristics							
Thermal current I _{th} in A (temperature ≤ 55°C)	8	12	16	12	10	6	3
Number of contacts	2 "C/O"	1 "C/O"	1 "C/O"	2 "C/O"	3 "C/O"	4 "C/O"	4 "C/O"
Contact material	AgNi	AgNi	AgNi	AgNi	AgNi	AgNi	AgAu
Switching voltage, min. / max.	5 / 250 VAC/DC			12 / 250 VAC/DC			
Switching capacity, min. / max. (mA / VA)	5 / 2000	5 / 3000	5 / 4000	10 / 3000	10 / 2500	10 / 1500	2 / 1500
Coil characteristics							
Average consumption, inrush,	0.75 VA / 0.45 W			1.2 VA / 0.9 W			
Permissible voltage variation	0.8/0.85...1.1 Un (50/60Hz or =)			0.8...1.1 Un (50/60Hz or =)			
References	(1)	(1)	(1)	(2)	(2)	(2)	
Coil supply voltage on DC	6 VDC	RSB2A080RD	RSB1A120RD	RSB1A160RD	–	–	–
	12 VDC	RSB2A080JD	RSB1A120JD	RSB1A160JD	RXM2AB2JD	RXM3AB2JD	RXM4AB2JD
	24 VDC	RSB2A080BD	RSB1A120BD	RSB1A160BD	RXM2AB2BD	RXM3AB2BD	RXM4AB2BD
	48 VDC	RSB2A080ED	RSB1A120ED	RSB1A160ED	RXM2AB2ED	RXM3AB2ED	RXM4AB2ED
	60 VDC	RSB2A080ND	RSB1A120ND	RSB1A160ND	–	–	–
110 VDC	RSB2A080FD	RSB1A120FD	RSB1A160FD	RXM2AB2FD	RXM3AB2ED	RXM4AB2ED	
Coil supply voltage on AC	24 VAC	RSB2A080B7	RSB1A120B7	RSB1A160B7	RXM2AB2B7	RXM3AB2B7	RXM4AB2B7
	48 VAC	RSB2A080E7	RSB1A120E7	RSB1A160E7	RXM2AB2E7	RXM3AB2E7	RXM4AB2E7
	120 VAC	RSB2A080F7	RSB1A120F7	RSB1A160F7	RXM2AB2F7	RXM3AB2F7	RXM4AB2F7
	220 VAC	RSB2A080M7	RSB1A120M7	RSB1A160M7	–	–	–
	230 VAC	RSB2A080P7	RSB1A120P7	RSB1A160P7	RXM2AB2P7	RXM3AB2P7	RXM4AB2P7
	240 VAC	RSB2A080U7	RSB1A120U7	RSB1A160U7	–	–	RXM4GB2U7

Sockets for relays

Type of socket	For interface relays RSB			For miniature relays RXM			
Mixed input/output type sockets with location for protection module							
	–	–	–	RXZE2M114(5)	–	RXZE2M114	RXZE2M114
	–	–	–	RXZE2M114M(5)	–	RXZE2M114M	RXZE2M114M
Separate input/output type sockets with location for protection module							
		RSZE1S48M	RSZE1S35M	RSZE1S48M(3)	RXZE2S108M	RXZE2S111M	RXZE2S114M
Protection modules							
Diode	6...230 VDC	RZM040W			RXM040W		
RC circuit	24...60 VAC	RZM041BN7			RXM041BN7		
	110...240 VAC	RZM041FU7			RXM041FU7		
Varistor	6...24 VDC or AC	RZM021RB (6)			RXM021RB		
	24...60 VDC or AC	RZM021BN (6)			RXM021BN		
	110...230 VDC or AC	RZM021FP (6)			RXM021FP		
	24 VDC or AC	–			–		
	240 VDC or AC	–			–		
Multifunction timer module	24...230 VDC or AC	–			–		
Accessories							
Plastic maintaining clamp		RSZR215			RXZR335		
Metal maintaining clamp		–			RXZ400		
Label for socket		RSZL300			RXZL420 (except RXZE2M114)		
Bus jumper	2 poles	–			RXZS2		
DIN rail adapter		–			RXZE2DA		
Panel mounting adapter		–			RXZE2FA		

(1) References for relays without socket, for relays with socket, add the letter **S** to the end of the selected reference. (Example: RSB2A080B7 becomes RSB2A080B7S).

(2) References for relays with LED, for relays without LED, replace the number 1 in the reference by **2**. (Example: RXM2AB2JD becomes RXM2AB1JD)

(3) To use RSB 1A160 ●● relay with socket, terminals must be interconnected

Universal and power relays



Universal relays RUM					Power relays RPM				RPF	
Cylindrics		Faston								
10	10	3	10	10	15	15	15	15	30 (4)	30 (4)
2 "C/O"	3 "C/O"	3 "C/O"	2 "C/O"	3 "C/O"	1 "C/O"	2 "C/O"	3 "C/O"	4 "C/O"	2 "N/O"	2 "C/O"
AgNi	AgNi	AgAu	AgNi	AgNi	AgNi	AgNi	AgNi	AgNi	AgSnO ₂	AgSnO ₂
12 / 250 VAC/DC					12 / 250 VAC/DC				12 / 250 VAC/DC	
10 / 2500	10 / 2500	3 / 750	10 / 2500	10 / 2500	100 / 3750	100 / 3750	100 / 3750	100 / 3750	100 / 7200	100 / 7200
2...3 VA / 1.4 W					0.9 VA / 0.7 W	1.2 VA / 0.9 W	1.5 VA / 1.7 W	1.5 VA / 2 W	4 VA / 1.7 W	
(2)	(2)	–	(2)	(2)	(2)	(2)	(2)	(2)	–	–
–	–	–	–	–	–	–	–	–	–	–
RUMC2AB2JD	RUMC3AB2JD	–	RUMF2AB2JD	RUMF3AB2JD	RPM12JD	RPM22JD	RPM32JD	RPM42JD	RPF2AJD	RPF2BJD
RUMC2AB2BD	RUMC3AB2BD	RUMC3GB2BD	RUMF2AB2BD	RUMF3AB2BD	RPM12BD	RPM22BD	RPM32BD	RPM42BD	RPF2ABD	RPF2BBD
RUMC2AB2ED	RUMC3AB2ED	RUMC3GB2ED	RUMF2AB2ED	RUMF3AB2ED	RPM12ED	RPM22ED	RPM32ED	RPM42ED	–	–
–	–	–	–	–	–	–	–	–	–	–
RUMC2AB2FD	RUMC3AB2FD	–	RUMF2AB2FD	RUMF3AB2FD	RPM12FD	RPM22FD	RPM32FD	RPM42FD	RPF2AFD	RPF2BFD
RUMC2AB2B7	RUMC3AB2B7	RUMC3GB2B7	RUMF2AB2B7	RUMF3AB2B7	RPM12B7	RPM22B7	RPM32B7	RPM42B7	RPF2AB7	RPF2BB7
RUMC2AB2E7	RUMC3AB2E7	RUMC3GB2E7	RUMF2AB2E7	RUMF3AB2E7	RPM12E7	RPM22E7	RPM32E7	RPM42E7	–	–
RUMC2AB2F7	RUMC3AB2F7	RUMC3GB2F7	RUMF2AB2F7	RUMF3AB2F7	RPM12F7	RPM22F7	RPM32F7	RPM42F7	RPF2AF7	RPF2BF7
–	–	–	–	–	–	–	–	–	–	–
RUMC2AB2P7	RUMC3AB2P7	RUMC3GB2P7	RUMF2AB2P7	RUMF3AB2P7	RPM12P7	RPM22P7	RPM32P7	RPM42P7	RPF2AP7	RPF2BP7
–	–	–	–	–	–	–	–	–	–	–

For universal relays RUM					For power relays RPM				For power relays RPF	
RUZH2M	RUZH3M	RUZH3M	–	–	RPZF1	RPZF2	RPZF3	RPZF4	–	–
–	–	–	–	–	–	–	–	–	–	–
RUZSC2M	RUZSC3M	RUZSC3M	RUZSF3M	RUZSF3M	–	–	–	–	–	–
RUW240BD	–	–	–	–	1 and 2 poles RXM040W	–	3 and 4 poles RUW240BD	–	–	–
–	–	–	–	–	RXM041BN7	–	–	–	–	–
RUW241P7	–	–	–	–	RXM041FU7	–	RUW241P7	–	–	–
–	–	–	–	–	RXM021RB	–	–	–	–	–
–	–	–	–	–	RXM021BN	–	–	–	–	–
–	–	–	–	–	RXM021FP	–	–	–	–	–
RUW242B7	–	–	–	–	RUW242B7	–	–	–	–	–
RUW242P7	–	–	–	–	–	–	RUW242P7	–	–	–
RUW101MW	–	–	–	–	–	–	RUW101MW	–	–	–
–	–	–	–	–	–	–	–	–	–	–
RUZH200	–	–	–	–	RPZF1 (for 1 pole relays)	–	–	–	–	–
RUZL420	–	–	–	–	–	–	–	–	–	–
RUZS2	–	–	–	–	–	–	–	–	–	–
–	–	–	–	–	RPZ1DA	RXZE2DA	RPZ3DA	RPZ4DA	–	–
–	–	–	–	–	RPZ1FA	RXZE2FA	RPZ3FA	RPZ4FA	–	–

(4) 30A with 13 mm space between relays; 25 A when relay mounting side by side

(5) Max 10 A operating

(6) With LED



2

Type of relay		Pre-assembled equipped with LED and protection circuit	
		Sold in lots of 10	
Contact characteristics			
Thermal current I _{th} in A	6		
Number of contacts	1 C/O		
Contact material	AgSnO ₂		
Switching voltage, min/max	12 / 300 V AC/DC		
Switching capacity min/max (mA /VA)	100 / 1500		
Coil characteristics			
Average consumption, inrush	0.17 W		
permissible voltage variation	-10% / +15%		
Socket connexion	Screw connector		Spring terminal
	Socket supply voltage	Coil supply voltage	
References	12 V AC/DC	12 V DC	RSL1PVJU
	24 V AC/DC	24 V DC	RSL1PVBU
	48 V AC/DC	48 V DC	RSL1PVEU
	110 V AC/DC	60 V DC	RSL1PVFU
	230 V AC/DC	60 V DC	RSL1PVPU
			RSL1PRJU
			RSL1PRBU
			RSL1PREU
			RSL1PRFU
			RSL1PRPU

RSL relays



Type of relay		Relay for customer assembly	
		Sold in lots of 10	
Number of contacts	1 C/O		
	Coil supply voltage		
References	12 V DC	RSL1AB4JD	
	24 V DC	RSL1AB4BD	
	48 V DC	RSL1AB4ED	
	60 V DC	RSL1AB4ND	

Sockets



Type of socket		Sockets for customer assembly with LED and protection circuit	
		Sold in lots of 10	
Socket connection	Screw connector		Spring terminal
	Socket supply voltage		
References	12 and 24 V AC/DC	RSLZVA1	RSLZRA1
	48 and 60 V AC/DC	RSLZVA2	RSLZRA2
	110 V AC/DC	RSLZVA3	RSLZRA3
	230 V AC/DC	RSLZVA4	RSLZRA4



Type of relay	Panel mounted without heat sink and thermal interface					
Contact characteristics						
Thermal current I _{th} in A	10	25	50	75	90	125
Number of contacts	1 NO					
Type if switching	Zero voltage switching					
Output	SPST contact					
Connection	Screw connector					
Control voltage range	3...32 V DC			4...32 V DC		
Operating voltage	24...280 V AC			48...530 V AC	48...660 V AC	
References	SSRPCDS10A1	SSRPCDS25A1	SSRPCDS50A1	SSRPCDS75A2	SSRPCDS90A3	SSRPCDS125A3
Control voltage range						
Control voltage range	90...280 V AC					
Operating voltage	24...280 V AC			80...530 V AC	48...660 V AC	
References	SSRPP8S10A1	SSRPP8S25A1	SSRPP8S50A1	SSRPP8S75A2	SSRPP8S90A3	SSRPP8S125A3

2

SSRD relays



Type of relay	Rail DIN mounted With integrated heat sink			
Contact characteristics				
Thermal current I _{th} in A	10	20	30	45
Number of contacts	1 NO			
Type if switching	Zero voltage switching			
Output	SPST contact			
Connection	Screw connector			
Control voltage range	4...32 V DC			3...32 V DC
Operating voltage	24...280 V AC			
References	SSRD0DS10A1	SSRD0DS20A1	SSRD0DS30A1	SSRD0DS45A1
Control voltage range				
Control voltage range	90...280 V AC			90...140 V AC
Operating voltage	24...280 V AC			
References	SSRDP8S10A1	SSRDP8S20A1	SSRDP8S30A1	SSRDP8S45A1

Accessories



Type of accessory	Heat sink	Thermal interface
For relay	SSRP	
References	SSRAH1	SSRAT1

Zelio Control Measurement and control relays

3-phase monitoring relays



2

Function	Presence of phase + phase sequence		+ phase sequence, +regeneration + phase unbalance, +under/over voltage	
	Monitoring voltage range	208...480 VAC	208...440 VAC	208...480 VAC
Outputs	1 C/O	2 C/O	1 C/O	2 C/O
References	RM17TG00	RM17TG20	RM17TE00	RM35TF30



Function	Presence of phase + under/over voltage		+ presence of neutral + under/over voltage
	Monitoring voltage range	208...480 VAC	220...480 VAC
Outputs	1 C/O	2 C/O	2 C/O
References	RM17UB310	RM35UB330	RM35UB3N30

Level / Speed monitoring relays



Function	Conductive liquid level monitoring	Non-conductive material level monitoring	Over/under speed monitoring
Power supply	24...240 VAC/DC		
Monitoring range	0,25...5 K Ω 5...100 K Ω 0,05...1 M Ω	Input of sensor : Contact / PNP / NPN	Interval between pulses: 0.05...0.5 s, 0.1...1 s, 0.5...5 s 1...10 s, 0.1...1 mn, 0.5...5 mn 1...10 mn
Output	2 C/O	1 C/O	1 C/O
Reference	RM35LM33MW	RM35LV14MW	RM35S0MW

Current / Voltage / Frequency monitoring relays



Function	Voltage Monitoring Under or Over Voltage		
Power Supply	24...240 VAC/DC 50/60Hz		
Monitoring range	0.05...0.5 V	1...10 V	15...150 V
	0.3...3 V	5...50 V	30...300 V
	0.5...5 V	10...100 V	60...600 V
Outputs	2 C/O	2 C/O	2 C/O
References	RM35UA11MW	RM35UA12MW	RM35UA13MW

2



Function	Voltage Monitoring Under or Over Voltage			Under and Over Voltage	
Power Supply	self powered			self powered	
Monitoring range	9...15 VDC	20...80 VAC/DC	65...260 VAC/DC	20...80 VAC/DC	65...260 VAC/DC
Outputs	1 C/O	1 C/O	1 C/O	1 C/O	1 C/O
References	RM17UAS14	RM17UAS16	RM17UAS15	RM17UBE16	RM17UBE15



Function	Current Monitoring		Frequency Monitoring
	over current	over or under current	Over or under frequency
Power supply	24...240 VAC/DC	24...240 VAC/DC 50/60 Hz	120...277 VAC 50/60 Hz
Monitoring range	2...20 A built-in CT	2...20 mA 10...100 mA 50...500 mA	0.15...1.5 A 0.5...5 A 1.5...15 A
Output	1 C/O	2 C/O	2 C/O
Reference	RM17JC00MW	RM35JA31MW	RM35JA32MW
			RM35HZ21FM

Zelio Control Measurement and control relays

Lift / Pump / Motor monitoring relays



2

Function	Lift motor room temperature monitoring		+ phase presence + phase sequence
Power supply	24...240 VAC/DC 50/60Hz		
Monitoring range	input PT100 3 wires Under -1...+11 °C Over +34...+46 °C		208...480 VAC 50/60Hz input PT100 3 wires Under -1...+11 °C Over +34...+46 °C
Output	1 C/O	2 NO	2 C/O
Reference	RM35ATL0MW	RM35ATR5MW	RM35ATW5MW



Function	Pump protection Current monitor + 3 phase monitor	Motor Protection Winding Temperature monitor + 3 phase monitor	
Power supply	self powered (single phase :230 VAC 50/60 Hz)	24...240 VAC/DC	
Monitoring range	Current: 0.1...10 A Voltage (three phase): 208...480 VAC 50/60Hz	Winding Temperature: PTC sensor Three phase voltage: 208...480 VAC 50/60Hz	
Output	1 C/O	2 NO	2 NO
Reference	RM35BA10	RM35TM50MW	RM35TM250MW

Control relays for 3-phase supplies



Function	Rotational direction and presence of phases					
		+Undervoltage	+ Over and undervoltage	+ Asymmetry		
Adjustable time delay	without	without	0.1...10 s	0.1...10 s	fixed, 0.5 s	0.1...10 s
Supply voltage	220...440V	380...440V	400V	380...440V	380...440V	380...440V
Output	2 C/O	2 C/O	2 C/O	2 C/O	1 C/O	2 C/O
References	RM4TG20	RM4TU02	RM4TR34 (1)	RM4TR32 (2)	RM4TA02	RM4TA32

(1) Relay with fixed voltage thresholds.

(2) Relay with adjustable voltage thresholds.

2

Current and voltage measurement relays

(3) Basic reference. To be completed with the letters indicating the required voltage, as shown below:

Voltage	VAC, 50/60 Hz	VDC
24...240 V	MW	MW
110...130 V	F	–
220...240 V	M	–
380...415 V	Q	–



Function	Detection of over and undervoltage					
	over and undercurrent		over and undervoltage			
Measuring range	3...30 mA	0.3...1.5 A	0.05 ...0.5 V	1...10 V	30...300 V	180...270 V
	10...100 mA	1...5 A	0.3 ...3 V	5...50 V	50...500 V	
Adjustable time delay	0.1...1 A	3...15 A	0.5...5 V	10...100 V		
	0.05...30 s	0.05...30 s	0.05...30 s	0.05...30 s	0.05...30 s	0.1...10 s
Output	2 C/O	2 C/O	2 C/O	2 C/O	2 C/O	2 C/O
References	RM4JA31** (3)	RM4JA32** (3)	RM4UA31** (3)	RM4UA32** (3)	RM4UA33** (3)	RM4UB35

(4) Basic reference. To be completed with the letters indicating the required voltage, as shown below:

Voltage	RM4-LG01	RM4-LA32	
	VAC, 50/60 Hz	VAC, 50/60 Hz	VDC
24 V	B	B	–
24...240 V	–	MW	MW
110...130 V	F	F	–
220...240 V	M	M	–
380...415 V	Q	Q	–



Liquid level control relays

Control relays	Empty or fill	
Sensitivity scale	5 ... 100 kΩ	0.25 ... 5 kΩ 2.5 ... 50 kΩ 25 ... 500 kΩ
Time delay	without	adjustable, 0.1 to 10 s
Output	1 C/O	2 C/O
References	RM4LG01• (4)	RM4LA32** (4)

Liquid level control probe type	Measuring electrode and reference electrode	1 simple stainless steel electrode in PVC protective casing
Mounting	suspended	suspended
Maximum operating temperature	100°C	100°C
References	LA9RM201	RM79696043



Type of relay			Size 24 x 48 mm - 1/32 DIN								
Input type			Thermocouple PT100 probe			Voltage/Current 1...5 V / 4...20 mA					
Integrated functions			Hysteresis, PID, auto-tuning, fuzzy logic, rampe 8 steps, automatic operating mode								
Alarm output			-		1		-		-		
Communication			ModBus			-		ModBus		ModBus	
Supply voltage			100...240 VAC			24 V AC/DC		100...240 VAC		24 V AC/DC	
References	Number/Output type	1/relay	REG24PTP1RHU	REG24PTP1ARHU	REG24PTP1RLU	REG24PUJ1RHU	REG24PUJ1RLU				
		1/solid-state	REG24PTP1LHU	REG24PTP1ALHU	REG24PTP1LLU	REG24PUJ1LHU	REG24PUJ1LLU				
		1/4-20 mA	REG24PTP1JHU	-	REG24PTP1JLU	-	-				



Type of relay			Format 48 x 48 mm - 1/16 DIN							
Input type			Universal							
Integrated functions			Hysteresis, PID, auto-tuning, fuzzy logic, rampe 16 steps, automatic and manual operating mode							
Alarm output			2							
Communication			ModBus			-		ModBus		
Supply voltage			100...240 VAC			24 V AC/DC				
References	Number/Output type	1/relay	REG48PUN1RHU	REG48PUN1ARHU	REG48PUN1RLU					
		2/relay	REG48PUN2RHU	-	REG48PUN2RLU					
		1/solid-state	REG48PUN1LHU	REG48PUN1LHU	REG48PUN1LLU					
		1 + 1 solid-state	REG48PUN2RLHU	-	REG48PUN2RLLU					
		1/4-20 mA	REG48PUN1JHU	-	REG48PUN1JLU					
		1/solid-state + 1/4-20 mA	REG48PUN2LJHU	-	REG48PUN2LJLU					



Type of relay			Size 96 x 48 mm - 1/8 DIN							
Input type			Universal							
Integrated functions			Hysteresis, PID, auto-tuning, fuzzy logic, rampe 16 steps, automatic and manual operating mode							
Alarm output			3							
Communication			ModBus			-		ModBus		
Supply voltage			100...240 VAC			24 V AC/DC				
References	Number/Output type	1/relay	REG96PUN1RHU	REG96PUN1ARHU	REG96PUN1RLU					
		2/relay	REG96PUN2RHU	-	REG96PUN2RLU					
		1/solid-state	REG96PUN1LHU	REG96PUN1LHU	REG96PUN1LLU					
		1 + 1 solid-state	REG96PUN2RLHU	-	REG96PUN2RLLU					
		1/4-20 mA	REG96PUN1JHU	-	REG96PUN1JLU					
		1/solid-state + 1/4-20 mA	REG96PUN2LJHU	-	REG96PUN2LJLU					

Zelio Count Counters Totalisers



Display	Mechanical				LCD
Supply voltage	24 VDC				Battery
Number of digits displayed	5	6	6	8	8
Counting frequency	20 Hz	10 Hz	25 Hz	25 Hz	7.5 kHz
Type of zero reset	Manual	Without	Manual	Without	Manual (1)
Front face dimensions, W x H	41.5 x 31 mm	30 x 20 mm	60 x 50 mm	60 x 50 mm	48 x 24 mm
References	XBKT50000U10M	XBKT60000U00M	XBKT60000U10M	XBKT80000U00M	XBKT81030U33E

(1) With electrical interlocking.

2

Hours counters



Display	Mechanical		LCD
Supply voltage	24 VAC	230 VAC	Battery
Number of digits / display	7 (99,999.99 h)	7 (99,999.99 h)	8 (999,999.99 h)
Supply frequency	50 Hz	50 Hz	Mode: 1/100 hour
Type of zero reset	Without	Without	Manual (1)
Front face dimensions, W x H	48 x 48 mm	48 x 48 mm	48 x 24 mm
References	XBKH70000004M	XBKH70000002M	XBKH81000033E

Multifunction counters

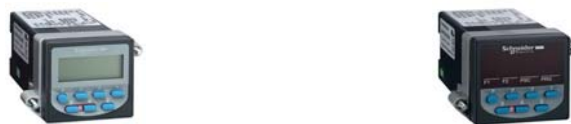

Display	LCD		LED			
Number of digits displayed	6					
Counting frequency	5 kHz					
Type of reset	Manual, electric and automation					
Front face dimensions, W x H	48 x 48 mm					
Preselection number	1	2	1	2		
References	Supply voltage	24 VDC	XBKP61130G30E	XBKP61230G30E	XBKP62130G30E	XBKP62230G30E
		115 VAC	XBKP61130G31E	XBKP61230G31E	–	–
		230 VAC	XBKP61130G32E	XBKP61230G32E	XBKP62130G32E	XBKP62230G32E



Type of modular timer width 17.5 mm, relay output	On-delay	Multifunction		
External control	no	–	–	–
Supply voltage	24...240 VAC/VDC	24...240 VAC/VDC	–	12 ... 240VAC/DC
Timing range	0.1 s...100 h	0.1 s...100 h	0.1 s...10 h	0.1 s...100 h
Output	1 C/O	1 C/O	1 C/O	1 C/O
References	RE17RAMU	RE17RMMU (1)	RE17RMEMU (2)	RE17RMMW (1)

(1) Multifunction: On-delay, Off-delay, Totaliser, Symmetrical flashing, Chronometer, Pulse on energisation, Pulse output, Timing after closing/opening of control contact.

(2) Multifunction: On-delay, Off-delay, Totaliser, Symmetrical flashing, Chronometer, Pulse on energisation.



Type of modular timer width 17.5 mm, relay output	Asymmetrical flashing	Pulse on energisation	Off delay	Timing on impulse
External control	–	–	–	–
Supply voltage	24...240 VAC/VDC	24...240 VAC/VDC	24...240 VAC/VDC	24...240 VAC/VDC
Timing range	0.1 s...100 h	0.1 s...100 h	0.1 s...100 h	0.1 s...100 h
Output	1 C/O	1 C/O	1 C/O	1 C/O
References	RE17RLMU	RE17RHMU	RE17RCMU	RE17RBMU



Type of modular timer width 17.5 mm, solid-state output	On-delay	Off-delay	Multifunction (3)
Supply voltage	24...240 VAC/DC	24...240 VAC	24...240 VAC
Timing range	0.1 s...100 h	0.1 s...100 h	0.1 s...100 h
Output	solid-state	solid-state	solid-state
References	RE17LAMW	RE17LCBM	RE17LMBM

(3) Multifunction: On-delay, Off-delay, Totaliser, Symmetrical flashing, Chronometer, Pulse on energisation, Pulse output, Timing after closing/opening of control contact.



Panel-mounted relays	Timer on-delay	Asymmetrical flasher	Multifunction (4)	Multifunction (5)
Power supply	24...240 VAC/DC			
Time range	0,02 s...300 h			
Output	2 relay 5 A			
Reference	RE48ATM12MW	RE48ACV12MW	RE48AMH13MW (6)	RE48AML12MW
	Back panel mounting socket RUZC2M	RUZC3M	RUZC2M	RUZC3M
	Front panel mounting socket RE48ASOC8SOLD	RE48ASOC11SOLD	RE48ASOC8SOLD	RE48ASOC11SOLD

(4) Timer on-delay / pulse on energization

(5) Timer on-delay / calibrator / timer off-delay / symmetrical flasher

(6) 1 selectable in instantaneous

Industrial timers



Type of single function relay width 22.5 mm, relay output	On-delay		Off-delay		
	no	yes	no	yes	yes
External control	no	yes	no	yes	yes
Supply voltage	24 VAC/DC 110...240 VAC	24 VAC/DC 42...48 VAC/DC 110...240 VAC	24...240 VAC/DC	24 VAC/DC 42...48 VAC/DC 110...240 VAC	24 VAC/DC 42...48 VAC/DC 110...240 VAC
Timing range	0.05 s...300 h	0.05 s...300 h	0.05 s...10 mn	0.05 s...300 h	0.05 s...300 h
Output	1 C/O	2 C/O (1)	1 C/O	2 C/O (1)	1 C/O
References	RE7TL11BU	RE7TP13BU	RE7RB11MW	RE7RL13BU	RE7RM11BU

(1) 1 selectable in instantaneous mode.



Type of relay width 22.5 mm, relay output	Single function		Multifunction	
	Asymmetrical flashing	Pulse on energisation	6 functions (2)	8 functions (3)
External control	yes	no	–	–
Supply voltage	24 VAC/DC 42...48 VAC/DC 110...240 VAC	24 VAC/DC 110...240 VAC	24 VAC/DC 42...48 VAC/DC 110...240 VAC	24 VAC/DC 110...240 VAC
Timing range	0.05 s...300 h	0.05 s...300 h	0.05 s...300 h	0.05 s...300 h
Output	1 C/O	1 C/O	1 C/O	2 C/O (4)
References	RE7CV11BU	RE7PE11BU	RE7ML11BU	RE7MY13BU

(2) RE7ML11BU functions: On-delay, Off-delay, Pulse on energisation with start on energisation, Pulse on energisation with start on opening of remote control contact, Flashing with start during the OFF period, Flashing with start during the ON period.

(3) REMY13BU functions: On-delay, Off-delay, Pulse on energisation with start on energisation, Pulse on energisation with start on opening of remote control contact, Flashing with start during the OFF period, Flashing with start during the ON period, Star-delta starting with double On-delay timing, Star-delta starting with contact for switching to star connection.

(4) 1 selectable in instantaneous mode

Miniature plug-in relays, relay output



Functions		On-delay
Timing ranges	7 switchable ranges	0.1 s...1 s - 1 s...10 s - 0.1 min...1 min - 1 min...10 min - 0.1 h...1 h - 1 h...10 h - 10 h...100 h
Relay output		4 timed C/O contacts
Rated current		2 timed C/O contacts
Voltages	24 VDC	3 AC 5 A RE XL4TMBD
	24 VAC 50/60 Hz	AC 5 A RE XL2TMBD
	120 VAC 50/60 Hz	RE XL4TMB7
	230 VAC 50/60 Hz	RE XL2TMB7
Socket with mixed contact terminals	With screw clamp	RE XL4TMF7
	With connector	RE XL2TMF7
		RXZE2M114
		RXZE2M114M



2

Type	Thermocouple				
Temperature range	0...150 °C 32...302 °F	0...300 °C 32...572 °F	0...600 °C 32...1112 °F	0...600 °C 32...1112 °F	0...1200 °C 32...2192 °F
Output range	0...10 V / 0...20 mA - 4...20 mA Switchable				
Dimensions H x W x D	80 x 22,5 x 80 mm				
Voltage	24 VDC - Non isolated				
References	RMTJ40BD	RMTJ60BD	RMTJ80BD	RMTK80BD	RMTK90BD

Universal PT 100



Type	PT 100				
Temperature range	-40...40 °C -40...104 °F	-100...100 °C -148...212 °F	0...100 °C 32...212 °F	0...250 °C 32...482 °F	0...500 °C 32...932 °F
Output range	0...10 V / 0...20 mA - 4...20 mA Switchable				
Dimensions H x W x D	80 x 22,5 x 80 mm				
Voltage	24 VDC - Non isolated				
References	RMPT10BD	RMPT20BD	RMPT30BD	RMPT50BD	RMPT70BD

Optimum PT 100



Type	PT 100				
Temperature range	-40...40 °C -40...104 °F	-100...100 °C -148...212 °F	0...100 °C 32...212 °F	0...250 °C 32...482 °F	0...500 °C 32...932 °F
Output range	0...10 V				
Dimensions H x W x D	80 x 22,5 x 80 mm				
Voltage	24 VDC - Non isolated				
References	RMPT13BD	RMPT23BD	RMPT33BD	RMPT53BD	RMPT73BD

2

Universal Analog Converter



Type	Analog Converter			
Input range	0...10 V or 4...20 mA	0...10 V / -10...+10 V 0...20 mA 4...20 mA	0...50 V / 0...300 V 0...500 V	0...1,5 A / 0...5 A 0...15 A
Output range	0...10 V or 4...20 mA	0...10 V / -10...+10 V 0...20 mA 4...20 mA Switchable	0...10 V 0...20 mA 4...20 mA Switchable	0...10 V or 0...20 mA ou 4...20 mA
Dimensions H x W x D	80 x 22,5 x 80 mm			80 x 45 x 80 mm
Voltage	24 VDC - Non isolated	24 VDC - Isolated	24 VDC - Isolated	24 VDC - Isolated
References	RMCA22BD	RMCL55BD	RMCA60BD	RMCA61BD



Compact smart relays		With display, a.c. power supply					
Supply voltage		24 VAC		48 VAC	100...240 VAC		
Number of inputs/outputs		12	20	20	10	12	20
Number of inputs	Discrete inputs	8	12	12	6	8	12
Number of outputs		4 relay	8 relay	8 relay	4 relay	4 relay	8 relay
Dimensions, W x D x H (mm)		71.2x59.5x107.6	124.6x59.5x107.6		71.2x59.5x107.6		124.6x59.5x107.6
Clock		yes	yes	no	no	yes	yes
References		SR2B121B	SR2B201B	SR2A201E	SR2A101FU (1)	SR2B121FU	SR2A201FU (1) SR2B201FU

(1) Programming on smart relay in LADDER language only



Compact smart relays		With display, d.c. power supply					
Supply voltage		12 VDC		24 VDC			
Number of inputs/outputs		12	20	10	12	20	20
Number of inputs	Discrete inputs	8	12	6	8	12	12
	including 0-10 V analogue inputs	4	6	-	4	2	6
Number of outputs		4 relay	8 relay	4 relay	4	8 relay	8
Dimensions, W x D x H (mm)		71.2x59.5x107.6	124.6x59.5x107.6	71.2x59.5x107.6		124.6x59.5x107.6	
Clock		yes	yes	no	yes	no	yes
References		SR2B121JD	SR2B201JD	SR2A101BD (1)	SR2B12●BD (2)	SR2A201BD (1)	SR2B20●BD (2)

(1) Programming on smart relay in LADDER language only

(2) Replace the ● by number 1 to order a smart relay with **relay output** or by 2 for a smart relay with **transistor output** (Example: SR2B121BD)



Compact smart relays		Without display and without buttons					
Supply voltage		100...240 VAC			24 VDC		
Number of discrete inputs/outputs		10	12	20	10	12	20
Number of inputs	Discrete inputs	6	8	12	6	8	12
	including 0-10 V analogue inputs	-	-	-	-	4	6
Number of outputs		4 relay	4 relay	8 relay	4 relay	4 relay	8 relay
Dimensions, W x D x H (mm)		71.2x59.5x107.6		124.6x59.5x107.6	71.2x59.5x107.6		124.6x59.5x107.6
Clock		no	yes	yes	no	yes	yes
References		SR2D101FU (1)	SR2E121FU	SR2E201FU	SR2D101BD (1)	SR2E121BD (3)	SR2E201BD (3)

(1) Programming on smart relay in LADDER language only

(3) To order a smart relay for a **24 VAC supply** (no analogue inputs), delete the letter **D** from the end of the reference (**SR2E121B** and **SR2E201B**)

Modular, SR3



Modular smart relays*	With display						
	24 VAC		100...240 VAC		12 VDC	24 VDC	
Supply voltage	24 VAC		100...240 VAC		12 VDC	24 VDC	
Number of inputs/outputs	10	26	10	26	26	10	26
Number of inputs	Discrete inputs		Discrete inputs		Discrete inputs	Discrete inputs	
	6	16	6	16	16	6	16
	including 0-10 V analogue inputs		including 0-10 V analogue inputs		including 0-10 V analogue inputs	including 0-10 V analogue inputs	
Number of outputs	4 relay	10 relay	4 relay	10 relay	6	4	6
Dimensions, W x D x H (mm)	71.2x59.5x107.6	124.6x59.5x107.6	71.2x59.5x107.6	124.6x59.5x107.6	124.6x59.5x107.6	71.2x59.5x107.6	124.6x59.5x107.6
Clock	yes	yes	yes	yes	yes	yes	yes
References	SR3B101B	SR3B261B	SR3B101FU	SR3B261FU	SR3B261JD	SR3B10BD (1)	SR3B26BD (1)

*The modular base can be fitted with one I/O extension module. The 24 VDC modular base can be fitted with one communication module and/or one I/O extension module

(1) Replace the ● by number 1 to order a smart relay with relay output (SR3B101BD) or by 2 for a smart relay with transistor output (SR3B102BD)



Extension modules for Zelio Logic SR3B●●●●● (2)	Communication		Discrete Inputs/Outputs			Analogue Inputs/Outputs	
	Modbus	Ethernet	6	10	14	4	
Network	Modbus	Ethernet	6	10	14	4	
Number of inputs/outputs	Modbus	Ethernet	6	10	14	4	
Number of inputs	Discrete	Discrete	4	6	8	—	
	Analogue (0...10 V, 0...20 mA, PT100)	Analogue (0...10 V, 0...20 mA, PT100)	—	—	—	2 (1 PT100 max.)	
Number of outputs	Relay	Relay	2 relay	4 relay	6 relay	—	
	Analogue (0...10 V)	Analogue (0...10 V)	—	—	—	2	
Dimensions, W x D x H (mm)	35.5x59.5x107.6		35.5x59.5x107.6		72x59.5x107.6		
References	24 VAC	—	SR3XT61B	SR3XT101B	SR3XT141B	—	
	100...240 VAC	—	SR3XT61FU	SR3XT101FU	SR3XT141FU	—	
	12 VDC	—	SR3XT61JD	SR3XT101JD	SR3XT141JD	—	
	24 VDC	SR3MBU01BD	SR3NET01BD	SR3XT61BD	SR3XT101BD	SR3XT141BD	SR3XT43BD

(2) The power supply of the extension modules is provided via the Zelio Logic modular relays

Zelio Soft 2 software and programming tools



Zelio Soft 2 software, connecting cables, wireless connecting, memory	Multilingual programming software	Connecting cables				Wireless connection	Back-up memory
Description	CD ROM PC (Windows XP, Vista 32 bits and Windows 7 32 bits) (3)	Serial PC/Smart relay	USB PC/Smart relay	XBT N/R Interface	HMISTO Interface	Bluetooth interface	EEPROM
References	SR2SFT01	SR2CBL01	SR2USB01	SR2CBL08	SR2CBL09	SR2BTC01	SR2MEM02

(3) CD-ROM including Zelio Soft 2 programming software, an application library, a self-training manual, installation instructions and a user's manual

Communication interface for SR2/SR3

Interface, modems, Zelio Logic Alarm software	Communication interface	Modems (4)		Alarm management software
Supply voltage	12...24 VDC	12...24 VDC	12...24 VDC	—
Description	—	Analogue modem	GSM modem	PC CD-ROM (Windows 98, NT, 2000, XP)
Dimensions, W x D x H (mm)	72x59.5x107.6	120.7x35x80.5	111x 25.5x54.5	—
References	SR2COM01	SR2MOD01	SR2MOD02	SR2SFT02

(4) Must be used in conjunction with communication interface SR2COM01



Type de base		Compact			
		Non expandable bases		Expandable bases	
Number of digital I/O		10	16	24	40
Number of digital inputs (24 VDC)		6 sink/source	9 sink/source	14 sink/source	24 sink/source
Number of digital outputs		4 relay (2 A)	7 relay (2 A)	10 relay (2 A)	14 relay (2 A), 2 solid-state (1 A)
Type of connection		Screw terminals (non removable)			
Possible I/O expansion modules		–	–	4	7
Counting		3 x 5 kHz, 1 x 20 kHz			
PWM positioning		–			
Serial ports		1 x RS 485	1 x RS 485; option: 1 x RS 232C or RS 485		
Protocol		Modbus master/slave, ASCII, I/O relocation			
Ethernet port		–	–	–	RJ45 Ethernet
Dimensions, W x D x H		80 x 70 x 90 mm	80 x 70 x 90 mm	95 x 70 x 90 mm	157 x 70 x 90 mm
References	Supply voltage 100...240 VAC	TWDLCAA10DRF	TWDLCAA16DRF	TWDLCAA24DRF	TWDLCAE40DRF (1)
	Supply voltage 19.2...30 VDC	TWDLCAA10DRF	TWDLCAA16DRF	TWDLCAA24DRF	TWDLCAE40DRF (1)
	Real-time clock (option)	TWDXCPRTC			
	Display unit (option)	TWDXCPODC			
	Memory cartridge (option)	TWDXCPMFK32 (3)			TWDXCPMFK64 (4)

(1) 40 I/O version without Ethernet also available: TWDLCAA40DRF and TWDLCAE40DRF

Modular bases



Type of base		Modular		
Number of digital I/O		20		40
Number of digital inputs (24 VDC)		12 sink/source	12 sink/source	24 sink/source
Number of digital outputs		8 transistor, source (0.3 A)	6 relay (2 A) & 2 trans., source (0.3 A)	16 transistor, source (0.3 A)
Type of connection		HE10 connector	Removable screw terminals	HE10 connector
Possible I/O expansion modules		4	7	7
Supply voltage		24 VDC		
Counting		2 x 5 kHz, 2 x 20 kHz		
PLS/PWM positioning		2 x 7 kHz		
Serial ports		1 x RS 485; option: 1 x RS 232C or RS 485		
Protocol		Modbus master/slave, ASCII, I/O relocation		
Dimensions, W x D x H		35.4 x 70 x 90 mm	47.5 x 70 x 90 mm	47.5 x 70 x 90 mm
References		TWDLMDA20DTK (2)	TWDLMDA20DRT	TWDLMDA40DTK (2)
	Real-time clock (option)	TWDXCPRTC		
	Display unit (option)	TWDXCPODM		
	Memory cartridge (option)	TWDXCPMFK32 (3)	TWDXCPMFK64 (4)	

(2) Sink version transistor outputs also available: TWDLMDA20DUK and TWDLMDA40DUK

(3) Application backup, program transfer

(4) Memory expansion, application backup, program transfer

I/O expansion modules

For I/O expansion modules, please consult Modicon TM2 page 2/21

Communication modules



Type of module	Serial interface			Serial interface adaptor		
	Physical layer (non isolated)	RS 232C	RS 485		RS 232C	RS 485
Connection	Mini-DIN connector	Screw terminals		Mini-DIN connector	Screw terminals	
Protocol	Modbus master/slave, ASCII, I/O relocation					
Twido base compatibility	Modular base TWDLMDA			Compact base TWDLCAA16/24DRF Modular base via integrated display module TWDXCPODM		
References	TWDNOZ232D	TWDNOZ485D	TWDNOZ485T	TWDNAC232D	TWDNAC485D	TWDNAC485T

2



Type of module	Modem for Twido	CANopen expansion	Ethernet interface	Modbus isolation module	Modbus junction module
Number of modules	–	1	1	–	–
Connection	–	SUB-D9	RJ45	RJ45	RJ45
Twido base compatibility	–	20, 24 or 40 I/O base	All models	All models	All models
References	SR2MOD03	TWDNCO1M	499TWD01100	TWDXCAISO	TWDXCAT3RJ

(1) 2 modules max., 62 digital slaves max., 7 analogue slaves max., AS-Interface/M3, V 2.11 (profile S.7.4 not supported)

Programming software



Software, connecting cables, interfaces	TwidoSuite software EN/FR	Connecting cables		Bluetooth® USB adaptor	Bluetooth® gateway
Application	PC with Windows XP or Vista	Twido/PC USB port	Twido/PC serial port	For PC not fitted with Bluetooth®	For Twido controller
References	TWDBTFU10M	TSXCUSB485 TSXCRJMD25	TSXPCX1031	VW3A8115	VW3A8114



SoMachine



Type of base	Compact			
Number of digital I/O	24 (removable battery to be ordered separately)			
Supply voltage	24VDC	100-240VAC	24VDC	100-240VAC
Number of digital inputs (24VDC)	14, 8 of which can be assigned as fast inputs			
Number of digital outputs	10 transistor, 4 of which can be configured as fast outputs	4 transistor + 6 relays	10 transistor, 4 of which can be configured as fast outputs	4 transistor + 6 relays
Type of connection	Removable screw terminal blocks (as standard) Removable spring terminal blocks (as option)			
Possible I/O expansion modules	7 modules: digital, analog, high-speed counter (3 max.), master AS-Interface (2 max.)			
High-speed counting (32 bits capacity)	8 x 100kHz simple channels, 4 x 100kHz simple channels + 1 x 100kHz advanced channels, or 2 x 100kHz advanced channels			
Motion or reflex functions	2 advanced channels, PWM:20kHz, PTO: 100kHz		4 advanced channels HSC reflex functions:100kHz	
PID Regulation	Yes			
Serial Ports	1 RS 232/485 (SL1) serial link		1 RS232/485 (SL1) serial link, 1 RS485 (SL2) serial link	
CANopen	-		1 master for 16 slaves max.	
Dimensions, W x D x H	157 x 86 x 118 mm			
References	TM238LDD24DT	TM238LDA24DR	TM238LFDC24DT	TM238LFAC24DR

High-speed counting modules



Type of module	High-speed counting	
Modularity	2 channels	
Maximum number of modules per base	3	
Number of sensor inputs	6 per channel	
Number of actuator outputs	2 per channel	
Capacity	31 bits + sign	
Frequency on inputs	60kHz	
Connection	1 screw terminal per channel	1 spring terminal per channel
References	TM200HSC206DT	TM200HSC206DF

Communication module and accessory



Designation	Ethernet interface	Program loader
Description	Ethernet Modbus/TCP	Kit: program loader, cable (USB/mini-B USB), 2 batteries (type AA/LR6)
Maximum number of modules per base	1	-
References	499TWD01100	TM2USBABDEV1

(1) Requires the use of a USB memory stick (not supplied)



Type of module		Analog inputs						
Number of inputs		2 I	2 I	4 I	8 I	8 I	8 I	8 I
Connection		Removable screw terminals						
Inputs		RJ11						
Inputs	Range	Thermocouples type K, J, T	0...10 V (1) 4...20 mA (2)	0...10 V (1) 0...20 mA (2) θ °C	0...10 V (1) 0...20 mA (2)	PTC/NTC	Thermo probe Pt100 / Pt1000 -200...+600 °C	
	Resolution	12 bits (4096 points)			10 bits (1024 points)		12 bits (4096 points)	
Supply voltage		24 VDC						
Dimensions, W x D x H		23.5 x 70 x 90 mm					39.1x70x90 mm	
References		TM2AMI2LT	TM2AMI2HT	TM2AMI4LT	TM2AMI8HT	TM2ARI8HT	TM2ARI8LT	TM2ARI8LRJ

(1) Non differential

(2) Differential



Type of module		Analog Outputs, Inputs/Outputs (mixed)				
Number of inputs and/or outputs		1 O	2 O	2 I / 1 O	2 I / 1 O	4 I / 2 O
Connection		Removable screw terminals				
Inputs	Range	–	–	0...10 V (1) 4...20 mA (2)	Thermocouple type K, J & T 3-wire Pt 100 thermal probe	0...10 V (1) 4...20 mA (2)
	Resolution	–	–	12 bits (4096 points)	12 bits (4096 points)	12 bits (4096 points)
Outputs	Range	0...10 V (1) 4...20 mA (2)	± 10 V	0...10 V (1) 4...20 mA (2)	0...10 V (1) 4...20 mA (2)	0...10 V (1) 4...20 mA (2)
	Resolution	12 bits	11 bits + sign	12 bits	12 bits	12 bits
Supply voltage		24 VDC				
Dimensions, W X D x H		23.5 x 70 x 90 mm				
References		TM2AMO1HT	TM2AVO2HT	TM2AMM3HT	TM2ALM3LT	TM2AMM6HT

(1) Non differential

(2) Differential



Type of module		Digital Inputs/Outputs						
Number of inputs and/or outputs		8	16	16	32	4 I / 4 O	16 I / 8 O	
Connection		Removable screw terminals			HE10 connectors		Removable screw terminals	Spring terminals (non removable)
References	Inputs	24 VDC sink	TM2DDI8DT	–	–	–	–	
		24 VDC sink/source	–	TM2DDI16DT	TM2DDI16DK	TM2DDI32DK	–	
		120 V sink	TM2DAI8DT	–	–	–	–	
	Outputs	Relay (2 A)	TM2DRA8RT	TM2DRA16RT	–	–	–	
		Transistor, source 0.5 A	TM2DDO8TT	–	–	–	–	
		Transistor, source 0.4 A	–	–	TM2DDO16TK	TM2DDO32TK	–	
		Transistor, sink 0.1 A	TM2DDO8UT	–	TM2DDO16UK	TM2DDO32UK	–	
	Inputs, 24 VDC + Outputs, Relais 2 A		–	–	–	–	TM2DMM8DRT	TM2DMM24DRF



SoMachine











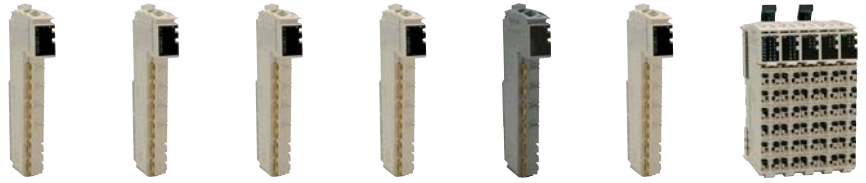

Controller type		42 digital I/O	42 digital I/O & CANopen
Internal memory	RAM	64 MB	
	Flash Eeprom	128 MB	
Typical Boolean instruction time		22 ns	
User program size		128 program K instructions	
Power supply		24 V DC	
Inputs	Digital	26 inputs 24VDC including 8 counter inputs (200 kHz)	
	Analog*	4 inputs (+10V/-10V, 4-20mA/0-20mA, 12-bits resolution)	
Outputs	Transistor	16 outputs (0,5A) including 4 reflex outputs (100 kHz)	
	Relay	-	
Optional communication ports*		2 PCI slots available on controller for optional communication modules (Profibus DP Slave, SL RS232, SL RS485)	
Communication	USB-B mini-port	Programming port for SoMachine software	
	USB-A port	Connection of a USB memory stick for transferring programs, data files, firmware updates	
	RJ45 port (MBS)	RS232 serial link	
		RS485 serial link (supplies 250 mA, 5 V for HMI power supply)	
		Protocols: Modbus ASCII/RTU Master/Slave, ASCII (character string)	
SUB-D connector (CAN0)	-	CANopen bus master (63 slaves)	
RJ45 port (Ethernet)	Ethernet TCP, Ethernet IP, FTP server, Ethernet Modbus TCP		
Max. number of expansions		250 modules (local or remote) for digital IO, analog IO or Expert functions	
References		TM258LD42DT TM258LD42DT4L*	TM258LF42DT TM258LF42DT4L*

*4 analog inputs & 2 PCI slots only for TM258LD42DT4L

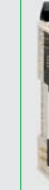

Controller type		42 digital I/O relays & CANopen	66 digital I/O & CANopen & 4 analog inputs
Internal memory	RAM	64 MB	
	Flash Eeprom	128 MB	
Typical Boolean instruction time		22 ns	
User program size		128 program K instructions	
Power supply		24 V DC	
Inputs	Digital	26 inputs 24VDC including 8 counter inputs (200 kHz)	38 inputs 24VDC including 8 counter inputs (200 kHz)
	Analog	-	4 analog inputs +10 V/-10V, 4-20mA/0-20 mA 12 bits resolution
Outputs	Transistor	4 reflex outputs (100 kHz)	28 outputs (0,5A) including 4 reflex outputs (100 kHz)
	Relay	12 relays	-
Optional communication ports		2 PCI slots for optional communication modules	
Communication	USB-B mini-port	Programming port for SoMachine software	
	USB-A port	Connection of a USB memory stick for transferring programs, data files, firmware updates	
	RJ45 port (MBS)	RS232 serial link	
		RS485 serial link (supplies 250 mA, 5 V for HMI power supply)	
		Protocols: Modbus ASCII/RTU Master/Slave, ASCII (character string)	
SUB-D connector (CAN0)	CANopen bus master (63 slaves)		
RJ45 port (Ethernet)	Ethernet TCP, Ethernet IP, FTP server, Web server, Ethernet Modbus TCP		
Max. number of expansions		250 modules (local or remote) for digital IO, analog IO or Expert functions	
References		TM258LF42DR	TM258LF66DT4L

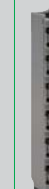

Type of module	Input			Output			Input Output Digital
	Digital	Analog		Digital	Analog		
Number of inputs	12 sink	–	–	–	–	–	24
Number of outputs	–	–	–	12 source	4 relay	–	18
Number of inputs	–	4	4	–	–	–	–
Number of outputs	–	–	–	–	–	4	–
Nominal input current	24 VDC	–	–	–	–	–	24 VDC
Nominal output current	–	–	–	24 VDC	30 VDC/ 230 VAC	–	24 VDC
Type	–	Thermal probe	Voltage / Current	–	–	Voltage / Current	–
Associated bus sub-bases (2)							–
	TM5ACBM11	TM5ACBM11	TM5ACBM11	TM5ACBM11	TM5ACBM12	TM5ACBM11	
Associated terminal block (2)							–
	TM5ACTB12	TM5ACTB12	TM5ACTB12	TM5ACTB12	TM5ACTB32	TM5ACTB12	
References	TM5SDI12D	TM5SAI4PH	TM5SAI4L	TM5SDO12T	TM5SDO4R	TM5SAO4L	TM5C24D18T

(1) Modicon M258 and Modicon LMC058 controllers offer the possibility of creating IP20 or IP67 islands of remote I/O via the TM5 expansion bus. For Modicon TM7 (IP67) and Modicon TM5 (IP20) modular I/O systems, please see page 6/13 and 6/3 or consult www.schneider-electric.com

(2) To be ordered separately



SoMachine



Controller type		42 digital I/O	42 digital I/O + 4 analog inputs
CANmotion Drive synchronisation	Up to 4 axes	2 ms	
	Up to 8 axes	4 ms	
Internal memory	RAM	64 MB	
	Flash Eeprom	128 MB	
Typical Boolean instruction time		22 ns	
Expert application	Relative and Absolute positioning	Yes	
	Velocity control	Yes	
	Homing	Yes	
	CNC visual editor	Yes	
	CAM profiles	Yes	
	Electronic gear	Yes	
	Interpolation	Yes	
	Shift Compensation	Yes	
Embedded number of digital inputs		26 including 8 high speed counter	
Embedded number of digital outputs		16 outputs transistor (0.5 A) including 4 reflex outputs	
Embedded number of analog inputs		–	4
Optional communication ports		–	2 PCI slots for optional communication modules
Communication	USB-B mini-port	Programming port for SoMachine software	
	USB-A port	Connection of a USB memory stick for transferring programs, data files, firmware updates	
	RJ45 port (MBS)	RS232 serial link RS485 serial link (supplies 250 mA, 5 V for HMI power supply) Protocols: Modbus ASCII/RTU Master/Slave, ASCII (character string)	
	SUB-D connector (CAN0)	CANopen bus master (63 slaves)	
	SUB-D connector (CAN1)	CANmotion bus master (63 slaves)	
	SUB-D connector (Encoder)	Encoder input (incremental or SSI)	
	RJ45 port (Ethernet)	Ethernet IP device	
		Ethernet TCP Modbus	
SoMachine protocol			
FTP server embedded Web server embedded			
Max. number of expansions		250	
References		LMC058LF42	LMC058LF424

I/O expansion modules

For I/O expansion modules, please consult Modicon TM5 page 2/23



SoMachine



Type		Characteristics		
Display	LCD screen size / Resolution	3,8" / QVGA	5,7" / QVGA	
	Type	STN monochrome, amber or red	STN monochrome, gray	STN 4096 colours
Functions	Representation of variables	Alphanumeric, bitmap, bargraph, gauge, button, light, clock, flashing light, keypad		
	Curves / Alarm logs	Yes, with log / Yes, incorporated		
	Control	5 languages IEC		
Communication	Serial link	1 Sub9 (RS 232/RS 422 - RS 485)		
	Networks	-		Ethernet, IEEE 802.3 10/100 BASE-T, RJ45
Downloadable protocols	Mitsubishi (Melsec), Omron (Sysmac), Rockwell Automation (Allen Bradley), Siemens (Simatic) Uni-TE, Modbus, Modbus TCP			
Development software	SoMachine (on Windows XP and Vista)			
Dimensions W x D x H (mm)	130 x 76 x 104		207 x 76 x 157	
Compatibility with PLCs	Twido, Modicon TSX Micro, Modicon Premium, Modicon Quantum, Modicon M340			
«Compact Flash» card slot	No			
USB port Host type A	1		1	1
Built-in Ethernet TCP/IP	No		No	Yes
Integrated I/O	12I/6O 24 VDC		16I/16O 24 VDC	
Extensions	2 modules TM2 or CANopen module		3 modules TM2 or CANopen module	
Supply voltage	24 VDC			
References	Source Output	XBTGC1100T	XBTGC2120T	XBTGC2230T
	Sink Output	XBTGC1100U	XBTGC2120U	XBTGC2230U

2

Extensions

Type of module	CANopen Master						
Characteristics	Class M10 limited 16 slaves, Standard DS301 V4.02						
References	XBTZGCCAN						

Type of module	Digitals Inputs / Outputs						
Characteristics	8I 24 VDC Screw terminal	16I 24 VDC Screw terminal	16I 24 VDC HE10	32I 24 VDC HE10	8I 120 VAC Screw terminal	4I 24 VDC 40 Relays Screw terminal	16I 24 VDC 80 Relays Screw terminal
References	TM2DDI8DT	TM2DDI16DT	TM2DDI16DK	TM2DDI32DK	TM2DAI8DT	TM2DMM8DRT	TM2DMM24DRF

Type of module	Digitals Inputs / Outputs					
Characteristics	8O Transistor 24 VDC Screw terminal	16O Transistor 24 VDC HE10	32O Transistor 24 VDC HE10	8O Relays 230 VAC 30 VDC Screw terminal	16O Relays 230 VAC 30 VDC Screw terminal	-
References	Source Output	TM2DD08TT	TM2DD016TK	TM2DD032TK	TM2DRA8RT	TM2DRA16RT
	Sink Output	TM2DD08UT	TM2DD016UK	TM2DD032UK	-	-

Type of module	Analog Inputs / Outputs					
Characteristics	2I Current/Voltage	2I Thermocouple	4I Current/Voltage Temperature	8I Current/Voltage	8I Temperature	8I PTC
References	TM2AMI2HT	TM2AMI2LT	TM2AMI4LT	TM2AMI8HT	TM2ARI8LRJ TM2ARI8LT	TM2ARI8HT

Type of module	Analog Inputs / Outputs				
Characteristics	1O Current/Voltage	2O Voltage	2I Current/Voltage 1O Current/Voltage	2I Temperature 1O Current/Voltage	4I Current/Voltage 2O Current/Voltage
References	TM2AMO1HT	TM2AVO2HT	TM2AMM3HT	TM2ALM3LT	TM2AMM6HT

For HMI Controllers Magelis XBTGT/GK with control function, see pages 1/36 to 1/38.



SoMachine

2

Type of card		Integrated controller card
Variable speed drive compatibility		Altivar 71 / Altivar 61 (1)
Power supply		24 VDC
Inputs	Digital	10 x 24 V DC inputs, 4 of which can be used for 2 high-speed counter inputs (100 kHz) or 2 incremental encoders (A/B) (100 kHz)
	Analog	2 x 0...20 mA inputs
Outputs	Digital	6 transistor outputs (2 A) - source
	Analog	2 x 0...20 mA outputs
Built-in communication ports	RJ45 port	Ethernet Modbus TCP, Web/FTP Server
	SUB-D connector (male 9-way)	Master CANopen bus (16 slaves)
	USB Mini-B port	SoMachine software programming
Real-time clock		Integrated
Typical time (for 1000 Boolean instructions)		942 µs
Data storage memory FRAM (Ferroelectric RAM)		64 KB
Compiled program size (saved in flash memory)		2 MB
User program size		1 MB
References		VW3A3521

(1) Refer to motion & drives essential guide or consult www.schneider-electric.com



Type of card	I/O expansion cards (2)	
Designation	I/O extension logic	Extended
Description	1 relay logic output ("C/O" contact) 4 x 24 VDC positive or negative logic inputs 2 x 24 VDC open collector positive or negative logic outputs 1 input for PTC probes	1 x 0...20 mA differential current analog input 1 software-configurable voltage (0...10 VDC) or current (0...20 mA) analog input 2 software-configurable voltage (±10V, 0...10 VDC) or current (0...20 mA) analog inputs 1 relay logic output ("C/O" contact) 4 x 24 VDC positive or negative logic inputs 2 x 24 VDC open collector positive or negative logic outputs 1 input for PTC probes 1 frequency control input
References	VW3A3201	VW3A3202

(2) Altivar 71 / 61 variable speed drives can only take one I/O expansion card with the same reference



SoMachine

Type	OEM machine programming software		
Compatibility	Modicon M238 - Logic controller Modicon M258 - Logic controller Modicon LMC058 - Motion controller Magelis XBT GC - HMI controllers XBT GT/GK with control function - HMI controllers Altivar IMC - Drive controller		
IEC 61131-3 Programming languages	IL (Instruction List) LD (Ladder Diagram) SFC (Sequential Function Chart) ST (Structured Text) FBD (Function Block Diagram) CFC (Continuous Function Chart)		
Languages	English French German Italian Spanish Simplified Chinese.		
System Requirements	Processor: Pentium 3 - 1.2 GHz or higher RAM Memory: 2 GByte; recommended: 3 GByte Hard Disk: 3.5 GB, recommended: 4 GB OS: Windows XP Professional, Windows Vista 32 Bit Drive: DVD reader Display: 1024 × 786 pixel resolution or higher Peripherals: a Mouse or compatible pointing device Peripherals: USB interface Web Access: Web registration requires Internet access		
Licence type	Trial (30 days)	1 (Single)	10 (Team)
References DVD	MSDCHNSFNV30	MSDCHNLMUA	MSDCHNLMTA

2

Simplify machine programming and commissioning

The SoMachine software solution, developed specifically for OEM machine builders, allows you to design, commission and service your machine in a single environment. It helps you get to market faster and gives your machines a competitive advantage.

A single software suite to create and manage your complete automation solution from control and HMI to remote devices.

Flexible and Scalable Control platforms include:

- Controllers:
 - > HMI controllers: XBT GC, XBT GT/GK CANopen,
 - > Logic controllers: Modicon M238, Modicon M258,
 - > Motion Controller Modicon LMC 058,
 - > Integrated Controller Card Altivar IMC,
 - > Modicon TM2, TM5 and TM7 I/O offers
 - HMI:
 - > HMI Magelis graphic panels: XBT GT, XBT GK, HMI STO, HMI STU, XBT GH
- SoMachine is a professional, efficient, and open software solution integrating Vjeco-Designer. It integrates also the configuring and commissioning tool for motion control devices. It features all IEC 61131-3 languages, integrated field bus configurators, expert diagnostics and debugging, as well as outstanding capabilities for maintenance and visualisation.

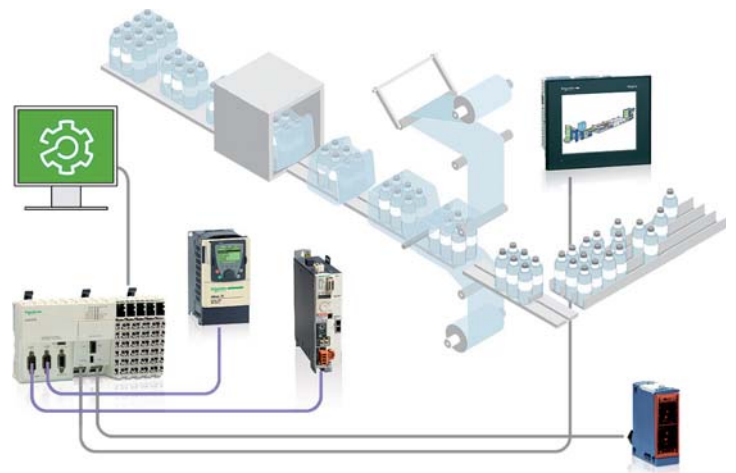

1

- | | | | |
|---|---|---|---|
| <p>Software suite</p> <p>for controllers, HMI, and remote devices.</p> | <p>Download</p> <p>to transfer the entire machine program in a single step</p> | <p>Connection</p> <p>to access to a device</p> | <p>File</p> <p>Create and maintain a single project file</p> |
|---|---|---|---|



Type of processor			Standard	High-performance			
Number of racks			2 (4, 6, 8 or 12 slots)	4 (4, 6, 8 or 12 slots)			
Maximum configuration			Maximum 24 slots for processor and modules (excluding power supply module)	Maximum 48 slots for processor and modules (excluding power supply module)			
Functions	Max. no. (1)	Discrete I/O	512	1024			
		Analog I/O	128	256			
		Control channels	Programmable loops (via CONT-CTL process control EFB library)				
		Counter channels	20	36			
		Motion control	–	Independent axes on CANopen bus (via MFB library)	–	Independent axes on CANopen bus (via MFB library)	
	Integrated connections		Ethernet TCP/IP	–		1 RJ45 port, 10/100 Mb/s, with Transparent Ready class B10 standard web server	
			CANopen master bus Integrated port	–	1 (SUB-D9)	–	1 (SUB-D9)
			Serial link	1 RJ45 port, Modbus master/slave RTU/ASCII or character mode (non isolated RS 232C/RS 485), 0.3...19.2 Kb/s			
			USB port	1 port, 12 Mb/s			
		Communication module	Ethernet TCP/IP	1 RJ45 port, 10/100 Mb/s with: - Transparent Ready class B30 standard web server with BMX NOE 0100 module - Transparent Ready class C30 configuration web server with BMX NOE 0110 module			
Internal user	Total capacity	2048 Kb	4096 Kb				
RAM	Program, constants and symbols	1792 Kb	3584 Kb				
	Data	128 Kb	256 Kb				
Execution time for one instruction	Boolean	0.18 µs	0.12 µs				
	On words or fixed point arithmetic	Single-length words	0.38 µs	0.25 µs			
		Double-length words	0.26 µs	0.17 µs			
	On floating points	1.74 µs	1.16 µs				
No. of K instructions executed per ms	100% Boolean	5.4 Kinst/ms	8.1 Kinst/ms				
	65% Boolean and 35% fixed arithmetic	4.2 Kinst/ms	6.4 Kinst/ms				
System overhead	Master task	1.05 ms	0.70 ms				
	Fast task	0.20 ms	0.13 ms				
References			BMXP341000	BMXP342000	BMXP3420102 BMXP342020 BMXP3420302		

(1) Only affects in-rack modules. The remote I/O on the CANopen bus are not included in these maximum numbers.

Memory cards



Type of card	8 MB memory card	8 MB memory card + 8 MB files	8 MB memory card + 128 MB files
Use	Supplied as standard with each processor. Used for:	As replacement for the memory card supplied as standard with each processor, used for:	
	Backup of program, constants, symbols and data		
	–	File storage, 8 MB	File storage, 128 MB
	Activation of class B10 web server		
Compatibility	BMXP341000/20...	BMXP3420...	
References	BMXRMS008MP	BMXRMS008MPF	BMXRMS0128MFP

2



Type of module		Ethernet Network Communication		
Speed		10/100 Mb/s		10/100 Mb/s
Protocols		Modbus TCP	TCP/IP (Uni-TE, Modbus)	EtherNet/IP and Modbus/TCP
Conformity class		Transparent Ready class B30		
Communication service	I/O Scanning service	Yes		Yes
Transparent Ready	FDR service	Yes (client/server)		Yes (client / server)
	SNMP network management service	Yes		Yes (agent)
	Global Data service	Yes		No
	SOAP/XML Web service	No	Server	-
	Bandwidth management	Yes		Yes
	Qos	-		Yes
	RSTP	-		No SOAP
References		BMXNOE0100	BMXNOE0110	BMXNOC0401
Memory card	Use	Provides services conforming to Transparent Ready: Class B		No
			Class C 32 MB available for user web pages	
References		BMXRWSB000M	BMXRWSFC032M	

Qos: Quality of Service - RSTP: Rapid Spanning Tree Protocol



Type of module		PROFIBUS DP V1		
Designation		PROFIBUS Remote Master (Ethernet Modbus TCP/PROFIBUS DP V1) compatible with all programmable automation under UNITY and supporting the I/O scanning service		
		Standard version 0...65°	Hardened version -25...70°, varnished	
Speed		9.6 Kb...12 Mb		
Interface		RS485 isolated (Sub-D 9 pin female connector)		
PROFIBUS Services		Master Class 1 and 2, support for 125 slaves, Sync & Freeze, Extended diagnostics. Delivered with communication DTM allowing any FDT tool to access the PROFIBUS slaves from the Ethernet network by way of the PROFIBUS Remote Master		
References		TCSEGPA23F14F	TCSEGPA23F14FK	

Type of module	Serial link (1)	AS-Interface (1)
Number of interfaces	2	1
Speed	115 Kbits/s	-
Profile	-	M4 (AS-i V3)
References	BMXNOM0200	BMXEIA0100

(1) For BMXNOC0401 (EtherNet/IP), Profibus DP Gateway TSX EGPA23F14F, Modbus Plus Gateway TCS EGDB23F24FA

Communication modules



Type of module		RTU communication
Designation		Communication
Protocols		IEC 60870-5-101, DNP3 (subset level 3), Modbus/TCP, IEC 60870-5-104, DNP3 IP, DNP3 (subset level 3), Multi-protocols master slave
Ports	Ethernet port	10BASE-T/100BASE-TX or PPPoE (PPP Protocol over Ethernet) for ADSL external modem
	Serial port	Non-isolated RS 232/485 (Serial link) or RS232 external modem (Radio, PSTN, GSM, GPRS/3G)
Conformity class		Transparent Ready class C30
Transparent Ready communication services	I/O Scanning service	-
	Global Data service	-
	NTP me synchronization	Yes
	FDR service	Yes (client)
	SMTP e-mail notification service	Yes
	SOAP/XML Web service	Server
	SNMP network management service	Yes (agent)
RTU communication services	Master or Slave configuration	Yes, IEC101/104 and DNP3, with Pull through routing of events
	RTU clock synchronization	via RTU protocol or NTP
	Time stamped data and events exchanges	Yes, IEC101/104 and DNP3, polled interrogations, Report by exception (RbE), unsolicited responses
	Time stamped events buffering and date stamped events	up to 100000 events, backup of events on power fail (10000)
	Automatic bacfill of time stamped events to Master/SCADA	Yes, on network disconnection/reconnection
	Data logging service	in CSV files in SD card memory (128 MB)
	Email/SMS service	Alarm and report notification
Memory Card	SD card 128 MB	Web server and Data logging CSV files
Reference		BMXNOR0200H



Type of module	Power supply modules				
Voltage	24 VDC isolated	24...48 VDC isolated	100...240 VAC		
Nominal input current	1A at 24 VDC	1.65 A at 24 VDC 0.83 A at 48 VDC	0.61 A at 115 VAC 0.31 A at 220 VDC	1.04 A at 0.52 A	100...150 VDC
Micro-break duration	≤ 1				
Integrated protection	Via internal fuse (not accessible)				
Max. useful power	17W	32 W	20 W	36 W	
Max. dissipated power	8.5 W				
Removable connectors (set of 2)	supplied as standard	BMXXTSCPS10 (cage clamp)			
	to be ordered separately	BMXXTSCPS20 (spring-type)			
References	BMXCPS2010	BMXCPS3020	BMXCPS2000	BMXCPS3500	BMXCPS3504 (1)

Racks



Designation	Racks			
Type of modules to be installed	BMX CPS power supply, BMX P34 processor, I/O modules and application-specific modules (counter, communication)			
No. of slots	4	6	8	12
References	BMXXBP0400	BMXXBP0600	BMXXBP0800	BMXXBP1200

Rack extensions

Designation	Rack extension module	Kit for rack extension
	Standard module to interconnect rack	A complete assembly kit for to racks distant from 0.8 m or less
References	BMXXBE1000	BMXXBE2005



Type of module			DC input modules					
Number of inputs			16	16	32	64	16	16
Connection			Screw or spring-type 20-way removable terminal block		1 connector 40-way	2 connectors 40-way	Screw or spring-type 20-way removable terminal block	
Nominal input values			Voltage		24 V	48 V	24 V	125 VDC
			Current		3.5 mA	2.5 mA	1 mA	3 mA
			Logic		Positive (<i>sink</i>)			Negative (<i>source</i>)
Input limit values			At state 1		Voltage		≥11 V	≥34 V
					Current		> 2 mA (for U ≥11 V)	> 2 mA (for U ≥34 V)
			At state 0		Voltage		< 5 V	< 10 V
					Current		≥1.5 mA	≥0.5 mA
References			BMXDDI1602	BMXDDI1603	BMXDDI3202K	BMXDDI6402K	BMXDAl1602	BMXDDI1604 (1)

2



Type of module			AC input modules					
Number of inputs			16			8		
Connection			Screw or spring-type 20-way removable terminal block					
Nominal input values			Voltage		24 VAC	48 AC	100...120 VAC	200...240 VAC
			Current		3 mA			10.4 mA
			Frequency		50/60 Hz			
Input limit values			At state 1		Voltage		≥15 V	≥34 V
					Current		≥2 mA	≥2.5 mA
			At state 0		Voltage		≤5 V	≤10 V
					Current		≤1 mA	≤4 mA
References			BMXDAl1602	BMXDAl1603	BMXDAl1604	BMXDAl0805 (2)		



Type of module			DC solid state output modules			
Number of inputs			16	16	32	64
Connection			Screw or spring-type 20-way removable terminal block		One 40-way connector	Two 40-way connectors
Nominal output values			Voltage		24 VDC	
			Current		0.5 V	
			Logic		Positive (<i>source</i>)	Negative (<i>sink</i>)
Output limit values			Voltage (ripple included)		19...30 (possible up to 34 V, limited to 1 hour in every 24 hours)	
			Current per channel		0.625 A	
			Current per module		0.125 A	
Maximum dissipated power			4	2.26	3.6	6.85
References			BMXDDO1602	BMXDDO1612	BMXDDO3202K	BMXDDO6402K



Type of module		Triac output modules
Number of inputs		16
Connection		Screw or spring-type 20-way removable terminal block
Operating voltage	Nominal	100...240 VAC
	Limit	85...288 VAC
Currents	Maximum	0.6 per channel, 2.4 per common, 4.8 for all 4 commons.
	Minimum	25 mA at 100 V a, 25 mA at 240 V a.
Maximum inrush current		≤ 20/cycle
Reference		BMXDAO1605



Type of module		Relay output modules		
Number of inputs		8	16	8
Connection		Screw or spring-type 20-way removable terminal block		
Max. operating voltage	DC	10...34 VDC	24...125 VDC (resistive load)	
	AC	10...264 VAC	200...264 VAC (Cosφ = 1)	100...150 VDC
Response time	Activation	< 10 ms		
	Deactivation	< 8 ms	< 12 ms	
Dissipated power		2.7 W max	3 W	
References		BMXDRA0805	BMXDRA1605	BMXDRA0804 (1)



Type of module		24 VDC mixed I/O modules			
		Inputs	Solid state outputs	Inputs	Solid state outputs
Number of I/O		8	8	16	16
Connection		Screw or spring-type 20-way removable terminal block		One 40-way connector	
Input limit values	At state 1	Voltage	≥11V	≥11V	
		Current	≥3 mA (for U ≥11)	≥2 mA (for U ≥11)	
	At state 0	Voltage	5 V	5 V	
		Current	≤1.5 mA	≤1.5 mA	
Sensor power supply (ripple included)		19...30 V (possible up to 30 V, limited to 1 hour in every 24 hours)			
Output limit values	Voltage (ripple included)		19...30 (possible up to 30 V, limited to 1 hour in every 24 hours)		
	Current	per channel	0.625 A	0.125 A	
		per module	5 A	3.2 A	
Maximum dissipated power		3.7 W		4 W	
References		BMXDDM16022		BMXDDM3202K	

Discrete I/O modules



Type of module		Mixed input/relay output modules	
		24 VDC inputs	24 VDC or 24...240 VAC relay outputs
Number of I/O		8	8
Connection		Screw or spring-type 20-way removable terminal block	
Nominal values	Inputs	Voltage	24 VDC (positive logic)
		Current	3.5 mA
	Outputs	DC voltage	24 VDC
		DC	2 (resistive load)
		AC voltage	220 VAC, Cosφ = 1
AC	2 A		
Input limit values	At state 1	Voltage	≥11V
		Current	≥2 mA (for U ≥ 11 V)
	At state 0	Voltage	5 V
		Current	≤1.5 mA
Sensor power supply (ripple included)		19...30 V (possible up to 30 V, limited to 1 hour in every 24 hours)	
Maximum dissipated power		3.1 W	
Reference		BMXDDM16025	

2



Counter and motion control modules



Type of module	Analog input module				
Input type	Isolated high-level inputs	Isolated high-level inputs	Non isolated high-level inputs	Isolated inputs, low-level voltage, resistors, temperature probes, thermocouples	
Number of channels	4	8	8	4	8
Nature of inputs	± 10 V, ± 5 V, 0...5 V, 0...10 V, 1...5 V 0...20 mA, 4...20 mA, ± 20 mA			±40 mV, ±80 mV, ±160 mV, ±320 mV, ±640 mV, ±1.28 V	
Resolution	0.35 mV/0.92 µA			15 mV + sign	
References	BMXAMI0410	BMXAMI0810 (1)	BMXAMI0800 (1)	BMXART0414	BMXART0814

Type of module	Analog output module		
Output type	Isolated high-level outputs		Non isolated high-level outputs
Number of channels	2	4	8
Range	Voltage	± 10 V	–
	Current	0...20 mA and 4...20 mA	–
Resolution	15 bits + sign		
References	BMXAMO0210	BMXAMO0410 (1)	BMXAMO0802 (1)

Type of module	Mixed analog I/O module	
Channel type	Non-isolated high-level inputs	Non-isolated high-level outputs
Number of channels	4	2
Ranges	±10 V, 0...5 V, 0...10 V, 1...5 V, 0...20 mA, 4...20 mA	
Maximum conversion value	Voltage	± 11.25 V
	Current	0...30
Resolution	14 bits, 12 bits, 13 bits, 12 bits	12 bits, 11 bits
Reference	BMXAMM0600	

Type of module	Counter module			Motion Control Module
	32 bits	16 bits	32 bits	
Modularity	2 channels	8 channels	4 channels	4 channels
No. of sensor inputs	6 per channel	2 per channel	3 per channel	4 auxiliary inputs
No. of actuator outputs	2 per channel			2 auxiliary outputs
Module cycle time	1 ms	5 ms		–
Applications	Upcounting, downcounting, measurement, frequency meter, frequency generator, axis following	Upcounting, downcounting, measurement		Frequency generator, Move, set position
References	BMXEHC0200	BMXEHC0800		BMXMSP0200



Type of module	SSI encoder interface
Number of channels	3
Encoder support	8 to 31 bits, 24V
Auxiliary input	2
Reflex output	3
Baud rate	100K to 1MHz
Module cycle time	1 ms
Functions	Capture, compare and event, modulo, reduction, offset
Reference	BMXEAE0300

2

Connection accessories



Removable terminal blocks	20-way			28-way	
	For use with modules	BMX AMI 0410 - BMX AM0 0210 - BMX AMM 0600 - BMX EHC 0800			BMX MSP 200, BMX AMI 0800 / AMI 0810
For use with TOR modules	All 8 and 16 channel modules				
Composition	Cage clamp	Screw clamp	Spring-type	–	–
Type of connection	–	–	–	Spring-type	Screw clamp
References	BMXFTB2000	BMXFTB2010	BMXFTB2020	BMXFTB2820	BMXFTB2800

Some racks, power supply, communication modules and specific modules, plus all the analog modules are now available in «ruggedized version». The references of these products end by a H.



Type of processor		TSX 5710	TSX 5720	TSX 5730
		4 racks max.	16 racks max.	16 racks max.
Number of I/O in racks	Discrete	512	1024	1024
	Analog	24	80	128
Integrated process control		No / Yes	30 loops / Yes	45 loops / Yes
Application-specific channels (counter, position control, weighing)		8	24	32
Bus	AS-Interface cabling system	2	4	8
	CANopen machine bus	1	1	1
	INTERBUS, Profibus DP fieldbus	–	1	3
Networks (Ethernet, Modbus Plus, Fipway)		1	2	3
Memory capacity	Without PCMCIA extension	96 Kb data/prog.	160/192 Kb data/prog. (1)	192/208 Kb data/prog. (1)
	With PCMCIA extension	96 Kb data/224 Kb prog.	160/192 Kb data (1)/768 Kb prog.	192/208 Kb data (1)/1,75 MB prog.
Execution time for one instruction without ext. PCMCIA	Boolean	0.19 µs	0.19 µs	0.12 µs
	On word or arithmetic	0.25 µs	0.25 µs	0.17 µs
Reference	Without integrated port	TSXP57104M (6)	TSXP57204M (6)	TSXP57304M (6)
	Integrated Ethernet	TSXP571634M (2) (6)	TSXP572634M (6)	TSXP573634M (6)
	Integrated CANopen	–	–	–
	Integrated Fipio	TSXP57154M (6)	TSXP57254M (6)	TSXP57354M (6)

Processors under PL7 software



Type of processor		TSX 5710	TSX 5720	TSX 5730
		4 racks max.	16 racks max.	16 racks max.
Number of I/O in racks	Discrete	512	1024	1024
	Analog	24	80	128
Integrated process control		No	30 loops	45 loops
Application-specific channels (counter, position control, weighing)		8	24	32
Bus	AS-Interface cabling system	2	4	8
	CANopen machine bus	1 (with TSXP57103M)	1	1
	INTERBUS, Profibus DP fieldbus	–	1	2
Networks (Ethernet, Modbus Plus, Fipway)		1	1	3
Memory capacity	Without PCMCIA extension	32 K words data/prog.	48 K words data/prog. (4)	64/80 K words data/prog. (4)
	With PCMCIA extension	32 K words data/64 K words prog.	32 K words data (4)/160 K words prog.	80/96 K words data (4)/384 K words prog.
Execution time for one instruction without ext. PCMCIA	Boolean	0.19 µs	0.19 µs	0.12 µs
	On word or arithmetic	0.25 µs	0.25 µs	0.17 µs
Reference	Without integrated port	TSXP57103M (6)	TSXP57203M (6)	TSXP57303AM (6)
	Integrated Ethernet	–	TSXP572623M (6)	TSXP573623AM (6)
	Integrated Fipio	TSXP57153M (6)	TSXP57253M (6)	TSXP57353AM (6)
	Integrated Ethernet and Fipio	–	TSXP572823M (6)	–

(1) The second value corresponds to the integrated memory capacity when the processor is equipped with a Fipio manager integrated link

(2) Processor with double format

(3) PC format card on PCI bus

(4) The second value corresponds to the processor with integrated Fipio bus manager link.

(5) with PL7 V4.4 min.

(6) For coated version add C at the end of the reference: example **TSXP571634M** becomes **TSXP571634MC**

HotStandBy offer



	TSX 5740 16 racks max.	TSX 5750 16 racks max.	TSX 5760 16 racks	TSXH5724M 16 racks	TSXH5744M 16 racks
	2048	2048	2048	512	512
	256	512	512	80	128
	60 loops / Yes	90 loops / Yes	90 loops / Yes	30 loops / Yes	60 loops / Yes
	64	64	64	16 (serial communication)	16 (serial communication)
	8	8	8	0	0
	1	1	1	0	0
	4	5	5	0	0
	4	4	4	2	4
	320 Kb data/prog.	1024 Kb data/prog.	2048 Kb data/prog.	192 Kb	440 Kb
	440 Kb data/2 MB prog.	1024 Kb data/7 MB prog.	2048 Kb data/7 MB prog.	192 Kb data/768 Kb prog.	440 Ko data/2 MB prog.
	0.06 µs	0.037 µs	0,037 µs	0,039 µs	0,039 µs
	0.07 µs	0.045 µs	0,045 µs	0,054 µs	0,054 µs
	-	-	-	TSXH5724M (6)	TSXH5744M (6)
	TSXP574634M (6)	TSXP575634M (6)	TSXP576634M (6)		
	-	-	-		
	TSXP57454M (6)	TSXP57554M (6)	-		

2

Modicon Premium Programmable Automation Controller

Memory extensions for Unity Pro processors



Type of PCMCIA card		Application		Additional data
Technology		SRAM	Flash EPROM only	SRAM
Memory size	96 Kb	–	TSXMFPB096K (3)	–
	128 Kb	TSXMRPP128K	TSXMFP128K	–
	224 Kb	TSXMRPP224K / TSXMCPC224K	TSXMFP224K	–
	384 Kb	TSXMRPP384K	TSXMFP384K	–
	448 Kb	TSXMRPC448K (1)	–	–
	512 Kb	–	TSXMCPC512K (2) / TSXMFP512K	–
	768 Kb	TSXMRPC768K (1)	–	–
	1 MB	TSXMRPC001M (1) (6)	TSXMFP001M	–
	1.7 MB	TSXMRPC01M7	–	–
	2 MB	TSXMRPC002M (1)	TSXMCPC002M (2) / TSXMFP002M	–
	3 MB	TSXMRPC003M (1) (6)	–	–
	4 MB	–	TSXMFP004M	TSXMRPF004M
	7 MB	TSXMRPC007M (1) (6)	–	–
	8 MB	–	–	TSXMRPF008M

(1) By configuration, the user can reserve part of the memory space for data storage (recipes, production data) on request.

(2) These cards have an additional SRAM area for storing data (recipes, production data).

(3) Backup cartridge of the program when this one reside entirely in PLC internal memory.

Memory extensions for PL7 processors



Type of PCMCIA card		Application		Additional data
Technology		SRAM	Flash EPROM only	SRAM
Memory size (4)	32 K words	TSXMRPP128K	TSXMFP128K	–
	64 K words	TSXMRPP224K	TSXMFP224K	–
	64 K words/128 K words	TSXMRPP384K	TSXMCPC224K	–
	96 K words	–	TSXMFPB096K	–
	128 K words	TSXMRPC448K	TSXMFP384K	–
	128 K words/128 K words	TSXMRPC768K (5)	–	–
	256 K words	TSXMRPC001M (6)	–	–
	256 K words/640 K words	TSXMRPC01M7 (5)	–	–
	384 K words/640 K words	TSXMRPC002M	–	–
	512 K words	TSXMRPC003M (5) (6)	–	–
	992 K words/640 K words	TSXMRPC007M (6)	–	–
	2048 K words	–	–	TSXMRPF004M

(4) The 1st value corresponds to the size of the application area, the second to the size of the additional data area for storing data (recipes, production data, etc).

(5) These cards have an additional SRAM area for storing application object symbols.

(6) For coated version add C at the end of the reference: example **TSXMRPC001M** becomes **TSXMRPC001MC**

Power supply modules (1)



Type of power supply module for	Premium					Atrium (2)
Input voltage	24 VDC		100...240 VAC	100...120/200...240 VAC		24 VDC
Output voltage	5 VDC/24 VDC					
Total useful power	26 W	50 W	26 W	50 W	77 W	26 W
Format	Standard	Double	Standard	Double	Double	–
Reference	TSXPSY1610M (4)	TSXPSY3610M (4)	TSXPSY2600M (4)	TSXPSY5500M (4)	TSXPSY8500M (4)	TSXPSI2010

(1) Process power supplies see chapter 6 "Power supply"

(2) Only for Atrium slot-PLCs under Unity

2

Racks



Type of rack	Non extendable		Extendable
For configuration	Mono-rack		Multi-rack (16 max.)
	Dimensions WxDxP		
Reference	4 positions	188 x 160 x 151,5 mm (3)	–
	6 positions	261,6 x 160 x 151,5 mm (3)	TSXRKY6 (4)
	8 positions	335,3 x 160 x 151,5 mm (3)	TSXRKY8 (4)
	12 positions	482,6 x 160 x 151,5 mm (3)	TSXRKY12 (4)
			TSXRKY4EX (4)
			TSXRKY6EX (4)
			TSXRKY8EX (4)
			TSXRKY12EX (4)

(3) Height of I/O modules : 151,5 mm with HE 10 or SUB-D connectors, 165 mm with screw terminals

(4) For coated version add C at the end of the reference: example **TSXPSY1610M** becomes **TSXPSY1610MC**

Connection accessories

Type	Bus X daisy chaining cable for extendable racks	Line terminators and accessories
	–	Set of 2
Reference	–	TSXTLYEX
	–	TSXTVSY100 (2 Bus X Transient voltage suppressor)
	L = 1 m	TSXCBY010K
	L = 3 m	TSXCBY030K
	L = 5 m	TSXCBY050K
	L = 12 m	TSXCBY120K
	L = 18 m	TSXCBY180K
	L = 28 m	TSXCBY280KT
	L = 38 m	TSXCBY380KT
	L = 50 m	TSXCBY500KT
	L = 72 m	TSXCBY720KT
	L = 100 m	TSXCBY1000KT

Modicon Premium Programmable Automation Controller

Discrete I/O modules



Type of module		Discrete inputs				
Connection		By screw terminals TSXBLY01 (1)		By HE 10 connector (2) high density		
Number of isolated channels		8	16	16 (3)	32	64
Input voltage	24 VDC	TSXDEY08D2 (5)	TSXDEY16D2 (5)	TSXDEY16FK (5)	TSXDEY32D2K (5)	TSXDEY64D2K (5)
	48 VDC	–	TSXDEY16D3 (5)	–	TSXDEY32D3K (5)	–
	24 VAC	–	TSXDEY16A2 (4) (5)	–	–	–
	48 VAC	–	TSXDEY16A3 (5)	–	–	–
	100...120 VAC	–	TSXDEY16A4 (5)	–	–	–
	200...240 VAC	–	TSXDEY16A5 (5)	–	–	–

- (1) Terminal block to be ordered separately
- (2) For use with Modicon ABE7 wiring system
- (3) Module with high-speed isolated inputs (filtering from 0.1 to 7.5 ms) able to activate the event-triggered task
- (4) Module also compatible with 24 VDC negative logic



Type of module		Discrete outputs							
		Solid state				Relay			Triac
Connection		By screw terminals TSXBLY01 (1)		By HE10 conn. (2)		By screw terminals TSXBLY01 (1)			
Number of protected channels		8	16	32	64	8	16	8	16
Output voltage/current	24 VDC/0,5 A	TSXDSY08T2 (5)	TSXDSY16T2 (5)	–	–	–	–	–	–
	24 VDC/2 A	TSXDSY08T2 (5)	–	–	–	–	–	–	–
	24 VDC/0,1 A	–	–	TSXDSY32T2K (5)	TSXDSY64T2K (5)	–	–	–	–
	48 VDC/1 A	TSXDSY08T31 (5)	–	–	–	–	–	–	–
	48 VDC/0,25 A	–	TSXDSY16T3 (5)	–	–	–	–	–	–
	24...48 VDC-24...240 VAC/5 A Th.c	–	–	–	–	TSXDSY08R5A (5)	–	–	–
	24...120 VAC/5 A Th.c	–	–	–	–	TSXDSY08R4D (5)	–	–	–
	24...120 VAC/1 A	–	–	–	–	–	–	–	TSXDSY16S4 (5)
	48...240 VAC/1 A	–	–	–	–	–	–	–	TSXDSY16S5
	48...240 VA /2 A	–	–	–	–	–	–	TSXDSY08S5	–
	24 VDC-24...240 VAC/3A	–	–	–	–	TSXDSY08R5 (5)	TSXDSY16R5 (5)	–	–

- (1) Terminal block to be ordered separately
- (2) For use with Modicon ABE7 wiring system



Type of module		Discrete I/O	
Connection		By HE 10 connector (2) high density	
Number of inputs		16 high-speed	
Number of protected outputs		12 solid state	12 reflex or timed
Output voltage/current	24 VDC/0,5 A	TSXDMY28FK (5)	TSXDMY28RFK (5)

- (2) For use with Modicon ABE7 wiring system
- (5) For coated version add C at the end of the reference: example TSXDEY08D2 becomes TSXDEY08D2C

Connection accessories: See www.schneider-electric.com

Analog I/O modules



Type of module		Analog input					
		High level with common point			High level isolated	Low level isolated	
Connection		By 25-way SUB-D connector					
Number of channels		4 high-speed	8	16	8	16	4
Resolution		16 bits	12 bits		16 bits	16 bits	16 bits
Isolation	Between channels	Common point	Common point	Common point	± 200 VDC	± 100 VDC	± 2830 Vrms
	Between channels and earth	~ 1000 Vrms	~ 1000 Vrms	~ 1000 Vrms	~ 1000 Vrms	~ 1000 Vrms	~ 1780 Vrms
Reference	High level input (2)	TSXAEY420 (7)	TSXAEY800 (7)	TSYAEY1600 (7)	TSXAEY810 (7)	–	–
	Multi-range	–	–	–	–	TSXAEY1614 (3)(7)	TSXAEY414 (4)(7)

(1) Screw terminals **TSXBLY01** to be ordered separately

(2) ± 10 V, 0...10 V, 0...5 V, 1...5 V, 0...20 mA, 4...20 mA

(3) ± 63 mV thermocouple (B, E, J, K, L, N, R, S, T, U)

(4) ± 10 V, ± 5 V, 0...10 V, 0...5 V, 1...5 V, 0...20 mA, 4...20 mA, -13...+63 mV, 0...400 W, 0...3850 W, thermal probe, thermocouple



Type of module		Analog output	
		Isolated	With common point
Connection		By screw terminals TSXBLY01 (5)	By 25-way SUB-D connector
Number of channels		4	8
Resolution		11 bits + sign	13 bits + sign
Isolation	Between channels	~ 1500 Vrms	Common point
	Between channels and earth	~ 1500 Vrms	~ 1000 Vrms
Reference	Input signal (6)	TSXASY410 (7)	TSXASY800 (7)

(5) Terminal block to be ordered separately

(6) ± 10 V, 0...10 V, 0...20 mA, 4...20 mA.

(7) For coated version add C at the end of the reference: example **TSXAEY420** becomes **TSXAEY420C**

Modicon Premium Programmable Automation Controller Counter modules



Type of module	Counter		Counter/measurement	Electronic cam
Type of inputs for	Sensors (2) Incremental encoders (3)		Sensors (2) Encoders (3)(4)	Incremental encoders (3) Absolute encoders (5)
Counting	40 kHz		500 kHz/200 kHz (5)	
Cycle time module	5 ms	10 ms	1 ms	–
Number of channels	2	4	2	128 cams
Number of axes	–	–	–	1
Reference	TSXCTY2A (1)	TSXCTY4A (1)	TSXCTY2C (1)	TSXCCY1128 (1)

(1) For coated version add **C** at the end of the reference: example TSXCTY2A becomes TSXCTY2AC

(2) For 2/3-wire PNP/NPN 24 VDC sensors

(3) For 5 VDC RS422, 10...30 VDC Totem Pole incremental encoders

(4) For SSI serial or parallel output absolute encoders

(5) For RS485 serial or parallel output absolute encoders

Motion control modules



Module type	For translators (amplifier for stepper motor)		For analog control servomotors (for asynchronous and brushless motors)		
Control outputs	RS 422		+/- 10 V		
Compatible with drives	Lexium 05, Twin Line		Lexium 05 / 15 LP, MP and HP, Twin Line, Lexium 32		
Functions	Linear axes	–	Limited	Limited or infinite	Limited or infinite(6)
	Slave axes	–	With static ratio	With dynamic ratio	–
Frequency for each axis	187 kHz		500 kHz with incremental encoder, 200 kHz with absolute encoder (7)		
Number of axes	1	2	2	4	3
Reference	TSXCFY11 (1)	TSXCFY21 (1)	TSXCAY21 (1)	TSXCAY41 (1)	TSXCAY22 (1) TSXCAY42 (1) TSXCAY33 (1)

(6) With linear interpolation on 2 or 3 axes

(7) SSI serial or with parallel outputs



Module type	Servomotors with SERCOS® digital ring (for brushless motors)		
Control outputs	SERCOS® network ring		
Compatible with ranges	Lexium 15 LP, MP, HP and Lexium 32 modular drive		
Functions	Linear or infinite independent axes, slave axes with cam profile or ratio		
Processing	4 sets of axes with linear interpolation from 2 to 8 axes	4 sets of axes with linear and circular interpolation from 2 to 3 axes (8)	4 sets of axes with linear interpolation from 2 to 8 axes
Frequency for each axis	4 MB SERCOS® network ring		
Number of axes	8 (9)	8 (9)	16 (10)
Reference	TSXCSY84	TSXCSY85	TSXCSY164

(8) TSXCSY85 module supplied with TJE trajectory editor: linear trajectories with links between segments according to polynomial or circular interpolation and circular trajectories.

(9) 8 real axes, 4 imaginary axes and 4 remote axes

(10) 16 axes (real axes, imaginary and remote axes)

Weighing modules



Type of module	ISP Plus	
	supplied uncalibrated	supplied calibrated and  offer
Load cell inputs / outputs	50 measurements (for 1 to 8 load cells) / 2 discrete and 1 RS 485 for display unit	
Reference	Without display unit	TSXISPY101 (1)
	With display unit TSXXBTN410	TSXISPY121
		Please consult Schneider Electric

Connection accessories: See www.schneider-electric.com

Communication modules



Type of module		Ethernet network communication					
Speed		10 Mb/s	10/100 Mb/s				
Standard services		Ethway, Modbus TCP (Uni-TE, Modbus)	Modbus TCP (Uni-TE, Modbus)			EtherNet/IP & Modbus TCP	
Transparent Ready	Class	C10	B30	B30	C30	D10	B30
	Global Data	–	Yes	Yes	Yes	–	–
	I/O Scanning	–	Yes	Yes	Yes	–	Yes
	QoS (3)	–	–	–	–	–	Yes
Web server	TCP Open	Yes	–	–	Yes	–	–
	Standard services	Yes	Yes	Yes	Yes	Yes	Yes
	FactoryCast services	Yes	–	–	Yes	–	–
Reference	FactoryCast HMI services	–	–	–	–	Yes	–
		TSXETY110WS (4)	TSXP57 (1)	TSXETY4103 (4)	TSXETY5103 (4)	TSXWMM100 (4)	TSXETC101 (2)

(1) References: see pages 2/38 and 2/39, Premium processors with integrated Ethernet TCP/IP port

(2) Seamless integration of Modbus and EtherNet/IP environments. Full integration in Unity (FDT/DTM technology). Available Unity V5

(3) QoS: Quality of Service

Profibus DPV1 is available for Modicon Premium

Please refer to page 3/23



Type of module	AS-Interface cabling system	CANopen machine bus	Fipio manager fieldbus	INTERBUS fieldbus	Profibus DP V0 fieldbus
Name and description	In-rack	PCMCIA	Integrated port	In-rack	In-rack
Speed	167 Kb/s	20 K...1 Mb/s	1 Mb/s	0.5 Mb/s	9.6 K...12 Mb/s
Reference	TSXSAY1000 (4)	TSXCPP110 (4)	TSXP57 (2)	TSXIBY100 (4)	TSXPBY100

(2) References: see pages 2/38 and 2/39, Premium processors with integrated Fipio port



Type of module		Serial links					
		Uni-Telway			Modbus		ASCII
Name and description		Integrated port	In-rack	PCMCIA	In-rack	PCMCIA	PCMCIA
Speed		19.2 Kb/s	19.2 Kb/s	1.2...19.2 Kb/s	19.2 Kb/s	1.2...19.2 Kb/s	1.2...19.2 Kb/s
Reference	With interface	RS 485	TSXP57 (1)	TSXSCY21601 (3) (4)	TSXSACP114 (4)	TSXSCY11601 (4)	TSXSACP114 (4)
		RS 232D	–	–	TSXSACP111 (4)	–	TSXSACP111 (4)
		20mA CL	–	–	TSXSACP112 (4)	–	TSXSACP112 (4)

(3) Also designed for Modbus serial (channel 0).



Type of module	Other networks		
	Modbus Plus	Fipway	Fipio (agent function)
Name and description	PCMCIA card	PCMCIA card	PCMCIA card
Speed	1 Mb/s	1 Mb/s	1 Mb/s
Reference	TSXMBP100 (4)	TSXFPP20 (4)	TSXFPP10 (4)

(4) For coated version add C at the end of the reference: example TSXETY110WS becomes TSXETY110WSC

Connection accessories: See www.schneider-electric.com

Modicon Quantum Programmable Automation Controller Processors under Unity Pro software



2

Type of processor		Simple applications	Simple and medium complexity applications
Max. number of discrete I/O (1)	Local	Unlimited (27 slots max.)	
	Remote/distributed	31744 inputs (RIO)/8000 inputs (DIO) and 31744 outputs (RIO)/8000 outputs (DIO)	
Max. number of analog I/O (1)	Local	Unlimited (27 slots max.)	
	Remote/distributed	1984 inputs (RIO)/500 inputs (DIO) and 1984 outputs (RIO)/500 outputs (DIO)	
Type of application-specific I/O		Counter, motion control, high-speed interrupt inputs, time-stamp, serial link, AS-Interface sensor/actuator bus	
Communication ports (2)	Integrated Modbus	2 RS 232/RS 485	2 RS 232
	Modbus Plus	1 integrated, 2 in local rack	1 integrated, 6 in local rack
	Ethernet TCP/IP	2 in local rack	6 in local rack
	Fieldbus	Profibus DP: 2 in local rack	Profibus DP: 6 in local rack
Memory capacity	Internal RAM	548 KB	1056 KB
	With PCMCIA extension	–	–
	File storage	–	–
Reference		140CPU31110 (4)	140CPU43412U (4)

- (1) The maximum values for the number of discrete or analog I/O are not cumulative
- (2) The numbers of communication modules are not cumulative, 2 or 6 in local rack, depending on model
- (3) Processor compatible with Unity Pro software after updating its firmware (via OS-Loader included in Unity Pro)
- (4) For coated version add C at the end of the reference: example **140CPU31110** becomes **140CPU31110C**
- (5) Suitable for safety related application up to SIL2 and SIL3
- (6) Reference to be completed by "0" or "1" according to the required distance :
 - **140CPU67260**: multi-mode fiber up to 4 km,
 - **140CPU67261**: single mode fiber up to 16 km.



Complex applications				Hot Standby redundant applications			
Unlimited (26 slots max.)				Unlimited (13 slots max.)	Unlimited (26 slots max.)	Unlimited (13 slots max.)	Unlimited (26 slots max.)
31744 inputs (RIO)/8000 inputs (DIO) and 31744 outputs (RIO)/8000 outputs (DIO)				31744 inputs and 31744 outputs	31744 inputs (RIO)/8000 inputs (DIO) and 31744 outputs (RIO)/8000 outputs (DIO)	31744 inputs and 31744 outputs	31744 inputs (RIO)/8000 inputs (DIO) and 31744 outputs (RIO)/8000 outputs (DIO)
Unlimited (27 slots max.)				Unlimited (13 slots max.)	Unlimited (27 slots max.)	Unlimited (13 slots max.)	Unlimited (27 slots max.)
1984 inputs (RIO)/500 inputs (DIO) and 1984 outputs (RIO)/500 outputs (DIO)				1984 inputs and 1984 outputs	1984 inputs (RIO)/500 inputs (DIO) and 1984 outputs (RIO)/500 outputs (DIO)	1984 inputs and 1984 outputs	1984 inputs (RIO)/500 inputs (DIO) and 1984 outputs (RIO)/500 outputs (DIO)
Intrinsically safe I/O, counter, motion control, high-speed interrupt inputs, time-stamp, serial link, AS-Interface sensor/actuator bus				–		–	–
1 RS 232/485				1 RS 232/485	1 RS 232/485	1 RS 232/485	1 RS 232/485
1 integrated, 6 in local rack				1 integrated	1 integrated, 6 in local rack	1 integrated	1 integrated, 6 in local rack
1 integrated, 6 in local rack				1 integrated, 6 in local rack	6 in local rack	1 integrated, 6 in local rack	6 in local rack
Profibus DP: 6 in local rack				–	Profibus DP: 6 in local rack	–	Profibus DP: 6 in local rack
768 KB	1024 KB	3072 KB	1024 KB	1024 KB	1024 MB	3072 KB	
7 MB	7 MB	7 MB	7 MB	7 MB	7 MB	7 MB	7 MB
8 MB	8 MB	8 MB	–	8 MB	–	8 MB	8 MB
140CPU65150 (4)	140CPU65160 (4)	140CPU65260 (4)	140CPU65160S (5)	140CPU67160 (4)	140CPU67160S (5)	140CPU67260 (6)	

2

Modicon Quantum Programmable Automation Controller

Power supply modules ⁽¹⁾



2

Type of power supply module for			Quantum				
Input voltage			24 VDC	48...60 VDC	100...150 VDC	120...130 VAC	115/230 VAC
Output current			8 A/3 A (5)	8 A	8 A/3 A	8 A/3 A	11 A
Reference	Type	Standalone (2)	140CPS21100 (3)	–	140CPS51100 (3)	140CPS11100 (3)	–
		Summable	140CPS21400 (3)	140CPS41400 (3)	–	–	140CPS11420 (3)
		Redundant	140CPS22400 (3)	140CPS42400 (3)	140CPS52400 (3)	–	140CPS12420 (3)

(1) For power supplies, see chapter 5.

(2) The output current for the standalone power supply modules is 3 A

(3) For coated version add C at the end of the reference: example **TSXMRPC001M** becomes **TSXMRPC001MC**

(4) For safety application, PV4 version is the one certified as non-interfering.

PCMCIA memory extensions



Type of PCMCIA card for Unity processors 140CPU65/67		Application		Additional data
Technology		SRAM	Flash EPROM	SRAM
Memory size	512 Kb/512 Kb (6)	–	TSXMCP512K (5)	–
	1 MB (7)	TSXMRPC001M (3)	TSXMFPP001M	–
	2 MB (7)	TSXMRPC002M	TSXMFPP002M	–
	2 MB/1 MB (6)	–	TSXMCP002M	–
	3 MB (7)	TSXMRPC003M (3)	–	–
	4 MB	–	TSXMFPP004M	TSXMRPF004M
	7 MB (7)	TSXMRPC007M (3)	–	–
	8 MB	–	–	TSXMRPF008M

(3) For coated version add C at the end of the reference: example **TSXMRPC001M** becomes **TSXMRPC001MC**

(5) These cards have an additional SRAM area for storing data (recipes, production data).

(6) The 1st value corresponds to the size of the application area, the second to the size of the additional data area for storing data (recipes, production data, etc)

(7) By configuration the user can reserve part of the memory space for data storage (recipes, production data, etc)

Racks

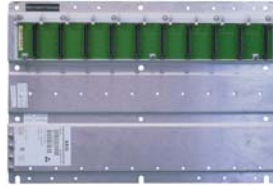

Type		Racks	
	Dimensions WxDxH		
References	2 slots	104x104x290 mm	140XBP00200 (2)
	3 slots	143x104x290 mm	140XBP00300 (2)
	4 slots	184x104x290 mm	140XBP00400 (2)
	6 slots	265x104x290 mm	140XBP00600 (2)
	10 slots	428x104x290 mm	140XBP01000 (2)
	16 slots	671x104x290 mm	140XBP01600 (2)
	Rack extension module		140XBE10000 (1) (2)

(1) Local extension module, to be placed in main rack and secondary rack.

(2) For coated version add C at the end of the reference: example 140XBP00200 becomes 140XBP00200C

Quantum Ethernet adaptors



Ethernet head and drop adaptors (1)		
Type	Quantum Ethernet I/O head adaptor (2)	Quantum Ethernet RIO drop adaptor (2)
Description	Provides 1 adaptor per Quantum Ethernet I/O CPU rack	Provides 1 module per Quantum Ethernet RIO rack
References	140CRP31200 (3)	140CRA31200 (3)

(1) Requires Unity Pro Extra large software ≥ V7.0, (see page 2/54).

(2) For additional characteristics, see our website www.schneider-electric.com

(3) Conformal coating version for harsh environments. In this case, add the letter "C" to the end of the reference.

Connection accessories (1)

Type	Cable for extension racks (main and secondary)	
References	L = 1 m	140XCA71703
	L = 2 m	140XCA71706
	L = 3 m	140XCA71709

(1) Other accessories: See www.schneider-electric.com

Modicon Quantum Programmable Automation Controller

Discrete I/O modules



Type of module (5)		Discrete inputs					
Connection		By screw terminals 140XTS00200 (to be ordered separately)					
Number of isolated channels		16	4 groups of 8	3 groups of 8	2 groups of 8	6 groups of 16	8 groups of 2
Input voltage	5 VDC TTL (negative logic)	–	140DDI15310	–	–	–	–
	24 VDC	–	140DDI35300(1)(2)	–	–	140DDI36400	–
	10...60 VDC	–	140DDI85300	–	–	–	140DDI84100
	20...30 VDC	–	140DSI35300(1)	–	–	–	–
	125 VDC	–	–	140DDI67300	–	–	–
	24 VAC	140DAI34000	140DAI35300	–	–	–	–
	48 VAC	140DAI44000	140DAI45300	–	–	–	–
	115 VAC	140DAI54000	140DAI55300	–	140DAI54300	–	–
230 VAC	140DAI74000	140DAI75300	–	–	–	–	

(1) For negative logic, replace 00 at the end of the reference with 10, for example **140DDI35300** becomes **140DDI35310**.

(2) Non-interfering module in safety related application



Type of module (5)		Discrete outputs					
		Solid state					
Connection		By screw terminals 140XTS00200 (to be ordered separately)					
Number of protected channels		16	4 groups of 8	4 groups of 4	2 groups of 8	6 groups of 16	2 groups of 6
Output voltage/current	5 VDC TTL/0.075 A (3)	–	140DDO15310	–	–	–	–
	24 VDC/0.5 A	–	140DDO35301(1) 140DDO35300(2)	–	–	–	–
	10...30 VDC/0.5 A (4)	–	140DVO85300	–	–	–	–
	19.2...30 VDC/0.5 A	–	–	–	–	140DDO36400	–
	10...60 VDC/2 A	–	–	–	140DDO84300	–	–
	24...125 VDC/0.75 A	–	–	–	–	–	140DDO88500
	24...48 VAC/4 A	–	–	140DAO84220	–	–	–
	24...115 VAC/4 A	140DAO84010	–	–	–	–	–
	24...230 VAC/ 4-3 A	140DAO84000	140DAO85300	–	–	–	–
	100...230 VAC/4-3 A	–	–	140DAO84210	–	–	–

(1) For negative logic, replace 01 at the end of the reference with 10, for example **140DDO35301** becomes **140DDO35310**.

(2) Non-interfering module in safety related application

(3) Negative logic

(4) Controlled outputs



Type of module (5)		Discrete I/O			Discrete outputs	
		Solid state			Relay	
Connection		By screw terminals 140XTS00200 (to be ordered separately)				
Number of I/O		2 groups of 8/2 groups of 4		1 group of 4/ 4 isolated	–/16 NO	–/8 NO/NC
Input voltage		24 VDC	115 VAC	125 VDC	–	–
Output voltage/current		24 VDC / 4 A	115 VAC / 8 A	24...125 VDC / 16 A	2 A	5 A
Reference		140DDM39000	140DAM59000	140DDM69000	140DRA84000	140DRC83000

(5) For coated version add C at the end of the reference: example **140DDI15310** becomes **140DDI15310 C**

Connection accessories: See www.schneider-electric.com

Analog I/O modules



Type of module (4)	Analog inputs				
Connection	By screw terminals 140XTS00200 (to be ordered separately)				
Number of channels	8	16	8		
Input signal	4...20 mA 1...5 V	0...25/20 mA 4...20 mA	(1)	Thermal probe Pt, Ni	Thermocouple (2)
Resolution	12 bits	0...25000 points	16 bits	12 bits + sign	16 bits
Reference	140ACI03000	140ACI04000 (3)	140AVI03000	140ARI03010	140ATI03000

(1) 0...25 mA, ± 20 mA, 4...20 mA, 0...10 V, ± 10 V, 0...5 V, ± 5 V, 1...5 V.

(2) Type B, E, J, K, R, S, T, mV

(3) Non-interfering module in safety related application



Type of module (4)	Analog output		
Connection	By screw terminals 140XTS00200 (to be ordered separately)		
Number of channels	4	8	4
Input signal	4...20 mA	0...25/20 mA 4...20 mA	0...10 V, ± 10 V 0...5 V, ± 5 V
Resolution	12 bits	0...25000 points	12 bits
Reference	140ACO02000 (3)	140ACO13000	140AVO02000

(3) Non-interfering module in safety related application



Type of module (4)	Analog I/O
Connection	By screw terminals 140XTS00200 (to be ordered separately)
Number of inputs	4
Number of outputs	2
Input signal	0...20 mA, ± 20 mA, 4...20 mA, 0...10 V, ± 10 V, 0...5 V, ± 5 V, 1...5 V.
Resolution	Inputs 16 bits, outputs 12 bits
Reference	140AMM09000

(4) For coated version add C at the end of the reference: example 140ACI03000 becomes 140ACI03000C

Connection accessories: See www.schneider-electric.com

Modicon Quantum Programmable Automation Controller

Counter and special purpose modules



Type of module	High-speed counter		High-speed inputs with interrupt	Time-stamp system
Type of inputs for	Incremental encoders		Discrete 24 VDC (1)	Discrete 24...125 VDC
Counting frequency	100 kHz	500 kHz	–	–
Number of channels	5	2	16	32
Reference	140EHC10500	140EHC20200	140HLI34000	140ERT85420

(1) 3 operating modes: Interrupt, latch, high-speed inputs, on rising or falling edge.

Safety I/O modules



Type of modules	Analog	Discrete	
Connection	Screw terminal		
Number of inputs	8 analog inputs	16 discrete inputs	–
Number of outputs	–	–	16 discrete outputs
Input signal	4...20mA	24VDC	–
Output voltage	–	–	24VDC
Resolution	16 bits	–	–
Certification	Suitable for safety related application up to SIL2 and SIL3, UL, CE, CSA, Haz-loc		
Reference	140SAI94000S	140SDI95300S	140SDO95300S

Communication modules



Type of module		Ethernet TCP/IP network				
Speed		10/100 Mb/s			10/100/1000 Mb/s	
Protocol		Modbus TCP	EtherNet/IP & Modbus TCP	Modbus TCP	Modbus TCP	EtherNet/IP & Modbus TCP
Transparent Ready	Class	B30	B30	C30	D10	B30
	Global Data	Yes	–	Yes	–	–
	I/O Scanning	Yes	Yes	Yes	–	Yes
	FDR server	Yes	Yes	Yes	–	Yes
	SNMP protocol	Yes	Yes	Yes	Yes	Yes
	QoS (1)	–	Yes	–	–	Yes
IP routing function		–	–	–	–	Yes
Web server	Standard services	Yes	Yes	Yes	Yes	–
	FactoryCast services	–	–	Yes	Yes	–
	FactoryCast HMI services	–	–	–	Yes	–
Reference		140CPU651* (2)	140NOC78000	140NOE77111 (3)	140NWM10000	140NOC78100

(1) QoS: Quality of Service

(2) 140 CPU 651 50, 140 CPU 651 60, 140 CPU 652 60

(3) Non-interfering module in safety related application. All references with «Non-interfering module in safety related application» are certified as non-interfering.

PROFIBUS DPV1 is available for Modicon Quantum

Please refer to page 3/23



Type of module	Modbus Plus network	AS-Interface cabling system	Fieldbus Profibus DP Master V1 (1)
Name and description	Integrated link	In-rack	In-rack
Speed	1 Mb/s	167 Kb/s	to 12 Mb/s
Reference	140CPU*	140EIA92100	PTQPDPMV1

(1) From your partner Prosoft, www.prosoft-technology.com

* 140 CPU 311 10, 140 CPU 434 12U, 140 CPU 651 50, 140 CPU 651 60, 140 CPU 652 60, 140 CPU 671 60, 140 CPU 672 60, 140 CPU 672 61



Type of module	Serial link Modbus	ASCII
Name and description	Integrated link	In-rack
Speed	19.2 Kb/s	19.2 Kb/s
Reference	140CPU* (1)	140ESI06210

(1) RS 232/RS 485 on 140CPU6●●●● processors and RS 232 on 140CPU31110, 140CPU43412A, 140CPU53414A processors.

* 140 CPU 311 10, 140 CPU 434 12U, 140 CPU 651 50, 140 CPU 651 60, 140 CPU 652 60, 140 CPU 671 60, 140 CPU 672 60, 140 CPU 672 61

To operate in a corrosive environment, Quantum modules can be ordered with a conformal coating applied to components of the product. Conformal coating will extend its life and enhance its environmental performance capabilities. To order conformal coating append a C to the standard catalog number. For example, 140CPS 11420 > 140CPS 114 20C

Automation systems Unity Pro, configuration software For Modicon M340, Premium, and Quantum



2

Software type		Unity Pro Small version 7.0			
License type version 7.0		Single (1 workstation)	Group (3 workstations)	Team (10 workstations)	Facility (100 workstations)
References	Software pack	UNYSPUSFUCD70	UNYSPUSFGCD70	UNYSPUSFTCD70	–
	Upgrade Legacy Software (1)	UNYSPUSZUCD70	UNYSPUSZGCD70	UNYSPUSZTCD70	–
Software type		Unity Pro Medium version 7.0			
License type version 7.0		Single (1 workstation)	Group (3 workstations)	Team (10 workstations)	Facility (100 workstations)
References	Software pack	UNYSPUMFUCD70	UNYSPUMFGCD70	UNYSPUMFTCD70	–
	Upgrade Legacy Software (2)	UNYSPUMZUCD70	UNYSPUMZGCD70	UNYSPUMZTCD70	–
Software type		Unity Pro Large version 7.0			
License type version 7.0		Single (1 workstation)	Group (3 workstations)	Team (10 workstations)	Facility (100 workstations)
References	Software pack	UNYSPULFUCD70	UNYSPULFGCD70	UNYSPULFTCD70	UNYSPULFFCD70
	Upgrade Legacy Software (3)	UNYSPULZUCD70	UNYSPULZGCD70	UNYSPULZTCD70	UNYSPULZFC70
Software type		Unity Pro Extra Large version 7.0			
License type version 7.0		Single (1 workstation)	Group (3 workstations)	Team (10 workstations)	Facility (100 workstations)
References	Software pack	UNYSPUEFUCD70	UNYSPUEFGCD70	UNYSPUEFTCD70	UNYSPUEFFCD70
	Upgrade Legacy Software (4)	UNYSPUEZUCD70	UNYSPUEZGCD70	UNYSPUEZTCD70	UNYSPUEZFC70

(1) From Concept S, PL7 Micro, ProWORX NxT Lite and ProWORX 32 Lite

(2) From Concept S/M, PL7 M/J, ProWORX NxT Lite and ProWORX 32 Lite

(3) From Concept S /M, PL7 M/J/P, ProWORX NxT Lite and ProWORX 32 Lite

(4) From all models Concept, PL7, ProWORX NxT and ProWORX 32

Unity Pro, is common programming software for debugging and operation of Modicon M340, Premium, and Quantum programmable controller ranges. Unity Pro takes the recognized usage values of PL7 and Concept software and offers a complete set of new functions for improved productivity and opening to other software.

Five IEC61131-3 languages are supported as standard in Unity Pro with all debugging functions, either on the simulator or directly online with the programmable controller.

Additional LL984 language is now available in Unity V7.0 to allow easy migration of Modsoft an Concept applications to Quantum platforms.

Thanks to symbolic variables independent of memory, structured data and user function blocks, application objects are a direct reflection of the automated process application components. Unity Pro operator screens are user-configured in the application from graphic libraries. Operator accesses are simple and direct. The converters integrated in Unity Pro automatically convert PL7 and Concept IEC 61131-3 standards and applications.

Unity V7.0 fully support new Quantum Ethernet IO architecture (Quantum and X80 drops) with improved OnLine changes in RUN possibilities. It integrates new Network Manager (for easy routing of Ethernet network) , as well as new powerful Trending Tool (for easy monitoring of variables). FDT DTM management is greatly improved thanks to copy/paste and Global Access function.

Unity software

Specialized software

2

Unity Pro application comparison software

Software type		Unity Dif
Licence type version 2.21		Single (1 workstation), French and English languages (software and documentation)
Reference	Software extension (1)	UNYSDUZFUCD22
Licence type version 2.21		Site licence (100 workstations), French and English languages (software and documentation)
Reference	Software extension (1)	UNYSDUZFFCD22

(1) Requires version Unity V2.1 or later

EF/EFB function development software in C language

Software type		Unity EFB Toolkit
Licence type version 3.1		Single (1 workstation), English language (software and documentation)
References	Software pack	UNYSPUZFUCD31E
	Renewal	UNYCSPSPUZBU

Process application design and generation software

Software type		Unity UAG (Unity Application Generator)	
Licence type version 3.2		Single (1 workstation)	Site (> 10 workstations)
References	Software pack	UAGSEWLFUCD32	UAGSEWLFCD23

Specific libraries according to the software used

Library type	Control Libraries				
Designation	Predictive Control Library (for Unity Pro and Concept)	Fuzzy Control Library (for Unity Pro)	TeSys Library (for Unity Pro)	HVAC Library (for Unity Pro)	Flow Calculation Library (for Unity Pro)
Licence type	Single Licence (1 work station)				
Reference	UNYLPZCAUCD10	UNYLFZZAUWB12	UNYLTSAUWB10	UNYLHVZAUWB10	UNYLAGZAUWB20

Library type	UAG Libraries	
Designation	Device and Process Library (for UAG)	Process Application Library (for UAG)
Licence type	Single Licence (1 workstation)	
Reference	UAGSBTDFUWB13	UAGSBTXFUWB20

*Includes Process Application Library (PAL) V2.0 and Device and Process Library (DPL) V1.0

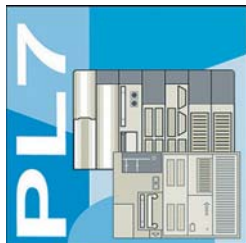

PL7 is the common programming, debugging and operating software for the TSX Micro and Premium ranges of PLCs as well as Atrium coprocessors (see pages 3/12, 3/18 and 3/26).

PL7 offers 4 IEC languages: Instruction List (IL), Ladder Diagram (LD), Structured Text (ST) and Sequential Function Chart (SFC). You can use the most suitable language for each function in your application, making use of the multi-tasking structure of the processors.

For using application-specific functions, PL7 directly integrates the application-specific screens required for configuration and adjustment as well as supervisory and diagnostics activities.

Type of software		PL7 Micro for TSX Micro platform			
Type of license version 4.5		Single (1 station)	Single with SyCon V2.8	Group (3 stations)	Open Team (10 stations)
Reference	Software package	TLXCDPL7MP45	TLXCDPL7MPC45	TLXCD3PL7MP45	TLXOTPL7MP45M
	Update (1)	TLXRCDPL7MP45M	TLXRCDPL7MPC45M	TLXRCD3PL7MP45M	–
		PL7 Junior for TSX Micro/Premium and Atrium coprocessor platforms			
Type of license version 4.5		Single (1 station)	Group (3 stations)		
Reference	Software package	TLXCDPL7JP45	TLXCD3PL7JP45		
	Update (1)	TLXRCDPL7JP45M	TLXRC3DPL7JP45M		
	Upgrade (2)	TLXUCDPL7JP45M	TLXUCD3PL7JP45M		
		PL7 Pro for TSX Micro/Premium and Atrium coprocessor platforms			
Type of license version 4.5		Single (1 station)	Group (3 stations)	Open Team (10 stations)	Open Site
Reference	Software package	TLXCDPL7PP45	TLXCD3PL7PP45	TLXOTPL7PP45M	TLXOSPL7PP45M
	Update (1)	TLXRCDPL7PP45M	TLXRCD3PL7PP45M	–	–
	Upgrade (2)	TLXUCDPL7PP45M	TLXUCD3PL7PP45M	–	–

(1) From the previous software version.

(2) From lower level, earlier version software.

Specialist tools

EF function development software in C language

Type of software		PL7 SDKC for EF function development software in C language
PL7 SDKC software extension		For PL7 Micro/Junior/Pro
Reference		TLXLSDKCPL741M

Development of applications in C language

Type of software		PL7 FUZ for processing process applications using fuzzy logic
PL7 FUZ software extension		For PL7 Micro/Junior/Pro, TSX Micro/Premium
Reference		TLXLPL7FUZ34M

Comparison of PL7 applications

Type of software		PL7 DIF for comparison of applications	
PL7 DIF software extension		For PL7 Pro, TSX Micro/Premium	
Type of license		Single (1 station)	Site (> 10 stations)
Reference		TLXCDPL7DIF42	TLXOSPL7DIF42

Availability of control systems based on Premium platforms

Type of software		Warm Standby redundant
Warm Standby software extension		For PL7 Junior/Pro
Type of license		Single (1 station)
Reference		TLXCDWSBYP40F / E

Programming software

For Modicon Quantum, Momentum



Concept is the IEC programming software for the Momentum and Quantum range of PLCs. It provides advanced Microsoft Windows based tools that deliver a multi-language development environment for control system programming.

Uses familiar, standardized editors, bundled in a single application to create and integrate PLC control, communication and diagnostic logic.

Five IEC editors give users the freedom to choose the programming language that fits their application requirements: Function Block Diagram (FBD), Ladder Diagram (LD), Sequential Function Chart (SFC), Structured Text (ST) and Instruction List (IL).

Type of software		Concept for Quantum/Momentum platforms			
Type of license version 2.6		Single (1 station)	Group (3 stations)	10 users (10 stations)	Site
Software references	Concept S	372SPU47101V26	–	–	–
	Concept M	372SPU47201V26	–	–	–
	Concept XL	372SPU47401V26	372SPU47411V26	372SPU47421V26	372SPU47431V26
Update references	Concept S (3)	372ESS47101	–	–	–
	Concept M (3)	372ESS47201	–	–	–
	Concept XL (3)	372ESS47401	372ESS47403	372ESS47410	372ESS47400

(3) From an earlier software version.

2

Specialist tools

EF/EFB function development software in C language

Type of software		Concept EFB Toolkit	
Type of license		Version 2.6	Upgrade version 2.6
Reference	Software package	332SPU47001V26	372ESS47001

Concept service version limited to application loading

Type of software		Concept Application Loader	
Type of license		Version 2.6	
Reference	Software package	372SPU47701V26	

Software for designing and generating batch/process applications

Type of software		Unity UAG (Unity Application Generator)	
Type of license version 3.0		Single (1 station)	Site
Reference	Medium Software package	UAGSEWMFUCD31	UAGSEWMFFCD31
	Large Software package	UAGSEWLFUCD31	UAGSEWLFCD31



ProWORX for Modicon Quantum, Momentum

ProWORX 32 is the flexible, easy-to-use cross-platform LL984-programming software for Modicon range PLCs. It gives you the power to program your Modicon controllers online or offline, manage your I/O subsystems, and analyze your plant's activity in real-time, all in a familiar Windows environment.

ProWORX 32 provides client/server capabilities to organize user-groups and -rights, store projects at a central location and realize office-plant floor bridging.

The project emulator provides the ability to test projects prior to running them in the PLC run-time environment to ensure your system will run at peak efficiency.

Type of software		ProWORX for Quantum/Momentum platforms			
Type of license version 2.1		Single (1 station)	Group (3 stations)	Multi-user (10 stations)	Site
Software references	ProWORX 32 Server	372SPU78001PSEV	–	–	–
	ProWORX 32 Suite	372SPU78001PSSV	–	–	–
	ProWORX 32 Client, Full Dev.	372SPU78001PDEV	372SPU78001PSTH	372SPU78001PSTE	372SPU78001SITE
	ProWORX 32 Online	372SPU78101PONL	–	–	–
	ProWORX 32 Lite	372SPU71001PLDV	372SPU71001PLTH	372SPU71001PLTE	–
Upgrade to ProWORX 32 references (4)		372SPU78401LPUP	372SPU78401LPSTH	372SPU78401LPSTE	–

(4) Only possible for customers, who are "up-to-date" with CSP (continuing support program)



Vijeo Citect

Type	Supervisory control and data acquisition (SCADA) software
Compatibility	All Schneider Electric automation platforms and third party devices
Operating system	Windows XP, Windows 2003 Server, Windows 7 (32 and 64 Bit), Windows Server 2008 R2, Windows Server 2008 (32 and 64 bit)
Versions	The development licence (without network connectivity) allows free communication with PLCs for 10 minutes at a time. Vijeo Citect full server, control client and view-only client licences are available in 75 points, 150 points, 500 points, 1500 points, 5000 points, 15000 points and unlimited points Vijeo Citect Lite (without network connectivity) is available in 100 points, 150 points, 300 points, 600 points and 1200 points
References	Please contact your local sales representative

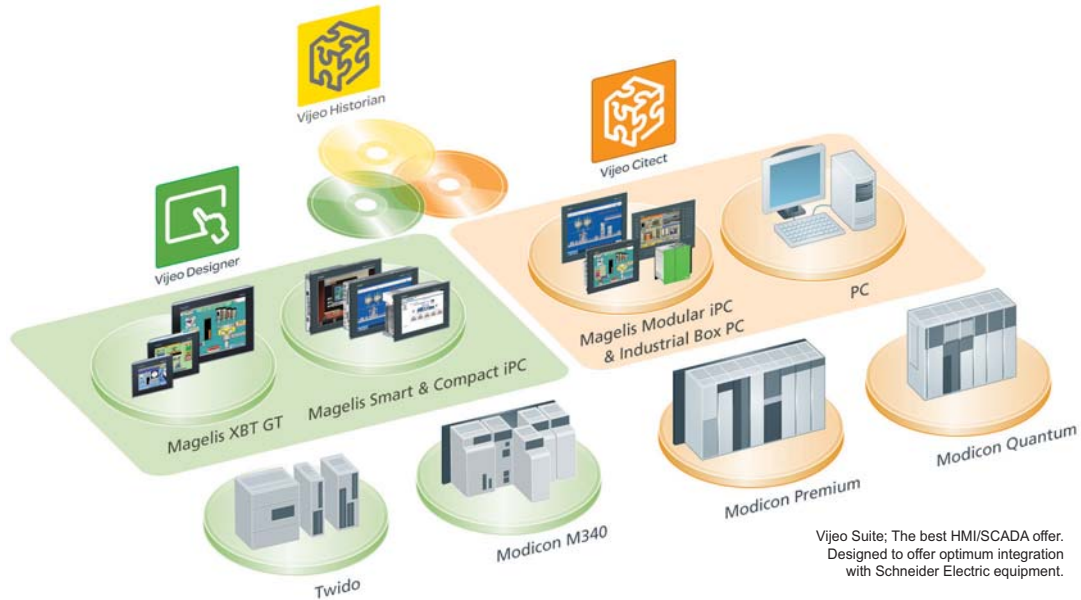

Vijeo Suite; The best HMI/SCADA offer. Designed to offer optimum integration with Schneider Electric equipment.

Vijeo Citect is a software for operating and monitoring. With its powerful visualisation capabilities and operational features, it delivers actionable insight faster, enabling operators to respond quickly to process disturbances, thereby increasing their effectiveness. Its easy-to-use configuration tools and powerful features enable you to quickly develop and deploy solutions for any size application.

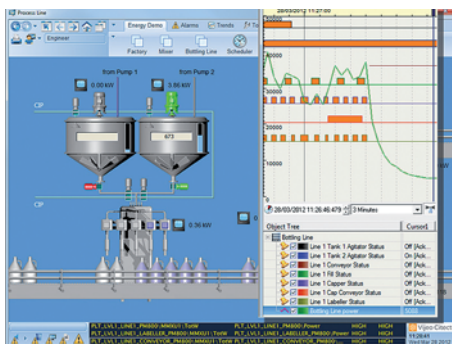

Benefits at a glance:

- **Full-redundancy for reliable architecture:** Vijeo Citect's in-built redundancy greatly reduces lost data and downtime, tolerating failure anywhere in your system.
- **Powerful graphics:** Vijeo Citect lets you develop true colour, easy-to-use graphics that provide the operator with an intuitive, consistent user interface.
- **Intuitive Process Analysis tool:** Vijeo Citect Process Analyst is an intuitive process analysis tool that sits directly in the SCADA system, providing a complete story of your plant and delivering actionable insight to the operators faster, thereby improving their efficiency and productivity.
- **Object-based configuration for rapid development:** Developing your control system is made quick and easy by Vijeo Citect's object-based configuration tools such as page templates, Genies, Super Genies, and SpeedLink.
- **Engineering with ease:** Vijeo Citect offers flexible and targeted system engineering tools to help you be more efficient. It accelerates your control system configuration process, significantly reducing your engineering time and costs and minimising your project risk.
- **Improved energy management:** Vijeo Citect and its product options allow alignment and management of power and process to improve energy efficiency.

Vijeo Historian Reporting software



Vijeo Historian

Type	Historian software
Compatibility	All Schneider Electric automation platforms and third party devices
Operating system	Windows XP® SP3 (32 bit), Windows® 2003 Server SP2 (32 bit), Windows® Server 2008 SP2 (32 and 64 bit), Windows® 7 (32 and 64 bit), Windows® Server 2008 R2
References CD-ROM PC	Please contact your local sales representative

2

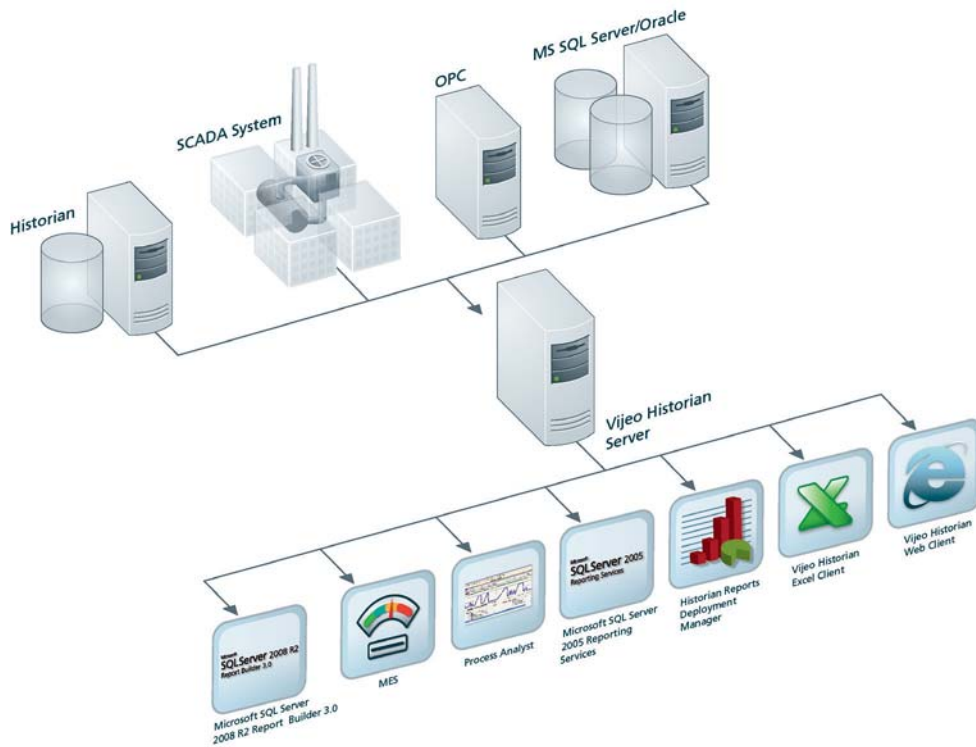

Vijeo Historian helps your plant and IT personnel to optimize operational efficiency by providing a powerful, plant-wide reporting tool that collects, and delivers meaningful reporting data from multiple, disparate systems. Comprising of historian and client functionalities, Vijeo Historian enables you to accurately store data for long-term reporting while also giving you the option of visualizing and accessing the information through the Vijeo Historian client, Microsoft Excel or Reporting Services.

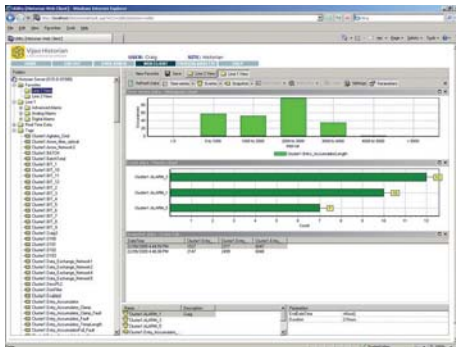

Benefits at a glance:

- **Business systems integration:** Vijeo Historian reduces the complexity and cost of bridging the divide between senior management and plant operations through its simple, easy-to-use interface and its active data transfers that push data from the control systems up to the business systems.
- **An open data store:** Vijeo Historian utilises 100% Microsoft SQL Server 2008 R2 as its embedded historical data store. Its open, industry-standard technology and trusted security integrate effortlessly into your business in a way that lowers your total cost of ownership.
- **Enterprise-wide reporting:** A range of reports can be produced using a convenient built-in historian in the familiar, open Microsoft user interface. Vijeo Historian also comes with a standard set of pre-configured reports, simplifying basic alarm and tag reporting.
- **Alarm management:** Pre-configured alarm reports based on the EEMUA (Engineering Equipment & Materials Users Association) 191 alarm management guidelines.
- **Going 'green' with the energy reports:** Energy reports help you perform a comprehensive energy assessment of your plant to determine how much energy is being consumed and how much could potentially be saved.

Altistart and Altivar

Use Altistart soft starters to start your motors smoothly and protect the mechanics of your equipment. With the Altivar range of variable speed drives, you save energy and manage the speed of your motors to optimise and enhance productivity in your installations.



3

The Altistart, Altivar and Lexium ranges increase the efficiency of your machines, reduce their energy consumption and optimise their kinematics. Easy to install, offering intuitive programming and extensive communication options, they are easily integrated into your control system architectures.



Lexium

Drives, motors and linear motion axes: Schneider Electric offers a complete range of motion control products and solutions suitable for even the most specialised applications. Designed with maximum simplicity in mind throughout a machine's entire service life, the Lexium range reduces costs and optimises productivity.

3 | Motion and Drives



This document is a selection of the top selling products.

For more information:
<http://www.schneider-electric.com>

Soft starters and variable speed drives

Selection guide	3/3 to 3/7
------------------------------	------------

Starters

Altistart 01	3/8 to 3/9
Altistart 22	3/10 to 3/11
Altistart 48	3/12 to 3/13

Drives

Altivar 12	3/14
Altivar 212	3/15
Altivar 312	3/16
Altivar 31C	3/17
Altivar 32 and 32-BMP	3/18
Altivar 61, 61Q, 61 Plus, 61 Plus-LH	3/20 to 3/27
Specific cards and extension for pumping and ventilation machines	3/28 to 3/29
Altivar 71, 71Q, 71 Plus	3/30 to 3/36
Altivar LIFT	3/37
Specific cards and extension for complex and high power machines	3/38 to 3/39

Accessories and options (Altistart and Altivar)	3/40 to 3/41
--	--------------

Drives, motors and linear motion axes

Selection guide	3/42 to 3/43
------------------------------	--------------

Drives, motors and linear motion axes

Lexium 23 Plus servo drives and Lexium BCH servo motors	3/44 to 3/45
Lexium 32 servo drives and Lexium BMH/BSH servo motors	3/46 to 3/51
Lexium 32i integrated servo drive	3/52 to 3/53
Lexium ILA/ILE/ILS/ILT/ILP integrated drives	3/54 to 3/56
Lexium SD2 stepper drives and Lexium BRS2 stepper motors	3/57
Lexium SD3 stepper drives and Lexium BRS3 stepper motors	3/57
Lexium PAS/CAS/TAS/MAX single axes and multi-axis systems Linear Motion	3/58 to 3/59

Highlights

Lexium 32i

When customization meets simplicity



The **Lexium 32i** is an integrated servo drive and comprises motor, positioning controller, power electronics, fieldbus and “Safe Torque Off” safety function in an extremely compact single device.

- The four catalogued components are easy to select via the online configurator
- Very easy to assemble: simply click on each component and secure
- Settings can be stored on the optional memory card
- With industrial connector or terminal connector module
- Lexium 32i is installed directly on the machine to improve cost and energy efficiency
- Reduce assembly time with simplified wiring and easy cabling

For more information, see page 3/52

ECO_{2.0} for HVAC

Estimate energy savings on your pump and fan applications

ECO_{2.0} is a free, multi-platform software to estimate energy savings and the payback period for an Altivar variable speed drive(*) installation.

- Easy and fast access to Energy and CO₂ information
- Customization with your own application motor data
- Direct access to your drives-related technical information
- Send and receive your project report by email
- Decision-making support to identify the optimal Energy Efficient solution
- Available for PC, tablet or smartphone online and offline as free download



*Altivar 212, Altivar 61 and Altivar 61 Plus – from 0.37 to 2400 kW



Soft starters and variable speed drives

Selection guide

Starters - Low voltage

Simple machines	Complex machines/ Special machines	
⇒Applications: Compressors, fans, pumps, conveyors, car wash gantries, etc.	⇒Applications: Pumps, fans, turbines, compressors, conveyors, conveyor belts, lifting screws, escalators, etc.	⇒Applications: Pumps, high inertia fans and machines, compressors, conveyors, agitators, mixers, escalators, etc.
Altistart 01	Altistart 22	Altistart 48
 Soft start and Soft start/soft stop units	 Soft start/soft stop units	 Soft start/soft stop units

Description		<ul style="list-style-type: none"> • Compact • Simple: easy mounting, wiring and adjustment • Efficient: Current peaks limitation on starting, reduction of mechanical shocks, increased service life for your machines • Energy saving 	<ul style="list-style-type: none"> • Innovative with its integrated Bypass contactor for motors up to 315 kW • Cost-effective • Compact dimensions • Quick setup • Protection of motor and starter • Energy saving • 3 controlled phases 	<ul style="list-style-type: none"> • Torque control system: controlled torque, prevention of pressure surges and limiting of temperature rises • Simple: quick setup • Protection of motor and starter: thermal protection, phase loss detection, locked rotor detection • Energy saving
Technical information	Power range for 50...60 Hz supply	0.37...15 kW	4... 400 kW	4...900 kW
	Voltage	Single-phase 110...480 V Three-phase 110...480 V	Three-phase 208...600 V Three-phase 230...440 V	Three-phase 208...690 V
	Drive/Output frequency			
	Motor type	Asynchronous Synchronous	Yes No	Yes No
Communication	Integrated	–	Modbus	Modbus
	As an option	Can be used with TeSys U motor starter-controller to create a complete motor starter solution	–	DeviceNet, Fipio, PROFIBUS DP, Ethernet
Standards and certifications		IEC/EN 60947-4-2, C-Tick, CSA, UL, CE	IEC/EN 60947-4-2, C-Tick, CSA, UL, CE, GOST, CCC, ABS, Class A EMC	IEC/EN 60947-4-2, C-Tick, CSA, UL, CE, DNV, GOST, CCC, NOM, SEPRO and TCF, Classes A and B EMC
Intended use		Buildings, Simple machines.	Machines, Infrastructures and Buildings	

Selection guide

Standard drives - Low voltage

Simple machines

⇒ Applications:

- Simple machines for industry (small handling applications, packaging, pumps, fans, etc.)
- Simple consumer machines (access barriers, rotating advertising hoardings, medical beds, treadmills, dough mixers, etc.)
- Other types of application:
 - Mobile machines and small appliances equipped with a power socket
 - Applications which traditionally use other solutions (2-speed DC motors, mechanical drives, etc.).

⇒ Applications:

Simple industrial machines (material handling and packaging, textile machines, special machines, pumps and fans).

⇒ Applications:

Simple industrial machines (material handling and packaging, textile machines, special machines, pumps and fans).

Altivar 12



Variable speed drives for small machines with 240 V three-phase asynchronous motor

Altivar 312



Variable speed drives for three-phase asynchronous motors

Altivar 31C IP55



Variable speed drives for three-phase asynchronous motors for machines in harsh environments.

Description

- **Compact**
- **Easy to set up** (Plug & Play)
- **Reliable, cost-effective solution** for compact machines

- **Open:** large number of communication cards available as options
- **User-friendly:** simplified interface
- **Autotuning:** maximum performance

- **Rugged** even in the most hostile environments:
 - Installed as close as possible to the motor
 - Integrated functions for applications requiring IP55 degree of protection
 - Modbus and CANopen communication protocols
- **Flexibility** to adapt to each machine:
 - Customisable depending on the model
 - Easy configuration

Technical information

Power range for 50...60 Hz supply

0.18...4 kW

0.18...15 kW

0.18...15 kW

Voltage

Single-phase 100...240 V
Three-phase 200...240 V

Single-phase 200...240 V
Three-phase 200...600 V

Single-phase 200...240 V
Three-phase 380...500 V

Drive/Output frequency

0.5...400 Hz

0.5...500 Hz

0.5...500 Hz

Motor type

Asynchronous
Synchronous

Yes

Yes

Yes

No

No

No

Communication

Integrated
As an option

Modbus

Modbus and CANopen

Modbus and CANopen

–

CANopen Daisy chain,
DeviceNet, PROFIBUS DP,
Modbus TCP, Fipio

DeviceNet, Ethernet TCP/IP,
Fipio, PROFIBUS DP





Standards and certifications

IEC/EN 61800-5-1, IEC/EN 61800-3 (environments 1 and 2, categories C1 to C3)
CE, UL, CSA, C-Tick, GOST, NOM

IEC/EN 61800-5-1, IEC/EN 61800-3 (environments 1 and 2, categories C1 to C3)
CE, UL, CSA, C-Tick, GOST

Intended use

Machines

Complex machines	Complex machines/ Special machines		Pumps and Fans	
<p>⇒ Applications: Industrial machines: hoisting, packaging, material handling, special machines (wood-working machines, metal processing machinery, etc.).</p>	<p>⇒ Applications: High performance applications:</p> <ul style="list-style-type: none"> • Material handling • Hoisting • Wood-working machines • Process machinery • Textile machines • Packaging 	<p>⇒ Applications: High performance applications:</p> <ul style="list-style-type: none"> • Material handling • Hoisting • Wood-working machines • Process machinery • Textile machines • Packaging 	<p>⇒ Applications: Range specifically for high performance pumps and fans for the industrial and building markets.</p>	<p>⇒ Applications: Pumping and ventilation machines in harsh environment</p>
<p>Altivar 32</p>  <p>Variable speed drives for asynchronous motors and open-loop synchronous motors</p>	<p>Altivar 71</p>  <p>For three-phase synchronous and asynchronous motors. Constant torque applications.</p>	<p>Altivar 71Q</p>  <p>Water-cooled variable speed drives for three-phase synchronous and asynchronous motors. Constant torque applications.</p>	<p>Altivar 61</p>  <p>Variable speed drives for three-phase asynchronous motors. Variable torque applications.</p>	<p>Altivar 61Q</p>  <p>Water-cooled variable speed drives for three-phase asynchronous and synchronous motors. Variable torque applications</p>
<ul style="list-style-type: none"> • Compact: "Book" format • Integrated Safety function compliant to IEC 61508 SIL3 and PL-e • Open: communication cards available as options • Integrated programmable logic functions • Simple setup • Energy saving : Control of energy efficient permanent magnet synchronous motors 	<ul style="list-style-type: none"> • Wide range • Quick start-up and easy diagnostics: multi-language graphic display terminal • Open to most industrial communication buses • Integrated safety • Motor control: high-performance in open-loop and closed loop mode 	<ul style="list-style-type: none"> • Improved robustness with water cooling • Efficient cooling system reduced need of air conditioning • Long time operation without maintenance • Excellent protection against corrosion due to stainless steel cooling pipes • Very high starting torque for frequent start-up applications 	<ul style="list-style-type: none"> • Wide range • Easy setup and diagnostics with the multi-language graphic display terminal • Open to the main industrial and buildings management communication buses 	<ul style="list-style-type: none"> • Improved robustness with water cooling • Efficient cooling system reduced need of air conditioning • Prolonged maintenance-free operational life • Excellent protection against corrosion due to stainless steel cooling pipes
0.18...15 kW	0.37...630 kW	90...630 kW	0.37...800 kW	110...800 kW
Single-phase 200...240 V Three-phase 380...480 V	Single-phase 200...240 V Three-phase 200...690 V	Three-phase 380...480 V Three-phase 500...690 V	Single-phase 200...240 V Three-phase 200...690 V	Three-phase 380...480 V Three-phase 500...690 V
0.1...599 Hz	0...599 Hz up to 37 kW / 200...240V and 380...480V 0...500 Hz for the rest of the range	0...500 Hz	0.1...599 Hz up to 37 kW / 200...240V and 380...480V 0.1...500 Hz for the rest of the range	0.1...500 Hz
Yes	Yes	Yes	Yes	Yes
Yes	Yes	Yes	Yes	Yes
Modbus and CANopen	Modbus and CANopen	Modbus et CANopen	Modbus and CANopen	Modbus et CANopen
EtherNet/IP, Modbus TCP, PROFIBUS DP V1, EtherCAT, Devicenet	Modbus TCP, Modbus/Uni-Telway, EtherNet/IP, DeviceNet, PROFIBUS DP, PROFIBUS DP V1, INTERBUS S, CC-Link, EtherCAT	Modbus TCP, Fipio, Modbus/Uni-Telway, Modbus Plus, EtherNet/IP, DeviceNet, PROFIBUS DP, PROFIBUS DP V1, INTERBUS S, CC-Link	Modbus TCP, Fipio, Modbus/Uni-Telway, Modbus Plus, EtherNet/IP, DeviceNet, PROFIBUS DP, PROFIBUS DP V1, INTERBUS S, CC-Link, Lonworks, METASYS N2, APOGEE FLN P1, BACnet, EtherCAT	HVAC protocols : LonWorks, BACnet, METASYS N2, APOGEE FLN P1 Industrial protocols: Modbus TCP, Modbus/Uni-Telway, Fipio, Modbus Plus, PROFIBUS DP, PROFIBUS DP V1, DeviceNet, Ethernet IP, CC-Link, INTERBUS
IEC/EN 61800-5-1, IEC/EN 61800-3 (environments 1 and 2, Categories C2 and C3), UL508C, EN 954-1 Category 3, ISO/EN 13849-1/-2 Category 3 (PLd), IEC 61800-5-2, IEC 61508 (parts 1&2) level SIL1 SIL2 SIL3, draft standard EN 50495E, CE, UL, CSA, C-Tick, GOST, NOM.	IEC/EN 61800-3, EN 55011, EN 55022, CSA, UL, C-TICK, CE, NOM, DNV, GOST	IEC/EN 61800-3, EN 55011, EN 55022, CSA, UL, C-TICK, CE, NOM, DNV, GOST	IEC/EN 61800-3, EN 55011, EN 55022, CSA, UL, C-TICK, CE, NOM, DNV, GOST	IEC/EN 61800-3, EN 55011, EN 55022, CSA, UL, C-TICK, CE, NOM, DNV, GOST
Machines	Machines, Industrial processes and Infrastructures	Machines, Industrial processes and Infrastructures	Buildings and Infrastructures	Building or Infrastructures

Selection guide

Specialized drives - Low voltage

HVAC

⇒ *Applications:*

Range specifically for HVAC applications (heating, ventilation, air conditioning) in buildings.

Lifts

⇒ *Applications:*

Lifts

Altivar 212



Variable speed drives for three-phase asynchronous motors.
Variable torque building HVAC applications.

Altivar LIFT



Variable speed drives for lifts.

Description

- **Compact size:** side-by-side mounting
- **Simplicity :** Dedicated HVAC functions and remote graphic keypad option
- **Openness :** Integrated communications for building management systems
- **EMC filters** built-in
- **Reduction of the total harmonic distortion** THDI<30%
- **Protection class:** IP21 and IP55

- **Quick start-up** and easy diagnostics with the multi-language graphic display terminal and dedicated Lift configuration menu.
- **Dedicated Lift functions** for greater comfort and safety
- **Energy saving:** Control of energy efficient permanent magnet synchronous motors

Technical information

Power range for 50...60 Hz supply

0.75...75 kW

4...22 kW

Voltage

Three-phase 200...480 V

Single-phase 200...240 V
Three-phase 200...480 V

Drive/Output frequency

0.5...200 Hz

0...599 Hz

Number of quadrants

Cooling system

Protection class

Motor type

Asynchronous

Yes

Yes

Synchronous

No

Yes

Communication

Integrated

Modbus, METASYS N2, APOGEE FLN P1, BACnet

Modbus and CANopen

As an option

Lonworks

Modbus TCP, Modbus/Uni-Telway, EtherNet/IP, DeviceNet, PROFIBUS DP, PROFIBUS DP V1, INTERBUS S, CC-Link

Standards and certifications

IEC/EN 61800-3, EN 55011, EN 55022, CSA, UL, C-TICK, CE, NOM





IEC/EN 61800-3, EN55011, EN 55022, CSA, UL, C-TICK, CE, NOM et EN81-1 (chap 12.7.3)

Intended use

Buildings

Machines

Integrated variable speed control solutions

Pumps and Fans Low voltage	Pumps and Fans Medium voltage	Complex machines/Special machines Low voltage	Complex machines/Special machines Medium voltage
<p>⇒ <i>Applications:</i></p> <ul style="list-style-type: none"> • Fans • Pumps • Compressors • Screw feeders 	<p>⇒ <i>Applications:</i></p> <ul style="list-style-type: none"> • Energy: fans, pumps, turbine starters • Oil and gas: pumps, compressors, air blowers, extruders • Mines and Minerals: conveyors, crushers, fans, pumps • Water treatment: pumps, air blowers. 	<p>⇒ <i>Applications:</i></p> <ul style="list-style-type: none"> • Fans • Pumps • Compressors • Screw feeders 	<p>⇒ <i>Applications:</i></p> <ul style="list-style-type: none"> • Energy: fans, pumps, turbine starters • Oil and gas: pumps, compressors, air blowers, extruders • Mines and Minerals: conveyors, crushers, fans, pumps • Water treatment: pumps, air blowers.
<p>Altivar 61 Plus</p>  <p>High power low voltage variable speed drives for buildings and infrastructures. Variable torque</p>	<p>Altivar 1100</p>  <p>Medium voltage variable speed drives for asynchronous motors (quotation on request)</p>	<p>Altivar 71 Plus</p>  <p>High power low voltage variable speed drives for industry. Constant torque</p>	<p>Altivar 1000</p>  <p>Medium voltage variable speed drives for asynchronous motors (quotation on request)</p>
<p>A simple, open range:</p> <ul style="list-style-type: none"> • Greater flexibility: numerous possible options and communication on most industrial networks • Easy configuration • Ready to use <p>Maximum safety: the Altivar Plus range has a cooling system and components that have been tested in extreme conditions.</p> <p>Time savings on:</p> <ul style="list-style-type: none"> • Creating quotes • Placing orders • Installation and start-up 	<p>Environmentally-friendly and Cost-effective:</p> <ul style="list-style-type: none"> • Perfect integration in the line supply • No disturbance of the motor and the driven load • High efficiency <p>Easy to install and set up</p> <p>Compact</p>	<p>A simple, open range:</p> <ul style="list-style-type: none"> • Greater flexibility: numerous possible options and communication on most industrial networks • Easy configuration • Ready to use <p>Maximum safety: the Altivar Plus range has a cooling system and components that have been tested in extreme conditions.</p> <p>Time savings on:</p> <ul style="list-style-type: none"> • Creating quotes • Placing orders • Installation and start-up 	<p>High efficiency</p> <p>For use in harsh environments</p> <p>Open to all communication networks</p> <ul style="list-style-type: none"> • Easy configuration • Ready to use
90...2400 kW	0.3...10.5 MW	90...2000 kW	0.5...10 MW
Three-phase 380...690 V	3,3 kV 6,6 kV 10 kV	Three-phase 380...690 V	2.4 kV 3.3 kV
0.1...500 Hz	Standard : 0,2...60 Hz Option : 0,2...120 Hz	0...500 Hz	Standard: 5...70 Hz Option: 5...140 Hz
2 and 4	2	2 and 4	2 and 4
Air or water cooled	Air cooled	Air or water cooled	Air or water cooled
IP23/IP54 IP55 (water cooled)	IP31 IP41 (option)	IP23/IP54 IP55 (water cooled)	IP41 (air cooled) IP54 (water cooled)
Yes	Yes	Yes	Yes
Yes	No	Yes	No
Modbus and CANopen	PROFIBUS, Modbus	Modbus and CANopen	Ethernet, PROFIBUS, Modbus
Modbus TCP, Fipio, Modbus/Uni-Telway, Modbus Plus, EtherNet/IP, DeviceNet, PROFIBUS DP, PROFIBUS DP V1, INTERBUS S, CC-Link, Lonworks, METASYS N2, APOGEE FLN P1, BACnet, EtherCAT	Ethernet, Devicenet, EtherNet/IP, DeviceNet, etc.	Modbus TCP, Fipio, Modbus/Uni-Telway, Modbus Plus, EtherNet/IP, DeviceNet, PROFIBUS DP, PROFIBUS DP V1, INTERBUS S, CC-Link, EtherCAT	Devicenet, CANopen
IEC/EN 61800-5-1, IEC/EN 61800-3 (environments 1 and 2), IEC/EN 61000-4-2, -4-3, -4-5, -4-6 (level 3), IEC/EN 61000-4-4 (level 4), IEC/EN 60529, IEC 60721-3-3 class 3C2 and 3S2, CE, DNV, GOST	IEC/EN 61800-5-1, IEC/EN 61800-4, IEC/EN 61800-3 (environnements 1 and 2, catégories C1 to C3), IEEE 519, IEC/EN 60204-11 and IEC/EN 60529	IEC/EN 61800-5-1, IEC/EN 61800-3 (environments 1 and 2), IEC/EN 61000-4-2, -4-3, -4-5, -4-6 (level 3), IEC/EN 61000-4-4 (level 4), IEC/EN 60529, IEC 60721-3-3 class 3C2 and 3S2, CE, DNV and GOST	IEC/EN 61800-5-1, IEC/EN 61800-4, IEC/EN 61800-3 (environments 1 and 2, categories C1 to C3), CE
Buildings and Infrastructures	Infrastructures	Machines, Industrial processes and Infrastructures	Machines, Industrial processes and Infrastructures



Dimensions (in mm)		width x height x depth	
ATS01	N103FT to N106 FT	Size A:	22.5 x 100 x 100.4
	N109FT to N125 FT	Size B:	45 x 124 x 130.7
	N206●● to N212●●	Size C:	45 x 124 x 130.7
	N222●● to N232●●	Size D:	45 x 154 x 130.7

Type	Soft start units	Soft start/soft stop units
Motor power	0.37 to 11 kW	0.75 to 15 kW
Degree of protection	IP20	
Reduction of current peaks	1 controlled phase	2 controlled phases
Adjustable starting time	1...5 s	1...10 s
Adjustable deceleration time	Freewheel stop	1... 10 s
Adjustable breakaway torque	30...80% of DOL motor starting torque	
Logic inputs	–	3 logic inputs (start, stop and startup boost)
Logic outputs	–	1 logic output
Relay outputs	–	1 relay output
Control supply voltage	110... 220 VAC ± 10%, 24 VDC ± 10%	Built into the starter

Soft starters for 0.37 to 11 kW motors

Motor						Starter Nominal current	Reference (2)
Motor power (1)							
Single phase	3-phase						
230 V	210 V	230 V	230 V	400 V	460 V		
kW	HP	kW	HP	kW	HP	A	
Single phase 110...230 V or 3-phase 110...480 V supply voltage, 50/60 Hz							
0,37	–	0,37	0,5	1,1	0,5	3	ATS 01N103FT Size A
		0,55	–	–	1,5		
0,75	0,5	0,75	1	2,2	2	6	ATS 01N106FT Size A
		1,1	1,5	3	3		
1,1	1	1,5	2	4	5	9	ATS 01N109FT Size B
1,5	1,5	2,2	3	5,5	7,5	12	ATS 01N112FT Size AB
2,2	2	3	5	7,5	10	25	ATS 01N125FT Size B
	3	4	7,5	9	15		
		5,5		11			

Soft start/soft stop units for 0.75 to 15 kW motors (3)

Motor		Starter Nominal current	Reference (2)
Motor power (1)			
kW	HP	A	
3-phase supply voltage: 200...240 V 50/60 Hz			
0,75/1,1	1/1,5	6	ATS 01N206LU Size B
1,5	2	9	ATS 01N209LU Size B
2,2/3	3/–	12	ATS 01N212LU Size B
4/5,5	5/7,5	22	ATS 01N222LU Size C
7,5	10	32	ATS 01N232LU Size C
3-phase supply voltage: 380...415 V 50/60 Hz			
1,5/2,2/3	–	6	ATS 01N206QN Size B
4	–	9	ATS 01N209QN Size B
5,5	–	12	ATS 01N212QN Size B
7,5/11	–	22	ATS 01N222QN Size C
15	–	32	ATS 01N232QN Size C
3-phase supply voltage: 440...480 V 50/60 Hz			
–	2/3	6	ATS 01N206RT Size B
–	5	9	ATS 01N209RT Size B
–	7,5	12	ATS 01N212RT Size B
–	10/15	22	ATS 01N222RT Size C
–	20	32	ATS 01N232RT Size C

(1) Standard power ratings of motors, HP power ratings indicated according to standard UL 508.

(2) For thermal protection of the motor, please use a thermal circuit-breaker GV●ME, GV3 P or GV7 RE.

(3) Control power supply built into the starter.

Starters with TeSys model U



Dimensions (in mm)		width x height x depth
ATSU01	N206LT/N209LT/N212LT	45 x 124 x 130.7
	N222LT/N232LT	45 x 154 x 130.7

Type		Soft start/soft stop units							
Motor power		0.75 to 15 kW							
Degree of protection		IP20							
Reduction of current peaks		Yes							
Adjustable starting and stopping times		1...10 s							
Adjustable breakaway torque		30... 80% of DOL motor starting torque							
Logic inputs		3 logic inputs (start, stop and startup boost)							
Logic outputs		1 logic output							
Relay outputs		1 relay output							
Control supply voltage		24 VDC, 100 mA, ± 10%							
References		Soft start/soft stop units	TeSys starter-controller model U Power base	Control unit (1)	Power connector between ATSU and TeSys model U				
Supply voltage		Three-phase 200...480 V							
Motor power									
230 V		400 V		460 V		Nominal current (IcL)			
kW	HP	kW	HP	kW	HP		Soft start/soft stop units	TeSys starter-controller model U	Control unit (1)
0.75	1	1.5	2	6 A		ATSU01N206LT	LUB12	LUC●05BL	VW3G4104
1.1	1.5	2.2/3	3	6 A		ATSU01N206LT	LUB12	LUC●12BL	VW3G4104
1.5	2	–	5	9 A		ATSU01N209LT	LUB12	LUC●12BL	VW3G4104
–	–	4	–	9 A		ATSU01N209LT	LUB12	LUC●12BL	VW3G4104
2.2	3	5.5	7.5	12 A		ATSU01N212LT	LUB12	LUC●12BL	VW3G4104
3	–	–	–	12 A		ATSU01N212LT	LUB32	LUC●18BL	VW3G4104
4	5	7.5	10	22 A		ATSU01N222LT	LUB32	LUC●18BL	VW3G4104
5.5	7.5	11	15	22 A		ATSU01N222LT	LUB32	LUC●32BL	VW3G4104
7.5	10	15	20	32 A		ATSU01N232LT	LUB32	LUC●32BL	VW3G4104

(1) To compose your reference, replace ● in the reference with: «A» for a standard control unit, «M» for a multifunction unit and «B» for an advanced unit.



Dimensions (in mm)		width x height x depth	
ATS22	D17 to D47	Size A:	130 x 265 x 169
	D62 to D88	Size B:	145 x 295 x 207
	C11 to C17	Size C:	150 x 356 x 229
	C21 to C41	Size D:	206 x 425 x 299
	C48 to C59	Size E:	304 x 455 x 340

Supply voltage		Three phase 208...600 V	Three phase 230...440 V
Protection	Degree of protection	IP20: for ATS 22D17●●●D88 starters IP00: for ATS 22C11●●●C59 starters (protection of terminals available as an option)	
	Motor thermal protection	Class 10, 20 or 30 (1)	
Drive	Number of controlled phases	3	
	Types of control	Configurable voltage ramp, torque ramp	
	Operating cycle	Standard	
Functions		Integrated Bypass contactor	
Number of I/O	Analog inputs	1 PTC probe	
	Logic inputs	3	
	Logic outputs	-	
	Analog outputs	-	
	Relay outputs	2	
Dialogue		Integrated display terminal, SoMove setup software	
Communication	Integrated	Modbus	
Standards and certifications		IEC/EN 60947-4-2, class A EMC, CE, UL, CSA, C-Tick, GOST, CCC, ABS	

(1) Soft starter sizing according to thermal protection class

Starting current	Protection class		
	Class 10	Class 20	Class 30
< = 3.5 I _n	Nominal*	Nominal +1**	Nominal +2***
max starting time	16s	32s	48s

* nominal size of the soft starter acc. to the nominal motor current (Motor FLA)

** oversize of the soft starter by 1 rating compared to the nominal motor current (Motor FLA)

*** oversize of the soft starter by 2 ratings compared to the nominal motor current (Motor FLA)

Connection in the motor power supply line							Soft start/soft stop unit 230...440 V - 50/60 Hz		
to the motor s inside delta connection									
Power indicated on rating plate									
230 V kW	400 V kW	440 V kW	230 V kW	400 V kW	440 V kW	Nominal current starter (IcL)	Reference	Size	
4	7.5	7.5	5.5	11	15	17	ATS22D17Q	Size A	
7.5	15	15	11	22	22	32	ATS22D32Q	Size A	
11	22	22	18.5	45	45	47	ATS22D47Q	Size A	
15	30	30	22	55	55	62	ATS22D62Q	Size B	
18.5	37	37	30	55	75	75	ATS22D75Q	Size B	
22	45	45	37	75	75	88	ATS22D88Q	Size B	
30	55	55	45	90	90	110	ATS22C11Q	Size C	
37	75	75	55	110	110	140	ATS22C14Q	Size C	
45	90	90	75	132	132	170	ATS22C17Q	Size C	
55	110	110	90	160	160	210	ATS22C21Q	Size D	
75	132	132	110	220	220	250	ATS22C25Q	Size D	
90	160	160	132	250	250	320	ATS22C32Q	Size D	
110	220	220	160	315	355	410	ATS22C41Q	Size D	
132	250	250	220	355	400	480	ATS22C48Q	Size E	
160	315	355	250	400	500	590	ATS22C59Q	Size E	

Connection in the motor power supply line										Soft start/soft stop unit 208...600 V - 50/60 Hz			
Motor										208...600 V		230...600V	
Motor power										Control power supply			
208 V HP	230 V	460 V	575 V	230 V kW	400 V	440 V	500 V	Nominal current (IcL)	110 V Reference	220 V Reference			
3	5	10	15	4	7.5	7.5	9	17 A	ATS22D17S6U Size A	ATS22D17S6 Size A			
7.5	10	20	25	7.5	15	15	18.5	32 A	ATS22D32S6U Size A	ATS22D32S6 Size A			
–	15	30	40	11	22	22	30	47 A	ATS22D47S6U Size A	ATS22D47S6 Size A			
15	20	40	50	15	30	30	37	62 A	ATS22D62S6U Size B	ATS22D62S6 Size B			
20	25	50	60	18.5	37	37	45	75 A	ATS22D75S6U Size B	ATS22D75S6 Size B			
25	30	60	75	22	45	45	55	88 A	ATS22D88S6U Size B	ATS22D88S6 Size B			
30	40	75	100	30	55	55	75	110 A	ATS22C11S6U Size C	ATS22C11S6 Size C			
40	50	100	125	37	75	75	90	140 A	ATS22C14S6U Size C	ATS22C14S6 Size C			
50	60	125	150	45	90	90	110	170 A	ATS22C17S6U Size C	ATS22C17S6 Size C			
60	75	150	200	55	110	110	132	210 A	ATS22C21S6U Size D	ATS22C21S6 Size D			
75	100	200	250	75	132	132	160	250 A	ATS22C25S6U Size D	ATS22C25S6 Size D			
100	125	250	300	90	160	160	220	320 A	ATS22C32S6U Size D	ATS22C32S6 Size D			
125	150	300	350	110	220	220	250	410 A	ATS22C41S6U Size D	ATS22C41S6 Size D			
150	–	350	400	132	250	250	315	480 A	ATS22C48S6U Size E	ATS22C48S6 Size E			
–	200	400	500	160	315	355	400	590 A	ATS22C59S6U Size E	ATS22C59S6 Size E			

Dimensions (in mm)	width x height x depth
ATS48 D17Q to D47Q	Size A: 160 x 275 x 190
D62Q to C11Q	Size B: 190 x 290 x 235
C14Q to C17Q	Size C: 200 x 340 x 265
C21Q to C32Q	Size D: 320 x 380 x 265
C41Q to C66Q	Size E: 400 x 670 x 300
C79Q to M12Q	Size F: 770 x 890 x 315



Supply voltage			Three-phase 230...415 V (1)			
Type of application			Standard		Severe (2)	
Starter control supply voltage			220...415 V			
Protection	Degree of protection		IP20: ATS48D17● to ATS48C11● starters IP00: ATS48C14● to ATS48M12● starters			
	Motor thermal protection		Class 10		Class 20 and 30	
EMC	Class A		On all starters			
	Class B		On all starters up to 170 A			
Starting mode			Torque control (patented TCS: Torque Control System)			
I/O	Analog inputs		1 PTC probe			
	Logic inputs		4 logic inputs, 2 of which are configurable			
	Logic outputs		2 configurable logic outputs			
	Analog outputs		1 analog output			
	Relay outputs		3 relay outputs, 2 of which are configurable			
Dialogue			Integrated or remote display terminal (in option), SoMove software workshop			
Communication	Integrated		Modbus			
	With gateway		DeviceNet, Ethernet, Fipio, PROFIBUS DP			
Motor power						
230 V	400 V	Nominal current				
kW	kW	(IcL)				
3	5.5	12 A	–		ATS48D17Q	Size A
4	7.5	17 A	ATS48D17Q	Size A	ATS48D22Q	Size A
5.5	11	22 A	ATS48D22Q	Size A	ATS48D32Q	Size A
7.5	15	32 A	ATS48D32Q	Size A	ATS48D38Q	Size A
9	18.5	38 A	ATS48D38Q	Size A	ATS48D47Q	Size A
11	22	47 A	ATS48D47Q	Size A	ATS48D62Q	Size B
15	30	62 A	ATS48D62Q	Size B	ATS48D75Q	Size B
18.5	37	75 A	ATS48D75Q	Size B	ATS48D88Q	Size B
22	45	88 A	ATS48D88Q	Size B	ATS48C11Q	Size B
30	55	110 A	ATS48C11Q	Size B	ATS48C14Q	Size C
37	75	140 A	ATS48C14Q	Size C	ATS48C17Q	Size C
45	90	170 A	ATS48C17Q	Size C	ATS48C21Q	Size D
55	110	210 A	ATS48C21Q	Size D	ATS48C25Q	Size D
75	132	250 A	ATS48C25Q	Size D	ATS48C32Q	Size D
90	160	320 A	ATS48C32Q	Size D	ATS48C41Q	Size E
110	220	410 A	ATS48C41Q	Size E	ATS48C48Q	Size E
132	250	480 A	ATS48C48Q	Size E	ATS48C59Q	Size E
160	315	590 A	ATS48C59Q	Size E	ATS48C66Q	Size E
–	355	660 A	ATS48C66Q	Size E	ATS48C79Q	Size F
220	400	790 A	ATS48C79Q	Size F	ATS48M10Q	Size F
250	500	1000 A	ATS48M10Q	Size F	ATS48M12Q	Size F
355	630	1200 A	ATS48M12Q	Size F	–	

(1) Possible to connect the starter in the motor delta connection

(2) Starting time greater than 30 seconds (fans, high inertia machines and compressors)

Soft start/soft stop units

Dimensions (in mm)		width x height x depth	
ATS48	D17Y to D47Y	Size A:	160 x 275 x 190
	D62Y to C11Y	Size B:	190 x 290 x 235
	C14Y to C17Y	Size C:	200 x 340 x 265
	C21Y to C32Y	Size D:	320 x 380 x 265
	C41Y to C66Y	Size E:	400 x 670 x 300
	C79Y to M12Y	Size F:	770 x 890 x 315



Supply voltage												Three-phase 208...690 V (1)						
Type of application												Standard		Severe (2)				
Starter control supply voltage												110...230 V						
Characteristics												Identical to 230...415 V starters						
Motor power												Nominal current (IcL)						
208 V	230 V	460 V	575 V	230 V	400 V	440 V	500 V	525 V	660 V	690 V								
											kW		HP					
2	3	7.5	10	3	5.5	5.5	7.5	7.5	9	11	12 A	–		ATS48D17Y	Size A			
3	5	10	15	4	7.5	7.5	9	9	11	15	17 A	–		ATS48D22Y	Size A	ATS48D22Y	Size A	
5	7.5	15	20	5.5	11	11	11	11	15	18.5	22 A	–		ATS48D22Y	Size A	ATS48D32Y	Size A	
7.5	10	20	25	7.5	15	15	18.5	18.5	22	22	32 A	–		ATS48D32Y	Size A	ATS48D38Y	Size A	
10	–	25	30	9	18.5	18.5	22	22	30	30	38 A	–		ATS48D38Y	Size A	ATS48D47Y	Size A	
–	15	30	40	11	22	22	30	30	37	37	47 A	–		ATS48D47Y	Size A	ATS48D62Y	Size B	
15	20	40	50	15	30	30	37	37	45	45	62 A	–		ATS48D62Y	Size B	ATS48D75Y	Size B	
20	25	50	60	18.5	37	37	45	45	55	55	75 A	–		ATS48D75Y	Size B	ATS48D88Y	Size B	
25	30	60	75	22	45	45	55	55	75	75	88 A	–		ATS48D88Y	Size B	ATS48C11Y	Size B	
30	40	75	100	30	55	55	75	75	90	90	110 A	–		ATS48C11Y	Size B	ATS48C14Y	Size C	
40	50	100	125	37	75	75	90	90	110	110	140 A	–		ATS48C14Y	Size C	ATS48C17Y	Size C	
50	60	125	150	45	90	90	110	110	132	160	170 A	–		ATS48C17Y	Size C	ATS48C21Y	Size D	
60	75	150	200	55	110	110	132	132	160	200	210 A	–		ATS48C21Y	Size D	ATS48C25Y	Size D	
75	100	200	250	75	132	132	160	160	220	250	250 A	–		ATS48C25Y	Size D	ATS48C32Y	Size D	
100	125	250	300	90	160	160	220	220	250	315	320 A	–		ATS48C32Y	Size D	ATS48C41Y	Size E	
125	150	300	350	110	220	220	250	250	355	400	410 A	–		ATS48C41Y	Size E	ATS48C48Y	Size E	
150	–	350	400	132	250	250	315	315	400	500	480 A	–		ATS48C48Y	Size E	ATS48C59Y	Size E	
–	200	400	500	160	315	355	400	400	560	560	590 A	–		ATS48C59Y	Size E	ATS48C66Y	Size E	
200	250	500	600	–	355	400	–	–	630	630	660 A	–		ATS48C66Y	Size E	ATS48C79Y	Size F	
250	300	600	800	220	400	500	500	500	710	710	790 A	–		ATS48C79Y	Size F	ATS48M10Y	Size F	
350	350	800	1000	250	500	630	630	630	900	900	1000 A	–		ATS48M10Y	Size F	ATS48M12Y	Size F	
400	450	1000	1200	355	630	710	800	800	–	–	1200 A	–		ATS48M12Y	Size F	–		

(1) Starter connection in the motor delta connection: up to 500 V only, add "S316" at the end of the reference

(2) Starting time greater than 30 seconds (fans, high inertia machines and compressors)

Altivar 12

0.18...4 kW

Simple machines Ultra-compact drives



Dimensions (in mm)		width x height x depth
1C1:	72 x 143 x 102.2	2F3: 105 x 143 x 131.2
1C2:	72 x 143 x 102.2	3F3: 140 x 184 x 141.2
1C3:	72 x 143 x 121.2	
2C1:	105 x 142 x 156.2	
2C2:	105 x 142 x 156.2	

Type of drive		Single-phase 120 V	Single-phase 240 V	Three-phase 240 V				
Supply voltage								
Degree of protection		IP20						
Drive	Output frequency	0.5... 400 Hz						
	Type of control	Asynchronous motor						
	Transient overtorque	U/F, sensorless flux vector control, quadratic Kn ²						
Speed range		150...170 of the nominal torque						
Functions		1 to 20						
Number of I/O	Number of functions	40						
	Number of preset speeds	8						
	Analog inputs	1 configurable analog input						
	Logic inputs	4 assignable logic inputs						
	Analog outputs	1 configurable analog output						
Relay outputs		1 protected relay logic output						
Dialogue		Integrated or remote display terminal, SoMove software workshop, or mobile phone via Bluetooth®						
Communication		Integrated Modbus						
Cards (available as an option)								
Reduction of current harmonics								
EMC filter	Integrated		C1 EMC					
	As an option							
Motor power	kW/HP	0.18/0.25	ATV12H018F1 (1)	1C1	ATV12H018M2 (1) (2)	1C2	ATV12H018M3 (1)	1C3
		0.37/0.5	ATV12H037F1	1C1	ATV12H037M2 (2)	1C1	ATV12H037M3	1C3
		0.55/0.75	–		ATV12H055M2 (2)	1C2	–	
		0.75/1	ATV12H075F1	2C1	ATV12H075M2 (2)	1C2	ATV12H075M3	1C3
		1.5/2	–		ATV12HU15M2 (2)	2C2	ATV12H015M3	2F3
		2.2/3	–		ATV12HU22M2 (2)	2C2	ATV12H022M3	2F3
		3/3	–		–		ATV12H030M3	3F3
		4/5	–		–		ATV12H040M3	3F3

(1) Because of the low heat dissipation, the ATV12H018.. is only supplied on a base plate

(2) Also exists as a multipack

Dimensions (in mm)		width x height x depth	
IP21		IP55	
T1A: 107 x 143 x 150	T1: 215 x 297 x 192		
T2A: 142 x 184 x 150	T2: 230 x 340 x 208		
T3A: 180 x 232 x 170	T3: 290 x 560 x 315		
T4A: 245 x 329.5 x 190	T4: 310 x 665 x 315		
T5A: 240 x 420 x 214	T5: 284 x 720 x 315		
T6A: 320 x 630 x 290	T5: 284 x 880 x 343		
T7A: 240 x 550 x 266	T5: 362 x 1000 x 364		
T8A: 320 x 630 x 290			



Type of drive		IP21		IP55		
Supply voltage		200...240 V		380...480 V		
Degree of protection		IP21 and IP41 on the upper part		IP55 drive available in two manufacturing variants, ATV212W...N4 C1 EMC or ATV212W...N4C C2 EMC		
Output frequency		0.5...200 Hz				
Type of control		Kn ² quadratic ratio, sensorless flux vector control, voltage/frequency ratio (2 points), energy saving ratio				
Speed range		1 to 10				
I/O	Analog inputs	1 switch-configurable current or voltage analog input and 1 voltage analog input, configurable as a PTC probe input				
	Logic inputs	3 programmable logic inputs				
	Analog outputs	1 switch-configurable current or voltage analog output				
	Relay outputs	2 relay logic outputs				
Dialogue		Integrated display terminal with local controls (1) or remote display terminal or PC software (3)				
Communication	Integrated	Modbus, APOGEE FLN P1, Metasys N2, BACnet				
	As an option	LonWorks				
EMC filter	Integrated	–	C2 EMC	C2 EMC	C1 EMC	
	Available as an option	C2 EMC	C1 EMC	–	–	
Motor power	kW/HP	0.75/1	ATV212H075M3X T1A	ATV212H075N4 T1A	ATV212W075N4 T1	ATV212W075N4C T1
		1.5/2	ATV212HU15M3X T1A	ATV212HU15N4 T1A	ATV212WU15N4 T1	ATV212WU15N4C T1
		2.2/3	ATV212HU22M3X T1A	ATV212HU22N4 T1A	ATV212WU22N4 T1	ATV212WU22N4C T1
		3/–	ATV212HU30M3X T2A	ATV212HU30N4 T2A	ATV212WU30N4 T2	ATV212WU30N4C T2
		4/5	ATV212HU40M3X T2A	ATV212HU40N4 T2A	ATV212WU40N4 T2	ATV212WU40N4C T2
		5.5/7.5	ATV212HU55M3X T3A	ATV212HU55N4 T2A	ATV212WU55N4 T2	ATV212WU55N4C T2
		7.5/10	ATV212HU75M3X T3A	ATV212HU75N4 T3A	ATV212WU75N4 T2	ATV212WU75N4C T2
		11/15	ATV212HD11M3X T4A	ATV212HD11N4 T3A	ATV212WD11N4 T3	ATV212WD11N4C T3
		15/20	ATV212HD15M3X T4A	ATV212HD15N4 T4A	ATV212WD15N4 T3	ATV212WD15N4C T3
		18.5/25	ATV212HD18M3X T4A	ATV212HD18N4 T4A	ATV212WD18N4 T4	ATV212WD18N4C T4
		22/30 (4)	–	ATV212HD22N4S T4A	–	–
		22/30	ATV212HD22M3X T5A	ATV212HD22N4(2) T5A	ATV212WD22N4 T5	ATV212WD22N4C T5
		30/40	ATV212HD30M3X T6A	ATV212HD30N4(2) T5A	ATV212WD30N4 T5	ATV212WD30N4C T5
		37/50	–	ATV212HD37N4 T7A	ATV212WD37N4 T6	ATV212WD37N4C T6
		45/60	–	ATV212HD45N4 T7A	ATV212WD45N4 T6	ATV212WD45N4C T6
		55/75	–	ATV212HD55N4 T8A	ATV212WD55N4 T7	ATV212WD55N4C T7
75/100	–	ATV212HD75N4 T8A	ATV212WD75N4 T7	ATV212WD75N4C T7		

(1) Drive with local controls, Run/Stop, Loc/Rem. keys
 (2) For references ATV212HD22N4 and ATV212HD30N4, please see: www.schneider-electric.com
 (3) PC Software is available as a free download from www.schneider-electric.com
 (4) Optimized size and weight



Dimensions (in mm)		width x height x depth	
T 1:	72 x 145 x 122	T 6:	107 x 143 x 152
T 2:	72 x 145 x 132	T 7:	142 x 184 x 152
T 3:	72 x 145 x 132	T 8:	180 x 232 x 172
T 4:	72 x 145 x 142	T 9:	245 x 330 x 192
T 5:	105 x 143 x 132		

Type of drive		Single-phase 240 V	Three-phase 240 V	Three-phase 500V	Three-phase 600V	
Supply voltage		with integrated EMC filters	without EMC filter	with integrated EMC filters	without EMC filter	
Degree of protection		IP31 & IP41 on upper part and IP21 on terminals				
Drive	Output frequency	0.5...500 Hz				
	Type of control	Asynchronous motor				
	Transient overtorque	Standard (voltage / frequency) - Performance (sensorless flux vector control) Energy saving ratio, pump & Fan ratio (Kn ² quadratic ratio) 170 ... 200% of the nominal motor torque				
Speed range		1 to 50				
Functions	Number of functions	50				
	Number of preset speeds	16				
	Number of I/O	Analog inputs	3			
		Logic inputs	6			
		Analog outputs	1			
		Logic outputs	-			
Relay outputs	2					
Dialogue		Integrated 4-digit display, remote terminals (IP54 or IP65), Altivar 61/71 remote graphic display terminal				
Communication	Integrated	Modbus and CANopen				
	As an option	CANopen Daisy chain, Modbus TCP, DeviceNet, PROFIBUS DP, Fipio				
Reduction of current harmonics						
EMC filter	Integrated	C2 EMC		Integrated C2(1) or C3 EMC		
	As an option	C1 EMC		-		
Motor power	kW/HP	0.18/0.25	ATV312H018M2 T3	ATV312H018M3 T1	-	-
		0.37/0.5	ATV312H037M2 T3	ATV312H037M3 T1	ATV312H037N4 T5	-
		0.55/0.75	ATV312H055M2 T4	ATV312H055M3 T2	ATV312H055N4 T5	-
		0.75/1	ATV312H075M2 T4	ATV312H075M3 T2	ATV312H075N4 T6	ATV312H075S6 T6
		1.1/1.5	ATV312HU11M2 T6	ATV312HU11M3 T5	ATV312HU11N4 T6	-
		1.5/2	ATV312HU15M2 T6	ATV312HU15M3 T5	ATV312HU15N4 T6	ATV312HU15S6 T6
		2.2/3	ATV312HU22M2 (2) T7	ATV312HU22M3 T6	ATV312HU22N4 T7	ATV312HU22S6 T7
		3/-	-	ATV312HU30M3 T7	ATV312HU30N4 T7	-
		4/5	-	ATV312HU40M3 T7	ATV312HU40N4 T7	ATV312HU40S6 T7
		5.5/7.5	-	ATV312HU55M3 T8	ATV312HU55N4 T8	ATV312HU55S6 T8
		7.5/10	-	ATV312HU75M3 T8	ATV312HU75N4 T8	ATV312HU75S6 T8
		11/15	-	ATV312HD11M3 T9	ATV312HD11N4 T9	ATV312HD11S6 T9
		15/20	-	ATV312HD15M3 T9	ATV312HD15N4 T9	ATV312HD15S6 T9

(1) C2 up to 4 kW

(2) Supplied with integrated C3 EMC filter

Altivar 31C

0.18...15 kW

Simple machines Enclosed IP55 drives



Dimensions (in mm)	width x height x depth
Size 1: 210 x 240 x 163 / Size 2: 215 x 297 x 192	
Size 3: 230 x 340 x 208 / Size 4: 320 x 512 x 282	
Size 5: 440 x 625 x 282	

Supply voltage			Single-phase 200...240 V		Three-phase 380...500 V	
Degree of protection			IP55			
Description			Enclosure equipped with an Altivar 31 drive with external heatsink. Removable covers for adding 1 switch-disconnector or 1 circuit-breaker, 3 buttons and/or LEDs, 1 potentiometer			
Motor power	kW/HP	0.18/0.25	ATV31C018M2	Size 1	-	
		0.37/0.5	ATV31C037M2	Size 1	ATV31C037N4	Size 2
		0.55/0.75	ATV31C055M2	Size 1	ATV31C055N4	Size 2
		0.75/1	ATV31C075M2	Size 1	ATV31C075N4	Size 2
		1.1/1.5	ATV31CU11M2	Size 2	ATV31CU11N4	Size 2
		1.5/2	ATV31CU15M2	Size 2	ATV31CU15N4	Size 2
		2.2/3	ATV31CU22M2	Size 3	ATV31CU22N4	Size 3
		3/-	-		ATV31CU30N4	Size 3
		4/5	-		ATV31CU40N4	Size 3
		5.5/7.5	-		ATV31CU55N4 (1)	Size 4
		7.5/10	-		ATV31CU75N4 (1)	Size 4
		11/15	-		ATV31CD11N4 (1)	Size 5
		15/20	-		ATV31CD15N4 (1)	Size 5

(1) Standard enclosed drive



Dimensions (in mm)	width x height x depth
T1:	45 x 317 x 245
T2:	60 x 317 x 245
T4:	150 x 308 x 232 (EMC plate installed)
T4:	150 x 232 x 232 (EMC plate not installed)
T5:	180 x 404 x 232 (EMC plate installed)
T5:	180 x 330 x 232 (EMC plate not installed)

Type of drive		Single-phase 240 V with integrated EMC filter	Three-phase 500 V with integrated EMC filter	
Degree of protection		IP20		
Drive	Output frequency	0.1...599 Hz		
	Type of control	Asynchronous motor		
		Synchronous motor		
	Transient overtorque	170...200% of the nominal motor torque		
Speed range		1 to 50		
Functions	Number of functions		150	
	Number of I/O	Analog inputs	3 - Response time : 3ms, resolution 10 bits	
		Logic inputs	6 - Response time : 8 ms, configurable in PTC and IN pwm	
		Analog outputs	1 - Updating time : 2 ms	
		Logic outputs	1 - Sampling time : 2 ms, configurable as voltage (0-10 V) or current (0-20 mA)	
		Relay outputs	2	
Dialogue		4-digit display, remote display terminal (IP54 or IP55), remote graphic display terminal, SoMove setup software and SoMove Mobile application for mobile phone.		
Communication	Integrated	Modbus and CANopen - Bluetooth® link		
	As an option	DeviceNet, PROFIBUS DP V1, EtherNet/IP, Modbus TCP, EtherCat		
Reduction of current harmonics				
EMC filter	Integrated	C2 EMC		
	As an option	C1 EMC		
Motor power	kW	HP		
	0.18	1/4	ATV32H018M2 T1	–
	0.37	1/2	ATV32H037M2 T1	ATV32H037N4 T1
	0.55	3/4	ATV32H055M2 T1	ATV32H055N4 T1
	0.75	1	ATV32H075M2 T1	ATV32H075N4 T1
	1.1	1 1/2	ATV32HU11M2 T2	ATV32HU11N4 T1
	1.5	2	ATV32HU15M2 T2	ATV32HU15N4 T1
	2.2	3	ATV32HU22M2 T2	ATV32HU22N4 T2
	3	–	–	ATV32HU30N4 T2
	4	5	–	ATV32HU40N4 T2
	5.5	7 1/2	–	ATV32HU55N4 T4
	7.5	10	–	ATV32HU75N4 T4
	11	15	–	ATV32HD11N4 T5
	15	20	–	ATV32HD15N4 T5



BMP motors + Altivar 32 variable speed drives associations

Single-phase supply voltage: 200...380 V 50/60 Hz

Power indicated on rating plate kW	BMP motor + drive combination			Associated drive	Motor reference
	Nominal speed rpm	Nominal torque Nm	Peak torque Nm		
0.37	3000	1.18	3.70	ATV32H037M2	BMP0701R3NA2A
0.55	3000	1.75	4.54	ATV32H055M2	BMP0702R3NA2A
0.75	3000	2.39	5.99	ATV32H075M2	BMP1001R3NA2A
1.1	3000	3.5	8.43	ATV32HU11M2	BMP1002R3NA2A
1.1	1500	7	15.95	ATV32HU11M2	BMP1401F3NA2A
1.1	1500	7	18.15	ATV32HU15M2	BMP1401F3NA2A
1.5	3000	4.77	9.60	ATV32HU15M2	BMP1002R3NA2A
2	3000	6.37	13.28	ATV32HU22M2	BMP1401R3NA2A
2.2	1500	14.01	24.34	ATV32HU22M2	BMP1402F3NA2A

Three-phase supply voltage: 400...500 V 50/60 Hz

0.37	3000	1.18	3.16	ATV32H037N4	BMP0701F3NA2A
0.55	3000	1.75	4.24	ATV32H055N4	BMP0702F3NA2A
0.75	3000	2.39	5.68	ATV32H075N4	BMP1001F3NA2A
0.75	3000	2.39	7.06	ATV32HU11N4	BMP1001F3NA2A
1.1	1500	7	13.49	ATV32HU11N4	BMP1401C3NA2A
1.1	1500	7	18.05	ATV32HU15N4	BMP1401C3NA2A
1.5	3000	4.77	9.33	ATV32HU15N4	BMP1002F3NA2A
2	3000	6.37	12.65	ATV32HU22N4	BMP1401F3NA2A
2.2	1500	14.01	23.51	ATV32HU22N4	BMP1402C3NA2A
3	3000	9.55	15.84	ATV32HU30N4	BMP1402F3NA2A
3	3000	9.55	20.83	ATV32HU40N4	BMP1402F3NA2A

Dimensions (in mm)		width x height x depth	
T2	: 130 x 230 x 175	T3	: 155 x 260 x 187
T4	: 175 x 295 x 187	T5A	: 210 x 295 x 213
T5B	: 230 x 400 x 213	T6	: 240 x 420 x 236
T7A	: 240 x 550 x 266	T7B	: 320 x 550 x 266
T8	: 320 x 630 x 290	T9	: 320 x 920 x 377
T10	: 360 x 1022 x 377	T11	: 340 x 1190 x 377
T12	: 440 x 1190 x 377	T13	: 595 x 1190 x 377
T14	: 890 x 1390 x 377	T15	: 1120 x 1390 x 377



Type of drive			Single-phase	Three-phase	Three-phase			
Supply voltage			200...240 V	200...240 V	380...480 V			
Degree of protection			IP20 for unprotected drives and IP41 on the upper part					
Drive	Output frequency		0.1...599 Hz up to 37 kW; 0.1...500 Hz from 45 to 800 kW					
	Type of control	Asynchronous motor	Kn ² quadratic ratio, flux vector control with or without sensor, voltage/frequency ratio (2 or 5 points), energy saving ratio					
		Synchronous motor	Vector control without speed feedback					
	Transient overtorque		120...130% of the nominal drive current for 60 seconds					
Speed range			1...100 in open loop mode					
Functions	Number of functions		> 150					
	Number of preset speeds		16					
	Number of I/O		Analog inputs 2...4/Logic inputs 6...20					
			Analog outputs 1...3/Logic outputs 0...8					
			Relay outputs 2...4					
			Safety input 1					
Dialogue			Remote graphic display terminal, SoMove setup software					
Communication	Integrated		Modbus and CANopen					
	As an option		HVAC protocols: LonWorks, BACnet, METASYS N2, APOGEE FLN P1 Industrial protocols: Modbus TCP Daisy Chain, Modbus/Uni-Telway, EtherNet/IP, EtherCAT, DeviceNet, PROFIBUS DP V0 and V1, INTERBUS, CC-Link					
Cards (available as an option)			Multi-pump cards, I/O extension cards, "Controller Inside" programmable card					
Reduction of current harmonics			DC choke integrated or supplied with the drive or AFE Altivar (Active Front End)					
EMC filter	Integrated		C2 EMC	C2 EMC up to 7.5 kW	C2 EMC up to 4 kW			
	As an option		C1 EMC	C1 EMC	C3 EMC from 5.5 to 630 kW C1 EMC from 0.75 to 630 kW			
Motor power	kW/HP	0.37/0.5	ATV61H075M3	T2	–	–		
		0.75/1	ATV61HU15M3	T2	ATV61H075M3	T2	ATV61H075N4	T2
		1.5/2	ATV61HU22M3	T3	ATV61HU15M3	T2	ATV61HU15N4	T2
		2.2/3	ATV61HU30M3	T3	ATV61HU22M3	T3	ATV61HU22N4	T2
		3/–	ATV61HU40M3 (1)	T3	ATV61HU30M3	T3	ATV61HU30N4	T3
		4/5	ATV61HU55M3 (1)	T4	ATV61HU40M3	T3	ATV61HU40N4	T3
		5.5/7.5	ATV61HU75M3 (1)	T5A	ATV61HU55M3	T4	ATV61HU55N4	T4
		7.5/10	–	–	ATV61HU75M3	T5A	ATV61HU75N4	T4
		11/15	–	–	ATV61HD11M3X(2)	T5B	ATV61HD11N4	T5A
		15/20	–	–	ATV61HD15M3X(2)	T5B	ATV61HD15N4	T5B
		18.5/25	–	–	ATV61HD18M3X(2)	T6	ATV61HD18N4	T5A
		22/30	–	–	ATV61HD22M3X(2)	T6	ATV61HD22N4	T6
		30/40	–	–	ATV61HD30M3X(2)	T7B	ATV61HD30N4	T7A
		37/50	–	–	ATV61HD37M3X(2)	T7B	ATV61HD37N4	T7A
		45/60	–	–	ATV61HD45M3X(2)	T7B	ATV61HD45N4	T8
		55/75	–	–	ATV61HD55M3X(2)	T9	ATV61HD55N4	T8
		75/100	–	–	ATV61HD75M3X(2)	T9	ATV61HD75N4	T8
		90/125	–	–	ATV61HD90M3X(2)	T10	ATV61HD90N4	T9
		110/150	–	–	–	–	ATV61HC11N4	T9
		132/200	–	–	–	–	ATV61HC13N4	T10
		160/250	–	–	–	–	ATV61HC16N4	T11
220/350	–	–	–	–	ATV61HC22N4	T12		
250/400	–	–	–	–	ATV61HC25N4	T13		
315/500	–	–	–	–	ATV61HC31N4	T13		
400/600	–	–	–	–	ATV61HC40N4	T14		
500/700	–	–	–	–	ATV61HC50N4	T14		
630/900	–	–	–	–	ATV61HC63N4	T15		

(1) Must be used with a line choke, refer to the Schneider Electric catalogue.

(2) Drive supplied without EMC filter



Dimensions (in mm)	width x height x depth
T6	: 240 x 420 x 236
T8	: 320 x 630 x 290
T11	: 340 x 1190 x 377
T13	: 595 x 1190 x 377
T15	: 1120 x 1390 x 377

Type of drive		Three-phase				
Supply voltage		500...690 V				
Degree of protection		IP20 and IP41 on the upper part				
Drive	Output frequency	0.1...599 Hz up to 37 kW; 0.1...500 Hz from 45 to 800 kW				
	Type of control	Asynchronous motor	Kn ² quadratic ratio, flux vector control with or without sensor, voltage/frequency ratio (2 or 5 points), energy saving ratio			
		Synchronous motor	Vector control without speed feedback			
	Transient overtorque	120...130% of the nominal drive current for 60 seconds				
Speed range		1...100 in open loop mode				
Functions	Number of functions	> 150				
	Number of preset speeds	16				
	Number of I/O	Analog inputs 2...4/Logic inputs 6...20 Analog outputs 1...3/Logic outputs 0...8 Relay outputs 2...4 Safety input 1				
Dialogue		Remote graphic display terminal, SoMove setup software				
Communication	Integrated	Modbus and CANopen				
	As an option	HVAC protocols: LonWorks, BACnet, METASYS N2, APOGEE FLN P1 Industrial protocols: Modbus TCP Daisy Chain, Modbus/Uni-Telway, EtherNet/IP, EtherCAT, DeviceNet, PROFIBUS DP V0 et V1, INTERBUS, CC-Link				
Cards (available as an option)		Multi-pump cards, I/O extension cards, "Controller Inside" programmable card				
Reduction of current harmonics		DC choke integrated or supplied with the product or AFE Altivar (Active Front End)				
EMC filter		Integrated				
Motor power	kW/HP	500 V	575 V	690 V		
		kW	HP	kW		
		2.2	3	3	ATV61HU30Y	T6
		3	—	4	ATV61HU40Y	T6
		4	5	5.5	ATV61HU55Y	T6
		5.5	7.5	7.5	ATV61HU75Y	T6
		7.5	10	11	ATV61HD11Y	T6
		11	15	15	ATV61HD15Y	T6
		15	20	18.5	ATV61HD18Y	T6
		18.5	25	22	ATV61HD22Y	T6
		22	30	30	ATV61HD30Y	T6
		30	40	37	ATV61HD37Y	T8
		37	50	45	ATV61HD45Y	T8
		45	60	55	ATV61HD55Y	T8
		55	75	75	ATV61HD75Y	T8
		75	100	90	ATV61HD90Y	T8
		90	125	110	ATV61HC11Y	T11
		110	150	132	ATV61HC13Y	T11
		132	—	160	ATV61HC16Y	T11
		160	200	200	ATV61HC20Y	T11
		200	250	250	ATV61HC25Y	T13
		250	350	315	ATV61HC31Y	T13
		315	450	400	ATV61HC40Y	T13
		400	550	500	ATV61HC50Y	T15
		500	700	630	ATV61HC63Y	T15
		630	800	800	ATV61HC80Y	T15



Dimensions (in mm)		width x height x depth	
ATV61W...			
TA2 : 235 x 490 x 272	TD : 310 x 665 x 315		
TA3 : 235 x 490 x 286	TE : 284 x 720 x 315		
TB : 255 x 525 x 286	TF : 284 x 880 x 343		
TC : 290 x 560 x 315	TG : 362 x 1000 x 364		

Type of drive		Three-phase 380...480 V				
Degree of protection		Type 12 (1) / IP54				
Drive	Output frequency	0.1...599 Hz up to 37 kW; 0.1...500 Hz from 45 to 800 kW				
	Type of control	Asynchronous motor	Kn ² quadratic ratio, flux vector control with or without sensor, voltage/frequency ratio (2 or 5 points), energy saving ratio			
		Synchronous motor	Vector control without speed feedback			
	Transient overtorque	120...130% of the nominal drive current for 60 seconds				
Speed range		1...100 in open loop mode				
Functions	Number of functions	> 150				
	Number of preset speeds	16				
	Number of I/O	Analog inputs 2...4/Logic inputs 6...20				
		Analog outputs 1...3/Logic outputs 0...8				
		Relay outputs 2...4				
		Safety input 1				
Dialogue		Remote graphic display terminal, SoMove setup software				
Communication	Integrated	Modbus and CANopen				
	As an option	HVAC protocols: LonWorks, BACnet, METASYS N2, APOGEE FLN P1 Industrial protocols: Modbus TCP Daisy Chain, Modbus/Uni-Telway, EtherNet/IP, EtherCAT, DeviceNet, PROFIBUS DP V0 and V1, INTERBUS, CC-Link				
Cards (available as an option)		Multi-pump cards, I/O extension cards, "Controller Inside" programmable card				
Reduction of current harmonics		Integrated DC choke				
EMC filter	Integrated	C2 EMC				
	As an option	-				
Motor power	kW/HP	0.75/1	ATV61W075N4	TA2	ATV61E5075N4	TA2
		1.5/2	ATV61WU15N4	TA2	ATV61E5U15N4	TA2
		2.2/3	ATV61WU22N4	TA2	ATV61E5U22N4	TA2
		3/-	ATV61WU30N4	TA3	ATV61E5U30N4	TA3
		4/5	ATV61WU40N4	TA3	ATV61E5U40N4	TA3
		5.5/7.5	ATV61WU55N4	TB	ATV61E5U55N4	TB
		7.5/10	ATV61WU75N4	TB	ATV61E5U75N4	TB
		11/15	ATV61WD11N4	TC	ATV61E5D11N4	TC
		15/20	ATV61WD15N4	TD	ATV61E5D15N4	TD
		18.5/25	ATV61WD18N4	TD	ATV61E5D18N4	TD
		22/30	ATV61WD22N4	TE	ATV61E5D22N4	TE
		30/40	ATV61WD30N4	TF	ATV61E5D30N4	TF
		37/50	ATV61WD37N4	TF	ATV61E5D37N4	TF
		45/60	ATV61WD45N4	TG	ATV61E5D45N4	TG
		55/75	ATV61WD55N4	TG	ATV61E5D55N4	TG
		75/100	ATV61WD75N4	TG	ATV61E5D75N4	TG
90/125	ATV61WD90N4	TG	ATV61E5D90N4	TG		

Drive with integrated C1 filter: add the letter **C** at the end of the reference For example, ATV61W075N4 becomes ATV61W075N4C

(1) For ATV61W... range only.

Altivar 61

0.37...800 kW

Pumping and ventilation machines

IP54 Altivar 61 kit with preassembled enclosure



Drive	Kit
ATV61HC11N4	VW3A9541
ATV61HC13N4	VW3A9542
ATV61HC16N4	VW3A9543
ATV61HC22N4	VW3A9544
ATV61HC25N4	VW3A9545
ATV61HC31N4	
ATV61HC25N4	VW3A9546
ATV61HC31N4	
ATV61HC40N4	VW3A9547
ATV61HC50N4	
ATV61HC63N4	VW3A9548
	VW3A7102 braking unit
	VW3A9549
	Additional empty enclosure (600 mm)
	VW3A9550
	Additional empty enclosure (800 mm)
	VW3A9551

3



Dimensions (in mm)	width x height x depth
T11	: 330 x 950 x 377
T13	: 585 x 950 x 377
T15	: 1110 x 1150 x 377

Type of drive		Three-phase	Three-phase		
Supply voltage		380...480 V	500...690 V		
Degree of protection		Sideways and front IP31 - Top IP20 - Bottom IP00			
Drive	Output frequency	0.1...500Hz			
	Type of control	Asynchronous motor	Kn ² quadratic ratio, flux vector control with or without sensor, voltage/frequency ratio (2 or 5 points), energy saving ratio		
		Synchronous motor	Vector control without speed feedback		
	Transient overtorque	120...130% of the nominal drive current for 60 seconds			
Speed range		1...100 in open loop mode			
Functions	Number of functions	> 150			
	Number of preset speeds	16			
	Number of I/O	Analog inputs 2...4/Logic inputs 6...20 Analog outputs 1...3/Logic outputs 0...8 Relay outputs 2...4 Safety input 1			
Dialogue		Remote graphic display terminal, SoMove setup software			
Communication	Integrated	Modbus and CANopen			
	As an option	HVAC protocols: LonWorks, BACnet, METASYS N2, APOGEE FLN P1 Industrial protocols: Modbus TCP, Modbus/Uni-Telway, Fipio, Modbus Plus, Profbus DP, Profbus DP V1, DeviceNet, EthernetIP, CC-Link, INTERBUS			
Cards (available as an option)		Multi-pump cards, I/O extension cards, "Controller Inside" programmable card			
Reduction of current harmonics		Optional AC choke, Altivar AFE (Active Front End)			
EMC filter	Integrated	C3 EMC			
	As an option	C1 EMC			
Motor power	kW/HP	110/150	ATV61QC11N4	T11	–
		132/200	ATV61QC13N4	T11	–
		160/250	ATV61QC16N4	T11	–
		200/300	ATV61QC20N4	T13	–
		250/400	ATV61QC25N4	T13	–
		315/500	ATV61QC31N4	T13	–
		400/600	ATV61QC40N4	T15	–
		500/700	ATV61QC50N4	T15	–
630/900	ATV61QC63N4	T15	–		

500 V	575 V	690 V		
kW	HP	kW		
110	150	132	–	ATV61QC13Y T11
132	–	160	–	ATV61QC16Y T11
160	200	200	–	ATV61QC20Y T11
200	250	250	–	ATV61QC25Y T13
250	350	315	–	ATV61QC31Y T13
315	450	400	–	ATV61QC40Y T13
400	550	500	–	ATV61QC50Y T15
500	700	630	–	ATV61QC63Y T15
630	800	800	–	ATV61QC80Y T15



Dimensions (in mm)	width x height x depth
ATV61EXC2C...	
E1	: 600 x 2162 x 642
E2	: 800 x 2162 x 642
E3	: 1000 x 2162 x 642
E4	: 1200 x 2162 x 642

Enclosure types		Three-phase 380...480 V - 500 V - 690 V (1)
Degree of protection		IP23, IP54
Drive	Output frequency	0.1...599 Hz up to 37 kW; 0.1...500 Hz from 45...2400 kW
	Type of control	Asynchronous motor Synchronous motor
	Transient overtorque	120...130% of the nominal drive current for 60 seconds
	Speed range	1...100 in open loop mode
Functions	Number of functions	> 150
	Number of preset speeds	16
	Number of I/O	Analog inputs 2...4/Logic inputs 6...20
		Analog outputs 1...3/Logic outputs 0...8
		Relay outputs 2...4
Dialogue		Safety input 1 Remote graphic display terminal, SoMove setup software
Communication	Integrated	Modbus and CANopen
	As an option	HVAC protocols: LonWorks, BACnet, METASYS N2, APOGEE FLN P1 Industrial protocols: Modbus TCP, Modbus/Uni-Telway, EtherNet/IP, EtherCAT, DeviceNet, PROFIBUS DP V0 and V1, INTERBUS, CC-Link.
Cards (available as an option)		Multi-pump cards, I/O extension cards, "Controller Inside" programmable card
Reduction of current harmonics		DC choke or Integrated AC choke, variant 12 pulse, AFE Altivar (Active Front End)
EMC filter	Integrated	C3 EMC
Equipment		A wide range of options listed in the catalogue provides add-ons for the standard offer as required. As well as the options listed in the catalogue, it is possible to customise the equipment. Just contact our teams of experts directly. - Water cooling solution - Integration of specific options



IP23	Three-phase 380...415 V			Three-phase 500 V			Three-phase 690 V		
	kW/HP	Dimensions		kW	Dimensions		kW	Dimensions	
	90/125	ATV61EXC2D90N4	E1	90	ATV61 EXC2D90N	E1	-		
	110/150	ATV61EXC2C11N4	E1	110	ATV61 EXC2C11N	E1	110	ATV61 EXC2C11Y	E1
	132/200	ATV61EXC2C13N4	E1	132	ATV61 EXC2C13N	E1	132	ATV61 EXC2C13Y	E1
	160/250	ATV61EXC2C16N4	E1	160	ATV61 EXC2C16N	E1	160	ATV61 EXC2C16Y	E1
	220/350	ATV61EXC2C22N4	E1	200	ATV61 EXC2C20N	E2	200	ATV61 EXC2C20Y	E1
	250/400	ATV61EXC2C25N4	E2	250	ATV61 EXC2C25N	E2	250	ATV61 EXC2C25Y	E2
	315/500	ATV61EXC2C31N4	E2	315	ATV61 EXC2C31N	E2	315	ATV61 EXC2C31Y	E2
	400/600	ATV61EXC2C40N4	E3	400	ATV61 EXC2C40N	E4	400	ATV61 EXC2C40Y	E2
	500/700	ATV61EXC2C50N4	E3	500	ATV61 EXC2C50N	E4	500	ATV61 EXC2C50Y	E4
	630/900	ATV61EXC2C63N4	E4	630	ATV61 EXC2C63N	E4	630	ATV61 EXC2C63Y	E4
							800	ATV61 EXC2C80Y	E4

(1) The Altivar 61 range in ready-assembled enclosure consists of: an ATV61H... drive, a switch and fast-acting fuses, an IP65 remote mounting kit for graphic display terminal

Dimensions (in mm)		width x height x depth	
ATV61EX...			
E5 : 600 x 2262 x 642	E9 : 600 x 2362 x 642		
E6 : 800 x 2262 x 642	E10 : 800 x 2362 x 642		
E7 : 1000 x 2262 x 642	E11 : 1000 x 2362 x 642		
E8 : 1200 x 2262 x 642	E12 : 1200 x 2362 x 642		
	E13 : 1400 x 2362 x 642		
	E14 : 1600 x 2362 x 642		

IP54	Three-phase 380...415 V				Three-phase 500 V				Three-phase 690 V			
	kW/HP		Dimensions		kW		Dimensions		kW		Dimensions	
Compact floor-standing enclosure												
	90 / 125	ATV61EXC5D90N4	E5	90	ATV61EXC5D90N	E5	90	ATV61EXC5D90N	E5	90	ATV61EXC5D90N	E5
	110/150	ATV61EXC5C11N4	E5	110	ATV61EXC5C11N	E5	110	ATV61EXC5C11N	E5	110	ATV61EXC5C11Y	E5
	132/200	ATV61EXC5C13N4	E5	132	ATV61EXC5C13N	E5	132	ATV61EXC5C13N	E5	132	ATV61EXC5C13Y	E5
	160/250	ATV61EXC5C16N4	E5	160	ATV61EXC5C16N	E5	160	ATV61EXC5C16N	E5	160	ATV61EXC5C16Y	E5
	220/350	ATV61EXC5C22N4	E5	200	ATV61EXC5C20N	E6	200	ATV61EXC5C20N	E6	200	ATV61EXC5C20Y	E5
	250/400	ATV61EXC5C25N4	E6	250	ATV61EXC5C25N	E6	250	ATV61EXC5C25N	E6	250	ATV61EXC5C25Y	E6
	315/500	ATV61EXC5C31N4	E6	315	ATV61EXC5C31N	E6	315	ATV61EXC5C31N	E6	315	ATV61EXC5C31Y	E6
	400/600	ATV61EXC5C40N4	E7	400	ATV61EXC5C40N	E8	400	ATV61EXC5C40N	E8	400	ATV61EXC5C40Y	E6
	500/700	ATV61EXC5C50N4	E7	500	ATV61EXC5C50N	E8	500	ATV61EXC5C50N	E8	500	ATV61EXC5C50Y	E8
	630/900	ATV61EXC5C63N4	E8	630	ATV61EXC5C63N	E8	630	ATV61EXC5C63N	E8	630	ATV61EXC5C63Y	E8
										800	ATV61EXC5C80Y	E8

IP54	Three-phase 380...415 V				Three-phase 500 V				Three-phase 690 V			
	kW/HP		Dimensions		kW		Dimensions		kW		Dimensions	
Separate air flow												
	90 / 125	ATV61EXS5D90N4	E9	90	ATV61EXS5D90N	E11	90	ATV61EXS5D90N	E11	90	ATV61EXS5D90N	E11
	110/150	ATV61EXS5C11N4	E9	110	ATV61EXS5C11N	E11	110	ATV61EXS5C11N	E11	110	ATV61EXS5C11Y	E11
	132/200	ATV61EXS5C13N4	E9	132	ATV61EXS5C13N	E11	132	ATV61EXS5C13N	E11	132	ATV61EXS5C13Y	E11
	160/250	ATV61EXS5C16N4	E9	160	ATV61EXS5C16N	E11	160	ATV61EXS5C16N	E11	160	ATV61EXS5C16Y	E11
	220/350	ATV61EXS5C22N4	E9	200	ATV61EXS5C20N	E12	200	ATV61EXS5C20N	E12	200	ATV61EXS5C20Y	E11
	250/400	ATV61EXS5C25N4	E10	250	ATV61EXS5C25N	E12	250	ATV61EXS5C25N	E12	250	ATV61EXS5C25Y	E12
	315/500	ATV61EXS5C31N4	E10	315	ATV61EXS5C31N	E12	315	ATV61EXS5C31N	E12	315	ATV61EXS5C31Y	E12
	400/600	ATV61EXS5C40N4	E13	400	ATV61EXS5C40N	E14	400	ATV61EXS5C40N	E14	400	ATV61EXS5C40Y	E12
	500/700	ATV61EXS5C50N4	E13	500	ATV61EXS5C50N	E14	500	ATV61EXS5C50N	E14	500	ATV61EXS5C50Y	E14
	630/900	ATV61EXS5C63N4	E14	630	ATV61EXS5C63N	E14	630	ATV61EXS5C63N	E14	630	ATV61EXS5C63Y	E14
										800	ATV61EXS5C80Y	E14

Altivar 61 Plus-LH

55...630 kW

Pumping and ventilation machines

Low harmonic solution in IP23 and IP54 enclosures

Dimensions (in mm)		width x height x depth	
ATV61EX●●●●●N4H			
E1	: 400 x 2157 x 642	E8	: 400 x 2237 x 642
E2	: 600 x 2157 x 642	E9	: 600 x 2237 x 642
E3	: 800 x 2157 x 642	E10	: 800 x 2237 x 642
E4	: 1200 x 2157 x 642	E11	: 1200 x 2237 x 642
E5	: 1600 x 2157 x 642	E12	: 1600 x 2237 x 642
E6	: 2000 x 2157 x 642	E13	: 2000 x 2237 x 642
E7	: 2400 x 2157 x 642	E14	: 2400 x 2237 x 642



Enclosure types			Three-phase 380...480 V (1)			
Degree of protection			IP23, IP54			
Drive	Output frequency		0.1...500 Hz			
	Type of control	Asynchronous motor	Kn ² quadratic ratio, flux vector control with or without sensor, voltage/frequency ratio (2 or 5 points), energy saving ratio			
		Synchronous motor	Vector control without speed feedback			
	Overload		120% for 60 seconds per 10minutes			
Speed range			1...100 in open loop mode			
Functions	Number of functions		> 150			
	Number of preset speeds		16			
	Number of I/O		Analog inputs 2...4/Logic inputs 6...20			
			Analog outputs 1...3/Logic outputs 0...8			
			Relay outputs 2...4			
Dialogue			Safety input 1			
Communication	Integrated		Remote graphic display terminal, SoMove setup software			
	As an option		Modbus and CANopen			
Cards (available as an option)			HVAC protocols: LonWorks, BACnet, METASYS N2, APOGEE FLN P1			
EMC filter			Industrial protocols: Modbus TCP, Modbus/Uni-Telway, EtherNet/IP, EtherCAT, DeviceNet, PROFIBUS DP V0 and V1, INTERBUS, CC-Link.			
Equipment			Multi-pump cards, I/O extension cards, "Controller Inside" programmable card			
EMC filter			C3 EMC			
Equipment			A wide range of options listed in the catalogue provides add-ons for the standard offer as required. As well as the options listed in the catalogue, it is possible to customise the equipment. Just contact our teams of experts directly. - Integration of specific options			
Motorpower	kW	55	ATV61EXC2D55N4H	E1	ATV61EXC5D55N4H	E8
		75	ATV61EXC2D75N4H	E2	ATV61EXC5D75N4H	E9
		90	ATV61EXC2D90N4H	E2	ATV61EXC5D90N4H	E9
		110	ATV61EXC2C11N4H	E2	ATV61EXC5C11N4H	E9
		132	ATV61EXC2C13N4H	E3	ATV61EXC5C13N4H	E10
		160	ATV61EXC2C16N4H	E3	ATV61EXC5C16N4H	E10
		220	ATV61EXC2C22N4H	E4	ATV61EXC5C22N4H	E11
		250	ATV61EXC2C25N4H	E5	ATV61EXC5C25N4H	E12
		315	ATV61EXC2C31N4H	E5	ATV61EXC5C31N4H	E12
		400	ATV61EXC2C40N4H	E6	ATV61EXC5C40N4H	E13
		500	ATV61EXC2C50N4H	E6	ATV61EXC5C50N4H	E13
		630	ATV61EXC2C63N4H	E7	ATV61EXC5C63N4H	E14

(1) The Altivar 61 range in a ready-assembled enclosure consists of: an ATV61H...drive, an active in feed converter, a clean power filter, a switch and fast-acting fuses, an IP65 remote mounting kit for graphic display terminal.



Type of card	I/O extension Logic	Extended
Description	1 relay logic output ("C/O" contact) 4 x 24 VDC positive or negative logic inputs 2 x 24 VDC open collector positive or negative logic outputs 1 input for PTC probes	1 x 0...20 mA differential current analog input 1 software-configurable voltage (0...10 VDC) or current (0...20 mA) analog input 2 software-configurable voltage ($\pm 10V$, 0...10 VDC) or current (0...20 mA) analog inputs 1 relay logic output ("C/O" contact) 4 x 24 VDC positive or negative logic inputs 2 x 24 VDC open collector positive or negative logic outputs 1 input for PTC probes 1 frequency control input
Reference	VW3A3201	VW3A3202

"Controller Inside" programmable card



Type of card	Programmable "Controller Inside"
Description	10 logic inputs, 2 of which can be used for 2 counters or 4 of which can be used for 2 incremental encoders 2 analog inputs, 6 logic outputs, 2 analog outputs, a master port for the CANopen bus, a PC port for programming with the PS 1131 software workshop.
Reference	VW3A3501

Multi-pump cards



Type of card	Multi-pump
Description	The pump switching card ensures compatibility of applications developed on the Altivar 38.
Reference	VW3A3502
Description	This card is specific to pump switching. It ensures optimum flow for an impeccable quality of service. Its algorithm both saves energy and prolongs equipment service life.
Reference	VW3A3502
Description	The VWA3503 "Water Solution" card can be used to support all multi-pump applications.
Reference	VW3A3503
Description	This card offers all the functions needed to manage a pumping, booster, irrigation station, etc with the operational safety of a control and monitoring system.
Reference	VW3A3503

Accessories and options

Braking resistors



The network braking unit can be used to restore the following to the line supply:

- The energy from the motor
- The energy from the motors controlled by several drives connected on the same DC bus

Type of drive Supply voltage	Three-phase	
	200...240 V 50/60 Hz	380...480 V 50/60 Hz
ATV61H075M3	VW3A7701	–
ATV61HU15M3, HU22M3	VW3A7702	–
ATV61HU30M3, HU40M3	VW3A7703	–
ATV61HU55M3, HU75M3	VW3A7704	–
ATV61HD11M3X	VW3A7705	–
ATV61HD15M3X	VW3A7706	–
ATV61HD18M3X, HD22M3X	VW3A7707	–
ATV61HD30M3X	VW3A7708	–
ATV61HD37M3X, HD45M3X	VW3A7709	–
ATV61HD55M3X, HD75M3X	VW3A7713	–
ATV61HD90M3X	VW3A7714	–
ATV61H075N4...HU40N4, ATV61W075N4...WU55N4, ATV61W075N4C...WU55N4C	–	VW3A7701
ATV61HU55N4, HU75N4, ATV61WU75N4, WD11N4, ATV61WU75N4C, WD11N4C	–	VW3A7702
ATV61HD11N4, HD15N4, ATV61WD15N4, WD18N4, ATV61WD15N4C, WD18N4C	–	VW3A7703
ATV61HD18N4...HD30N4, ATV61WD22N4...WD37N4, ATV61WD22N4C...WD37N4C	–	VW3A7704
ATV61HD37N4, ATV61WD45N4, WD45N4C	–	VW3A7705
ATV61WD55N4...WD90N4, ATV61WD55N4C...WD90N4C	–	VW3A7706
ATV61HD45N4...HD75N4	–	VW3A7707
ATV61HD90N4, HC11N4	–	VW3A7710
ATV61HC13N4, HC16N4, E5C16N4	–	VW3A7711
ATV61HC22N4	–	VW3A7712
ATV61HC25N4	–	VW3A7715
ATV61HC31N4	–	VW3A7716
ATV61HC40N4, HC50N4, E5C50N4	–	VW3A7717
ATV61HC63N4	–	VW3A7718

Other accessories (please see www.schneider-electric.com)

- > Resistance braking units (integrated in ATV61 drives up to 220 kW)
- > Additional EMC input filters
- > AC line chokes
- > Optional DC chokes
- > Passive filters
- > Sinus filters
- > Motor chokes
- > Altivar AFE (Active Front End)
- > Regenerative network braking unit

Dimensions (in mm)		width x height x depth
T2	: 130 x 230 x 175	T3 : 155 x 260 x 187
T4	: 175 x 295 x 187	T5A : 210 x 295 x 213
T5B	: 230 x 400 x 213	T6 : 240 x 420 x 236
T7A	: 240 x 550 x 266	T7B : 320 x 550 x 266
T8	: 320 x 630 x 290	T9 : 320 x 920 x 377
T10	: 360 x 1022 x 377	T11 : 340 x 1190 x 377
T12	: 440 x 1190 x 377	T13 : 595 x 1190 x 377
T14	: 890 x 1390 x 377	T15 : 1120 x 1390 x 377



Type of drive		Single-phase	Three-phase	Three-phase				
Supply voltage		200...240 V (3)	200...240 V (3)	380...480 V (3)				
Degree of protection		IP20 for unprotected drives and IP41 on the upper part						
Drive	Output frequency	0...599 Hz up to 37 kW - 0...500 Hz from 45...630 kW						
	Type of control	Asynchronous motor	Flux vector control with or without sensor, voltage/frequency ratio (2 or 5 points), ENA System					
		Synchronous motor	Vector control with and without speed feedback (4)					
	Transient overtorque	220% of nominal motor torque for 2 seconds, and 170% for 60 seconds						
Speed range	1...1000 in closed loop mode with encoder feedback, 1...100 in open loop mode							
Functions	Number of functions	> 150						
	Number of preset speeds	16						
	Number of I/O	Analog inputs	2...4					
		Logic inputs	6...20					
	Analog outputs	1...3						
	Logic outputs	0...8						
	Relay outputs	2...4						
Safety input	1							
Dialogue	Remote graphic display terminal, SoMove setup software							
Communication	Integrated	Modbus and CANopen						
	As an option	Modbus TCP, Modbus/Uni-Telway, EtherNet/IP, EtherCAT, DeviceNet, PROFIBUS DP V0 and V1, INTERBUS, CC-Link.						
Cards (available as an option)	Encoder interface cards, I/O extension cards, "Controller Inside" programmable card							
Reduction of current harmonics	DC choke integrated or supplied with the product or Altivar AFE (Active Front End).							
EMC filter	Integrated	C2 EMC up to 4 kW, C3 EMC from 5,5 to 500 kW						
	As an option	C1 EMC from 0.75 to 500 kW						
Motor power	kW/HP	0.37/0.5	ATV71H075M3	T2	ATV71H037M3	T2	–	
		0.75/1	ATV71HU15M3	T2	ATV71H075M3	T2	ATV71H075N4	T2
		1.5/2	ATV71HU22M3	T3	ATV71HU15M3	T2	ATV71HU15N4	T2
		2.2/3	ATV71HU30M3	T3	ATV71HU22M3	T3	ATV71HU22N4	T2
		3/–	ATV71HU40M3 (1)	T3	ATV71HU30M3	T3	ATV71HU30N4	T3
		4/5	ATV71HU55M3 (1)	T4	ATV71HU40M3	T3	ATV71HU40N4	T3
		5.5/7.5	ATV71HU75M3 (1)	T5A	ATV71HU55M3	T4	ATV71HU55N4	T4
		7.5/10	–	–	ATV71HU75M3	T5A	ATV71HU75N4	T4
		11/15	–	–	ATV71HD11M3X (2)	T5B	ATV71HD11N4	T5A
		15/20	–	–	ATV71HD15M3X (2)	T5B	ATV71HD15N4	T5B
		18.5/25	–	–	ATV71HD18M3X (2)	T6	ATV71HD18N4	T5B
		22/30	–	–	ATV71HD22M3X (2)	T6	ATV71HD22N4	T6
		30/40	–	–	ATV71HD30M3X (2)	T7B	ATV71HD30N4	T7A
		37/50	–	–	ATV71HD37M3X (2)	T7B	ATV71HD37N4	T7A
		45/60	–	–	ATV71HD45M3X (2)	T7B	ATV71HD45N4	T8
		55/75	–	–	ATV71HD55M3X (2)	T9	ATV71HD55N4	T8
		75/100	–	–	ATV71HD75M3X (2)	T10	ATV71HD75N4	T8
		90/125	–	–	–	–	ATV71HD90N4	T9
		110/150	–	–	–	–	ATV71HC11N4	T10
		132/200	–	–	–	–	ATV71HC13N4	T11
		160/250	–	–	–	–	ATV71HC16N4	T12
		200/300	–	–	–	–	ATV71HC20N4	T13
		220/350	–	–	–	–	ATV71HC25N4	T13
		280/450	–	–	–	–	ATV71HC28N4	T13
		315/500	–	–	–	–	ATV71HC31N4	T14
		355/–	–	–	–	–	ATV71HC40N4	T14
		500/700	–	–	–	–	ATV71HC50N4	T15

(1) Must be used with a line choke.

(2) Drive supplied without EMC filter.

(3) A three-phase 380...480 V range on base plate is available from 0.75 to 11 kW.

(4) Vector control with speed feedback for synchronous motors is supported by the S383 variant of the Altivar 71.

Altivar 71

0.37...630 kW

Complex, high-power machines High performance drives



Dimensions (in mm)		width x height x depth
T2	: 130 x 230 x 175	T3 : 155 x 260 x 187
T4	: 175 x 295 x 187	T5A : 210 x 295 x 213
T5B	: 230 x 400 x 213	T6 : 240 x 420 x 236
T7A	: 240 x 550 x 266	T7B : 320 x 550 x 266
T8	: 320 x 630 x 290	T9 : 320 x 920 x 377
T10	: 360 x 1022 x 377	T11 : 340 x 1190 x 377
T12	: 440 x 1190 x 377	T13 : 595 x 1190 x 377
T14	: 890 x 1390 x 377	T15 : 1120 x 1390 x 377

Type of drive		Three-phase				
Supply voltage		500... 690 V				
Degree of protection		IP20 for unprotected drives and IP41 on the upper part				
Drive	Output frequency	0...599 Hz up to 37 kW - 0...500 Hz from 45...630 kW				
	Type of control	Asynchronous motor	Flux vector control with or without sensor, voltage/frequency ratio (2 or 5 points), ENA System			
		Synchronous motor	Vector control with and without speed feedback (1)			
	Transient overtorque	220% of nominal motor torque for 2 seconds, and 170% for 60 seconds				
Speed range		1...1000 in closed loop mode with encoder feedback, 1...100 in open loop mode				
Functions	Number of functions		> 150			
	Number of preset speeds		16			
	Number of I/O	Analog inputs	2...4			
		Logic inputs	6...20			
		Analog outputs	1...3			
	Logic outputs	0...8				
	Relay outputs	2...4				
Safety input	1					
Dialogue		Remote graphic display terminal, SoMove setup software				
Communication	Integrated	Modbus and CANopen				
	As an option	Modbus TCP, Modbus/Uni-Telway, EtherNet/IP, EtherCAT, DeviceNet, PROFIBUS DP V0 and V1, INTERBUS, CC-Link.				
Cards (available as an option)		Encoder interface cards, I/O extension cards, "Controller Inside" programmable card				
Reduction of current harmonics		DC choke integrated or DC choke optional or AFE Altivar (Active Front End)				
EMC filter		Integrated				
Motor power	kW/HP	500 V	575 V	690 V		
		kW	HP	kW		
		1.5	2	2.2	ATV71HU22Y	T6
		2.2	3	3	ATV71HU30Y	T6
		3	–	4	ATV71HU40Y	T6
		4	5	5.5	ATV71HU55Y	T6
		5.5	7.5	7.5	ATV71HU75Y	T6
		7.5	10	11	ATV71HD11Y	T6
		11	15	15	ATV71HD15Y	T6
		15	20	18.5	ATV71HD18Y	T6
		18.5	25	22	ATV71HD22Y	T6
		22	30	30	ATV71HD30Y	T6
		30	40	37	ATV71HD37Y	T8
		37	50	45	ATV71HD45Y	T8
		45	60	55	ATV71HD55Y	T8
		55	75	75	ATV71HD75Y	T8
		75	100	90	ATV71HD90Y	T8
		90	125	110	ATV71HC11Y	T11
		110	150	132	ATV71HC13Y	T11
		132	–	160	ATV71HC16Y	T11
		160	200	200	ATV71HC20Y	T13
		200	250	250	ATV71HC25Y	T13
		250	350	315	ATV71HC31Y	T13
		315	450	400	ATV71HC40Y	T15
		400	550	500	ATV71HC50Y	T15
		500	700	630	ATV71HC63Y	T15

(1) Vector control with speed feedback for synchronous motors is supported by the S383 variant of the Altivar 71.

Altivar 71

0.75...75 kW

Complex, high-power machines

IP54 drives



Dimensions (in mm)		width x height x depth	
ATV71W..., ATV71E5... up to 75 kW			
TA2	: 235 x 490 x 272	TD	: 310 x 665 x 315
TA3	: 235 x 490 x 286	TE	: 284 x 720 x 315
TB	: 255 x 525 x 286	TF	: 284 x 880 x 343
TC	: 290 x 560 x 315	TG	: 362 x 1000 x 364

Type of drive		Three-phase 380...480 V				
					With switch	
Degree of protection		UL Type 12 (1) / IP54				
Drive	Output frequency	0...599 Hz up to 37 kW - 0...500 Hz from 45...75 kW				
	Type of control	Asynchronous motor	Flux vector control with or without sensor, voltage/frequency ratio (2 or 5 points), ENA System			
		Synchronous motor	Vector control without speed feedback			
	Transient overtorque	220% of nominal motor torque for 2 seconds, and 170% for 60 seconds				
Speed range	1...1000 in closed loop mode with encoder feedback, 1...100 in open loop mode					
Functions	Number of functions	> 150				
	Number of preset speeds	16				
	Number of I/O	Analog inputs	2...4			
		Logic inputs	6...20			
		Analog outputs	1...3			
	Logic outputs	0...8				
	Relay outputs	2...4				
	Safety input	1				
Dialogue	Remote graphic display terminal, SoMove setup software					
Communication	Integrated	Modbus and CANopen				
	As an option	Modbus TCP, Modbus/Uni-Telway, EtherNet/IP, EtherCAT, DeviceNet, PROFIBUS DP V0 et V1, INTERBUS, CC-Link.				
Cards (available as an option)	Encoder interface cards, I/O extension cards, "Controller Inside" programmable card					
Reduction of current harmonics	Optional chokes and passive filters					
EMC filter	Integrated	C2 EMC				
	As an option	External C1 EMC				
Motor power	kW/HP	0.75/1	ATV71W075N4	TA2	ATV71E5075N4	TA2
		1.5/2	ATV71WU15N4	TA2	ATV71E5U15N4	TA2
		2.2/3	ATV71WU22N4	TA2	ATV71E5U22N4	TA2
		3/-	ATV71WU30N4	TA3	ATV71E5U30N4	TA3
		4/5	ATV71WU40N4	TA3	ATV71E5U40N4	TA3
		5.5/7.5	ATV71WU55N4	TB	ATV71E5U55N4	TB
		7.5/10	ATV71WU75N4	TB	ATV71E5U75N4	TB
		11/15	ATV71WD11N4	TC	ATV71E5D11N4	TC
		15/20	ATV71WD15N4	TD	ATV71E5D15N4	TD
		18.5/25	ATV71WD18N4	TD	ATV71E5D18N4	TD
		22/30	ATV71WD22N4	TD	ATV71E5D22N4	TD
		30/40	ATV71WD30N4	TF	ATV71E5D30N4	TF
		37/50	ATV71WD37N4	TF	ATV71E5D37N4	TF
		45/60	ATV71WD45N4	TG	ATV71E5D45N4	TG
		55/75	ATV71WD55N4	TG	ATV71E5D55N4	TG
		75/100	ATV71WD75N4	TG	ATV71E5D75N4	TG

(1) For ATV71W... range only.

Altivar 71

90...500 kW

Complex, high-power machines

IP54 Altivar 71 kit with preassembled enclosure



Drive		Kit
ATV71HD90N4		VW3A9541
ATV71HC11N4		VW3A9542
ATV71HC13N4		VW3A9543
ATV71HC16N4		VW3A9544
ATV71HC20N4		VW3A9545
ATV71HC25N4		
ATV71HC28N4		
ATV71HC20N4	With VW3A7101 braking unit	VW3A9546
ATV71HC25N4	With VW3A7101 braking unit	
ATV71HC28N4	With VW3A7101 braking unit	
ATV71HC31N4	Without braking unit	VW3A9547
ATV71HC40N4		
ATV71HC50N4		VW3A9548
	VW3A7102 braking unit	VW3A9549
	Additional empty enclosure (600 mm)	VW3A9550
	Additional empty enclosure (800 mm)	VW3A9551

3



Dimensions (in mm)	width x height x depth
T11	: 330 x 950 x 377
T13	: 585 x 950 x 377
T15	: 1110 x 1150 x 377

Type of drive		Three-phase	Three-phase		
Supply voltage		380...480 V	500...690 V		
Degree of protection		Sideways and front IP31 - Top IP20 - Bottom IP00			
Drive	Output frequency	0.1...500Hz			
	Type of control	Asynchronous motor	Flux vector control with or without sensor, voltage/frequency ratio (2 or 5 points), ENA System		
		Synchronous motor	Vector control without speed feedback		
	Transient overtorque	220% of nominal motor torque for 2 seconds, and 170% for 60 seconds			
Speed range		1...1000 in closed loop mode with encoder feedback, 1...100 in open loop mode			
Functions	Number of functions		> 150		
	Number of preset speeds		16		
	Number of I/O	Analog inputs	2...4		
		Logic inputs	6...20		
		Analog outputs	1...3		
		Logic outputs	0...8		
		Relay outputs	2...4		
		Safety input	1		
Dialogue		Remote graphic display terminal, SoMove setup software			
Communication	Integrated	Modbus and CANopen			
	As an option	Modbus TCP, Modbus/Uni-Telway, Fipio, Modbus Plus, Profbus DP, Profbus DP V1, DeviceNet, EthernetIP, CC-Link, INTERBUS			
Cards (available as an option)		Multi-pump cards, I/O extension cards, "Controller Inside" programmable card			
Reduction of current harmonics		Optional AC choke, Altivar AFE (Active Front End)			
EMC filter	Integrated	C3 EMC			
	As an option	C1 EMC			
Motor power	kW/HP	90/125	ATV71QD90N4	T11	–
		110/150	ATV71QC11N4	T11	–
		132/200	ATV71QC13N4	T11	–
		160/250	ATV71QC16N4	T13	–
		200/300	ATV71QC20N4	T13	–
		250/400	ATV71QC25N4	T13	–
		315/500	ATV71QC31N4	T15	–
		400/600	ATV71QC40N4	T15	–
		500/700	ATV71QC50N4	T15	–

	500 V	575 V	690 V			
	kW	HP	kW			
	90	125	110	–	ATV71QC11Y	T11
	110	150	132	–	ATV71QC13Y	T11
	132	-	160	–	ATV71QC16Y	T11
	160	200	200	–	ATV71QC20Y	T13
	200	250	250	–	ATV71QC25Y	T13
	250	350	315	–	ATV71QC31Y	T13
	315	450	400	–	ATV71QC40Y	T15
	400	550	500	–	ATV71QC50Y	T15
	500	700	630	–	ATV71QC63Y	T15

Altivar 71 Plus

90...2000 kW

Complex, high-power machines

Solutions in IP23 and IP54 ready-assembled enclosures



Dimensions (in mm)		width x height x depth	
ATV71EXC2C...			
E1 : 600 x 2162 x 642	E3 : 1000 x 2162 x 642		
E2 : 800 x 2162 x 642	E4 : 1200 x 2162 x 642		

Type of drive		Three-phase 380...480 V	
Degree of protection		IP23, IP54	
Drive	Output frequency	0...500 Hz	
	Type of control	Asynchronous motor Flux vector control with or without sensor, voltage/frequency ratio (2 or 5 points), ENA System	
		Synchronous motor Vector control without speed feedback	
	Transient overtorque	220% of nominal motor torque for 2 seconds, and 170% for 60 seconds	
Speed range		1...1000 in closed loop mode with encoder feedback, 1...100 in open loop mode	
Functions	Number of functions	> 150	
	Number of preset speeds	16	
	Number of I/O	Analog inputs	2...4
		Logic inputs	6...20
	Analog outputs	1...3	
	Logic outputs	0...8	
	Relay outputs	2...4	
	Safety input	1	
Dialogue		Remote graphic display terminal, SoMove setup software	
Communication	Integrated	Modbus and CANopen	
	As an option	Modbus TCP, Modbus/Uni-Telway, EtherNet/IP, EtherCAT, DeviceNet, PROFIBUS DP V0 et V1, INTERBUS, CC-Link.	
Cards (available as an option)		Encoder interface cards, I/O extension cards, "Controller Inside" programmable card,	
Reduction of current harmonics		DC choke or Integrated AC choke, variant 12 pulse, AFE Altivar (Active Front End)	
EMC filter	Integrated	C3 EMC	
	As an option	External C1 EMC	
Equipment		A wide range of options listed in the catalogue provides add-ons for the standard offer as required. As well as the options listed in the catalogue, it is possible to customise the equipment. Just contact our teams of experts direct. - Water cooling solution - Integration of specific options	

3

IP23	Three-phase 380...415 V			Three-phase 500 V			Three-phase 690 V		
	kW/HP	Dimensions		kW	Dimensions		kW	Dimensions	
	90/125	ATV71EXC2D90N4	E1	90	ATV71 EXC2D90N	E1	-		
	110/150	ATV71EXC2C11N4	E1	110	ATV71 EXC2C11N	E1	110	ATV71 EXC2C11Y	E1
	132/200	ATV71EXC2C13N4	E1	132	ATV71 EXC2C13N	E1	132	ATV71 EXC2C13Y	E1
	160/250	ATV71EXC2C16N4	E1	160	ATV71 EXC2C16N	E2	160	ATV71 EXC2C16Y	E1
	200/300	ATV71EXC2C20N4	E2	200	ATV71 EXC2C20N	E2	200	ATV71 EXC2C20Y	E2
	250/400	ATV71EXC2C25N4	E2	250	ATV71 EXC2C25N	E2	250	ATV71 EXC2C25Y	E2
	280/450	ATV71EXC2C28N4	E2	-	-	-	-		
	315/500	ATV71EXC2C31N4	E3	315	ATV71 EXC2C31N	E4	315	ATV71 EXC2C31Y	E2
	400/600	ATV71EXC2C40N4	E3	400	ATV71 EXC2C40N	E4	400	ATV71 EXC2C40Y	E4
	500/700	ATV71EXC2C50N4	E4	500	ATV71 EXC2C50N	E4	500	ATV71 EXC2C50Y	E4
							630	ATV71EXC2C63N4	E4

- (1) The Altivar 71 range in ready-assembled enclosure consists of:
- An ATV71H... drive
 - A switch and fast-acting fuses
 - An IP65 remote mounting kit for graphic display terminal

Altivar 71 Plus

90...2000 kW

Complex, high-power machines

Solutions in IP23 and IP54 ready-assembled enclosures



Dimensions (in mm)		width x height x depth	
ATV71EX...			
E5 : 600 x 2262 x 642	E9 : 600 x 2362 x 642		
E6 : 800 x 2262 x 642	E10 : 800 x 2362 x 642		
E7 : 1000 x 2262 x 642	E11 : 1000 x 2362 x 642		
E8 : 1200 x 2262 x 642	E12 : 1200 x 2362 x 642		
	E13 : 1400 x 2362 x 642		
	E14 : 1600 x 2362 x 642		

IP54	Three-phase 380...415 V				Three-phase 500 V				Three-phase 690 V			
	kW/HP		Dimensions		kW		Dimensions		kW		Dimensions	
Compact floor-standing enclosure	90/125		ATV71EXC5D90N4	E5	90	ATV71EXC5D90N	E5					
	110/150		ATV71EXC5C11N4	E5	110	ATV71EXC5C11N	E5	110	ATV71EXC5C11Y	E5		
	132/200		ATV71EXC5C13N4	E5	132	ATV71EXC5C13N	E5	132	ATV71EXC5C13Y	E5		
	160/250		ATV71EXC5C16N4	E5	160	ATV71EXC5C16N	E6	160	ATV71EXC5C16Y	E5		
	220/350		ATV71EXC5C20N4	E6	200	ATV71EXC5C20N	E6	200	ATV71EXC5C20Y	E6		
	250/400		ATV71EXC5C25N4	E6	250	ATV71EXC5C25N	E6	250	ATV71EXC5C25Y	E6		
	280/450		ATV71EXC5C28N4	E6		–			–			
	315/500		ATV71EXC5C31N4	E7	315	ATV71EXC5C31N	E8	315	ATV71EXC5C31Y	E6		
	400/600		ATV71EXC5C40N4	E7	400	ATV71EXC5C40N	E8	400	ATV71EXC5C40Y	E8		
	500/700		ATV71EXC5C50N4	E8	500	ATV71EXC5C50N	E8	500	ATV71EXC5C50Y	E8		
								630	ATV71EXC5C63Y	E8		

IP54	Three-phase 380...415 V				Three-phase 500 V				Three-phase 690 V			
	kW/HP		Dimensions		kW		Dimensions		kW		Dimensions	
Separate air flow	90/125		ATV71EXS5D90N4	E9	90	ATV71EXS5D90N	E11					
	110/150		ATV71EXS5C11N4	E9	110	ATV71EXS5C11N	E11	110	ATV71EXS5C11Y	E11		
	132/200		ATV71EXS5C13N4	E9	132	ATV71EXS5C13N	E11	132	ATV71EXS5C13Y	E11		
	160/250		ATV71EXS5C16N4	E9	160	ATV71EXS5C16N	E12	160	ATV71EXS5C16Y	E11		
	220/350		ATV71EXS5C20N4	E10	200	ATV71EXS5C20N	E12	200	ATV71EXS5C20Y	E12		
	250/400		ATV71EXS5C25N4	E10	250	ATV71EXS5C25N	E12	250	ATV71EXS5C25Y	E12		
	280/450		ATV71EXS5C28N4	E10		–			–			
	315/500		ATV71EXS5C31N4	E13	315	ATV71EXS5C31N	E14	315	ATV71EXS5C31Y	E12		
	400/600		ATV71EXS5C40N4	E13	400	ATV71EXS5C40N	E14	400	ATV71EXS5C40Y	E14		
	500/700		ATV71EXS5C50N4	E14	500	ATV71EXS5C50N	E14	500	ATV71EXS5C50Y	E14		
								630	ATV71EXS5C63Y	E14		



Dimensions (in mm) width x height x depth without remote graphic terminal	
T4 : 175 x 295 x 161	T6 : 240 x 420 x 210
T5A : 210 x 295 x 187	T7 : 240 x 550 x 230
T5B : 230 x 400 x 187	

Type of drive		Three-phase	Three-phase			
Supply voltage		200...240 V	380...480 V			
Degree of protection		IP20 for unprotected drives and IP41 on the upper part				
Drive	Output frequency	0...599 Hz				
	Type of control	Asynchronous motor	Flux vector control with or without sensor, voltage/frequency ratio			
		Synchronous motor	Vector control with and without speed feedback			
	Transient overtorque		220% of nominal motor torque for 2 seconds, and 170% for 60 seconds			
Speed range		1...1000 in closed loop mode with encoder feedback, 1...100 in open loop mode				
Functions	Number of functions		> 150			
	Number of preset speeds		16			
	Number of I/O	Analog inputs	2...4			
		Logic inputs	6...20			
		Analog outputs	1...3			
		Logic outputs	0...8			
		Relay outputs	2...4			
Safety input		1				
Dialogue		Remote graphic display terminal, SoMove setup software				
Communication	Integrated	Modbus and CANopen				
	As an option	Ethernet, PROFIBUS DP, DeviceNet, Uni-Telway, INTERBUS				
Cards (available as an option)		Encoder interface cards, I/O extension cards, "Controller Inside" programmable card, Encoder emulation card				
Reduction of current harmonics		Integrated DC choke or supplied with the product				
EMC filter	Integrated	C2 EMC up to 5.5 kW				
	As an option	External C2 EMC from 7.5 kW				
Motor power	kW / HP / A	4 / 5 / 10	–	ATV71LD10N4Z	T4	
		5,5 / 7,5 / 14	–	ATV71LD14N4Z	T4	
		5,5 / 7,5 / 27	ATV71LD27M3Z	T5B	–	
		7,5 / 10 / 17	–	ATV71LD17N4Z	T5A	
		7,5 / 10 / 33	ATV71LD33M3Z	T5B	–	
		11 / 15 / 27	–	ATV71LD27N4Z	T5B	
		11 / 15 / 54	ATV71LD54M3Z	T6	–	
		15 / 20 / 33	–	ATV71LD33N4Z	T5B	
		15 / 20 / 66	ATV71LD66M3Z	T6	–	
		22 / 30 / 48	–	ATV71LD48N4Z	T7	

(1) SoMove setup software : available from 2011. Altivar LIFT is also supported by Powersuite software workshop.



Type of card	I/O extension	Extended
	Logic	
Description	1 relay logic output ("C/O" contact) 4 x 24 VDC positive or negative logic inputs 2 x 24 VDC open collector positive or negative logic outputs 1 input for PTC probes	1 x 0...20 mA differential current analog input 1 software-configurable voltage (0...10 VDC) or current (0...20 mA) analog input 2 software-configurable voltage ($\pm 10V$, 0...10 VDC) or current (0...20 mA) analog inputs 1 relay logic output ("C/O" contact) 4 x 24 VDC positive or negative logic inputs 2 x 24 VDC open collector positive or negative logic outputs, 1 input for PTC probes, 1 frequency control input
Reference	VW3A3201	VW3A3202

3

"Controller Inside" programmable card



Type of card	Programmable "Controller Inside"
Description	10 logic inputs, 2 of which can be used for 2 counters or 4 of which can be used for 2 incremental encoders 2 analog inputs, 6 logic outputs, 2 analog outputs, a master port for the CANopen bus, a PC port for programming with the PS 1131 software workshop
Reference	VW3A3501

Encoder interface cards



Type of card	Encoder interface with		
	Differential outputs (RS422)	Open collector outputs (NPN)	Push-pull outputs
Operating frequency	300 kHz		
Reference	VW3A3401	–	–
5 V	–	VW3A3403	VW3A3405
12 V	–	VW3A3404	VW3A3406
15 V	VW3A3402	–	VW3A3407
24 V	–	–	–

3

Type of card (1)	Resolver	Universal	Incremental with emulation
Speed feedback resolution	12 bits	16 bits	10,000
Encoder type supported	Resolver with 2, 4, 6 or 8 poles	"SinCos, SinCosHiperface EnDat, SSI"	"Incremental RS 422 - 5 V or 15 V"
References	VW3A3408	VW3A3409	VW3A3411

Supported by Altivar LIFT and Altivar71 with S383 firmware version



Communication tools	Remote display terminal (IP54 & IP65)	Remote graphic display terminal	Multi-loader	Simple Loader	Dongle Bluetooth® (TM)
Altistart 01					
Altistart 22	x				x
Altistart 48	x				
Altivar 12	x		x	x	x
Altivar 212	x	x	x	x	x
Altivar 312	x	x	x	x	x
Altivar 31C	x			x	x
Altivar 32	x	x	x	x	
Altivar LIFT		x	x	x	x
Altivar 61		x	x	x	x
Altivar 71		x	x	x	x
Altivar 61 Plus		x	x	x	x
Altivar 71 Plus		x	x	x	x
Altivar 61Q (Water Cooled)		x	x	x	x
Altivar 71Q (Water Cooled)		x	x	x	x

Accessories & Options	ALTIVAR													
	12	21	212	312	31C	32	61	71	LIFT	61 Plus	71 Plus	61Q	71Q	
Panel cut-out adaptor for mounting control unit at 90°			x											
Ferrite suppressors for downstream contactor opening	x	x		x	x									
Additional EMC filter	x	x	x	x	x	x	x	x	x	x	x	x	x	x
Passive filters				x	x			x	x	x	x	x	x	x
Sinus filters				x	x			x	x	x	x	x	x	x
Line choke		x	x	x	x	x	x	x	x	x	x	x	x	x
Motor chokes	x	x	x	x	x	x	x	x	x	x	x	x	x	x
EMC conformity kit														
UL Type 1 conformity kit	x			x										
Mechanical base kit for mounting GV2 circuit-breaker			x											
Mounting plates	x		x	x	x	x	x		x				x	
Braking resistors for vertical movements					x	x								
Braking resistors and braking units	x	x	x	x	x	x	x	x	x	x	x	x	x	x
References	If options or accessories not listed, please see: www.schneider-electric.com													



Industrial protocols	ALTISTART			ALTIVAR													
	01	22	48	12	212	312	31C	32	61	71	LIFT	61 Plus	71 Plus	61Q	71Q	1000	1100
Canopen						●	●	●	●	●	●	●	●	●	●	○	
CANopen Daisy chain						○											
CC-Link									○	○	○	○	○	○	○		
DeviceNet			Δ			○	○	○	○	○	○	○	○	○	○	○	
EtherCAT			Δ					○	○	○							
Ethernet			Δ													●	
Ethernet IP								○	○	○	○	○	○	○	○		
Ethernet TCP/IP							○			○							
Fipio			○			○	○		○			○		○			
INTERBUS S									○	○	○	○	○	○	○		
Modbus		●	●	●	●	●	●	●	●	●	●	●	●	●	●	●	●
Modbus Plus									○			○		○			
Modbus TCP						○		○	○	○	○	○	○	○	○		
Modbus/ Unitelway									○	○	○	○	○	○	○		
PROFIBUS DP			Δ			○	○	○	○	○	○	○	○	○	○	●	●
PROFIBUS DP V0								○	○	○	○	○	○	○	○		
PROFIBUS DP V1								○	○	○	○	○	○	○	○		
References	Please see: www.schneider-electric.com																

HVAC protocols	ALTISTART			ALTIVAR													
	01	22	48	12	212	312	31C	32	61	71	LIFT	61 Plus	71 Plus	61Q	71Q	1000	1100
Lonworks					○				○			○		○			
Metasys N2					●				○			○		○			
Apogee FLN					●				○			○		○			
BACnet					●				○			○		○			
References	Please see: www.schneider-electric.com																

● Embedded ○ Option Δ Gateway

Communication modules



Altistart 48/Altivar 31 starters/drives		Ethernet/Modbus	DeviceNet/Modbus	Fipio/Modbus	PROFIBUS DP/Modbus	
Parameter setting		–	–	–	Standard configurator	ABC configurator program
References	Bridge	TSXETG100	–	–	–	–
	Gateway	–	LUFP9	LUFP1	LA9P307	LUFP7
Cable references	L = 0.3 m	–	VW3A8306R03	VW3A8306R03	–	VW3A8306R03
	L = 1 m	–	VW3A8306R10	VW3A8306R10	VW3P07306R10	VW3A8306R10
	L = 3 m	VW3A8306D30	VW3A8306R30	VW3A8306R30	–	VW3A8306R30

Drives, motors and linear motion axes

Selection guide

⇒ *Applications:*

Lexium servo drives are the perfect drive for applications involving high-precision, dynamic positioning.

3

Servo Drives & Motors

Integrated Servo Drive

Lexium 23 Plus Lexium BCH



Lexium 32



Lexium BMH



Lexium BSH



Lexium 32i



Machines

Textile machines, Electronics machines, Packaging machines, Material working machines, Material handling machines, Printing machines

Packaging machines, Material handling machines, Material working machines, Assembling machines

Packaging machines, Material handling machines, Material working machines, Assembling machines

Description

The Lexium 23 Plus servo range consists of two book-size servo drive models – Lexium 23A with CANopen interface, Lexium 23D with pulse train interface plus the motor family Lexium BCH from ultra low inertia to high inertia.

The Lexium 32 servo range consists of three high-performance book-size servo drive models – Lexium 32 Compact, Lexium 32 Advanced and Lexium 32 Modular – and two motor families – the versatile medium-inertia Lexium BMH and the dynamic low-inertia Lexium BSH.

The Lexium 32i is an integrated servo drive and comprises motor, positioning controller, power electronics, fieldbus and “Safe Torque Off” safety function in an extremely compact single device.

Power range

0.1 kW...7.5 kW

0.15...7 kW

0.6...2.2 kW

Voltage range

1 or 3 phase 170...255 VAC

1 phase 115...240 VAC, 3 phase 400...480 VAC

1 phase 115...240 VAC, 3 phase 400...480 VAC

Speed

1000rpm to 3000rpm depending on the motor

up to 8000 rpm

up to 3600 rpm

Torque

up to 47.74Nm

up to 84 Nm

up to 7.8 Nm

Interfaces

CANopen

CANopen, CANmotion, PROFIBUS DP, DeviceNet, EtherNet/IP, Pulse train, +/- 10V Encoder modules for digital and analog encoders and resolvers

CANopen, CANmotion, EtherCAT

Safety functions

Safe Torque Off (STO) on board
Enhanced Safety Module: Safe Stop 1 (SS1), Safe Stop 2 (SS2), Safely Limited Speed (SLS), Safe Operation Stop (SOS)

Safe Torque Off (STO) on board

⇒ Applications :

Lexium Integrated Drives allow for extremely space-saving decentralised motion solutions.

⇒ Applications :

Lexium SDx stepper drives and motors are used for short-distance positioning applications requiring maximum accuracy and high torque.

⇒ Applications :

The Lexium Linear Motion products are designed for maximum flexibility, performance and cost-effectiveness. This range offers products for all linear movements in the automation industry from single-axis to multi-axis systems.

Integrated Drives

Stepper Drives & Motors

Linear Motion

Lexium ILA

Lexium ILE



Lexium SD2

Lexium BRS2



Lexium PAS

Lexium CAS



Lexium ILP / ILT

Lexium ILS



Lexium SD3

Lexium BRS3



Lexium TAS

Lexium MAX



Format adjustment, Printing machines, Material handling machines

Printing machines, Labelling machines, Screen printing machines

Material handling machines
Material working machines
On-the-fly working machines
Assembling machines

The Lexium ILx Integrated Drives comprise motor, positioning controller, power electronics, fieldbus and "Safe Torque Off" safety function in an extremely compact single device. Lexium ILx Integrated Drives are available with multiple motor technologies (servo, brushless DC, stepper).

The Lexium SDx stepper motor drive range consists of two high-precision stepper drive lines – the three-phase stepper drives Lexium SD3 and the two-phase stepper drives Lexium SD2. These drive lines are complemented by two perfectly matched stepper motor families – Lexium BRS3 three-phase stepper motors and Lexium BRS2 two-phase stepper motors.

Lexium Linear Motion is a comprehensive linear motion range comprising Lexium PAS portal axes, Lexium TAS linear tables, Lexium CAS cantilever and telescopic axes and Lexium MAX multi-axis systems.

150 - 305 W

12...48 VDC, 1 phase 115...240 VAC

up to 9000 rpm

up to 12 Nm

RS485, CANopen, PROFIBUS DP, DeviceNet, EtherNet/IP, EtherCAT, Ethernet POWERLINK, Modbus TCP, Pulse train

Safe Torque Off (STO) on board
(Lexium ILA, Lexium ILE, Lexium ILS)

up to 750 W

24...48 VDC, 1 phase 115...240 VAC

up to 1000 rpm

up to 16.5 Nm

CANopen, CANmotion, PROFIBUS DP or Pulse train

Safe Torque Off (STO) on board
(Lexium SD3 28)

Single axes:

Stroke up to 5.5 m

Load up to 150 kg

Speed up to 8 m/s

Multi axes:

Stroke up to 5.5 m

Load up to 130 kg

Speed up to 4 m/s

Available as individual components or completely pre-assembled, customised systems with drives and motors

Lexium 23 Plus Motion control

Lexium 23 Plus servo drives and motors



Main functions	Lexium23A-CANopen Version	Lexium23D-Pulse Train Version
Communication	CANopen CANmotion Pulse Train RS485	Pulse Train RS485
Operating modes	Jog mode Profile Position mode Profile Velocity mode Profile Torque mode Homing mode	Electronic gearbox Positioning mode Speed mode Torque mode
Functions	Auto-tuning 2-notch filters Position capture	Auto-tuning 2-notch filters Position capture
24V logic inputs	8 reassignable	8 reassignable
24V logic outputs	5 reassignable	5 reassignable
Analog inputs	2	2
Pulse control input	RS422 500kHz(standard)/4MHz(high-speed) 200KHz open collector	
ESIM PTO output	1 RS422	1 RS422
Encoder	high-speed pulse train	high-speed pulse train
Architecture	Control Via: CANopen CANmotion Pulse Train Analog input	Control Via: Pulse Train Analog input
Type of servo drive	Lexium 23A	Lexium 23D



Main functions	
Application type	From ultra-low inertia to high inertia, fitting from high-dynamic applications to high-load applications
Flange size	40, 60, 80, 100, 130 and 180mm
Continuous stall torque	0.32 to 47.74Nm
Encoder type	incremental 20bits*
Degree of protection	Casing Shaft end
	IP65 IP40 (standard) / IP65 (option)
Type of servo motor	Lexium BCH

*With a battery encoder cable, absolute positioning can be realized, this function will come

Lexium 23 Plus Motion control

Servo drive/servo motor combinations

Servo drive	Servo motor	Power (w)	Rated Torque (Nm)	Peak Torque (rpm)	Rated Speed (rpm)	Peak Speed (rpm)	Inertial w/o Brake (kg cm ²)	motor inertia type
Single phase: 200...255 V 50/60 Hz or three phase: 170...255 V 50/60 Hz								
LXM23●U01M3X	BCH0401O●2●●●	100	0.32	0.96	3000	5000	0.037	ultra low
LXM23●U02M3X	BCH0601O●2●●●	200	0.64	1.92	3000	5000	0.177	ultra low
LXM23●U04M3X	BCH1301M●2●●●	300	2.86	8.59	1000	2000	8.17	medium
LXM23●U04M3X	BCH0602O●2●●●	400	1.27	3.82	3000	5000	0.277	ultra low
LXM23●U04M3X	BCH0801O●2●●●	400	1.27	3.82	3000	5000	0.68	low
LXM23●U04M3X	BCH1301N●2●●●	500	2.39	7.16	2000	3000	8.17	medium
LXM23●U07M3X	BCH1302M●2●●●	600	5.73	17.19	1000	2000	8.41	medium
LXM23●U07M3X	BCH0802O●2●●●	750	2.39	7.16	3000	3000	1.13	low
LXM23●U10M3X	BCH1303M●2●●●	900	8.59	25.78	1000	2000	11.18	medium
LXM23●U10M3X	BCH1001O●2●●●	1000	3.18	9.54	3000	5000	2.65	low
LXM23●U10M3X	BCH1302N●2●●●	1000	4.77	14.32	2000	3000	11.18	medium
LXM23●U15M3X	BCH1303N●2●●●	1500	7.16	21.48	2000	3000	11.18	medium
Three phase: 170...255 V 50/60 Hz								
LXM23●U20M3X	BCH1002O●2●●●	2000	6.37	19.11	3000	5000	4.45	low
LXM23●U20M3X	BCH1304N●2●●●	2000	9.55	26.65	2000	3000	14.59	medium
LXM23●U20M3X	BCH1801N●2●●●	2000	9.55	26.65	2000	3000	34.58	high
LXM23●U30M3X	BCH1802N●2●●●	3000	14.32	42.96	2000	3000	54.95	high
LXM23●U30M3X	BCH1802M●2●●●	3000	19.1	57.29	1500	3000	54.95	high
LXM23●U45M3X	BCH1803N●2●●●	3500	16.71	50.31	2000	3000	54.8	high
LXM23●U45M3X	BCH1803M●2●●●	4500	28.65	71.62	1500	3000	77.75	high
LXM23●U55M3X	BCH1804M●2●●●	5500	35.01	87.53	1500	3000	99.78	high
LXM23●U75M3X	BCH1805M●2●●●	7500	47.74	119.36	1500	3000	142.7	high



Main functions		Lexium 32 Compact	Lexium 32 Advanced	Lexium 32 Modular
Communication	Integrated	Modbus serial link Pulse train	Modbus serial link CANopen, CANmotion machine bus	Modbus serial link Pulse train
	As an option	–	–	CANopen, CANmotion machine bus, DeviceNet, EtherNet/IP, PROFIBUS DP, EtherCAT, I/O module
	Operating modes	Manual mode (JOG), Electronic gearbox, Speed control, Current control	Homing, Manual mode (JOG), Speed control, Current control, Position control	Homing, Manual mode (JOG), Motion sequence, Electronic gearbox, Speed control, Current control, Position control
	Functions	Auto-tuning, monitoring, stopping, conversion –	Stop window, Rapid entry of position values	Stop window, Rapid entry of position values, Rotary axes, Position register
24 V $\overline{\text{N}}$ logic inputs		6, reassignable	3, reassignable	4, reassignable
24 V $\overline{\text{N}}$ capture inputs (1) (2)		–	1	2
24 V $\overline{\text{N}}$ logic outputs (1)		5, reassignable	2, reassignable	3, reassignable
Analog inputs		2	–	–
Pulse control input		1, configurable as: RS 422 link 5 V or 24 V push-pull 5 V or 24 V open collector		
ESIM PTO output		RS 422 link		
Safety functions	Integrated	"Safe Torque Off" STO		
	As an option	–	–	Safe Stop 1 (SS1) and Safe Stop 2 (SS2) Safe Operating Stop (SOS) Safe Limited Speed (SLS)
Sensor	Integrated	SinCos Hiperface® sensor		
	As an option	–	–	Resolver encoder, Analog encoder, Digital encoder
Architecture		Control via: Logic or analog I/O	Control via: Motion controller via CANopen and CANmotion machine bus	Control via: Schneider Electric or third-party PLCs via communication buses and networks
Type of servo drive		LXM 32C	LXM 32A	LXM 32M



Main functions		BMH	BSH
Application type		High load, With robust adjustment of the movement	High dynamic range, Power density
Flange size		70, 100, 140 and 190 mm	55, 70, 100 and 140 mm
Continuous stall torque		1.2 to 84 Nm	0.5 to 33.4 Nm
Encoder type		Single turn SinCos: 32,768 points/turn and 131,072 points/turn Multiturn SinCos: 32,768 points/turn x 4096 turns and 131,072 points/turn x 4096 turns	Single turn SinCos: 131,072 points/turn Multiturn SinCos: 131,072 points/turn x 4096 turns
Degree of protection	Casing	IP 65 (IP 67 conformity kit as an option)	
	Shaft end	IP 50 or IP 65 (IP 67 conformity kit as an option)	
Type of servo motor		BMH	BSH



Communication modules

Lexium 32M can be connected to the following communication buses and networks: CANopen and CANmotion, DeviceNet, Profibus DP V1, EtherNet/IP, I/O module

Reference	Module description	Part number
	CANopen / CANmotion module with 2 * RJ 45 connectors	VW3 A3 608
	CANopen / CANmotion module with SUB-D 9 connector	VW3 A3 618
	DeviceNet module	VW3 M3 301
	Profibus DP V1 module	VW3 A3 607
	EtherNet/IP module	VW3 A3 616
	Module CANopen / CANmotion one 5-way screw terminal block	VW3 A3 628
	Module EtherCAT with 2 RJ45 connectors	VW3 A3 601
	I/O module with 4DI, 2DO, 2AI, 2AO	VW3 M3 302



Second encoder modules

Lexium 32M has an input for an additional encoder to connect third party motor (motor encoder) or to improve positioning accuracy (machine encoder)

Reference	Module description	Machine	Motor
	Module for resolver encoder		x
	Module for digital encoder (A/B/I, BiSS, EndDat 2.2, SSI)	x	
	Module for analog encoder (1 Vpp/Hall, 1 Vpp, Hiperface)	x (Hiperface only)	x



Safety module

eSM safety module allows Lexium 32M servo drives to access additional IEC/EN 61800-5-2 safety functions: SS1, SS2, SLS, SOS

Reference	Module description	Part number
	eSM safety module allows	VW3 M3 501

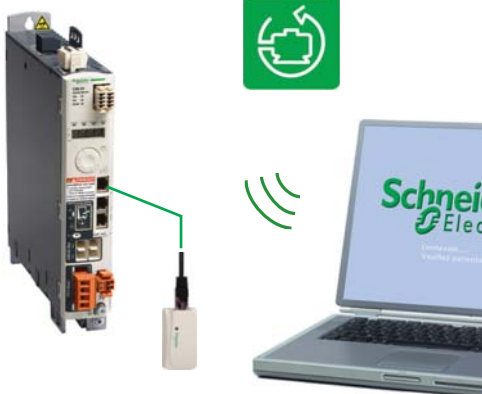

SoMove setup software

The SoMove setup software is used to configure, adjust, debug and maintain the Lexium 32 servo drive, as for all other Schneider Electric variable speed drives and starters.

It communicates via Bluetooth® wireless link with the servo drive, which is equipped with the Modbus-Bluetooth® adaptor (VW3 A8 114).

SoMove Mobile application for mobile phone

The SoMove Mobile software converts any compatible mobile phone into a remote graphic display terminal, offering an identical Human-Machine Interface.

Particularly suitable for on-site or remote maintenance operations, the SoMove Mobile software can be used to print out and save configurations, import them from a PC and export them to a PC, or to a servo drive equipped with the Modbus adaptor via the Bluetooth® wireless link.



Lexium 32 servo drive/BMH or BSH servo motor combinations

Servo motors				Lexium 32C, 32A and 32M servo drives			
BMH (IP50, IP65 or IP67)		BSH (IP50, IP65 or IP67)		100...120 V single-phase supply voltage with integrated EMC filter			
				LXM 32●U90M2			
				Continuous output current: 3 A rms			
				Nominal operating point			Stall torques
Type of servo motor	Rotor inertia	Type of servo motor	Rotor inertia	Nominal torque	Nominal speed	Nominal power	M_0/M_{max}
	kgcm ²		kgcm ²	Nm	rpm	W	Nm/Nm
		BSH 0551T	0.06	0.49	3000	150	0.5/1.5
		BSH 0552T	0.10	0.77	3000	250	0.8/1.9
		BSH 0553T	0.13				
BMH 0701T	0.59						
		BSH 0701T	0.25				
		BSH 0702T	0.41				
BMH 0702T	1.13						
BMH 0703T	1.67						
		BSH 1001T	1.40				
BMH1001T	3.2						
BMH1002T	6.3						

- (1) These values are given for a supply voltage of 120 V single phase.
 (2) - M_0 : Continuous stall torque,
 - M_{max} : Peak stall torque.

Lexium 32 servo drive/BMH or BSH servo motor combinations

Servo motors				Lexium 32C, 32A and 32M servo drives			
BMH (IP50, IP65 or IP67)		BSH (IP 50, IP65 or IP67)		200...240 V single-phase supply voltage with integrated EMC filter			
				LXM 32●U45M2			
				Continuous output current: 1.5 A rms			
				Nominal operating point			Stall torques
Type of servo motor	Rotor inertia	Type of servo motor	Rotor inertia	Nominal torque	Nominal speed	Nominal power	M_0/M_{max}
	kgcm ²		kgcm ²	Nm	rpm	W	Nm/Nm
		BSH 0551T	0.06	0.45	6000	300	0.5/1.4
		BSH 0552T	0.10				
		BSH 0553T	0.13				
		BSH 0701T	0.25				
BMH 0701T	0.59						
		BSH 0702T	0.41				
		BSH 0703T	0.58				
BMH 0702T	1.13						
		BSH 1001T	1.40				
BMH 0703T	1.67						
BMH 1001T	3.2						
		BSH 1002T	2.31				
BMH 1002T	6.3						
BMH 1003T	9.4						
BMH 1401P	16.5						

- (1) These values are given for a supply voltage of 240 V single phase.
 (2) - M_0 : Continuous stall torque,
 - M_{max} : Peak stall torque.

LXM 32●U18M2 Continuous output current: 6 A rms				LXM 32●D30M2 Continuous output current: 10 A rms			
Nominal operating point			Stall torques	Nominal operating point			Stall torques
Nominal torque	Nominal speed	Nominal power	M_0/M_{max}	Nominal torque	Nominal speed	Nominal power	M_0/M_{max}
Nm	rpm	W	Nm/Nm	Nm	rpm	W	Nm/Nm
1.14	3000	350	1.2/3.3				
1.35	2500	350	1.4/4.2				
1.36	2500	350	1.4/3.5				
				2.07	2500	550	2.2/6.1
				2.3	2500	600	2.5/6.4
				3.1	2000	650	3.4/8.7
				2.75	2500	700	3.3/6.3
				3.3	2000	700	3.4/8.9
				3.5	2000	750	6/10.3

LXM 32●U90 M2 Continuous output current: 3 A rms				LXM 32●D18M2 Continuous output current: 6 A rms				LXM 32●D30M2 Continuous output current: 10 A rms			
Nominal operating point			Stall torques	Nominal operating point			Stall torques	Nominal operating point			Stall torques
Nominal torque	Nominal speed	Nominal power	M_0/M_{max}	Nominal torque	Nominal speed	Nominal power	M_0/M_{max}	Nominal torque	Nominal speed	Nominal power	M_0/M_{max}
Nm	rpm	W	Nm/Nm	Nm	rpm	W	Nm/Nm	Nm	rpm	W	Nm/Nm
0.74	6000	450	0.8/2.5								
0.84	6000	550	1.2/3								
0.94	5000	500	1.3/3.5								
1.1	4000	450	1.4/4								
				1.8	5000	950	2.2/7.2				
				2.1	4000	900	2.6/7.4				
				2.1	4000	900	2.5/7.4				
				2.2	4000	900	2.7/7.5				
				2.9	3000	900	3.4/10.2				
				2.8	3000	900	3.4/10.2				
								3.7	4000	1500	5.8/16.4
								4.6	3000	1450	6/18.4
								5.6	2500	1450	8.2/22.8
								6.9	2000	1450	10.3/30.8



Lexium 32 servo drive/BMH or BSH servo motor combinations

Servo motors				Lexium 32C, 32A and 32M servo drives 208...480 V three-phase supply voltage with integrated EMC filter								
BMH (IP50, IP65 or IP67)		BSH (IP50, IP 65 or IP67)		LXM 32●U60N4 Continuous output current: 1.5 A rms				LXM 32●D12N4 Continuous output current: 3 A rms				
Type of servo motor	Rotor inertia kgcm ²	Type of servo motor	Rotor inertia kgcm ²	Nominal operating point			Stall torques	Nominal operating point			Stall torques	
				Nominal torque Nm	Nominal speed rpm	Nominal power W	M ₀ /M _{max}	Nominal torque Nm	Nominal speed rpm	Nominal power W	M ₀ /M _{max}	
		BSH 0551P	0.06	0.48	6000	300	0.5/1.5					
		BSH 0552P	0.10	0.65	6000	400	0.8/2.5					
		BSH 0553P	0.13	0.65	6000	400	1.05/3.5					
BMH 0701P	0.59			1.1	3000	350	1.2/4.2					
BMH 0701P	0.59							1.3	5000	700	1.4/4.2	
		BSH 0701P	0.25					1.32	5000	700	1.4/3.5	
		BSH 0702P	0.41					1.64	5000	850	2.2/7.6	
BMH 1001P	3.2							1.9	4000	800	3.3/10.8	
BMH 0702P	1.13							2.2	3000	700	2.5/7.4	
BMH 0703P	1.67											
		BSH 0703P	0.58									
		BSH 1001P	1.40									
BMH 1001P	3.2											
BMH 1002P	6.3											
		BSH 1002P	2.31									
BMH 1003P	9.4											
		BSH 1003P	3.2									
BMH 1401P	16.5											
		BSH 1004P	4.2									
		BSH 1401P	7.4									
BMH 1402P	32.0											
		BSH 1402T	12.7									
		BSH 1403T	17.9									
BMH 1403P	47.5											
		BSH 1404P	23.7									
BMH 1901P	67.7											
BMH 1902P	130											
BMH 1903P	194											

(1) These values are given for a supply voltage of 400 V three phase.

(2) - M₀: Continuous stall torque,

- M_{max}: Peak stall torque.

LXM 32●D18N4 Continuous output current: 6 A rms				LXM 32●D30N4 Continuous output current: 10 A rms				LXM 32●D72N4 Continuous output current: 24 A rms			
Nominal operating point			Stall torques	Nominal operating point			Stall torques	Nominal operating point			Stall torques
Nominal torque	Nominal speed	Nominal power	M ₀ /M _{max}	Nominal torque	Nominal speed	Nominal power	M ₀ /M _{max}	Nominal torque	Nominal speed	Nominal power	M ₀ /M _{max}
Nm	rpm	W	Nm/Nm	Nm	rpm	W	Nm/Nm	Nm	rpm	W	Nm/Nm
2.4	5000	1300	3.4/10.2								
2.44	5000	1300	3.1/11.3								
2.7	4000	1100	3.3/9.6								
3.1	4000	1300	3.4/10.2								
3.9	4000	1600	6.2/18.4								
4	4000	1700	5.8/18.3								
				6.2	4000	2600	8.4/25.1				
				6.3	3000	2000	8/28.3				
				7.6	3000	2400	10.3/30.8				
				8.3	2500	2100	10/37.9				
				9.5	2500	2500	11.1/27				
								12.1	3000	3800	16.8/50.3
								12.3	3000	3900	19.5/59.3
								12.9	3000	4100	27.8/90.2
								14.2	3000	4500	24/71.8
								19	2500	5000	33.4/103.6
								18.4	2 500	4 800	30/77.7
								22.3	2 500	5 900	37.4/101
								36	1 500	5 700	43.2/123



Main functions		Drive control unit	
Communication	Integrated	Modbus serial link CANopen, CANmotion, EtherCAT	
	Operating modes	Homing Manual mode (JOG) Speed control Current control Position control	
	Functions	Auto-tuning, monitoring, stopping, conversion Stop window Rapid entry of position values	
24 V logic inputs		4	
24 V logic outputs		2	
Safety function		"Safe Torque Off" STO	
Architecture		Control via: Motion controller via CANopen CANmotion machine bus	Control via: EtherCAT
Type of servo drive		LXM32ICAN	LXM32IECT

I/O and fieldbus connector module



Drive control unit				LXM32ICAN	LXM32IECT
Description	Connector for bus	Number of I/O	STO function		
Industrial connector module for I/O and fieldbus Positive logic inputs (Source)	2 M12 connectors	4 logic inputs with M8 connectors	Yes –	VW3M9101 VW3M9102	VW3M9106 VW3M9107
		2 logic inputs with M8 connector	Yes –	VW3M9103 VW3M9104	VW3M9108 VW3M9109
	2 M12 connectors	4 logic inputs with M8 connectors	Yes –	VW3M9201 VW3M9202	VW3M9206 VW3M9207
		2 logic inputs with M8 connectors	Yes –	VW3M9203 VW3M9204	VW3M9208 VW3M9209
Terminal connector module for I/O and fieldbus Top part with eight drill holes for cable gland (3): 6 x M12 and 2 x M16	–	4 logic inputs 2 logic outputs	Yes	VW3M9105	VW3M9110

Power supply connector module



Description	Reference
Single-phase power supply module for Lexium 32i	VW3M9001
Three-phase power supply module for Lexium 32i	VW3M9002



Main functions		Servo motor
Application type		High load, With robust adjustment of the movement
Flange size		70, 100
Nominal torque		2.2 to 5.6 Nm
Encoder type		Single turn SinCos: 32,768 points/turn and 131,072 points/turn Multiturn SinCos: 32,768 points/turn x 4096 turns and 131,072 points/turn x 4096 turns
Degree of protection	Casing	IP65
	Shaft end	IP54 or IP 65
Type of servo motor		BMI

Lexium BMI servo motor

Power supply		115 V single-phase supply			
Type of servo motor	Rotor inertia kgcm ² without brake	Nominal operating point			Stall torques M ₀ / M _{max} (1)
		Nominal torque (Nm)	Nominal speed (rpm)	Nominal power (kW)	
BMI702T	1.13	2.2	1700	0.4	2.3 / 6.6
BMI703T	1.67	2.9	1400	0.4	3 / 8.6
BMI1002T	6.28	5.4	1400	0.75	5.4 / 14.5

Power supply		230 V single-phase supply			
Type of servo motor	Rotor inertia kgcm ² without brake	Nominal operating point			Stall torques M ₀ / M _{max} (1)
		Nominal torque (Nm)	Nominal speed (rpm)	Nominal power (kW)	
BMI702T	1.13	1.7	4000	0.7	2.3 / 6.6
BMI703T	1.67	2.2	3200	0.7	3 / 8.6
BMI1002T	6.28	4.4	3000	1.3	5.4 / 14.5

Power supply		208 V three-phase supply			
Type of servo motor	Rotor inertia kgcm ² without brake	Nominal operating point			Stall torques M ₀ / M _{max} (1)
		Nominal torque (Nm)	Nominal speed (rpm)	Nominal power (kW)	
BMI702P	1.13	2.4	1800	0.4	2.5 / 6.8
BMI703P	1.67	2.9	1600	0.45	3 / 8.6
BMI1002P	6.28	5.4	1900	1	5.4 / 14
BMI1003P	9.37	7.2	1500	1	7.2 / 19.2

Power supply		400 V three-phase supply			
Type of servo motor	Rotor inertia kgcm ² without brake	Nominal operating point			Stall torques M ₀ / M _{max} (1)
		Nominal torque (Nm)	Nominal speed (rpm)	Nominal power (kW)	
BMI07021.13	1.13	2.2	3600	0.8	2.5 / 6.8
BMI07031.67	1.67	2.7	3300	0.9	3 / 8.6
BMI10026.28	6.28	5.1	3800	1.9	5.4 / 14
BMI10039.37	9.37	6.8	3000	2	7.2 / 19.2

Power supply		480 V three-phase supply			
Type of servo motor	Rotor inertia kgcm ² without brake	Nominal operating point			Stall torques M ₀ / M _{max} (1)
		Nominal torque (Nm)	Nominal speed (rpm)	Nominal power (kW)	
BMI07021.13	1.13	2	4400	0.9	2.5 / 6.8
BMI07031.67	1.67	2.3	3900	0.9	3 / 8.6
BMI10026.28	6.28	4.1	4700	1.9	5.4 / 14
BMI10039.37	9.37	5.6	3700	2.1	7.2 / 19.2

(1) M₀: Continuous stall torque, M_{max}: Peak stall torque



Integrated Drives		Lexium ILA	Lexium ILE	Lexium ILS	Lexium ILP / ILT
Type of process		Dynamic process and accurate positioning	Automatic format adjustment	Short distance movements with accurate positioning	
Type of technology		Integrated drive with servo motor	Integrated drive with dc brushless motor	Integrated drive with three-phase stepper motor	Integrated drive with two-phase stepper motor
Main characteristics		Highly dynamic Compact Integrated holding brake in option	High holding torque without power Integrated gearbox in option	High torque at low speed	
Dynamic		★★★★	★★	★★★	★★★
Precision and stability		★★★★	★★	★★★★	★★★★
Energy saving		★★★★★	★★★★	★★	★★
Motor inertia		Medium			
Control interface	Control signals	Input/output		Pulse/direction Input/output	Pulse/direction Input/output
	Bus and networks	CANopen, PROFIBUS DP, RS 485 serial link, DeviceNet, EtherCAT, Modbus TCP, Ethernet Powerlink, EtherNet/IP			CANopen, RS485
	Motion bus	-			
Association	Nominal power	150...305W	100...350W	100...350W	150 - 305 W
Drive/motor combinations	Nominal speed	500...9000 rpm	1500...7000 rpm	0...1000 rpm	0...2000 rpm
Drive combinations	Nominal torque	0.26...0.78 Nm	0.18...0.5 Nm	0.45...6 Nm	0.11...5.87 Nm
Drive characteristics	Safety function	"Safe Torque Off"			
Power Supply		24...48 VDC max. 10 A			12...48 VDC or 230 VAC max. 3.4 A
Motor characteristics	Type of sensor (resolution)	Single turn SinCos encoder (16,384 increments/turn) Multiturn SinCos encoder (16,384 increments/turn × 4096 turns)	Absolute value encoder (12...1380 increments/turn)	Index pulse monitoring	
	Motor flange size	57	66	57, 85	36, 42, 57, 85
Accessories		Cable, Connector kits, Installation sets, Commissioning tools, Planetary gearboxes			Cable, Connector kits, Installation sets, Commissioning tools
References		ILA	ILE	ILS	ILP ILT



Lexium ILA with Servo Motor	Nominal Torque (Nm)	Maximum Torque (Nm)	Nominal Speed (Rpm)	Maximum Speed (Rpm)	Nominal Power (W)
ILA1 for CANopen, PROFIBUS DP, RS485					
ILA1●571P	0.26	0.6	5500	7500	150
ILA1●571T	0.26	0.43	7500	11500	200
ILA1●572P	0.45	0.72	4300	6200	200
ILA1●572T	0.41	0.61	5000	7500	215
ILA2 for DeviceNet, EtherCAT, EtherNet/IP, Modbus TCP, Ethernet Powerlink					
ILA2●571P	0.44	0.62	5100	7000	235
ILA2●571T	0.31	0.45	7000	9000	255
ILA2●572P	0.78	1.62	3400	4300	275
ILA2●572T	0.57	0.85	5100	6800	305



Lexium ILE with included spurwheel gearbox.
Ratios: 18:1, 38:1, 54:1, 115:1

Lexium ILE with included worm gearbox with hollow shaft.
Ratios: 24:1, 54:1, 92:1, 115:1

Lexium ILE with Brushless DC Motor	Nominal Torque (Nm)	Detent Torque (Nm)	Nominal Speed (Rpm)	Maximum Speed (Rpm)
ILE1 for CANopen, PROFIBUS DP, RS485				
ILE1●661	0.24	0.08	4800	5000
ILE1●661 spurwheel gearing	up to 11.0	up to 8.0	44	44
ILE1●661 worm gearing	up to 10.6	up to 16.7	44	44
ILE2 for DeviceNet, EtherCAT, EtherNet/IP, Modbus TCP, Ethernet Powerlink				
ILE2●661	0.26	0.08	6000	7000
ILE2●661 spurwheel gearing	up to 12	up to 9.19	44	44
ILE2●661 worm gearing	up to 10.6	up to 16.7	44	44
ILE2●662	0.5	0.106	5000	7000



Lexium ILS with three-phase Stepper Motor	Maximum Torque (Nm)	Holding Torque (Nm)	Speed (Rpm)
ILS1 for CANopen, PROFIBUS DP, RS485, Pulse-Direction, Motion Sequence Mode			
ILS1●571●	0.45	0.51	1000
ILS1●572●	0.9	1.02	600
ILS1●573●	1.5	1.7	450
ILS1●851●	2.0	2.0	450
ILS1●852●	4.0	4.0	200
ILS1●853P	6.0	6.0	120
ILS1●853T	4.5	4.5	300
ILS2 for DeviceNet, EtherCAT, EtherNet/IP, Modbus TCP, Ethernet Powerlink			
ILS2●571●	0.45	0.51	1100
ILS2●572●	0.9	1.02	900
ILS2●573●	1.5	1.7	600
ILS2●851●	2.0	2.0	600
ILS2●852●	4.0	4.0	380
ILS2●853P	6.0	6.0	200
ILS2●853T	4.5	4.5	300

Lexium ILP/ILT Motion Control Lexium integrated drives



Lexium ILP, Lexium ILT with two-phase Stepper Motor	Nominal Torque (Nm)	Holding Torque (Nm)	Maximum Speed (Rpm)
ILP for RS485 with programmable interface			
ILP2R361	0.11	0.11	1800
ILP2R421	0.19	0.19	1500
ILP2R422	0.33	0.33	1500
ILP2R423	0.39	0.39	1500
ILP2R571	0.63	0.63	1500
ILP2R572	0.86	0.86	1500
ILP2R573	1.44	1.44	1500
ILP2R574	1.77	1.77	1500
ILP2R851	2.13	2.13	1000
ILP2R852	3.12	3.12	1000
ILP2R853	5.87	5.87	1000
ILT for Pulse/Direction, CANopen			
ILT2●361	0.11	0.11	1800
ILT2●421	0.19	0.19	1500
ILT2●422	0.33	0.33	1500
ILT2●423	0.39	0.39	1500
ILT2●571	0.63	0.63	1500
ILT2●572	0.86	0.86	1500
ILT2●573	1.44	1.44	1500
ILT2●574	1.77	1.77	1500
ILT2●851	2.13	2.13	1000
ILT2●852	3.12	3.12	1000
ILT2●853	5.87	5.87	1000

3



Assignment of BRS2 2-phase stepper motors and SD21 stepper motor drives

BRS2 2-phase stepper motors	SD21●●U20C	SD21●●U50C
	24...48 V; 3 A	24...48 V; 5 A
BRS236	0.07 Nm	–
BRS242	0.23...0.53 Nm	–
BRS257	0.64...1.69 Nm	0.64...1.69 Nm
BRS285	–	2.96...9.20 Nm



Assignment of BRS3 3-phase stepper motors and SD3 stepper motor drives

BRS3 3-phase stepper motors	SD326●U25	SD328●U25	SD326●U68	SD328●U68
	115 V / 230 V; 2.5 A; including mains filter		115 V / 230 V; 6.8 A; including mains filter and fan	
BRS368	1.7 Nm / 1.5 Nm		–	
BRS397	2.3 Nm / 2.0 Nm		–	
BRS39A	4.5 Nm / 4.0 Nm		–	
BRS39B	6.8 Nm / 6.0 Nm		–	
BRS3AC	–		13.5 Nm / 12.0 Nm	
BRS3AD	–		19.7 Nm / 16.5 Nm	



Assignment of stepper motors, stepper motor drives SD3 15

3-phase stepper motors	SD3 15
	24...48 VDC; max. 10 A
Motors with F winding	
BRS 364F	0.46 Nm / 0.40 Nm
BRS 366F	0.92 Nm / 0.80 Nm
BRS 368F	1.50 Nm / 1.30 Nm
BRS 397F	2.00 Nm / 1.85 Nm
BRS 39AF	4.20 Nm / 3.40 Nm
BRS 39BF	5.55 Nm / 4.80 Nm
Motors with H winding	
BRS 364H	0.51 Nm / 0.45 Nm
BRS 366H	1.02 Nm / 0.90 Nm
BRS 368H	1.70 Nm / 1.50 Nm
BRS 397H	2.26 Nm / 2.00 Nm
BRS 39AH	4.80 Nm / 4.00 Nm
BRS 39BH	6.50 Nm / 5.75 Nm

Lexium Linear Motion Motion Control Linear axes



Product		Lexium PAS B	Lexium PAS S
Axis type		Portal axes	
Movement	Number of directions	1	
	Movement type	Typically horizontal	
	Position of the load	On carriage	
Drive		Toothed belt	Ballscrew
Type of guide		Ball or roller	Ball
Main characteristics		High dynamic response, Long stroke length, High positioning speed	High precision movement (positioning, repeatability, guiding), High feed forces, High rigidity
Dynamic response		★★★★★	★★★
Precision		★★★	★★★★★
Maximum payload		100 kg	100 kg
Maximum driving force		2600 N	4520 N
Maximum speed of movement of the load		8 m/s	1.25 m/s
Maximum working stroke		5500 mm	3000 mm
Repeatability		± 0.05 mm	± 0.02 mm
Options		Choice of guide type: Ball (for applications requiring high forces and torques) or roller (simple, cost-effective solution), Wide range of sensors, Choice of carriage type for adapting to the load, Option to add carriages, Protective metal strip.	Choice of pitch, Protective metal strip, Wide range of sensors, Choice of carriage type for adapting to the load, Option to add carriages, Option to add ballscrew supports for longer axes
Reference		PAS 4●B	PAS 4●S

Multi-axis systems



Product		Lexium MAX H	Lexium MAX S
Axis type		Double portal axes	
Movement	Number of directions	1	
	Movement type	Combination of two parallel axes	
	Position of the load	On two parallel carriages	
Multi-axis system type		PAS 4●B axes + PAS 4●H support axis (driven by the load)	PAS 4●B + PAS 4●B axes (shaft-driven)
Drive		Toothed belt on one axis	Toothed belt on both axes
Type of guide		Ball or roller	Ball or roller
Main characteristics		Long stroke length, High dynamic response, High precision movement (positioning, guiding)	Long stroke length, High precision movement (positioning, guiding), High feed forces
Maximum payload		250 kg	300 kg
Maximum working stroke	On the X-axis	5500 mm	
	On the Y-axis	–	
	On the Z-axis	–	
Options		Choice of guide type: Ball (for applications requiring high forces and torques) or roller (simple, cost-effective solution), Protective metal strip, Anti-corrosion version, Anti-static belt, Wide range of sensors, Several different motor mounting options, Variable distance between the two axes	
Reference		MAX H	MAX S



Lexium TAS	Lexium CAS 4	Lexium CAS 3	Lexium CAS 2
Linear tables	Cantilever axes with mobile structure on profile	Cantilever axes with mobile structure on parallel rods	Telescopic axes
1			
Typically horizontal	Typically vertical		Typically horizontal
On carriage	On the side of the profile or on the 2 end blocks	On the 2 end blocks	On carriage
Ballscrew	Toothed belt	Toothed belt or rack	Toothed belt
Double, ball	Ball or roller	Ball	Ball or roller
High precision movement (positioning, repeatability, guiding), High feed forces, High rigidity, Feed movement without mechanical backlash	Long stroke length, High feed forces, Option to mount the load on the side of the profile or on the end blocks, High rigidity	Compact, Mobile structure with light travel weight	Long stroke length from a compact unit, High rigidity, High dynamic response
★★	★★★★	★★★★	★★★★
★★★★★	★★★	★★★	★★
150 kg	50 kg	18 kg	35 kg
2580 N	2150 N	705 N	1500 N
1 m/s	3 m/s	3 m/s	3 m/s
1500 mm	1200 mm	500 mm	2400 mm
± 0.02 mm	± 0.05 mm	± 0.05 mm	± 0.1 mm
Choice of pitch , Several different motor mounting options	Choice of guide type: Ball (for applications requiring high forces and torques) or roller (simple, cost-effective solution), Protective metal strip, Anti-corrosion version, Wide range of sensors	Anti-corrosion version, Anti-static belt	Choice of guide type: Ball (for applications requiring high forces and torques) or roller (simple, cost-effective solution), Choice of carriage type for adapting to the load
TAS 4	CAS 4	CAS 3	CAS 2

3

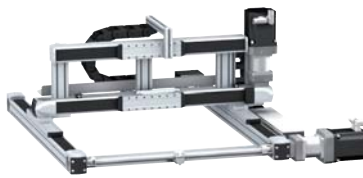

Lexium MAX P	Lexium MAX R2	Lexium MAX R3
Linear positioners	Portal robots	
2		3
Horizontal and vertical: Combination of one X-axis and one Z-axis	Horizontal: Combination of two perpendicular axes X and Y	Horizontal and vertical: Combination of two perpendicular axes X and Y and one Z-axis
On the side or on the end blocks of the Z-axis profile	On the Y-axis carriage	On the side or on the end blocks of the Z-axis profile
MAX S + CAS 4 axes MAX S + CAS 3 axes	MAX S + MAX H axes MAX S + PAS 4●B axes	MAX S + MAX H + CAS 4 axes MAX S + MAX H + CAS 3 axes
Toothed belt on each axis		
Ball or roller		
Dynamic load positioning	Long stroke length on both axes	Long stroke length on three axes
50 kg	130 kg	50 kg
5500 mm		
–	1500 mm	1500 mm
1200 mm	–	1200 mm
Choice of guide type: Ball (for applications requiring high forces and torques) or roller (simple, cost-effective solution), Wide range of sensors Supplied as standard: Protective metal strip , Anti-corrosion version		
MAX P	MAX R●2	MAX R●3

4

Schneider Electric has been leading the way in the motor starter market for more than 80 years. Its TeSys products offer an extensive range of innovative motor protection and power control solutions.

TeSys

Protect your machines and installations with TeSys - a comprehensive range of contactors, circuit-breakers, starters, motor starters and power control components.



4 | Motor control



This document is a selection of the top selling products.

For more information:
<http://www.schneider-electric.com>

Motor control components

Selection guide 4/2 and 4/3

TeSys contactors 4/4 to 4/11
Contactors **TeSys K, D, F**

TeSys protection components

Motor circuit-breakers **TeSys GV2, GV3, GV7** 4/12 to 4/18

Fuse carriers **TeSys DF, LS1, GK1** 4/19 to 4/21

Switch-disconnector-fuses **TeSys GS** 4/22 to 4/24

Thermal overload relays **TeSys K, D** 4/25 and 4/26

Electronic thermal overload relays **TeSys LR9** 4/27

Motor management system **TeSys T** 4/28 and 4/29

Electronic protection relays **TeSys LT3, LT6** 4/30

Switch disconnectors **Mini Vario and Vario** 4/31

TeSys starters

Combination motor starters **TeSys GV2/GV3 + LC** 4/32 and 4/33

Starter-controller **TeSys U** 4/34 and 4/35

Controller **TeSys LUTM** 4/36 and 4/37

Enclosed motor starters 4/38 and 4/39

Complementary products selection guides

Universal enclosures 4/40 and 4/41

Power distribution and connection systems 4/42 and 4/43

Incoming protection and switching 4/44 and 4/45

Short circuit and overload protection 4/46 and 4/47

Indication and metering 4/48 and 4/49

Selection guide

Motor protection and control

⇒ *Applications:*

Motor control circuit designed with separate components

Fuse switch disconnecter	Contactor	Thermal overload relay
--------------------------	-----------	------------------------

ISFT



TeSys K, D, F



TeSys LRK, LRD



Function	Disconnection and short-circuit protection		Motor power control	Overload protection, to be associated with a contactor
Characteristics	Rated insulation voltage (Ui)	440 V DC 690 V AC	690 V to 1000 V AC DC	690 V AC
	Breaking capacity (on 400-415 V)	80 kA (Icn)	–	–
	Rated operational current (on 415 V AC)	100 to 300 A (Ie)	–	–
	Ie max AC3	–	6 to 16 A (TeSys K) 9 to 150 A (TeSys D) 185 to 800 A (TeSys F)	–
	Ie max AC1	–	12 to 20 A (TeSys K) 20 to 200 A (TeSys D) 275 to 1400 A (TeSys F)	–
	Motor current In	–	–	0.1 to 16 A
Standards and certifications	IEC	IEC, UL, CSA	IEC, UL, CSA	
Pages	More information: www.schneider-electric.com	4/4 to 4/11	4/25 to 4/26	

4

⇒ *Applications:*

Motor control circuit designed with multifunction components

Thermal magnetic circuit-breakers			ON-OFF Motor controller	Normal-Reverse Motor controller
TeSys GV2	TeSys GV3	TeSys GV7	TeSys U	TeSys U
				
Disconnection, short-circuit and overload protection. Manual power control, automatic when associated with a contactor			Full protection and ON-OFF control of motor circuit. Communication ability	Full protection Normal, Reverse control of motor circuit. Communication ability
690 V AC				
10 to 100 kA (Icu)	50 to 100 kA (Icu)	35 to 70 kA (Icu)	50 kA (Icu)	
0.1 to 32 A (Ith)	9 to 65 A (Ith)	12 to 220 A (Ith)	12 to 32 A (400 V AC)	
-				
-				
-				
IEC for certain models IEC, UL, CSA		IEC		
4/12 to 4/13	4/14	4/16	4/34 to 4/35	



Connections

screw clamp terminals

Rated operational current	le max AC-3 (Ue ≤ 440 V) le AC-1 (θ ≤ 40° C)	6 A	9 A	12 A
Rated operational power	220/240 V	1.5 kW	2.2 kW	3 kW
in category AC3	380/400 V...415/440 V 660/690 V...500 V	2.2 kW 3 kW	4 kW 4 kW	5.5 kW 4 kW
Contactor type (1)*	~ ---	LC1K06** LP1K06** or LP4K06**	LC1K09** LP1K09 or LP4K09**	LC1K12** LP1K12 or LP4K12**
Reversing contactor type *	~	LC2K06	LC2K09	LC2K12
with mechanical interlock	---	LP2K06 or LP5K06	LP2K09 or LP5K09	LP2K12 or LP5K12

Spring terminals

Add the figure 3 before the voltage code. Example: **LC1K0610**** becomes **LC1K06103****

Faston connectors, 1 x 6.35 or 2 x 2.8

Add the figure 7 before the voltage code. Example: **LC1K0610**** becomes **LC1K06107****

Solder pins for printed circuit boards

Add the figure 5 before the voltage code. Example: **LC1K0610**** becomes **LC1K06105****

(1) Basic reference, to be completed by adding **01** for NC auxiliary contact, or **10** for NO auxiliary contact.

* Basic reference to be completed by adding the coil voltage code

Standard control circuit voltages

~ supply

Contactors LC1K (0.8...1.15 Uc) (0.85...1.1 Uc)

Volts	12	20	24	36	42	48	110	115	120	127	200/208	220/230	230	230/240
50/60 Hz	J7	Z7	B7	C7	D7	E7	F7	FE7	G7	FC7	L7	M7	P7	U7
Volts	256	277	380/400	400	400/415	440	480	500	575	600	660/690			
50/60 Hz	W7	UE7	Q7	V7	N7	R7	T7	S7	SC7	X7	Y7			

Example of complete reference: **LC1K0910P7**

--- supply

Contactors LP1K (0.8...1.15 Uc)

Volts	12	20	24	36	48	60	72	100	110	125	155	174	200	220	230	240	250
Code	JD	ZD	BD	CD	ED	ND	SD	KD	FD	GD	PD	QD	LD	MD	MPD	MUD	UD

Coil with integral suppression device available, add **3** to the code required. Example: **JD3**

Low consumption

Contactors LP4K (0.7...1.30 Uc), coil suppression as standard

Volts	12	20	24	48	72	110	120
Code	JW3	ZW3	BW3	EW3	SW3	FW3	GW3

Example of complete reference: **LC1K0910BD**



Auxiliary contact blocks

instantaneous, screw clamp connections

	■ for LC1, LP1K, LP4			■ for LC1, LP1K				
Composition	2NO	- 2NC	1NO 1NC	4NO	3NO 1NC	2NC 2NC	1NO 3NC	- 4NC
Reference	LA1KN20	LA1KN02	LA1KN11	LA1KN40	LA1KN31	LA1KN22	LA1KN13	LA1KN04

electronic time delay

Relay outputs, with common point changeover contact, \sim or \equiv 24...48, 2 A maximum

Control voltage 0.85...1.1 U_c

Maximum switching capacity 250 VA or 150 W

Operating temperature -10...+60°C

Reset time: 1.5 s during the time delay period, 0.5 s after time delay period

Type	On-delay							
Timing range	1...30 s							
Composition	1							
Voltage	\sim or \equiv 24...48 V				\sim 110...240			
Reference	LA2KT2E				LA2KT2U			

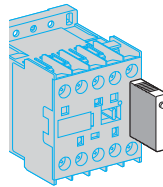

Suppressor modules

For LC1, LP1-K

Type	Varistor (\sim and \equiv)				Diode (\equiv) + Zener		RC (\sim)
Voltage	12...24 V	32...48 V	50...129 V	130...250 V	12...24 V	32...48 V	220...250 V
Reference	LA4KE1B	LA4KE1E	LA4KE1FC	LA4KE1UG	LA4KC1B	LA4KC1E	LA4KA1U



Connections

screw clamp terminals or connectors

Rated operational voltage		690 V					
Rated operational current	le max AC-3 (Ue ≤ 440 V)	9 A	12 A	18 A	25 A	32 A	38 A
	le AC-1 (θ ≤ 60° C)	25 A		32 A	40 A	50 A	
Rated operational power in category AC3	220/240 V	2.2 kW	3 kW	4 kW	5.5 kW	7.5 kW	9 kW
	380/400 V	4 kW	5.5 kW	7.5 kW	11 kW	15 kW	18.5 kW
	415/440 V	4 kW	5.5 kW	9 kW	11 kW	15 kW	18.5 kW
	500 V	5.5 kW	7.5 kW	10 kW	15 kW	18.5 kW	18.5 kW
	660/690 V	5.5 kW	7.5 kW	10 kW	15 kW	18.5 kW	18.5 kW
1000 V	–	–	–	–	–	–	
Contactor type *		LC1D09	LC1D12	LC1D18	LC1D25	LC1D32	LC1D38
Reversing contactor type * with mechanical interlock		LC2D09	LC2D12	LC2D18	LC2D25	LC2D32	LC2D38

spring terminals (1)

Add the figure 3 before the voltage code. Example: LC1D09P7 becomes LC1-093P7

lug-clamps (2)

Add the figure 6 before the voltage code. Example: LC1D09P7 becomes LC1-096P7

Faston connectors (3) 2 x 6.35 (power) and 1 x 6.35 (control) up to D12 only

Add the figure 9 before the voltage code. Example: LC1D09P7 becomes LC1-099P7

* Basic reference to be completed by adding the coil voltage code



(1)



(2)



(3)

Standard control circuit voltages

~ supply

Volts	24	42	48	110	115	220	230	240	380	400	415	440	500
-------	----	----	----	-----	-----	-----	-----	-----	-----	-----	-----	-----	-----

Contactors LC1D09...D150 (coils D115 and D150 with integral suppression device fitted as standard)

50/60 Hz	B7	D7	E7	F7	FE7	M7	P7	U7	Q7	V7	N7	R7	S7
----------	-----------	-----------	-----------	-----------	------------	-----------	-----------	-----------	-----------	-----------	-----------	-----------	-----------

Contactors LC1D80...D115

50 Hz	B5	D5	E5	F5	FE5	M5	P5	U5	Q5	V5	N5	R5	S5
-------	-----------	-----------	-----------	-----------	------------	-----------	-----------	-----------	-----------	-----------	-----------	-----------	-----------

60 Hz	B6	-	E6	F6	-	M6	-	U6	Q6	-	-	R6	-
-------	-----------	---	-----------	-----------	---	-----------	---	-----------	-----------	---	---	-----------	---

⋮ supply

Volts	12	24	36	48	60	72	110	125	220	250	440
-------	----	----	----	----	----	----	-----	-----	-----	-----	-----

Contactors LC1D09...D65A (coils with integral suppression device fitted as standard)

U 0.75...1.25 Uc	JD	BD	CD	ED	ND	SD	FD	GD	MD	UD	RD
------------------	-----------	-----------	-----------	-----------	-----------	-----------	-----------	-----------	-----------	-----------	-----------

Contactors LC1D80...D95

U 0.85...1.1 Uc	JD	BD	CD	ED	ND	SD	FD	GD	MD	UD	RD
-----------------	-----------	-----------	-----------	-----------	-----------	-----------	-----------	-----------	-----------	-----------	-----------

U 0.75...1.2 Uc	JW	BW	CW	EW	-	SW	FW	-	MW	-	-
-----------------	-----------	-----------	-----------	-----------	---	-----------	-----------	---	-----------	---	---

Contactors LC1D115 and D150 (coils with integral suppression device fitted as standard)

U 0.75...1.2 Uc	-	BD	-	ED	ND	SD	FD	GD	MD	UD	RD
-----------------	---	-----------	---	-----------	-----------	-----------	-----------	-----------	-----------	-----------	-----------

Low consumption

Contactors LC1D09...D38 (coils with integral suppression device fitted as standard)

Volts ⋮	5	12	20	24	48	110	120	250
---------	---	----	----	----	----	-----	-----	-----

U 0.7...1.25 Uc	AL	JL	ZL	BL	EL	FL	ML	UL
-----------------	-----------	-----------	-----------	-----------	-----------	-----------	-----------	-----------

Example of complete reference: LC1D09P7



690 V			1000 V on ~ supply, 690 V on ≡ supply			
40 A	50 A	65 A	80 A	95 A	115 A	150 A
60 A	80 A	80 A	125 A		200 A	
11 kW	15 kW	18.5 kW	22 kW	25 kW	30 kW	40 kW
18.5 kW	22 kW	30 kW	37 kW	45 kW	55 kW	75 kW
22 kW	25 kW	30 kW	45 kW	45 kW	59 kW	80 kW
22 kW	30 kW	37 kW	55 kW	55 kW	75 kW	90 kW
30 kW	33 kW	37 kW	45 kW	45 kW	80 kW	100 kW
–	–	–	45 kW	45 kW	75 kW	90 kW
LC1D40A	LC1D50A	LC1D65A	LC1D80	LC1D95	LC1D115	LC1D150
LC2D40A	LC2D50A	LC2D65A	LC2D80	LC2D95	LC2D115	LC2D150

Mounting accessories for 3-pole reversing contactors

2 identical contactors with screw clamp terminals or connectors, horizontally mounted

Mechanical interlock	Set of connections	Mechanical interlock
with an electrical interlocking kit for the contactors LC1-D09...D38	LAD-9R1V	included
with integral electrical interlocking LC1-D80 and D95 (~) LC1-D80 and D95 (≡) LC1-D115 and D150	LA9D8069 LA9D8069 LA9D11569	LA9D4002 LA9D8002 LA9D11502
without electrical interlocking LC1-D09...D38 LC1-D40A...D65A LC1-D80 and D95 (~) LC1-D80 and D95 (≡)	LA99R1 LAD9R3 LA9D8069 LA9D8069	included included LA9D50978 LA9D80978



Mechanical latch blocks

Clip-on front mounting, manual or electrical unlatching control

For use on contactor	Reference	Standard control circuit voltages
LC1D09...D65A ~ or ≡, LC1DT20...DT80 ~ or ≡	LAD6K10•	B E F M Q
LC1D80...D150 3P ~, LC1D80 and D115 3P ~, LC1D115 4P ≡	LA6DK20•	B E F M Q



Contact type			Instantaneous, connection by screw terminals	
Block mounting			Front mounting	Side mounting
References	Contact	1 NO	LADN10	–
		1 NC	LADN01	–
		1 NO + 1 NC	LADN11	LAD8N11
		2 NO	LADN20	LAD8N20
		2 NC	LADN02	LAD8N02
		2 NO + 2 NC	LADN22	–
		1 NO + 3 NC	LADN13	–
		3 NO + 1 NC	LADN31	–
		4 NO	LADN40	–
	4 NC	LADN04	–	



Contact type		Time delay, connection by screw terminals		
Block mounting		Front mounting		
Time delay ¹²		0.1...3 s	0.1...30 s	10...180 s
References	On-delay	LADT0	LADT2	LADT4
	Off-delay	LADR0	LADR2	LADR4

Maximum number of auxiliary contacts that can be fitted

Type	Number of poles and size		Instantaneous						Time delay
			Side mounting			Front mounting			Front mounting
			on left side	on right side		1 contact	2 contacts	4 contacts	
AC	3P	LC1D09...D38	1	–	and	–	1	or 1	or 1
		LC1D40A...D65A	1	or 1	and	–	1	or 1	or 1
		LC1D80...95 (50/60 Hz)	1	1	or	2	and 1	or 1	or 1
		LC1D80...95 (50 or 60 Hz)	1	1	and	2	and 1	or 1	or 1
		LC1D115 and D150	1	–	and	–	1	or 1	or 1
	4P	LC1DT20...DT40	1	–	and	–	1	or 1	or 1
		LC1DT60A...D80A	1	or 1	and	–	1	or 1	or 1
		LC1D115	1	1	and	1	or 1	or 1	or 1
DC	3P	LC1D09...D38	–	–	and	–	1	or 1	or 1
		LC1D40A...D65A	1	or 1	and	–	1	or 1	or 1
		LC1D80 and 95	–	–	and	1	or 1	or 1	or 1
		LC1D115 and D150	1	–	and	–	1	or 1	or 1
	4P	LC1DT20...DT40	–	–	and	–	1	or 1	or 1
			LC1DT60A...D80A	–	–	and	–	1	or 1
		LC1D115	1	1	and	–	and 1	or 1	or 1
DC low consumption	3P	LC1D09...D38	–	–	and	–	1	–	–
	4P	LC1DT20...DT40	–	–	and	–	1	–	–

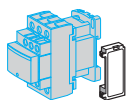

Type of module			RC circuits (Resistor-Capacitor)		
Mounting			Side clip-on	Front clip-on	Screw fixing
For use with contactor			D09...D38(3P) DT20...DT40(4P)	D40A...D65A(3P) DT60A...DT80A(4P)	D80...D150(3P) D40...D115(4P)
References	Voltage	24...48 V AC	LAD4RCE	LAD4RC3E	LA4DA2E
		50...127 V AC	LAD4RCG	LAD4RC3G	LA4DA2G
		110...240 V AC	LAD4RCU	LAD4RC3U	LA4DA2U
		380...415 V AC	–	LAD4RC3N	LA4DA2N

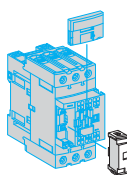

Type of module			Varistors (peak limiting)		
Mounting			Side clip-on	Front clip-on	Screw fixing
For use with contactor			D09...D38(3P) DT20...DT40(4P)	D40A...D65A(3P) DT60A...DT80A(4P)	D80...D150(3P) D40...D115(4P)
References	Voltage	24...48 V AC	LAD4VE	LAD4V3E	LA4DE2E
		50...127 V AC	LAD4VG	LAD4V3G	LA4DE2G
		110...240 V AC	LAD4VU	LAD4V3U	LA4DE2U
		24...48 V DC	–	–	LAD4DE3E (AC and DC)
		50...127 V DC	–	–	LAD4DE3G (AC and DC)
		110...240 V DC	–	–	LAD4DE3U (AC and DC)

4

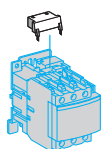

Type of module			Flywheel diodes		
Mounting			Side clip-on	Front clip-on	Screw fixing
For use with contactor			D09...D38(3P) DT20...DT40(4P)	D40A...D65A(3P) DT60A...DT80A(4P)	D80...D150(3P) D40...D115(4P)
References	Voltage	24...250 V DC	LAD4DDL	LAD4D3U	LAD4DC3U

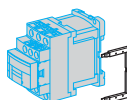

Type of module			Bidirectional peak limiting diode		
Mounting			Side clip-on	Front clip-on	Screw fixing
For use with contactor			D09...D38(3P) DT20...DT40(4P)	D40A...D65A(3P) DT60A...DT80A(4P)	D80...D150(3P) D40...D115(4P)
References	Voltage	24 V AC	LAD4TB	LAD4T3B	LA4DB2B
		24 V DC	LAD4TBDL	LAD4T3B	LA4DB2S
		72 V AC	LAD4TS	LAD4T3S	LA4DB3B
		72 V DC	LAD4TSDL	LAD4T3S	LA4DB3S
		125 V DC	LAD4TGDL	LAD4T3G (AC and DC)	–
		250 V DC	LAD4TUDL	LAD4T3U (AC and DC)	–
		600 V DC	LAD4TXDL	LAD4T3R (AC and DC)	–



Rated operational current	le max AC-3 (Ue ≤ 440 V)	185 A	225 A	265 A	330 A
	le AC-1 (θ ≤ 40° C)	275 A	315 V	350 A	400 A
Rated operational voltage		1 000 V	1 000 V	1 000 V	1 000 V
Number of poles		3 or 4	3 or 4	3 or 4	3 or 4
Rated operational power	220/240 V	55 kW	63 kW	75 kW	100 kW
in category AC3	380/400 V	90 kW	110 kW	132 kW	160 kW
	415 V	100 kW	110 kW	140 kW	180 kW
	440 V	100 kW	110 kW	140 kW	200 kW
	500 V	110 kW	129 kW	160 kW	200 kW
	660/690 V	110 kW	129 kW	160 kW	220 kW
	1000 V	100 kW	100 kW	147 kW	160 kW
Contactor type*		LC1F185	LC1F225	LC1F265	LC1F330
Reversing contactor type*		LC2F185	LC2F225	LC2F265	

* Basic reference to be completed by adding the coil voltage code

Standard control circuit voltages

~ supply

Volts	24	48	110	115	120	208	220	230	240	380	400	415	440
Contactors LC1F115...F225 (0.85...1.1 Uc)													
50 Hz (coil LX1)	B5	E5	F5	FE5	-	-	M5	P5	U5	Q5	V5	N5	-
60 Hz (coil LX1)	-	E6	F6	-	G6	L6	M6	-	U6	Q6	-	-	R6U7
40...400 Hz (coil LX9)	-	E7	F7	FE7	G7	L7	M7	P7	U7	Q7	V7	N7	R7
Contactors LC1F265...F330U7													
40...400 Hz (coil LX1)	B7	E7	F7	FE7	G7	L7	M7	P7	U7	Q7	V7	N7	R7
Contactors LC1F400...F630U7													
40...400 Hz (coil LX1)	-	E7	F7	FE7	G7 (1)	L7	M7	P7	U7	Q7	V7	N7	R7
Contactors LC1F780U7													
40...400 Hz (coil LX1)	-	-	F7	FE7	F7	L7	M7	P7	U7	Q7	V7	N7	R7
Contactors LC1F800U7													
40...400 Hz (coil LX1)	-	-	FE7	FE7	FE7	-	P7	P7	P7	V7	V7	V7	V7Y7

--- supply

Volts	24	48	110	125	220	230	250	400	440
Contactors LC1F115...F330 (0.85...1.1 Uc)									
(coil LX4-F)	BD	ED	FD	GD	MD	MD	UD	-	RD
Contactors LC1F400...F630 (0.85...1.1 Uc)									
(coil LX4-F)	-	ED	FD	GD	MD	-	UD	-	RD
Contactors LC1F780 (0.85...1.1 Uc)									
(coil LX4-F)	-	-	FD	GD	MD	-	UD	-	RD
Contactors LC1F800 (0.85...1.1 Uc)									
(coil LX4-F)	-	-	FW	FW	MW	MW	-	QW	-
Contactors LC1F1250									
(coil LX4F)	-	ED	FD	-	MD	-	UD	-	-
Contactors LC1F1400									
(coil LX4F)	-	-	FD	GD	MD	-	UD	-	RD

Example: For a 630 A contactor with a 110 V ~ coil, order **LC1F630F7**

(1) F7 for LC1-F630



	400 A	500 A	630 A	780 A	800 A	-	-
	500 A	700 A	1 000 A	1 600 A	1 000 A	1260	1400
	1 000 V	1 000 V	1 000 V	1 000 V	1 000 V	1000	1000
	2, 3 or 4	2, 3 or 4	2, 3 or 4	3 or 4	3	3	3
	110 kW	147 kW	200 kW	220 kW	250 kW	Sans objets	Sans objets
	200 kW	250 kW	335 kW	400 kW	450 kW	en AC1	en AC1
	220 kW	280 kW	375 kW	425 kW	450 kW	-	-
	250 kW	295 kW	400 kW	425 kW	450 kW	-	-
	257 kW	355 kW	400 kW	450 kW	450 kW	-	-
	280 kW	335 kW	450 kW	475 kW	475 kW	-	-
	185 kW	335 kW	450 kW	450 kW	450 kW	-	-
	LC1F400	LC1F500	LC1F630	LC1F780	LC1F800	LC1F1250	LC1F1400
	For customer assembly					-	-

4



Auxiliary contact blocks

instantaneous				dust & damp protected contacts				time delay 1 NO + 1 NC		
Composition	Reference	Composition	Reference	Composition	Reference	Composition	Reference	Type	Range	Reference
NO NC		NO NC		NO NC		NO NC				
1 -	LADN10	1 1	LADN11	2 2	LADN22	2 - - -	LA1DX20	On-delay	0.1...3 s	LADT0
- 1	LADN01	2 -	LADN20	1 3	LADN13	2 2 - -	LA1DY20		0.1...30 s	LADT2
		- 2	LADN02	4 -	LADN40	2 - 2 -	LA1DZ40		10...180 s	LADT4
				- 4	LADN04	2 - 1 1	LA1DZ31		1...30 s	LADS2
				3 1	LADN31			Off-delay	0.1...3 s	LADR0
				2 2	LADC22				0.1...30 s	LADR2
									10...180 s	LADR4

Mounting accessories for 3-pole reversing contactors for motor control

2 identical contactors, horizontally mounted

Mechanical interlock with an electrical interlocking kit for the contactors

Contactor type	Set of connections	Mechanical interlock
LC1F115	LA9FF976	LA9FF970
LC1F150	LA9F15076	LA9FF970
LC1F185	LA9FG976	LA9FG970
LC1F225	LA9F22576	LA9FG970
LC1F265	LA9FH976	LA9FJ970
LC1F330	LA9FJ976	LA9FJ970
LC1F400	LA9FJ976	LA9FJ970
LC1F500	LA9FK976	LA9FJ970
LC1F630 or LC1F800	LA9FL976	LA9FL970
LCIF1250	-	-
LCIF1400	-	-



Thermal-magnetic circuit-breakers GV2-ME and GV2-P for connection by screw clamp terminals

GV2-ME with pushbutton control, GV2-P control by rotary knob

Standard power ratings of 3-phase motors 50/60 Hz in category AC-3

400/415 V						500 V			690 V			Setting range of thermal trips	Magnetic tripping current	Reference
P	I _{cu}	I _{cs} (1)	P	I _{cu}	I _{cs} (1)	P	I _{cu}	I _{cs} (1)						
kW	kA		kW	kA		kW	kA		A	A (d ± 20%)				
-	-	-	-	-	-	-	-	-	0.1...0.16	1.5	GV2ME01	GV2P01		
0.06	★	★	-	-	-	-	-	-	0.16...0.25	2.4	GV2ME02	GV2P02		
0.09	★	★	-	-	-	-	-	-	0.25...0.40	5	GV2ME03	GV2P03		
0.12	★	★	-	-	-	0.37	★	★	0.40...0.63	8	GV2ME04	GV2P04		
0.18	★	★	-	-	-	-	-	-	0.40...0.63	8	GV2ME04	GV2P04		
0.25	★	★	-	-	-	0.55	★	★-	0.63...1	13	GV2ME05	GV2P05		
0.37	★	★	0.37	★	★	-	-	-	1...1.6	22.5	GV2ME06	GV2P06		
0.55	★	★	0.55	★	★	0.75	★	★	1...1.6	22.5	GV2ME06	GV2P06		
-	-	-	0.75	★	★	1.1	★	★	1...1.6	22.5	GV2ME06	GV2P06		
0.75	★	★	1.1	★	★	1.5	3	75	1.6...2.5	33.5	GV2ME07			
0.75	★	★	1.1	★	★	1.5	8	100	1.6...2.5	33.5		GV2P07		
1.1	★	★	1.5	★	★	2.2	3	75	2.5...4	51	GV2ME08			
1.1	★	★	1.5	★	★	2.2	8	100	2.5...4	51		GV2P08		
1.5	★	★	2.2	★	★	3	3	75	2.5...4	51	GV2ME08			
1.5	★	★	2.2	★	★	3	3	100	2.5...4	51		GV2P08		
2.2	★	★	3	50	100	4	3	75	4...6.3	78	GV2ME10			
2.2	★	★	3	★	★	4	6	100	4...6.3	78		GV2P10		
3	★	★	4	10	100	5.5	3	75	6...10	138	GV2ME14			
3	★	★	4	50	100	5.5	6	100	6...10	138		GV2P14		
4	★	★	5.5	10	100	7.5	3	75	6...10	138	GV2ME14			
4	★	★	5.5	50	100	7.5	6	100	6...10	138		GV2P14		
5.5	15	50	7.5	6	75	9	3	75	9...14	170	GV2ME16			
5.5	★	★	7.5	42	75	9	6	100	9...14	170		GV2P16		
-	-	-	-	-	-	11	3	75	9...14	170	GV2ME16			
-	-	-	-	-	-	11	6	100	9...14	170		GV2P16		
7.5	15	50	9	6	75	15	3	75	13...18	223	GV2ME20			
7.5	50	50	9	10	75	15	4	100	13...18	223		GV2P20		
9	15	40	11	4	75	18.5	3	75	17...23	327	GV2ME21			
9	50	50	11	10	75	18.5	4	100	17...23	327		GV2P21		
11	15	40	15	4	75	-	-	-	20...25	327	GV2ME22 (2)			
11	50	50	15	10	75	-	-	-	20...25	327		GV2P22		
15	10	50	18.5	4	75	22	3	75	24...32	416	GV2ME32			
15	50	50	18.5	10	75	22	4	100	24...32	416		GV2P32		

H > 100 kA

(1) as % of I_{cu}

(2) combined with a recommended contactor

Thermal-magnetic circuit-breakers GV2-ME for connection by spring terminals

Add the figure 3 to the end of the reference. Example: GV2ME22 becomes GV2ME223

Thermal-magnetic circuit-breakers GV2-ME for connection by ring terminals

Add the figure 6 to the end of the reference. Example: GV2ME32 becomes GV2ME326

TeSys extended rotary handles

These handles are suitable for the following products	GV2 -P and GV2 - L	GV3-P and GV3 - L	TeSys U
IP54 kit black handle	GV2APN01	GV3APN01	LU9APN21
IP54 kit red handle and yellow front	GV2APN02	GV3APN02	LU9APN22
IP65 kit red handle and yellow front	GV2APN04	GV3APN04	LU9APN24

Common accessories GV2 / GV3, see page 4/15



Magnetic circuit-breakers GV2-LE and GV2-L for connection by screw clamp terminals

GV2-LE control by rocker lever, GV2-L control by rotary knob

Standard power ratings of 3-phase motors 50/60 Hz in category AC-3									Magnetic	Tripping	Use in association	Reference
400/415 V			500 V			690 V			protection	current	with thermal	
P	I _{cu}	I _{cs} (1)	P	I _{cu}	I _{cs} (1)	P	I _{cu}	I _{cs} (1)	rating	d ± 20%	overload relay	
kW	kA		kW	kA		kW	kA		A	A		
0.06	★	★	-	-	-	-	-	-	0.4	5	LR2K0302	GV2LE03
0.09	★	★	-	-	-	-	-	-	0.4	5	LR2K0304 or LRD03	GV2LE03 GV2L03
0.12	★	★	-	-	-	0.37	★	★	0.63	8	LR2K0304 or LRD04	GV2LE04 GV2L04
0.18	★	★	-	-	-	-	-	-	0.63	8	LR2K0305 or LRD04	GV2LE04 GV2L04
-	-	-	-	-	-	0.55	★	★	1	13	LR2K0305 or LRD05	GV2LE05 GV2L05
0.25	★	★	-	-	-	-	-	-	1	13	LR2K0306 or LRD05	GV2LE05 GV2L05
-	-	-	-	-	-	0.75	★	★	1	13	LR2K0306 or LRD06	GV2LE05 GV2L05
0.37	★	★	0.37	★	★	-	-	-	1	13	LR2K0306 or LRD05	GV2LE05 GV2L05
0.55	★	★	0.55	★	★	1.1	★	★	1.6	22.5	LR2K0307 or LRD06	GV2LE06 GV2L06
-	-	-	0.75	★	★	-	-	-	1.6	22.5	LR2K0307 or LRD06	GV2LE06 GV2L06
0.75	★	★	1.1	★	★	1.5	3	75	2.5	33.5	LR2K0308	GV2LE07
0.75	★	★	1.1	★	★	1.5	4	100	2.5	33.5	LRD07	GV2L07
1.1	★	★	-	-	-	-	-	-	2.5	33.5	LR2K0308 or LRD08	GV2LE08 GV2L08
1.5	★	★	1.5	★	★	3	3	75	4	51	LR2K0310	GV2LE08
1.5	★	★	1.5	★	★	3	4	100	4	51	LRD08	GV2L08
-	-	-	2.2	★	★	-	-	-	4	51	LR2K0312 or LRD08	GV2LE08 GV2L08
2.2	★	★	3	50	100	4	3	75	6.3	78	LR2K0312	GV2LE10
2.2	★	★	3	★	★	4	4	100	6.3	78	LRD10	GV2L10
3	★	★	4	10	100	5.5	3	75	10	138	LR2K0314	GV2LE14
3	★	★	4	10	100	5.5	4	100	10	138	LRD12	GV2L14
4	★	★	5.5	10	100	-	-	-	10	138	LR2K0316 or LRD14	GV2LE14 GV2L14
-	-	-	-	-	-	7.5	3	75	10	138	LRD14	GV2LE14
-	-	-	-	-	-	7.5	4	100	10	138	LRD14	GV2L14
-	-	-	-	-	-	9	3	75	14	170	LRD16	GV2LE16
-	-	-	-	-	-	9	4	100	14	170	LRD16	GV2L16
5.5	15	50	7.5	6	75	11	3	75	14	170	LR2K0321	GV2LE16
5.5	50	50	7.5	10	75	11	4	100	14	170	LRD16	GV2L16
7.5	15	50	9	6	75	15	3	75	18	223	LRD21	GV2LE20
7.5	50	50	9	10	75	15	4	100	18	223	LRD21	GV2L20
9	15	40	11	4	75	18.5	3	75	25	327	LRD22	GV2LE22
9	50	50	11	10	75	18.5	4	100	25	327	LRD22	GV2L22
11	15	40	15	4	75	-	-	-	25	327	LRD22	GV2LE22
11	50	50	15	10	75	-	-	-	25	327	LRD22	GV2L22
15	10	50	18.5	4	75	22	3	75	32	416	LRD32	GV2LE32
15	50	50	18.5	10	75	22	4	100	32	416	LRD32	GV2L32

H > 100 kA

(1) as % of I_{cu}

Common accessories GV2 / GV3, see page 4/15



Thermal-magnetic circuit-breakers GV3-P for connection by EverLink terminal blocks (2)

Control by rotary knob

Standard power ratings of 3-phase motors 50/60 Hz in category AC-3									Setting range	Reference
400/415 V			500 V			660/690 V			of thermal	
P	Icu	Ics (1)	P	Icu	Ics (1)	P	Icu	Ics (1)	trips	
kW	kA		kW	kA		kW	kA		A	
5.5	100	50	7.5	12	50	11	6	50	9...13	GV3P13
7.5	100	50	11	12	50	15	6	50	12...18	GV3P18
11	100	50	15	12	50	18.5	6	50	17...25	GV3P25
15	100	50	18.5	12	50	22	6	50	23...32	GV3P32
18.5	50	50	22	10	50	30	5	60	30...40	GV3P40
22	50	50	30	10	50	37	5	60	37...50	GV3P50
30	50	50	37	10	50	45	5	60	48...65	GV3P65

(1) as % of Icu

Thermal-magnetic circuit-breakers GV3-P for connection by ring terminals

Add the figure 6 to the end of the reference. Example: GV3-P13 becomes GV3-P136

Thermal-magnetic circuit-breakers GV3-P for connection by only 1 EverLink terminal block

Add the figure 1 to the end of the reference. Example: GV3P65 becomes GV3P651



Magnetic 11...30 kW
with EverLink terminal blocks

Magnetic circuit-breakers GV3-L for connection by EverLink terminal blocks (2)

Control by rotary knob

Standard power ratings of 3-phase motors 50/60 Hz in category AC-3									Associated equipment	Circuit-breaker	
400/415 V			500 V			690 V			Thermal	Short-circuit	
P	Icu	Ics	P	Icu	Ics	P	Icu	Ics	overload	protection	Reference
kW	kA		kW	kA		kW	kA		relay	Rating A	
11	100	50	15	12	50	18.5	6	50	LRD325	25	GV3L25
15	100	50	18.5	12	50	22	6	50	LRD332	32	GV3L32
18.5	50	50	22	10	50	30	5	60	LRD340	40	GV3L40
22	50	50	30	10	50	45	5	60	LRD350	50	GV3L50
30	50	50	37	10	50	45	5	60	LRD365	65	GV3L65

Magnetic circuit-breakers GV3-L for connection by ring terminals

Add the figure 6 to the end of the reference. Example: GV3-L25 becomes GV3-L256

Magnetic circuit-breakers GV3-L for connection by only 1 EverLink terminal block

Add the figure 1 to the end of the reference. Example: GV3L65 becomes GV3L651

(2) 4 mm BTR screw

Add-on blocks and accessories (3)

Add-on blocks (front)	Fault signalling contact + instantaneous auxiliary contact	
Contact type	NO (fault) + NC	NO (fault) + NO
References (4)	GV-AED011	GV-AED101

Accessories	Cover			Busbars		
Type	IP20 for lug type terminals	IP20 for lug type terminals when used with contactor	"Wide spacing" UL 508 type E	Set of 3-pole 115 A busbars for 2 circuit-breakers	Set of 3-pole 115 A busbars for 3 circuit-breakers	"S" form for side by side mounted circuit-breaker/contactors
References	LAD96570	LAD96575	GV3G66	GV3G264	GV3G364	GV3S

(3) Common add-on blocks and accessories GV2 / GV3, see page 4/15

(4) For spring terminal version add 3 to the end of the reference. Example: GV-AED011 becomes GV-AED0113



(TeSys rotating handles)

Combination block GV2

For mounting on	LC1-K or LP1-K	LC1-D09...D38	LAD-31 and LC1-D09...D38
	GV2AF01	GV2AF3	GV2AF4

Sets of 3-pole busbars GV2

63 A	Pitch	45 mm	54 mm	72 mm
Number of tap-offs	2	GV2G245	GV2G254	GV2G272
	3	GV2G345	GV2G354	
	4	GV2G445	GV2G454	GV2G472
	5		GV2G554	

Protective end cover GV2

For unused busbar outlets	GV1G10
---------------------------	---------------

Terminal blocks GV2

For supply to one or more GV2-G busbar sets	Connection from the top	Can be fitted with current limiter gv1-I3 (gv2-me and gv2-p)
	GV1G09	GV1G05

Padlockable external operator for GV2 and GV3 (150 to 290 mm)

Padlocking	In "On" and "Off" position	In "Off" position	
Handle	Black	Red	
Legend plate	Blue	Yellow	
IP 54	For GV2-ME/P/L	GV2AP01	GV2AP02
	For GV2-LE	GV2AP03	–
	For GV3-P/L	GV3AP01	GV3AP02

TeSys rotating handles for

	GV2-P	GV3-P
IP54 kit black handle	GV2APN01	GV3APN01
IP54 kit red/yellow handle	GV2APN02	GV3APN02
IP65 kit red/yellow handle	GV2APN04	GV3APN04

Contact blocks common to GV2 / GV3

	NO + NC	NO + NC	NO + NO	(fault) + NC	(fault) + NO	CO common
Instantaneous auxiliary contacts						point
Mounting front	GVAE1	GVAE11	GVAE20			
LH side		GVAN11	GVAN20			
Fault signalling contact + instantaneous auxiliary contact						
LH side NO (fault)				GVAD1001	GVAD1010	
NC (fault)				GVAD0101	GVAD0110	
Short-circuit signalling contact						
LH side						GVAM11

Electric trips for GV2 and GV3 : undervoltage or shunt (1)

Side mounting (1 block on RH side of circuit-breaker)	50 Hz	60 Hz
Voltage 24 V	GVA*025	GVA*026
48 V	GVA*055	GVA*056
100 V	GVA*107	
100...110 V		GVA*107
110...115 V	GVA*115	GVA*116
120...127 V	GVA*125	
127 V		GVA*115
200 V	GVA*207	
200...220 V		GVA*207
220...240 V	GVA*225	GVA*226
380...400 V	GVA*385	GVA*386
415...440 V	GVA*415	
415 V		GVA*416

Padlocking device

For use with up to 4 padlocks (padlocks not supplied) Ø 6 mm shank max	GV2V03
--	---------------

(1) Undervoltage trips: replace the • with **U**, shunt trips: replace the • with **S**



Thermal-magnetic circuit-breakers GV7-R for connection by screw clamp terminals

Control by rocker lever

Standard power ratings of 3-phase motors 50/60 Hz in category AC-3									Setting range	Reference
400/415 V			500 V			660/690 V			of thermal	
P	I _{cu}	I _{cs} (1)	P	I _{cu}	I _{cs} (1)	P	I _{cu}	I _{cs} (1)	trips	
kW	kA		kW	kA		kW	kA		A	
7.5	25	100	9	18	100	11	8	100	12...20	GV7RE20
9	25	100	11	18	100	15	8	100		
7.5	70	100	9	50	100	11	10	100	12...20	GV7RS20
9	70	100	11	50	100	15	10	100		
9	25	100	11	18	100	15	8	100	15...25	GV7RE25
11	25	100	15	18	100	18.5	8	100		
9	70	100	11	50	100	15	10	100	15...25	GV7RS25
11	70	50	15	50	100	18.5	10	100		
18.5	25	100	18.5	18	100	22	8	100	25...40	GV7RE40
			22	18	100					
18.5	70	100	18.5	50	100	22	10	100	25...40	GV7RS40
22	25	100	30	18	100	30	8	100	30...50	GV7RE50
37	25	100	45	18	100	55	8	100	48...80	GV7RE80
			55	18	100					
37	70	100	45	50	100	55	10	100	48...80	GV7RS80
			55	50	100					
45	25	100	-	18	100	75	8	100	60...100	GV7RE100
45	70	100	-	50	100	75	10	100	60...100	GV7RS100
55	35	100	75	30	100	90	8	100	90...150	GV7RE150
75	70	100	90	30	100	110	8	100		
55	70	100	75	50	100	90	10	100	90...150	GV7RS150
75	70	100	90	50	100	110	10	100		
90	35	100	110	30	100	160	8	100	132...220	GV7RE220
110	35	100	132	30	100	200	8	100		
			160	30	100					
90	70	100	110	50	100	160	10	100	132...220	GV7RS220

(1) as % of I_{cu}

4

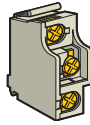

Add-on blocks

Contact blocks

Auxiliary contacts

Contact type	CO
	GV7AE11

Thermal or magnetic fault discrimination

	\approx 24...48 V or \approx 24...72 V	\approx 110...240 V
	GV7AD111	GV7AD112

Electric trips

Voltage	50/60 Hz	48 V	110... 130 V	200... 240 V	380...440 V	
	50 Hz					525 V
Undervoltage trip (1)		GV7AU055	GV7AU107	GV7AU207	GV7AU387	GV7AU525
Shunt trip (1)		GV7AS055	GV7AS107	GV7AS207	GV7AS387	GV7AS525

(1) For mounting of a GV7-AD or a GV7-AU or AS

4

Accessories

Terminal shields IP 405

Supplied with sealing accessory	GV7AC01
---------------------------------	---------

Phase barriers

Safety accessories	GV7AC04
--------------------	---------

used when fitting of shields is impossible

Insulating screens

Ensure insulation between	GV7AC05
---------------------------	---------

the connections and the backplate

Kit for combination with contactor

Allowing link between the circuit-breaker and the contactor	LC1-F115 to F185	LC1-F225 and F26	LC1-D115 and D150
	GV7AC06	GV7AC07	GV7AC08

Rotary handles

Handle	black	red
Legend plate	black	yellow
■ direct IP 40	GV7AP03	GV7AP04
■ extended IP 55	GV7AP01	GV7AP02

Conversion accessory

For mounting on enclosure door IP 43	GV7AP05
--------------------------------------	---------

Locking device

For circuit-breaker not fitted with a rotary handle	GV7V01
---	--------



Thermal-magnetic circuit-breakers GV3-ME for connection by screw clamp terminals

Pushbutton control

Standard power ratings of 3-phase motors 50/60 Hz in category AC-3									Setting range	Reference
400/415 V			500 V			660/690 V			of thermal	
P	I _{cu}	I _{cs} (1)	P	I _{cu}	I _{cs} (1)	P	I _{cu}	I _{cs} (1)	trips	
kW	kA		kW	kA		kW	kA		A	
37	15	50	45	4	100	55	2	100	56...80	GV3ME80

(1) as % of I_{cu}

4

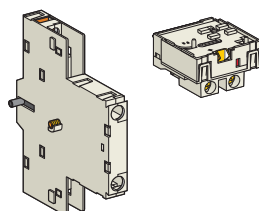

Add-on blocks for GV3-ME

Contact blocks

Instantaneous auxiliary contacts (1 per breaker)						
Normal early break type contacts	NC + NO	NO + NO	NC + NO + NO	NO + NO + NO	NO + NO (1)	NC + NO (1)
	GV3A01	GV3A02	GV3A03	GV3A05	GV3A06	GV3A07
Fault signalling contact						
Normal early break type contacts	NC			NO		
	GV3A08			GV3A09		
Electric trips						
Voltage	50 Hz	110, 120, 127 V		220, 240 V		380, 415 V
	60 Hz	120, 127 V		277 V		440, 480 V
Undervoltage trip		GV3B11		GV3B22		GV3B38
Shunt trip		GV3D11		GV3D22		GV3D38
Padlocking device						
Start button (for bare device)	GV1V02					

(1) + 2 volt free terminals



Type			Fuse carriers without "blown fuse" indicator			
Rated insulation voltage (Ui)			500 V	690 V		
Fuse size			8.5 x 31.5 mm	10 x 38 mm	14 x 51 mm	22 x 58 mm
Conventional thermal current (Ith)			25 A	32 A	50 A	125 A
References	Number of poles	1P	DF81	DF101	DF141	DF221
		N	DF10N	DF10N	DF14N	DF22N
		1P+N	DF81N	DF101N	DF141N	DF221N
		2P	DF82	DF102	DF142	DF222
		3P	DF83	DF103	DF143C	DF223C
		3P+N	DF83N	DF103N	DF143NC	DF223NC



Type			Fuse carriers with "blown fuse" indicator			
Rated insulation voltage (Ui)			500 V	690 V		
Fuse size			8.5 x 31.5 mm	10 x 38 mm	14 x 51 mm	22 x 58 mm
Conventional thermal current (Ith)			25 A	32 A	50 A	125 A
References	Number of poles	1P	DF81V	DF101V	DF141V	DF221V
		1P + N	DF81NV	DF10NV	DF14NV	DF22NV
		2P	DF82V	DF102V	DF142V	DF222V
		3P	DF83V	DF103V	DF143VC	DF223VC
		3P + N	DF83NV	DF103NV	DF143NVC	DF223NVC

Accessories

Type	Auxiliary early break and blown fuse signalling contacts			
Fuse carrier to be equipped	DF14		DF22	
Fuse size	14 x 51 mm		22 x 58 mm	
Number of poles	3P or 3P + N		3P or 3P + N	
Number of contacts	1	2	1	2
References	DF14AM1	DF14AM2	DF22AM1	DF22AM2

Type	Fuse carrier assembly kits			
Fuse carrier to be assembled	DF8	DF10	DF14	DF22
Fuse size	8.5 x 31.5 mm	10 x 38 mm	14 x 51 mm	22 x 58 mm
Kit contents	1 pin, 2 clips		1 pin, 3 clips	
References	DF10AP		DF14AP	DF22AP



Type	3-pole fuse carriers					
Rated insulation voltage (Ui)	690 V					
Rating	25 A	32 A	50 A		125 A	
Fuse size	10 x 38	10 x 38	14 x 51		22 x 58	
Connection	Spring terminals		Screw clamp terminals or connectors			
Single-phase protection device	Without		Without		Without	With
Number of early break contacts	-		-		1	1
Reference	LS1D323	LS1D32	GK1K	GK1EV	GK1FK	GK1FV
Number of early break contacts			2		2	
Reference			GK1ES	GK1EW	GK1FS	GK1FW

4



Type	4-pole fuse carriers				
Rated insulation voltage (Ui)	690 V				
Rating	32 A	50 A		125 A	
Fuse size	10 x 38	14 x 51		22 x 58	
Connection	Screw clamp terminals or connectors				
Single-phase protection device	Without	Without	With	Without	With
Number of early break contacts	-	1		1	
Reference	LS1D32 + LA8D324	GK1EM	GK1EY	GK1FM	GK1FY
Number of early break contacts		2		2	
Reference		GK1ET	GK1EX	GK1FT	GK1FX

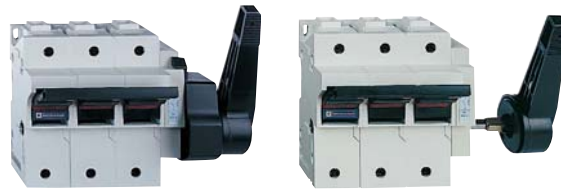

Type	Early break auxiliary contact blocks			
Fuse carrier rating	32 A		25 A	
For use with fuse carrier	LS1D32		LS1D323	
Contact type	NO + NC	NO + NO	NO + NC	NO + NO
References	GVAE11	GVAE20	GVAE113	GVAE203

Type	Direct operator handle		
Fuse carrier rating	125 A		32, 50, 125 A
For mounting on	RH side	LH side	Front
References	GK1AP07	GK1AP08	Fitted as standard

4

Type	External operator handle					
Fuse carrier rating	32 A		50 A		125 A	
For mounting on	RH side	LH side	RH side	LH side	RH side	LH side
References	LS1D32005	LS1D32006	GK1AP05	GK1AP06	GK1AP07	GK1AP08

Type	Padlocking devices				
Fuse carrier rating	32 A	50 A			
Number of poles	3 or 4	3	4		
Single-phase protection device	Without	Without	With	Without	With
References	Integrated	GK1AV07	GK1AV08	GK1AV08	GK1AV09

Type	Tubular links		
Fuse carrier rating	32 A	50 A	125 A
References	DK1CB92	DK1EB92	DK1FA9



Type	Switch-disconnector-fuse switch bodies for use with NF C or DIN fuses Handle to be ordered separately (see previous page)			
Rated insulation voltage (Ui)	690 V			
Conventional thermal current (Ith)	32 A	50 A	63 A	100 A
Fuse size	10 x 38	14 x 51	Size 00C (1)	22 x 58
External front-mounted and RH side-mounted operator	3-pole GS1DD3	GS2F3	GS2G3	GS2J3
	4-pole GS1DD4 (2)	GS2F4	GS2G4	GS2J4
External LH side-mounted operator	3-pole GS1DD3	GS2FG3	GS2GG3	GS2JG3
	4-pole GS1DD4 (2)	GS2FG4	GS2GG4	GS2JG4
Direct RH side-mounted operator	3-pole GS1DD3 (3)	GS1FD3	GS1GD3	GS1JD3
	4-pole GS1DD4 (2) (3)	GS1FD4	GS1GD4	GS1JD4

(1) Compact fuse for German market

(2) 3-pole + switched neutral

(3) Direct front-mounted operator

Type	Switch-disconnector-fuse switch bodies for use with BS fuses Handle to be ordered separately (see previous page)			
Rated insulation voltage (Ui)	690 V			
Conventional thermal current (Ith)	32 A	32 A	63 A	100 A
Fuse size	A1	A1	A2-A3	A4 (Ø ≤ 31 mm)
External front-mounted and RH side-mounted operator	3-pole GS1DDB3	GS2DB3	GS2GB3	GS2JB3
	4-pole GS1DDB4 (2)	GS2DB4	GS2GB4	GS2JB4

(2) 3-pole + switched neutral

Accessories

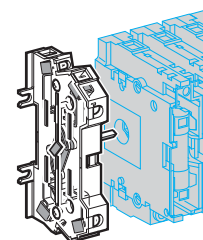
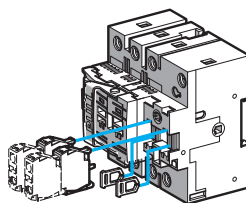

Type	Auxiliary contacts Early break and/or O, I and Test signalling			
	O and I signalling		O and I signalling	
Switch rating	32...1250 A		50...1250 A	
Number of contacts	1 NO	1 NC	1 NO + NC	2 NO + 2 NC
Operator	External front-mounted or RH side-mounted GS1AM110	GS1AM101	GS1AN11	GS1AN22
	External LH side-mounted GS1AM110	GS1AM101	GS1AN11G	GS1AN22G
	Direct RH side-mounted	—	GS1AN11	GS1AN22
	Direct front-mounted	—	—	—

Type	Auxiliary "blown fuse" signalling contacts for use with NF C and DIN fuses			
Number of contacts	1 NO/NC			
Switch rating	50 A	100 and 125 A	160 A	250 and 400 A
Fuse size	14 x 51	22 x 58	Size 0	Size 1 and Size 2
References	3-pole GS1AF1	GS1AF23	GS1AF33	GS1AF43
	4-pole GS1AF1	GS1AF24	GS1AF34	GS1AF44



Switch-disconnector-fuse switch bodies for use with NF C or DIN fuses
Handle to be ordered separately (see previous page)

690 V							
125 A		160 A		250 A	400 A	630 A	1250 A
22 x 58	Size 00	Size 00	Size 0	Size 1	Size 2	Size 3	Size 4
GS2K3	GS2KK3	GS2LL3	GS2L3	GS2N3	GS2QQ3	GS2S3	GS2V3
GS2K4	GS2KK4	GS2LL4	GS2L4	GS2N4	GS2QQ4	GS2S4	GS2V4
GS2KG3	GS2KKG3	GS2LLG3	GS2LG3	GS2NG3	GS2QQG3	GS2SG3	GS2VG3
GS2KG4	GS2KKG4	GS2LLG4	GS2LG4	GS2NG4	GS2QQG4	GS2SG4	GS2VG4
GS1KD3	GS1KKD3	GS1LLD3	GS1LD3	GS1ND3	GS1QD3	GS2S3 (3)	GS2V3 (3)
GS1KD4	GS1KKD4	GS1LLD4	GS1LD4	GS1ND4	GS1QD4	GS2S4 (3)	GS2V4 (3)

Switch-disconnector-fuse switch bodies for use with BS fuses
Handle to be ordered separately (see previous page)

690 V								
160 A		200 A	250 A	315 A	400 A	630 A	800 A	1250 A
A4	B1-B2	B1-B2	B1...B3	B1...B3	B1...B4	C1-C2	C1...C3	D1
GS2LLB3	GS2LB3	GS2MMB3	GS2NB3	GS2PPB3	GS2QQB3	GS2SB3	GS2TB3	GS2VB3
GS2LLB4	GS2LB4	GS2MMB4	GS2NB4	GS2PPB4	GS2QQB4	GS2SB4	GS2TB4	GS2VB4

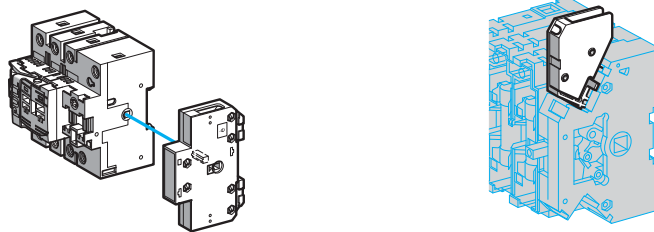

Auxiliary contacts
O, I and Test signalling

Early break and O and I signalling

50...400 A		32 A		50...400 A	
1 NO + NC	2 NO + 2 NC	1 NO/NC	2 NO/NC	1 NO/NC	2 NO/NC
GS1ANT11	GS1ANT22	–	–	–	–
–	–	–	–	GS1AM1	GS1AM2
–	–	GS1AM111	GS1AM211	–	–

Auxiliary "blown fuse" signalling contacts for use with NF C and DIN fuses

		2 nd NO/NC
630 A	1250 A	50...1250 A
Size 3	Size 4	–
GS2AF63	GS2AF73	GS1AF
GS2AF64	GS2AF74	GS1AF

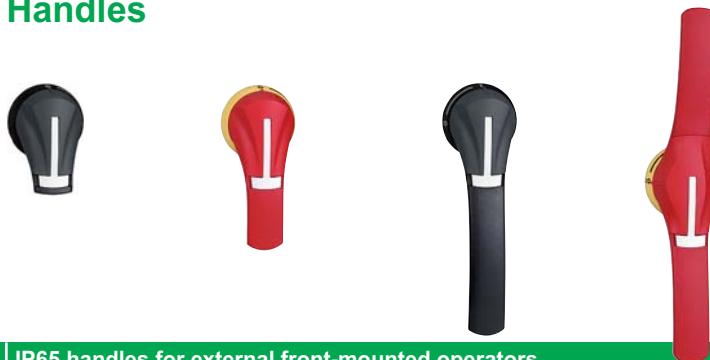

Type		IP65 handles for external front-mounted operators			
Switch rating		32...63 A	100...400 A	630...800 A	1250 A
References	Black/grey	GS2AH510 (1)	GS2AH530 (1)	GS2AH550	GS2AH570
	Red/yellow	GS2AH520 (1)	GS2AH540 (1)	GS2AH560	GS2AH580

(1) For external front operators with Test facility, insert the letter **T** in the reference. Example: GS2AH510 becomes GS2AHT510

Type		IP65 handles for external RH side-mounted operators (2)		
Switch rating		32...63 A	100...400 A	630...1250 A
References	Black/grey	GS2AH210	GS2AH230	GS2AH250
	Red/yellow	GS2AH220	GS2AH240	GS2AH260

(2) For external LH side-mounted operators, replace the number 2 in the reference by 3. Example: GS2AH210 becomes GS2AH310

Type			Shafts for external operators		
Switch rating			32 A	50...400 A	630...1250 A
References	Length of shaft	200 mm	GS2AE82	GS2AE22	GS2AE52
		320 mm	GS2AE8	GS2AE2	GS2AE5
		400 mm	GS2AE81	GS2AE21	GS2AE51



Type		Handles for direct operators				
Switch rating		32 A	50 and 63 A	100...400 A	630 and 800 A	1250 A
Type of operator		Front	RH side	RH side	Front	Front
References		GS1AH103	GS1AH01	GS1AH02	GS2AH104	GS2AH105



Thermal overload relays, TeSys K

adjustable from 0.11 to 12 A

Connection by screw clamp terminals, direct mounting on contactors LC1-K, manual or automatic reset

Relay setting range	Fuses to be used with selected relay			Reference
	aM	gG	BS88	
Class 10A				
0.11...0.16 A	0.25 A	0.5 A	-	LR2K0301
0.16...0.23 A	0.25 A	0.5 A	-	LR2K0302
0.23...0.36 A	0.5 A	1 A	-	LR2K0303
0.36...0.54 A	1 A	1.6 A	-	LR2K0304
0.54...0.8 A	1 A	2 A	-	LR2K0305
0.8...1.2 A	2 A	4 A	6 A	LR2K0306
1.2...1.8 A	2 A	6 A	6 A	LR2K0307
1.8...2.6 A	2 A	6 A	10 A	LR2K0308
2.6...3.7 A	4 A	10 A	16 A	LR2K0310
3.7...5.5 A	6 A	16 A	16 A	LR2K0312
5.5...8 A	8 A	20 A	20 A	LR2K0314
8...11.5 A	10 A	25 A	20 A	LR2K0316

Thermal overload relays for use on class 10A unbalanced loads: for above references LR2-K0305 to LR2-K0316 only, replace the prefix LR2 with LR7.

Example: LR7-K0310.

Accessories

Prewiring kit

Allowing direct connection of the NC contact of relay LRD-01...35 or LR3-D01... D35 to the contactor	For use on	
	LC1D09...D18	LAD7C1
	LC1D25...D38	LAD7C2

Terminal blocks (1)

For clip-on mounting on 35 mm mounting rail (AM1-DP200) or screw fixing	LRD01...35 and LR3D01...D35	LAD7B10
	LRD3***, LR3D3***, LRD35**	LA7D3064 (2)
For independent mounting of the relay	LR2K****	LA7K0064

EverLink Terminal blocks

Separate terminal block	LRD313... LRD365	LAD9R3
-------------------------	------------------	--------

Terminal block adapter

For mounting a relay beneath an LC1-D115 or D150 contactor	LRD3***, LR3D3***, LRD35**	LA7D3058
--	----------------------------	----------

Stop or electrical reset

Remote (3)	LRD01...35 and LR3D01...D35	LAD703• (4)
------------	-----------------------------	-------------

Tripping or electrical reset device

Remote (3)	All relays except LRD01...35 and LR3D01...D35	LA7D03• (4)
------------	---	-------------

(1) Terminal blocks are supplied with terminals protected against direct finger contact and screws in the open "ready-to-tighten" position.

(2) To order a terminal block for connection by lug-clamps, the reference becomes LA7-D30646.

(3) The time for which the coil of remote tripping or electrical resetting device LA7-D03 or LAD-703 can remain energised depends on its rest time: 1 s pulse duration with 9 s rest time; maximum pulse duration of 20 s with a rest time of 300 s. Minimum pulse time 200 ms.

(4) Reference to be completed by adding the code indicating the control circuit voltage.

Standard control circuit voltages

~ supply

Volts	12	24	48	96	110	220/230	380/400	415/440
50/60 Hz. Consumption, inrush and sealed < 100 VA	-	B	E	-	F	M	Q	N

≡ supply

Consumption, inrush and sealed < 100 W	J	B	E	DD	F	M	-	-
--	---	---	---	----	---	---	---	---

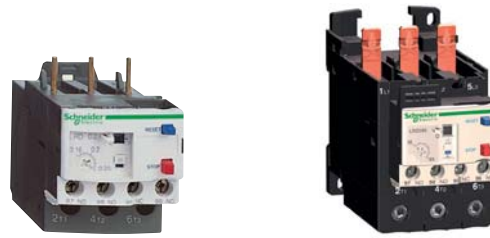

Thermal overload relays, TeSys D
adjustable from 0.1 to 140 A

Compensated relays with manual or automatic reset, with relay trip indicator, for a.c. or d.c.

Connection by screw clamp terminals or connectors	Relay setting range	Fuses to be used with selected relay			With contactor	Reference	
		aM	gG	BS88			
Class 10A	0.10...0.16 A	0.25 A	2 A	-	LC1D09...D38	LRD01 (1)	
	0.16...0.25 A	0.5 A	2 A	-	LC1D09...D38	LRD02 (1)	
	0.25...0.40 A	1 A	2 A	-	LC1D09...D38	LRD03 (1)	
	0.40...0.63 A	1 A	1.6 A	-	LC1D09...D38	LRD04 (1)	
	0.63...1 A	2 A	4 A	-	LC1D09...D38	LRD05 (1)	
	1...1.7 A	2 A	4 A	6 A	LC1D09...D38	LRD06 (1)	
	1.6...2.5 A	4 A	6 A	10 A	LC1D09...D38	LRD07 (1)	
	2.5...4 A	6 A	10 A	16 A	LC1D09...D38	LRD08 (1)	
	4...6 A	8 A	16 A	16 A	LC1D09...D38	LRD10 (1)	
	5.5...8 A	12 A	20 A	20 A	LC1D09...D38	LRD12 (1)	
	7...10 A	12 A	20 A	20 A	LC1D09...D38	LRD14 (1)	
	9...13 A	16 A	25 A	25 A	LC1D12...D38	LRD16 (1)	
	12...18 A	20 A	35 A	32 A	LC1D18...D38	LRD21 (1)	
	16...24 A	25 A	50 A	50 A	LC1D25...D38	LRD22 (1)	
	23...32 A	40 A	63 A	63 A	LC1D25...D38	LRD32 (1)	
	30...38 A	50 A	80 A	80 A	LC1D32 and D38	LRD35 (1)	
	55...70 A	80 A	125 A	125 A	D50...D95	LRD3361 (1)	
	63...80 A	80 A	125 A	125 A	D65...D95	LRD3363 (1)	
	80...104 A	100 A	160 A	160 A	D80 and D95	LRD3365 (1)	
	80...104 A	125 A	200 A	160 A	D115 and D150	LRD4365 (1)	
95...120 A	125 A	200 A	200 A	D115 and D150	LRD4367 (1)		
110...140 A	160 A	250 A	200 A	D150	LRD4369 (1)		
80...104 A	100 A	160 A	160 A	Independent mtg.	LRD33656 (1)		
95...120 A	125 A	200 A	200 A	Independent mtg.	LRD33676 (1)		
110...140 A	160 A	250 A	200 A	Independent mtg.	LRD33696 (1)		
Class 20	6 A	10 A	16 A	-	LC1D09...D32	LRD1508 (1)	
	4...6 A	8 A	16 A	16 A	LC1D09...D32	LRD1510 (1)	
	5.5...8 A	12 A	20 A	20 A	LC1D09...D32	LRD1512 (1)	
	7...10 A	16 A	20 A	25 A	LC1D09...D32	LRD1514 (1)	
	9...13 A	16 A	25 A	25 A	LC1D12...D32	LRD1516 (1)	
	12...18 A	25 A	35 A	40 A	LC1D18...D32	LRD1521 (1)	
	17...25 A	32 A	50 A	50 A	LC1D25 and D32	LRD1522 (1)	
	23...28 A	40 A	63 A	63 A	LC1D25 and D32	LRD1530 (1)	
	25...32 A	40 A	63 A	63 A	LC1D25 and D32	LRD1532 (1)	
	55...70 A	100 A	125 A	125 A	D65...D95	LR2D3561 (1)	
	63...80 A	100 A	160 A	125 A	D80 and D95	LR2D3563 (1)	
	Connection by EverLink terminal blocks, with BTR screws						
	Class 10A	9...13 A	16 A	25 A	25 A	LC1D40A...D65A	LRD313 (2)
12...18 A		20 A	32 A	35 A	LC1D40A...D65A	LRD318 (2)	
17...25 A		25 A	50 A	50 A	LC1D40A...D65A	LRD325 (2)	
23...32 A		40 A	63 A	63 A	LC1D40A...D65A	LRD332 (2)	
30...40 A		40 A	80 A	80 A	LC1D40A...D65A	LRD340 (2)	
37...50 A		63 A	100 A	100 A	LC1D40A...D65A	LRD350 (2)	
48...65 A		63 A	100 A	100 A	LC1D40A...D65A	LRD365 (2)	
Class 20	9...13 A	20 A	32 A	35 A	LC1D40A...D65A	LRD313L (2)	
	12...18 A	25 A	40 A	40 A	LC1D40A...D65A	LRD318L (2)	
	17...25 A	32 A	50 A	50 A	LC1D40A...D65A	LRD325L (2)	
	23...32 A	40 A	63 A	63 A	LC1D40A...D65A	LRD332L (2)	
	30...40 A	50 A	80 A	80 A	LC1D40A...D65A	LRD340L (2)	
	37...50 A	63 A	100 A	100 A	LC1D40A...D65A	LRD350L (2)	
	48...65 A	80 A	125 A	125 A	LC1D40A...D65A	LRD365L (2)	

Class 10A with connection by lug-clamps:

Select overload relay with screw clamp terminals or connectors from the table above and add one of the following suffixes:

■ figure 6 for relays LRD01 to LRD35 and LRD313 to LRD365.

■ A66 for relays LRD3361 to LRD3365.

Relays LRD43 are suitable as standard, for use with lug-clamps.

(1) For independent mounting on a DIN rail, order an EverLink LAD7B106 terminal block.

Thermal overload relays for use with unbalanced loads Class 10A

with connection by screw clamp terminals and lug-clamp terminals:

In the reference selected above, change LRD (except LRD4●●●) to LR3D

Example: LRD01 becomes **LR3D01**

Example with EverLink terminals: LRD340 becomes **LR3D340**

Example with lug-clamp terminals: LRD3406 becomes **LR3D3406**

(2) For independent mtg. on a DIN rail, order an EverLink LAD96560 terminal block.



For use with contactor	LC1-D	LC1-F
Motor current	60...150 A	30...630 A
Basic reference, to be completed	LR9D	LR9F

Relay setting range	Fuse to be used with selected relay		For mounting beneath contactor LC1-	Compensated and differential		With alarm
	aM	gG		Class 10	Class 20	
60...100	100	160	D115 and D150	LR9D5367	LR9D5567	Class 10 or 20
90...150	160	250	D115 and D150	LR9D5369	LR9F5569	
30...50	50	80	F115...F185	LR9F5357	LR9F5557	LR9F57
48...80	80	125	F115...F185	LR9F5363	LR9F5563	LR9F63
60...100	100	200	F115...F185	LR9F5367	LR9F5567	LR9F67
90...150	160	250	F115...F185	LR9F5369	LR9F5569	LR9F69
132...220	250	315	F185...F400	LR9F5371	LR9F5571	LR9F71
200...330	400	500	F225...F500	LR9F7375	LR9F7575	LR9F75
300...500	500	800	F225...F500	LR9F7379	LR9F7579	LR9F79
380...630	630	800	F400...F630 and F800	LR9F7381	LR9F7581	LR9F81

Accessories		
Remote control		
Function	Reset	Stop and/or Reset
Electrical reset (1)	LA7D03•(2)	
Reset by flexible cable (length 0.5 m)	LA7D305	
Adapter for door interlock mechanism		LA7D1020
Operating head for pushbutton		
Spring return	ZA2BL639	ZA2BL432
Rod with snap-off end		
Adjustable from 17 to 120 mm	ZA2BZ13	
Insulated terminal blocks		
For relays LR9-F5•57, F5•63, F5•67, F5•69, F57, F63, F67 and F69	Set of 2 blocks	
	LA9F103	

(1) The time for which the coil of remote electrical reset device LA7-D03 can remain energised depends on its rest time: 1 s pulse with 9 s rest time; 5 s pulse duration with 30 s rest time; 10 s pulse duration with 90 s rest time: maximum pulse duration 20 s with rest time of 300 s. Minimum pulse time: 200 ms.

(2) Reference to be completed by adding the coil voltage code, see page 4/25



Type of fieldbus			Ethernet		Modbus		Profibus DP	
Supply voltage			24 V DC	100...240 V AC	24 V DC	100...240 V AC	24 V DC	100...240 V AC
References	Current range	0.4...8 A	LTMR08EBD	LTMR08EFM	LTMR08MBD	LTMR08MFM	LTMR08PBD	LTMR08PFM
		1.35...27 A	LTMR27EBD	LTMR27EFM	LTMR27MBD	LTMR27MFM	LTMR27PBD	LTMR27PFM
		5...100 A	LTMR100EBD	LTMR100EFM	LTMR100MBD	LTMR100MFM	LTMR100PBD	LTMR100PFM



Type of fieldbus			CANopen		DeviceNet	
Supply voltage			24 V DC	100...240 V AC	24 V DC	100...240 V AC
References	Current range	0.4...8 A	LTMR08CBD	LTMR08CFM	LTMR08DBD	LTMR08DFM
		1.35...27 A	LTMR27CBD	LTMR27CFM	LTMR27DBD	LTMR27DFM
		5...100 A	LTMR100CBD	LTMR100CFM	LTMR100DBD	LTMR100DFM

Extension module



Type of module	Extension		Ethernet external port
	4 additional inputs + voltage measuring		Modbus RTU / Modbus TCP/IP
Inputs voltage	24 V DC	100...240 V AC	24 V DC
References	LTMEV40BD	LTMEV40FM	TCSEQM113M13M

Control unit



Type of terminal	Compact display
Supply voltage	24 V DC
Reference	LTMCU



Type of transformer		External			
Operational current	primary	100 A	200 A	400 A	800 A
	secondary	1 A			
References		LT6CT1001	LT6CT2001	LT6CT4001	LT6CT8001

Earth fault toroids

Type of toroid	Closed						Split	
Maximum current	65 A	85 A	160 A	250 A	400 A	630 A	85 A	250 A
Internal diameter	Ø 30	Ø 50	Ø 80	Ø 120	Ø 200	Ø 300	Ø 46	Ø 110
References	TA30	PA50	IA80	MA120	SA200	GA300	POA	GOA

PTC thermistor probe

Type of probe	Triple							
Operating temperature	90°C	110°C	120°C	130°C	140°C	150°C	160°C	170°C
References	DA1TT090	DA1TT110	DA1TT120	DA1TT130	DA1TT140	DA1TT150	DA1TT160	DA1TT170

Accessories (1)



Type of accessory	Connecting cable Controller / Extension module		
Length of cable	0.04 m	0.3 m	1 m
References	LTMCC004	LU9R03	LU9R10



Type of accessory	Connecting cable Controller/ Display			Connection kit PC serial port
Length of cable	1 m	3 m	5 m	-
References	VW3A1104R10	VW3A1104R30	VW3A1104R50	VW3A8106

(1) For other connection accessories, see www.schneider-electric.com



Relay type	PTC thermistor probes	
For use with contactor	LC1-D or LC1-F	LC1-D or LC1-F
Motor current	No limit	1...5 A
Basic reference, to be completed	LT3S	LT6P0M0•5FM

Protection unit

4

Type	With automatic reset with thermistor short-circuit detection		
Without fault memory			
Connection	Voltage	Output contact	Reference
by cage connectors	~ 50/60 Hz	115 V	NC
	---	230 V	NC
	---	24 V	NC
On front panel: fault and voltage signalling indicator			
	~ 50/60 Hz	115/230 V	NC + NO
	---	24/48 V	NC + NO
	~ 50/60 Hz or ---	24...230 V	2 CO
With fault memory			
On front panel: fault and voltage signalling indicator, Test and Reset button			
	~ 50/60 Hz	400 V	NC + NO
		24/48 V	NC + NO
		115/230 V	NC + NO
	---	24/48 V	NC + NO
	~ 50/60 Hz or ---	24...230 V	2 CO

Accessories

Type	PTC thermistor probes for LT3 relays							
Normal operating temperature (NOT)	90 °C	110 °C	120 °C	130 °C	140 °C	150 °C	160 °C	170 °C
Integrated triple probes	DA1TT090	DA1TT110	DA1TT120	DA1TT130	DA1TT140	DA1TT150	DA1TT160	DA1TT170
Normal operating temperature (NOT)	60 °C	70 °C	80 °C	90 °C	100 °C			
Surface probes	DA1TS060	DA1TS070	DA1TS080	DA1TS090	DA1TS100			

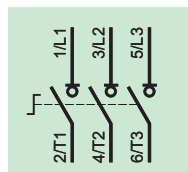

Type	Mini-Vario for standard applications		
	Door mounting		Backplate mounting in enclosure
Colour: Handle / Front plate	Red / Yellow	Black / Black	Red / Yellow
Front plate dimensions (mm)	60 x 60		60 x 60
Fixing	Ø 22.5 mm		Ø 22.5 mm
Degree of protection	IP 20		IP 20
Rated insulation voltage (Ui)	690 V		690 V
Thermal current in open air (Ith)	12 A	VCDN12	VBDN12
	20 A	VCDN20	VBDN20

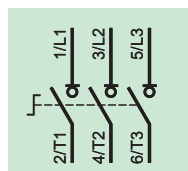

Type	Vario for high performance applications								
	Door mounting			Backplate mounting in enclosure					
Colour: Handle / Front plate	Red / Yellow	Black / Black	Red / Yellow	Black / Black	Red / Yellow	Red / Yellow			
Front plate dimensions (mm)	60 x 60		60 x 60		90 x 90	60 x 60			
Fixing	Ø 22.5 mm		4 screws		4 screws	Ø 22.5 mm			
Degree of protection	IP 20		IP 20		IP 20	IP 20			
Rated insulation voltage (Ui)	690 V		690 V		690 V	690 V			
Thermal current in open air (Ith)	12 A	VCD02	VBD02	VCF02	VBF02	–	VCCD02	VCCF02	–
	20 A	VCD01	VBD01	VCF01	VBF01	–	VCCD01	VCCF01	–
	25 A	VCD0	VBD0	VCF0	VBF0	–	VCCD0	VCCF0	–
	32 A	VCD1	VBD1	VCF1	VBF1	–	VCCD1	VCCF1	–
	40 A	VCD2	VBD2	VCF2	VBF2	–	VCCD2	VCCF2	–
	63 A	–	–	VCF3	VBF3	–	–	VCCF3	–
	80 A	–	–	VCF4	VBF4	–	–	VCCF4	–
	125 A	–	–	–	–	VCF5	–	–	VCCF5
	175 A	–	–	–	–	VCF6	–	–	VCCF6



Add-on modules	For mini-Vario		For Vario						
Main pole modules									
Switch rating	12 A	20 A	12 A	20 A	25 A	32 A	40 A	63 A	80 A
References	VZN12	VZN20	VZ02	VZ01	VZ0	VZ1	VZ2	VZ3	VZ4
Neutral pole module with early make and late break contacts									
Switch rating	12...20 A		12...40 A		63 and 80 A		125 and 175 A		
References	VZN11		VZ11		VZ12		VZ13		
Earthing module									
Switch rating	12...20 A		12...40 A		63 and 80 A		125 and 175 A		
References	VZN14		VZ14		VZ15		VZ16		
Auxiliary contact block modules									
Contact type	NO	NC	NO + NC			NO + NO			
References	VZN05	VZN06	VZ7			VZ20			



D.O.L. starters

		with circuit-breaker			with fuse protection
Level of service	Coordination:	Type 1			Type 2
Power at 400 V	Up to:	5.5 kW		15 kW	37 kW
Type of components		Combination automatic motor starter with overload protection incorporated in the circuit-breaker			Fuse carrier + plate-mounted contactor
Basic reference, to be completed		GV2ME	GV2DM	GV2DP	LC4D

4



Starters GV2-ME

Standard power ratings of 3-phase motors 50/60 Hz in category AC-3 (kW)					Setting range of thermal trips	Fixed magnetic tripping current	For customer assembly		Non-reversing	Reversing
400/415 V			440 V	500 V			Motor circuit-breaker	Contactor	Factory assembled	Basic reference, to be completed with code indicating control circuit voltage
0.37	0.37	0.37	1...1.6	22.5	GV2ME06	LC1K06	GV2ME06K1**	GV2ME06K2**		
0.55	0.55	0.55								
-	-	0.75								
0.75	0.75	-	1.6...2.5	33.5	GV2ME07	LC1K06	GV2ME07K1**	GV2ME07K2**		
-	1.1	1.1								
1.1	-	1.5	2.5...4	51	GV2ME08	LC1K06	GV2ME08K1**	GV2ME08K2**		
1.5	1.5	2.2								
2.2	2.2	-	4...6.3	78	GV2ME10	LC1K06	GV2ME10K1**	GV2ME10K2**		
-	-	3								
3	-	4	6...10	138	GV2ME14	LC1K09	GV2ME14K1**	GV2ME14K2**		
4	4	5.5								
5.5	5.5	7.5	9...14	170	GV2ME16	LC1K12	GV2ME16K1**	GV2ME16K2**		

Standard control circuit voltages (for other voltages, please consult our website <http://www.schneider-electric.com>)

Volts	24	110	220/230	230	230/240	380/400
~ 50...400 Hz	B7	F7	M7	P7	U7	Q7
--- (1)	BW3	-	-	-	-	-

(1) Low consumption coil (1.5 W), wide range (0.7...1.3 Uc) and with integral suppression device as standard.



D.O.L. starters GV2DM and GV3-DP

Standard power ratings of 3-phase motors 50/60 Hz in category AC-3 (kW)				Setting range of thermal trips	Fixed magnetic tripping current	For customer assembly		Non-reversing	Reversing
400/415 V	440 V	500 V				Motor circuit-breaker	Contactor	Factory assembled	
Basic reference, to be completed with code indicating control circuit voltage									
0.06	0.06	-	0.16...0.25	2.4	13 Irth	GV2ME02	LC1D09**	GV2DM102**	GV2DM202**
						GV2P02	LC1D09**	GV2DP102**	GV2DP202**
0.09	0.09	-	0.25...0.40	5		GV2ME03	LC1D09**	GV2DM103**	GV2DM203**
-	0.12	-				GV2P03	LC1D09**	GV2DP103**	GV2DP203**
0.12	-	-	0.40...0.63	8		GV2ME04	LC1D09**	GV2DM104**	GV2DM204**
0.18	0.18	-				GV2P04	LC1D09**	GV2DP104**	GV2DP204**
0.25	0.25	-	0.63...1	13		GV2ME05	LC1D09**	GV2DM105**	GV2DM205**
0.37	0.37	-				GV2P05	LC1D09**	GV2DP105**	GV2DP205**
-	-	0.37	1...1.6	22.5		GV2ME06	LC1D09**	GV2DM106**	GV2DM206**
0.55	0.55	0.55				GV2P06	LC1D09**	GV2DP106**	GV2DP206**
-	-	0.75							
0.75	0.75	-	1.6...2.5	33.5		GV2ME07	LC1D09**	GV2DM107**	GV2DM207**
-	1.1	1.1				GV2P07	LC1D09**	GV2DP107**	GV2DP207**
1.1	-	1.5	2.5...4	51		GV2ME08	LC1D09**	GV2DM108**	GV2DM208**
1.5	1.5	2.2				GV2P08	LC1D09**	GV2DP108**	GV2DP208**
2.2	2.2	-	4...6.3	78		GV2ME10	LC1D09**	GV2DM110**	GV2DM210**
-	3	3				GV2P10	LC1D09**	GV2DP110**	GV2DP210**
3	-	4	6...10	138		GV2ME14	LC1D09**	GV2DM114**	GV2DM214**
4	4	5.5				GV2P14	LC1D09**	GV2DP114**	GV2DP214**
5.5	5.5	7.5	9...14	170		GV2ME16	LC1D12**	GV2DM116**	GV2DM216**
-	7.5	9				GV2P16	LC1D25**	GV2DP116**	GV2DP216**
7.5	9	-	13...18	223		GV2ME20	LC1D18**	GV2DM120**	GV2DM220**
						GV2P20	LC1D25**	GV2DP120**	GV2DP220**
9	11	11	17...23	327		GV2ME21	LC1D25**	GV2DM121**	GV2DM221**
						GV2P21	LC1D25**	GV2DP121**	GV2DP221**
11	-	15	20...25	327		GV2ME22	LC1D25**	GV2DM122**	GV2DM222**
						GV2P22	LC1D25**	GV2DP122**	GV2DP222**
15	15	18.5	24...32	416		GV2ME32	LC1D32**	GV2DM132**	GV2DM232**
						GV2P32	LC1D32**	GV2DP132**	GV2DP232**

4

D.O.L. starters GV3 + LC1D

Standard power ratings of 3-phase motors 50/60 Hz in category AC-3 (kW)				Setting range of thermal trips	Fixed magnetic tripping current	For customer assembly		Non-reversing	Reversing
400/415 V	440 V	500 V				Motor circuit-breaker	Contactor	Reference of accessory to be ordered for assembly of motor starter (2)	
18,5	18,5	-	30...40	560		GV3P401 (1)	LC1D40A**	-	LAD9R3
-	22	22	30...40	560		GV3P401 (1)	LC1D40A**	-	LAD9R3
22	-	30	37...50	700		GV3P501 (1)	LC1D50A**	-	LAD9R3
30	30	37	48...65	910		GV3P651 (1)	LC1D65A**	-	LAD9R3

(1) Circuit-breaker GV3P without downstream EverLink terminal block. A standard GV3P can also be used by removing the downstream terminal block.

(2) For side by side circuit-breaker/contacting mounting, order accessory GV3S.

Standard control circuit voltages (for other voltages, please consult our website <http://www.schneider-electric.com>)

Volts	24	220	230
~ 50...400 Hz	B7	M7	P7
⋮ (3)	BD	-	-

(3) Low consumption coil, wide range (0.7 to 1.25 Uc) and with suppression device as standard (bidirectional peak limiting diode).



Function characteristics, LUB... + LUCA...	Maximum motor power < 400/415 V	Power base		Standard control unit	
		Non-reversing	Reversing (1)	Class 10 (2)	Setting range
- Thermal overload protection against: short-circuit, overcurrent, phase failure or imbalance, insulation breaks (equipment only). - Manual reset following thermal fault.	0.09 kW	LUB12	LU2B12●●	LUCA6X●●	0.15...0.6 A
	0.25 kW	LUB12	LU2B12●●	LUCA1X●●	0.35...1.4 A
	1.5 kW	LUB12	LU2B12●●	LUCA05●●	1.25...5 A
	5.5 kW	LUB12	LU2B12●●	LUCA12●●	3...12 A
	7.5 kW	LUB32	LU2B32●●	LUCA18●●	4.5...18 A
	15 kW	LUB32	LU2B32●●	LUCA32●●	8...32 A

ADVANCED motor starter



Function characteristics, LUB... + LUCA...	Maximum motor power < 400/415 V	Power base Non-reversing	Advanced control unit		Setting range
			Class 10 (2) (3)	Class 20 (2)	
- Thermal overload protection against: short-circuit, overcurrent, phase failure or imbalance, insulation breaks (equipment only). - Manual reset following thermal fault. - Thermal overload test function.	0.09 kW	LUB120	LUCB6X●●	LUCD6X●●	0.15...0.6 A
	0.25 kW	LUB120	LUCB1X●●	LUCD1X●●	0.35...1.4 A
	1.5 kW	LUB120	LUCB05●●	LUCD05●●	1.25...5 A
	5.5 kW	LUB120	LUCB12●●	LUCD12●●	3...12 A
	7.5 kW	LUB320	LUCB18●●	LUCD18●●	4.5...18 A
	15 kW	LUB320	LUCB32●●	LUCD32●●	8...32 A

(3) For single-phase-motors, replace LUCB●●●● by LUC●●●●.

MULTIFUNCTION motor starter



Function characteristics, LUB... + LUCA...	Maximum motor power < 400/415 V	Power base Non-reversing	Multifunction control unit	
			Class 5 to 30	Setting range
- Thermal overload protection against: short-circuit, overcurrent, phase failure or imbalance, insulation breaks (equipment only). - Manual, automatic or remote reset, - Thermal overload test function, - Overtorque and no-load running, alarm, - Motor operation log, - Motor parameters display on LUCM..., PC or HMI, - Integrated Modbus communication.	0.09 kW	LUB120	LUCM6XBL	0.15...0.6 A
	0.25 kW	LUB120	LUCM1XBL	0.35...1.4 A
	1.5 kW	LUB120	LUCM05BL	1.25...5 A
	5.5 kW	LUB120	LUCM12BL	3...12 A
	7.5 kW	LUB320	LUCM18BL	4.5...18 A
	15 kW	LUB320	LUCM32BL	8...32 A

(1) Complete the references of the power bases according to the following table.

Example: LU2B12

●●

(2) Complete the references of the control units according to the following table.

Example: LUCA/B/D/M6X

●●

Standard control circuit voltages

24 V DC	BL
24 V AC	B
48 V AC / 48...72 V DC	ES
110...240 V AC / 110...220 V DC	FU



Type of optional function	Thermal overload alarm		Thermal fault signalling			Motor load indication
	NO	NO	NO	NO	NO	NO
Compatible with LUCA	NO	NO	NO	NO	NO	NO
Compatible with LUCL	NO	NO	NO	NO	NO	NO
Compatible with LUCB, LUCD	YES	YES	YES	YES	YES	YES
Compatible with LUCM	NO	NO	NO	NO	NO	YES
Output signal	1 NO	1 NO +1 NC	1 NC	1 NO	1 NO	4...20 mA
Reset	NA	Manual	Automatic or remote			NA
References	LUFW10	LUFDH11	LUFDA01	LUFDA10	LUFV2	

Communication modules



Type of communication	Modbus	Modicon STB	Profibus DP	CANopen	DeviceNet	AS-Interface	Parallel wiring
Only compatible with 24 V DC control units LUCA..BL, LUCB..BL, LUCD..BL, LUCM..BL	YES	YES	YES	YES	YES	YES	YES
Transfer speed	19.2 Kbps	Dpg. on NIM (1)	9.6...12 Mbps	20 K...1 Mbps	125...500 Kbaud	167 Kbps	NA
Number of slaves	31 per Modbus master	Dpg. on Network Interface Module	125 per Profibus DP module	128 per CANopen module	63 per DeviceNet module	62 per AS-Interface master	8 per LU9GC02 splitter box
Pre-wired coil connection (A1 A2)	LU9BN11C, LU9MRC	LU9BN11L, LU9MRL	LU9BN11L, LU9MRL	LU9BN11L, LU9MRL	LU9BN11L, LU9MRL	LU9BN11C, LU9MRC	LU9Rxx
Connecting cable to PC	VW3 A8 306 R●●	LU9RCD●●, LU9RDD●●	TSXPBSCA●●	TSXCANC●●	DeviceNet standard	XZCG0142	TSXCDP●●●
References	LUFC033	LULC15	LULC07	LULC08	LULC09	ASILUFC51	LUFC00

(1) Network Interface Module.

Information carried by the Modbus, Modicon STB or CANopen bus

Type of control unit	LUCA●●BL	LUCB●●BL, LUCD●●BL	LUCM●●BL
Start and Stop commands	X	X	X
Starter status (ready, running, fault)	X	X	X
Thermal alarm		X	X
Remote reset via the bus		X	X
Indication of motor load		X	X
Signalling and fault differentiation		X	X
Alarms (overcurrent, ...)			X
Remote programming and monitoring of all the functions			X
"Log" function			X
Monitoring function			X

Contact blocks



Type of contact block	Add-on	Auxiliary
Signalling contacts	of any fault	NC (95-96) NO (97-98) – – –
	position of control handle	NO (17-18) NO (17-18) – – –
2 auxiliary contacts module	–	NO (33-34) NC (31-32) NC (31-32)
	–	NO (43-44) NO (43-44) NC (41-42)
References	Screw clamp terminals	LUA1C11 LUA1C20 LUFN20 LUFN11 LUFN02
	Without connections	LUA1C110 LUA1C200 – – –

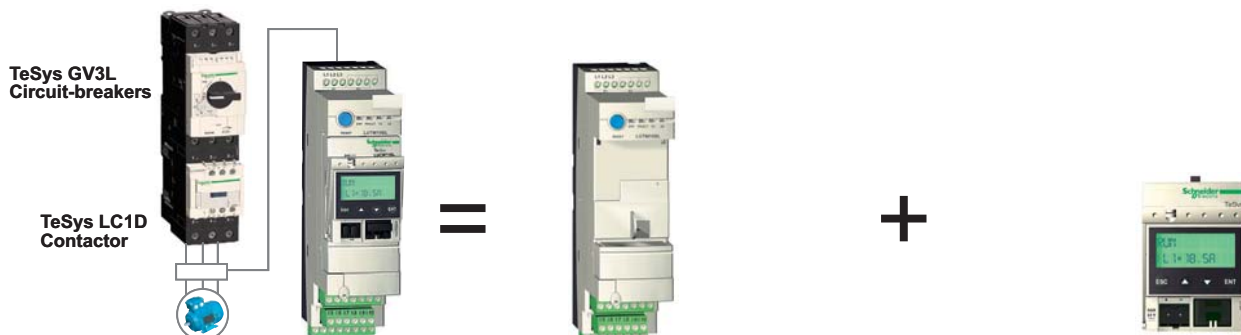

Function characteristics	Control base for use with contactors		Multifunction control unit
	TeSys D (LC1D..)	TeSys F (LC1F..)	Class 5 to 35
<ul style="list-style-type: none"> - Thermal overload protection against: short-circuit, overcurrent, phase failure or imbalance, insulation breaks (equipment only). - Manual, automatic or remote reset, - Thermal overload test function, - Overtorque and no-load running, alarm, - Motor operation log, - Motor parameters display on LUCM..., PC or HMI, - Integrated Modbus communication. 	LUTM10BL	LUTM20BL	LUCMT1BL

4

ADVANCED protection



Function characteristics	Control base for use with contactors		Advanced control unit	
	TeSys D (LC1D..)	TeSys F (LC1F..)	Class 10	Class 20
<ul style="list-style-type: none"> - Thermal overload protection against: short-circuit, overcurrent, phase failure or imbalance, insulation breaks (equipment only). - Manual reset following thermal fault. - Thermal overload test function. 	LUTM10BL	LUTM20BL	LUCBT1BL	LUCDT1BL

Current transformers

Type of transformer							
Supply voltage		24 V DC					
Operating current	Primary	30 A	50 A	100 A	200 A	400 A	800 A
	Secondary	1 A					
References		LUTC0301	LUTC0501	LUTC01001	LUTC02001	LUTC04001	LUTC05001

Above 32 A, the TeSys U controller provides a motor starter management system solution identical to that provided by the **TeSys U** starter-controller.

Used in conjunction with a short-circuit protection device and a contactor, it provides a motor starter whose functions are the same as those of a **TeSys U** starter-controller and, in particular, provides the following functions: overload protection, motor starter control and application monitoring.

It comprises a control unit, whose adjustment range is compatible with the secondary of current transformers, and a control base that also enables the fitting of a function module or communication module.

It requires a 24 V DC external power supply.



Type of optional function	Thermal overload alarm	Motor load indication
Compatible with LUCA	NO	NO
Compatible with LUCL	NO	NO
Compatible with LUCB, LUCD	YES	YES
Compatible with LUCM	NO	YES
Output signal	1 NO	4...20 mA
Reset	NA	NA
References	LUFW10	LUFV2



TeSys rotating handles for	TeSys U
IP54 kit black handle	LU9APN21
IP54 kit red handle and yellow front	LU9APN22
IP65 kit red handle and yellow front	LU9APN24

Communication modules



Type of communication	Modbus	Modicon STB	CANopen	DeviceNet	Parallel wiring
Only compatible with 24 V DC control units LUCA..BL, LUCB..BL, LUCD..BL, LUCM..BL	YES	YES	YES	YES	YES
Transfer speed	19.2 Kbps	Dpg. on NIM (1)	20 K...1 Mbps	125...500 Kbaud	NA
Number of slaves	31 per Modbus master	Dpg. on Network Interface Module	128 per CANopen module	63 per DeviceNet module	8 per LU9GC02 splitter box
Pre-wired coil connection (A1 A2)	LU9BN11C, LU9MRC	LU9BN11L, LU9MRL	LU9BN11L, LU9MRL	LU9BN11L, LU9MRL	LU9Rxx
Connecting cable to PC	VW3 A8 306 R●● LU9RDD●●	LU9RCD●●	TSXCANC●●	DeviceNet standard	TSXCDP●●●
References	LUFC033	LULC15	LULC08	LULC09	LUFC00

(1) Transmission speed depending on the Network Interface Module.

Information carried by the Modbus, Modicon STB or CANopen bus		
Type of control unit	LUCBT1BL, LUCDT1BL	LUCMT1BL
Start and Stop commands	X	X
Starter status (ready, running, fault)	X	X
Thermal alarm	X	X
Remote reset via the bus	X	X
Indication of motor load	X	X
Signalling and fault differentiation	X	X
Alarms (overcurrent, ...)		X
Remote programming and monitoring of all the functions		X
"Log" function		X
Monitoring function		X



Starters

		D.O.L.				
		■ standard				
Standard power ratings of 3-phase motors in category AC3 400/415 V		4...37 kW	0.06...37 kW	0.55...30 kW	0.37...5.5 kW	0.25...45 kW
Starters	Manual	●	●	●	-	-
	Auto	-	-	-	●	●
Isolating device	Switch-disconnector-fuse	●	-	-	-	-
	Circuit-breaker	-	●	●	●	-
	Fuse carrier	-	-	-	-	-
Protection	Short-circuit	-	●	●	●	-
	Overload	-	●	-	●	●
Communication		-	-	-	-	-
Basic reference	Non-reversing	V•F•GE	GV2ME	GV2LC	LE1GVME	LE1M
		VCFN•GE	GV3PC	GV-NGC		LE1D
	Reversing	V•FXGE•	GV3CE			LE2K
						LE2D



					2 stage		
	■ safety applications			■ AS-Interface bus		standard star-delta	
2.2...45 kW	0.06...11 kW	0.06...9 kW	0.06...9 kW	0.06...5.5 kW	5.5...132 kW	7.5...75 kW	
-	●	-	-	-	-	-	
●	-	●	●	●	●	●	
-	-	●	-	-	-	-	
-	●	●	●	●	-	-	
●	-	-	-	-	-	●	
●	●	●	●	●	-	●	
●	●	●	●	●	●	●	
-	-	-	-	●	-	-	
LE4K	GV2ME	LG1K	LG7K	LF3M	LE3K	LE6D	
LE4D		LG1D	LG7D	LF3P	LE3D	LE3D	
			LJ7K	LF7P	LE3F		
LE8K			LG8K	LF4M			
LE8D			LJ8K	LF4P			
LE2D				LF8P			

Selection guide



For more information:
<http://www.schneider-electric.com>

Universal Enclosures

Spacial Steel

Boxes

From 74 x 74 mm
 to 720 x 540 mm



- SBM** Industrial boxes
- S44** Industrial boxes IP 66
- S57** Screw fixed cover boxes IP 66
- S24** Safety boxes IP 55

Wall-mounting enclosures

From 300 x 200 mm
 to 1200 x 1000 mm



- S3D** Wall-mounting steel
- S3DB** Terminal enclosures
- S3DBFL** Terminal enclosures
with FL21 cut-out
- S3DM** Distribution modular enclosures
- VDM** 19" enclosures
- S3DEX** Potentially explosive atmospheres
- S3HF** Electromagnetic compatibility

Floor-standing enclosures

From 500 x 500 mm
 to 2200 x 1600 mm



- SM** Floor-standing compact
- SF** Floor-standing suitable for:
 - Compartmentalised application
 - Electronic application
 - Prisma Plus application
 - Automobile application

Human-Machine Interface enclosures



- S3CM** Control enclosures with suspension system
- SD** Compact control desks
- SDF** Control desks with console
- SF** PC rack

ClimaSys







Thermal management







CV-CA
Ventilation/Airing



CE
Exchangers

<p>Spacial Stainless steel</p>	<p>Thalassa Insulating material</p>
	 <p> PLS Insulating modular boxes TBP Polycarbonate industrial boxes TBS ABS industrial boxes </p>
 <p> S3X Wall-mounting S3XEX Potentially explosive atmospheres </p>	 <p> PLM Wall-mounting polyester PLMEX Potentially explosive atmospheres </p>
 <p> SMX Floor-standing monobloc SFX Floor-standing </p>	 <p> PLA Floor-standing polyester PLD Floor-standing DIN polyester </p>
 <p> SDX Control desk SMX PC rack </p>	

 <p>CU Cooling Units</p>	 <p>CR Resistance Heaters</p>	 <p>CC Thermal control</p>	 <p>ProClima 5.0 Thermal software</p>
--	---	---	---

 <p>Spacial.pro Graphic configurator</p>	 <p>Digital Rules Enclosure selector</p>	 <p>Spacial.conf Services configurator</p>
--	--	--

Selection guide

 For more information:
<http://www.schneider-electric.com>

Power distribution and connection systems

Power busbars

Device feeders

⇒ *Applications:*

This power busbar system is designed for distributing the power vertically to device feeders or as a horizontal device feeder for circuit-breakers, motor controllers, etc.

⇒ *Applications:*

These device feeder systems are designed for feeding the power to modular and non-modular protection devices on single or multiple DIN rail rows.

Lineryg BZ

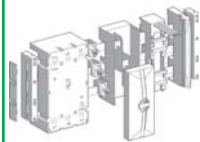

Lineryg FH



Lineryg FT

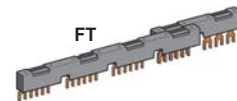

Lineryg FM



Lineryg HK

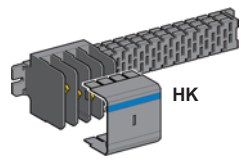

Description

630 A/60 mm busbar system for connection of circuit-breakers, contactors, motor controllers, etc. using a range of snap-on mounting plates and snap-on cable connectors. Suitable for both horizontal and vertical power distribution.

Insulated comb busbars, with accessories. FT simplifies cabling of TeSys motor starters. FH is specifically for Acti 9 miniature circuit-breakers, even when lateral auxiliaries are mounted.

Insulated busbars, with spring connectors and accessories. Quick connection simplifies phase balancing.

Insulated busbars, with plug-in pre-wired connectors and mounting plates, accessories.

Hot-plug: Safely plug-in and unplug live connectors.

Characteristics

Rating

630 A

63 to 100 A

63, 80, 160 A

160 A

Connection technology

Cabling range (mm²)

Standards and certifications

IEC - UL







IEC

IEC - UL

IEC

IEC - UL

4

Distribution blocks			Terminal blocks			
<p>⇒ <i>Applications:</i> The wired power distribution is a flexible solution for feeding various components when their electrical connections are on multiple levels.</p>			<p>⇒ <i>Applications:</i> Screw, spring and push-in modular terminal blocks and earth/neutral bars offer a universal solution when a reliable and simple connection is needed in distribution and control panel boards.</p>			
Linery DX	Linery DS	Linery BS	Linery TRV	Linery TRR	Linery TRP	Linery TB
						
Quick distribution block, for flexible or rigid cables. Installation on rail (63 A) or mounting plate (125, 160 A)	Single and four pole multistage distribution blocks. Lateral upstream cable terminals for easier connection. Installation on DIN rail or mounting plate	Multistage distribution blocks. Plain or threaded holes in copper bars. Cabling accessories. Horizontal or vertical mounting.	Common range of accessories Copper bars with plain or threaded holes.	Common range of accessories For extra reliable connections	Common range of accessories Single-handed installation	Various lengths, accessories.
63, 125, 160 A	100, 125, 160, 250 A	160, 250, 400, 630 A	Up to 309 A (IEC), 300 A (UL-CSA)	Up to 76 A (IEC), 85 A (UL-CSA)	Up to 20 A (IEC-UL-CSA)	
Spring	Screw	Screw	Screw	Spring	Push-in	Spring/screw
6 to 16	1.5 to 120	M6 holes, 16 to 50 mm ²	0.18 to 150	0.16 to 16	2.5, 4	2.5 to 16
IEC	IEC	IEC	IEC - UL	IEC - UL	IEC - UL	IEC

Selection guide

 For more information:
<http://www.schneider-electric.com>

4

Incoming protection and switching

⇒ *Applications:*
 On-load switching of motors, resistive and inductive loads.

⇒ *Applications:*
 Control and disconnection of electrical distribution circuits.

TeSys Vario



Compact



Description		Switch disconnectors Rotary switch with fully visible breaking	Switch disconnectors
	Isolation and Disconnection	●	
	Protection	-	
Characteristics	Rated operational current (A)	12 to 175	40 to 2500
	Number of poles	3 to 6	3 and 4
	Short-circuit making capacity at 400 V I _{cm} (kA)	0.5 to 3	50 to 220
	Product name	V	INS
	Embedded metering		
Standards and certifications		IEC 60947-3 UL508	IEC 60947-3 UL508

<p>⇒ <i>Applications:</i> Protection and switching of motors.</p>	<p>⇒ <i>Applications:</i> Protection in industrial and tertiary applications.</p>	<p>⇒ <i>Applications:</i> Feeder protection and circuit disconnection for multistandard motor circuit design.</p>	<p>⇒ <i>Applications:</i> Power circuit protection and disconnection in industrial, infrastructure and building applications.</p>
<p>TeSys GS</p> 	<p>NG</p> 	<p>Powerpact</p> 	<p>Compact</p> 
<p>Switch fuse disconnectors</p>	<p>Circuit-breakers</p>	<p>Moulded case circuit-breakers with optional integrated communication and metering possibilities.</p>	
<ul style="list-style-type: none"> ● 	<ul style="list-style-type: none"> ● 		
<ul style="list-style-type: none"> ● 	<ul style="list-style-type: none"> ● 		
<p>32 to 1250</p>	<p>10 to 125</p>	<p>15 to 600</p>	<p>16 to 3200</p>
<p>5 to 90</p>	<p>10 to 50</p>	<p>18 to 65</p>	<p>25 to 150</p>
<p>GS</p>	<p>NG125</p>	<p>NH, NJ, NL</p>	<p>NSX/NS</p>
		<p>Micrologic metering adapters</p>	
<p>IEC 60947-3</p>	<p>IEC 60947-2</p>	<p>IEC 60947-2 UL508</p>	<p>IEC 60947-2</p>

Selection guide

 For more information:
<http://www.schneider-electric.com>

Short-circuit and overload protection

⇒ *Applications:*
 DC circuit protection and disconnection:
 DC power supplies, generators, batteries, etc.

⇒ *Applications:*
 AC circuit protection and disconnection colon machines, electrical distribution in buildings.

Acti 9

Multi 9

Acti 9

Multi 9





Description		Miniature circuit-breaker	Miniature circuit-breaker	Miniature circuit-breaker	Miniature circuit-breaker	
Characteristics	Voltage	60 V DC/pole	250 V DC/pole	230 / 400 V AC		
	Number of poles	1 or 2		1, 2, 3 and 4		
	Nominal current (A)	1 to 63			80 to 125	
	Breaking capacity (kA)	6	6	10		
	Type of loads / Tripping curve (1)	B, C, D		C	B, C, D	
	Width	18 mm/pole			27 mm/pole	
	Product reference	IEC	Acti 9 iC60N	Acti 9 C60H-DC	Acti 9 iC60N	Multi 9 C120N
		IEC/UL	Multi 9 C60N	Multi 9 C60H-DC	Multi 9 C60N	

(1) Tripping curve: B (3 I_n < I_m < 5 I_n) standard.
 C (5 I_n < I_m < 10 I_n) inrush current.
 D (10 I_n < I_m < 14 I_n) electronics or long cable length.

4

Earth leakage protection

Surge protection

				Earth leakage protection			Surge protection		
⇒ Applications: Protection and disconnection of electrical circuits				⇒ Applications: Protection of operators against electrical shocks in event of direct or indirect contact with live equipment.			⇒ Applications: Protection of operators against electrical shocks in event of direct or indirect contact with live equipment.		
⇒ Applications: Protection of sensitive equipments against voltage surges due to lightning, high power switching, etc.				⇒ Applications: Protection of operators against electrical shocks in event of direct or indirect contact with live equipment.			⇒ Applications: Protection of sensitive equipments against voltage surges due to lightning, high power switching, etc.		
TeSys DF				Acti 9			Multi 9		
									
Fuse holder				RCBO (3)			RCCB (4)		
500 V AC		690 V AC		230/400 V AC					
				1P+N		2, 3 and 4P			
25	32	50	25	6 to 32			25 to 63		
8 x 32 mm	10 x 38 mm	14 x 51 mm	22 x 58 mm						
20		120					20		
				C class A 30 or 300 mA			C class A 30 or 300 mA		
				36 mm		27 to 63 mm		36 to 72 mm	
				Acti 9 DPN Vigi		Acti 9 Vigi iC60 blocks (2)		Acti 9 RCCB ID	
DF8		DF10		DF14		DF22		Multi9 GFP	
							Surge arrester		

Selection guide

 For more information:
<http://www.schneider-electric.com>

Indication and metering

Current transformers

Basic meters

⇒ *Applications:*

Current sensor: the current value is converted into a 0 to 5 A scale.

To be used with ammeter, power meter, energy metering.

⇒ *Applications:*

Display of simple electrical values, volts or amps. Meters for mounting on DIN rails.

⇒ *Applications:*

Display of simple electrical values, volts or amps. Meters for mounting on front panels.

CT



iVLT iAMP



VLT AMP



Description

Current transformers

Voltmeter
Ammeter

Voltmeter
Ammeter

Electrical indications

I / U

I / U

Characteristics

Measurement accuracy

Class 0.5 to 3

Class 1.5

Class 1.5

Installation

On conductor (cable, bar..)

DIN rail
4 x 18 mm modules

Flush mounted
72 x 72 mm / 96 x 96 mm

Voltage measurement

Maximum rated operational voltage:
720 V AC

VLT:
500 V AC direct or external VT

VLT:
500 V AC direct or external VT

Current measurement

Ranges from 40/5 A to 6000/5 A

AMP:
30 A direct or external CT

AMP:
external CT

Communication ports

–

–

–

Inputs / Outputs

–

–







–

Memory capacity

–

–

–

Basic energy meters			Basic multi-function metering			
⇒ <i>Applications:</i> Recording and display of energy consumption. The meters are mounted on a DIN rail.			⇒ <i>Applications:</i> Simple indication of the current passing through a Compact NSX circuit-breaker.	⇒ <i>Applications:</i> Full indication of electrical values and energy metering of a circuit protected by a Compact NSX circuit-breaker.	⇒ <i>Applications:</i> Full indication of electrical values and energy metering of a circuit.	
iEM2000 / iEM2010 / IEM2000T	iME1	iEM3000 Series	Micrologic A trip unit	Micrologic E trip unit	PM3200 / PM3210 / PM3250 / PM3255	PM5100 / PM5300 / PM5500
						
Kilowatt-hour meters	Kilowatt-hour meters	Kilowatt-hour meters	Ammeter	Power meter	Metering & sub-metering Class 0.5S IEC 62053-22 Class 1 IEC 62053-21 Class 2 IEC 62053-23	Metering & sub-metering Class 0.5S IEC 62053-22 Class 0.2S (PM55●●) IEC 62053-22 Class 1/2 IEC 62053-24
E			I	I, U, F, P, Q, S, PF, E	I, U, F, P, Q, S, PF, E (Power demand and current demand)	I, U, F, P, Q, S, PF, E (Power demand and current demand)
Class 1			Current: class 1	Current: class 1 Voltage: 0.5% Power: class 2	Class 0.5	Class 0.2S (PM55●●) Class 0.5S
DIN rail 1.2 or 4 x 18 mm modules			Embedded into circuit-breaker. Remote LCD display available	Embedded into circuit-breaker, remote LCD display available	DIN rail	Flush mounted 96 mm x 96 mm
400 V AC direct				690 V AC	50 V to 330 V AC (Ph-N) 80 V to 570 V AC (Ph-Ph) up to 1 MV AC (ext. VT)	20 V L-N / 35 V L-L to 277 V L-N / 480 V L-L / 600 V L-L (PM55●●)
40 to 63 A direct or external CT			0.2 x In 1.2 x In of circuit-breaker	0.2 x In 1.2 x In of circuit-breaker	External CT	External CT
–			1	1	1	2
–			–	–	–	4 I/O 6 I/O (PM55●●)
–			–	–	–	256 KB 1.1 MB (PM55●●)

5

Schneider Electric offers complete and compact ranges of power supplies (switch mode or filtered rectified) and transformers. With the Phaseo range, your installations will be equipped with a high quality AC or DC power supply compliant with international standards.

Phaseo

Phaseo offers universal power supplies and protection modules with a very wide operating range to provide continuity of service for your installations. An innovative offer, Phaseo integrates numerous features which set the standard across this market.



5 | Power supplies

 This document is a selection of the top selling products.
For more information:
<http://www.schneider-electric.com>

Power supplies

Regulated switch mode power supplies and accessories	
Phaseo ABL8, ABL7, ABL4, ABL1	5/2 to 5/5
Filtered rectified power supplies	
Phaseo ABL8	5/5

Transformers

Phaseo ABL6, ABT7	5/6
--------------------------------	-----



Type of power supply	7 to 60 W Single-phase					
Rated input voltage	100...240 VAC					
Rated output voltage	24 V			5 V		12 V
Rated power / Rated output current	7.5 W / 0.3 A	15 W / 0.6 A	30 W / 1.2 A	60 W / 2.5 A	20 W / 4 A	25 W / 2 A
Reset	Auto					
Conformity to IEC 61000-3-2	Without					
Certifications	cULus, cCSAus, TUV, CE, C-Tick					
Dimensions W x D x H (mm)	36 x 59 x 90		54 x 59 x 90	72 x 59 x 90	54 x 59 x 90	
Fixing (mm)	DIN rail 35x7.5 or 35x15 or on panel mount by screw					
References	ABL8MEM24003	ABL8MEM24006	ABL8MEM24012	ABL7RM24025	ABL8MEM05040	ABL8MEM12020



5

Type of power supply	72 to 240 W Single-phase - Wide input range		
Rated input voltage	100...120 VAC and 200...500 VAC		
Rated output voltage	24 V		
Rated power / Rated output current	72 W / 3 A	120 W / 5 A	240 W / 10 A
Permissible temporary inrush current (boost)	1.5 In during 4 s		
Reset	Auto or manual		
Conformity to IEC 61000-3-2	Yes		
Diagnostic relay (output voltage > 21.6V)	No	Yes	
Certifications	cCSAus, CB scheme, CE		
Dimensions W x D x H (mm)	44 x 120 x 143	56 x 120 x 143	85 x 140 x 143
Fixing (mm)	DIN rail 35x7.5 or 35x15		
References	ABL8RPS24030	ABL8RPS24050	ABL8RPS24100

Regulated, switch mode
Compact - Rail mounting



Type of power supply	85 to 480W Single-phase			
Rated Input Voltage AC	120...230V 50/60Hz		120/230V	
Rated Input Voltage DC	100...370V		300...350 V	
Rated adjustable output Voltage	23...27,5 V			24...28V
Rated power / Rated output current	84W / 3,5A	120W / 5A	240W / 10A	480W / 20A
Temporary permissible inrush current output	6A for 30s	8A for 30s	15A for 30s	30A for 5s
Reset after overload	Auto			
Diagnostic relay (output voltage > 21.6V)	Yes			
Fixing (mm)	DIN rail 35 x 7,5			
Dimensions W x D x H (mm)	39 x 115 x 134		64 x 140 x 139	80 x 127 x 146
References	ABL4RSM24035	ABL4RSM24050	ABL4RSM24100	ABL4RSM24200



60 to 144 W single-phase

100...240 VAC			
24 V		12 V	
72 W / 3 A	120 W / 5 A	60 W / 5 A	48 V
Auto		Auto or manual	
No		Yes	
cULus, cCSAus, TUV, CE, C-Tick			
27 x 120 x 120		54 x 120 x 120	
DIN rail 75x7.5, 35x7.5 or 35x15			
ABL8REM24030	ABL8REM24050	ABL7RP1205	ABL7RP4803



480 to 960 W single and 3-phases

100...120 VAC and 200...240 VAC	3 x 380...500 VAC	
24 V		
480 W / 20 A	960 W / 40 A	
1.5 In during 4 s		
Auto or manual		
Yes		
Yes		
cCSAus, CB scheme, CE		
145 x 140 x 143	95 x 155 x 143	165 x 155 x 143
DIN rail 35x7.5 or 35x15		
ABL8RPM24200	ABL8WPS24200	ABL8WPS24400

Type of module

Converters DC/DC

Compatibility	Output connection of power supplies ABL8RPS24..., ABL8WPS24..., ABL4RSM24... and ABL4WSR24...	
Rated output voltage	5 V	12 V
Rated output current	6 A	2 A
Certifications	cCSAus, CB scheme, CE	
Dimensions W x D x H (mm)	44 x 140 x 146	
Fixing (mm)	DIN rail 35x7.5 or 35x15	
References	ABL8DCC05060	ABL8DCC12020

5



Type of power supply

480 to 960W 3-phase

Rated Input Voltage AC	400 ... 500V 50/60 Hz		
Working on 2 phases	Possible with output current = 75% of the nominal output current.		
Output Voltage	24V		
Rated power / Rated output current	480W / 20A	720W / 30A	960W / 40A
Temporary permissible inrush current output	30A for 5s	45A for 5s	60A for 5s
Reset after overload	Auto		
Diagnostic relay	Yes		
Fixation (mm)	DIN rail 35 x 7,5		
Dimensions W x D x H (mm)	80 x 127 x 146		
References	ABL4WSR24200	ABL4WSR24300	ABL4WSR24400

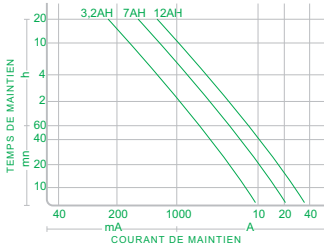

Type of module	Microcuts and cuts network solutions. (1)		
Compatibility	Output connection of Universal power supplies ABL8RPS24..., ABL8WPS24..., ABL4RSM24..., ABL4WSR24...		
Technology	Buffer module	battery backup module + battery	
Rated output voltage	40 A	20 A	40 A
Holding time 1A	2 s typique	adjustable from 10 s to 24 H (battery depending)	
Holding time for maximum current output	100 ms typique	adjustable from 10 s to 30 mn (battery depending)	adjustable from 10 to 10 mn (battery depending)
Certifications	cCSAus, CB scheme, CE		
Dimensions W x D x H (mm)	85 x 140 x 146	86 x 175 x 143	86 x 175 x 143
Fixing (mm)	DIN rail 35x7.5 or 35x15 (1)		
References Control module	ABL8BUF24400	ABL8BBU24200	ABL8BBU24400
References battery	3,2AH (2)	ABL8BPK24A03	ABL8BPK24A03
	7AH (2)	ABL8BPK24A07	ABL8BPK24A07
	12AH (2)	ABL8BPK24A12	ABL8BPK24A12

(1) Battery module except 7AH and 12AH. For battery module 3.2AH with ABL1A02 kit.

(2) Battery to be chosen according to the graph above.

5



Type of module	Redundancy power supplies solutions
Compatibility	Connection of 2 power supplies inputs ABL4... or ABL8RP, ABL8WP up to 20 A (1 power supply 40A)
Rated output voltage	24 V
Rated output current	40 A
Certifications	cCSAus, CB scheme, CE
Dimensions W x D x H (mm)	44 x 140 x 146
Fixing (mm)	DIN rail 35x7.5 ou 35x15
References	ABL8RED24400

Type of module	Starter protection solution
Compatibility	Output connection of Universal power supplies ABL8RPS24100..., ABL8RPM24200..., ABL8WPS24..., ABL4RSM24... and ABL4WSR24...
Rated output current	10A par voie
Calibres	1 / 2.5 / 4 / 5 / 7 / 8 / 10 A
Number of channels	4
Diagnostic relay	Yes
Manual switch off (1 per channel)	Two-pole
Certifications	cCSAus, CB scheme, CE
Dimensions (mm)	71 x 109 x 110
Fixing (mm)	DIN rail 35x7.5 or 35x15 or on panel mount by screw
References	ABL8PRP24100



Type of power supply		60W to 240W					
Input voltage		85...264 VAC			85...132 VAC / 170...264 VAC		
Output voltage		12 VDC		24 VDC		24 VDC	
Rated power / Rated output current		60 W / 5 A	100 W / 8.3 A	60 W / 2.5 A	100 W / 4.2 A	150 W / 6.2 A	240 W / 10 A
Certifications		UL, c CSA us, CE, Ctick					
Dimensions W x D x H (mm)		150 x 38 x 98	200 x 38 x 98	150 x 38 x 98	200 x 38 x 98	200 x 50 x 98	200 x 65 x 98
Fixing (mm)		Panel mount by screw, by bracket ABL1A01 (1), on DIN rail 35mm by panel ABL1A02 (1).					
References	Without filter	ABL1REM12050	–	ABL1REM24025	ABL1REM24042	ABL1REM24062	ABL1REM24100
	With filter (2)	–	ABL1RPM12083	–	ABL1RPM24042	ABL1RPM24062	ABL1RPM24100

(1) To be ordered separately.

(2) Anti harmonic IEC/EN 61000-3-2

Filtered rectified



5

Type of power supply		12W to 480W single-phase							
Input voltage		215/230/245 V or 385/400/415 VAC							
Rated output voltage		24 V							
Certifications		cULus, ENEC							
Rated power / Rated output current		12 W / 0.5 A	24 W / 1 A	48 W / 2 A	96 W / 4 A	144 W / 6 A	240 W / 10 A	360 W / 15 A	480 W / 20 A
Dimensions W x D x H (mm)		87 x 124 x 108	87 x 124 x 108	87 x 142 x 108	87 x 165 x 108	123 x 153 x 153	123 x 185 x 153	135 x 185 x 138	175 x 215 x 128
Fixing (mm)		DIN rail 35x7.5 or 35x15 or on panel mount by screw				On panel mount by screw			
References		ABL8FEQ24005	ABL8FEQ24010	ABL8FEQ24020	ABL8FEQ24040	ABL8FEQ24060	ABL8FEQ24100	ABL8FEQ24150	ABL8FEQ24200



Type of power supply		240W to 1440W 3-phases				
Input voltage		3x 380 / 400 / 420 V				
Rated output voltage		24 V				
Certifications		cULus, ENEC				
Rated power / Rated output current		240 W / 10 A	480 W / 20 A	720 W / 30 A	960 W / 40 A	1440 W / 60 A
Dimensions W x D x H (mm)		185 x 190 x 78	220 x 215 x 104	240 x 252 x 108	310 x 310 x 140	310 x 310 x 154
Fixing (mm)		On panel mount by screw				
References		ABL8TEQ24100	ABL8TEQ24200	ABL8TEQ24300	ABL8TEQ24400	ABL8TEQ24600



Type of transformer		Double winding operating temperature									
		+60°C									
Rated input voltage		230/400 VAC (±15 V) 1-phase									
Certifications		cULus, ENEC									
Rated power / Rated output current		25 VA	40 VA	63 VA	100 VA	160 VA	250 VA	320 VA	400 VA	630 VA	1000 VA
Visualization		LED display of voltage presence at primary									Without
Fixing (mm)		DIN rail 35x15 or on panel mount by screw					On panel mount by screw				
References		ABT7PDU**(1)									ABT7TDU**(1)
Rated output voltage	24/48 V	002B	004B	006B	010B	016B	025B	032B	040B	063B	100B
	115/230 V	002G	004G	006G	010G	016G	025G	032G	040G	063G	100G

(1) Complete the reference according to the power and voltage using the table below (example: ABT7PDU002G)

5



Type of transformer		Single winding operating temperature +50°C									
Rated input voltage		230/400 VAC (±15 V) 1-phase									
Certifications											
Rated output power		25 VA	40 VA	63 VA	100 VA	160 VA	250 VA	400 VA	630 VA	1000 VA	
Fixing (mm)		On panel mount by screw									
References		ABL6TS**(2)									
Rated output voltage	24 V	02B	04B	06B	10B	16B	25B	40B	63B	100B	
	115 V	02G	04G	06G	10G	16G	25G	40G	63G	100G	
	230 V	02U	04U	06U	10U	16U	25U	40U	63U	100U	

(2) Complete the reference according to the power and voltage using the table below (example: ABL6TS02G)



Type of transformer		Single winding operating temperature +40°C						
Rated input voltage		230 VAC (±15 V) 1-phase						
Certifications		Without						
Rated power / Rated output current		40 VA	63 VA	100 VA	160 VA	250 VA	320 VA	400 VA
Fixing (mm)		On panel mount by screw						
References		ABT7ESM**(3)						
Rated output voltage	24 V	004B	006B	010B	016B	025B	032B	040B

(3) Complete the reference according to the power and voltage using the table below (example: ABT7ESM004B)

6

From simple connectors to integrated I/O platforms, monobloc products to modular solutions, Modicon I/O presents an extensive range of interfaces and I/O for any application.

Modicon I/O

The compact dimensions and pre-wired system characteristic of the Modicon I/O range allow you to optimise installation time, minimise costs and the risk of error, as well as simplify maintenance.



6 | Interfaces and I/O



This document is a selection of the top selling products.

For more information:
<http://www.schneider-electric.com>

Distributed I/O

IP20

Optimum modular I/O system, for simple machines, **Modicon OTB** 6/2

Modular I/O system for complexes machines or installations, **Modicon TM5** 6/3 to 6/8

Modular I/O with device integration capabilities, **Modicon STB** 6/9 to 6/12

IP67

Modular I/O system for machines or installations in harsh environment, **Modicon TM7** 6/13

Distributed I/O with embedded control

IP20

Block I/O, **Modicon Momentum** 6/14 to 6/17

Pre-wired interfaces

IP20

Sub-bases, **Modicon ABE7** 6/18 to 6/20

IP67

Passive splitter boxes, **Modicon ABE9** 6/21

Accessories and cabling

Connection cables and jumper cables 6/22

Modicon OTB _____ IP 20 Distributed I/O, optimum system Interface modules



Discrete Type of bus	CANopen Machine bus	Ethernet TCP/IP network (2)	Modbus Series network
Number of I/Os	20 I/O		
Number of inputs	12 inputs 24 VDC IEC type 1		
Number of outputs	6 relay outputs and 2 solid state 24 VDC outputs		
Connection method	Removable terminal block		
Number of I/O expansion modules (1)	7 discrete or analogue input/output modules, or connection accessories		
Maximum I/O configuration	With interface module base: 132 with screw terminal I/O expansion; 244 with HE10 connector I/O expansion; up to 48 analogue channels		
Supply voltage	24 VDC		
Counting	5 kHz	2 channels, 32 bits (0...4 294 967 295 points) dedicated discrete inputs -up counting/down counting with preset	
	20 kHz	2 channels, 32 bits (0...4 294 967 295 points) up/down counting, up counting, down counting, frequency meter	
Pulse generator, 7 kHz	2 PWM function channels (output with pulse width modulation) or PLS function (pulse generator output)		
Dimensions W x D x H (mm)	55 x 70 x 90		
References	OTB1C0DM9LP	OTB1E0DM9LP	OTB1S0DM9LP

(1) For the references of discrete I/O and analogue expansion modules, please see www.schneider-electric.com

(2) Transparent Ready : Class A10

6

Accessories

Type of accessory	Commoning modules	Documentation
Usage	For grouping input or output commons, max 8 A	User guides for Modicon hardware and software, and Modicon Configuration Software for Modicon OTB/FTB/FTM. Provided on CD.
Positioning	Inter-module	–
Référence	OTB9ZZ61JP	FTXES01















Type of module	Bus base	CANopen electronic interface module	Power distribution electronic module	Terminal block
Max. number of addressable I/O modules	40 with 240 Digital Input, 240 Digital Output, 20 Input Analog & 20 Output Analog (1)			
Baud rate	10 K...1 Mbps			
Power supply	24 VDC			
Module color	White	White	Grey	Grey
Description	For TM5NCO1 and TM5SPS3 electronic modules	CANopen bus communication with CANopen protocol	For the CANopen bus interface and slice I/O expansion modules	12 spring terminals
References	TM5ACBN1	TM5NCO1	TM5SPS3	TM5ACTB12PS

(1) Only 3 configurations maximum on CANopen fieldbus

Digital and analogue I/O expansion blocks (2)



Type of module	Input		Output			
	Digital	Analog	Digital	Analog		
Number of inputs	12 sink	–	–	–	–	–
Number of outputs	–	–	–	12 source	4 relay	–
Number of inputs	–	4	4	–	–	–
Number of outputs	–	–	–	–	–	4
Nominal input current	24 VDC	–	–	–	–	–
Nominal output current	–	–	–	24 VDC	30 VDC/ 230 VAC	–
Type	–	Thermal probe	Voltage / Current	–	–	Voltage / Current
Associated bus sub-bases (3)	 TM5ACBM11	 TM5ACBM11	 TM5ACBM11	 TM5ACBM11	 TM5ACBM12	 TM5ACBM11
Associated terminal block (3)	 TM5ACTB12	 TM5ACTB12	 TM5ACTB12	 TM5ACTB12	 TM5ACTB32	 TM5ACTB12
References	TM5SDI12D	TM5SAI4PH	TM5SAI4L	TM5SDO12T	TM5SDO4R	TM5SAO4L

(2) Wide range of I/O expansion modules (digital I/O, analog, expert, non-functioning dummy, remote I/O modules...), please consult our catalogue pages on www.schneider-electric.com.

(3) To be ordered separately



Type of module	20 I/O Digital Compact block	36 I/O Digital Compact block	42 I/O Digital Compact block	24 I/O Digital/Analog Compact block
Digital input number	12	24	24	12
Digital input type	Sink	Sink	Sink	Sink
Analog input number	–	–	–	4
Analog input type	–	–	–	- 10...+ 10 VDC, 0...20 mA, 4...20 mA
Digital output number	8	12	18	6
Digital output type	Transistor	Relay with NO contact	Transistor	Transistor
Analog output number	–	–	–	2
Analog output type	–	–	–	- 10...+ 10 VDC, 0...20 mA
References	TM5C12D8T	TM5C24D12R	TM5C24D18T	TM5C12D6T6L

Type of module	16 I/O Analog Compact block	16 I/O Analog Compact block	16 I/O Analog Compact block
Analog input number	8	8	8
Analog input type	- 10...+ 10 VDC	0...20 mA, 4...20 mA	4 inputs : - 10...+ 10 VDC, 4 inputs : 0...20 mA, 4...20 mA
Analog output number	8	8	8
Analog output type	- 10...+ 10 VDC	0...20 mA, 4...20 mA	4 inputs : - 10...+ 10 VDC, 4 inputs : 0...20 mA, 4...20 mA
References	TM5CAI8O8VL	TM5CAI8O8CL	TM5CAI8O8CVL







6

IP 20 Distributed I/O, modular system PCI modules









Type of module	PCI Serial link communication modules	Serial link communication modules	Profibus DP communication module
Physical layer	RS232	RS485	RS485
Protocol	Modbus / ASCII	Modbus / ASCII	Profibus DP Slave
Baud Rate	115,2 kbit/s max.	115,2 kbit/s max.	12 Mbit/s max.
Connector	D-Sub 9, male	D-Sub 9, male	SUB-D connector (male 9-way)
References	TM5PCRS2	TM5PCRS4	TM5PCDPS





Type of module	Analog Input	Analog Input	Analog Input
Type	Voltage / Current	Voltage / Current	Pt100 / Pt1000 temperature probe
Range	- 10...+ 10 VDC 0...20 mA 4...20 mA	- 10...+ 10 VDC 0...20 mA 4...20 mA	- 200...+ 850°C
Resolution	12 bits + sign	15 bits + sign	16 bits
Associated bus sub-bases (3)	 TM5ACBM11	 TM5ACBM11	 TM5ACBM11
Associated terminal block (3)	 TM5ACTB12	 TM5ACTB12	 TM5ACTB12
References	2 channels 4 channels	TM5SAI2L TM5SAI4L	TM5SAI2H TM5SAI4H
		TM5SAI2PH	TM5SAI4PH









Type of module	Analog Output	Analog Output	Analog Input
Type	Voltage / Current	Voltage / Current	J, K, S, N thermocouple
Range	- 10...+ 10 VDC 0...20 mA	- 10...+ 10 VDC 0...20 mA	Type J : - 210...+ 1200°C Type K : - 270...+ 1372°C Type S : - 50...+ 1768°C Type N : - 270...+ 1300°C
Resolution	12 bits + sign	15 bits + sign	16 bits
Associated bus sub-bases (3)	 TM5ACBM11	 TM5ACBM11	 TM5ACBM11
Associated terminal block (3)	 TM5ACTB12	 TM5ACTB12	 TM5ACTB12
References	2 channels 4 channels	TM5SAO2L TM5SAO4L	TM5SAI2TH TM5SAI6TH (6 channels)
		TM5SAO2H TM5SAO4H	



Type of module	Digital Inputs	Digital Inputs	Digital Inputs/Outputs
Supply voltage	24 VDC	100/240 VAC	24 VDC
Type of signal (1)	Sink	–	Sink / Source
Associated bus sub-bases (3)	 TM5ACBM11	 TM5ACBM12	 TM5ACBM11
Associated terminal block (3)	 TM5ACTB12	 TM5ACTB32	 TM5ACTB12
References	2 channels 4 channels 6 channels 12 channels	TM5SDI2D TM5SDI4D TM5SDI6D TM5SDI12D	– TM5SDI2A TM5SDI4A TM5SDI6U – TM5SDM12DT

6











Type of module	Digital Outputs	Digital Outputs	Output analog
Supply voltage	24 VDC	24 VDC	30 VDC / 230 VAC
Type of signal (1)	Source	Source	Relay
Associated bus sub-bases (3)	 TM5ACBM11	 TM5ACBM11	 TM5ACBM12
Associated terminal block (3)	 TM5ACTB12	 TM5ACTB12	 TM5ACTB32
References	2 channels 4 channels 6 channels 12 channels	– TM5SDO2T TM5SDO4TA TM5SDO6T –	– TM5SDO2R TM5SDO4R – –

IP 20 Distributed I/O, modular system



Expert and other modules



Type of module	Expert module	Expert module	Expert module	Expert module
Number of channels	2	1 or 2	1	1
Max. frequency	50 kHz	100 kHz	250 kHz	1 MHz
Signal	Sink	Sink	Sink	Sink
Integrated functions	Event counting Interval measurement	2 x 24 VDC auxiliary inputs 24 VDC encoder power supply	2 x 24 VDC auxiliary inputs 5 VDC encoder power supply	2 x 24 VDC auxiliary inputs 5 VDC SSI encoder power supply
Associated bus sub-bases (3)	 TM5ACBM11	 TM5ACBM11	 TM5ACBM11	 TM5ACBM11
Associated terminal block (3)	 TM5ACTB12	 TM5ACTB12	 TM5ACTB12	 TM5ACTB12
References	TM5SDI12DF	TM5SE1IC1024 TM5SE2IC1024	TM5SE1IC02505	TM5SE1SC1005



6

Type of module	Expert module
Number of channels	1
Sensor range	85...5000 Ω
Resolution	24 bits
Measurement type	Full-bridge strain gauge
Associated bus sub-bases (3)	 TM5ACBM11
Associated terminal block (3)	 TM5ACTB12
References	TM5SEAISG



Type of module	CANopen Fieldbus Interface module	Digital Inputs	Digital Outputs	Digital Outputs
Number of channels	–	12	12	4
Power Supply	–	24 VDC	24 VDC	30 VDC / 230 VAC
Type of signal	–	Sink	Source	Relay
Type of wiring	–	1-wire	1-wire	NO/NC contact
Composition of the kit	TM5ACBN1 + TM5ACTB12PS + TM5NCO1 + TM5SPS3	TM5ACBM11 + TM5ACTB12 + TM5SDI12D	TM5ACBM11 + TM5ACTB12 + TM5SDO12T	TM5ACBM12 + TM5ACTB32 + TM5SDO4R
References	TM5NCO1K	TM5SDI12DK	TM5SDO12TK	TM5SDO4RK



Type of module	Analog Input	Analog Output	Analog Input
Number of channels	4	4	4
Type	Voltage / Current	Voltage / Current	Pt100 / Pt1000 temperature probe
Range	- 10...+ 10 VDC 0...20 mA 4...20 mA	- 10...+ 10 VDC 0...20 mA	- 200...+ 850°C
Resolution	12 bits + sign	12 bits + sign	16 bits
Composition of the kit	TM5ACBM11 + TM5ACTB12 + TM5SAI4L	TM5ACBM11 + TM5ACTB12 + TM5SAO4L	TM5ACBM11 + TM5ACTB12 + TM5SAI4PH
References	TM5SAI4LK	TM5SAO4LK	TM5SAI4PHK

6



Type of module		PDM				Auxiliary Power supply	
Connection by removable terminals		Screw STBXTS1130 (2) (3) Spring STBXTS2130 (2) (3)				Screw STBXTS1120 (2) Spring STBXTS2120 (2)	
Supply voltage		24 VDC				115...230 VAC	
Maximum current	Inputs (4)	4 A at 30°C, 2.5 A at 60°C		–		5 A at 30°C, 2.5 A at 60°C	
	Outputs (4)	8 A at 30°C, 5 A at 60°C		–		10 A at 30°C, 5 A at 60°C	
	Inputs/Outputs (4)	–		4 A at 30°C, 2.5 A at 60°C		–	
	Logic internal 5 V	–		–		4 A at 30°C, 2.5 A at 60°C	
Sensor/actuator bus voltage range		19.2...30 VDC				85...265 VAC	
Dimensions W x D x H (mm)		18.4 x 70 x 128.3				–	
Reference	Module (5)	Standard	STBPDT3100K	–	STBPDT2100K	–	STBCPS2111K
		Basic	–	STBPDT3105K	–	STBPDT2105K	–
	Base	STBXBA2200	–	STBXBA2200	–	STBXBA2100	–

- (1) For power supplies see chapter 5.
- (2) To be ordered separately, sold in lots of 10.
- (3) PDM connector keying pin kit STBXMP7810.
- (4) PDM fuse kit STBXMP5600.
- (5) Kit reference including module, base and terminal.
Base and terminals can be ordered separately as spare parts.

Bus extension modules for standard range



Type of module		“EOS” End of segment	“BOS” Beginning of segment	Extension for CANopen connection devices	
Connection by removable terminals		–	Screw STBXTS1120 (1) Spring STBXTS2120 (1)	Screw STBXTS1110 (2) Spring STBXTS2110 (2)	
Use		For placing at end of segment (except for the last)	For placing at head of each extension segment	For placing at end of last segment	
Dimensions W x D x H (mm)		18.4 x 70 x 128.3			
Reference	Module (3)	Standard	STBXBE1100K	STBXBE1300K	STBXBE2100K
	Base	STBXBA2300K	STBXBA2400	STBXBA2000	STBXBA2000

- (1) To be ordered separately, sold in lots of 10.
- (2) To be ordered separately, sold in lots of 20.
- (3) Kit reference including module, base and terminal. Base and terminals can be ordered separately as spare parts.

Software and memory card



Type	Modicon STB, OTB, FTM, FTB configuration software (PC connection cable supplied)					Removable memory card
Software User Guide	Single station	3 pack	10 pack	Unlimited Site	System Alliance Integrator	–
Memory size	–					32 KB
Reference	STBSPU1000	STBSPU1003	STBSPU1011	STBSPU1130	STBSPU1010	STBXMP4440
Hardware User Guide	STBSUS8800					–

Connection accessories

Type of accessory	Island bus expansion cable				
Length	0.3 m	1 m	4.5 m	10 m	14 m
Reference	STBXCA1001	STBXCA1002	STBXCA1003	STBXCA1004	STBXCA1006
Type of accessory	Bus termination module or plug		Programming connection cable L= 2 m		
Reference	STBXMP1100		STBXCA4002		

Connection accessories: See www.schneider-electric.com



Type of module			Discrete inputs							
Connection by removable terminals (1)	Screw (2)		STBXTS1100		STBXTS1180		STBXTS1110			
		Spring (2)	STBXTS2100		STBXTS2180		STBXTS2110			
Number of channels			2	4	6	16	2	2 (isolated)	2	
Input voltage			24 VDC				115 VAC		230 VAC	
Dimensions W x D x H (mm)			13.9 x 70 x 128.3				18.4 x 70 x 128.3			
Reference	Module (6)	Standard	STBDDI3230K	STBDDI3420K	STBDDI3610K	–	STBDAI5230K	STBDAI5260K	STBDAI7220K	
		Basic	–	STBDDI3425K	STBDDI3615K	STBDDI3725KS/KC*	–	–	–	
	Base (3)		STBXBA1000			STBXBA3000		STBXBA2000		

* KS with base and screw terminals,
KC with base and spring terminals.

** Without base and terminals.
Base and terminals can be ordered separately as spare parts.



Type of module			Discrete solid state outputs						
Connection by removable terminals (1)	Screw (2)		STBXTS1100				STBXTS1180		
		Spring (2)	STBXTS2100				STBXTS2100		
Number of channels			2		4		6		16
Output voltage			24 VDC		24 VDC		24 VDC		24 VDC
Output current			0.5 A	2 A	0.25 A	0.5 A	0.25 A	0.5 A	0.5 A
Dimensions W x D x H (mm)			13.9 x 70 x 128.3						
Reference	Module (6)	Standard	STBDDO3200K	STBDDO3230K	–	STBDDO3410K	–	STBDDO3600K	–
		Basic	–	–	STBDDO3415K	–	STBDDO3605K	–	STBDDO3705KS/KC*
	Base (3)		STBXBA1000				STBXBA3000		

* KS with base and screw terminals,
KC with base and spring terminals.

** Without base and terminal.
Base and terminals can be ordered separately as spare parts.



Type of module			Discrete outputs			
			Triac		Relay	
Connection by removable terminals (1)	Screw (2)		STBXTS1100			
		Spring (2)	STBXTS2100			
Number of channels			2	2 (isolated)	2 NO/NC and common	2NC+NO
Output voltage			115...230 VAC		115 VAC	
Output current			2 A à 30°C, 1 A à 60°C		24 VDC ou 115...230 VAC	
Dimensions W x D x H (mm)			18.4 x 70 x 128.3			28.1 x 70 x 128.3
Reference	Module (6)	Standard	STBDAO8210K	STBDAO5260K	STBDRC3210K	STBDRA3290K
		Base (3)	STBXBA2000			STBXBA3000

(1) To be ordered separately, sold in lots of 20.

(2) I/O connector keying pin kit STBXMP7800.

(3) Module keying pin kit STBXMP7700.

(4) If connection on Telefast2 order STBXTS6510 or connection on Telefast Twido order STBXTS5510.

(5) If connection on Telefast2 order STBXTS6610 or connection on Telefast Twido order STBXTS5610.

(6) Kit reference including module, base and terminal except for STBDDI3725 and STBDDO3705. Base and terminals can be ordered separately as spare parts.

Connection accessories: See www.schneider-electric.com



Type of module (1)		Analog inputs (*)									
Connection by removable terminals		Screw STBXTS1100 (2) / Spring STBXTS2100 (2)									
Number of channels		2				4		8		2	
Input signal		- 10...+10 V	0...+10 V	0...20 mA	4...20 mA	4...20 / 0...20 mA	Selectable	Selectable	Multirange (3)		
Resolution		11 bits + sign	10 bits	12 bits	10 bits	15 bits + sign					
Dimensions W x D x H (mm)		13.9 x 70 x 128.3				18.4 x 70 x 128.3				13.9 x 70 x 128.3	
Reference	Module (8)	Standard	-	-	STBACI1230K	-	STBACI0320K	STBAVI0300K	STBACI1400K (5)	STBART0200K	
		Basic	-	-	-	-	STBACI8320K (4)	-	STBAVI1400K (6)	-	
	Base	STBXBA1000				STBXBA2000				STBXBA1000	

(*) For other references, please see: www.schneider-electric.com

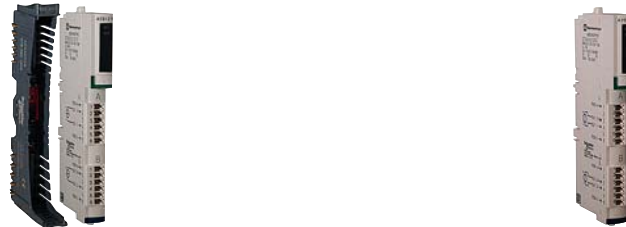

Type of module (1)		Analog outputs								
Connection by removable terminals		Screw STBXTS1100 (2) / Spring STBXTS2100 (2)								
Number of channels		1		2						
Output signal		4...20 mA	0...+10, -10...+10 V	0...+10 V	-10 V...+10 V	0...20 mA	4...20 mA	4...20 mA	Selectable (6)	
Resolution		15 bits + sign	11 bits + sign or 12 bits	10 bits	9 bits + sign	12 bits	10 bits	15 bits + sign		
Dimensions W x D x H (mm)		18.4 x 70 x 128.3		13.9 x 70 x 128.3				18.4 x 70 x 128.3		
Reference	Module (8)	Standard	STBACO0120K	STBAVO1250K	-	-	STBACO1210K	-	STBACO0220K	STBAVO0200K
		HART compliant	-	-	-	-	-	-	STBACO8220K (7)	-
	Basic	-	-	STBAVO1255K	STBAVO1265K	-	STBACO1225K	-	-	
Base		STBXBA2000		STBXBA1000				STBXBA2000		

Application-specific modules



Type of module (1)		For motor starters TeSys model U		Counter		HART Interface module	
Connection by connector		4 RJ45		Spring STBXTS2150 (2)		Spring STBXTS2150	
Number of inputs/outputs		12 I / 8 O		4 I / 2 O		-	
Input voltage		24 VDC		24 VDC		-	
Output voltage/current		24 VDC/0.1 A per channel		24 VDC/0.5 A		-	
Number of channels		4 starters-controllers		1 counter channel 40 kHz		4 channels compatible with 4...20mA HART signals	
Dimensions W x D x H (mm)		28.1 x 70 x 128.3				28.1 X 70 X 128.3	
Reference	Module (8)	Standard		STBEPI2145K		STBEHC3020K	
	Base			STBXBA3000		STBXBA3000	
	Connection cables		(9)		-		-

(1) Grounding kit (recommended for counter > 40 kHz): STBXSP3000 (connecting support) + STBXSP3010 (1.5...6 mm² cables) + STBXSP3020 (5...11 mm² cables)

(2) To be ordered separately, sold in lots of 20. (3) Multirange temperature probe thermocouples B, E, J, K, R, S, T. Thermal probe Pt 100, Pt 1000, Ni 100, Ni 1000, cu 10, ± 80 mV.

(4) 4 HART-tolerant channels (5) Input signal selectable / channel 0...20 mA and 4...20 mA (6) Input signal selectable / channel 1...5 VDC, 0...5 VDC, 0...10 VDC, ± 5 VDC and ± 10 VDC

(7) 2 Hart compliant channels. (8) Kit reference including module, base and terminal

(9) LU9R03 (0,3 m), LU9R10 (1 m), 490NTW00002 (2 m), LU9R30 (3 m), 490NTW00005 (5 m), 490NTW00012 (12 m)



Type of module	CANopen interface blocks with digital I/O		
Number of channels	8 I/O	16 I/O	16 I/O
Number, type of inputs	8 sink (1)	16 sink (1)	16 sink (1)
Number, type of outputs	8 transistor / source (2)	16 transistor / source (2)	16 transistor / source (2)
Sensor / actuator connection	8 female M8 connectors	16 female M8 connectors	8 female M12 connectors
Communication bus	CANopen TM7 bus		
References	TM7NCOM08B	TM7NCOM016B	TM7NCOM016A

(1) Sink inputs: positive logic

(2) Source outputs: positive logic

Digital I/O expansion blocks



Type of module	Analog I/O expansion blocks		
Input voltage	24 VDC IEC type 1		
Output voltage	24 VDC		
Type of inputs	Sink (positive logic)		
Type of outputs	Transistor / source (positive logic)		
Diagnostics	By expansion block, channel, communication on TM7 bus		
Communication bus	TM7 bus		
Output current	0.5 A		2A
Sensor / actuator connection	M8 connectors	M12 connectors	M8 connectors
References	8 inputs TM7BDI8B	–	–
	8 configurable I/O TM7BDM8B	–	–
	16 inputs TM7BDI16B	TM7BDI16A	–
	16 configurable I/O TM7BDM16B	TM7BDM16A	–
	8 outputs –	–	TM7BDO8TAB

6

Analog I/O expansion blocks



Type of module	Analog I/O expansion blocks			
Input range	Voltage	Current 0...20 mA	Temperature probe Pt100 / Pt1000	J, K, S thermocouple
Output range	Voltage -10... + 10 V DC	Current 0...20 mA	–	–
Type of inputs	Sink (positive logic)			
Type of outputs	Transistor / source (positive logic)			
Diagnostics	By expansion block, channel, communication on TM7 bus			
Communication bus	TM7 bus			
Sensor / actuator connection	M12 connectors			
Resolution	11 bit + sign	12 bit	16 bit	16 bit
References	2 inputs/2 outputs TM7BAM4VLA	TM7BAM4CLA	–	–
	4 inputs TM7BAI4VLA	TM7BAI4CLA	TM7BAI4TLA	TM7BAI4PLA
	4 outputs TM7BAO4VLA	TM7BAO4CLA	–	–

Modicon Momentum _____ Distributed I/O and processors

Discrete I/O modules



Type of module	Multibus discrete inputs			
Connection	By screw terminals 170XTS00100 or spring terminals 170XTS00200 (to be ordered separately)			
Input voltage	24 VDC	120 VAC	230 VAC	
Number of channels	16 (1 common point)	32 (2 common points)	16 (2 common points)	
Dimensions W x D x H (mm)	125 x 47.5 x 141.5 (with communication modules or processors) 144 x 70 x 141.5 (with M1/M1E processors and optional modules)			
Reference	170ADI34000	170ADI35000	170ADI54050	170ADI74050



Type of module	Multibus discrete outputs					
	Solid state		Triac			
Connection	By screw terminals 170XTS00100 or spring terminals 170XTS00200 (to be ordered separately)					
Output voltage	24 VDC		120 VAC		230 VAC	
Number of protected channels	16 (2 common pts)	32 (2 common pts)	8 (2 common pts)	16 (2 common pts)	8 (2 common pts)	16 (2 common pts)
Output current	Per channel	0,5 A	0,5 A	2 A	0,5 A	0,5 A
	Per group of channels	4 A	8 A	4 A	4 A	4 A
	Per module	8 A	16 A	8 A	8 A	8 A
Dimensions W x D x H (mm)	125 x 47.5 x 141.5 (with communication modules or processors) 144 x 70 x 141.5 (with M1/M1E processors and optional modules)					
Reference	170ADO34000	170ADO35000	170ADO53050	170ADO54050	170ADO73050	170ADO74050



Type of module	Multibus discrete I/O								
	Solid state			Relay		Triac			
Connection	By screw terminals 170XTS00100 or spring terminals 170XTS00200 (to be ordered separately)								
Number of channels	Inputs	16 (1 common pt)	16 (4 com. pts)	16 (1 com. pt)	10 (1 common pt)				
	Input logic	Positive	Positive (2)	Negative	Positive		-		
	Outputs	16 (1 common pt)	16 (2 common pts)	8/4 (1 com. pt)	12	8 (2 common pts)		8 (1 com. pt)	
Input voltage	12...48 VDC		24 VDC				120 VAC		
Output voltage	12...48 VDC		24 VDC				24...230 VAC/20...115 VDC		120 VAC
Output current	Per output	0,5 A	0,5 A		2 A	0,5 A	2 A		0,5 A
	Per group of channels	-	4 A		4 A	4/2 A	8 A		4 A
	Per module	8 A	8 A		8 A	6 A	16 A		4 A
Dimensions W x D x H (mm)	125 x 47.5 x 141.5 (with communication modules or processors) 144 x 70 x 141.5 (with M1/M1E processors and optional modules)								
Reference	170ADM85010	170ADM35010	170ADM35015	170ADM37010	170ADM39010	170ADM39030	170ARM37030	170ADM69051	

(2) For a version with high-speed positive logic, replace 0 at the end of the reference with 1. E.g. 170ADM35010 becomes 170ADM35011

Connection accessories: See www.schneider-electric.com

Modicon Momentum Distributed I/O and processors

Analog I/O modules



Type of module	Multibus analog inputs		
Connection	By screw terminals 170XTS00100 or spring terminals 170XTS00200 (to be ordered separately)		
Number of channels	8 isolated	16 with common point	4 isolated
Input signal	$\pm 5\text{ V}$, $\pm 10\text{ V}$, $\pm 20\text{ mA}$, 1...5 V, 4...20 mA	$\pm 5\text{ V}$, $\pm 10\text{ V}$, 4...20 mA	Multi-range $\pm 25\text{ mV}$, $\pm 10\text{ mV}$ (1)
Resolution	14 bits + sign, 15 bits unipolar	12 bits + sign	15 bits + sign
Dimensions W x D x H (mm)	125 x 47.5 x 141.5 (with communication modules or processors) 144 x 70 x 141.5 (with M1/M1E processors and optional modules)		
Reference	170AAI03000	170AAI14000	170AAI52040

(1) Temperature probe: Pt 100, Pt 1000, Ni 100, Ni 1000, Thermocouple: B, E, J, K, N, R, S, T.



Type of module	Multibus analog outputs		Analog I/O and multibus discrete I/O			
Connection	By screw terminals 170XTS00100 or spring terminals 170XTS00200 (to be ordered separately)					
Number of channels	Inputs	–	4 differential + 4 discrete		6 with com pt + 8 discrete (24 VDC)	
	Outputs	4	2 + 2 discrete (24VDC)	2 + 2 discrete (12VDC)	4 with com pt + 8 discrete (24 VDC)	
Input signal	$\pm 10\text{ V}$, 0...20 mA	$\pm 10\text{ V}$, 4...20 mA	$\pm 5\text{ V}$, $\pm 10\text{ V}$, $\pm 20\text{ mA}$, 1...5 V, 4...20 mA	0...10 V	$\pm 10\text{ V}$	
Output signal	–		$\pm 10\text{ V}$, 4...20 mA	0...10 V	$\pm 10\text{ V}$	
Resolution	12 bits + sign		12...14 bits dep. on signal	14 bits	14 bits	
Dimensions W x D x H (mm)	125 x 47.5 x 141.5 (with communication modules or processors) 144 x 70 x 141.5 (with M1/M1E processors and optional modules)					
Reference	170AAO12000	170AAO92100	170AMM09000	170AMM09001	170ANR12090	170ANR12091

6

Application-specific I/O modules



Type of module	High-speed counter	Discrete I/O with Modbus port
Connection	By screw terminals 170XTS00100 or spring terminals 170XTS00200 (to be ordered separately)	
Type of inputs for	Incremental or absolute encoders	RS 485 Modbus port
Operating voltage	24 VDC	120 VAC
Counting frequency	200 kHz	–
Number of channels	2 independent	–
Number of discrete I/O	2 x 3 inputs/2 x 2 outputs	6 inputs/3 outputs
Dimensions W x D x H (mm)	125 x 47.5 x 141.5 (with communication modules or M1/M1E processors) 144 x 70 x 141.5 (with M1/M1E processors and optional modules)	
Reference	170AEC92000	170ADM54080

Modicon Momentum Distributed I/O and processors Communication modules



Type of module	Ethernet TCP/IP network		Fipio fieldbus	INTERBUS (1) fieldbus	Profibus DP fieldbus
Speed	10 Mbps	10/100 Mbps	1 Mbps	0.5 Mbps	9.6 K...12 Mbps
Manager PLC	-		Premium	-	-
Redundancy	No		No	No	No
Standard services	Modbus TCP/IP		-	-	-
Reference	170ENT11002	170ENT11001	170FNT11001	170INT11000 (1)	170DNT11000

(1) Generation 4, twisted pair medium: 170INT11003, with optical fiber medium: 170INT12000



Type of module	Other networks Modbus Plus		DeviceNet
Speed	1 Mbps		0.5 Mbps
Manager PLC	Premium or Quantum	Quantum	-
Redundancy	No	Yes	No
Standard services	-		-
Reference	170PNT11020	170PNT16020	170LNT71000

Optional modules for M1/M1E processors



Type of module (2)	Modbus Plus		Asynchronous serial link
Communication ports	1 Modbus Plus	2 redundant Modbus Plus	RJ45
Real-time clock	Integrated, ± 13 sec/day accuracy		
Connection	By 9-way SUB-D connector		
Reference	172PNN21022	172PNN26022	172JNN21032

(2) Include save battery of the M1/M1E processors application and data memories.

Connection accessories

Type	RS 232C communication cable		
Length	1 m	3 m	6 m
Reference	110XCA28201	110XCA28202	110XCA28203

Power supply module (3)



Type of power supply module for	Momentum processors
Input voltage	120 or 230 VAC (selected by jumper)
Output voltage	24 VDC
Output current	0.7 A
Dimensions W x D x H (mm)	73 x 44.5 x 146
Reference	170CPS11100

(3) For power supplies, see chapter 5.

Modicon Momentum Distributed I/O and processors M1/M1E processors



Type of processor		M1			
Number of I/O	Discrete	2048 I/O		2048 I/2048 Q	
	Registers	2048 words		4096 words	
Integrated communication ports	Modbus	1 RS 232C	1 RS 232C + 1 RS 485	1 RS 232C	1 RS 232C + 1 RS 485
	Ethernet TCP/IP	–			
	I/O bus (1)	–		1 I/O port	–
Transparent Ready	Embedded Web server	–			
Memory capacity	RAM	64 Kb		256 Kb	
	Flash	256 Kb		256 Kb	
	User, 984 LL language (2)	2.4 K		12 K	
	User, IEC language (3)	–		160 K	
	Data	2 K		4 K	
Cycle time		1 ms/K	1 ms/K	0.63 ms/K	1 ms/K
Reference		171CCS70000	171CCS78000	171CCS76000	171CCC78010

(1) I/O bus derived from INTERBUS bus.

(2) ProWORX 32 or Concept programming software.

(3) Concept programming software.



Type of processor		M1		M1E	
Number of I/O	Discrete	8192 I/O			
	Registers	26048 words			
Integrated communication ports	Modbus	1 RS 232C	1 RS 485	–	
	Ethernet TCP/IP	–		1 integrated Ethernet port	
	I/O bus (1)	1 I/O port	–	1 I/O port	
Transparent Ready	Embedded Web server	–		Standard services (class A10)	
Memory capacity	RAM	512 Kb		544 Kb	
	Flash	512 Kb		1 Mb	512 Kb
	User, 984 LL language (2)	18 K			
	User, IEC language (3)	240 K	–	200 K	–
	Data	24 K			
Cycle time		1 ms/K	0.3 ms/K		
Reference		171CCC76010	171CCC98020	171CCC98030	171CCC96020
				171CCC96030	

6



Type of processor		171 CBB97030	
Integrated communication ports	Modbus	1 RS 232/485	
	Ethernet TCP/IP	4 integrated Ethernet port	
Transparent Ready	Embedded Web server	Standard services (class B)	
Memory capacity	RAM	512 Kb	
	Flash	1 Mb	
	User, 984 LL language (2)	18 K	
	User, IEC language (3)	200 K	
	Data	24 K	
Cycle time		0.25 ms/K	
Reference		171CBB97030	

Connection accessories: See www.schneider-electric.com



Type of connection sub-base	Optimum			
Number of channels	16	16		
Max. current per channel	0.5 A	0.5 A		
Control voltage / output voltage	24 VDC / 24 VDC	24 VDC / 24 VDC		
LED per channel	–	With		
Number of terminals per channel/on row number	1/2	1/1	2/2	3/3
Dimensions W x D x H (mm)	55 x 59 x 67	106 x 60 x 49		
References	–	ABE7H16C11	ABE7H16C21	ABE7H16C31
Cable L = 1 m	ABE7H20E100 (1)	–	–	–
Cable L = 2 m	ABE7H20E200 (1)	–	–	–
Cable L = 3 m	ABE7H20E300 (1)	–	–	–
Connection cable recommended for Modicon, TSX Micro and Premium PLCs, L = 1 m (2)	ABFH20H100			

(1) Connection cable supplied for PLCs.

(2) For a 2 m length cable, replace the number 1 in the reference by 2, and for a 3 m length, by 3. (Example: ABFH20H100 becomes ABFH20H200).



Type of connection sub-base	Universal					
Number of channels	16					
Max. current per channel	0.5 A					
Control voltage / output voltage	24 VDC / 24 VDC					
LED per channel	–	With	–	–	With	With
Number of terminals per channel/on row number	1/1	1/1	1/2	2/2	2/2	3/3
Dimensions W x D x H (mm)	125 x 58 x 70		84 x 58 x 70	125 x 58 x 70		
References	ABE7H16R10	ABE7H16R11	ABE7H16R50	ABE7H16R20	ABE7H16R21	ABE7H16R31
Connection cable recommended for Modicon, TSX Micro and Premium PLCs, L = 1 m: ABFH20H100 (2)						

(2) For a 2 m length cable, replace the number 1 in the reference by 2, and for a 3 m length, by 3. (Example: ABFH20H100 becomes ABFH20H200).



Type of connection sub-base	For counter and analogue channels	Passive distribution with shielding continuity	Distribution and supply of analogue channels
Number of channels	1 counter channel (3)	8	8
Max. current per channel	25 mA	25 mA	25 mA
Control voltage / output voltage	24 VDC / 24 VDC		
Number of terminals per channel	2	2 or 4	2 or 4
Dimensions W x D x H (mm)	143 x 58 x 70	125 x 58 x 70	125 x 58 x 70
References	ABE7CPA01	ABE7CPA02	ABE7CPA03
Connection cable recommended for Modicon PLCs (4)	TSX Micro L = 2.5 m Premium L = 3 m	TSXCCPS15	–

(3) Or 8 inputs + 2 outputs, analogue .

(4) Connection cables available for other PLCs, please see www.schneider-electric.com



Type of connection sub-base	With soldered solid-state relay inputs	With soldered solid-state relay outputs	With soldered electro-mechanical relay outputs
Number of channels	16	16	16
Max. current per channel	12 mA	0.5 A	2 A 5 A
Input voltage / output voltage	24 VDC / - 110 VAC / -	- / 24 VDC	- / 5...30 VDC, 250 VAC
Number of contacts	-	-	1 N/O
Polarity distribution	-	-	(1) Volt-free
Number of terminals per channel	2		
Dimensions W x D x H (mm)	206 x 58 x 77		
References	ABE7S16E2B1 ABE7S16E2F0	ABE7S16S2B0(2) ABE7S16S1B2	ABE7R16S111 ABE7R16S210

Connection cable recommended for Modicon, TSX Micro and Premium PLCs, L = 1 m: **ABFH20H100** (3)

(1) Contact common per group of 8 channels.

(2) With fault detection signal (can only be used with modules with protected outputs).

(3) For a 2 m length cable, replace the number 1 in the reference by 2, and for a 3 m length, by 3. (Example: ABFH20H100 becomes ABFH20H200).



Type of connection sub-base	With plug-in electromechanical relays				
Number of channels	16				
Max. current per channel	5 A	2.5 A		4 A	5 A
Control voltage / output voltage	24 VDC / 5...24 VDC, 230 VAC				
Number of contacts	1 N/O		1 C/O		2 C/O
Polarity distribution	(4)	(5)	Volt-free		
Number of terminals per channel	2	2 or 3		2 to 6	
Dimensions W x D x H (mm)	110 x 54 x 89	211 x 64 x 89		272 x 74 x 89	
References	ABE7R16T111	ABE7R16T212	ABE7R16T210	ABE7R16T230	ABE7R16T330 ABE7R16T370

Connection cable recommended for Modicon, TSX Micro and Premium PLCs, L = 1 m: **ABFH20H100** (6)

(4) Contact common per group of 4 channels.

(5) Common on both poles.

(6) For a 2 m length cable, replace the number 1 in the reference by 2, and for a 3 m length, by 3. (Example: ABFH20H100 becomes ABFH20H200).

Connection cables for PLCs (7)

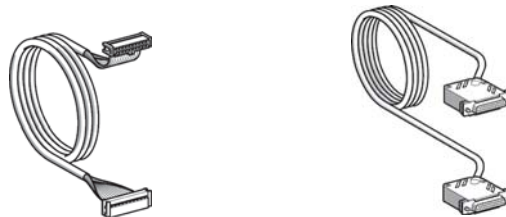

Input/Output functions	Discrete	Analogue	Analogue and counter	Counter	Axis control
References					
Cable L = 1 m	ABFH20H100	-	-	-	-
Cable L = 2 m	ABFH20H200	ABFY25S200	-	-	TSXCXP213
Cable L = 2.5 m	-	-	TSXCCPS15	TSXCCPH15	-
Cable L = 3 m	ABFH20H300	TSXCAP030	-	-	-
Cable L = 6 m	-	-	-	-	TSXCXP613

(7) Modicon, TSX Micro and Premium PLCs.

For other connection cables and accessories, please see www.schneider-electric.com

Sub-bases for input/output module for Twido and Modicon M238



Type of connection sub-base	Discrete outputs			Relay
	Number of channels	16	16	16
Type of outputs	16 I (1 common for 16 channels)	16 O (1 common for 16 channels)	16 O, fuse protected (1 common for 16 channels)	16 O (1 common for 4 channels)
Voltage / current of outputs	24 VDC / 5 mA	24 VDC / 0.1 A		Relay: 5...30 VDC, 250 VAC / 3 A
LED per channel	–		With	–
Number of terminals per channel/row number	2/2			
Dimensions W x D x H (mm)	106 x 60 x 49		130 x 62.5 x 83	
References	ABE7E16EPN20	ABE7E16SPN20	ABE7E16SPN22	ABE7E16SRM20

Connection cables for Twido and Modicon M238



Type of cable	For linking Twido base and Modicon Telefast sub-base	For linking discrete I/O expansion modules Twido or Modicon M238 and Modicon Telefast sub-base
For use with	TWDLMDA20DTK/40DTK	TM2DI16DK/32DK/DDO16TK/32TK
Type of connectors	HE10, 26-pin, at either end	HE10, 20-pin, at either end
References	Cable L = 0.5 m L = 1 m L = 2 m	ABFT20E050 ABFT20E100 ABFT20E200
	ABFT26B050 ABFT26B100 ABFT26B200	

Accessories

Type of accessory	Optional clip-in terminals	
Number of linked terminals	20	12 + 8
References	ABE7BV20	ABE7BV20TB



Type of connection		To PLC using multicore cable		
Number of channels		4	8	
Type of female connector		M12, 5-pin	M12, 5-pin	
Max. number of signals		8	16	
Max. current per channel		4 A		
Max. current per splitter box		16 A (1 mm ²)		
Product certification		cULus		
Dimensions W x D x H (mm)		50.2 x 42 x 92.2	50.2 x 42 x 149.2	
References	Without LEDs	Cable L = 5 m	ABE9C1240L05	ABE9C1280L05
		Cable L = 10 m	ABE9C1240L10	ABE9C1280L10
	With LEDs (1)	Cable L = 5 m	ABE9C1241L05	ABE9C1281L05
		Cable L = 10 m	ABE9C1241L10	ABE9C1281L10

(1) Green LED: power supply status, yellow LED: channel status.



Type of connection		To PLC using M23 connector	
Number of channels		4	8
Type of female connector		M12, 5-pin	M12, 5-pin
Max. number of signals		8	16
Max. current per channel		4 A	
Max. current per splitter box		16 A	
Product certification		cULus	
Dimensions, W X D x H		50.2 x 36.5 x 92.2	50.2 x 36.5 x 149.2
References	Without LEDs	ABE9C1240C23	ABE9C1280C23
	With LEDs (1)	ABE9C1241C23	ABE9C1281C23

(1) Green LED: power supply status, yellow LED: channel status.

6

Accessories

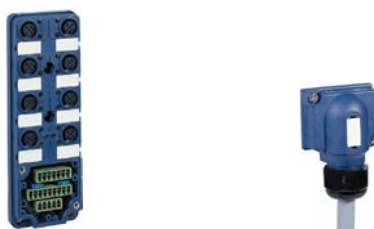

Type of accessory		Splitter boxes w/o cable		Terminal connectors		Sealing plugs (sold in lots of 10)
		Without LEDs	With LEDs	Cable L = 5 m	Cable L = 10 m	
References	4-channel	ABE9C1240M	ABE9C1241M	ABE9XCA1405	ABE9XCA1410	–
	8-channel	ABE9C1280M	ABE9C1281M	ABE9XCA1805	ABE9XCA1810	–
	for Ø12 connector	–	–	–	–	FTXCM12B

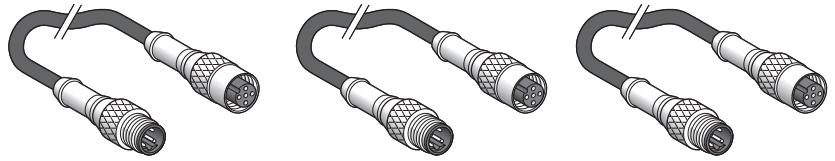

Type			Male / Female jumper cables		
Type of male connector, interface side			M12, 4-pin, straight, screw thread	M12, 4-pin, straight, screw thread	M12, 5-pin, straight, screw thread
Type of female connector, sensor side			M12, 3-pin, straight, screw thread	M12, 4-pin, straight, screw thread	M12, 5-pin, straight, screw thread
Cable			PUR, black	PUR, black	PUR, black
References	Cable	L = 1 m	XZCR1511040A1	XZCR1511041C1	XZCR1511064D1
		L = 2 m	XZCR1511040A2	XZCR1511041C2	XZCR1511064D2

M8/M8, M8/M12 and M12/DIN jumper cables

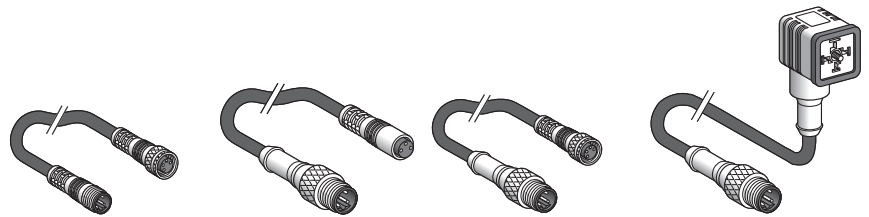

Type			Male / Female jumper cables			
Type of male connector, interface side			M8, 3-pin straight, screw thread	M12, 3-pin straight, screw thread	M12, 3-pin straight, screw thread	M12, 3-pin straight, screw thread
Type of female connector, sensor side			M8, 3-pin straight, screw thread	M8, 3-pin straight, clip together	M8, 3-pin straight, screw thread	DIN 43650A elbowed, screw thread
Cable			PUR, black	PUR, black	PUR, black	PUR, black
References	Cable	L = 1 m	XZCR2705037R1	XZCR1501040G1	XZCR1509040H1	XZCR1523062K1
		L = 2 m	XZCR2705037R2	XZCR1501040G2	XZCR1509040H2	XZCR1523062K2

Pre-wired connectors and splitter box

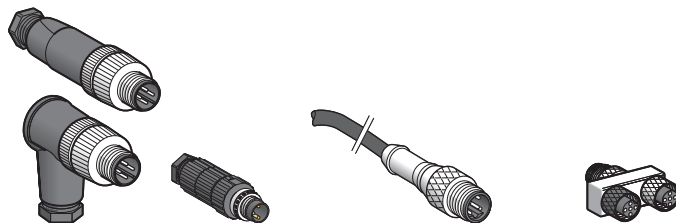

Type			Connectors		Pre-wired connectors	Splitter box "Y"	
Type of male connector, interface side			M12, 4-pin	M8, 3-pin	M12, 5-pin, straight, screw thread	1 x M12	1 x M12
Type of female connector, sensor side			-	-	-	2 x M12	2 x M8
Cable			-	-	PUR, black	-	-
References	Straight connector, screw thread		XZCC12MDM40B	XZCC8MDM30V	-	FTXCY1212	FTXCY1208
		Elbowed connector, screw thread	XZCC12MCM40B	-	-	-	-
		Cable	L = 0.5 m	-	-	XZCP1564L05	-
		L = 2 m	-	-	XZCP1564L2	-	-

Notes



Modicon FactoryCast

Modicon FactoryCast PLC modules and the Modicon FactoryCast Gateway combine the benefits of open Web technologies with the reliability of industrial control.

In the areas of distributed infrastructure, RTU installations, industry, machinery and energy, the Modicon FactoryCast ranges offer an ideal solution for all your remote diagnostics and maintenance, monitoring, control and programming needs.



Schneider Electric's communication solutions for industrial networks monitor your control system applications to give you precise control and maintenance data in real time.

Remote intelligent modules or in-rack modules for PLCs, standalone products and devices - the Modicon FactoryCast, AS-Interface and Modicon Connexium ranges provide access to advanced functions, flexible tools and services for optimising communication between all your automation products.



AS-Interface

AS-Interface is a quick expandable cabling system which connects all components in a control system with just a single cable. Intelligent, it features built-in communication management.



Modicon Connexium

Designed for open industrial solutions, Modicon Connexium products are the Ethernet-ready network hubs, switches, transceivers, gateways and cables which provide you with integrated Ethernet solutions to unite everything in your installation, from device level all the way to your corporate intranet. Modicon Connexium boosts network performance and reliability.

7 | Networks, connectivity and Web servers



This document is a selection of the top selling products.
For more information:
<http://www.schneider-electric.com>

ConneXium cabling system

Hub, IP 67 Switch	7/2
Switches	7/3 to 7/7
Gateways	7/8
Cables & Connectors	7/9
WiFi products	7/10

AS-Interface cabling system

Modicon interfaces for generic products	7/12 to 7/13
IP20 interfaces	
IP67 interfaces	
Dedicated components	7/14 to 7/15
For control	
For dialogue	
Installation system	7/16 to 7/18
Master modules, power supply units	
Cables, repeaters	
Accessories	
Tools	7/19
Adjustment and addressing terminals	

Servers and Gateways

Data server software,	
OPC Factory Server	7/20
Other servers and gateways,	
FactoryCast	7/21 to 7/23



Hub			
Interfaces	Copper cable ports	Number and type	4 x 10BASE-T ports
		Shielded connectors	RJ45
		Medium	Shielded twisted pair, category CAT 5E
		Total length of pair	100 m
Power supply	Voltage	24 V (18...32) DC, safety extra low voltage (SELV)	
Degree of protection		IP 30	
Dimensions W x H x D		40 x 125 x 80 mm	
Conformity to standards		cUL 60950, UL 508 and CSA 142, UL 1604 and CSA 213 Class 1 Division 2, C, GL	
		FM 3810, FM 3611 Class 1 Division 2 , C-TICK	
Reference		499 NEH 104 10	



IP 67 switch		Twisted pair, unmanaged	
Interfaces	Copper cable ports	Number and type	5 x 10BASE-T/100BASE-TX ports
		Shielded connectors	M12 (type D)
		Medium	Shielded twisted pair, category CAT 5E
		Total length of pair	100 m with rated cable
Power supply	Voltage	24 VDC (18...32 VDC), safety extra low voltage (SELV)	
Degree of protection		IP 65/67	
Dimensions W x H x D		60 x 126 x 31 mm	
Conformity to standards		cUL 508 and CSA 22.2 14 , C-TICK	
Reference		TCS ESU 051 F0	



Switches			Copper twisted pair, unmanaged				
Interfaces	Copper cable ports	Number and type	3 x 10BASE-T/ 100BASE-TX ports	4 x 10BASE-T/ 100BASE-TX ports	5 x 10BASE-T/ 100BASE-TX ports	8 x 10BASE-T/ 100BASE-TX ports	
		Shielded connectors	Type RJ45				
		Medium	Shielded twisted pair, category CAT 5E				
		Total length of pair	100 m				
	Fiber optic ports	Number and type	–	1 x 100BASE-FX ports	–	–	
		Connectors	–	Duplex SC	–	–	
		Medium	–	Multimode optical fiber	–	–	
		Length of optical fiber					
		50/125 µm fiber	–	5000 m (1)	–	–	
		62,2/125 µm fiber	–	4000 m (1)	–	–	
Attenuation analys	50/125 µm fiber	–	8 dB	–	–		
	62,2/125 µm fiber	–	11 dB	–	–		
Power supply	Voltage, safety extra low voltage (SELV)	~ 24 VDC (≐ 9,6...32 VDC)					
	Power consumption	Max. 2,2 W	Max. 3,9 W	Max. 2,2 W	Max. 4,1 W		
	Connector	3 way removable connector					
Degree of protection		IP 30					
Dimensions		W x H x D		25 x 114 x 79 mm		35 x 138 x 121 mm	
Weight		0,113 kg		0,120 kg		0,113 kg	0,246 kg
Conformity to standards		UL 508 and CSA 22.2 N° 142 IEC/EN 61131-2, IEC 60825-1 class 1, CISPR 11A					
Alarm relay		–					
Reference		TCS ESU 033FN0		TCS ESU 043F1N0		TCS ESU 053FN0	TCS ESU 083FN0

(1) Length dependent on the attenuation analysis and attenuation of the fiber optic (typical value: 2,000 m).



7

Switches			Copper twisted pair and fibre optic, unmanaged					
Interfaces	Copper cable ports	Number and type	4 x 10BASE-T/ 100BASE-TX ports	3 x 10BASE-T/ 100BASE-TX ports	4 x 10BASE-T/ 100BASE-TX ports	3 x 10BASE-T/ 100BASE-TX ports	8 x 10BASE-T/ 100BASE-TX ports	
		Shielded connectors	RJ45					
		Medium	Shielded twisted pair, category CAT 5E					
		Total length of pair	100 m					
	Fiber optic ports	Number and type	1 x 100BASE-FX port	2 x 100BASE-FX ports	1 x 100BASE-FX port	2 x 100BASE-FX ports	–	
		Connectors	SC				–	
		Medium	Multimode optical fiber		Single mode optical fiber		–	
		Length of optical fiber						
		50/125 µm fiber	5000 m (1)		–		–	
		62,2/125 µm fiber	4000 m (1)		–		–	
			32 500 m (2)		–			
Power supply	Voltage	24 VDC (18...32), safety extra low voltage (SELV)						
	Degree of protection	IP 20						
Dimensions		W x H x D		47 x 135 x 111 mm				
Conformity to standards		cUL 60950, cUL 508 and CSA 142, UL 1604 and CSA 213 Class 1 Division 2, CE, GL, C-TICK						
References		499 NMS 251 01		499 NMS 251 02		499 NSS 251 01	499 NSS 251 02	499 NES 181 00

(1) Length dependent on the attenuation analysis and attenuation of the fiber optic (typical value: 2,000 m).

(2) Length dependent on the attenuation analysis and attenuation of the fiber optic (typical value: 15,000 m).



Switches			Copper twisted pair and fiber optic, managed			
Interfaces	Copper cable ports	Number and type	3 x 10/100BASE-TX ports	2 x 10/100BASE-TX ports	3 x 10/100BASE-TX ports	2 x 10/100BASE-TX ports
		Shielded connectors	RJ45			
		Medium	Shielded twisted pair, category CAT 5E			
		Total length of pair	100 m			
	Fiber optic ports	Number and type	1 x 100BASE-FX port	2 x 100BASE-FX ports	1 x 100BASE-FX port	2 x 100BASE-FX ports
	Connectors	Duplex SC				
	Medium	Multimode optical fiber		Single mode optical fiber		
	Length of optical fiber					
	50/125 µm fiber	5,000 m (1)		-		
	62.2/125 µm fiber	4,000 m (1)		-		
	9/125 µm fiber	-		32,500 m (2)		
Power supply	Voltage	Operation	9.6...60 VDC/18...30 VAC, safety extra low voltage (SELV)			
Degree of protection			IP 20			
Dimensions W x H x D			47 x 131 x 111 mm			
Conformity to standards			IEC 61131-2, UL 508, UL 1604 Class 1 Division 2, CSA C22.2 14 (cUL), CSA C22.2 213 Class 1 Division 2 (cUL), CE, GL, C-TICK			
References			TCSESM043F1CU0	TCSESM043F2CU0	TCSESM043F1CS0	TCSESM043F2CS0

(1) Length dependent on the attenuation analysis and attenuation of the fiber optic (typical value: 2,000 m).

(2) Length dependent on the attenuation analysis and attenuation of the fiber optic (typical value: 15,000 m).



Switches			Copper twisted pair, managed	
Interfaces	Copper cable ports	Number and type	4 x 10/100BASE-TX ports	8 x 10/100BASE-TX ports
		Shielded connectors	RJ45	
		Medium	Shielded twisted pair, category CAT 5E	
		Total length of pair	100 m	
Power supply	Voltage	Operation	9.6...60 VDC/18...30 VAC, safety extra low voltage (SELV)	
Degree of protection			IP 20	
Dimensions W x H x D			47 x 131 x 111 mm	74 x 131 x 111 mm
Conformity to standards			IEC 61131-2, UL 508, UL 1604 Class 1 Division 2, CSA C22.2 14 (cUL), CSA C22.2 213 Class 1 Division 2 (cUL), CE, GL, C-TICK	
References			TCSESM043F23F0	TCSESM083F23F0



Switches			Copper twisted pair and fiber optic, managed			
Interfaces	Copper cable ports	Number and type	7 x 10/100BASE-TX ports	6 x 10/100BASE-TX ports	7 x 10/100BASE-TX ports	6 x 10/100BASE-T ports
		Shielded connectors	RJ45			
		Medium	Shielded twisted pair, category CAT 5E			
		Total length of pair	100 m			
	Fiber optic ports	Number and type	1 x 100BASE-FX port	2 x 100BASE-FX port	1 x 100BASE-FX port	2 x 100BASE-FX port
		Connectors	Duplex SC			
		Medium	Multimode optical fiber (MM)		Single mode optical fiber (SM)	
Length of optical fiber						
	50/125 µm fiber	5,000 m (1)	-			
	62.2/125 µm fiber	4,000 m (1)	-			
	9/125 µm fiber	-	32,500 m (2)			
Power supply	Voltage	Operation	9.6...60 VDC/18...30 VAC, safety extra low voltage (SELV)			
Degree of protection	IP 20					
Dimensions W x H x D	74 x 131 x 111 mm					
Conformity to standards	IEC 61131-2, UL 508, UL 1604 Class 1 Division 2, CSA C22.2 14 (cUL), CSA C22.2 213 Class 1 Division 2 (cUL), CE, GL, C-TICK					
References	TCSESM083F1CU0		TCSESM083F2CU0	TCSESM083F1CS0	TCSESM083F2CS0	

(1) Length dependent on the attenuation analysis and attenuation of the fiber optic (typical value: 2,000 m).

(2) Length dependent on the attenuation analysis and attenuation of the fiber optic (typical value: 15,000 m).



Switches			Copper twisted pair, managed	Copper twisted pair and fiber optic, managed		
Interfaces	Copper cable ports	Number and type	16x10/100BASE-TX ports	14x10/100BASE-TX ports	22x10/100BASE-TX ports	14 ports 10/100BASE-TX
		Shielded connectors	RJ45			
		Total length of pair	100 m			
	Fiber optic ports	Number and type	-	2 x 100BASE-FX ports		
		Connector	-	Duplex SC		
		Medium	-	Multimode optical fiber		Optical fiber
		Length of optical fiber				
	50/125 µm fiber	-	5,000 m (1)	-		
	62.2/125 µm fiber	-	4,000 m (1)	32 500 M (2)		
Power supply	Voltage	Operation	9.6...60 VDC/18...30 VAC, safety extra low voltage (SELV)			
Degree of protection	IP 20					
Dimensions W x H x D	111 x 131 x 111 mm					
Conformity to standards	cUL 60950, UL 508 and CSA 142, UL 1604 and CSA 213 Class 1 Division 2, CE, GL, C-TICK					
References	TCSESM163F23F0		TCSESM163F2CU0	TCSESM243F2CU0	TCSESM16F2CS0	

(1) Length dependent on the attenuation analysis and attenuation of the fiber optic (typical value: 2,000 m).



Switches			Copper twisted pair and fibre optic, managed - extended features			
Interfaces	Copper cable ports	Number and type	8 x 10/100 BASE-TX ports	6 x 10/100 BASE-TX ports	6 x 10/100 BASE-TX ports	
		Shielded connectors	RJ45			
		Medium	Shielded twisted pair, category CAT 5E			
		Total length of pair	100 m			
	Fiber optic ports	Number and type	–	2 x 100BASE-FX ports	2 x 100BASE-FX ports	
		Connectors	–	Duplex SC	Duplex SC	
		Medium	–	Multi mode optical fibre	Single mode optical fibre	
		Length of optical fiber	50/125 µm fiber	–	5,000 m (1)	–
			62.2/125 µm fiber	–	4,000 m (1)	–
			9/125 µm fiber	–	–	32,500 m (2)
		Attenuation analysis	50/125 µm fibre	–	8 dB	–
			62.2/125 µm fiber	–	11 dB	–
			9/125 µm fiber	–	–	16 dB
		Ethernet services	FDR, SMTP V3, SNMP client, multicast filtering for optimization of the Global Data protocol, configuration via Web access, VLAN, IGMP Snooping, RSTP (Rapid Spanning Tree Protocol), priority port, data stream control, secure port.			
Topology	Number of switches	Cascaded	Unlimited			
		Redundant in a ring	max. 50			
Redundancy	Redundant power supplies, redundant single ring, ring coupling					
Power supply	Voltage	Operation	18 - 60 V safety extra low voltage (SELV)			
	Power consumption		10 W	12 W	12 W	
Degree of protection	IP30					
Dimensions W x H x D	120 x 137 x 115 mm					
Conformity to standards	IEC/EN 61131-2, IEC 61850-3, UL 508, UL ISA-12.12.-01 Class 1 Div 2 Group A, B, C, D, CSA 22.2 No. 142 (cUL), CSA 22.2 No. 213 Class 1 Division 2 (cUL), CE, GL, C-Tick					
Alarm relay	Power supply fault, Ethernet network fault or communication port fault (2 A max. volt-free contact at 30 VDC)					
References			TCSESM083F23F1	TCSESM063F2CU1	TCSESM063F2CS1	

(1) Length dependent on the attenuation analysis and attenuation of the fiber optic (typical value: 2,000 m).

(2) Length dependent on the attenuation analysis and attenuation of the fiber optic (typical value: 15,000 m).

Switches			Copper twisted pair and fiber optic, managed			Copper twisted pair, managed	
Interfaces	Copper cable ports	Number and type	8 x 10/100 BASE-TX ports			8 x 10/100 BASE-TX ports 2 x 100 BASE-TX ports (Gigabits)	
		Shielded connectors	RJ45				
		Medium	Shielded twisted pair, category CAT 5E				
		Total length of pair	100 m				
	Fiber optic ports	Number and type	2 x 100BASE-SX ports (1)	2 x 100BASE-LH ports (2)	2 x 100BASE-LX ports (3)	-	
		Connectors	LC			-	
		Medium	Multimode optical fiber	Single optical fibre	Single mode and multi-mode optical fiber	-	
		Length of optical fiber	50/125 µm fiber	550 m	-	550 m	-
			62.2/125 µm fiber	275 m	-	550 m	-
			9/125 µm fiber	-	8 - 72,000 m	20,000 m	-
		Attenuation analysis	50/125 µm fibre	7,5 dB	-	11 dB	-
			62.2/125 µm fiber	7,5 dB	-	11 dB	-
			9/125 µm fiber	-	6 - 22 dB	11 dB	-
		Ethernet services	FDR, SMTP V3, SNMP client, multicast filtering for optimization of the Global Data protocol, configuration via Web access, VLAN, IGMP Snooping, RSTP (Rapid Scanning Tree Protocol), priority port, data stream control, secure port.				
		Topology	Number of switches	Cascaded	Unlimited		
Redundant in a ring	max. 50						
Redundancy	Redundant power supplies, redundant single ring, ring coupling						
Power supply	Voltage	Operation	9,6...60 VDC/18...30 VAC, safety extra low voltage (SELV)				
Degree of protection	IP20						
Dimensions W x H x D	111 x 113 x 111 mm						
Conformity to standards	cUL 60950, UL 508 and CSA 22.2, UL 1604 and CSA 213 CSA 22.2 No. 213 Class 1 Division 2, CE, GL						
References	TCSESM103F2LG0			TCSESM103F23G0			

(1) With TCSEAAF1LFU00 fiber optic module to be ordered separately

(2) With TCSEAAF1LFH00 fiber optic module to be ordered separately

(3) With TCSEAAF1LFS00 fiber optic module to be ordered separately

Switches			Copper twisted pair and fiber optic, managed			Copper twisted pair, managed	
Interfaces	Copper cable ports	Number and type	6 x 10/100 BASE-TX ports			8 x 10/100 BASE-TX ports	
		Shielded connectors	RJ45				
		Total length of pair	100 m				
	Fiber optic ports	Number and type	2 x 100 BASE-SX ports	3 x 100 BASE-LX ports		-	
		Connector	Duplex SC			-	
		Medium	Multimode optical fiber			-	
		Length of optical fiber	50/125 µm fiber	5,000 m (1)		-	
			62.2/125 µm fiber	4,000 m (1)		-	
			Attenuation analysis	50/125 µm fiber	8 dB		-
		62.2/125 µm fiber		11 dB		-	
		Ethernet services	FDR, SNMP client, multicast filtering for optimization of the Global Data protocol, configuration via Web access, IGMP Snooping, RSTP (Rapid Scanning Tree Protocol), priority port, data stream control, secure port.				
		Topology	Number of switches	Cascaded	Unlimited		
				Redundant in a ring	Max. 50		
		Redundancy	Redundant power supplies				
	Conformity to standards	UL 508, CSA C22.2, CSA No. 213, UL 1604, CE					
References	TCSESB083F23F0		TCSESB083F2CU0		TCSESB093F2CU0		



Type of gateway		TSX ETG 100		
Transparent Ready services	Class	B10		
		Standard Web services	Configuration	Predefined Web pages
			Read/Write	Acces to connected products list, reading of Modbus devices registers
	Diagnostic		Via predefined Web pages : diagnostic on Ethernet and Modbus links	
	Ethernet TCP/IP communication management services	Modbus messaging	Read/Write Modbus registers of connected devices	
		SNMP	SNMP Agent, device administration with a SNMP manager	
		BOOTP protocol	FDR Client (replacement of defective product)	
Security		Miniature firewall on-board (IP address filtering) and password protection		
Ethernet connectivity	Physical interface	10BASE-T/100BASE-TX (RJ45)		
	Data rate	10/100 Mbps with automatic recognition		
	Medium	Twisted pair		
Modbus connectivity	Type of port	RS 485 (2 or 4-wire) or RS 232		
	Protocol	Modbus (RTU and ASCII)		
	Maxi transmission speed	38,4 Kbps (RS 485), 57,6 Kbps (RS 232)		
	Number of devices	32 max.		
Power supply		24 VDC, 4 W or by power supply device PoE (Power Over Ethernet - IEEE 802.3af)		
Degree of protection		IP 30		
Dimensions W x H x D		72 x 81 x 76 mm, mounting on symmetrical DIN rail		
Conformity to standards		UL, cUL (conforming to CSA C22-2 no. 14-M91), UL508 , C-TICK, CÉ		
Reference		TSX ETG 100 (1)		

(1) Fonctions: Twido, Compact, Momentum, TSX Micro, Altivar, Altistart, Magelis, ... All products compatible with Modbus standard.



7

Type of gateway		Ethernet/Modbus Plus gateway/router Class B10		
Transparent Ready services	Class	B10		
		Standard Web services	Configuration	Predefined Web pages
			Read/Write	Acces to connected products list, reading of Modbus Plus devices registers
	Diagnostic		Via predefined Web pages : diagnostic on Ethernet and Modbus Plus links	
	Standard Ethernet TCP/IP communication services		Modbus TCP messaging	
			SNMP Agent	
	Functions	Communication gateway	Ethernet/Modbus Plus (many-to-many Modbus Plus)	
Interface for programming		Ethernet/Modbus Plus		
Interfaces	Ethernet TCP/IP port	Type	1 x 10BASE-T/100BASE-TX	
		Shielded connectors	RJ45	
		Medium	Shielded twisted pair	
	Serial port	Max. distances	100 m (327 ft)	
		Type	1 x Modbus Plus	
		Shielded connectors	9-way SUB-D connector	
	Medium	Shielded twisted pair (single or double)		
Power supply	Voltage	110/220 VAC (93.5 VAC...242 VAC), 47...63 Hz		
Degree of protection		IP 20		
Dimensions W x H x D		122 x 229 x 248 mm		
Conformity to standards		UL 508, CSA 142, CÉ		
Reference		174 CEV 200 40 (2)		

(2) Fonctions: 1 Ethernet port, 10BASE-T/100BASE-TX, 1 Modbus Plus port

Ethernet TCP/IP, Transparent Ready Cabling system: Connection components Shielded copper connection cables

ConneXium shielded connection cables are available in two versions to meet the various current standards and approvals:

These cables conform to:

- EIA/TIA-568 standard, category CAT 5E,
- IEC 11801/EN 50173 standard, class D.

Their fire resistance conforms to:

- NFC 32070# C2 classification
- IEC 322/1 standards
- Low Smoke Zero Halogen (LSZH).

EIA/TIA 568 shielded twisted pair cables



EIA/TIA 568 shielded twisted pair cables for CE market						
Length	m / (ft)	2 (6.6)	5 (16.4)	12 (39.4)	40 (131.2)	80 (262.5)
Straight cables	Preformed at both ends	2 RJ45 connectors for connection to terminal devices (DTE)				
References		490 NTW 000 02	490 NTW 000 05	490 NTW 000 12	490 NTW 000 40	490 NTW 000 80
Crossed cord cables	Preformed at both ends	2 RJ45 connectors for connections between hubs, switches and transceivers				
References		-	490 NTC 000 05	-	490 NTC 000 40	490 NTC 000 80

Ethernet cables

Ethernet cables						
Length	m / (ft)	1 (3.3)	2 (6.6)	3 (9.8)	5 (16.4)	10 (32.8)
		Cat 5E w/RJ45				
References	CE	TCSECE3M3M1S4	TCSECE3M3M2S4	TCSECE3M3M3S4	TCSECE3M3M5S4	TCSECE3M3M10S4
	UL	TCSECU3M3M1S4	TCSECU3M3M2S4	TCSECU3M3M3S4	TCSECU3M3M5S4	TCSECU3M3M10S4

EIA/TIA 568 shielded twisted pair cables



Cable material is :

- CEC type FT-1
- NEC type CM

EIA/TIA shielded twisted pair cables for UL markets							
Length	m / (ft)	2 (6.6)	5 (16.4)	12 (39.4)	15 (49.2)	40 (131.2)	80 (262.5)
Straight cables	Preformed at both ends	2 RJ45 connectors for connection to terminal devices (DTE)					
References		490 NTW 000 02U	490 NTW 000 05U	490 NTW 000 12U	-	490 NTW 000 40U	490 NTW 000 80U
Crossed cord cables	Preformed at both ends	2 RJ45 connectors for connections between hubs, switches and transceivers					
References		-	490 NTC 000 05U	-	490 NTC 000 12U	490 NTC 000 40U	490 NTC 000 80U

Cables M12



Cables M12						
M12 / M12	Length (m)	1	3	10	25	40
Reference		TCSECL1M1M●●S2●●				
RJ45 / M12	Length(m)	1	3	10	25	40
Reference		TCSECL1M3M●●S2●●				

Glass fiber optic cables



These glass fiber optics are for making connections:

- To a terminal device (DTE)
- Between hubs, transceivers and switches

Glass fiber optic cables					
Length	m / (ft)	5 (16.4)	5 (16.4)	3 (9.8)	5 (16.4)
Glass fiber optic cables	Preformed at both ends	1 SC connector	1 ST connector (BFOC)	2 MT-RJ connectors	
		1 MT-RJ connector	1 MT-RJ connector		
References		490 NOC 000 05	490 NOT 000 05	490 NOR 000 03	490 NOR 000 05



Access Points and Clients		Dual band industrial wireless LAN Access Point/Client based on IEEE 802.11a/b/g/h/i		Dual band industrial high performance wireless LAN Access Point/Client based on IEEE 802.11a/b/g/h/n	
Wireless standard		IEEE 802.11a/b/g/h/i	IEEE 802.11a/b/g/h/i	IEEE 802.11a/b/g/h/n	IEEE 802.11a/b/g/h/n
Operating frequencies		2.4GHz & 5GHz	2.4GHz & 5GHz	2.4GHz & 5GHz	2.4GHz & 5GHz
IP Rating		IP 40	IP 67	IP 40	IP 67
Mounting		Din Rail	Wall / Mast	Din Rail	Wall / Mast
Radios		Access Point: 2 Client: 1	2	1	1
Nominal Data rate		54 Mbps	54 Mbps	300 Mbps	300 Mbps
Antenna connections		4 x RP-SMA	4 x N-type	3 x RP-SMA	4 x N-type
Ethernet connections (10/100BASE-TX)		Access Points: 2 Client: 1	1	2	2
Wireless connections		2 x WLAN Interfaces 8 SSIDs per interface	2 x WLAN Interfaces 8 SSIDs per interface	1 x WLAN Interfaces 8 SSIDs per interface	1 x WLAN Interfaces 8 SSIDs per interface
References	Global	TCSGWA242	TCSGWA272	TCSNWA241	TCSNWA271
	North America (FCC approved)	TCSGWA242F	–	TCSNWA241F	TCSNWA271F
	Client only	TCSGWC241	–	–	–
	ATEX Compliant	–	–	–	TCSNWA2A1

Antennas		TSCG**** Compatible References (1)	TSCN**** Compatible References (1)
2.4 GHz	2.4 GHz Omni Directional (6dBi)	TCSWAB20	–
	2.4 GHz Directional (14dBi)	TCSWAB2D	–
	2.4 GHz Dual Slant (8dBi)	TCSWAB2S	TCSWAB2S
	Leaky Cable – 50 meter	TCSWABC5	–
	Leaky Cable – 100 meter	TCSWABC10	–
5 GHz	5 GHz Omni Directional (5dBi)	TCSWAB50	–
	5 GHz Directional – Medium (18.5dBi)	TCSWAB5D	–
	5 GHz Directional – Long (23dBi)	TCSWAB5V	TCSWAB5V
	5 GHz Directional – 802.11n (23dBi)	TCSWAB5VN	TCSWAB5VN
	5 GHz Dual Slant (9dBi)	TCSWAB5S	–
	5 GHz Directional – 802.11n (9dBi)	–	TCSWAB5DN
Dual Band	Dual Band Hemispherical (6dBi/8dBi)	TCSWABDH	–
	Dual Band Omni (3.5dBi/5.5dBi)	–	TCSWABDON

(1) Consult www.schneider-electric.com for a complete list of antenna cables and accessories for WiFi products



Modular interface, width 25 mm V2.1 with standard addressing	Analogue		Digital		
	Number of inputs	2 (0...10V)	2 (0/4...20mA)	4	4
Number of outputs	–	–	4 relay, 2A	4 solid state, 0.5A	4 solid state, 0.5A
Type of addressing	Standard				
Supply by AS-Interface	Inputs and sensor supply (200 mA max.)				–
Supply by 24 VDC external source (black AUX cable)	–	–	–	Outputs	(2)
AS-Interface profile	S.7.3.F.D	S.7.3.F.D	S.7.0.F.E	S.7.0.F.E	S.7.0.F.E
Maximum consumption from AS-Interface (excluding sensor supply)	60 mA	60 mA	110 mA	50 mA	20 mA
Dimensions (WxDxH)	25x77x87 mm	25x77x87 mm	25x77x87 mm	25x77x87 mm	25x77x87 mm
References	ASI20MA2VU	ASI20MA2VI	ASI20MT4I4OR	ASI20MT4I4OS	ASI20MT4I4OSA
Accessory (1) for connection to flat cables	TCSATN01N2	TCSATN01N2	TCSATN01N2	TCSATV01N2	TCSATV01N2

(1) Or direct screw terminal connection (without accessory).

(2) Inputs, outputs and sensor supply (200 mA max.).



Modular interface, width 25 mm V2.1 with Extended (A/B) addressing	Digital				
	Number of inputs	4	2	4	4
Number of outputs	–	1 triac, 2A	3 relay, 2A	3 solid state, 0.5A	3 solid state, 0.5A
Type of addressing	Extended (A/B)				
Supply by AS-Interface	Inputs and sensor supply (200 mA max.) (3)				–
Supply by 24 VDC external source (black AUX cable)	–	–	–	Outputs	(2)
AS-Interface profile	S.0.A.7.0	S.3.A.7.0	S.7.A.7.0	S.7.A.7.0	S.7.A.7.0
Maximum consumption from AS-Interface (excluding sensor supply)	50 mA	40 mA	90 mA	50 mA	20 mA
Dimensions (WxDxH)	25x77x87 mm	25x77x87 mm	25x77x87 mm	25x77x87 mm	25x77x87 mm
References	ASI20MT4IE	ASI20MT2I1OTE	ASI20MT4I3ORE	ASI20MT4I3OSE	ASI20MT4I3OSAE
Accessory (1) for connection to flat cables	TCSATN01N2	TCSATN01N2	TCSATN01N2	TCSATV01N2	TCSATV01N2

(1) Or direct screw terminal connection (without accessory).

(2) Inputs, outputs and sensor supply (200 mA max.).

(3) Except ASI20MT4I3ORE (170 mA max.).

IP67 for mounting on machine



Interface			Digital						
V2.1 with extended (A/B) addressing									
Number of inputs			4	2	–	4	4	4	8
Input cabling			Standard (1 x M12)			"Y" (2 x M12)		"Y" (4 x M12)	
Number of outputs			–	2 solid-state, 2A	3 solid-state, 2A	3 solid-state, 2A	–	3 solid-state, 2A	–
Type of addressing			Extended (A/B)						
Supply by AS-Interface			Inputs and sensor supply (200 mA max. except ASI67FFP22*: 100 mA)						
Supply by 24 VDC external source (black AUX cable)			–	Outputs	–	Outputs	–	Outputs	–
AS-Interface profile			S.0.A.7.0	S.B.A.7.0	S.8.A.7.0	S.7.A.7.0	S.0.A.7.2	S.7.A.7.E	S.0.A.7.2 (2x)
Maximum consumption from AS-Interface (excluding sensor supply)			45 mA	32 mA	18 mA	48 mA	45 mA	48 mA	90 mA
Dimensions (WxDxH)			45x42x80mm	45x42x80mm	45x42x80mm	60x30,5x151mm	45x42x80mm	60x30,5x151mm	60x30,5x151mm
Connection	IDC	Interface	ASI67FFP40E	ASI67FFP22E	ASI67FFP03E	ASI67FFP43E	ASI67FFP40EY	ASI67FFP43EY	ASI67FFP80EY
		Standard connection base	ASI67FFB01 (1)	ASI67FFB01 (1)	ASI67FFB01 (1)	ASI67FFB03	ASI67FFB01 (1)	ASI67FFB03	ASI67FFB03
	M12 connector	Interface + Connection base	ASI67FMP40E	ASI67FMP22E	ASI67FMP03E	ASI67FMP43E	ASI67FMP40EY	ASI67FMP43EY	–

(1) A connection base with fixing centres that are compatible with the ASIB4VM12 connection base is available. Reference **ASI67FFB02**.



Interface			Digital						
V2.1 with standard addressing									
Number of inputs			4	2	–	4	4	8	
Input cabling			Standard (1 x M12)			"Y" (2 x M12)		"Y" (4 x M12)	
Number of outputs			–	2 solid-state, 2A	4 solid-state, 2A	4 solid-state, 2A	4 solid-state, 2A	–	
Type of addressing			Standard						
Supply by AS-Interface			Inputs and sensor supply (200 mA max. except ASI67FFP22*: 100 mA)						
Supply by 24 VDC external source (black AUX cable)			–	Outputs	Outputs	Outputs	Outputs	–	
AS-Interface profile			S.0.0.F.E	S.3.0.F.E	S.8.0.F.E	S.7.0.F.E	S.7.1.F.E	S.0.1.F.F (2x)	
Maximum consumption from AS-Interface (excluding sensor supply)			45 mA	32 mA	19 mA	49 mA	49 mA	90 mA	
Dimensions (WxDxH)			45x42x80mm	45x42x80mm	45x42x80mm	60x30,5x151mm	60x30,5x151mm	60x30,5x151mm	
Connection	IDC	Interface	ASI67FFP40D	ASI67FFP22D	ASI67FFP04D	ASI67FFP44D	ASI67FFP44DY	ASI67FFP80DY	
		Standard connection base	ASI67FFB01 (1)	ASI67FFB01 (1)	ASI67FFB01 (1)	ASI67FFB03	ASI67FFB03	ASI67FFB03	
	M12 connector	Interface + Connection base	ASI67FMP40D	ASI67FMP22D	ASI67FMP04D	ASI67FMP44D	ASI67FMP44DY	–	

(1) A connection base with fixing centres that are compatible with the ASIB4VM12 connection base is available. Reference **ASI67FFB02**.



Interface			Digital			
V2.1 (V1 compatible) with standard addressing						
Number of inputs			4	2	–	4
Input cabling			Standard (1 x M12 input)			
Number of outputs			–	2 solid-state, 2A	4 solid-state, 2A	4 solid-state, 2A
Type of addressing			Standard			
Supply by AS-Interface			Inputs and sensor supply (200 mA max. except ASI67FFP22*: 100 mA)			
Supply by 24 VDC external source (black AUX cable)			–	Outputs	Outputs	Outputs
AS-Interface profile			S.0.0.F.F	S.3.0.F.F	S.8.0.F.F	S.7.0.F.F
Maximum consumption from AS-Interface (excluding sensor supply)			45 mA	32 mA	19 mA	49 mA
Dimensions (WxDxH)			45x42x80 mm	45x42x80 mm	45x42x80 mm	60x30,5x151 mm
Connection	IDC	Interface	ASI67FFP40A	ASI67FFP22A	ASI67FFP04A	ASI67FFP44A
		Standard connection base	ASI67FFB01	ASI67FFB01	ASI67FFB01	ASI67FFB03

AS-Interface Dedicated components For control



Starter in insulated enclosure (1) V1		Control by	
		Black rotary knob (blue bkgnd.)	Pushbuttons
Type of addressing		Standard	
Supply by AS-Interface		Inputs, sensor supply (2)	
Supply by 24 VDC external source (black AUX cable)		(2)	
AS-Interface profile		S.7.F.F. (LF3....) / S.7.A.7.0. (LF4....)	
Maximum consumption from AS-Interface		20 mA	
Dimensions (WxDxH)		175x175x195 mm	
References (3) (see table below)	Non reversing	LF3P●●D	LF3M●●D
	Reversing	LF4P●●D	LF4M●●D

Connection to AS-Interface and external supply (AUX) by accessory for flat cable: **TCSATN011F1** (AS-Interface and AUX cables) or **TCSATV011F1** (AS-Interface cable).

(1) For an LF3 or LF4 starter in a metal enclosure, add the letter **M** after the 3rd digit in the references listed above (example: LF3P02D becomes **LF3MP02D**).

(2) Contactors supplied by AS-Interface or external source, configurable directly on terminal block.

(3) To complete the reference, replace ●● by the numbers indicated in the table below. (Example: LF3P●●D becomes LF3P00D).

kW	A	●●	kW	A	●●
–	without MCB	00	0.75	1.6...2.5	07
0.06	0.16...0.25	02	1.1 / 1.5	2.5...4	08
0.09	0.25...0.40	03	2.2	4...6.3	10
0.12 / 0.18	0.40...0.63	04	3 / 4	6...10	14
0.25	0.63...1	05	5.5	9...14	16
0.37/ 0.55	1...1.6	06			

kW= Motor power ratings in category AC-3, 400/415V, in kilowatts.

A= Adjustable range of circuit-breaker thermal trips, in amperes.

7



Communication interface for V2.1		TeSys U	
Type of addressing		Standard	Extended (A/B)
Supply by AS-Interface		–	–
Supply by external source (AUX)		Coil	Coil
AS-Interface profile		S.7.D.F.0	7.A.7.E
Maximum consumption from AS-Interface		30 mA	30 mA
Dimensions (WxDxH)		depending on LU model	depending on LU model
References		ASILUFC5	ASILUFC51
Recommended accessory for connection to AS-Interface cable (4)		TCSATV01N2	TCSATV01N2

(4) Or direct screw terminal connection to AS-Interface and external supply (AUX).

For dialogue



Control stations V2.1	Control stations with 2 pushbuttons		
	Black and white	Green and red	Green and red illuminated
Type of addressing	Extended (A/B)	Extended (A/B)	Extended (A/B)
Supply by AS-Interface	Buttons	Buttons	Buttons and pilot lights
Supply by external source (AUX)	–	–	–
AS-Interface profile	S.B.A.E.	S.B.A.E.	S.B.A.E.
Consumption from AS-Interface	< 45 mA	< 45 mA	< 80 mA
Dimensions (WxDxH)	68x62x118 mm	68x62x118 mm	68x65x118 mm
References	XALS2001H	XALS2002H	XALS2003H
Recommended accessory for connection to AS-Interface cable (5)	TCSATN011F1	TCSATN011F1	TCSATN011F1

(5) Or direct screw terminal connection to AS-Interface and external supply (AUX).



Interface (6) V2.1	For 2 control units and 2 pilot lights
Number of pages available	–
Number of inputs	2
Number of outputs	2 solid state, 0.5 A
Type of addressing	Standard
Supply by AS-Interface	Inputs and pilot lights
AS-Interface profile	S.B.A.E.
Maximum consumption from AS-Interface	80 mA
Dimensions (WxDxH)	52x15x38 mm
References	XALSZ1E

(6) Direct screw terminal connection to AS-Interface or by accessory for flat cable: TCSATN01N2.



Indicator banks, Ø 70 mm (9) V2.1	Base units and cover		Illuminated units		Audible unit
			"Flash" discharge tube	Steady light	
Type of addressing	Standard	Standard	–	–	–
Connection to AS-Interface cable and AUX (male M12 connector)	yes	yes, remote L=1m	–	–	–
Supply by AS-Interface	(7)	(7)	–	–	–
Supply by external source (AUX)	(7)	(7)	–	–	–
AS-Interface profile	S.7.F	S.7.F	–	–	–
Consumption from AS-Interface, supply by AS-Interface / external	250 / 30 mA	250 / 30 mA	–	–	–
Light source	–	–	5 Joule	LED	–
Buzzer	–	–	–	–	70...80 dB at 1m
References	XVBC21A	XVBC21B	XVBC6B● (8)	XVBC2B● (8)	XVBC9B
Recommended accessory for connection to AS-Interface cable & AUX	TCSATN011F1	TCSATN011F	–	–	–

(7) Illuminated units supplied by AS-Interface or externally, configurable by shunt.

(8) To complete the reference, replace the ● by the following number designating the colour: green: 3, red: 4, orange: 5, blue: 6, clear: 7, yellow: 8.

(9) To obtain a complete indicator bank, order a base unit + the illuminated or audible units (5 units maximum).

AS-Interface — Installation system

Master modules



Platform	Twido	Premium	Micro	Quantum	Ethernet GW
Maximum number of master modules per PLC	2	2, 4 or 8 depending on processor	1	8 (1)	–
Compatibility with AS-Interface interfaces and components	V1 / V2.1	V1 / V2.1	V1	V1	V1 / V2.1 / V3.0
Direct connection to AS-Interface cable	by terminal block	by terminal block	by terminal block	by terminal block	by terminal block
Maximum number of addresses	62	62	31	31	62
Type of addressing	Standard / Extended (A/B)	Standard / Extended (A/B)	Standard	Standard	Standard / Extended (A/B)
Compatibility with analogue interfaces	Yes	Yes	–	–	Yes
Compatibility with safety interfaces	Yes	Yes	Yes	Yes	Yes
AS-Interface profile	M.3	M.2.E	M.2	M.2	M.4
References	TWDNOI10M3	TSXSAY1000	TSXSAZ10	140EIA92100	TCSAGEA1SF13F

(1) 4 per local rack, 4 per remote I/O, 2 per distributed I/O.

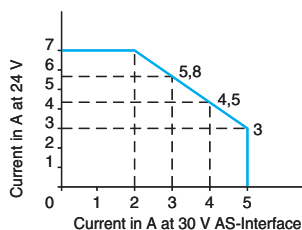

Power supply units



Type of supply	AS-Interface		AS-Interface + Auxiliary
Input voltage	100...240 VAC	100...240 VAC	100...240 VAC
AS-Interface output voltage	30 VDC	30 VDC	30 VDC
Auxiliary output voltage	–	–	24 VDC
AS-Interface nominal power	73 W	146 W	73 W
Auxiliary nominal power	–	–	72 W
AS-Interface nominal current	2.4 A	4.8 A	2.4 A
AUX nominal current	–	–	3 A
Direct connection to AS-Interface cable	by terminal block	by terminal block	by terminal block
Dimensions (WxDxH)	54x120x120 mm	81x120x120 mm	81x120x120 mm
References	without earth fault detection	ASIABL3002	ASIABL3004
	with earth fault detection	ASIABLD3002	ASIABLD3004
			ASIABLM3024

(2) Power supply unit with constant maximum output, see curve above.

Insulation control relay



Type	For AS-Interface line
Degree of protection	IP20
Number of C/O contacts	2 relays, each with 1 N/O contact
Rated operational voltage	50 VDC
Dimensions (WxDxH)	90x58x76 mm
References	RM0PAS101 (3)

(3) Provided with an impedance adapter.

Cables, repeater and line extension



Type	Yellow AS-Interface cable	Black Auxiliary cable	Repeater (5)	Line Extension	
Wire c.s.a.	2 x 1.5 mm ²	2 x 1.5 mm ²	–	–	
References	Cable	L = 20 m	XZCB10201 (4)	XZCB10202 (4)	–
		L = 50 m	XZCB10501 (4)	XZCB10502 (4)	–
		L = 100 m	XZCB11001 (4)	XZCB11002 (4)	–
Reference of repeater	–	–	ASIRPT01	TCSARR011M	

(4) Standard cable. For TPE cable (oil and vapour resistant) add the letter **H** to the end of the reference, example: XZCB10201 becomes **XZCB10201H**.

(5) Enables an AS-Interface network to be extended by 100 m. Direct connection to the AS-Interface yellow cable by IDC

Tap-offs for flat cable

(For connecting interfaces and components)



Connection to cable by IDC	AS-Interface IP67	AS-Interface + Auxiliary IP67				
Connection to the AS-Interface component	M12 connector (6)	Bared wires (7)				
References	Cable	L = 1 m	TCSATN011F1	–	TCSATV011F1	–
		L = 2 m	TCSATN011F2	TCSATN01N2	TCSATV011F2	TCSATV01N2

(6) Female 5-pin M12 end connector, screw threaded for connection with M12 male connector.

(7) 2 x 0.34 mm² for product with terminal block.

(8) 4 x 0.34 mm² for product with terminal block.

7

T connectors



Connection to cable by IDC	T connector AS-Interface IP 67	Branch AS-Interface or Auxiliaires IP 67
Connection to the AS-Interface sensor or actuator	1 x M12 connector 5-pin female, screw threaded	Extension for 2 flat cables
References	TCSATN011F	TCSATN02V

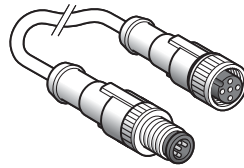

Type		Male / Female jumper cable		
Male connector type, interface side		M12, 3-pin, straight, screw thread.	M12, 4-pin, straight, screw thread.	M12, 5-pin, straight, screw thread.
Female connector type, sensor side		M12, 3-pin, straight, screw thread.	M12, 4-pin, straight, screw thread.	M12, 5-pin, straight, screw thread.
Cable		PUR, black	PUR, black	PUR, black
References	Cable L = 1 m	XZCR1511040A1	XZCR1511041C1	XZCR1511064D1
	L = 2 m	XZCR1511040A2	XZCR1511041C2	XZCR1511064D2

Jumper cables M12 / M8 or DIN

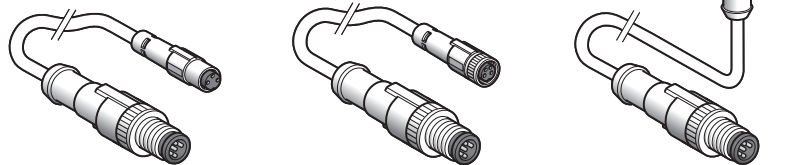

Type		Male / Female jumper cable		
Male connector type, interface side		M12, 3-pin, straight, screw thread.	M12, 3-pin, straight, screw thread.	M12, 3-pin, straight, screw thread.
Female connector type, sensor side		M8, 3-pin, straight (1)	M8, 3-pin, straight, screw thread.	DIN 43650A, elbowed, screw thrd.
Cable		PUR, black	PUR, black	PUR, black
References	Cable L = 1 m	XZCR1501040G1	XZCR1509040H1	XZCR1523062K1
	L = 2 m	XZCR1501040G2	XZCR1509040H2	XZCR1523062K2

(1) Clip together connector.

7

Connectors, splitter box

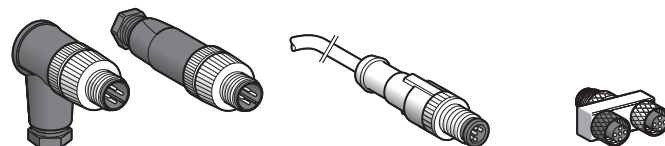

Type		Connectors	Pre-wired connectors	Splitter box
Male connector type, interface side		M12, 4-pin	M12, 5-pin, straight, screw thread.	1 x M12, 5-pin, straight, screw thrd.
Female connector type, sensor side		–	–	2 x M12, 5-pin, straight, screw thrd.
Cable		–	PUR, black	–
References	Straight connector, screw thread.	XZCC12MDM40B	–	FTXCY1212
	Elbowed connector, screw thread.	XZCC12MCM40B	–	–
	Cable L = 0.5 m	–	XZCP1564L05	–
	Cable L = 2 m	–	XZCP1564L2	–

Tools

Adjustment and addressing terminals



Display	25 mm LCD screen
Degree of protection	IP40
AS-Interface voltage / current measurement	yes
Addresses stored in memory	yes
Access to functions	direct by selector switch
Compatibility	V1/V2
Operating time	2500 addressing operations
References	ASITERV2
Reference with set of 7 leads + protective cover for terminal	ASITERV2SET

Addressing accessories for terminals ASITERV2 and XZMC11

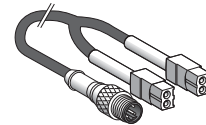
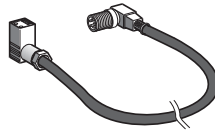

Product connection	Infrared addressing	Socket
For products	ASISL...	ABE8... / APP1 / ASILUF... / XBZS43 / ASI20M
References	ASITERIR1	XZMG12

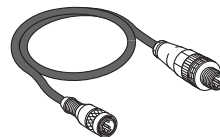
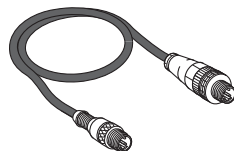

Product connection	M12, male	M12, female	Jack plug
For products	(2)	ASI67FMP XVB... / XAL... / LF...	ASI20M... / ASI67FFP...
References	ASITERACC1M	ASITERACC1F	ASITERACC

(2) Possibility to connect AS-Interface cable using T connector TCSATN011F.



Type	OPC data server	
	OFS Small	OFS Large
Items number	1000 items	Unlimited
OPC protocols	OPC DA, OPC UA	OPC DA, OPC UA, OPC XML DA
References	Single station licence	TLX CDSUOFS34
	10 stations licence	TLX CDSTOFS34
	200 stations licence	TLX CDLFOFS34

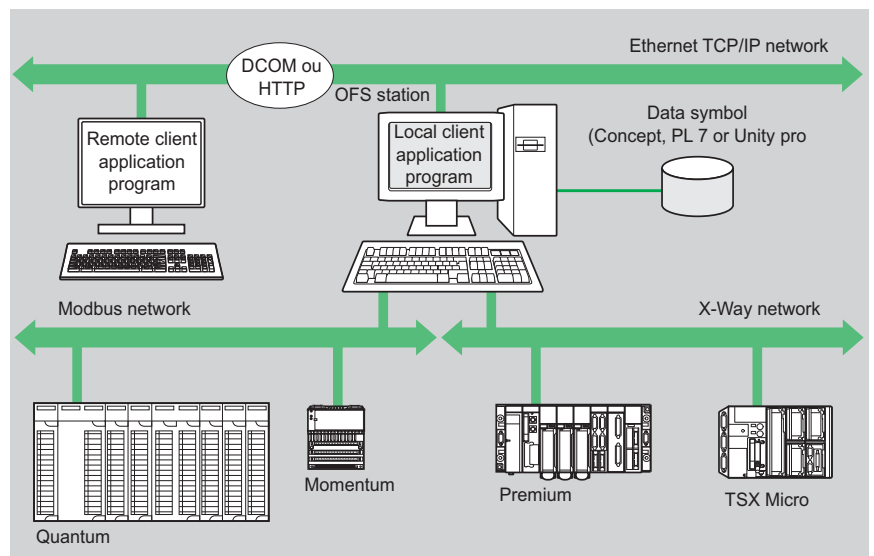

Description:

Based on the OPC protocols, Schneider-Electric's OFS software (**OPC Factory Server**) enables local or remote OPC client applications such as SCADA, supervisors or custom interfaces, to access Schneider devices and PLCs data in real time.

OFS software is a multi-device data server which provides simultaneous use of various communication protocols, and allows client applications to access control data via physical addresses or via symbols. OFSV3.40 provides to SCADA at source time stamped data, with 1 ms resolution for BMXERT modules, and 10 ms resolution with regular x80 Digital IOs.

Supported devices :

- Modicon Quantum, Premium, Micro, Compact and Momentum PLCs
- TSX Series 7 and April Series 1000 Schneider-Electric PLCs
- Serial Modbus or Uni-Telway devices connected via Schneider-Electric and Merlin Gerin gateways TSX ETG 10xx, EGX xxx ranges etc.

Supported networks and protocols :

- Modbus: Serial Modbus, Modbus Plus, Modbus TCP/IP.
- XWAY/UNI-TE: Uni-Telway, FIPWAY, ETHWAY, ISAWAY, PCIWAY.

Openess:

OFS V3.40, integrates the most recent specifications of the OPC Foundation:

- **OPC-DA** (OPC Data Access)
- **OPC-UA** (OPC Unified architecture)
- **.NET API interface**
- **OPC XML-DA V1.0** (OPC XML Data Access)

The development of specialized interfaces is even more easy and open.

Developers and System integrators can develop custom applications (in Visual Basic, VBA for Excel, C++, etc) requiring access to Schneider Electric control devices. The OPC XML-DA V1.0 interface is designed to provide an interface for Windows and non-Windows client applications and remote access via the Internet through firewalls.

7





Embedded in the TCP/IP communication modules for Modicon M340, Premium and Quantum PLCs, FactoryCast Web servers provide secured access to the diagnostics, monitoring and maintenance functions of your automation installations via a simple web browser.

FactoryCast modules for PLC

“Ready to use” diagnostic and monitoring functions embedded in a PLC module accessible remotely via a simple Internet browser:

- Real-time communication based on Ethernet TCP/IP (Modbus and Uni-TE)
- Secure access to the PLC system and application diagnostics
- Numerical or graphical data monitoring and control
- E-mail notifications
- Web server open to user customization and creation of Web pages for diagnostics suited to your needs
- Library of animated graphic objects
- Open communications using SOAP/XML protocol as a server interface (Web services)
- Visualization of Unity Pro IEC program via Web pages
- New - SilverLight based Rack Viewer
- New - Custom Web pages using Microsoft Expression Blend

FactoryCast HMI modules for PLC

Diagnostic functions identical as FactoryCast modules + Built-in HMI / SCADA functions embedded in a PLC module:

- Visualization of Unity Pro PLC program and Operator screens via Web pages
- PLC data acquisition
- Calculations scripts for data-processing Real-time database (1000 variables)
- Alarm and report notifications via E-mail
- Archiving of data directly into database servers (SQL, Oracle, MySQL)
- Data logging in CSV files in the module.
- Recipe management with read Database
- Dynamic HTML Reporting function
- Web server open to user Web pages customization
- Built-in Supervision via graphic screens and custom Web pages
- Data monitoring and Graphic monitoring (read/write)
- Library of animated graphic objects
- Open communication using SOAP/XML protocol as a server interface (Web services)

FactoryCast Gateways - ETG 1000 / 10.. modules

Cost-effective web gateways offer integrating in a stand-alone module:

- All Communications network interfaces: Ethernet TCP/IP, Modbus and Uni-Telway
- Remote access functions, RAS server,
- Transparent gateway / Router functions
- Notification of alarms via E-mail
- Data monitoring and Graphic monitoring (read/write)
- A user customizable Web server for creating an interface fully adapted to your needs
- Library of animated graphic objects



In the areas of distributed infrastructures, transport, RTU installations, industry and machines, ETG 1000 / 3000 modules more than satisfy your requirements for remote diagnostics and maintenance, remote monitoring and control, and remote programming.

FactoryCast HMI Gateways - ETG 3000 / 30.. modules

“All in one” Web gateway module integrating in a stand-alone device:

- a built-in modem (PSTN or GSM/GPRS) depending on the reference
- Secured access : VPN, data encryption and IP filtering.
- A Remote Access server function (RAS)
- 2 Ethernet ports and a Modbus serial port
- Transparent gateway router functions NAT to Ethernet or Modbus serial devices
- I/O card : 6 discrete inputs/ 2 discrete outputs
- Operating temperature : -25°C to +75°C
- User customizable Web server
- Built-in Supervision via graphic screens and custom Web pages
- Data monitoring and Graphic monitoring (read/write)
- Data Acquisition, Data Processing and Data logging in the module (CSV files)
- Archiving of data directly into database servers (SQL, Oracle, MySQL)
- Alarms and reports via E-mail / SMS
- Open communication using SOAP/XML protocol as a server interface



Applications		Web Server modules for PLCs					
		FactoryCast				FactoryCast HMI	
Target devices	Type	TSX Micro PLCs	Modicon M340 PLCs	Modicon Premium PLCs	Modicon Quantum PLCs	Modicon Premium PLCs	Modicon Quantum PLCs
Network & Remote access services	Remote access	Intranet or via external RAS/modem					
		Remote programming, downloading via FTP, access to Web server via Internet browser					
	Gateway function	-					
	Serial protocols	-					
	Ethernet protocols	Modbus TCP, Uni-TE	Modbus TCP	Modbus TCP, Uni-TE	Modbus TCP	Modbus TCP, Uni-TE	Modbus TCP
	TCP/IP protocols	BootP/DHCP, DNS, SNMP agent, SMTP client, NTP client, FTP					
	Security	Protection by IP address filtering and passwords					
Web server	Characteristics	HTTP and FTP server, 8 Mb memory available for user add (32 MB of memory for M340), hosting of user Web pages and documents (Doc, Pdf, Excel)					
Predefined services	Configuration	Via Web Designer software or predefined Web pages					
	Diagnostics	System, rack and PLC I/O diagnostics via predefined Web pages					
	Monitoring of variables	Monitoring of devices and application via animated data (read/write variables)					
	Alarm management	PLCs and applications alarms monitoring via predefined Web pages					
Customizable services	Graphic views	Graphic monitoring via animated pages (integrated graphic editor)					
	Unity Pro operator screen	-				Display in the form of Web pages	
	User Web pages	Graphic monitoring via animated Web pages created by the user					
Advanced services and HMI	Calculation scripts	-				Arithmetic and logical scripts	
	E-mail service	Alarm notification by E-mail					
	Data logging	-				Data logging in the module with time stamping (CSV files)	
	Database connection	-				Direct logging in an SQL, Oracle, MySQL database servers	
	Report service	-				Dynamic HTML report management	
	Recipe service	-				Management of "Recipe" data (storage and read locally or on remote database)	
	PLC programme visualization by Web page	-				Unity Pro IEC Program Sections are visible and animated. Viewable from Windows based browsers	

7

Application development software

Web Designer

Supplied with each module



References	TSXETZ510	BMXNOE0110	TSXETY5103	140NOE77111	TSXWMY100	140NWM10000

FactoryCast Gateway

Web Gateways for Remote control



Standalone Gateway, Web Server for Remote Access FactoryCast Gateway ETG 10●0		FactoryCast HMI Gateway ETG30●●	
All equipment supporting Modbus	All equipment supporting Uni-Telway	All Modicon PLCs and third-party equipment supporting Modbus	
Intranet or via external Modem, integrated RAS function		Intranet or Modem External modem, integrated RAS	Intranet or Modem Integrated PSTN/RTC/GSM modem and RAS modem, NAT
Remote programming, downloading via FTP, access to Web server via		Internet browser	
Ethernet to Modbus serial Modem to Modbus serial and Ethernet	Ethernet to Uni-Telway serial Modem to Uni-Telway and Ethernet	Ethernet to Modbus serial Modem to Modbus serial and Ethernet (Modbus, UNITE)	
Modbus (Master)	Uni-Telway (Slave)	Modbus (Master)	
Modbus TCP	Modbus TCP, Uni-TE (Modicon Premium, Modicon TSX Micro)	Modbus TCP Uni-TE TCP	
BootP/DHCP, SNMP agent, SMTP client, NTP client, FTP		DHCP, DNS, SNMP agent, SMTP client, NTP client, FTP	
Protection by IP address filtering and password		Protection by IP address filtering and password + Tunnels VPN & encryption of the datas.	
HTTP and FTP server, 8 Mb memory available for user, hosting of user Web pages and documents (Doc, Pdf, Excel)		HTTP and FTP server, 32 Mb memory available for user Web pages, memory extension using Compact Flash cards 1 Gb max., hosting of user Web pages and documents (Doc, Pdf, Excel)	
Via Web Designer software or predefined Web pages			
Diagnostics of serial devices via predefined Web pages		Network diagnostics, diagnostics of serial devices and Ethernet via predefined Web pages	
Monitoring of devices and application via data tables (read/write variables)			
Via E-mail		Via E-mail/SMS	
Graphic monitoring via animated views (integrated graphic editor)			
-			
Graphic monitoring via animated Web pages created by the user			
-		Arithmetic and logical scripts	
Alarm notification by E-mail		Alarm notification by E-mail/SMS	
-		Data logging in the module with time stamping (CSV files)	
-		Direct recording in SQL, Oracle, MySQL database servers	
-		Dynamic HTML report management	
-		Management of "Recipe" data (storage and revad locally or on remote database)	
-		-	

Web Designer

Supplied with each module



TSXETG1000

TSXETG1010

TSXETG3000

TSXETG3010 (Modem RTC)

TSXETG3021
Modem GSM/GPRS
(Bands 900/1800MHz)
TSXETG3022
Modem GSM/GPRS
(Bands 850/1900 MHz)

Preventa

The Preventa range enhances safety throughout a machine's entire life cycle from design, manufacture, installation, adjustment, operation and servicing right through to decommissioning.

8

In addition to moral obligation and economic consequences, the law requires that machinery is safe in the interests of accident prevention. Preventa offers an extensive range of safety products, compliant with international standards, designed to provide the most comprehensive protection for personnel and equipment.

Preventa, the safety attitude around your machine life cycle

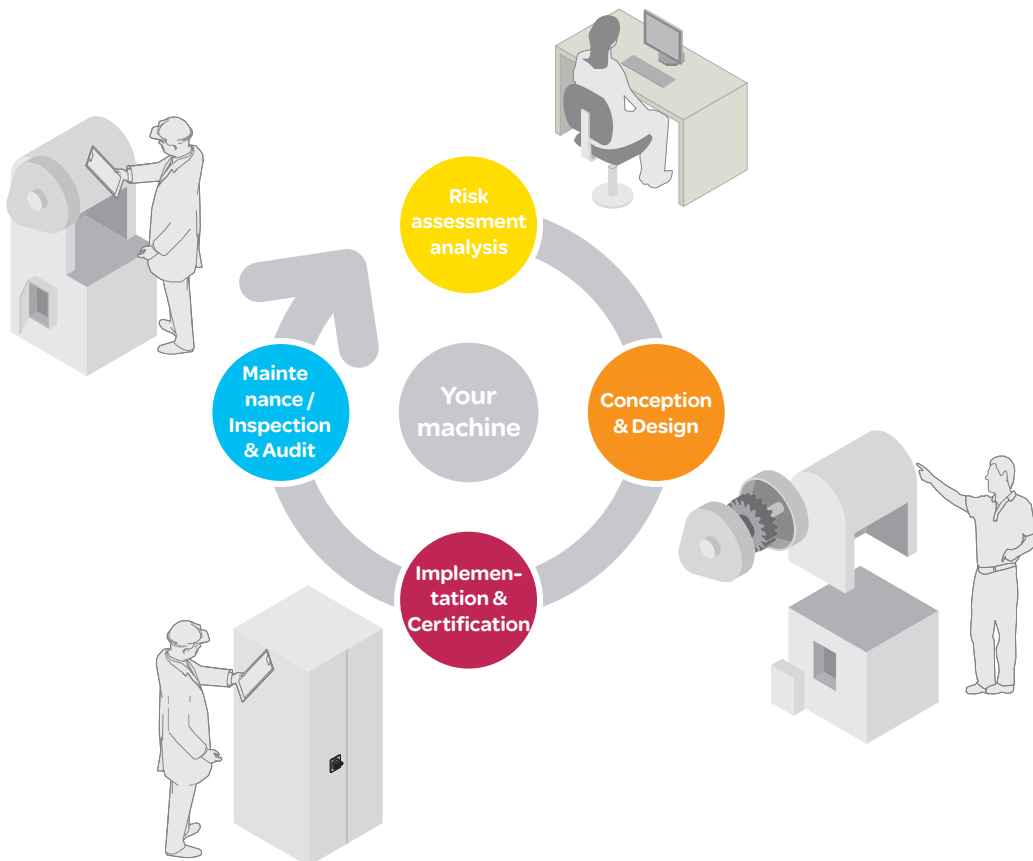

8 | Machine safety



This document is a selection of the top selling products.

For more information:
<http://www.schneider-electric.com>

Safety chain solutions 8/4 to 8/7

Automation

Safety PLCs	8/8 and 8/9
Safety controllers and modules	8/10 to 8/14

Operator dialog

Emergency stop buttons	8/15
Foot switches	8/16 and 8/17
Two-hand control and enabling switches	8/18

Motor control

Switch disconnectors	8/19
Motor starters	8/20 and 8/21

> New machines - the Machinery Directive

From 29 December 2009, the new European Machinery Directive 2006/42/EC is effective. Machines have to comply with the Essential Health and Safety Requirements (EHSRs) listed in Annex I of the Directive, thus setting a common minimum level of protection across the EEA (European Economic Area).

Machine manufacturers, or their authorised representatives within the EU, must ensure that their machines are compliant, the Technical File must be made available to the enforcing authorities on request, the CE marking is affixed, and a Declaration of Conformity has been signed, before the machine may be placed on the market within the EU.

Why safety?



Human life is the most important
value in a company!

Schneider Electric helps protect people and improve your productivity

Functional safety



Simplifying your work to reach your
required performance level and SIL

Thanks to directives and standards as guidelines and our certified safety
chain solutions

Certified safety chain solutions, designed by Schneider Electric, for you!

The concept:

Provides you certified safety architectures based upon the most common safety functions required on and around a machine. The safety chain solutions enable you to save time and costs when designing and manufacturing your machine in accordance with the European Machinery Directive.

Each solution comes with:

- > Bill of materials and the system description file
- > Safety conceptual principle diagram
- > Layout of solution indicating performance level (PL) and safety integrity level (SIL)
- > Example description of the PL and SIL calculation for the safety function
- > Sistema Library file with corresponding solution
- > TÜV certification



Approved

- > TÜV approval certified solutions

Motor starter (PL c, SIL 1)

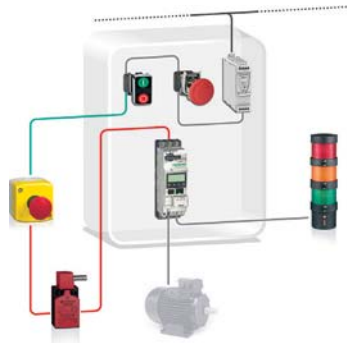

Light curtain (PL c, SIL 1)

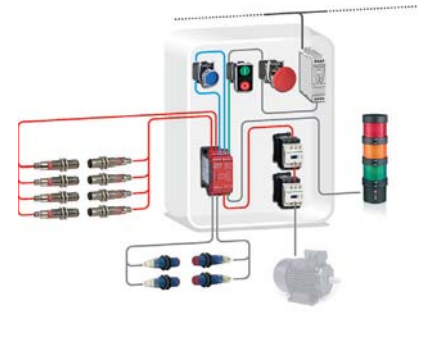

Safe stop 0 (PL d, SIL 2)

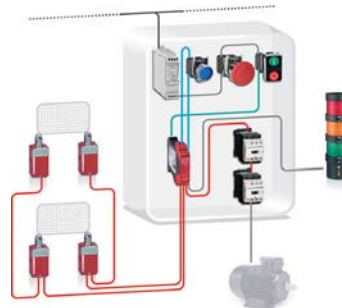

Safe stop 0 (PL e, SIL 3)
High performance

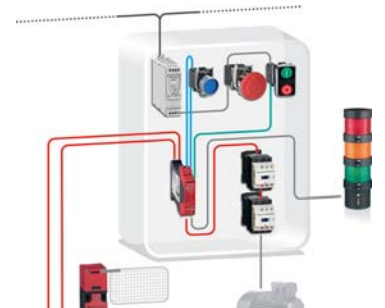

Machine Safety Expertise and Co-design

- > Worldwide support and assistance with a local engineers to help you implement machine safety solutions that meet or exceed the latest legislation and compliance with new functional machine safety standards



Be confident by using certified safety chain solutions

- > Save cost by reducing external safety expert engineering
- > Reduce machine design time by using our calculations to meet your safety function requirements

Safe stop 1 (PL d, SIL 2)
Variable speed drive

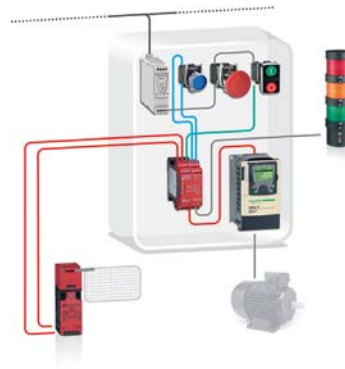

Safe stop 1 (PL e, SIL 3)
High performance

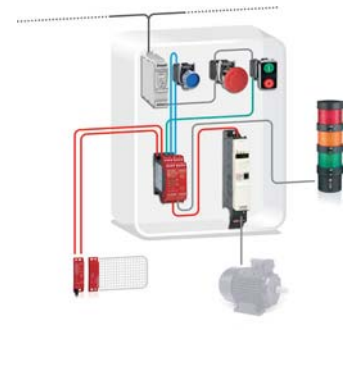

Safe stop 1 (PL e, SIL 3)
Servo drive

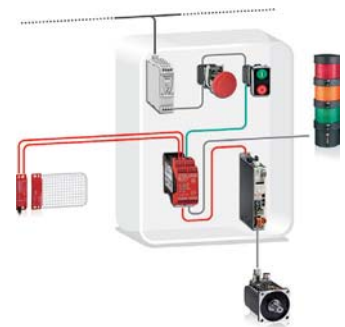

Safe stop 2 (PL e, SIL 3)
Servo enhanced safety

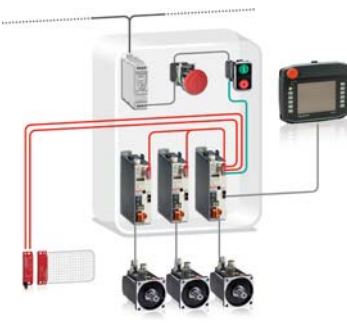

No reason to delay your implementation of the functional standards

- > We guide you step by step on <http://www.schneider-electric.com>
- > Download our Machine Safety guide
- > Select the right safety chain to solve each function
- > Evaluate if your architecture meets the risk reduction requirements by use of the Sistema software tool and Preventa library all downloadable via www.schneider-electric.com.

Safety Mat (PL d, SIL 2)



Magnetic switches (PL e, SIL 3)

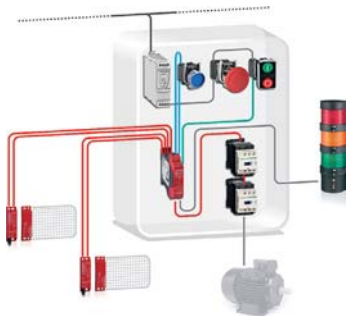

Zero speed detection (PL e, SIL 3)



Multifunction (PL e, SIL 3)

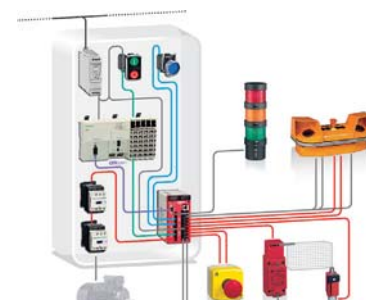

Save cost and time with our Preventa offer

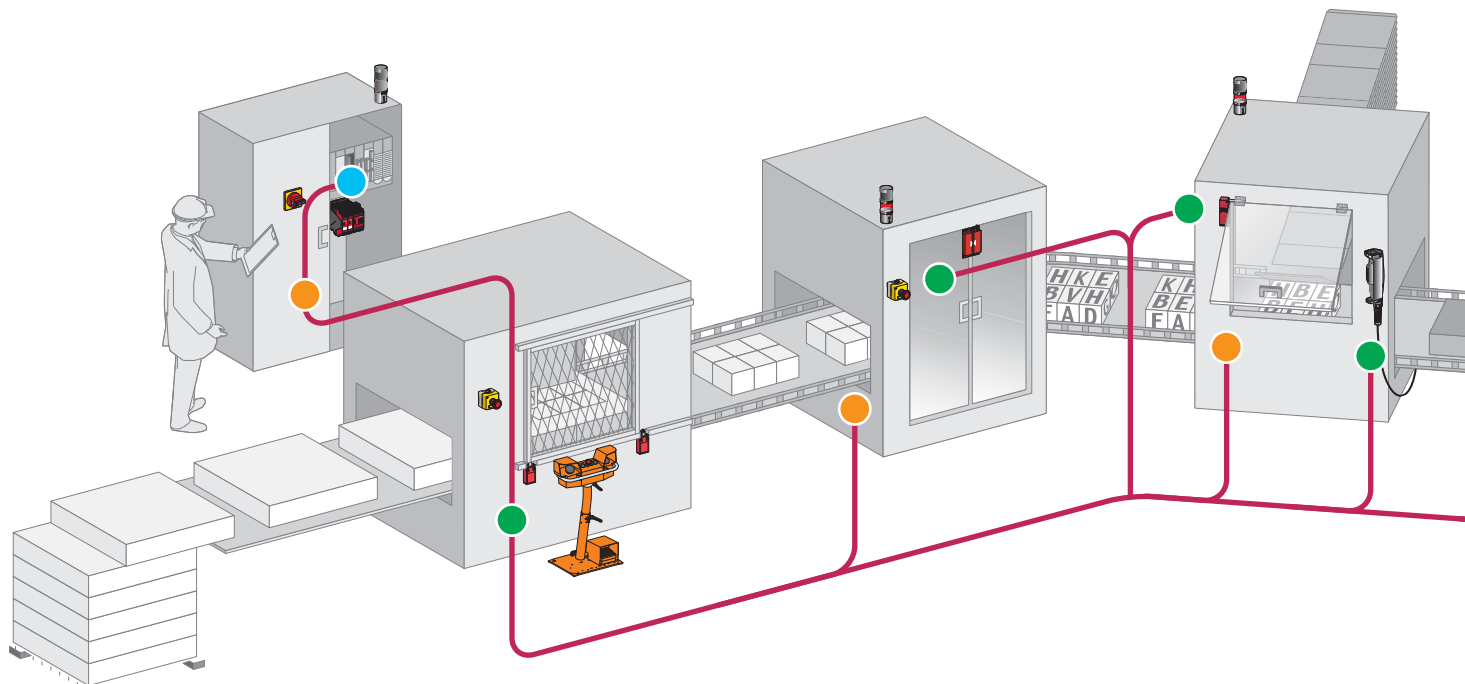

Safe signal transmission

Acquire the information*:

- > Protective guard devices used as part of safeguarding systems to control the access under specific conditions of reduced risk.
- > Light curtains to detect approach to dangerous and limited areas.
- > Two hand control stations and enabling switches for starting and enabling of dangerous movements.
- > Generic protective measures - Emergency stop.

Monitor and processing:

- > Safety modules manage one safety function, monitoring inputs from safety devices and manages the outputs to contactors and drives.
- > Safety controllers: configurable safety device capable of managing multiple safety functions simultaneously
- > Safety PLCs: programmable electronic systems to carry out safety or non-safety related tasks for machinery and equipment.



Protective guard devices



Light curtains



Two hand control stations and enabling switches



Emergency stop



Emergency stop rope pull switch



Safety relays



Safety Controller



Safety PLCs

*For detection products, please refer to the Telemecanique Sensors Essential guide of Detection

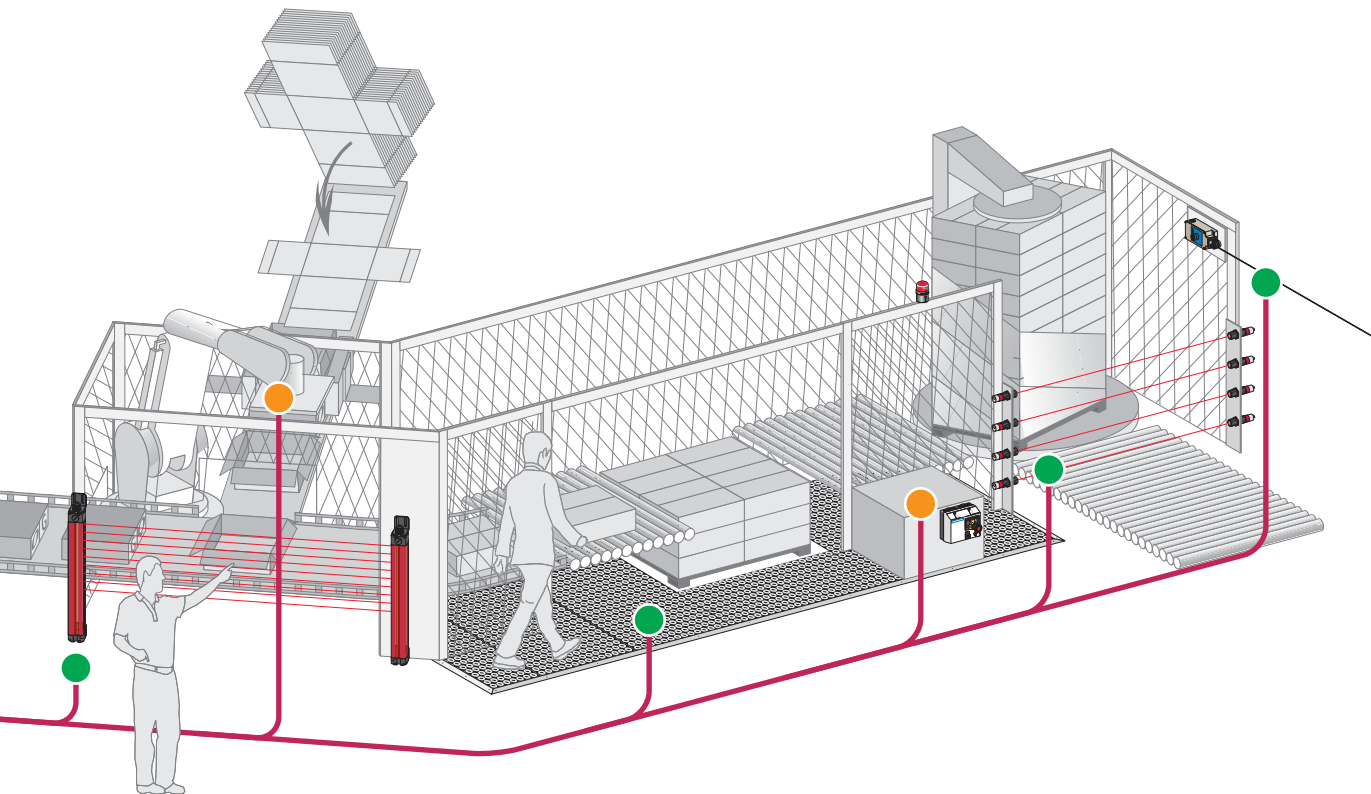

Stop the machine:

- > Contactors to cut-off the electrical power supply to the motors with mechanically linked mirror auxiliary contacts integrated for the feedback loop diagnosis used by the safety modules, controller and PLCs.
- > Variable speed drives and servo drives provide controlled stopping of the machine by using embedded safety functions.
- > Rotary switch disconnectors: for equipment isolation from the electrical supply and/or emergency stop by direct interruption of the power supply.



Variable speed Drives



Servo drives



Contactors



Rotary switch disconnectors

1 Complete & upgraded safety offer:

Improved hardware features and expanded offer

Up to 50% of space optimization

Increase the compactness by reducing size.

Save up to 30% on installation time

Reduce installation time by easy and quick wiring.

For all XPSMF PLCs

- Maximum category of the solution **Category 4**
(EN 954-1)
- Max performance level for the solution **PL e**
(EN ISO 13849-1)
- Max safety integrity level for the solution **SIL 3**
(EN IEC 62061)



Safety PLC type		Compact					
Number of inputs/outputs	Digital (configurable with XPSMFWIN software)	24					
	Pulsed (1)	2x4					
Memory capacity	Application	250 Kb					
	Data	250 Kb					
Supply		External 24 VDC supply (with separate protection conforming to IEC 61131-2)					
Communication	On Ethernet network with safe Ethernet protocol	Integrated (2xRJ45)	Integrated (2xRJ45)	Integrated (2xRJ45)	Integrated (2xRJ45)	Integrated (2xRJ45)	Integrated (2xRJ45)
	On Modbus TCP/IP	–	Integrated (2xRJ45)	–	Integrated (2xRJ45)	–	Integrated (2xRJ45)
	On Modbus (Serial link)	–	–	Integrated (1xRJ45)	Integrated (1xRJ45)	–	–
	On Profibus DP	–	–	–	–	Integrated (SUB-D9)	Integrated (SUB-D9)
Input/output connections		Removable screw terminal blocks or removable cage clamp terminal blocks coded with locating device					
References		XPSMF4000	XPSMF4002	XPSMF4020	XPSMF4022	XPSMF4040	XPSMF4042

(1) They outputs are not safety outputs.

Compact



Safety PLC type		Compact				
Number of inputs	Digital	20	20	24	24	24
	Analogue	–	–	8	8	8
	Counting	–	–	2	2	2
Number of outputs	Digital	8	8	8	8	8
	Analogue	–	–	–	–	–
	Relay	–	–	–	–	–
Memory capacity	Application	250 Kb				
	Data	250 Kb				
Supply		External 24 VDC supply (with separate protection conforming to IEC 61131-2)				
Communication	On Ethernet network (Modbus TCP/IP)	Integrated (4xRJ45)	Integrated (4xRJ45)	Integrated (4xRJ45)	Integrated (4xRJ45)	Integrated (4xRJ45)
	On Modbus (Serial link)	Integrated (SUB-D9)	–	–	Integrated (SUB-D9)	–
	On Profibus DP	–	–	–	–	Integrated (SUB-D9)
Input/output connections		Removable screw terminal blocks, coded with locating device				
References (2)		XPSMF3022	XPSMF31222	XPSMF3502	XPSMF3522	XPSMF3542

(2) Products referenced XPSMF30/MF31/MF35 are marked Himatrix F30, F31 and F35.

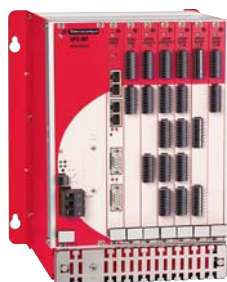

For all XPSMF PLCs

- Maximum category of the solution **Category 4**
(EN 954-1)
- Max performance level for the solution **PL e**
(EN ISO 13849-1)
- Max safety integrity level for the solution **SIL 3**
(EN IEC 62061)

Type		CPU	Power supply module	Rack with 6 slots	Software
Memory capacity	Application	500 Kb	–	–	For XPSMF PLCs
	Data	500 Kb	–	–	
Supply		–	External 24 VDC, integrated	–	
Communication	On Ethernet network (Modbus TCP/IP)	Integrated (4xRJ45)	–	–	Complete version
	On Modbus bus (Serial link)	Integrated (SUB-D9)	–	–	SSV1XPSMFWIN
Power connections		Screw terminal blocks	Screw terminal blocks	–	(1)
Dimensions W x D x H		–	–	257 x 239 x 310 mm	Update version
References		XPSMFCPU22	XPSMFP01	XPSMFGEH01	SSVXPSMFWINUP



I/O module type	For modular safety PLC							
	Analogue		Digital			Relay		
Number of inputs	Digital	–	–	–	24	32	24	–
	Analogue	8	–	–	–	–	–	–
	Counting	–	–	2	–	–	–	–
Number of outputs	Digital	–	–	4	–	–	16	–
	Analogue	–	8	–	–	–	–	–
	Relay	–	–	–	–	–	–	8
Supply	Removable screw terminal blocks, coded with locating device							
References	XPSMFAI801	XPSMFAO801	XPSMFCIO2401	XPSMFDI2401	XPSMFDI3201	XPSMFDIO241601	XPSMFD0801	

Decentralised safety I/O modules



Module type	Inputs/Ouputs Digital				
Number of inputs	Digital	16	8+2	16	20
Number of outputs	Digital	–	8	8	8
	Pulsed	4	2	2	–
Supply	External 24 VDC supply (with separate protection conforming to IEC 61131-2)				
Communication	On Safe Ethernet network (Modbus TCP/IP)	Integrated (2xRJ45)			
Input/output connections	Removable screw terminal blocks, coded with locating device				
References (2)	XPSMF1DI1601	XPSMF3DIO8801	XPSMF3DIO16801	XPSMF3DIO20802	



I/O module type	Inputs/Outputs		Outputs		Relay	
	Analogue	Digital	Digital	Relay		
Number of inputs	Analogue	8	–	–	–	–
Number of outputs	Digital	–	4	16	–	–
	Analogue (not safety)	4	–	–	–	–
	Relay	–	–	–	8	16
Supply	External 24 VDC supply (with separate protection conforming to IEC 61131-2)					
Communication	On Safe Ethernet network (Modbus TCP/IP)	Integrated (2xRJ45)				
Input/output connections	Removable screw terminal blocks, coded with locating device					
References (2)	XPSMF3AIO8401	XPSMF2DO401	XPSMF2DO1601	XPSMF2DO801	XPSMF2DO1602	

(1) To be ordered only if the previous version of have been already installed.

(2) Products referenced **XPSMF1/MF2/MF3** are marked **Himatrix F1, F2 and F3**.

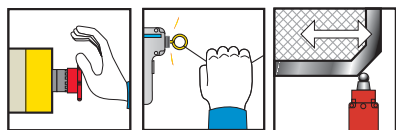

Maximum safety level of the solution attained (EN ISO 13849-1, EN/IEC 62061)		PL e / Cat. 4, SILCL 3		
Number of circuits	Safety	2 x 2N/O + 6 solid-state		2 x 3N/O per function
	Additional	-		3 solid-state
Display (number of LEDs)		30		12
Width of housing		74 mm		45 mm
Communication interface		Modbus	Modbus, CANopen	Modbus, Profibus DP

Universal solutions: safety controllers (for monitoring several safety functions simultaneously)

Supply voltage	24 VDC	XPSMC32Z (1) (2)	XPSMC32ZC (1) (2)	XPSMC32ZP (1) (2)	XPSMP11123P (3)
-----------------------	--------	-------------------------	--------------------------	--------------------------	------------------------

**Coded magnetic switches
Enabling switch**



Maximum safety level of the solution attained (EN ISO 13849-1, EN/IEC 62061)		PL e / Cat. 4, SILCL 3		
For monitoring		magnetic switches and enabling switch		
Number of circuits	Safety	2 x 2N/O + 6 solid-state		2 x 3N/O per function
	Additional	-		3 solid-state
Display (number of LEDs)		30		12
Width of housing		74 mm		45 mm
Communication interface		Modbus	Modbus, CANopen	Modbus, Profibus DP

Universal solutions: safety controllers (for monitoring several safety functions simultaneously)

Supply voltage	24 VDC	XPSMC32Z (1)(2)	XPSMC32ZC (1)(2)	XPSMC32ZP (1)(2)	XPSMP11123P (3)
-----------------------	--------	------------------------	-------------------------	-------------------------	------------------------

Safety mats and edging



Maximum safety level of the solution attained (EN ISO 13849-1, EN/IEC 62061)		PL d / Cat. 3, SILCL 2		
Number of circuits	Safety	2 x 2N/O + 6 solid-state		2 x 3N/O per function
	Additional	-		3 solid-state
Display (number of LEDs)		30		12
Width of housing		74 mm		45 mm
Communication interface		Modbus	Modbus, CANopen	Modbus, Profibus DP

Universal solutions: safety controllers (for monitoring several safety functions simultaneously)

Supply voltage	24 VDC	XPSMC32Z (1)(2)	XPSMC32ZC (1)(2)	XPSMC32ZP (1)(2)	XPSMP11123P (3)
-----------------------	--------	------------------------	-------------------------	-------------------------	------------------------

(1) Version with 32 inputs. For version with 16 inputs, replace 32 in the reference by 16 (example: XPSMC32Z becomes XPSMC16Z).
 (2) Configuration software XPSMCWIN (complete version), configuration cable, adaptor and set of screw or cage clamp terminal plug-in connectors XPSMCTS16 and XPSMCTS32 or set of spring clip terminal plug-in connectors XPSMCTC16 and XPSMCTC32 to be ordered separately.
 (3) For fixed connector version, delete the letter P from the end of the reference (example: XPSMP11123P becomes XPSMP11123).

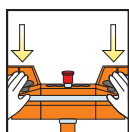

Universal



Maximum safety level of the solution attained (EN ISO 13849-1, EN/IEC 62061)		PL e / Cat. 4, SILCL 3		
Number of circuits	Safety	2 x 2N/O + 6 solid-state		
	Additional	-		
Display (number of LEDs)		30		
Width of housing		74 mm		
Communication interface		Modbus	Modbus, CANopen	Modbus, Profibus DP

Universal solutions: safety controllers (for monitoring several safety functions simultaneously)

Supply voltage	24 VDC	XPSMC32Z (1)(2)	XPSMC32ZC (1)(2)	XPSMC32ZP (1)(2)
-----------------------	--------	------------------------	-------------------------	-------------------------

Light curtains

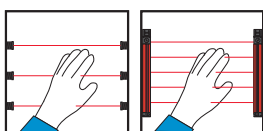

Universal



Maximum safety level of the solution attained (EN ISO 13849-1, EN/IEC 62061)		PL e / Cat. 4, SILCL 3			2 light curtains monitoring max.
Number of circuits	Safety	2 x 2N/O + 6 solid-state	2x3N/O per function	6 PNP solid-state	
	Additional	-	3 solid-state	1 PNP + 1 NPN	
Display (number of LEDs)		30	12	14 + double display units	
Width of housing		74 mm	45 mm	100 mm	
Integral Muting function		Yes	No	Yes	
Communication interface		Modbus	Modbus, CANopen	Modbus, Profibus DP	-

Universal solutions: safety controllers (for monitoring several safety functions simultaneously)

Supply voltage	24 VDC	XPSMC32Z (1)(2)	XPSMC32ZC (1)(2)	XPSMC32ZP (1)(2)	XPSMP11123P (3)	XPSLCM1150 (4)
-----------------------	--------	------------------------	-------------------------	-------------------------	------------------------	-----------------------

- (1) Version with 32 inputs, for version with 16 inputs, replace 32 in the reference by 16 (example: XPSMC32Z becomes XPSMC16Z).
- (3) For version with non removable terminal block, delete the letter P from the end of the reference (example: XPSMP11123P becomes XPSMP11123).
- (4) Removable terminal blocks

Zero speed, time delay

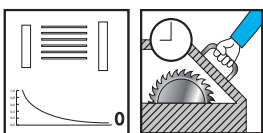

Universal



Maximum safety level of the solution attained (EN ISO 13849-1, EN/IEC 62061)		PL e / Cat. 4, SILCL 3		
For monitoring		Motor zero speed condition		
Number of circuits	Safety	2 x 2N/O + 6 solid-state		
	Additional	-		
Display (number of LEDs)		30		
Width of housing		74 mm		
Communication interface		Modbus	Modbus, CANopen	Modbus, Profibus DP

Universal solutions: safety controllers (for monitoring several safety functions simultaneously)

Supply voltage	24 VDC	XPSMC32Z (5) (2)	XPSMC32ZC (5) (2)	XPSMC32ZP (5) (2)
-----------------------	--------	-------------------------	--------------------------	--------------------------

- (2) Configuration software XPSMCWIN (complete version), configuration cable, adaptor and set of screw or cage clamp terminal plug-in connectors XPSMCTS16 and XPSMCTS32 or set of spring clip terminal plug-in connectors XPSMCTC16 and XPSMCTC32 to be ordered separately.
- (5) Plug-in connector version only.

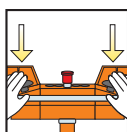

Maximum safety level of the solution attained (EN ISO 13849-1, EN/IEC 62061)		PL c / Cat. 1 (type IIIA to EN 574/ISO 13851)	PL e / Cat. 4, SILCL 3 (type IIIC to EN 574/ISO 13851)	
Number of circuits	Safety	1N/O	2N/O	2N/O
	Additional	1N/C	1N/C	2 solid-state
Display (number of LEDs)		2	3	3
Width of housing		22.5 mm	22.5 mm	22.5 mm

Optimum solutions: safety modules (for monitoring 1 safety function)

Supply voltage	24 VDC	–	–	XPSBF1132P (1)
	24 VAC/DC	XPSBA5120 (2)	XPSBCE3110P (2)	–

(1) For version with non removable terminal block, delete the letter P from the end of the reference (example: XPSBF1132P becomes XPSBF1132).

(2) For version with cage clamps removable terminal block, change the letter P for C from the end of the reference (example: XPSBCE3110P becomes XPSBCE3110C)

Light curtains

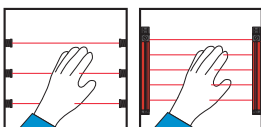

Maximum safety level of the solution attained (EN ISO 13849-1, EN/IEC 62061)		PL c / Cat. 2, SILCL 1	PL e / Cat. 4, SILCL 3		
Number of circuits	Safety	2N/O	3N/O	3N/O	7N/O
	Additional	4 solid-state	–	1N/C + 4 solid-state	1N/C + 4 solid-state
Display (number of LEDs)		4	3	4	4
Width of housing		45 mm	22.5 mm	45 mm	90 mm
Integral Muting function		Yes	No	No	No

Optimum solutions: safety modules (for monitoring 1 safety function)

Supply voltage	24 VDC	XPSCM1144P (1)	–	–	–
	24 VAC/DC	–	XPSAFL5130P (1)	XPSAK311144P (1)	XPSAR311144P (1)

(1) For version with non removable terminal block, delete the letter P from the end of the reference (example: XPSCM1144P becomes XPSCM1144).

Zero speed, time delay and lifts

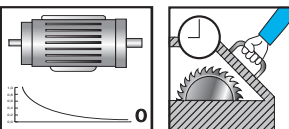

Maximum safety level of the solution attained (EN ISO 13849-1, EN/IEC 62061)		PL d / Cat. 3, SILCL 2		
For monitoring		Motor zero speed condition	Safety time delay	
Number of circuits	Safety	1N/O + 1N/C	1N/O time delay	1N/O pulse
	Additional	2 solid-state	2N/C + 2 solid-state	2N/C + 2 solid-state
Display (number of LEDs)		4	4	4
Width of housing		45 mm	45 mm	45 mm

Optimum solutions: safety modules (for monitoring 1 safety function)

Supply voltage	24 VDC	XPSVNE1142P (1)	–	–
	24 VAC/DC	–	XPSTSA5142P (2)	XPSTSW5142P (2)

(1) Motor frequency ≤ 60 Hz.. For frequencies ≥ 60 Hz, please see: www.schneider-electric.com

(2) Removable terminal block version only.

Preventa Safety modules



Maximum safety level of the solution attained (EN ISO 13849-1, EN/IEC 62061, EN/IEC 61058)		PL e/Cat. 4, SILCL 3		PL e/Cat. 4 (1) and PL d/Cat. 3 (2), SILCL 3 (1) and SILCL 2 (2)	PL e/Cat. 4, SILCL 3
Number of circuits	Safety	3 NO	3 NO	2 NO instantaneous + 3 NO time delay	3 NO instantaneous + 3 NO time delay
	Additional	1 solid-state output for signalling to PLC	1 relay output for signalling to PLC	4 solid-state outputs for signalling to PLC	1 NC
Display (number of LEDs)		2 LEDs	2 LEDs	4 LEDs	5 LEDs
Width of housing		22,5mm	22,5mm	45 mm	45 mm
Supply voltage	24 VDC	XPSAC5121	XPSAXE5120P or XPSAXE5120C	XPSATE5110P	XPSATR1153P or XPSATR1153C
Section Title		For Emergency stop and switch monitoring			For Emergency stop and protective guard applications



Maximum safety level of the solution attained (EN ISO 13849-1, EN/IEC 62061, EN/IEC 61058)		PL e/Cat. 4, SILCL 3	PL e/Cat. 4 (1) and PLC d/Cat. 3 (2), SILCLC 3 (1) and SILCLC 2 (2)	PL e/Cat. 4, SILCL 3
Number of circuits	Safety	3 NO instantaneous + 3 NO time delay	2 NO instantaneous + 1 NO time delay	3 NO
	Additional	3 solid-state outputs for signalling to PLC		
Display (number of LEDs)		11 LEDs	3 LEDs	3 LEDs
Width of housing		45 mm	22,5 mm	22,5 mm
Supply voltage	24 VDC	XPSAV11113P	XPSABV11330P or XPSABV11330C	XPSAF5130P
Section Title		For Emergency stop and switch monitoring		



Maximum safety level of the solution attained (EN ISO 13849-1, EN/IEC 62061, EN/IEC 61058)		PL e/Cat. 4, SILCL 3			
Number of circuits	Safety	3 NO	7 NO	3 NO instantaneous	2 NO
	Additional		2 NC + 4 solid-state outputs for signalling to PLC	1 NC + 4 solid-state outputs for signalling to PLC	2 solid-state outputs for signalling to PLC
Display (number of LEDs)		3 LEDs	4 LEDs	4 LEDs	3 LEDs
Width of housing		22,5 mm	90 mm	45 mm	22,5mm
Supply voltage	24 VDC	XPSAFL5130P	XPSAR311144P	XPSAK311144P	XPSVC1132P
Section Title		For Emergency stop, switch or solid-state output safety light curtain monitoring		For Emergency stop, switch, sensing mat/edges or solid-state output safety light curtain monitoring	For enabling switch monitoring

(1) Instantaneous safety outputs.
(2) Time-delay safety outputs.

Preventa Safety modules



Maximum safety level of the solution attained (EN ISO 13849-1, EN/IEC 62061, EN/IEC 61058)		PL c/Cat. 1, SILCL 1		PL e/Cat. 4, SILCL 3		PL c/Cat. 2, SILCL 1	
Number of circuits	Safety	1 NO	2 NO	2 NO	2 NO	2 NO	2 NO
	Additional	1 NC	1 NC	1 NC	2 solid-state outputs for signalling to PLC	4 solid-state PNP NO outputs for signalling to PLC	
Display (number of LEDs)		2 LEDs	3 LEDs	3 LEDs	3 LEDs	4 LEDs	
Width of housing		22,5mm	22,5mm	22,5mm	22,5mm	45 mm	
Supply voltage		24 VDC	XPSBAE5120P or XPSBAE5120C	XPSBCE3110P or XPSBCE3110C	XPSBF1132P	XPSCM1144P	
Section Title		For electrical monitoring of two-hand control stations				To monitor 1 to 4 XUS S single beam photo-electric sensors transmitter-receiver pairs	



Maximum safety level of the solution attained (EN ISO 13849-1, EN/IEC 62061, EN/IEC 61058)		PL e/Cat. 4, SILCL 3 (1)		PL d/Cat. 3, SILCL 2		
Number of circuits	Safety	4 NO	8 NO	1 NO time delayed	1 NO pulse type	
	Additional	2 NC	1 NC	2 NC + 2 solid-state outputs for signalling to PLC	2 NC + 2 solid-state outputs for signalling to PLC	
Display (number of LEDs)		2 LEDs	3 LEDs	4 LEDs	4 LEDs	
Width of housing		22,5 mm	45 mm	45 mm	45 mm	
Supply voltage		24 VDC	XPSECME5131P or XPSECME5131C	XPSECPE5131P or XPSECPE5131C	XPSTSA5142P	XPSTSW5142P
Section Title		For extending the number of safety contacts		For the monitoring of applications requiring safety time delays		



Maximum safety level of the solution attained (EN ISO 13849-1, EN/IEC 62061, EN/IEC 61058)		PL e/Cat. 4, SILCL 3		PL d/Cat. 3, SILCL 2	
Number of circuits	Safety	2 NO	2 NO	1 NO + 1 NC	
	Additional	2 solid-state outputs for signalling to PLC	2 solid-state outputs for signalling to PLC	2 solid-state outputs for signalling to PLC	
Display (number of LEDs)		3 LEDs	15 LEDs	4 LEDs	
Width of housing		22,5 mm	45 mm	45 mm	
Supply voltage		24 VDC	XPSDME1132P	XPSDME1132P	XPSVNE1142P (>60 Hz) or XPSVNE1142HSP (<60 Hz)
Section Title		For coded magnetic switch monitoring		For zero speed detection of AC or DC motors which produce a remanent voltage in their windings due to residual magnetism	

(1) When connected to the appropriate module.

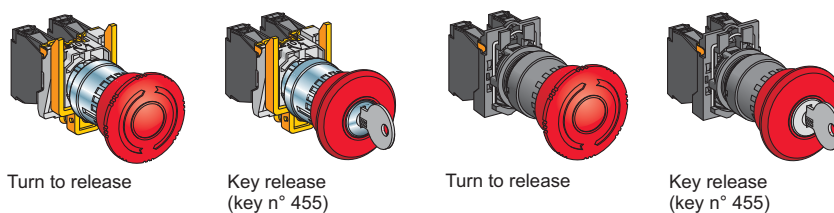
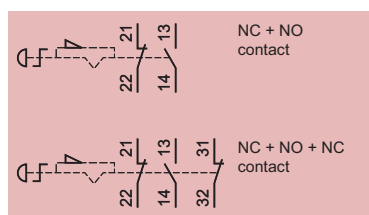

Pushbuttons		Metal		Plastic	
Mechanical life (millions of operating cycles)		0.3		0.3	
Shock / vibration resistance		10 gn / 5 gn		10 gn / 5 gn	
Degree of protection		IP 66		IP 66	
Rated operational characteristics		AC 15, A 600 / DC 13, Q 600 (conforming to EN IEC 60947-5-1)			
Dimensions Ø x Depth		Ø 40 x 82 mm	Ø 40 x 104 mm	Ø 40 x 81.5 mm	Ø 40 x 103 mm
Contact	NC + NO	XB4BS8445	XB4BS9445	XB5AS8445	XB5AS9445
	2 NC + 1 NO	XB4BS84441	ZB4BS944+ZB4BZ141	ZB5AS844 + ZB5AZ141	ZB5AS944+ZB5AZ141

Ø 22 trigger action latching pushbutton stations

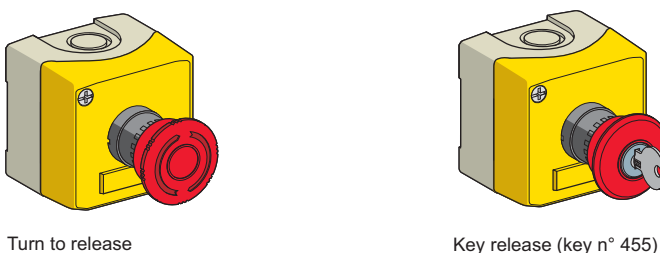
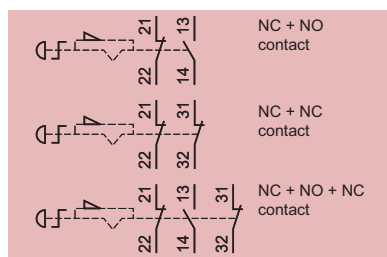

Enclosure		Plastic	
		2 x ISO M20 cable entries or n° 13 (Pg 13.5) cable gland	
Mechanical life (millions of operating cycles)		0.1	
Shock / vibration resistance		10 gn / 5 gn	
Degree of protection		IP 66	
Rated operational characteristics		AC 15, A 600 / DC 13, Q 600 (conforming to EN IEC 60947-5-1)	
Dimensions W x D x H		68 x 91 x 68 mm	68 x 113 x 68 mm
Contact	NC + NO	XALK178E	XALK188E
	NC + NC	XALK178F	XALK188F
	2 NC + 1 NO	–	XALK188G

Accessories

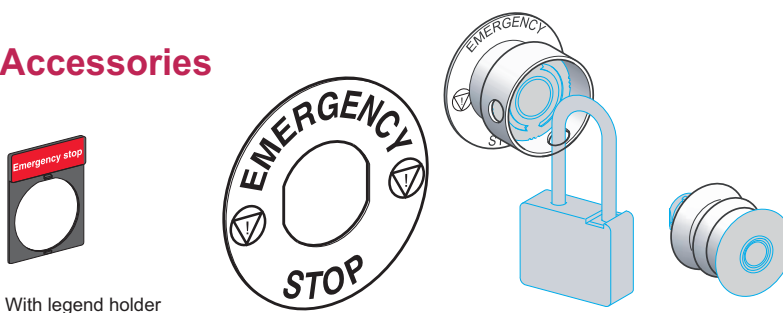

Type		Étiquettes		Padlocking kit	Bellows seals	
Colour		Red with white lettering	Yellow with black lettering	Yellow	Red Silicone	Black EPDM
Dimensions		30 x 40 mm (1)	Ø 60 mm			
Références	Marking:	"Arrêt d'urgence"	ZBY2130	ZBY9130	–	–
		"Emergency stop"	ZBY2330	ZBY9330	–	–
		"Not Halt"	ZBY2230	ZBY9230	–	–
		–	–	ZBZ3605	ZBZ48	ZBZ28

(1) circular appearance

ISO entry
(to EN 50262)

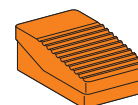
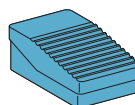
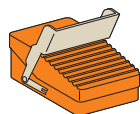

Type		Foot switches without protective cover			
		2 cable entries for n° 16 (Pg 16) cable gland (1)			
Trigger mechanism		With (positive operating action reqd.)		Without	
Colour		Orange		Blue Orange	
Mechanical life (millions of operating cycles)		15			
Degree of protection		IP 66			
Shock resistance		100 joules			
Rated operational characteristics		AC 15, A 300 / DC 13, Q 300 (conforming to EN IEC 60947-5-1)			
Dimensions W x D x H		104 x 172 x 59 mm			
Contact operation	1 step	1 NC + NO	XPER810	XPEM110	XPER110
		2 NC + NO	XPER811	XPEM111	XPER111
Contact operation	2 step	2 NC + NO	XPER911	XPEM211	XPER211
		Analogue output	2 NC + NO	XPER929	–

(1) For entry for ISO M20 cable gland, also order adaptor DE9RA1620 (sold in lots of 5).

ISO entry
(to EN 50262)

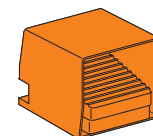
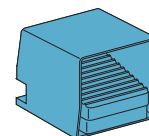
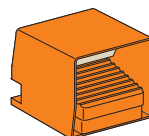
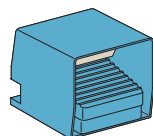

Type		Foot switches without protective cover			
		2 cable entries for n° 16 (Pg 16) cable gland (1)			
Trigger mechanism		With (positive operating action reqd.)		Without	
Colour		Blue Orange		Blue Orange	
Mechanical life (millions of operating cycles)		15			
Degree of protection		IP 66			
Shock resistance		100 joules			
Rated operational characteristics		AC 15, A 300 / DC 13, Q 300 (conforming to EN IEC 60947-5-1)			
Dimensions W x D x H		160 x 186 x 152 mm			
Contact operation	1 step	1 NC + NO	XPEM510	XPER510	XPEM310
		2 NC + NO	XPEM511	XPER511	XPEM311
Contact operation	1 step latching	1 NC + NO	–	–	XPEM410
		2 NC + NO	XPEM711	XPER711	XPEM611
Contact operation	Analogue output	2 NC + NO	XPEM529	XPER529	XPEM329
					–

(1) For entry for ISO M20 cable gland, also order adaptor DE9RA1620 (sold in lots of 5).

Double pedal switches

ISO entry
(to EN 50262)

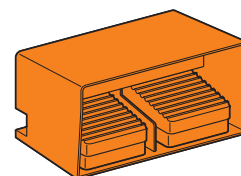
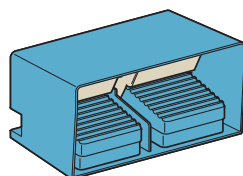

Type		Foot switches without protective cover			
		2 cable entries for n° 16 (Pg 16) cable gland (1)			
Trigger mechanism		With (positive operating action reqd.)		Without	
Colour		Blue Orange		Blue Orange	
Mechanical life (millions of operating cycles)		15			
Degree of protection		IP 66			
Shock resistance		100 joules			
Rated operational characteristics		AC 15, A 300 / DC 13, Q 300 (conforming to EN IEC 60947-5-1)			
Dimensions W x D x H		295 x 190 x 155 mm			
Contact operation	1 step	2 x 1 NC + NO	XPEM5100D	XPER510D	XPEM3100D
		2 x 2 NC + NO	XPEM5110D	XPER5110D	XPEM3110D
					XPER3100D
					XPER3110D

(1) For entry for ISO M20 cable gland, also order adaptor DE9RA1620 (sold in lots of 5).

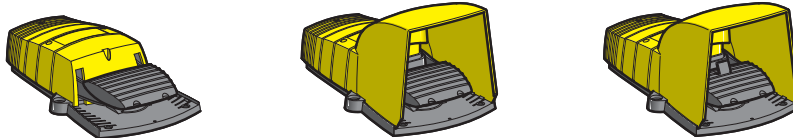

Type			Without protective cover		With protective cover	
			2 cable entries for ISO M20 cable gland			
Trigger mechanism			Without		With (positive operating action reqd.)	
Colour			Yellow		Yellow	
Mechanical life (millions of operating cycles)			5			
Degree of protection			IP 55			
Shock resistance			30 joules			
Rated operational characteristics			AC 15, A 300 / DC 13, Q 300 (conforming to EN IEC 60947-5-1)			
Dimensions W x D x H			160 x 280 x 70 mm		160 x 280 x 162 mm	
Contact operation	1 step	1 NC + NO	XPEY110	XPEY310	XPEY510	
		2 NC + NO	–	XPEY311	XPEY511	
	2 step	2 NC + NO	XPEY211	XPEY611	XPEY711	

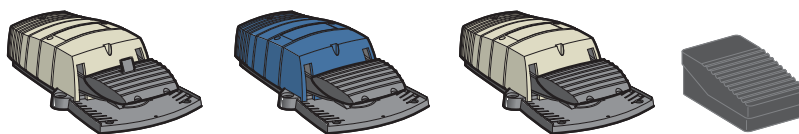

Type			Foot switches without protective cover			1 entry (1)
			2 cable entries for ISO M20 cable gland			
Trigger mechanism			With (positive operating action reqd.)		Without	
Colour			Grey+		Blue Grey	
Mechanical life (millions of operating cycles)			10		2	
Degree of protection			IP 66		IP 43	
Shock resistance			100 joules			
Rated operational characteristics			AC 15, A 300 / DC 13, Q 300 (conforming to EN IEC 60947-5-1)			
Dimensions W x D x H			160 x 280 x 70 mm			94 x 161 x 54 mm
Contact operation	1 step	1 NC + NO	XPEG810	XPEB110	XPEG110	XPEA110
		2 NC + NO	–	XPEB111	XPEG111	XPEA111
	2 step	2 NC + NO	XPEG911	XPEB211	XPEG211	–

(1) Cable entry for ISO M16 or n° 9 (Pg 9) cable gland and for ISO M20 or n° 13 (Pg 13.5) cable gland.

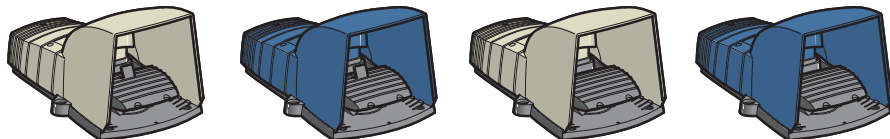

Type			Foot switches with protective cover			
			2 cable entries for ISO M20 cable gland			
Trigger mechanism			With (positive operating action reqd.)		Without	
Colour			Grey		Blue Grey Blue	
Mechanical life (millions of operating cycles)			10			
Degree of protection			IP 66			
Shock resistance			100 joules			
Rated operational characteristics			AC 15, A 300 / DC 13, Q 300 (conforming to EN IEC 60947-5-1)			
Dimensions W x D x H			180 x 280 x 162 mm			
Contact operation	1 step	1 NC + NO	XPEG510	XPEB510	XPEG310	XPEB310
		2 NC + NO	XPEG511	XPEB511	XPEG311	XPEB311
	2 step	2 NC + NO	XPEG711	XPEB711	XPEG611	XPEB611

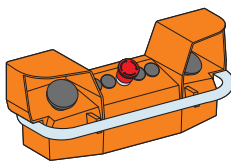

2 control pushbuttons and 1 mushroom head
Emergency stop or Lock out pushbutton

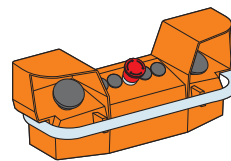

2 control pushbuttons and 1 mushroom head Emergency
stop or Lock out pushbutton, with pre-wired terminal block

Type	Two-hand control stations	
	2 cable entries for ISO M20 or n° 13 (Pg 13.5) cable gland, 1 cable entry for n° 21 (Pg 21) cable gland (2)	
Mechanical life (millions of operating cycles)	1	1
Degree of protection	IP 65	IP 65
Rated operational characteristics	AC 15, A 600 / DC 13, Q 600 (conforming to EN IEC 60947-5-1)	
Dimensions W x D x H	455 x 170 x 188.5 mm	
Red emergency stop (NC + NC slow break)	XY2SB71 (1)	XY2SB72 (1)
Yellow lock out (NC + NO break before make)	XY2SB75	XY2SB76

(1) To order a two-hand control station with pedestal XY2SB90, add 4 to the end of the reference (example: XY2SB71 becomes XY2SB714).

(2) For entry for ISO M25 cable gland, also order adaptor DE9RA2125 + fixing nut DE9EC21 (sold in lots of 5).

Enabling switch

Contact states

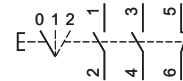
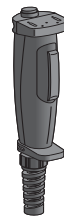
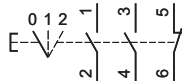
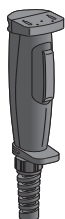
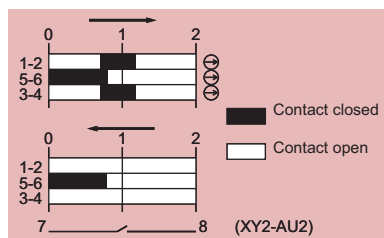

Type	Plastic grip	
	Entry for Ø 7 to 13 mm cable	
Number of contacts	3	3
Type of contacts	2 NO + 1 NC	2 NO + 1 NC 1 NO auxiliary
Description	3 positions	3 positions with button for NO contact (auxiliary)
Shock / vibration resistance	10 gn / 6 gn	
Degree of protection	IP 66	IP 65
Rated operational characteristics	AC 15, C300 / DC 13, R300 (conforming to EN IEC 60947-5-1)	
Dimensions W x D x H	46 x 58 x 261 mm	46 x 58 x 269 mm
References	XY2AU1	XY2AU2

For fixing accessories, please refer to www.schneider-electric.com.

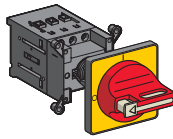
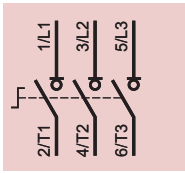

Door mounting

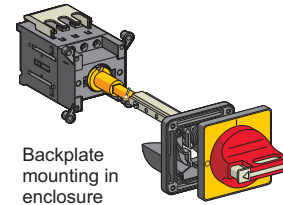

Backplate mounting in enclosure

Type	Mini-Vario for standard applications	
Front plate dimensions (mm)	60 x 60	60 x 60
Fixing	Ø 22.5 mm	Ø 22.5 mm
Degree of protection	IP 20	IP 20
Rated operational voltage (Ue)	690 V	690 V
Thermal current in open air (Ith)	12 A 20 A	VCDN12 VCDN20
		VCCDN12 VCCDN20

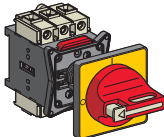
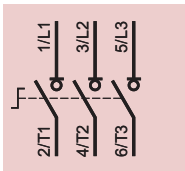

Door mounting

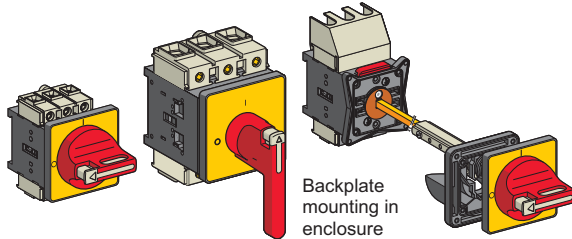

Backplate mounting in enclosure

Type	Vario for high performance applications					
Front plate dimensions (mm)	60 x 60	60 x 60	90 x 90	60 x 60	60 x 60	90 x 90
Fixing	Ø 22.5 mm	4 screws	4 screws	Ø 22.5 mm	4 screws	4 screws
Degree of protection	IP 20	IP 20	IP 20	IP 20	IP 20	IP 20
Rated operational voltage (Ue)	690 V	690 V	690 V	690 V	690 V	690 V
Thermal current in open air (Ith)	12 A	VCD02	VCF02	–	VCCD02	VCCF02
	20 A	VCD01	VCF01	–	VCCD01	VCCF01
	25 A	VCD0	VCF0	–	VCCD0	VCCF0
	32 A	VCD1	VCF1	–	VCCD1	VCCF1
	40 A	VCD2	VCF2	–	VCCD2	VCCF2
	63 A	–	VCF3	–	–	VCCF3
	80 A	–	VCF4	–	–	VCCF4
	125 A	–	–	VCF5	–	–
	175 A	–	–	VCF6	–	–
						VCCF5 VCCF6

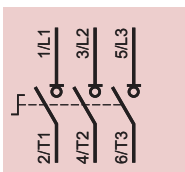

Enclosed

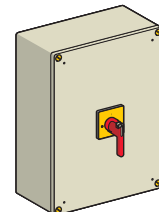
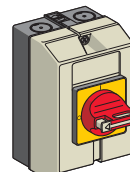
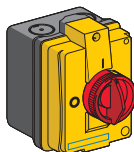

Type	Mini-Vario	Vario	
Front plate dimensions (mm)	60 x 60	60 x 60	90 x 90
Dimensions W x D x H	82.5 x 106 x 131 mm	90 x 131 x 146 mm	241 x 191 x 291 mm
Degree of protection	IP 55	IP 65	IP 65
Rated operational voltage (Ue)	690 V	690 V	690 V
Thermal current in enclosure (Ithe)	10 A	VCFN12GE	VCF02GE
	16 A	VCFN20GE	VCF01GE
	20 A	VCFN25GE	VCF0GE
	25 A	VCFN32GE	VCF1GE
	32 A	VCFN40GE	VCF2GE
	50 A	–	VCF3GE (1)
	63 A	–	VCF4GE (1)
	100 A	–	VCF5GEN
	140 A	–	VCF6GEN

(1) Dimensions W x D x H: 150 x 152 x 170 mm.

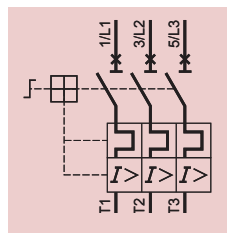

Complete circuit-breaker: circuit-breaker + enclosure + safety device.
Ex.: GV2ME01 + GV2MC02 + GV2K04.

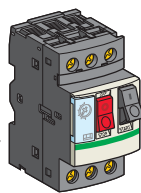

Type	Thermal-magnetic motor circuit-breakers					
Motor power	kW (on 400 V)	–	0.06	0.09	0.12...0.18	0.25...0.37
Setting range	A	0.1...0.16	0.16...0.25	0.25...0.40	0.40...0.63	0.63...1
Current I _d ± 20%	A	1.5	2.4	5	8	13
Current I _{the} (in enclosure)	A	0.16	0.25	0.40	0.63	1
Reference		GV2ME01	GV2ME02	GV2ME03	GV2ME04	GV2ME05
Motor power	kW (on 400 V)	0.37...0.55	0.75	1.1...1.5	2.2	3...4
Setting range	A	1...1.6	1.6...2.5	2.5...4	4...6.3	6...10
Current I _d ± 20%	A	22.5	33.5	51	78	138
Current I _{the} (in enclosure)	A	1.6	2.5	4	6.3	9
Reference		GV2ME06	GV2ME07	GV2ME08	GV2ME10	GV2ME14
Motor power	kW (on 400 V)	5.5	7.5	9...11	11	15
Setting range	A	9...14	13...18	17...23	20...25	24...32
Current I _d ± 20%	A	170	223	327	327	416
Current I _{the} (in enclosure)	A	13	17	21	23	24
Reference		GV2ME16	GV2ME20	GV2ME21	GV2ME22	GV2ME32

Enclosure

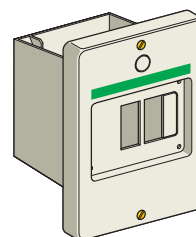
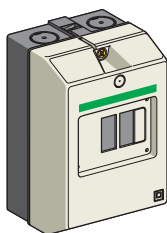

Type	Empty enclosure	
Mounting	Surface mounting	Flush mounting
Degree of protection	IP 55	IP 55 (front face)
Dimensions W x D x H (1)	93 x 145.5 x 147 mm	93 x 55 x 126 mm
References	GV2MC02	GV2MP02

(1) Dimensions with safety device GV2K04 fitted.

Safety device

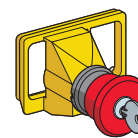
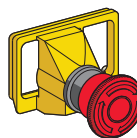
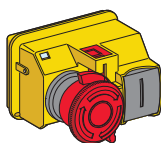

Type	Safety devices		
With red mushroom head	Turn to release Padlockable in "Off" position	Turn to release	Key release (key n° 455)
References	GV2K04	GV2K031	GV2K021

Enclosed motor starters Enclosed DOL

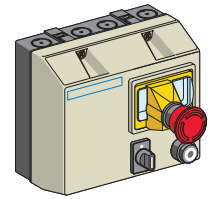
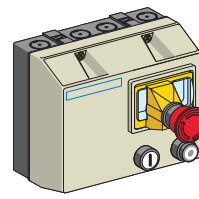
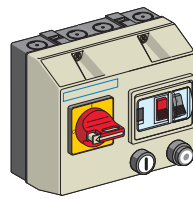

Type				Non reversing		Reversing
Degree of protection				IP 657		IP 657
Standard motor power ratings (kW), category AC3				Basic reference, to be completed by code indicating voltage (1)		
220/230 V	400/415 V	440 V	lth setting range (A)			
–	0.06	0.06	0.16...0.25	LG1K065●●02	LG7K06●●02	LG8K06●●02
0.06	0.09	0.12	0.25...0.40	LG1K065●●03	LG7K06●●03	LG8K06●●03
–	0.18	0.18	0.40...0.63	LG1K065●●04	LG7K06●●04	LG8K06●●04
0.12	0.25	0.25	0.63...1	LG1K065●●05	LG7K06●●05	LG8K06●●05
0.25	0.55	0.55	1...1.6	LG1K065●●06	LG7K06●●06	LG8K06●●06
0.37	0.75	1.1	1.6...2.5	LG1K065●●07	LG7K06●●07	LG8K06●●07
0.75	1.5	1.5	2.5...4	LG1K065●●08	LG7K06●●08	LG8K06●●08
1.1	2.2	3	4...6.3	LG1K065●●10	LG7K06●●10	LG8K06●●10
1.5	4	4	6...10	LG1K095●●14	LG7K09●●14	LG8K09●●14
3	5.5	5.5	9...14	LG1D122●●16	LG7D12●●16	LG8K12●●16
4	7.5	9	13...18	LG1D182●●20	LG7D18●●20	–
4	9	9	17...23	LG1D182●●21	LG7D18●●21	–

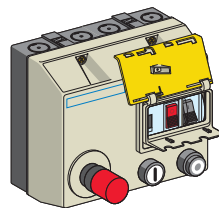

With integral control transformer, 400/24 V

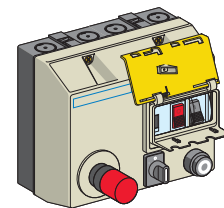

With integral control transformer, 400/24 V

Type		Non reversing	Reversing
Degree of protection		IP 657	
Standard motor power ratings (kW), category AC3		Basic references	
380/400 V	lth setting range (A)	(The code Q7 (380/400 V) designates the power supply voltage to which the starter will be connected)	
0.06	0.16...0.25	LJ7K06Q702	LJ8K06Q702
0.09	0.25...0.40	LJ7K06Q703	LJ8K06Q703
0.18	0.40...0.63	LJ7K06Q704	LJ8K06Q704
0.25	0.63...1	LJ7K06Q705	LJ8K06Q705
0.55	1...1.6	LJ7K06Q706	LJ8K06Q706
0.75	1.6...2.5	LJ7K06Q707	LJ8K06Q707
1.5	2.5...4	LJ7K06Q708	LJ8K06Q708
2.2	4...6.3	LJ7K06Q710	LJ8K06Q710
4	6...10	LJ7K09Q714	LJ8K09Q714

Control circuit voltages available

Volts 50/60 Hz	24 V	230 V	400 V	415 V
(1) Voltage code	B7	P7	V7	N7

The control circuit must be cabled by the user.

Schneider Electric Industries SAS

Head Office
35, rue Joseph Monier - CS 30323
F92500 Rueil-Malmaison Cedex
France

www.schneider-electric.com

The information provided in this documentation contains general descriptions and/or technical characteristics of the performance of the products contained herein. This documentation is not intended as a substitute for and is not to be used for determining suitability or reliability of these products for specific user applications. It is the duty of any such user or integrator to perform the appropriate and complete risk analysis, evaluation and testing of the products with respect to the relevant specific application or use thereof. Neither Schneider Electric nor any of its affiliates or subsidiaries shall be responsible or liable for misuse of the information contained herein.

Design : IGS-CP
Photos : Schneider Electric
Print :