

TABLE OF CONTENTS

Introduction

Basic Connection Principles O-2 to O-5 Terminal Stud Size Chart O-32

Hardware Data

DURIUM™ Steel/Aluminum Tightening Torques O-6 AWG vs. Metric Wire Sizes O-33, O-34

DURIUM™ Hex Bolts Data O-6

UL Tightening Torque UL486 O-7, O-8

Recommended Clamping on Bolted Connectors O-9

BURNDY Conductor Numbering System O-36, O-37

Present Installation Tool Index O-38 to O-48

Color Coding for Overhead Connectors O-49

Cable Data (Tables)

Copper Cable

Copper Tube O-10

Solid Copper Wire O-11

Compact Stranded Copper Cable O-11

Stranded Copper Cable O-12, O-13

Flexible Copper Stranded Cable O-14, O-15

Color Coding for AL/CU Connectors O-49

Color Coding for Copper Lugs and Splices O-50

Aluminum and ACSR Cable

Aluminum Tube O-16

Aluminum 1350 Cable Bare - Classes AA and A O-17

Aluminum 1350 Cable Bare - Class B O-18

ACSR Cable O-19

High Strength ACSR Cable O-20

Compact Aluminum 1350 Cable O-21

Aluminum Alloy 5005 Cable O-22

Aluminum 6201 Cable O-22

Aluminum Alloy 8000 Series "O" Temper Cable O-23, O-24

Compact ACSR Cable O-25

ACSR/TW Cable (Trap Wire) O-25, O-26

AAC/TW Cable (All Aluminum Trap Wire) O-26

ACAR Cable O-27

SSAC Cable O-27, O-28

Product/Trade Name Index O-51

Alpha-Numeric Index O-52 to O-99

Steel Conductors

Copperweld Cable O-29

Copperweld - Copper Cable O-29, O-30

Galvanized Steel Cable O-31

Aluminum Coated Steel Cable O-32

Introduction - Basic Electrical Connection Principles:

Basic Factors:

The basic factors which influence the design and performance of pressure wire connections are as follows:

1. Creep
2. Surface Oxide
3. Corrosion

A fourth factor, known as thermal effects, is also a consideration, but due to the technical nature and length of this topic, it will not be discussed in this publication.

At the outset it should be pointed out that these factors give rise to much more difficult problems in connections involving aluminum conductors than those encountered in copper to copper connections.

Creep (Cold Flow)

Creep is the cold flow of the metal under pressure and it continues until the pressure reduces to a value at which any further creep is negligible. Creep properties depend on the particular metal or alloy and on its hardness; alloys having less creep than pure metals, and harder metals have less creep than soft metals. In a typical connection, the conductors are generally of pure metal and often of soft temper and therefore, subject to considerable creep. In addition, the condition is further exaggerated when aluminum is the conductor as compared to copper, since its creep rate is many times that of copper.

Effect of Creep: Figure 2 shows typical curves of total contact resistance plotted against total contact force. Curve A shows how the contact resistance continually decreases with increasing contact force. When the full contact force F_1 is reached, the contact resistance reaches the low value of R_1 . In general, the full tightening force on a connector greatly exceeds the maximum force for which there is no appreciable creep. Therefore, the force will gradually settle down to a value after which there will be no further significant creep. Fortunately, however, the resistance does not climb back up along curve A, the tightening curve, but instead it follows a new curve B, the relaxing curve, along which the resistance changes very little until the force relaxes to a value such as F_2 .

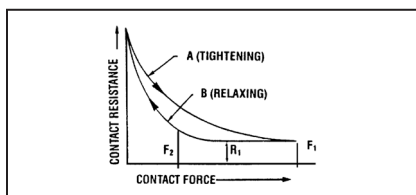

Figure 2

Admittedly, the point of “no appreciable creep” is difficult to define. For pure metals, especially in the soft state, there is always some creep, even at very low pressures at room temperature. However, we do know that the pressure required to produce the same creep rate is several times greater for copper than for aluminum. Thus, to permit the same contact force F_2 for aluminum and copper, the contact area A required for aluminum can be expected to be considerably greater than that required for copper. This explains why the contact areas for connectors for aluminum must be considerably greater than for copper and why many light duty connectors for copper are entirely inadequate for aluminum, even when specially plated and when recommended compounds are used on the contact surfaces.

Relaxation: Relaxation of pressure due to creep, or for any other reason, would be a much more difficult factor in a pressure connection were it not for the relationship of contact pressure to contact resistance on the relaxation curve as shown in Figure 2. It is frequently observed that some time after the bolts of a clamp type connector are tightened, the bolt tensions are relaxed appreciably. The question arises as to whether it is necessary to retighten the bolts to the original torque value. In a properly designed connector, retightening is unnecessary since the contact resistance should increase very little due to the relaxation of pressure, as shown by the relaxation curve of Figure 2.

This fact is largely responsible for the successful operation of a compression connector. The application of the compression tool applies very high pressure, establishing very low contact resistance. The removal of the compression tool releases a very large proportion of this pressure, and creep further relaxes this pressure. Fortunately, the contact resistance increases very little due to this pressure relaxation.

Contact Force: The previous analysis shows that the total contact force largely determines the contact resistance. Thus, to achieve the desired low value of contact resistance, the proper size and number of bolts in a clamp type connector must be supplied, and the compression tool must apply the proper force to a compression connector. In addition, the connector must be designed with sufficient structural strength, contact area, and resilience, to assure that the contact force cannot relax beyond the point where contact resistance begins to rise appreciably, as shown in Figure 2.

Surface Oxide

The contact of pure metallic surfaces cannot be assured in practical connections. Surface contamination must be expected, especially surface oxidation. These surface films are insulators as far as contact resistance is concerned, and they must be broken to achieve metal to metal contact to make an adequate electrical connection. The difficulty of breaking the film depends on the nature of the film, its thickness, and the metal on which it is formed.

Copper oxide is generally broken down by reasonably low values of contact pressure. Unless the copper is badly oxidized, good contact can be obtained with very little or no cleaning.

Silver oxide is even more easily broken down by the contact pressure; and since silver oxide forms less readily at elevated temperatures, silver contact surfaces are preferred over copper when used for high temperatures. For this reason, it is considered good practice to silver plate copper contact surfaces that must operate at temperatures over 200° C.

On the other hand, aluminum oxide is a hard, tenacious, high resistance film that forms very rapidly on the surface of aluminum exposed to air. In fact, it is the toughness of this film that gives aluminum its good corrosion resistance. The oxide film that forms after more than a few hours is too thick and tough to permit a low resistance contact without cleaning. The aluminum oxide film is transparent so that even the bright and clean appearance of an aluminum connector is no assurance that the low contact resistance can be attained without cleaning.

In addition to the necessity for cleaning the oxide from aluminum, the surface should be covered with a good connector compound to prevent the oxide from reforming. Common practice is to clean the surface with a wire brush or emery cloth. The compound should be applied immediately after cleaning, or the compound should be put on first and the surface scraped through the compound. Present practice is to scratch brush dry and to apply the compound immediately thereafter. This allows a more thorough job of cleaning the conductor.

Contact Compounds: Petrolatum or No-Oxid are good contact surface compounds for aluminum, but BURNDY® PENETROX™ A, a petroleum type compound containing zinc dust, has the additional advantage of assisting in the

Introduction - Basic Electrical Connection Principles: (continued)

breaking down of the contact resistance. How this is accomplished is not certain, but it appears that the zinc particles of PENETROX™ probably act as current bridges in the breaks in the oxide film. For more complete information about the PENETROX™ line of compounds, refer to the Accessories section of this catalog.

Interstrand Resistance: The high contact resistance due to the oxide on the strands of an aluminum cable may be responsible for a poor distribution of current among the strands on the cable. Thus, the outer strands may carry much more than their share of the current and overheating of the cable may result. Tests have shown that even on new cable this effect of interstrand resistance can be considerable unless a good contact compound is used. The clamping action tends to break down the oxide and force the compound between the strands. This is particularly true of compression connectors due to the very high unit pressures developed.

The most effective way to break down interstrand resistance of aluminum cable is to use compression connectors filled with a compound having zinc particles. Then, when the end of the cable is inserted in the connector, the compound is forced between the strands where it very effectively breaks down the interstrand resistance upon application of the compressive force.

Plating Aluminum: Plating the contact surfaces of aluminum connectors will prevent the formation of aluminum oxide. Electro-tin, cadmium and zinc platings have been used for this purpose. However, the use of a plated aluminum conductor, does not make it less necessary to scratch brush the aluminum conductor, nor does it reduce the need for a good contact compound. Additional problems are introduced due to the plating on aluminum which render it of very doubtful value over the proper use of base aluminum. This will be more fully discussed later.

Corrosion

The electrical conductivity and mechanical strength of an electrical connection must remain stable under the deteriorating influences of the environment. This deterioration is corrosion. It is the electrolytic action of moisture and other elements of the atmosphere in conjunction with the metals of the connection. If the conductors and connectors are of copper or a corrosion resistant copper alloy, corrosion is usually a minor factor. However, it is a very vital factor if aluminum is involved.

If moisture can be kept away from the connection, corrosion will not be a factor. The electrical connection of a high voltage splice on insulated cable is generally free from corrosion since the taping may be used to avoid corrosion on bare cable, provided it excludes moisture. It is difficult to get a good tape seal to the conductor itself, especially on stranded cable. If moisture does penetrate the taping, it will not dry out as readily as if the joint were untaped. Various plastic materials are available today for covering low voltage connections or for bare conductor connections on high voltage. Unless such coverings are completely moisture-proof, it is better to rely on installation with a good contact compound, using a connector designed to resist corrosion.

Galvanic Action: Whenever dissimilar metals are in the presence of an electrolyte, a difference in electric potential is developed. One metal becomes the cathode and receives a positive charge. The other becomes the anode and receives a negative charge. When these metals are in contact, an electrical current will flow, as in the case of any short-circuited electric cell. This electrolytic action causes an attack of the anodic metal, leaving the cathodic metal unharmed. The extent of the attack is proportional to the strength of the electrolytic current, which in turn is proportional to the electric potential difference developed.

The magnitude of the potential difference generated between two dissimilar metals can be seen by the position of these metals in the electrolytic series. Figure 3 is such a series. When two metals are in contact in an electrolyte, the one higher up in this series is the anode, the corroded metal, while the one lower is the cathode, the protected metal. The further apart the metals are in this series, the greater the electrolytic potential difference, and the greater the attack to the anodic metal.

Note that copper and aluminum are quite far apart in the series, copper being cathodic and aluminum anodic. Hence, when aluminum and copper are in contact in an electrolyte, the aluminum can be expected to be severely attacked.

Crevice Corrosion: Electrolytic attack can also occur between like metals due to a phenomenon known as oxygen concentration cell or crevice corrosion. Since oxygen is necessary for corrosive action, a variation in the concentration of

oxygen where a metal is exposed to an electrolyte will generate a difference of potential, and cause a corrosive attack in the oxygen starved area. Thus, since an electrolyte in a deep crevice is freely exposed to the air at the outside, the concentration of oxygen will be greatest at the mouth of the crevice. Then corrosion can be expected to occur in the crevice remote from the surface. Crevice corrosion can be prevented if the crevice is filled with a compound to exclude moisture. Thus, within the contact groove of an aluminum connector containing an aluminum conductor, there will be numerous crevices in which corrosion will take place unless a good connector compound is applied during installation. Copper, being a more noble metal, appears to be much less subject to crevice corrosion.

Corrosion Testing: The effectiveness of an electrical connection to resist corrosion can be tested in the laboratory under conditions designed to greatly accelerate the natural corrosive conditions of actual service. The most widely accepted means is the standard salt spray chamber. In this chamber the specimens are placed in a salt fog made by atomizing a 20% salt solution at 100° F.

BURNDY, as well as other manufacturers and utility companies, have done a great deal of testing and a considerable area of agreement has been reached. There are, however, minor differences in recommended practices. The problem is concerned with aluminum and aluminum to copper connections since the effect of corrosion on copper to copper connections is far less serious. Let us study the recommended practices.

Aluminum to Aluminum Connections: For joining aluminum to aluminum conductors, there is little disagreement that an aluminum bodied connector is the proper choice, since this obviously eliminates the galvanic corrosion of dissimilar metals. However, even in this case, care must be taken to prevent crevice corrosion and to select an alloy of aluminum for the connector body that is free from cracking due to stress corrosion.

Aluminum to Copper Connections: Similarly, for joining aluminum to copper conductors, an aluminum bodied connector is the best choice since it prevents galvanic corrosion of the aluminum conductor, the most vulnerable element to attack in the connection. Realizing this, BURNDY initiated a research program aimed at finding the best way to make an aluminum

Introduction - Basic Electrical Connection Principles: (continued)

+ LESS NOBLE (ANODIC)

- ↓ Magnesium
- ↓ Magnesium alloys
- ↓ Zinc
- ↓ Aluminum 1100
- ↓ Cadmium
- ↓ Aluminum 2024-T4
- ↓ Steel or Iron
- ↓ Cast Iron
- ↓ Chromium Iron (Active)
- ↓ Ni-Resist
- ↓ Type 304 Stainless (Active)
- ↓ Type 316 Stainless (Active)
- ↓ Lead Tin Solders
- ↓ Lead
- ↓ Tin
- ↓ Nickel (Active)
- ↓ Inconel
- ↓ Brasses
- ↓ Copper
- ↓ Bronzes
- ↓ Copper-Nickel alloys
- ↓ Monel
- ↓ Silver Solder
- ↓ Nickel (Passive)
- ↓ Inconel (Passive)
- ↓ Chromium-Iron (Passive)
- ↓ Type 304 Stainless (Passive)
- ↓ Type 316 Stainless (Passive)
- ↓ Silver
- ↓ Titanium
- ↓ Graphite
- ↓ Gold
- ↓ Platinum

— MORE NOBLE (CATHODIC)

Figure 3

connector suitable for joining aluminum to copper conductors.

This led to the evolution of the “Massive Anode Principle” of connector design for joining conductors of dissimilar metal. On the basis of this principle, properly designed, all-aluminum connectors became available for universal use in joining aluminum to aluminum or aluminum to copper conductors.

Massive Anode Principle: By making the aluminum connector massive in comparison to the copper conductor, when the copper conductor emerges from the connector, the electrolytic current density over the exposed face of the aluminum connector is greatly reduced. This is schematically represented in Figure 4. Since the rate of corrosion is directly related to the current density on the surface of the anodic material, the relatively large face of the aluminum connector will suffer only minor attack.

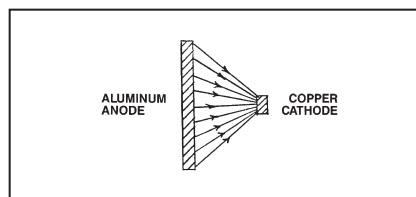

Figure 4

In addition, because the aluminum connector body is massive in the region where the corrosion occurs, the small loss of metal caused by corrosion is insignificant, even after long periods of service. Furthermore, the connector design should be such that clamping bolts, and areas of high stress which provide structural strength, are not in the regions subject to galvanic attack.

The effectiveness of this theory has been amply demonstrated in salt spray corrosion tests in which the connectors were subject to 1,000 hours in the salt spray fog with only minor corrosive pitting adjacent to the copper conductor, as seen in Figure 5. In addition, the aluminum conductor was completely protected, and the joint resistance remained virtually unchanged. The test involved a wide variety of sizes and types of connectors showing the effectiveness for small service connectors as well as large power connectors. Figure 6 shows a large all aluminum clamp type T connector installed on 3-1/2" diameter copper run and 750 kcmil aluminum tap. The figure shows this connector which was opened up after 1,400 hours of the salt spray test. Note that the contact surfaces are bright and clean and the only

evidence is minor pitting along the faces adjacent to the copper.

*It should be emphasized that a good compound should be used on the contact surfaces whether aluminum or copper is used in an aluminum connector.

Position of Conductor: A properly designed aluminum connector for joining aluminum to copper must provide adequate separation between the conductors to prevent electrolytic attack on the aluminum conductor. Even then, it is good practice to install the aluminum conductor above the copper conductor if possible. This will prevent pitting of the aluminum conductor due to copper salts being washed over the aluminum.

Plated Aluminum Connectors: Plating has been used as a means to make an aluminum connector suitable for copper conductor. Such platings as copper, zinc, tin and cadmium have been used. The plating of aluminum is much more critical than plating a more noble metal such as copper. In addition, a preplate, usually of copper or brass, must be applied, thus introducing numerous metals and further possibilities for galvanic corrosion.

To be effective in reducing galvanic corrosion between the copper conductor and the aluminum connector, the plated metal must be closer in the Electrolytic Series to copper than is aluminum. It must therefore, be cathodic to aluminum. Since porosity and minor scratches are always present, galvanic action can be expected in the presence of moisture, resulting in attack of the aluminum under the plating. Corrosion tests reveal attack in the form of a mottled appearance and flaking of the plating.

In addition, the presence of plated metal can cause galvanic attack of the aluminum conductor, thus reducing the protection offered to this conductor in an aluminum connector.

Cleaning and the Use of Compound: It should be emphasized that when aluminum connectors or conductors are involved, proper cleaning of the aluminum and the use of a good connector compound, such as BURNDY PENETROX™ A, are essential for trouble-free service. BURNDY, as well as other manufacturers, provide the contact grooves with a coating to make it unnecessary to clean the connectors, but in all cases the aluminum conductor should be

Introduction - Basic Electrical Connection Principles: (continued)

cleaned by means such as scratch brushing, and immediately coated with the connector compound.

To simplify the application of the compound, and to assure its use, almost all BURNDY aluminum connectors, except the large clamp type substation connectors, are supplied factory filled with PENETROX™ compound. For the tubular compression connectors, the tubular barrels are sufficiently filled with PENETROX™ and capped. For other types, the contact grooves are filled with PENETROX™ and enclosed in plastic packaging in a process called 'stripsealing'.

Clamp vs. Compression: In general, a compression connection can be expected to be more corrosion resistant than a clamp connection. The high pressures applied to a compression connector more effectively seal the contact against the penetration of moisture. The tubular sleeve of a compression connector has no side openings such as exist in clamp connectors between the clamping members. On the other hand, the clamp connector can be made more corrosion resistant if the conductor grooves conform more closely with the conductor contour. Thus a clamp connector made to accommodate a wide range of conductor sizes cannot be expected to be as corrosion resistant as one designed for one specific conductor size. Nevertheless, the differences in effectiveness of various designs can be minimized if a good contact compound is used.

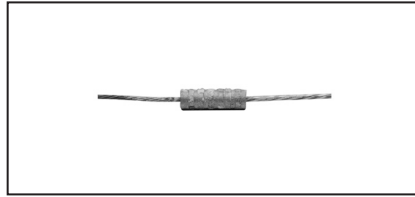

Figure 5

Negligible Corrosion of Severe Salt Spray on Compression Connector Joining Aluminum to Copper.

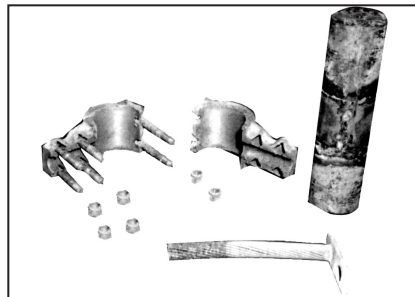

Figure 6

Large Aluminum Bolted Connector Joining Copper Run to Aluminum Tap After Severe Salt Spray Test.

HARDWARE DATA

Recommended Tightening Torque

The hardware used in connectors must be compatible with the connector material, have high mechanical strength and be corrosion resistant.

Copper alloy connectors have hardware made of DURIMUM™, which is the BURNDY trade name for silicon bronze alloy ASTM B99. This material was first introduced by BURNDY in 1927 for use in outdoor construction and today is the standard throughout the industry.

Aluminum connectors generally have aluminum alloy hardware. The bolts are 2024T4 and anodized to resist corrosion. The nuts are 6061T6, which is resistant to corrosion and does not require anodizing. Bolts are lubricated to eliminate galling and to provide consistent clamping forces.

The size material for clamping hardware are selected to provide the required force when tightened to the recommended torque. To reduce or greatly exceed the recommended torque can adversely affect the performance of the connector.

Steel Hardware	
Bolt Size	Recommended Torque (Inch Pounds)
1/4 - 20	80
5/16 - 18	180
3/8 - 16	240
1/2 - 13	480
5/8 - 11	660
3/4 - 10	1050

Aluminum Hardware	
Bolt Size	Recommended Torque (Inch Pounds)
1/2 - 13	300
5/8 - 11	480
3/4 - 10	650

DURIMUM™ (Silicon Bronze) Hexagonal Bolt Data

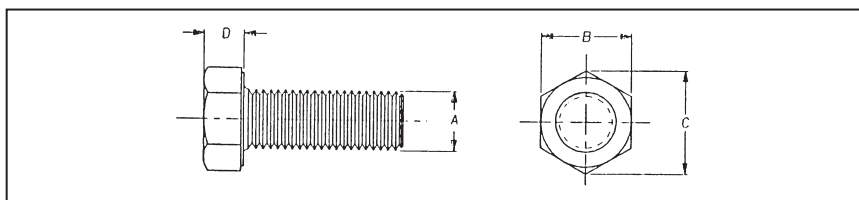

DURIMUM™ (Silicon Bronze) Hardware							
Catalog Number Series*	"A" Bolt Size	"B"	"C"	"D"	Recommended Torque (in-lb)**	Min. Breaking Force (lb)	Min. Shearing Force (lb)
25X__HEB	1/4 - 20	7/16	.50	.16	80	1,780	990
31X__HEB	5/16 - 18	1/2	.56	.21	180	2,930	1,640
38X__HEB	3/8 - 16	9/16	.65	.24	240	4,350	2,430
50X__HEB	1/2 - 13	3/4	.87	.32	480	7,950	4,460
62X__HEB	5/8 - 11	15/16	1.08	.40	660	12,700	7,100
75X__HEB	3/4 - 10	1-1/8	1.30	.48	1050	17,510	10,540

* __ is substituted for bolt length; Consult sales representative for available lengths

**These torque values develop maximum bolt preload

This drawing is based on BURNDY engineering specification

HARDWARE DATA (continued)

Recommended Termination Hardware

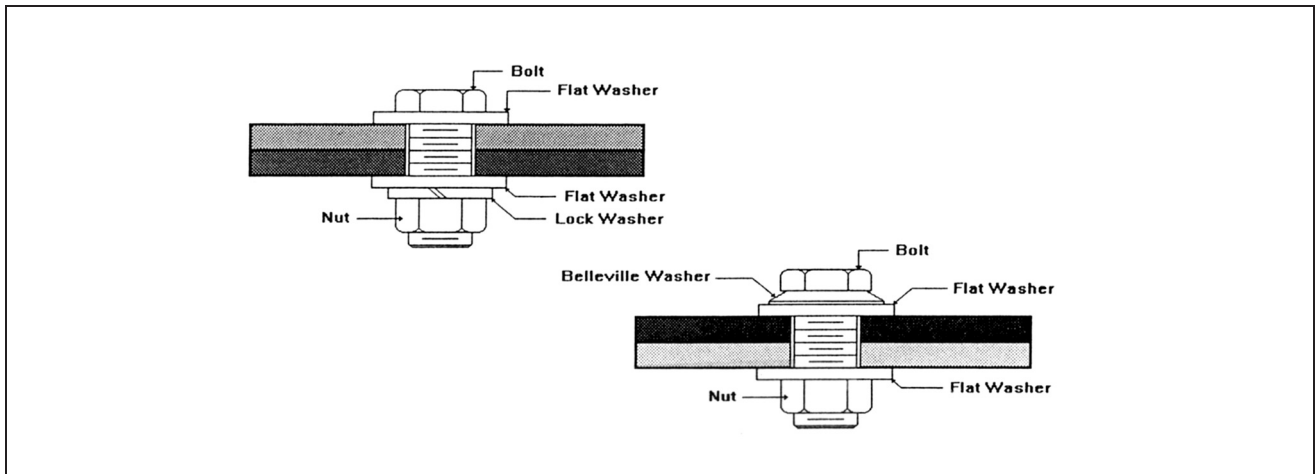

Recommended Tightening Torque per UL 486A and UL486B

Table 21 - Tightening torque for screws

Conductor Size Installed in Connector		Tightening Torque, N•m (lbf-in)			
		Slotted Head No. 10 and Larger*		Hexagonal Head - External Drive Socket Wrench	
		Slot Width - 1.2mm (.047 in) or Less and Slot Length - 6.4mm (1/4 in.) or less	Slot Width - Over 1.2mm (.047 in) or Slot Length - Over 6.4mm (1/4 in.)	Split-Bolt Connectors	Other Connectors
AWG or kcmil	mm ²				
30 - 10	.05 - 5.3	2.3 (20)	4.0 (35)	9.0 (80)	8.5 (75)
8	8.4	2.8 (25)	4.5 (40)	9.0 (80)	8.5 (75)
6 - 4	13.2 - 21.2	4.0 (35)	5.1 (45)	18.6 (165)	12.4 (110)
3	26.7	4.0 (35)	5.6 (50)	31.1 (275)	16.9 (150)
2	33.6	4.5 (40)	5.6 (50)	31.1 (275)	16.9 (150)
1	42.4	-	5.6 (50)	31.1 (275)	16.9 (150)
1/0 - 2/0	53.5 - 67.4	-	5.6 (50)	43.5 (385)	20.3 (180)
3/0 - 4/0	85.0 - 107.2	-	5.6 (50)	56.5 (500)	28.2 (250)
250 - 350	127 - 177	-	5.6 (50)	73.4 (650)	36.7 (325)
400	203	-	5.6 (50)	93.2 (825)	36.7 (325)
500	253	-	5.6 (50)	93.2 (825)	42.4 (375)
600 - 750	304 - 380	-	5.6 (50)	113.0 (1000)	42.4 (375)
800 - 1000	406 - 508	-	5.6 (50)	124.3 (1100)	56.5 (500)
1250 - 2000	635 - 1000	-	-	124.3 (1100)	67.8 (600)

* For values of slot width or length not corresponding to those specified, select the largest torque value associated with the conductor size. Slot width is the nominal design value. Slot length shall be measured at the bottom of the slot.

HARDWARE DATA (continued)

Recommended Tightening Torque per UL486A & UL486B

Table 22 - Tightening torque for slotted head screws smaller than No. 10 intended for use with 8 AWG (8.4 mm²) or smaller conductors

Slot Length of Screw*		Tightening Torque, N•m (lbf-in)	
		Slot Width of Screw Smaller than 1.2 mm (.047 in.) ^b	Slot Width of Screw 1.2mm (.047 in.) and larger**
mm	inch		
Less than 4	Less than 5/32	0.79 (7)	1.0 (9)
4	5/32	0.79 (7)	1.4 (12)
4.8	3/16	0.79 (7)	1.4 (12)
5.6	7/32	0.79 (7)	1.4 (12)
6.4	1/4	1.0 (9)	1.4 (12)
7.1	9/32	-	1.7 (15)
Above 7.1	Above 9/32	-	2.3 (20)

* For slot lengths of intermediate values, select torques pertaining to next shorter slot length.

Also see Table 21 for screws with multiple tightening means.

Slot length shall be measured at the bottom of the slot.

** Slot width is the nominal design value

Recommended Tightening Torque per UL486A & UL486B

Table 23 - Tightening torque for screws with recessed allen or square drives

Socket Width Across Flats*		Tightening Torque, N•m (lbf-in)
mm	inch	
3.2	1/8	5.1 (45)
4.0	5/32	11.3 (100)
4.8	3/16	13.6 (120)
5.6	7/32	16.9 (150)
6.4	1/4	25.4 (225)
7.9	5/16	33.9 (300)
9.5	3/8	45.2 (400)
12.7	1/2	56.6 (500)
14.3	9/16	67.8 (600)

* See Table 21 for screws with multiple tightening means

HARDWARE DATA (continued)

Recommended Clamping on Bolted Connectors:

When installing a bolted connector, an appropriate sequence needs to be followed.

INSTALLATION INSTRUCTIONS:

1. Nuts need to be tightened up to 30% of expected torque.
2. A check needs to be done to ensure the clamping elements are even.

Even clamping elements

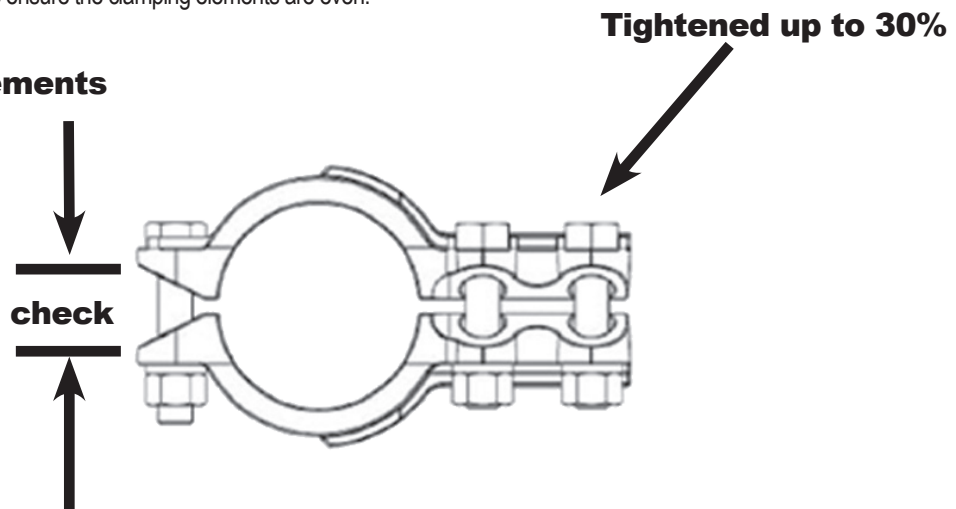

3. Tightening has to follow a sequence (1-6) as shown below. As a general rule, the torque has to be applied to the nut. For ease of installation most connectors are designed for one wrench installation. A torque wrench is recommended when tightening the nut to ensure the proper torque is applied.

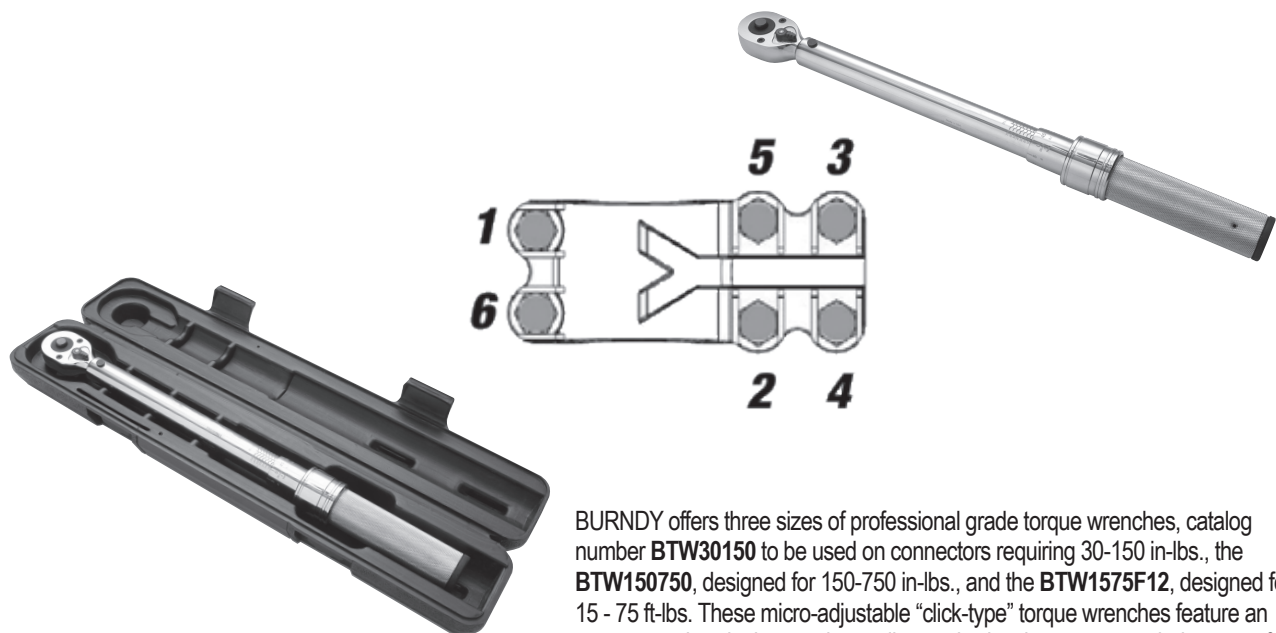

BURNDY offers three sizes of professional grade torque wrenches, catalog number **BTW30150** to be used on connectors requiring 30-150 in-lbs., the **BTW150750**, designed for 150-750 in-lbs., and the **BTW1575F12**, designed for 15 - 75 ft-lbs. These micro-adjustable "click-type" torque wrenches feature an easy-to-read scale that can be easily matched to the recommended torque of each of our mechanical connector products. Calibration traceable to N.I.S.T.

CABLE DATA

COPPER TUBE (BUS)

Size of Tube IPS	Diameter of Tube (Inches)		Wall Thickness (Inches)
	Outside	Inside	
STANDARD PIPE SIZES			
1/4"	0.540	0.375	0.082
3/8"	0.675	0.494	0.090
1/2"	0.840	0.625	0.107
3/4"	1.050	0.822	0.114
1"	1.315	1.062	0.126
1-1/4"	1.660	1.368	0.146
1-1/2"	1.900	1.600	0.150
2"	2.375	2.062	0.156
2-1/2"	2.875	2.500	0.187
3"	3.500	3.062	0.219
3-1/2"	4.000	3.500	0.250
4"	4.500	4.000	0.250
4-1/2"	5.000	4.500	0.250
5"	5.563	5.063	0.250
6"	6.625	6.125	0.250
EXTRA HEAVY PIPE SIZES			
1/4"	0.540	0.294	0.123
3/8"	0.675	0.421	0.127
1/2"	0.840	0.542	0.149
3/4"	1.050	0.736	0.157
1"	1.315	0.951	0.182
1-1/4"	1.660	1.272	0.194
1-1/2"	1.900	1.494	0.203
2"	2.375	1.933	0.221
2-1/2"	2.875	2.315	0.280
3"	3.500	2.892	0.304
3-1/2"	4.000	3.358	0.321
4"	4.500	3.818	0.341
4-1/2"	5.000	4.250	0.375
5"	5.563	4.813	0.375
6"	6.625	5.751	0.437

Size of Tube IPS	Diameter of Tube (Inches)		Wall Thickness (Inches)
	Outside	Inside	
DOUBLE EXTRA HEAVY PIPE SIZES			
1/2"	0.840	0.252	0.294
3/4"	1.050	0.434	0.308
1"	1.315	0.599	0.358
1-1/4"	1.660	0.896	0.382
1-1/2"	1.900	1.100	0.400
2"	2.375	1.503	0.436
2-1/2"	2.875	1.771	0.552
3"	3.500	2.300	0.600
3-1/2"	4.000	2.728	0.636
4"	4.500	3.152	0.674
4-1/2"	5.000	3.580	0.710
5"	5.563	4.063	0.750
6"	6.625	4.897	0.864

Tube dimensions (excepting wall thickness of double extra heavy) taken from A.S.T.M. Specification B42-33.

Tubular values based on a density of 0.322 pound per cubic inch.

* Conductivity of 98% I.A.C.S. at 20° C or 68° F

CABLE DATA (continued)

SOLID COPPER WIRE (ASTM B1, B2, & B3)

Size AWG (Solid)	Wire Dia (Inch)	Hard Drawn	Medium Drawn	Soft Drawn
		Normal Breaking Load (Pounds)	Minimum Breaking Load (Pounds)	Elongation in 10 in. % Min.
18	.040	85.8	67.6	25
17	.045	107.5	84.7	25
16	.050	135.2	106.2	25
15	.057	170.0	133.0	25
14	.064	213.8	166.6	25
13	.071	268.2	208.0	25
12	.080	337.0	261.6	25
11	.090	422.5	327.6	25
10	.101	529.2	410.4	25
9	.114	661.0	514.2	30
8	.128	826.0	643.9	30
7	.144	1,030.0	806.6	30
6	.162	1,280.0	1,010.0	30
5	.181	1,591.0	1,265.0	30
4	.204	1,970.0	1,584.0	30
3	.229	2,439.0	1,984.0	30
2	.257	3,003.0	2,450.0	30
1	.289	3,688.0	3,024.0	30
1/0	.324	4,519.0	3,730.0	35
2/0	.364	5,518.0	4,599.0	35
3/0	.409	6,722.0	5,667.0	35
4/0	.460	8,143.0	6,980.0	35

**COMPACT STRANDED COPPER CABLE
(ASTM SPEC. B496)**

Conductor Size		Number of Wires	Conductor Dia (in)
KCMIL	AWG		
1000		61 ¹	1.060
900		61 ¹	0.999
800		61 ¹	0.938
750		61 ¹	0.908
700		61 ¹	0.877
650		61 ¹	0.845
600		61 ¹	0.813
550		61 ¹	0.775
500		37 ²	0.736
450		37 ²	0.700
400		37 ²	0.659
350		37 ²	0.616
300		37 ²	0.570
250		37 ²	0.520
	4/0	19 ³	0.475
	3/0	19 ³	0.423
	2/0	19 ³	0.376
	1/0	19 ³	0.336
	1	19 ³	0.299
	2	7	0.268
	4	7	0.213
	6	7	0.169
	8	7	0.134

¹ 58 Wires Minimum

² 35 Wires Minimum

³ 18 Wires Minimum

CABLE DATA (continued)

STRANDED COPPER WIRE (ASTM B8 EXCLUDING BREAKING LOADS)

Size		A.S.T.M. Strandings			Hard Drawn	Medium Drawn	Soft Drawn
Stranded		Class	No. of Wires	Cable Diameter (Inches)	Minimum Breaking Load (Pounds)		
Circular Mils	AWG						
1,022	20	B	7	0.036	50.0	40.67	32.1
1,624	18	B	7	0.045	79.0	63.91	51.0
2,583	16	B	7	0.057	124.7	100.4	81.1
4,107	14	B	7	0.072	197.1	157.7	124.2
6,530	12	B	7	0.091	311.1	247.7	197.5
10,380	10	B	7	0.116	491.7	388.9	314.0
13,090	9	B	7	0.130	618.2	487.4	395.9
16,510	8	B	7	0.146	777.2	610.7	499.2
20,820	7	B	7	0.164	977.1	765.2	629.5
26,250	6	B	7	0.184	1,288.0	958.6	793.8
33,100	5	B	7	0.206	1,542.0	1,201.0	1,001.0
41,740	4	AA	3	0.254	1,879.0	1,465.0	1,213.0
41,740	4	B&A	7	0.232	1,938.0	1,505.0	1,262.0
52,630	3	AA	3	0.285	2,359.0	1,835.0	1,530.0
52,630	3	B&A	7	0.260	2,433.0	1,885.0	1,592.0
66,370	2	AA	3	0.320	2,913.0	2,299.0	1,929.0
66,370	2	B&A	7	0.292	3,045.0	2,361.0	2,007.0
83,690	1	AA	3	0.360	3,621.0	2,879.0	2,432.0
83,690	1	A	7	0.328	3,804.0	2,958.0	2,432.0
83,690	1	B	19	0.332	3,899.0	3,037.0	2,531.0
105,500	1/0	A&A	7	0.368	4,752.0	3,705.0	3,067.0
105,500	1/0	-	12	0.390	4,841.0	3,755.0	3,191.0
105,500	1/0	B	19	0.373	4,901.0	3,805.0	3,191.0
133,100	2/0	A&A	7	0.414	5,926.0	4,640.0	3,867.0
133,100	2/0	-	12	0.438	6,048.0	4,703.0	3,867.0
133,100	2/0	B	19	0.419	6,152.0	4,765.0	4,024.0
167,800	3/0	A&A	7	0.464	7,366.0	5,812.0	4,876.0
167,800	3/0	-	12	0.492	7,556.0	5,890.0	4,876.0
167,800	3/0	B	19	0.470	7,698.0	5,970.0	5,074.0
211,600	4/0	A&A	7	0.522	9,154.0	7,278.0	6,149.0
211,600	4/0	-	12	0.522	9,483.0	7,378.0	6,149.0
211,600	4/0	B	19	0.528	9,617.0	7,479.0	6,149.0

CABLE DATA (continued)

STRANDED COPPER WIRE (ASTM B8 EXCLUDING BREAKING LOADS continued)

Size	A.S.T.M. Strandings			Hard Drawn	Medium Drawn	Soft Drawn
	Circular Mils	Class	No. of Wires			
250 kcmil	AA	12	0.600	11,130	8,717	7,265
250 kcmil	A	19	0.574	11,360	8,986	7,265
250 kcmil	B	37	0.575	11,560	8,952	7,559
300 kcmil	AA	12	0.657	13,170	10,390	8,718
300 kcmil	A	19	0.628	13,510	10,530	8,718
300 kcmil	B	37	0.630	13,870	10,740	9,071
350 kcmil	AA	12	0.710	15,140	12,040	10,170
350 kcmil	A	19	0.679	15,590	12,200	10,170
350 kcmil	B	37	0.681	16,060	12,450	10,580
400 kcmil	A&AA	19	0.726	17,810	13,950	11,620
400 kcmil	B	37	0.728	18,320	14,140	11,620
450 kcmil	AA	19	0.770	19,750	15,590	13,080
450 kcmil	B&A	37	0.772	20,450	15,900	13,080
500 kcmil	AA	19	0.811	21,950	17,320	14,530
500 kcmil	B&A	37	0.813	22,510	17,550	14,530
600 kcmil	A&AA	37	0.891	27,020	21,060	17,440
600 kcmil	B	61	0.893	27,530	21,350	18,140
700 kcmil	AA	37	0.963	31,170	24,410	20,340
700 kcmil	B&A	61	0.964	31,820	24,740	20,340
750 kcmil	AA	37	0.997	33,400	26,150	21,790
750 kcmil	B&A	61	0.998	34,090	26,510	21,790
800 kcmil	AA	37	1.029	35,120	27,710	23,250
800 kcmil	B&A	61	1.031	36,360	28,270	23,250
900 kcmil	AA	37	1.092	39,510	31,170	26,150
900 kcmil	B&A	61	1.094	40,520	31,590	26,150
1000 kcmil	AA	37	1.151	43,830	34,400	29,060
1000 kcmil	B&A	61	1.152	45,030	35,100	29,060
1250 kcmil	A	61	1.288	55,670	43,590	36,320
1250 kcmil	B	91	1.289	56,280	43,880	36,320
1500 kcmil	A	61	1.411	65,840	51,950	43,590
1500 kcmil	B	91	1.412	67,540	52,650	43,590
1750 kcmil	A	91	1.526	77,930	61,020	50,850
1750 kcmil	B	127	1.526	78,800	61,430	50,850
2000 kcmil	A	91	1.630	87,790	69,270	58,120
2000 kcmil	B	127	1.632	90,050	70,210	58,120

CABLE DATA (continued)

FLEXIBLE COPPER STRANDED CABLE

Conductor Size kcmil or B & S G (AWG)	# Strands	Strand Diameter	Nominal Diameter	Class
8	41	.0201	.156	I
8	49	.0184	.166	G
8	133	.0111	.167	H
8	168	.010	.157	K
8	420	.0063	.162	M
7	49	.0206	.185	G
7	52	.0201	.185	I
7	133	.0125	.188	H
7	210	.010	.179	K
7	532	.0063	.196	M
6	49	.0231	.208	G
6	63	.0201	.207	I
6	133	.0140	.210	H
6	266	.010	.210	K
6	665	.0063	.215	M
5	49	.0260	.234	G
5	84	.0201	.235	I
5	133	.0158	.237	H
5	336	.010	.235	K
5	836	.0063	.240	M
4	49	.0292	.263	G
4	105	.0201	.263	I
4	133	.0177	.266	H
4	420	.010	.272	K
4	1064	.0063	.269	M
3	49	.0328	.295	G
3	133	.0199	.299	I
3	133	.0201	.291	H
3	532	.010	.304	K
3	1323	.0063	.305	M
2	49	.0368	.331	G
2	133	.0223	.335	I
2	161	.0201	.319	H
2	665	.010	.338	K
2	1666	.0063	.337	M
1	133	.0251	.377	G
1	210	.0201	.367	I
1	259	.018	.378	H
1	836	.010	.397	K
1	2107	.0063	.376	M

Conductor Size kcmil or B & S G (AWG)	# Strands	Strand Diameter	Nominal Diameter	Class
1/0	133	.0282	.423	I
1/0	259	.0202	.424	G
1/0	266	.0201	.441	H
1/0	1064	.010	.451	K
1/0	2646	.0063	.423	M
2/0	133	.0316	.474	G
2/0	259	.0227	.477	I
2/0	342	.0201	.500	H
2/0	1323	.010	.470	K
2/0	3325	.0063	.508	M
3/0	133	.0355	.533	G
3/0	259	.0255	.536	I
3/0	418	.0201	.549	H
3/0	1666	.010	.533	K
3/0	4256	.0063	.576	M
4/0	133	.0399	.599	G
4/0	259	.0286	.601	I
4/0	532	.0201	.613	H
4/0	2107	.010	.627	K
4/0	5320	.0063	.645	M
250	259	.0311	.650	G
250	427	.0242	.653	I
250	637	.0201	.682	H
250	2499	.010	.682	K
250	6384	.0063	.713	M
300	259	.0340	.714	G
300	427	.0265	.716	I
300	735	.0201	.737	H
300	2989	.010	.768	K
300	7581	.0063	.768	M
350	259	.0368	.773	G
350	427	.0286	.772	I
350	882	.0201	.800	H
350	3458	.010	.809	K
350	8806	.0063	.825	M
400	259	.0393	.825	G
400	427	.0306	.826	I
400	980	.0201	.831	H
400	3990	.010	.878	K
400	10101	.0063	.901	M

CABLE DATA (continued)

FLEXIBLE COPPER STRANDED CABLE (continued)

Conductor Size kcmil or B & S G (AWG)	# Strands	Strand Diameter	Nominal Diameter	Class
450	259	.0417	.876	I
450	427	.0325	.878	G
450	1127	.0201	.894	H
450	4522	.010	.933	K
450	11396	.0063	.940	M
500	259	.0439	.922	G
500	427	.0342	.923	I
500	1225	.0201	.941	H
500	5054	.010	.988	K
500	12691	.0063	.997	M
600	427	.0375	1.013	G
600	703	.0292	1.022	I
600	1470	.0201	1.027	H
600	5985	.010	1.125	K
600	14945	.0063	1.084	M
700	427	.0405	1.094	G
700	703	.0316	1.106	I
700	1729	.0201	1.194	H
700	6916	.010	1.207	K
700	17507	.0063	1.183	M
800	427	.0433	1.169	G
800	703	.0337	1.180	I
800	1995	.0201	1.290	H
800	7980	.010	1.305	K
800	20069	.0063	1.256	M
900	427	.0459	1.239	G
900	703	.0358	1.253	I
900	2261	.0201	1.372	H
900	9065	.010	1.323	K
900	22631	.0063	1.331	M
1000	427	.0484	1.307	G
1000	703	.0377	1.320	I
1000	2527	.0201	1.427	H
1000	10101	.010	1.419	K
1000	25193	.0063	1.404	M

CABLE DATA (continued)

ALUMINUM TUBE

Size of Tube IPS	Diameter of Tube (Inches)		Wall Thickness (Inches)
	Outside	Inside	
STANDARD PIPE SIZES			
1/4"	0.540	0.364	0.088
3/8"	0.675	0.493	0.091
1/2"	0.840	0.622	0.109
3/4"	1.050	0.824	0.113
1"	1.315	1.049	0.133
1-1/4"	1.660	1.380	.0140
1-1/2"	1.900	1.610	0.145
2"	2.375	2.067	0.154
2-1/2"	2.875	2.469	0.203
3"	3.500	3.068	0.213
3-1/2"	4.000	3.548	0.226
4"	4.500	4.026	0.237
4-1/2"	5.000	4.506	0.247
5"	5.563	5.047	0.258
6"	6.625	6.065	0.280

Size of Tube IPS	Diameter of Tube (Inches)		Wall Thickness (Inches)
	Outside	Inside	
EXTRA HEAVY PIPE SIZES			
1/4"	0.540	0.302	0.119
3/8"	0.675	0.423	0.126
1/2"	0.840	0.546	0.147
3/4"	1.050	0.742	0.154
1"	1.315	0.957	0.179
1-1/4"	1.660	1.278	0.191
1-1/2"	1.900	1.500	0.200
2"	2.375	1.939	0.218
2-1/2"	2.875	2.323	0.276
3"	3.500	2.900	0.300
3-1/2"	4.000	3.364	0.318
4"	4.500	3.826	0.337
4-1/2"	5.000	4.290	0.355
5"	5.563	4.813	0.375
6"	6.625	5.761	0.432

CABLE DATA (continued)

**ALUMINUM 1350 CABLE
BARE-CLASSES AA AND A - Hard Drawn**

Cable Code Word	Size (circular mils or AWG)	Copper Equivalent based on equal D.C. resistance, Cu 97% Al 61%	# of Wires	Cable Dia. (inches)	Ultimate Strength (pounds)
Peachbell	6	8	7	0.184	528
Rose	4	6	7	0.232	826
Lily	3	5	7	0.260	1022
Iris	2	4	7	0.292	1266
Pansy	1	3	7	0.328	1537
Poppy	1/0	2	7	0.368	1865
Aster	2/0	1	7	0.414	2350
Phlox	3/0	1/0	7	0.464	2845
Oxlip	4/0	2/0	7	0.522	3590
Daisy	266800	3/0	7	0.586	4525
Laurel	266800	3/0	19	0.593	4800
Tulip	336400	4/0	19	0.666	5940
Canna	397500	250000	19	0.724	6880
Cosmos	477000	300000	19	0.793	8090
Syringa	477000	300000	37	0.795	8600
Dahlia	556500	350000	19	0.856	9440
Mistletoe	556500	350000	37	0.858	9830
Orchid	636000	400000	37	0.918	11240
Violet	715500	450000	37	0.974	12640
Nasturtium	715500	450000	61	0.975	13150
Arbutus	795000	500000	37	1.026	13770
Lilac	795000	500000	61	1.028	14330
Anemone	874500	550000	37	1.077	14830
Crocus	874500	550000	61	1.078	15760
Magnolia	954000	600000	37	1.124	16180
Goldenrod	954000	600000	61	1.126	16860
Bluebell	1033500	650000	37	1.170	17530
Larkspur	1033500	650000	61	1.172	18260
Marigold	1113000	700000	61	1.216	19660
Narcissus	1272000	800000	61	1.300	22000
Carnation	1431000	900000	61	1.379	24300
Coreopsis	1590000	1000000	61	1.454	27000
Dogwood	1590000	1000000	91	1.454	28100

CABLE DATA (continued)

ALUMINUM 1350 CABLE
BARE-CLASS B

Size (circular mils or AWG)	Copper Equivalent based on equal D.C. resistance, Cu 97% Al 61%	# of Wires	Cable Dia. (inches)	Ultimate Strength (pounds) Hard Drawn	Minimum Ultimate Strength (pounds) 3/4 Hard	Minimum Ultimate Strength (pounds) Inter Temper
250000	157300	37	0.575	4860	3338	2946
300000	188800	37	0.629	5831	4005	3534
350000	220200	37	0.681	6680	4673	4123
400000	251500	37	0.728	7352	5341	4713
450000	283000	37	0.772	8110	6007	5301
500000	314500	37	0.813	9012	6675	5890
550000	346000	61	0.855	10490	7344	6480
600000	377000	61	0.893	11450	8010	7068
650000	409000	61	0.929	11940	8678	7657
700000	440000	61	0.964	12860	9346	8247
750000	472000	61	0.998	13510	10010	8835
800000	503000	61	1.031	14410	10680	9424
900000	566000	61	1.094	15900	12010	10600
1000000	629000	61	1.152	17670	13350	11780
1100000	692000	91	1.209	20210	14680	12950
1200000	755000	91	1.263	21630	16020	14130
1250000	786000	91	1.289	22530	16690	14720
1300000	818000	91	1.315	23430	17350	15310
1400000	880000	91	1.364	24750	18700	16500
1500000	943000	91	1.412	26500	20020	17670
1600000	1006000	127	1.459	28840	21360	18850
1700000	1069000	127	1.504	30630	22690	20020
1750000	1101000	127	1.526	31530	23350	20610
1800000	1132000	127	1.548	32450	24030	21210
1900000	1195000	127	1.590	33570	25360	22380
2000000	1258000	127	1.632	35340	26700	23560
2500000	1570000	127	1.824	43300	33380	29460
3000000	1890000	169	1.998	53010	40050	35340
3500000	2200000	169	2.158	60610	46730	41230

CABLE DATA (continued)

ACSR

Cable Code Word	Size (circular mils or AWG)	No. Alum Strands	No. Steel Strands	Complete Cable Dia. (inches)	Steel Core Dia. (inches)	Copper Equivalent based on equal D.C. resistance, Cu 97% Al 61%	Ultimate Strength (pounds)
Turkey	6	6	1	0.198	0.0661	8	1170
Thrush	5	6	1	0.223	0.0743	7	1460
Swan	4	6	1	0.250	0.0834	6	1830
Swanate	4	7	1	0.257	0.1029	6	2288
Swallow	3	6	1	0.281	0.0937	5	2250
Sparrow	2	6	1	0.316	0.1052	4	2790
Sparate	2	7	1	0.325	0.1299	4	3525
Robin	1	6	1	0.355	0.1182	3	3480
Raven	1/0	6	1	0.398	0.1327	2	4280
Quail	2/0	6	1	0.447	0.1490	1	5345
Pigeon	3/0	6	1	0.502	0.1672	1/0	6675
Penguin	4/0	6	1	0.563	0.1878	2/0	8420
Waxwing	266800	18	1	0.609	0.1217	3/0	7100
Owl	266800	26	7	0.633	0.2109	3/0	9645
Partridge	266800	26	7	0.642	0.2364	3/0	11250
Ostrich	300000	26	7	0.680	0.2505	188700	12650
Merlin	336400	18	1	0.684	0.1367	4/0	8950
Linnet	336400	26	7	0.721	0.2655	4/0	14050
Oriole	336400	30	7	0.741	0.3177	4/0	17040
Chickadee	397500	18	1	0.743	0.1486	250000	10400
Brant	397500	24	7	0.771	0.2575	250000	14690
Ibis	397500	26	7	0.783	0.2883	250000	16190
Lark	397500	30	7	0.806	0.3453	250000	19980
Pelican	477000	18	1	0.814	0.1628	300000	12300
Flicker	477000	24	7	0.846	0.2820	300000	17200
Hawk	477000	26	7	0.858	0.3162	300000	19430
Hen	477000	30	7	0.883	0.3783	300000	23300
Parakeet	556500	24	7	0.914	0.3045	350000	19850
Dove	556500	26	7	0.927	0.341	350000	22400
Eagle	556500	30	7	0.953	0.409	350000	27200
Peacock	605000	24	7	0.953	0.318	380500	21500
Squab	605000	26	7	0.966	0.356	380500	24100
Teal	605000	30	19	0.994	0.426	380500	30000
Rook	636000	24	7	0.977	0.326	400000	22600
Grosbeak	636000	26	7	0.990	0.365	400000	25000
Egret	636000	30	19	1.019	0.437	400000	31500
Flamingo	666600	24	7	1.000	0.333	419000	23700
Crow	715500	54	7	1.036	0.345	450000	26300
Starling	715500	26	7	1.051	0.387	450000	28100
Redwing	715500	30	19	1.081	0.463	450000	34600
Condor	795000	54	7	1.093	0.364	500000	28500

CABLE DATA (continued)

ACSR (continued)

Cable Code Word	Size (circular mils or AWG)	No. Alum Strands	No. Steel Strands	Complete Cable Dia. (inches)	Steel Core Dia. (inches)	Copper Equivalent based on equal D.C. resistance, Cu 97% Al 61%	Ultimate Strength (pounds)
Drake	795000	26	7	1.108	0.408	500000	31200
Mallard	795000	30	19	1.140	0.489	500000	38400
Crane	874500	54	7	1.146	0.382	550000	31400
Canary	900000	54	7	1.162	0.387	566000	32300
Cardinal	954000	54	7	1.196	0.399	600000	34200
Curlew	1033500	54	7	1.246	0.415	650000	37100
Finch	1113000	54	19	1.293	0.431	700000	40200
Pheasant	1272000	54	19	1.382	0.461	800000	44800
Plover	1431000	54	19	1.465	0.489	900000	50400
Falcon	1590000	54	19	1.545	0.515	100000	56000

HIGH STRENGTH ACSR

Cable Code Word	Size (circular mils or AWG)	No. Alum Strands	No. Steel Strands	Complete Cable Dia. (inches)	Steel Core Dia. (inches)	Copper Equivalent based on equal D.C. resistance, Cu 97% Al 61%	Ultimate Strength (pounds)
Grouse	80000	8	1	0.367	0.1670	50310	5200
Petrel	101800	12	7	0.461	0.2763	64160	9860
Minorca	110800	12	7	0.481	0.2883	69700	10730
Leghorn	134600	12	7	0.530	0.3177	84600	12920
Guinea	159000	12	7	0.576	0.3453	100000	15200
Dotterel	176900	12	7	0.607	0.3642	111200	16440
Dorking	190800	12	7	0.631	0.3783	120000	17730
Cochin	211300	12	7	0.663	0.3981	132900	19640
Brahma	203200	16	9	0.714	0.4885	127800	27500

CABLE DATA (continued)

COMPACT ALUMINUM 1350 CABLE (ASTM B400) EXTRA HARD

Conductor Size		Class	No. of Wires	Cable Diameter (Inches)	Breaking Strength (pounds)
kcmil	AWG				
1000		B	61 ¹	1.060	17700
900		B	61 ¹	0.999	15900
800		B	61 ¹	0.938	14400
750		B	61 ¹	0.908	13500
700		B	61 ¹	0.877	12900
650		B	61 ¹	0.845	11900
600		B	61 ¹	0.813	11500
556		AA	19 ³	0.780	9750
550		B	61 ¹	0.775	10500
500		B	37 ²	0.736	9110
500		AA	19 ³	0.736	8760
477		AA	19 ³	0.722	8360
450		B	37 ²	0.700	8200
400		B	37 ²	0.659	7440
397		AA, A	19 ³	0.659	7110
350		B	37 ²	0.616	6760
350		A	19 ³	0.616	6390
336		A	19 ³	0.603	6150
336		AA	7	0.603	5960
300		B	37 ²	0.570	5890
300		A	19 ³	0.570	5480
300		AA	7	0.570	5430
266		A	19 ³	0.537	4970
266		AA	7	0.537	4830
250		B	37 ²	0.520	4910
250		A	19 ³	0.520	4660
250		AA	7	0.520	4520
	4/0	B	19 ³	0.475	4020
	4/0	AA, A	7	0.475	3830
	3/0	B	19 ³	0.423	3310
	3/0	AA, A	7	0.423	3040
	2/0	B	19 ³	0.376	2670
	2/0	AA, A	7	0.376	2510
	1/0	B	19 ³	0.336	2160
	1/0	AA, A	7	0.336	1990
	1	B	19 ³	0.299	1740
	1	AA, A	7	0.299	1640
	2	AA, A, B	7	0.268	1350
	3	A, B	7	0.238	1090
	4	A, B	7	0.213	.881
	6	A, B	7	0.169	.563
	8	A, B	7	0.134	.312

¹ 58 Wires Minimum
² 35 Wires Minimum
³ 18 Wires Minimum

CABLE DATA (continued)

ALUMINUM ALLOY 5005 CABLE (ASTM B397)

Conductor Size cmil	Number of Wires	Approx. Aluminum 1350 Size having Equivalent Resistance		Size & Stranding of ACSR with Equal Diameter			Rated Strength (pounds)
		cmil	AWG	cmil	AWG	Stranding	
927200	37	795000	-	795000	-	26/7	23900
740800	37	636000	-	636000	-	26/7	19300
652400	19	556500	-	556500	-	26/7	16200
587200	19	506500	-	506500	-	18/1	14600
559500	19	477000	-	477000	-	26/7	13900
503600	19	435500	-	435500	-	18/1	12500
465400	19	397500	-	397500	-	26/7	12200
419400	19	362000	-	362000	-	18/1	11200
394500	19	336400	-	336400	-	26/7	10500
355100	19	306400	-	306400	-	18/1	9600
312800	19	266800	-	266800	-	26/7	8450
281400	19	242900	-	242900	-	18/1	7610
246900	7	211600	4/0	211600	4/0	6/1	6330
195700	7	167800	3/0	167800	3/0	6/1	5020
155400	7	133100	2/0	133100	2/0	6/1	4280
123300	7	105600	1/0	105600	1/0	6/1	3440
77470	7	66360	2	66360	2	6/1	2200
48690	7	41740	4	41740	4	6/1	1430
30580	7	26240	6	26240	6	6/1	922

ALUMINUM ALLOY 6201 CABLE (ASTM B399)

Conductor Size cmil	Number of Wires	Approx. Aluminum 1350 Size having Equivalent Resistance		Size & Stranding of ACSR with Equal Diameter			Rated Strength (pounds)
		cmil	AWG	cmil	AWG	Stranding	
1439200	61	1272000	-	1272000	-	54/7	46800
1348800	61	1192500	-	1192500	-	54/7	43900
1259600	61	1113000	-	1113000	-	54/7	41000
1165100	61	1033500	-	1033500	-	54/7	37900
1077400	61	954000	-	954000	-	54/7	35000
927200	37	795000	-	795000	-	26/7	30500
740800	37	636000	-	636000	-	26/7	24400
652400	19	556500	-	556500	-	26/7	21900
559500	19	477000	-	477000	-	26/7	18800
465400	19	397500	-	397500	-	26/7	15600
394500	19	336400	-	336400	-	26/7	13300
312800	19	266800	-	266800	-	26/7	11000
246900	7	211600	4/0	211600	4/0	6/1	8560
195700	7	167800	3/0	167800	3/0	6/1	6790
155400	7	133100	2/0	133100	2/0	6/1	5390
123300	7	105600	1/0	105600	1/0	6/1	4460
77470	7	66360	2	66360	2	6/1	2800
48690	7	41740	4	41740	4	6/1	1760
30580	7	26240	6	26240	6	6/1	1110

CABLE DATA (continued)

ALUMINUM ALLOY 8000 SERIES “O” TEMPER CABLE ASTM B801)

Conductor Size		Number of Wires†	Class	Conductor Diameter (inches)			Min. Breaking Strength (pounds)
kcmil	AWG			Conventional	Compressed	Compact	
1000		127	D	1.153	1.119	1.060	6010
1000		91	C	1.153	1.118	1.060	6010
1000		61	B, A	1.152	1.117	1.060	6010
900		127	D	1.095	1.062	0.999	5400
900		91	C	1.093	1.060	0.999	5400
900		61	B, A	1.093	1.060	0.999	5400
800		127	D	1.032	1.001	0.938	4800
800		91	C	1.032	1.001	0.938	4800
800		61	B, A	1.031	1.000	0.938	4800
750		127	D	0.998	0.968	0.908	4500
750		91	C	0.999	0.969	0.908	4500
750		61	B, A	0.998	0.938	0.908	4500
700		127	D	0.965	0.936	0.877	4200
700		91	C	0.965	0.936	0.877	4200
700		61	B, A	0.964	0.935	0.877	4200
650		127	D	0.930	0.902	0.845	3900
650		91	C	0.930	0.902	0.845	3900
650		61	B	0.929	0.901	0.845	3900
650		37	A	0.928	0.900	0.845	3950
600		127	D	0.893	0.866	0.813	3600
600		91	C	0.893	0.866	0.813	3600
600		61	B	0.893	0.866	0.813	3600
600		37	A	0.891	0.864	0.813	3640
556		127	D	0.861	0.835	0.780	3340
556		91	C	0.860	0.834	0.780	3340
556		61	B	0.860	0.834	0.780	3340
556		37	A	0.858	0.832	0.780	3380
550		127	D	0.855	0.829	0.775	3300
550		91	C	0.855	0.829	0.775	3300
550		61	B	0.855	0.829	0.775	3300
550		37	A	0.853	0.827	0.775	3340
500		91	D	0.815	0.791	0.736	3000
500		61	C	0.815	0.791	0.736	3000
500		37	B, A	0.813	0.789	0.736	3040
477		91	D	0.796	0.772	0.722	2860
477		61	C	0.796	0.772	0.722	2860
477		37	B, A	0.795	0.771	0.722	2900
450		91	D	0.773	0.750	0.700	2700
450		61	C	0.773	0.750	0.700	2700
450		37	B, A	0.772	0.749	0.700	2730

CABLE DATA (continued)

ALUMINUM ALLOY 8000 SERIES "O" TEMPER CABLE (ASTM B801) Continued

Conductor Size		Number of Wires†	Class	Conductor Diameter (inches)			Min. Breaking Strength (pounds)
kcmil	AWG			Conventional	Compressed	Compact	
400		91	D	0.729	0.707	0.659	2400
400		61	C	0.729	0.707	0.659	2400
400		37	B, A	0.728	0.706	0.659	2430
397		91	D	0.727	0.705	0.659	2390
397		61	C	0.726	0.704	0.659	2390
397		37	B	0.725	0.703	0.659	2410
397		19	A	0.724	0.702	0.659	2470
350		91	D	0.682	0.661	0.616	2100
350		61	C	0.681	0.661	0.616	2100
350		37	B	0.681	0.661	0.616	2130
350		19	A	0.679	0.659	0.616	2170
336		61	C	0.669	0.649	0.603	2020
336		37	B	0.668	0.648	0.603	2040
336		19	A	0.666	0.646	0.603	2090
300		61	C	0.631	0.612	0.570	1800
300		37	B	0.630	0.611	0.570	1820
300		19	A	0.629	0.610	0.576	1860
266		61	C	0.595	0.577	0.537	1600
266		37	B	0.594	0.576	0.537	1620
266		19	A	0.593	0.575	0.537	1660
250		61	C	0.576	0.559	0.520	1500
250		37	B	0.575	0.558	0.520	1520
250		19	A	0.574	0.557	0.520	1550
	4/0	37	C	0.529	0.513	0.475	1280
	4/0	19	B	0.528	0.512	0.475	1310
	4/0	7	A	0.522	0.506	0.475	1360
	3/0	37	C	0.471	0.457	0.423	1020
	3/0	19	B	0.470	0.456	0.423	1040
	3/0	7	A	0.464	0.450	0.423	1070
	2/0	19	B	0.419	0.406	0.376	826
	2/0	7	A	0.414	0.402	0.376	853
	1/0	19	B	0.373	0.362	0.336	655
	1/0	7	A	0.368	0.357	0.336	676
	1	19	B	0.332	0.322	0.229	519
	2	7	B, A	0.292	0.283	0.268	425
	3	7	B, A	0.260	0.252	0.238	337
	4	7	B, A	0.232	0.225	0.213	267
	6	7	B, A	0.184	0.178	0.169	168
	8	7	B, A	0.146	0.142	0.134	106

† For compact-stranded constructions, the number of wires may be reduced as follows:

19-Wire Constructions - 18 Wires Minimum

61-Wire Constructions - 58 Wires Minimum

127-Wire Constructions - 122 Wires Minimum

37-Wire Constructions - 35 Wires Minimum

91-Wire Constructions - 87 Wires Minimum

CABLE DATA (continued)

COMPACT ACSR (ASTM B401)

Conductor Size		Cable Diameter (Inches)	Breaking Strength (pounds)
kcmil	AWG		
336.4		0.628	8260
266.8		0.559	6540
	4/0	0.517	7420
	3/0	0.461	5880
	2/0	0.410	4880
	1/0	0.365	3980
	1	0.326	3290
	2	0.298	3260
	2	0.290	2640
	3	0.258	2130
	4	0.236	2160
	4	0.229	1760
	6	0.182	1120

ACSR/TW (TRAP WIRE) CABLE (ASTM B779)

Conductor Size kcmil	Stranding		Nominal Diameter (inches)	Rated Strength (pounds)
	No. Aluminum Wires	No. Steel Wires		
336.4	14	1	0.63	8600
405.1	14	1	0.68	10200
477.0	18	7	0.78	17200
477.0	18	7	0.79	19400
556.5	18	7	0.84	20000
556.5	20	7	0.85	22600
565.3	20	7	0.86	22900
571.7	18	7	0.85	20600
636.0	27	1	0.85	13500
636.0	18	7	0.89	22900
636.0	20	7	0.91	25400
664.8	20	7	0.93	26600
666.6	20	7	0.91	24000
762.8	20	7	0.99	30500
768.2	20	7	0.98	27700
768.9	27	1	0.93	16400
795.0	17	7	0.96	21000
795.0	18	7	0.98	25900
795.0	20	7	0.99	28200
795.0	20	7	1.01	31800
946.7	35	7	1.08	29600
954.0	30	7	1.05	23700

Conductor Size kcmil	Stranding		Nominal Diameter (inches)	Rated Strength (pounds)
	No. Aluminum Wires	No. Steel Wires		
954.0	32	7	1.06	25900
954.0	20	7	1.08	33500
957.2	32	7	1.06	26000
959.6	22	7	1.11	37000
966.2	21	7	1.09	34000
1033.5	30	7	1.09	25700
1033.5	32	7	1.10	28100
1033.5	21	7	1.13	36300
1113.0	30	7	1.13	27500
1113.0	33	7	1.14	30000
1113.0	38	19	1.19	39100
1158.0	33	7	1.17	31600
1158.4	25	7	1.20	39600
1168.1	30	7	1.16	28900
1192.5	30	7	1.17	29500
1192.5	33	7	1.18	32400
1192.5	38	19	1.22	41900
1233.6	38	19	1.25	42900
1257.1	35	7	1.21	34200
1272.0	30	7	1.20	31400
1272.0	35	7	1.22	34600
1272.0	39	19	1.26	44100

CABLE DATA (continued)

ACSR/TW (TRAP WIRE) Continued

Conductor Size kcmil	Stranding		Nominal Diameter (inches)	Rated Strength (pounds)
	No. Aluminum Wires	No. Steel Wires		
1334.6	39	19	1.29	46300
1351.5	35	7	1.26	36700
1351.4	39	19	1.30	46800
1359.7	36	7	1.26	36900
1372.5	30	7	1.25	33400
1431.0	36	7	1.29	38900
1431.0	39	19	1.34	49600
1433.6	39	19	1.34	49700
1455.3	36	7	1.30	39200
1467.8	33	7	1.29	35800
1533.3	39	19	1.38	53200
1557.4	36	7	1.35	41900
1569.0	33	7	1.33	38200

Conductor Size kcmil	Stranding		Nominal Diameter (inches)	Rated Strength (pounds)
	No. Aluminum Wires	No. Steel Wires		
1590.0	36	7	1.36	42200
1590.0	42	19	1.41	55100
1622.0	39	19	1.42	57500
1657.4	36	7	1.39	44000
1730.6	39	19	1.47	59400
1758.6	37	19	1.47	34600
1780.0	37	19	1.45	50700
1926.9	42	19	1.55	65300
1949.6	42	7	1.50	51900
2153.8	64	19	1.60	61100
2156.0	64	19	1.61	61100
2627.3	64	19	1.76	74500

AAC/TW (ALL ALUMINUM TRAP WIRE) (ASTM B778)

Conductor Size kcmil	Nominal Diameter (inches)	Number of Wires	Rated Strength (pounds)
336.4	0.612	17	6220
397.5	0.661	17	7230
477.0	0.720	17	8530
500.0	0.736	17	8940
556.5	0.775	17	9950
600.0	0.803	17	10700
636.0	0.825	17	11400
700.0	0.864	17	12500
750.0	0.893	17	13400
795.0	0.919	17	13900
900.0	0.990	31	15800
954.0	1.018	31	16700
1000.0	1.041	31	17500
1033.5	1.057	31	18100
1113.0	1.095	31	19500
1192.5	1.132	31	20900
1272.0	1.168	31	22300
1351.5	1.202	31	23700
1431.0	1.236	31	24600
1590.0	1.315	49	27300
1750.0	1.377	49	30000
2000.0	1.468	49	34300

CABLE DATA (continued)

ACAR CABLE (ASTM B524)

Conductor Size		Number of Wires	Nominal Outside Diameter (inches)
kcmil	AWG		
2000		91	1.630
2000		61	1.630
1900		61	1.588
1800		61	1.546
1750		61	1.525
1700		61	1.502
1600		61	1.458
1500		61	1.411
1400		61	1.364
1300		61	1.314
1300		37	1.312
1250		61	1.288
1250		37	1.287
1200		61	1.263
1200		37	1.261
1100		61	1.209
1100		37	1.207
1000		61	1.152
1000		37	1.151
950		37	1.121
900		37	1.092
850		37	1.061
800		37	1.029
750		37	0.997
700		37	0.962
650		37	0.928
600		37	0.891
600		19	0.888
550		37	0.853
550		19	0.850
500		37	0.813
500		19	0.811
450		19	0.770
400		19	0.726
350		19	0.678
300		19	0.628
250		19	0.574
246.9		7	0.563

Conductor Size		Number of Wires	Nominal Outside Diameter (inches)
kcmil	AWG		
	4/0	7	0.522
195.7		7	0.502
	3/0	7	0.464
155.4		7	0.447
	2/0	7	0.414
123.3		7	0.398
	1/0	7	0.368
77.4		7	0.316
	2	7	0.292
48.6		7	0.250
	4	7	0.232
30.5		7	0.198

SSAC CABLE

Size AWG or kcmil	# Alum Strands	# Steel Strands	Conductor Diameter	Rated Strength (pounds)
266.8	22	7	.622	6030
266.8	24	7	.633	7410
266.8	26	7	.642	8880
266.8	30	7	.660	11700
300.0	26	7	.680	9970
336.4	20	7	.692	5990
336.4	22	7	.701	7610
336.4	24	7	.710	9340
336.4	26	7	.720	11200
336.4	30	7	.741	14800
397.5	20	7	.752	7090
397.5	22	7	.762	8990
397.5	24	7	.772	11000
397.5	26	7	.783	13000
397.5	30	7	.806	17500
477.0	20	7	.823	8490
477.0	22	7	.834	10800
477.0	24	7	.846	13000
477.0	26	7	.858	15600
477.0	30	7	.883	21000
500.0	30	7	.904	22000

CABLE DATA (continued)

SSAC CABLE (Continued)

Size AWG or kcmil	# Alum Strands	# Steel Strands	Conductor Diameter	Rated Strength (pounds)
556.5	20	7	.890	9910
556.5	22	7	.901	12600
556.5	24	7	.914	15200
556.5	26	7	.927	18200
556.5	30	7	.953	24500
605.0	24	7	.953	16500
605.0	26	7	.966	19700
605.0	30	7	.994	26000
605.0	30	19	.994	26600
636.0	20	7	.951	11300
636.0	22	7	.963	14100
636.0	24	7	.977	17300
636.0	26	7	.990	20700
636.0	30	7	1.019	27400
636.0	30	19	1.019	28000
666.6	24	7	1.000	18200
666.6	26	7	1.104	21700
715.5	24	7	1.036	19500
715.5	26	7	1.051	23300
715.5	30	19	1.081	30800
795.0	42	7	1.055	11800
795.0	20	7	1.063	14200
795.0	45	7	1.063	14200
795.0	22	7	1.077	17700
795.0	24	7	1.092	21700
795.0	54	7	1.092	21700
795.0	26	7	1.108	25900
795.0	30	19	1.140	34300
900.0	45	7	1.131	15800
900.0	54	7	1.162	24600
954.0	42	7	1.155	14200
954.0	20	7	1.185	16700
954.0	45	7	1.165	16700
954.0	48	7	1.175	19700
954.0	24	7	1.196	26000
954.0	54	7	1.196	26000
954.0	30	19	1.248	41100
1033.5	42	7	1.203	15400

Size AWG or kcmil	# Alum Strands	# Steel Strands	Conductor Diameter	Rated Strength (pounds)
1033.5	45	7	1.212	18100
1033.5	48	7	1.222	21300
1033.5	54	7	1.245	28200
1113.0	42	7	1.248	16300
1113.0	45	7	1.259	19500
1113.0	48	7	1.269	23000
1113.0	54	19	1.293	30400
1192.5	42	7	1.292	17500
1192.5	45	7	1.302	20900
1192.5	48	7	1.313	24600
1192.5	54	19	1.338	32600
1272.0	42	7	1.334	18700
1272.0	45	7	1.345	22300
1272.0	48	7	1.357	26200
1272.0	54	19	1.382	34100
1351.5	42	7	1.376	19900
1351.5	45	7	1.386	23700
1351.5	48	7	1.398	27900
1351.5	54	19	1.424	36200
1431.0	42	7	1.415	21000
1431.0	45	7	1.427	25100
1431.0	48	7	1.439	29500
1431.0	54	19	1.465	38400
1510.5	45	7	1.466	26500
1510.5	54	19	1.505	40500
1590.0	42	7	1.492	23400
1590.0	45	7	1.504	27900
1590.0	48	7	1.517	32200
1590.0	54	19	1.545	42600
1780.0	84	19	1.602	35400
1869.0	68	7	1.603	21500
2034.5	72	7	1.681	27200

CABLE DATA (continued)

SOLID COPPERWELD CABLE (ASTM B227)

Conductor Size (AWG)	Nominal Diameter (inches)	Circular Mils	Minimum Breaking Load (pounds)			
			Grade 40 HS	Grade 40 EHS	Grade 30 HS	Grade 30 EHS
4	0.2043	41740	3540	-	3934	4671
5	0.1819	33090	2937	-	3249	3911
-	0.1650*	27230	2779	-	2779	3367
6	0.1620	26240	2679	-	2679	3246
7	0.1443	20820	2207	-	2207	2681
8	0.1285	16510	1816	-	1816	2205
-	0.1280*	16380	1802	-	1802	2188
9	0.1144	13090	1491	-	1491	1790
-	0.1040*	10820	1283	1325	1283	1487
10	0.1019	10380	1231	-	1231	1460
12	0.0808	6530	774	-	774	918
-	0.0800*	6400	759	-	759	900
-	0.0640*	4096	485	-	485	576
18	0.0403	1624	193	-	193	228
-	0.0390*	1521	180	-	180	214
20	0.0320	1024	121	-	121	144

* These diameters are often employed by purchasers for communication lines BUT are not in the American Wire Gauge (B&S Wire Gauge) series, as are the other diameter listed.

STRANDED COPPERWELD CABLE (ASTM B228)

Nominal Diameter† (inch) Size AWG‡	Circular Mils	Diameter* (inch)	Breaking Load (pounds)**		
			High Strength		Extra High Strength
			40% Cond.	30% Cond.	30% Cond.
7/8 (19 No. 5)	628900	.910	50240	55570	66910
13/16 (19 No. 6)	498800	.810	41600	45830	55530
23/32 (19 No. 7)	395500	.721	34390	37740	45850
27/32 (19 No. 8)	313700	.642	28380	31040	37690
9/16 (19 No. 9)	248800	.572	23390	25500	30610
5/8 (7 No. 4)	292200	.613	22310	24780	29430
9/16 (7 No. 5)	231700	.546	18510	20470	24650
1/2 (7 No. 6)	183800	.486	15330	16890	20460
7/16 (7 No. 7)	145700	.433	12670	13910	16890
3/8 (7 No. 8)	115600	.385	10460	11440	13890
11/32 (7 No. 9)	91650	.343	8616	9393	11280
5/16 (7 No. 10)	72680	.306	7121	7758	9196
3 No. 5	99310	.392	8373	9262	11860
3 No. 6	78750	.349	6934	7639	9754
3 No. 7	62450	.311	5732	6291	7922
3 No. 8	49530	.277	4730	5174	6282
3 No. 9	39280	.247	3898	4250	5129
3 No. 10	31150	.220	3221	3509	4160
3 No. 12	19590	.174	2236	-	-

† The designation "inch" is the approximate diameter in proper fraction of an inch.
 ‡ The designation AWG is a combination of the number of wires each of the American Wire Gauge size indicated by "No."
 * Diameter of circumscribing.
 ** Breaking loads of 7-wire and 19-wire conductors are taken as 90% of the sum of the breaking loads of individual wires; breaking load of 3-wire conductors is taken as 95% of the sum of the breaking loads of the individual wires.

CABLE DATA (continued)

COPPERWELD-COPPER CABLE (ASTM B229)

Conductor size Hard Drawn Copper Equivalent			Nom. Dia. of Conductor (inches)	Min. Breaking Load (pounds)
cmil	AWG	Type		
350000	-	E	0.788	32420
350000	-	EK	0.735	23850
350000	-	V	0.754	23480
300000	-	E	0.729	27770
300000	-	EK	0.680	20960
300000	211600	V	0.698	20730
250000	-	E	0.666	23920
250000	-	EK	0.621	17840
250000	-	V	0.637	17420
	4/0	E	0.613	20730
211600	4/0	G	0.583	15640
211600	4/0	EK	0.571	15370
211600	4/0	V	0.586	15000
211600	4/0	F	0.550	12290
167800	3/0	E	0.545	16800
167800	3/0	J	0.555	16170
167800	3/0	G	0.519	12860
167800	3/0	EK	0.509	12370
167800	3/0	V	0.522	12200
167800	3/0	F	0.490	9980
133100	2/0	K	0.534	17600
133100	2/0	J	0.494	13430
133100	2/0	G	0.463	10510
133100	2/0	V	0.465	9846
133100	2/0	F	0.436	8094
105600	1/0	K	0.475	14490
105600	1/0	J	0.440	10970
105600	1/0	G	0.412	8563
105600	1/0	F	0.388	6536
83690	1	N	0.464	15410
83690	1	K	0.423	11900
83690	1	J	0.392	9000
83690	1	G	0.367	6956
83690	1	F	0.346	5266
66360	2	P	0.462	16870
66360	2	N	0.413	12680
66360	2	K	0.377	9730
66360	2	J	0.349	7322
66360	2	A	0.366	5876
66360	2	G	0.327	5626
66360	2	F	0.308	4233
55620	3	P	0.411	13910
52620	3	N	0.368	10390

Conductor size Hard Drawn Copper Equivalent			Nom. Dia. of Conductor (inches)	Min. Breaking Load (pounds)
cmil	AWG	Type		
52620	3	K	0.336	7910
52620	3	J	0.311	5955
52620	3	A	0.326	4810
41740	4	P	0.366	11420
41740	4	N	0.328	8460
41740	4	D	0.348	7340
41740	4	A	0.290	3938
33090	5	P	0.326	9311
33090	5	D	0.310	6035
33090	5	A	0.258	3193
26240	6	D	0.276	4942
26240	6	A	0.230	2585
26240	6	C	0.225	2143
20820	7	D	0.246	4022
20820	7	A	0.223	2754
16510	8	D	0.219	3256
16510	8	A	0.199	2233
16510	8	C	0.179	1362
11750	9	D	0.174	1743

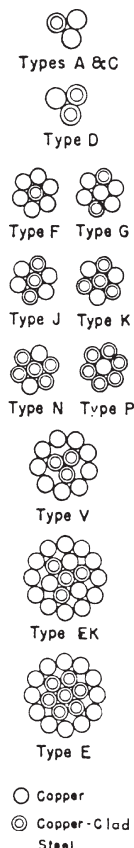

CABLE DATA (continued)

GALVANIZED STEEL CABLE (ASTM A475)

inches	Nom. Dia. of Strand (mm)	Number of Wires in Strand	Minimum Breaking Load (pounds)				
			Utilities Grade	Common Grade	Siemens-Martin Grade	High-Strength Grade	Extra High-Strength Grade
1/8	3.18	7	-	540	910	1330	1830
5/32	3.97	7	-	870	1470	2140	2940
3/16	4.76	7	-	1150	1900	2850	3990
3/16	4.76	7	2400	-	-	-	-
7/32	5.56	3	-	1400	2340	3500	4900
7/32	5.56	7	-	1540	2560	3850	5400
1/4	6.35	3	3150	1860	3040	4730	6740
1/4	6.35	3	4500	-	-	-	-
1/4	6.35	7	-	1900	3150	4750	6650
9/32	7.14	3	-	2080	3380	5260	7500
9/32	7.14	7	4600	2570	4250	6400	8950
5/16	7.94	3	6500	2490	4090	6350	9100
5/16	7.94	7	-	3200	5350	8000	11200
5/16	7.94	7	6000	-	-	-	-
3/8	9.52	3	8500	3330	5560	8360	11800
3/8	9.52	7	11500	4250	6950	10800	15400
7/16	11.11	7	18000	5700	9350	14500	20800
1/2	12.70	7	25000	7400	12100	18800	26900
1/2	12.70	19	-	7620	12700	19100	26700
9/16	14.29	7	-	9600	15700	24500	35000
9/16	14.29	19	-	9640	16100	24100	33700
5/8	15.88	7	-	11600	19100	29600	42400
5/8	15.88	19	-	11000	18100	28100	40200
3/4	19.05	19	-	16000	26200	40800	58300
7/8	22.22	19	-	21900	35900	55800	79700
1	25.40	9	-	28700	47000	73200	104500
1	25.40	37	-	28300	46200	71900	102700
1-1/8	28.58	37	-	36000	58900	91600	130800
1-1/4	31.75	37	-	44600	73000	113600	162200





















CABLE DATA (continued)

ALUMINUM-COATED STEEL CABLE (ASTM A474)

Nom. Dia. of Strand (inches)	Number of Wires in Strand	Minimum Breaking Strength (pounds)				
		Utilities Grade*	Common Grade	Siemens-Martin Grade	High-Strength Grade	Extra High-Strength Grade
3/16	7		1150	1900	2850	
3/16	7	2400				
1/4	3	3150				
1/4	3	4500				
1/4	7		1900	3150	4750	6650
9/32	7	4600				
5/16	3	6500				
5/16	7		3200	5350	8000	11200
5/16	7	6000				
3/8	3	8500				
3/8	7	11500	4250	6950	10800	15400
7/16	7	18000	5350	9350	14500	20800
1/2	7	25000	7400	12100	18800	26900

* The Utilities Grade is used principally by communications and power and light industries.

TERMINAL STUD SIZE CHART*

STUD SIZE	#0	#1	#2	#3	#4	#5	#6	#8	#10	#12	#14	1/4"	5/16"	3/8"
Stud Diameter	.060	.073	.086	.090	.112	.125	.138	.164	.190	.216	.242	.250	.312	.375
														
Stud Hole	.067	.093	.119			.145	.171	.197	.223	.250	17/64	21/64	25/64	
STUD SIZE	7/16"		1/2"		5/8"		3/4"		7/8"		1"			
Stud Diameter	.437		.500		.625		.750		.875		1.000			
														
Stud Hole	29/64		33/64		21/32		29/32		29/32		1 - 1/32			

*Tolerance .003" on decimal and .005" on fractional dimensions

AWG VS. METRIC WIRE SIZES

Circ. Mils	Equivalent Circ. Mils	AWG Size	Metric Wire Size (mm)	Number of Strands	Wire Dia. per Strand		Approx. Overall Diameter	
					inches	mm	inches	mm
-	937	-	.50	1	.032	.813	.032	.81
1020	-	20	-	7	.0121	.307	.036	.91
-	1480	-	.75	1	.039	.091	.039	.99
1620	-	18	-	1	.0103	1.02	.040	1.02
1620	-	18	-	7	.0152	.386	.046	1.16
-	1974	-	1.0	1	.045	1.14	.045	1.14
-	1974	-	1.0	7	.017	.422	.061	1.30
2580	-	16	-	1	.0503	1.29	.051	1.29
2580	-	16	-	7	.0192	.468	.058	1.46
-	2960	-	1.5	1	.055	1.40	.055	1.40
-	2960	-	1.5	7	.021	5.33	.063	1.60
4110	-	14	-	1	.0641	1.63	.064	1.63
4110	-	14	-	7	.0242	.615	.073	1.84
-	4934	-	2.5	1	.071	1.80	.071	1.80
-	4934	-	2.5	7	.027	6.66	.081	2.06
6530	-	12	-	1	.0308	2.05	.081	2.05
6530	-	12	-	7	.0305	.775	.092	2.32
-	7894	-	4	1	.089	2.26	.089	2.26
-	7894	-	4	7	.034	.864	.102	2.59
10380	-	10	-	1	.1019	2.59	.102	2.59
10380	-	10	-	7	.0355	.978	.116	2.93
-	11840	-	6	1	.109	2.77	.109	2.77
-	11840	-	6	7	.042	.107	.126	3.21
13000	-	9	-	1	.1144	2.91	.114	2.91
13090	-	9	-	7	.0432	1.10	.130	3.30
16510	-	8	-	1	.1285	3.26	.128	3.25
16510	-	8	-	7	.0486	1.23	.146	3.70
-	19740	-	10	1	.141	3.58	.141	3.58
-	19740	-	10	7	.054	1.37	.162	4.12
20520	-	7	-	1	.1443	3.67	.144	3.67
20520	-	7	-	7	.0545	1.38	.164	4.15
26240	-	6	-	1	.162	4.11	.162	4.11
26240	-	6	-	7	.0612	1.55	.184	4.66
-	31580	-	16	7	.008	1.73	.204	5.13
33090	-	5	-	7	.0688	1.75	.206	5.24
41740	-	4	-	7	.0772	1.96	.232	5.88
-	49340	-	25	7	.085	2.16	.255	6.48
-	49340	-	25	19	.052	1.32	.260	6.60
52620	-	3	-	7	.0867	2.20	.260	6.61
66300	-	2	-	7	.0974	2.47	.292	7.42
-	69070	-	35	7	.100	2.54	.300	7.62
-	69070	-	35	19	.001	1.55	.305	7.75

AWG VS. METRIC WIRE SIZES (continued)

Circ. Mils	Equivalent Circ. Mils	AWG Size	Metric Wire Size (mm)	Number of Strands	Wire Dia. per Strand		Approx. Overall Diameter	
					inches	mm	inches	mm
83690	-	1	-	19	.0064	1.50	.332	8.43
-	98680	-	50	19	.073	1.85	.365	9.27
105000	-	1/0	-	19	.0745	1.59	.373	9.46
133100	-	2/0	-	19	.0837	2.13	.419	10.6
-	138100	-	70	19	.086	2.18	.430	10.9
167800	-	3/0	-	19	.094	2.59	.470	11.9
167800	-	3/0	-	36	.0673	1.71	.471	12.0
-	187500	-	95	19	.101	2.57	.505	12.8
-	187500	-	95	37	.072	1.83	.504	12.5
211600	-	4/0	-	19	.1055	2.89	.528	13.4
-	237.8 kcmil	-	120	37	.081	2.06	.567	14.4
250 kcmil	-	-	-	37	.0822	2.07	.575	14.6
300 kcmil	-	-	150	37	.090	2.29	.630	16.0
350 kcmil	-	-	-	37	.0973	2.47	.681	17.3
-	365.1 kcmil	-	185	37	.100	2.54	.700	17.8
400 kcmil	-	-	-	37	.104	2.64	.728	18.5
-	473.6 kcmil	-	240	37	.114	2.90	.798	20.3
-	473.6 kcmil	-	240	61	.089	2.26	.801	20.3
500 kcmil	-	-	-	37	.1162	2.95	.813	20.7
500 kcmil	-	-	-	61	.0905	2.30	.814	20.7
-	592.1 kcmil	-	300	61	.099	2.51	.891	22.6
600 kcmil	-	-	-	61	.0992	2.52	.893	22.7
700 kcmil	-	-	-	61	.1071	2.72	.964	24.5
750 kcmil	-	-	-	6	.1109	2.82	.998	25.4
750 kcmil	-	-	-	91	.0908	2.31	.998	25.4
-	789.4 kcmil	-	400	61	.114	2.90	1.026	26.1
800 kcmil	-	-	-	61	.1145	2.91	1.031	26.2
800 kcmil	-	-	-	91	.0938	2.38	1.032	26.2
1000 kcmil	986.8 kcmil	-	500	61	.1280	3.25	1.152	28.3
1000 kcmil	-	-	-	91	.1048	2.66	1.153	29.3
-	1233.7 kcmil	-	625	91	.117	2.97	1.287	32.7
1250 kcmil	-	-	-	91	.1172	2.93	1.289	32.7
1250 kcmil	-	-	-	127	.0992	2.52	1.200	32.8
1500 kcmil	-	-	-	91	.1284	3.26	1.412	36.9
1500 kcmil	-	-	-	127	.1087	2.76	1.413	36.9
-	1578.8 kcmil	-	800	91	.132	3.35	1.452	36.9
-	1973.5 kcmil	-	1000	91	.147	3.73	1.617	41.1
2000 kcmil	-	-	-	127	.1255	3.19	1.632	41.5
2000 kcmil	-	-	-	169	.1088	2.76	1.632	41.5

INCHES & MILLIMETERS CONVERSION CHART

INCHES		MM	INCHES		MM	MM	INCHES	MM	INCHES
$\frac{1}{64}$.015625	0.397	$\frac{33}{64}$.515625	13.097	.1	.0039	46	1.8110
$\frac{1}{32}$.03125	0.794	$\frac{17}{32}$.53125	13.494	.2	.0079	47	1.8504
$\frac{3}{64}$.046875	1.191	$\frac{35}{64}$.546875	13.891	.3	.0118	48	1.8898
$\frac{1}{16}$.0625	1.588	$\frac{9}{16}$.5625	14.288	.4	.0157	48	1.9291
$\frac{5}{64}$.078125	1.984	$\frac{37}{64}$.578125	14.684	.5	.0197	50	1.9685
$\frac{3}{32}$.09375	2.381	$\frac{19}{32}$.59375	15.081	.6	.0236	51	2.0079
$\frac{7}{64}$.109375	2.778	$\frac{39}{64}$.609375	15.478	.7	.0276	52	2.0472
$\frac{1}{8}$.1250	3.175	$\frac{5}{8}$.6250	15.875	.8	.0315	53	2.0866
$\frac{9}{64}$.140625	3.572	$\frac{41}{64}$.640625	16.272	.9	.0354	54	2.1260
$\frac{5}{32}$.15625	3.969	$\frac{21}{32}$.65625	16.669	1	.0394	55	2.1654
$\frac{11}{64}$.171875	4.366	$\frac{43}{64}$.671875	17.066	2	.0787	56	2.2047
$\frac{3}{16}$.1875	4.763	$\frac{11}{16}$.6875	17.463	3	.1181	57	2.2441
$\frac{13}{64}$.203125	5.159	$\frac{45}{64}$.703125	17.859	4	.1575	58	2.2835
$\frac{7}{32}$.21875	5.556	$\frac{23}{32}$.71875	18.256	5	.1969	59	2.3228
$\frac{15}{64}$.234375	5.953	$\frac{47}{64}$.734375	18.653	6	.2362	60	2.3622
$\frac{1}{4}$.2500	6.350	$\frac{3}{4}$.7500	19.050	7	.2756	61	2.4016
$\frac{17}{64}$.265625	6.747	$\frac{49}{64}$.765625	19.447	8	.3150	62	2.4409
$\frac{9}{32}$.28125	7.144	$\frac{25}{32}$.78125	19.844	9	.3543	63	2.4803
$\frac{19}{64}$.296875	7.541	$\frac{51}{64}$.796875	20.241	10	.3937	64	2.5197
$\frac{5}{16}$.3125	7.938	$\frac{13}{16}$.8125	20.638	11	.4331	65	2.5591
$\frac{21}{64}$.328125	8.334	$\frac{45}{64}$.828125	21.034	12	.4724	66	2.5984
$\frac{11}{32}$.34375	8.731	$\frac{27}{32}$.84375	21.431	13	.5118	67	2.6378
$\frac{23}{64}$.359375	9.128	$\frac{55}{64}$.859375	21.828	14	.5512	68	2.6772
$\frac{3}{8}$.3750	9.525	$\frac{7}{8}$.8750	22.225	15	.5906	69	2.7165
$\frac{25}{64}$.390625	9.922	$\frac{57}{64}$.890625	22.622	16	.6299	70	2.7559
$\frac{13}{32}$.40625	10.319	$\frac{29}{32}$.90625	23.019	17	.6693	71	2.7953
$\frac{27}{64}$.421875	10.716	$\frac{59}{64}$.921875	23.416	18	.7087	72	2.8346
$\frac{7}{16}$.4375	11.113	$\frac{15}{16}$.9375	23.813	19	.7480	73	2.8740
$\frac{29}{64}$.453125	11.509	$\frac{61}{64}$.953125	24.209	20	.7874	74	2.9134
$\frac{15}{32}$.46875	11.906	$\frac{31}{32}$.96875	24.606	21	.8268	75	2.9528
$\frac{31}{64}$.484375	12.303	$\frac{63}{64}$.984375	25.003	22	.8661	76	2.9921
$\frac{1}{2}$.5000	12.700	1	1.000	25.400	23	.9055	77	3.0315
						24	.9449	78	3.0709
						25	.9843	79	3.1102
						26	1.0236	80	3.1496
						27	1.0630	81	3.1890
						28	1.1024	82	3.2283
						29	1.1417	83	3.2677
						30	1.1811	84	3.3071
						31	1.2205	85	3.3465
						32	1.2598	86	3.3858
						33	1.2992	87	3.4252
						34	1.3386	88	3.4646
						35	1.3780	89	3.5039
						36	1.4173	90	3.5433
						37	1.4567	91	3.5827
						38	1.4961	92	3.6220
						39	1.5354	93	3.6614
						40	1.5748	94	3.7008
						41	1.6142	95	3.7402
						42	1.6535	96	3.7795
						43	1.6929	97	3.8189
						44	1.7323	98	3.8583
						45	1.7717	99	3.8976
								100	3.9370

BURNDY CONDUCTOR NUMBERING SYSTEM - © BURNDY ENGINEERING CO., INC., 1940

Outside Dia. IN	Outside Dia. MM	STR. CABLE		SOL. WIRE		AREA MM ² Copper Cable	ACSR		PIPE SIZE CONDUCTOR				TUBE & ROD		SERVIT NO.	
		Cat. No.	Size	Cat. No.	Size		Cat. No.	Cable Size	Cat. No.	ST D	Cat No.	Ex Hvy	Cat. No.	Dia.		
.102	2.594			10W	10	5.261										KS90
.114	2.896			9W	9	6.634										
.116	2.946	10 C	10			5.261										
.125	3.175												60	1/8		
.129	3.277			8W	8	8.366										KS15
.130	3.302	9 C	9			6.634										
.144	3.658			7W	7	10.550										
.146	3.708	8 C	8			8.366										
.158	4.013						8R	8								
.162	4.115			6W	6	13.300										KS17
.164	4.166	7 C	7			10.550										
.176	4.470						7R	7								
.182	4.597			5W	5	16.770										
.184	4.648	6 C	6			13.300										
.198	5.029						6R	6								
.204	5.182			4W	4	21.150										KS20
.206	5.258	5 C	5			16.770										
.223	5.664						5R	5								
.229	5.817			3W	3	26.670										
.232	5.867	4 C	4			21.150										
.250	6.350						4R	4					61	1/4		
.258	6.553			2W	2	33.630										KS22
.260	6.629	3 C	3			2.6670										
.281	7.137						3R	3								
.289	7.344			1W	1	42.410										
.292	7.394	2 C	2			33.630										KS23
.316	8.026						2R	2								
.325	8.255			75	1/0	53.480										
.332	8.382	1 C	1			42.410										
.355	9.017						1R	1								
.365	9.274			76	2/0	67.430										
.372	9.474	25	1/0			53.480										KS25
.375	9.525												62	3/8		
.398	10.109						25R	1/0								
.405	10.287								10	1/8	50	1/8				
.410	10.414			77	3/0	85.030										
.419	10.617	26	2/0			67.430										KS26
.447	11.354						26R	2/0								
.460	11.684			78	4/0	107.200										
.470	11.938	27	3/0			85.030										
.500	12.700												63	1/2		
.502	12.725						27R	3/0								
.528	13.414	28	4/0			107.200										KS28
.540	13.716								11	1/4	51	1/4				
.563	14.326						28R	4/0								
.575	14.605	29	250			127.000										
.630	16.002	30	300			152.000										
.633	16.078						29R	266.800								
.642	16.307						30R	266.800								
.675	17.145								12	3/8	52	3/8				
.680	17.272						31R	300.000								
.681	17.297	31	350			177.000										KS31
.721	18.313						32R	336.400								
.728	18.494	32	400			203.000										
.741	18.824						33R	336.400								
.750	19.050												64	3/4		
.772	19.609	33	450			228.000										
.783	19.888						34R	397.500								
.806	20.472						35R	397.500								
.813	20.676	34	500			253.000										
.840	21.336								13	1/2	53	1/2				
.855	21.717	35	550			279.000										KS34
.858	21.742						36R	477.000								
.883	22.428						37R	477.000								
.893	22.682	36	600			304.000										
.904	22.962						38R	500.000								
.927	23.546						39R	556.500								
.929	23.597	37	650			329.000										
.953	24.206						40R	556.500								
.953	24.206						41R	605.000								
.964	24.486	38	700			355.000										
.977	24.714						42R	636.000								
.998	25.349	39	750			380.000										KS39
1.000	25.400						43R	666.600					65	1		

BURNDY CONDUCTOR NUMBERING SYSTEM (continued)

Outside Dia. IN	Outside Dia. MM	STR. CABLE		SOL. WIRE		AREA MM ² Copper Cable	ACSR		PIPE SIZE CONDUCTOR				TUBE & ROD		SERVIT NO.	
		Cat. No.	Size	Cat. No.	Size		Cat. No.	Cable Size	Cat. No.	ST D	Cat No.	Ex Hvy	Cat. No.	Dia.		
1.031	26.187	40	800			405.000										
1.036	26.314						44R	715,500								
1.050	26.670								14		54					
1.062	26.975	41	850			431.000										
1.094	27.762	42	900			456.000	45R	795,000								
1.123	28.524	43	950			481.000										
1.146	29.108						46R	874,000								
1.152	29.264	44	1000			507.000										KS44
1.162	29.515						47R	900,000								
1.196	30.378						48R	954,000								
1.209	30.709	444	1100			557.000										
1.246	31.648						49R	1,033,500								
1.250	31.750												66	1		
1.263	32.080	448	1200			608.000										
1.289	32.744	45	1250			633.000										
1.293	32.817						50R	1,113,000								
1.315	33.404	452	1300						15	1	55	1				
1.338	33.960						51R	1,192,500								
1.364	34.646	456	1400			709.000										
1.382	35.103						52R	1,272,000								
1.412	35.865	46	1500			760.000										
1.424	36.170						53R	1,351,500								
1.459	37.059	464	1600			811.000										
1.465	37.214						54R	1,431,000								
1.500	38.100												67	1-1/2		
1.504	38.202	468	1700			861.000										
1.506	38.252						55R	1,510,500								
1.526	38.786	47	1750			866.000										
1.545	39.218						56R	1,590,000								
1.548	39.319	472	1800			912.000										
1.590	40.386	476	1900			963.000										
1.632	41.427	48	2000			1013.000										
1.660	42.164								16	1	56	1				
1.729	43.917	483	2250			1140.000										
1.824	46.330	486	2500			1267.000										
1.900	48.260								17	1-1/2	57	1-1/2				
1.914	48.616	490	2750			1393.000										
1.988	50.495	493	3000			1520.000										
2.000	50.800												68	2		
2.375	60.325								18	2	58	2				
2.500	63.500												69	2-1/2		
2.875	73.025								19	2-1/2	59	2-1/2				
3.000	76.200												70	3		
3.500	88.900								20	3	90	3	71	3-1/2		
4.000	101.600								21	3-1/2	91	3-1/2	72	4		
4.500	114.300								22	4	92	4	73	4-1/2		
5.000	127.000								23	4-1/2	93	4-1/2	74	5		
5.563	141.300								24	5	94	5				
6.063	154.000								85	5-1/2	95	5-1/2				
6.625	168.275								86	6	96	6				
7.625	193.675								87	7	97	7				
8.625	219.075								88	8	98	8				

PRESENT INSTALLATION TOOL INDEX

This chart provides a cross-reference between die index numbers marked on BURNDY® COMPRESSION CONNECTORS and the CORRESPONDING DIE SETS used with the various BURNDY® INSTALLATION TOOLS. This is the only way to have a complete connections with the BURNDY® ENGINEERED SYSTEM.

A die index number has been assigned to each required groove configuration. A prefix letter is used to indicate the specific installation tool for which the die has been designed, as shown.

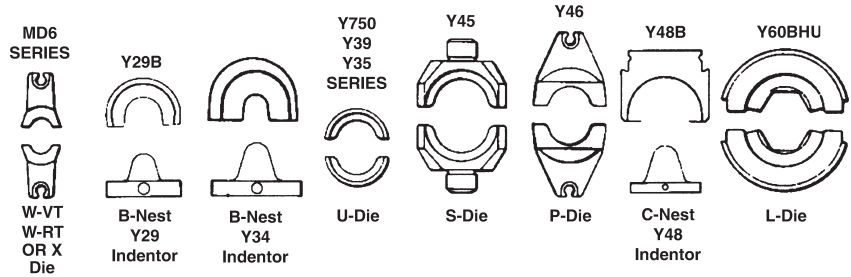

U	34	ART	USE CHART (CHART III)		
			WIRE SIZE (CHART II) OR INDEX		
			TOOL TYPE (CHART I)		
CHART I					
A - Y34A	E - Y44B	P - Y46	X - OUR840/MD-6		
B - Y34BH	F - Y486RB	S - Y45			
C - Y48B	G - Y34C	U - Y35			
	L - Y60B	W - MD-6/OUR840			
CHART II					
12 - #12	4C - #4	26 - 2/0	31 - 350 MCM	OR INDEX	
10 - #10	3C - #3	27 - 3/0	32 - 400 MCM	i.e., U312	
8C - # 8	2C - #2	28 - 4/0	34 - 500 MCM	312 Die Index	
6C - # 6	1C - #1	29 - 250 MCM	36 - 600 MCM		
5C - # 5	25 - 1/0	30 - 300 MCM	39 - 750 MCM		
			44 - 1000 MCM		
CHART III					
A - ALUMINUM					
B - INDENTOR NEST (USED WITH INDENTOR DIE # Y34P**)					
R - ROUND DIE (CIRCUMFERENTIAL)					
T - TWIN DIE (BOTH HALVES)					

PRESENT INSTALLATION TOOL INDEX (continued)

DIE		DIELESS TOOLS		INSTALLATION TOOLING USING DIES										
GROOVE		MECH.	HYD.	DIE INFORMATION		MECHANICAL			HYDRAULIC					
BURNDY	EEI	MR, MY	Y644	TYPE	COLOR	MD6	OUR840	Y29B ^⑤	Y35 ^①	Y39	Y750 ^①	Y45 ^②	Y46 ^③	Y60 Ser.
A				DIE SET					U-A	U-A	U-A	U-A	U-A	
BG				DIE SET		Perm. GR W-BG	X-BG X-NBG		U-BG	U-BG	U-BG	U-BG	U-BG	
C				DIE SET	BROWN	W-C			U-C	U-	U-C	U-C	U-C	
D				DIE SET					U-D	U-D	U-D	U-D	U-D	
D3				DIE SET	BLUE				U-YFD	U-YFD	U-YFD	U-YFD	U-YFD	
				DIE SET		Perm. GR			U-D3	U-D3	U-D3	U-D3	U-D3	
E				DIE SET					U-E	U-E	U-E	U-E	U-E	
F				DIE SET					U-F	U-F	U-F	U-F	U-F	
H				DIE SET					U-H	U-H	U-H	U-H	U-H	
K-1/4				DIE SET		WK14								
K-5/16				DIE SET		WK516			UK516T	UK526T	UK516T	UK516T	UK516T	
K-3/8				DIE SET		WK38			UK38T	UK38T	UK38T	UK38T	UK38T	
K-1/2				DIE SET		WK12								
K-9/16				DIE SET		WK916			UK916T	UK916T	UK916T	UK916T	UK916T	
K-19/32				DIE SET		WK1932								
K-5/8-1				DIE SET					UK581T	UK581T	UK581T	UK581T	UK581T	
K-11/16				DIE SET		WK1116			UK1116T	UK1116T	UK1116T	UK1116T	UK1116T	
K-3/4				DIE SET					UK34T	UK34T	UK34T	UK34T	UK34T	
K-1				DIE SET					UK1T	UK1T	UK1T	UK1T	UK1T	
K-1-5/16				DIE SET					UK1516T	UK1516T	UK1516T	UK1516T	UK1516T	
K-635				DIE SET		WK737			UK737T	UK737T	UK737T	UK737T	UK737T	
K-747				DIE SET		WK747								
K-781				DIE SET		WK781								
K-840				DIE SET		W-K840			U-K840	U-K840	U-K840	U-K840	U-K840	
KB				DIE SET		WKB			UKBT	UKBT	UKBT	UKBT	UKBT	
KBKT				DIE SET					UKBKTT	UKBKTT	UKBKTT	UKBKTT	UKBKTT	
KC				DIE SET					UKCT	UKCT	UKCT	UKCT	UKCT	
KK				DIE SET		WKK								
KR				DIE SET	YELLOW								P-YFR	
												S-KR	P-KR	
KT				DIE SET		WKT								
KU				DIE SET					UKUT	UKUT	UKUT	UKUT	UKUT	
L				DIE SET		W-L			U-L	U-L	U-L	U-L	U-L	
L80				DIE SET					U32XRT	U32XRT	U32XRT	U32XRT	U32XRT	
L99				DIE SET	PINK				U38XRT	U38XRT	U38XRT	U38XRT	U38XRT	
L115				DIE SET	YELLOW				U44XRT	U44XRT	U44XRT	U44XRT	U44XRT	
M				DIE SET					U-M	U-M	U-M	U-M	U-M	
N				DIE SET	RED				U-YFN	U-YFN	U-YFN	U-YFN	U-YFN	
									U-N	U-N	U-N	U-N	U-N	
O				DIE SET	GREEN				U-YFO	U-YFO	U-YFO	U-YFO	U-YFO	
						Perm. GR W-O			U-O	U-O	U-O	U-O	U-O	
Q				DIE SET		W-Q								

① Cat. No. Y35P3 Adaptor is required to use "Y34PR" type indentors with "U" type nest dies in Y35 and Y750 series.
 ② Cat. No. PT6515 Adaptor is required to use "U" type dies in Y45 series.

③ Cat. No. PUADP-1 Adaptor is required to use "U" type dies in Y46 series.
 ④ The MD6-6R2 ratchet tool is required on these sizes. The standard MD6 or MD6R ratchet tools will not work.

⑤ Also pneumatic version Y29NC.

PRESENT INSTALLATION TOOL INDEX (continued)

DIE		DIELESS TOOLS		INSTALLATION TOOLING USING DIES										
GROOVE		MECH.	HYD.	DIE INFORMATION			MECHANICAL		HYDRAULIC					
BURNDY	EEI	MR, MY	Y644	TYPE	COLOR	MD6	OUR840	Y29B ⑤	Y35 ①	Y39	Y750 ①	Y45 ②	Y46 ③	Y60 Ser.
R				DIE SET					U-R	U-R	U-R	U-R	U-R	
T				DIE SET								S-T		
Z				DIE SET								S-Z		
7 94		MR4C MY29-3 MY29-11	1 CRIMP	DIE SET	BLUE	W5CRT	X5CRT		U5CRT	U5CRT	U5CRT	U5CRT	U5CRT	
				NEST				D6CL	U6CD-1	U6CD-1	U6CD-1	U6CD-1	U6CD-1	
				INDENTOR				Y29PR	Y34PR	Y34PR	Y34PR	Y34PR	Y34PR	
8 95		MR4C MY29-3 MY29-11	1 CRIMP	DIE SET	GRAY	W4CRT	X4CRT		U4CRT	U4CRT	U4CRT	U4CRT	U4CRT	
				NEST				D4CL	U4CD-1	U4CD-1	U4CD-1	U4CD-1	U4CD-1	
				INDENTOR				Y29PR	Y34PR	Y34PR	Y34PR	Y34PR	Y34PR	
9 96		MY29-3 MY29-11	1 CRIMP	DIE SET	WHITE	W3CRT	X3CRT		U3CRT	U3CRT	U3CRT	U3CRT	U3CRT	
				NEST				D3CL	U3CD-1	U3CD-1	U3CD-1	U3CD-1	U3CD-1	
				INDENTOR				Y29PR	Y34PR	Y34PR	Y34PR	Y34PR	Y34PR	
10 97		MY29-3 MY29-11	1 CRIMP	DIE SET	BROWN	W2CRT	X2CRT		U2CRT	U2CRT	U2CRT	U2CRT	U2CRT	
				NEST				D2CL	U2CD-1	U2CD-1	U2CD-1	U2CD-1	U2CD-1	
				INDENTOR				Y29PR	Y34PR	Y34PR	Y34PR	Y34PR	Y34PR	
11 98		MY29-3 MY29-11	1 CRIMP	DIE SET	GREEN	W1CRT-1	X1CRT-1		U1CRT-1	U1CRT-1	U1CRT-1	U1CRT-1	U1CRT-1	
				NEST				D1CL	U1CD-1	U1CD-1	U1CD-1	U1CD-1	U1CD-1	
				INDENTOR				Y29PR	Y34PR	Y34PR	Y34PR	Y34PR	Y34PR	
12 99		MY29-3 MY29-11	1 CRIMP	DIE SET	PINK	W25RT	X25RT		U25RT	U25RT	U25RT	U25RT	U25RT	
				NEST				D25L	U25D-1	U25D-1	U25D-1	U25D-1	U25D-1	
				INDENTOR				Y29PR	Y34PR	Y34PR	Y34PR	Y34PR	Y34PR	
13 100		MY29-3 MY29-11	1 CRIMP	DIE SET	BLACK	W26RT	X26RT		U26RT	U26RT	U26RT	U26RT	U26RT	
				NEST				D26L	U26D-1	U26D-1	U26D-1	U26D-1	U26D-1	
				INDENTOR				Y29PR	Y34PR	Y34PR	Y34PR	Y34PR	Y34PR	
14 101		MY29-3 MY29-11	1 CRIMP	DIE SET	ORANGE	W27RT	X27RT		U27RT	U27RT	U27RT	U27RT	U27RT	
				NEST				D27L	U27D-1	U27D-1	U27D-1	U27D-1	U27D-1	
				INDENTOR				Y29PR	Y34PR	Y34PR	Y34PR	Y34PR	Y34PR	
15		MY29-3 MY29-11	1 CRIMP	DIE SET	PURPLE	W28RT	X28RT		U28RT	U28RT	U28RT	U28RT	U28RT	
				NEST				D28L	U28D-1	U28D-1	U28D-1	U28D-1	U28D-1	
				INDENTOR				Y29PR	Y34PR	Y34PR	Y34PR	Y34PR	Y34PR	
16		MY29-3 MY29-11	1 CRIMP	DIE SET	YELLOW	W29RT④	X29RT		U29RT	U29RT	U29RT	U29RT	U29RT	
				NEST				D29L		U29D-1	U29D-1	U29D-1	U29D-1	
				INDENTOR				Y29PR		Y34PR	Y34PR	Y34PR	Y34PR	
17			1 CRIMP	DIE SET	WHITE	W30RT④			U30RT	U30RT	U30RT	U30RT	U30RT	L30RT
				NEST						U30D-1	U30D-1	U30D-1	U30D-1	
				INDENTOR						Y34PR	Y34PR	Y34PR	Y34PR	
18			1 CRIMP	DIE SET	RED	W31RT④			U31RT	U31RT	U31RT	U31RT	U31RT	L31RT
				NEST						U31D-1	U31D-1	U31D-1	U31D-1	
				INDENTOR						Y34PR	Y34PR	Y34PR	Y34PR	
19			1 CRIMP	DIE SET	BLUE	W32RT④			U32RT	U32RT	U32RT	U32RT	U32RT	L32RT
				NEST						U32D-1	U32D-1	U32D-1	U32D-1	
				INDENTOR						Y34PR	Y34PR	Y34PR	Y34PR	

① Cat. No. Y35P3 Adaptor is required to use "Y34PR" type indentors with "U" type nest dies in Y35 and Y750 series.
 ② Cat. No. PT6515 Adaptor is required to use "U" type dies in Y45 series.

③ Cat. No. PUADP-1 Adaptor is required to use "U" type dies in Y46 series.
 ④ The MD6-6R2 ratchet tool is required on these sizes. The standard MD6 or MD6R ratchet tools will not work.

⑤ Also pneumatic version Y29NC.

PRESENT INSTALLATION TOOL INDEX (continued)

DIE		DIELESS TOOLS		INSTALLATION TOOLING USING DIES										
GROOVE		MECH.	HYD.	DIE INFORMATION		MECHANICAL			HYDRAULIC					
BURNDY	EEI	MR, MY	Y644	TYPE	COLOR	MD6	OUR840	Y29B ⑤	Y35 ①	Y39	Y750 ①	Y45 ②	Y46 ③	Y60 Ser.
20			1 CRIMP	DIE SET	BROWN	W34RT④			U34RT	U34RT	U34RT	U34RT	U34RT	L34RT
				NEST					U34D-1	U34D-1	U34D-1	U34D-1		
				INDENTOR					Y34PR	Y34PR	Y34PR	Y34PR		
21			1 CRIMP	DIE SET	YELLOW					U35RT	U35RT	U35RT	U35RT	
				NEST										
				INDENTOR										
22			1 CRIMP	DIE SET	GREEN					U36RT	U36RT	U36RT	U36RT	L36RT
				NEST									P36D	
				INDENTOR									P44PR	
23			1 CRIMP	DIE SET	ORANGE					U37RT	U37RT	U37RT	U37RT	
				NEST										
				INDENTOR										
24			1 CRIMP	DIE SET	BLACK					U39RT	U39RT	S39RT	P39RT	L39RT
				NEST									P39D	
				INDENTOR									P44PR	
25			1 CRIMP	DIE SET	ORANGE							S40RT	P40RT	
				NEST									P40D	
				INDENTOR									P44PR	
26			1 CRIMP	DIE SET	GOLD									
				NEST										
				INDENTOR										
27			1 CRIMP	DIE SET	WHITE							S44RT	P44RT	L44RT
				NEST									P44D	
				INDENTOR									P44PR	
29				DIE SET	YELLOW								P45RT	L45RT
				NEST										
				INDENTOR										
30				DIE SET	ORANGE									
				NEST										
				INDENTOR										
31				DIE SET	GREEN							S46RT	P46RT	L46RT
				NEST									No Nest	
				INDENTOR									P44PR	
33				DIE SET	GRAY									L47RT
				NEST										
				INDENTOR										
34				DIE SET	BROWN									L48RT
				NEST										
				INDENTOR										
38		MR4C MR8G98 MR89Q MY28 Y8MRB-1		NEST				DV8L	UV8L	UV8L	UV8L	UV8L	UV8L	
				INDENTOR				Y29PL	Y34PL	Y34PL	Y34PL	Y34PL	Y34PL	

① Cat. No. Y35P3 Adaptor is required to use "Y34PR" type indentors with "U" type nest dies in Y35 and Y750 series.
 ② Cat. No. PT6515 Adaptor is required to use "U" type dies in Y45 series.

③ Cat. No. PUADP-1 Adaptor is required to use "U" type dies in Y46 series.
 ④ The MD6-6R2 ratchet tool is required on these sizes. The standard MD6 or MD6R ratchet tools will not work.

⑤ Also pneumatic version Y29NC.

PRESENT INSTALLATION TOOL INDEX (continued)

DIE		DIELESS TOOLS		INSTALLATION TOOLING USING DIES										
GROOVE		MECH.	HYD.	DIE INFORMATION		MECHANICAL		HYDRAULIC						
BURNDY	EEI	MR, MY	Y644	TYPE	COLOR	MD6	OUR840	Y29B ⑤	Y35 ①	Y39	Y750 ①	Y45 ②	Y46 ③	Y60 Ser.
39		MR4C MY28	1 CRIMP	NEST				DV6L	UV6L	UV6L	UV6L	UV6L	UV6L	
				INDENTOR				Y29PL	Y34PLA	Y34PLA	Y34PLA	Y34PLA	Y34PLA	Y34PLA
40		MR4C MY28		NEST				DV4L	UV4L	UV4L	UV4L	UV4L	UV4L	
				INDENTOR				Y29PL	Y34PLA	Y34PLA	Y34PLA	Y34PLA	Y34PLA	Y34PLA
41		MY28		NEST				DV2L	UV2;	UV2;	UV2;	UV2;	UV2;	
				INDENTOR				Y29PL	Y34PLA	Y34PLA	Y34PLA	Y34PLA	Y34PLA	Y34PLA
42		MY28		NEST				DV1L	UV1L	UV1L	UV1L	UV1L	UV1L	
				INDENTOR				Y29PL	Y34PLA	Y34PLA	Y34PLA	Y34PLA	Y34PLA	Y34PLA
43		MY28		NEST				DV25L	UV25L	UV25L	UV25L	UV25L	UV25L	
				INDENTOR				Y29PL	Y34PA	Y34PA	Y34PA	Y34PA	Y34PA	Y34PA
44		MY28		NEST				DV26L	UV26L	UV26L	UV26L	UV26L	UV26L	
				INDENTOR				Y29PL	Y34PA	Y34PA	Y34PA	Y34PA	Y34PA	Y34PA
45		MY28		NEST					UV27L	UV27L	UV27L	UV27L	UV27L	
				INDENTOR					Y34PA	Y34PA	Y34PA	Y34PA	Y34PA	Y34PA
46		MY28		NEST					UV28L	UV28L	UV28L	UV28L	UV28L	
				INDENTOR					Y34PA	Y34PA	Y34PA	Y34PA	Y34PA	Y34PA
49				DIE SET	RED	W8CRT	X8CRT		U8CRT	U8CRT	U8CRT	U8CRT	U8CRT	
161				DIE SET		W161	X-161		U161	U161	U161	U161	U161	
162				DIE SET		W162	W162		U162	U162	U162	U162	U162	
163 505				DIE SET		W163	W163		U163	U163	U163	U163	U163	
164 275				DIE SET		W164			U164	U164	U164	U164	U164	
165 205 287 339				DIE SET		W165	X-165		U165/ U205	U165/ U205	U165/ U205	U165/ U205	U165/ U205	L165
166 206 459				DIE SET		W166			U166/ U459	U166/ U459	U166/ U459	U166/ U459	U166/ U459	L166
167 207 211 256 568				DIE SET		W167			U167/ U568	U167/ U568	U167/ U568	U167/ U568	U167/ U568	L167
168 208				DIE SET					U168	U168	U168	U168	U168	L168
169				DIE SET					U169	U169	U169	U169	U169	L169
170 306				DIE SET					U170	U170	U170	U170	U170	L170
171				DIE SET		W161			U171	U171	U171	U171	U171	
193				DIE SET					U193	U193	U193	U193	U193	L193
202				DIE SET					U202	U202	U202	U202	U202	
203				DIE SET					U203	U203	U203	U203	U203	
204				DIE SET					U204	U204	U204	U204	U204	
205 165 287 339				DIE SET		W165	X-165		U165/ U205	U165/ U205	U165/ U205	U165/ U205	U165/ U205	L165
206 166 459				DIE SET		W166			U166/ U459	U166/ U459	U166/ U459	U166/ U459	U166/ U459	L166
207 167 211 256 568				DIE SET		W167			U167/ U568	U167/ U568	U167/ U568	U167/ U568	U167/ U568	L167
208 168				DIE SET					U168	U168	U168	U168	U168	L168
209				DIE SET					U209	U209	U209	U209	U209	L209
210				DIE SET					U210	U210	U210	U210	U210	L210

① Cat. No. Y35P3 Adaptor is required to use "Y34PR" type indentors with "U" type nest dies in Y35 and Y750 series.
 ② Cat. No. PT6515 Adaptor is required to use "U" type dies in Y45 series.

③ Cat. No. PUADP-1 Adaptor is required to use "U" type dies in Y46 series.
 ④ Also pneumatic version Y29NC.

PRESENT INSTALLATION TOOL INDEX (continued)

DIE		DIELESS TOOLS		INSTALLATION TOOLING USING DIES									
GROOVE		MECH.	HYD.	DIE INFORMATION		MECHANICAL		HYDRAULIC					
BURNDY	EEI	MR, MY	Y644	TYPE	COLOR	MD6	OUR840	Y35 ①	Y39	Y750 ①	Y45 ②	Y46 ③	Y60 Ser.
211 167 256 568				DIE SET		W167		U167/ U568	U167/ U568	U167/ U568	U167/ U568	U167/ U568	L167
236				DIE SET		W236		U236	U236	U236	U236	U236	
237				DIE SET		W237	X-237	U237	U237	U237	U237	U237	
238				DIE SET		W238		U238	U238	U238	U238	U238	
239				DIE SET		W239	X-239	U239	U239	U239	U239	U239	
240				DIE SET	RED	W240		U240	U240	U240	U240	U240	
241				DIE SET		W241	X-241	U241	U241	U241	U241	U241	
242 244	3S/4S			DIE SET		W242		U242	U242	U242	U242	U242	L242
243				DIE SET		W243		U243	U243	U243	U243	U243	L243
244 242	3S/4S			DIE SET		W242		U242	U242	U242	U242	U242	L242
245	9A			DIE SET		W245	X-245	U245	U245	U245	U245	U245	L245
246 248	5S			DIE SET		W248		U248	U248	U248	U248	U248	L248
247				DIE SET		W247	X-247	U247	U247	U247	U247	U247	L247
248 246	5S			DIE SET		W248		U248	U248	U248	U248	U248	L248
249	11A			DIE SET		W249	X-249	U249	U249	U249	U249	U249	L249
250				DIE SET				U250	U250	U250	U250	U250	L250
251	12A			DIE SET	RED	W251		U251	U251	U251	U251	U251	L251
252				DIE SET				U252	U252	U252	U252	U252	L252
253				DIE SET				U253	U253	U253	U253	U253	L253
254				DIE SET							S254	P254	L254
255				DIE SET				U255	U255	U255	U255	U255	L255
256 167 207 211 568				DIE SET		W167		U167/ U567	U167/ U567	U167/ U567	U167/ U567	U167/ U567	L167
257				DIE SET				U257	U257	U257	U257	U257	L257
259				DIE SET				U259	U259	U259	U259	U259	
260				DIE SET									L260
261 318	15A			DIE SET				U261	U261	U261	U261	U261	L261
263				DIE SET				U263	U263	U263	U263	U263	
267				DIE SET				U267	U267	U267	U267	U267	L267
275 164				DIE SET		W164		U164	U164	U164	U164	U164	
276				DIE SET				U276	U276	U276	U276	U276	
285				DIE SET				U285	U285	U285	U285	U285	
287 165 205 339				DIE SET		W165		U165/ U205	U165/ U205	U165/ U205	U165/ U205	U165/ U205	L165
292 578				DIE SET							S292	P292	L292
293 294				DIE SET							S293	P293	L293
296		MY29-3	1 CRIMP	DIE SET	TAN		X25ART	U25ART	U25ART	U25ART	U25ART		
				NEST							P27D		
				INDETOR							P34PR5		
297		MY29-3	1 CRIMP	DIE SET	OLIVE		X26ART	U26ART	U26ART	U26ART	U26ART		
				NEST							P29D		
				INDENTOR							P34PR5		

① Cat. No. Y35P3 Adaptor is required to use "Y34PR" type indentors with "U" type nest dies in Y35 and Y750 series.
 ② Cat. No. PT6515 Adaptor is required to use "U" type dies in Y45 series.

③ Cat. No. PUADP-1 Adaptor is required to use "U" type dies in Y46 series.

PRESENT INSTALLATION TOOL INDEX (continued)

DIE		DIELESS TOOLS		INSTALLATION TOOLING USING DIES									
GROOVE		MECH.	HYD.	DIE INFORMATION		MECHANICAL		HYDRAULIC					
BURNDY	E EI	MR, MY	Y644	TYPE	COLOR	MD6	OUR840	Y35 ①	Y39	Y750 ①	Y45 ②	Y46 ③	Y60 Ser.
298		MY29-3	1 CRIMP	DIE SET	WHITE		X28ART	U28ART	U28ART	U28ART	U28ART	U28ART	L28ART
				NEST							P31D		
				INDENTOR							Y45PR5		
299			1 CRIMP	DIE SET	BROWN			U31ART	U31ART	U31ART	U31ART	U31ART	L31ART
				NEST							P35D		
				INDENTOR							P48PR1		
300			1 CRIMP	DIE SET	PINK			U34ART	U34ART	U34ART	U34ART	U34ART	L34ART
				NEST							P39D		
				INDENTOR							P49PR1		
301			1 CRIMP	DIE SET	RED						S39ART	P39ART	L39ART
				NEST							P45D		
				INDENTOR							P48PR1		
302			1 CRIMP	DIE SET	BROWN						S44ART	P44ART	L44ART
				NEST							No Nest		
				INDENTOR							P48PR1		
303				DIE SET	GRAY			U42ART	U42ART	U42ART	U42ART	U42ART	
304				DIE SET				U304	U304	U304	U304	U304	L304
305 341				DIE SET				U305	U305	U305	U305	U305	L305
306 170				DIE SET				U170	U170	U170	U170	U170	L170
308				DIE SET				U308	U308	U308	U308	U308	
313				DIE SET				U313	U313	U313	U313	U313	L313
314 376				DIE SET									L314
316				DIE SET				U316	U316	U316	U316	U316	L316
317 426				DIE SET				U317	U317	U317	U317	U317	L317
318 261				DIE SET				U261	U261	U261	U261	U261	L261
319				DIE SET							S319	P319	L319
320				DIE SET							S320	P320	L320
321				DIE SET				U321	U321	U321	U321	U321	L321
322				DIE SET				U322	U322	U322	U322	U322	
324			1 CRIMP	DIE SET	RED			U29ART	U29ART	U29ART	U29ART	U29ART	L29ART
				NEST							P32D		
				INDENTOR							P34PR5		
326 538				DIE SET				U33RT	U33RT	U33RT	U33RT	U33RT	
327	14A			DIE SET				U327	U327	U327	U327	U327	L327
328				DIE SET									L328
329				DIE SET				U329	U329	U329	U329	U329	
331				DIE SET				U331	U331	U331	U331	U331	
339 165 205 287				DIE SET			X-339	U165/ U205	U165/ U205	U165/ U205	U165/ U205	U165/ U205	
341 305				DIE SET				U305	U305	U305	U305	U305	L305
342				DIE SET							S342	P342	L342
344				DIE SET									L344
345				DIE SET									L345

① Cat. No. Y35P3 Adaptor is required to use "Y34PR" type indentors with "U" type nest dies in Y35 and Y750 series.

② Cat. No. PT6515 Adaptor is required to use "U" type dies in Y45 series.

③ Cat. No. PUADP-1 Adaptor is required to use "U" type dies in Y46 series.

④ The MD6-6R2 ratchet tool is required on these sizes. The standard MD6 or MD6R ratchet tools will not work.

PRESENT INSTALLATION TOOL INDEX (continued)

DIE		DIELESS TOOLS		INSTALLATION TOOLING USING DIES										
GROOVE		MECH.	HYD.	DIE INFORMATION		MECHANICAL		HYDRAULIC						
BURNDY	EEI	MR, MY	Y644	TYPE	COLOR	MD6	OUR840	Y35 ①	Y39	Y750 ①	Y45 ②	Y46 ③	Y60 Ser.	
346	⑦		1 CRIMP	DIE SET	GRAY		X6CART	U6CABT	U6CABT	U6CABT	U6CABT	U6CABT		
348			1 CRIMP	DIE SET	PINK		X2CART	U2CABT	U2CABT	U2CABT	U2CABT	U2CABT		
350				DIE SET				U350	U350	U350	U350	U350	L350	
352				DIE SET							S352	P352	L352	
373				DIE SET				U373	U373	U373	U373	U373		
374		MY29-3		DIE SET	BLUE		X8CART	U8CABT	U8CABT	U8CABT	U8CABT	U8CABT		
375		MY29-3	1 CRIMP	DIE SET	GREEN		X4CART	U4CABT	U4CABT	U4CABT	U4CABT	U4CABT		
376 314				DIE SET									L314	
400				DIE SET	PURPLE			U38RT	U38RT	U38RT	U38RT	U38RT		
403				DIE SET				U403	U403	U403	U403	U403		
419				DIE SET							S419	P419	L419	
422				DIE SET									L422	
426 317				DIE SET				U317	U317	U317	U317	U317		
459 166				DIE SET				U166/459	U166/459	U166/459	U166/459	U166/459		
467		MY29-3	1 CRIMP	DIE SET	RUBY		X27ART	U27ART	U27ART	U27ART	U27ART	U27ART		
				NEST								P30D		
				INDENTOR									P34PR5	
468				DIE SET			U468	U468	U468	U468	U468			
469				DIE SET						S469	P469	L469		
470			1 CRIMP	DIE SET	BLUE			U30ART	U30ART	U30ART	U30ART	U30ART	L30ART	
				NEST									P34D	
				INDENTOR										P48PR1
471		MY29-3	1 CRIMP	DIE SET	GOLD		X1CART	U1CART	U1CART	U1CART	U1CART	U1CART		
				NEST										
				INDENTOR										
472			1 CRIMP	DIE SET	GREEN			U32ART	U32ART	U32ART	U32ART	U32ART	L32ART	
				NEST									P35D	
				INDENTOR										P48PR1
473			1 CRIMP	DIE SET	BLACK			U36ART	U36ART	U36ART	U36ART	U36ART	L36ART	
				NEST									P44D	
				INDENTOR										P48PR1
474			1 CRIMP	DIE SET	GOLD						S40ART	P40ART	L40ART	
				NEST										
				INDENTOR										
478			1 CRIMP	DIE SET	BLUE								L46ART	
				NEST										
				INDENTOR										
479				DIE SET	RED							L48ART		
490 547				DIE SET				U490	U490	U490	U490	U490	L490	
495				DIE SET									L495	
505 163				DIE SET		W163		U163	U163	U163	U163	U163	L163	

① Cat. No. Y35P3 Adaptor is required to use "Y34PR" type indentors with "U" type nest dies in Y35 and Y750 series.
 ② Cat. No. PT6515 Adaptor is required to use "U" type dies in Y45 series.

③ Cat. No. PUADP-1 Adaptor is required to use "U" type dies in Y46 series.
 ④ The MD6-6R2 ratchet tool is required on these sizes. The standard MD6 or MD6R ratchet tools will not work.

⑦ Hexagonal crimp

PRESENT INSTALLATION TOOL INDEX (continued)

DIE		DIELESS TOOLS		INSTALLATION TOOLING USING DIES									
GROOVE		MECH.	HYD.	DIE INFORMATION		MECHANICAL		HYDRAULIC					
BURNDY	EEI	MR, MY	Y644	TYPE	COLOR	MD6	OUR840	Y35 ①	Y39	Y750 ①	Y45 ②	Y46 ③	Y60 Ser.
511		MY29-3		NEST INDENTOR									
512		MY29-3		NEST INDENTOR									
513		MY29-3		NEST INDENTOR									
514		MY29-3		NEST INDENTOR									
515		MY29-3		NEST INDENTOR									
516		MY29-3		NEST INDENTOR									
517		MY29-3		NEST INDENTOR									
518		MY29-3		NEST INDENTOR									
519		MY29-3		NEST INDENTOR									
520		MY29-3		NEST INDENTOR									
538 326				DIE SET				U33RT	U33RT	U33RT	U33RT	U33RT	
547 490				DIE SET				U490	U490	U490	U490	U490	L490
552				DIE SET				U552	U552	U552	U552	U552	
568 167 207 211 256				DIE SET		W167		U167/ U568	U167/ U568	U167/ U568	U167/ U568	U167/ U568	
575				DIE SET									L575
576				DIE SET									L576
578 292				DIE SET							S292	P292	L292
579				DIE SET							S579	P579	L579
587				DIE SET									L47ART
607				DIE SET				U607	U607	U607	U607	U607	
608				DIE SET				U608	U608	U608	U608	U608	608
609				DIE SET				U609	U609	U609	U609	U609	
627				DIE SET									L627
642				DIE SET				U642	U642	U642	U642	U642	L642
643				DIE SET				U643	U643	U643	U643	U643	
647 [Ⓢ]				DIE SET									L45ART
648				DIE SET									L648
654				DIE SET	PURPLE			U654	U654	U654	U654	U654	L654
655	13A			DIE SET				U655	U655	U655	U655	U655	
658				DIE SET				U658	U658	U658	U658	U658	
659				DIE SET		W659		U659	U659	U659	U659	U659	
660				DIE SET		W660	X-660	U660	U660	U660	U660	U660	
667				DIE SET									L667
668				DIE SET				U668	U668	U668	U668	U668	

① Cat. No. Y35P3 Adaptor is required to use "Y34PR" type indentors with "U" type nest dies in Y35 and Y750 series.
 ② Cat. No. PT6515 Adaptor is required to use "U" type dies in Y45 series.

③ Cat. No. PUADP-1 Adaptor is required to use "U" type dies in Y46 series.
 ④ Die 302 recommended for 1.84 O.D. barrel.

PRESENT INSTALLATION TOOL INDEX (continued)

DIE		DIELESS TOOLS		INSTALLATION TOOLING USING DIES									
GROOVE		MECH.	HYD.	DIE INFORMATION		MECHANICAL		HYDRAULIC					
BURNDY	EEL	MR, MY	Y644	TYPE	COLOR	MD6	OUR840	Y35 ①	Y39	Y750 ①	Y45 ②	Y46 ③	Y60 Ser.
676				DIE SET				U676	U676	U676	U676	U676	
677				DIE SET				U677	U677	U677	U677	U677	L677
678				DIE SET				U678	U678	U678	U678	U678	
679				DIE SET				U679	U679	U679	U679	U679	
684				DIE SET									L684
687				DIE SET		W687	X-687						
690	1S			DIE SET		W690		U690	U690	U690	U690	U690	
691	2S			DIE SET		W691		U691	U691	U691	U691	U691	
692	4S			DIE SET		W692		U692	U692	U692	U692	U692	
693	6A			DIE SET		W693		U693	U693	U693	U693	U693	
694	10A			DIE SET		W694		U694	U694	U694	U694	U694	
702				DIE SET		W702							
705				DIE SET				U705	U705	U705	U705	U705	
717	⊗			DIE SET							S717	P717	L717/ L717W
718	⊗			DIE SET									L718
719	⊗			DIE SET							S719	P719	L719/ L719W
720	⊗			DIE SET							S720	P720	L720/ L720W
721	⊗			DIE SET									L721
722	⊗			DIE SET							S722	P722	L722/ L722W
723	⊗			DIE SET									L723
724	⊗			DIE SET							S724	P724	L724/ L724W
725	⊗			DIE SET							S725	P725	L725/ L725W
726	⊗			DIE SET									L726
727	⊗			DIE SET									L727/ L727W
728	⊗			DIE SET									L728/ L728W
729	⊗			DIE SET									L729/ L729W
735	⊗			DIE SET									L735/ L735W
740	⊗			DIE SET									L740
786				DIE SET				U786	U786	U786	U786	U786	
788				DIE SET				U788	U788	U788	U788	U788	
789				DIE SET									L789
936	⊗		1 CRIMP	DIE SET	YELLOW			U39ART-2	U39ART-2	U39ART-2	U39ART-2	U39ART-2	L39ART-2
997				DIE SET	ORANGE			U997	U997	U997	U997	U997	
998				DIE SET						PU998	S998	P998	
999				DIE SET							S999	P999	
1011				DIE SET						U1011	S1011	P1011	
1012				DIE SET							S1012		

① Cat. No. Y35P3 Adaptor is required to use "Y34PR" type indentors with "U" type nest dies in Y35 and Y750 series.

② Cat. No. PT6515 Adaptor is required to use "U" type dies in Y45 series.

③ Cat. No. PUADP-1 Adaptor is required to use "U" type dies in Y46 series.
⊗ Hexagonal crimp

PRESENT INSTALLATION TOOL INDEX (continued)

DIE		DIELESS TOOLS		INSTALLATION TOOLING USING DIES										
GROOVE		MECH.	HYD.	DIE INFORMATION		MECHANICAL		HYDRAULIC						
BURNDY	EEI	MR, MY	Y644	TYPE	COLOR	MD6	OUR840	Y35 ①	Y39	Y750 ①	Y45 ②	Y46 ③	Y60 Ser.	
1013		MY29-11		NEST				UV8L	UV8L	UV8L	UV8L	UV8L		
				INDENTOR				Y34PL	Y34PL	Y34PL	Y34PL	Y34PL		
1014		MY29-11		NEST				U6CD1	U6CD1	U6CD1	U6CD1	U6CD1		
				INDENTOR				Y34PR	Y34PR	Y34PR	Y34PR	Y34PR		
1015		MY29-11		NEST				U4CD1	U4CD1	U4CD1	U4CD1	U4CD1		
				INDENTOR				Y34PR	Y34PR	Y34PR	Y34PR	Y34PR		
1016		MY29-11		NEST				U3CD1	U3CD1	U3CD1	U3CD1	U3CD1		
				INDENTOR				Y34PR	Y34PR	Y34PR	Y34PR	Y34PR		
1017		MY29-11		NEST				U2CD1	U2CD1	U2CD1	U2CD1	U2CD1		
				INDENTOR				Y34PR	Y34PR	Y34PR	Y34PR	Y34PR		
1018		MY29-11		NEST				U1CD1	U1CD1	U1CD1	U1CD1	U1CD1		
				INDENTOR				Y34PR	Y34PR	Y34PR	Y34PR	Y34PR		
1019		MY29-11		NEST				U25D1	U25D1	U25D1	U25D1	U25D1		
				INDENTOR				Y34PR2	Y34PR2	Y34PR2	Y34PR2	Y34PR2		
1020		MY29-11		NEST				U26D1	U26D1	U26D1	U26D1	U26D1		
				INDENTOR				Y34PR2	Y34PR2	Y34PR2	Y34PR2	Y34PR2		
1021		MY29-11		NEST				U27D1	U27D1	U27D1	U27D1	U27D1		
				INDENTOR				Y34PR2	Y34PR2	Y34PR2	Y34PR2	Y34PR2		
1022		MY29-11		NEST				U28D1	U28D1	U28D1	U28D1	U28D1		
				INDENTOR				Y34PR2	Y34PR2	Y34PR2	Y34PR2	Y34PR2		
1023		MY29-11		NEST				U29D1	U29D1	U29D1	U29D1	U29D1		
				INDENTOR				Y34PR2	Y34PR2	Y34PR2	Y34PR2	Y34PR2		
1024				NEST				U30D1	U30D1	U30D1	U30D1	U30D1		
				INDENTOR				Y34PR2	Y34PR2	Y34PR2	Y34PR2	Y34PR2		
1025				NEST				U31D1	U31D1	U31D1	U31D1	U31D1		
				INDENTOR				Y34PR2	Y34PR2	Y34PR2	Y34PR2	Y34PR2		
1026				NEST				U32D1	U32D1	U32D1	U32D1	U32D1		
				INDENTOR				Y34PR2	Y34PR2	Y34PR2	Y34PR2	Y34PR2		
1027				NEST				U34D1	U34D1	U34D1	U34D1	U34D1		
				INDENTOR				Y34PR2	Y34PR2	Y34PR2	Y34PR2	Y34PR2		
1028				NEST								P36D		
				INDENTOR										Y48PR1
1029				NEST									P38D	
				INDENTOR										P48PR1
1030				NEST									P39D	
				INDENTOR										P48PR1
1031				NEST									P40D	
				INDENTOR										P48PR1
1032				NEST									P44D	
				INDENTOR										P48PR1
1102				DIE SET	WHITE							P1102		
1103				DIE SET	BLUE								P1103	
1104				DIE SET	BROWN					U1104			P1104	
1105				DIE SET						U1105			P1105	
2000				NEST				U27B	U27B	U27B	U27B			
				INDENTOR				Y34PR15	Y34PR15	Y34PR15	Y34PR15			

COLOR CODING FOR OVERHEAD CONNECTORS

Color Code	Wire Dia. per Strand			
	Str.	Compact	Sol.	ACSR
Brown	10		8	
Green	8		6	
Blue	5, 6		4	6
Orange	3, 4	#2	2	4
Red	1-19, 2	1/0	1	2
Yellow	1/0	2/0		1/0, 1
Gray	2/0	3/0		2/0
Black	3/0	4/0		3/0
Pink	4/0	266, 300		4/0
Red	250			
White	266			
Blue	300	350		266.8 (26/7, 18/1)
Brown	336			
Green	350, 397, 400			336.4 (26/7, 18/1)
Gray	450			
Pink	500			477 (18/1)
Green	556			
Purple	600			
Yellow				556.5 (24/7, 26/7)
Blue	650			
Red	700			
Yellow	750			
Orange	800			
White	900			
Brown	1000			

NOTE: This chart is only intended as a guide. For specific applications, refer to the catalog page of the connector.

COLOR CODING FOR AL/CU CONNECTORS

Color Code	Str.	Color Code	Str.
Blue	8	Blue	300
Gray	6	Brown	350
Green	4	Green	400
Pink	2	Pink	500
Gold	1	Black	600
Tan	1/0	Yellow	700/750
Olive	2/0	Red	700/750
Ruby	3/0	Brown	1000
White	4/0	Blue	1500
Red	250	Red	2000

NOTE: This chart is only intended as a guide. For specific applications, refer to the catalog page of the connector.

COLOR CODING FOR COPPER LUGS AND SPLICES

Color Code	Code Size		Flex Cable
	Str.	Sol.	
Red	8	6	8
Blue	6		6
Blue	5		
Gray	4		4
White	3	2	
Brown	2		2
Green	1		1
Pink	1/0		1/0
Black	2/0		2/0
Orange	3/0		3/0
Purple	4/0		4/0
Yellow	250		4/0 and 250
White	300		250
Red	350		313.1
Blue	400		373.7
Brown	500		444.4
Green	600		
Pink	700		535.3
Purple			600
Black	750		646
Yellow			777.7
Orange	800		
White	1000		
Yellow			1111
Green	1500		
Brown	2000		

NOTE: This chart is only intended as a guide. For specific applications, refer to the catalog page of the connector.

BURNDY® REGISTERED AND TRADE NAMES

Registered Name	Registered/Trade Name	Catalog Section	Registered/Trade Name	Catalog Section
4-POINT®	4-POINT®	N	PATRIOT®	N
BONDIT®	ALFLUID™	N	PENETROX™	F
BURNDY®	BARTAP™	A, E, L	POLYTAP™	A
BURNDYWeld®	BONDIT®	E	POPPER™	N
ENFORCER®	BURNDYWeld®	E	POSI-PRESS™	N
GRIDMAX®	CABELOK™	H	POWERLUG™	J
HYGROUND®	CLIPIT™	H	QIKLINK™	A
IMPLO®	CRIMPIT™	C, E, H	QIKLITE®	E
INFINITY DRIVE®	DURIUM™	D	QIKLUG™	A, E
IN-LINE®	ENFORCER®	N	QIKTAP™	B
PATRIOT®	FASTAP™	H	SCRULLUG™	A
SERVIT®	FINGRIP™	B	SERVIT POST™	E
The SmartCart®	FLEXITAP™	A	SERVIT®	A, H
There is Only One IMPLO®	GRIDLOK™	E	SPEC-BLOK™	A
	GRIDMAX®	E	STIRRUP™	H
Connecting Power to Your World™	GROUNDLINK™	E	STIRRUP™	J
	GROUNDMAX™	E	STUDBUG™	E
	HYCRAB™	K	SUPER-CLAMP™	E
	HYCRIMP™	H	TAPIT™	H
	HYDENT™	B, C	The SmartCart®	N
	HYFLUID™	N	TRITAP™	A
	HYGRID™	E	U-BLOK™	A
	HYGROUND®	E	UNIGROUND™	E
	HYLINK™	B, C, E	UNIRAP™	G
	HYLUG™	B, C, E, H	UNISPLICE™	H
	HYPLUG™	C, H	UNITAP™	A
	HYPRESS™	N	VARILUG™	L
	HYREDUCER™	B, C, K	VARITAP™	A
	HYSEALPLUG™	H	VERSILUG™	A
	HYSEALUG™	H	VERSIPOLE™	A
	HYSPLICE™	C, H	VERSITAIL™	E
	HYSTACK™	C	VERSITAP™	A, H
	HYTAIL™	E	VINYLUG™	B
	HYTAP™	C, E	VISEIT™	H
	HYTEE™	H	VISI-SHRINK™	F
	HYTOOL™	N	WEEB™	E
	IMPLO®	I	WEJTAP™	J
	INFINITY DRIVE®	N	WIREMIKE™	N
	IN-LINE®	N		
	INSULUG™	B		
	KA-LUG™	A		
	KOMPRESSOR™	N		
	L'IL CRIMP™	N		
	LINEMAN ASSIST™	H		
	LOKTAP™	H		
	MOLE™	A, K		
	MOLIMITER™	K		
	NOTAPE™	K		
	OKLIP™	A		
	OKLIP™	H		

ALPHA-NUMERIC INDEX BY CATALOG NUMBER

Catalog Number	Page #	Catalog Number	Page #	Catalog Number	Page #	Catalog Number	Page #
15	E-74	1149	I-59	2113	I-55	3075	I-55
25	E-74	1150	I-59	2114	I-55	3076	I-55
32	E-74	1157	I-59	2117	I-55	3077	I-55
45	E-74	1158	I-59	2118	I-55	3079	I-55
65	E-74	1165	I-59	2120	I-55	3080	I-55
90	E-74	1166	I-59	2121	I-55	3083	I-55
115	E-74	1167	I-56	2123	I-55	3084	I-55
150	E-74	1169	I-59	2124	I-55	3085	I-59
200	E-74	1170	I-59	2131	I-55	3086	I-59
250	E-74	1171	I-59	2133	I-55	3090	I-55
500	E-74	1174	I-59	2138	I-55	3093	I-59
1050	I-54	1179	I-59	2139	I-55	3094	I-55
1051	I-54	1181	I-59	2140	I-55	3095	I-55
1052	I-54	1182	I-59	2141	I-55	3103	I-55
1053	I-54	1190	I-56	2142	I-56	3112	I-55
1054	I-54	1903	I-60	2143	I-56	3113	I-55
1056	I-54	1904	I-60	2144	I-56	3114	I-55
1057	I-54	1906	I-60	2146	I-56	3117	I-55
1058	I-54	1923	I-60	2149	I-59	3118	I-55
1059	I-54	1930	I-60	2150	I-59	3120	I-55
1060	I-54	1931	I-60	2157	I-59	3121	I-55
1061	I-54	1978	I-60	2158	I-59	3123	I-55
1062	I-54	1990	I-60	2165	I-59	3124	I-55
1063	I-54	1991	I-60	2166	I-59	3131	I-55
1064	I-54	1993	I-60	2167	I-56	3133	I-55
1065	I-54	1994	I-60	2169	I-59	3138	I-55
1066	I-54	1995	I-60	2170	I-59	3139	I-55
1067	I-54	1997	I-60	2171	I-59	3140	I-55
1070	I-54	1998	I-60	2174	I-59	3141	I-55
1072	I-54	2050	I-54	2179	I-59	3142	I-56
1073	I-55	2051	I-54	2181	I-59	3143	I-56
1074	I-55	2052	I-54	2182	I-59	3144	I-56
1075	I-55	2053	I-54	2190	I-56	3146	I-56
1076	I-55	2054	I-54	2903	I-60	3149	I-59
1077	I-55	2056	I-54	2904	I-60	3150	I-59
1079	I-55	2057	I-54	2906	I-60	3157	I-59
1080	I-55	2058	I-54	2923	I-60	3158	I-59
1083	I-55	2059	I-54	2978	I-60	3165	I-59
1084	I-55	2060	I-54	2990	I-60	3166	I-59
1085	I-59	2061	I-54	2991	I-60	3167	I-56
1086	I-59	2062	I-54	2993	I-60	3169	I-59
1090	I-55	2063	I-54	2994	I-60	3170	I-59
1093	I-59	2064	I-54	2995	I-60	3171	I-59
1094	I-55	2065	I-54	2997	I-60	3174	I-59
1095	I-55	2066	I-54	2998	I-60	3179	I-59
1103	I-55	2067	I-54	3050	I-54	3181	I-59
1112	I-55	2070	I-54	3051	I-54	3182	I-59
1113	I-55	2072	I-54	3053	I-54	3190	I-56
1114	I-55	2073	I-55	3054	I-54	9050	I-54
1117	I-55	2074	I-55	3056	I-54	9051	I-54
1118	I-55	2075	I-55	3057	I-54	9052	I-54
1120	I-55	2076	I-55	3058	I-54	9053	I-54
1121	I-55	2077	I-55	3059	I-54	9054	I-54
1123	I-55	2079	I-55	3060	I-54	9056	I-54
1124	I-55	2080	I-55	3061	I-54	9057	I-54
1131	I-55	2083	I-55	3062	I-54	9058	I-54
1133	I-55	2084	I-55	3063	I-54	9059	I-54
1138	I-55	2085	I-59	3064	I-54	9060	I-54
1139	I-55	2086	I-59	3065	I-54	9061	I-54
1140	I-55	2090	I-55	3066	I-54	9062	I-54
1141	I-55	2093	I-59	3067	I-54	9063	I-54
1142	I-56	2094	I-55	3070	I-54	9064	I-54
1143	I-56	2095	I-55	3072	I-54	9065	I-54
1144	I-56	2103	I-55	3073	I-55	9066	I-54
1146	I-56	2112	I-55	3074	I-55	9067	I-54

ALPHA-NUMERIC INDEX BY CATALOG NUMBER (Continued)

Catalog Number	Page #	Catalog Number	Page #	Catalog Number	Page #	Catalog Number	Page #
9070	I-54	1057/ACSS	I-57	1PLD3503	A-60	25CP	E-74
9072	I-54	1057/ACSS/TW	I-58	1PLD3504	A-60	25FWBOX	D-3
9073	I-55	1059/ACSS	I-57	1PLD3506	A-60	25FWSS	D-6
9074	I-55	1059/ACSS/TW	I-58	1PLD3508	A-60	25HSSN	D-6
9075	I-55	1060/ACSS	I-57	1PLD43	A-60	25NWBOX	D-3
9076	I-55	1060/ACSS/TW	I-58	1PLD44	A-60	25Q	E-71
9077	I-55	1061/ACSS	I-57	1PLD6002	A-60	25SWBOX	D-3
9079	I-55	1061/ACSS/TW	I-58	1PLD6003	A-60	25SWSSLT	D-6
9080	I-55	1062/ACSS	I-57	1PLD6004	A-60	25x100HEBBOX	D-2
9083	I-55	1062/ACSS/TW	I-58	1PLD6005	A-60	25x125HEBBOX	D-2
9084	I-55	1063/ACSS	I-57	1PLD6006	A-60	25x150HEBBOX	D-2
9085	I-59	1063/ACSS/TW	I-58	1PLD6008	A-60	25x200HEBBOX	D-2
9086	I-59	1065/ACSS	I-57	1PLO2/02	A-60	25x250HEBBOX	D-2
9090	I-55	1065/ACSS/TW	I-58	1PLO2502	A-60	25x300HEBBOX	D-2
9093	I-59	1066/ACSS	I-57	1PLO3502	A-60	25x50HEBBOX	D-2
9094	I-55	1066/ACSS/TW	I-58	1PLO42	A-60	25x62HEBBOX	D-2
9095	I-55	1067/ACSS	I-57	1PLO6002	A-60	25x75HEBBOX	D-2
9103	I-55	1067/ACSS/TW	I-58	200Q	E-71	3050/ACSS	I-57
9112	I-55	1070/ACSS	I-57	2050/ACSS	I-57	3050/ACSS/TW	I-58
9113	I-55	1070/ACSS/TW	I-58	2050/ACSS/TW	I-58	3051/ACSS	I-57
9114	I-55	1072/ACSS	I-57	2050/I	I-54	3051/ACSS/TW	I-58
9117	I-55	1072/ACSS/TW	I-58	2051/ACSS	I-57	3052/ACSS	I-57
9118	I-55	1073/ACSS	I-57	2051/ACSS/TW	I-58	3052/ACSS/TW	I-58
9120	I-55	1073/ACSS/TW	I-58	2052/ACSS	I-57	3053/ACSS	I-57
9121	I-55	1074/ACSS	I-57	2052/ACSS/TW	I-58	3053/ACSS/TW	I-58
9123	I-55	1074/ACSS/TW	I-58	2053/ACSS	I-57	3054/ACSS	I-57
9124	I-55	1075/ACSS	I-57	2053/ACSS/TW	I-58	3054/ACSS/TW	I-58
9131	I-55	1075/ACSS/TW	I-58	2054/ACSS	I-57	3056/ACSS	I-57
9133	I-55	1076/ACSS	I-57	2054/ACSS/TW	I-58	3056/ACSS/TW	I-58
9138	I-55	1076/ACSS/TW	I-58	2056/ACSS	I-57	3057/ACSS	I-57
9139	I-55	115CI	E-74	2056/ACSS/TW	I-58	3057/ACSS/TW	I-58
9140	I-55	115Q	E-71	2057/ACSS	I-57	3059/ACSS	I-57
9141	I-55	1165-NZ	I-59	2057/ACSS/TW	I-58	3059/ACSS/TW	I-58
9142	I-56	122EMT	N-121	2059/ACSS	I-57	3060/ACSS	I-57
9143	I-56	122IMC	N-121	2059/ACSS/TW	I-58	3060/ACSS/TW	I-58
9144	I-56	122PVC	N-121	2060/ACSS	I-57	3061/ACSS	I-57
9146	I-56	122RIG	N-121	2060/ACSS/TW	I-58	3061/ACSS/TW	I-58
9149	I-59	145PTAG	G-11	2061/ACSS	I-57	3062/ACSS	I-57
9150	I-59	150Q	E-71	2061/ACSS/TW	I-58	3062/ACSS/TW	I-58
9157	I-59	15CI	E-74	2062/ACSS	I-57	3063/ACSS	I-57
9158	I-59	15CP	E-74	2062/ACSS/TW	I-58	3063/ACSS/TW	I-58
9165	I-59	15Q	E-71	2063/ACSS	I-57	3065/ACSS	I-57
9166	I-59	1PBS1/0	A-60	2063/ACSS/TW	I-58	3065/ACSS/TW	I-58
9167	I-56	1PBS2	A-60	2065/ACSS	I-57	3066/ACSS	I-57
9169	I-59	1PBS250	A-60	2065/ACSS/TW	I-58	3066/ACSS/TW	I-58
9170	I-59	1PBS350	A-60	2066/ACSS	I-57	3067/ACSS	I-57
9171	I-59	1PBS500	A-60	2066/ACSS/TW	I-58	3067/ACSS/TW	I-58
9174	I-59	1PL2/02	A-60	2067/ACSS	I-57	3070/ACSS	I-57
9179	I-59	1PL2/03	A-60	2067/ACSS/TW	I-58	3070/ACSS/TW	I-58
9181	I-59	1PL2502	A-60	2070/ACSS	I-57	3072/ACSS	I-57
9182	I-59	1PL2503	A-60	2070/ACSS/TW	I-58	3072/ACSS/TW	I-58
9190	I-56	1PL3502	A-60	2072/ACSS	I-57	3073/ACSS	I-57
1050/ACSS	I-57	1PL42	A-60	2072/ACSS/TW	I-58	3073/ACSS/TW	I-58
1050/ACSS/TW	I-58	1PL43	A-60	2073/ACSS	I-57	3074/ACSS	I-57
1050/I	I-54	1PL44	A-60	2073/ACSS/TW	I-58	3074/ACSS/TW	I-58
1051/ACSS	I-57	1PL6002	A-60	2074/ACSS	I-57	3075/ACSS	I-57
1051/ACSS/TW	I-58	1PLD2/02	A-60	2074/ACSS/TW	I-58	3075/ACSS/TW	I-58
1052/ACSS	I-57	1PLD2/03	A-60	2075/ACSS	I-57	3076/ACSS	I-57
1052/ACSS/TW	I-58	1PLD2/04	A-60	2075/ACSS/TW	I-58	3076/ACSS/TW	I-58
1053/ACSS	I-57	1PLD2/06	A-60	2076/ACSS	I-57	3165-NZ	I-59
1053/ACSS/TW	I-58	1PLD2502	A-60	2076/ACSS/TW	I-58	31CHENBOX	D-3
1054/ACSS	I-57	1PLD2503	A-60	2165-NZ	I-59	31CHGSN	D-5
1054/ACSS/TW	I-58	1PLD2504	A-60	250Q	E-71	31FWBOX	D-3
1056/ACSS	I-57	1PLD2506	A-60	25CHENBOX	D-3	31NWBOX	D-3
1056/ACSS/TW	I-58	1PLD3502	A-60	25CI	E-74	31SWBOX	D-3

ALPHA-NUMERIC INDEX BY CATALOG NUMBER (Continued)

Catalog Number	Page #	Catalog Number	Page #	Catalog Number	Page #	Catalog Number	Page #
31x100HEBBOX	D-2	50FWABOX	D-4	5600-1040D	I-47	62FWABOX	D-4
31x125HEBBOX	D-2	50FWBOX	D-3	5600-1042	I-47	62FWBOX	D-3
31x150HEBBOX	D-2	50FWSS	D-6	5600-1042D	I-47	62FWSS	D-6
31x175HEBBOX	D-2	50HANBOX	D-4	5600-1044	I-47	62HANBOX	D-4
31x200HEBBOX	D-2	50HGSN	D-5	5600-1044D	I-47	62HGSN	D-5
31x250HEBBOX	D-2	50HSSN	D-6	5600-1050	I-47	62HSSN	D-6
31x300HEBBOX	D-2	50NWBOX	D-3	5600-1050D	I-47	62NWBOX	D-3
31x50HEBBOX	D-2	50NWGS	D-5	5600-1052	I-47	62NWGS	D-5
31x62HEBBOX	D-2	50SWALBOX	D-4	5600-1052D	I-47	62SWALBOX	D-4
31x75HEBBOX	D-2	50SWBOX	D-3	5600-1054	I-47	62SWBOX	D-3
32CI	E-74	50SWSSMD	D-6	5600-1054D	I-47	62SWSSMD	D-6
32CP	E-74	50x100HEBBOX	D-2	5600-1056	I-47	62x100HEBBOX	D-2
32Q	E-71	50x100HGSSB	D-5	5600-1056D	I-47	62X100HGSSB	D-5
38CHENBOX	D-3	50x106BWSS	D-7	5600-1058	I-48	62x125HEBBOX	D-2
38FWBOX	D-3	50x106FWGS	D-5	5600-1058D	I-48	62x150HEBBOX	D-2
38FWSS	D-6	50x125HEBBOX	D-2	5600-1060	I-47	62x175HABBOX	D-4
38HGSN	D-5	50x150HABBOX	D-4	5600-1060D	I-47	62x175HEBBOX	D-2
38HGSN009	D-5	50x150HEBBOX	D-2	5600-1062	I-47	62x175HGSSB	D-5
38HSSN	D-6	50x150HGSSB	D-5	5600-1062D	I-47	62x200HABBOX	D-4
38NWBOX	D-3	50x175HABBOX	D-4	5600-1064	I-48	62x200HEBBOX	D-2
38NWGS	D-5	50x175HEBBOX	D-2	5600-1064D	I-48	62x225HABBOX	D-4
38SWBOX	D-3	50x200HABBOX	D-4	5600-1066	I-48	62x225HEBBOX	D-2
38SWSSMD	D-6	50x200HEBBOX	D-2	5600-1066D	I-48	62x250HABBOX	D-4
38x100HEBBOX	D-2	50x200HGSSB	D-5	5600-1070	I-48	62x250HEBBOX	D-2
38x125HEBBOX	D-2	50x200HSSB	D-6	5600-1070D	I-48	62x275HEBBOX	D-2
38x125HGSSB	D-5	50x225HABBOX	D-4	5600-1072	I-48	62x300HABBOX	D-4
38X125HSSB	D-6	50x225HEBBOX	D-2	5600-1074	I-48	62x300HEBBOX	D-2
38x150HEBBOX	D-2	50x250HABBOX	D-4	5600-1074D	I-48	62x300HSSB	D-6
38x175HEBBOX	D-2	50x250HEBBOX	D-2	5600-1076	I-48	62x325HEBBOX	D-2
38x200HEBBOX	D-2	50x250HSSB	D-6	5600-1076D	I-48	62x350HABBOX	D-4
38x225HEBBOX	D-2	50x275HABBOX	D-4	5600-1078	I-48	62x350HEBBOX	D-2
38x225HGSSB	D-5	50x275HEBBOX	D-2	5600-1078D	I-48	62x400HABBOX	D-4
38x225HSSB	D-6	50x300HABBOX	D-4	5600-1079	I-48	62x400HEBBOX	D-2
38x250HEBBOX	D-2	50x300HEBBOX	D-2	5600-1079D	I-48	62x450HABBOX	D-4
38x250HSSB	D-6	50x300HSSB	D-6	5600-1080	I-48	62x450HEBBOX	D-2
38x275HEBBOX	D-2	50x325HABBOX	D-4	5600-1080D	I-48	62x500HABBOX	D-4
38x275HGSSB	D-5	50x325HEBBOX	D-2	5600-1082	I-48	62x500HEBBOX	D-2
38x275HSSB	D-6	50x350HABBOX	D-4	5600-1082D	I-48	62x550HABBOX	D-4
38x300HEBBOX	D-2	50x350HEBBOX	D-2	5600-2020	I-49	62x600HABBOX	D-4
38x325HEBBOX	D-2	50x375HABBOX	D-4	5600-2022	I-49	62x600HEBBOX	D-2
38x350HEBBOX	D-2	50x375HEBBOX	D-2	5600-2026	I-49	65CI	E-74
38x400HEBBOX	D-2	50x400HABBOX	D-4	5600-2028	I-49	65CP	E-74
38x450HEBBOX	D-2	50x400HEBBOX	D-2	5600-2030	I-49	65Q	E-71
38x500HEBBOX	D-2	50x425HABBOX	D-4	5600-2032	I-49	75NWGS	D-5
38x50HEBBOX	D-2	50x450HABBOX	D-4	5600-2040	I-49	75X125HGSSB	D-5
38x62HEBBOX	D-2	50x450HEBBOX	D-2	5600-2042	I-49	9050/ACSS	I-57
38x75BWSS	D-7	50x500HABBOX	D-4	5600-2044	I-49	9050/ACSS/TW	I-58
38x75HEBBOX	D-2	50x500HEBBOX	D-2	5600-2050	I-49	9051/ACSS	I-57
38x81FWGS	D-5	50x550HABBOX	D-4	5600-2052	I-49	9051/ACSS/TW	I-58
38x88HEBBOX	D-2	50x550HEBBOX	D-2	5600-2054	I-49	9052/ACSS	I-57
3S	A-41	50x600HEBBOX	D-2	5600-2056	I-49	9052/ACSS/TW	I-58
3U	A-41	50x75HEBBOX	D-2	5600-2058	I-49	9053/ACSS	I-57
44CHENBOX	D-3	5600-1020	I-47	5600-2060	I-49	9053/ACSS/TW	I-58
44FWBOX	D-3	5600-1020D	I-47	5600-2062	I-49	9054/ACSS	I-57
44NWBOX	D-3	5600-1022	I-47	5600-2064	I-49	9054/ACSS/TW	I-58
44SWBOX	D-3	5600-1022D	I-47	5600-2066	I-49	9056/ACSS	I-57
44x150HEBBOX	D-2	5600-1026	I-47	5600-2070	I-49	9056/ACSS/TW	I-58
44x200HEBBOX	D-2	5600-1026D	I-47	5600-2072	I-49	9057/ACSS	I-57
45CI	E-74	5600-1028	I-47	5600-2074	I-49	9057/ACSS/TW	I-58
45CP	E-74	5600-1028D	I-47	5600-2076	I-49	9059/ACSS	I-57
45Q	E-71	5600-1030	I-47	5600-2078	I-49	9059/ACSS/TW	I-58
4S	A-41	5600-1030D	I-47	5600-2079	I-49	9060/ACSS	I-57
4U	A-41	5600-1032	I-47	5600-2080	I-49	9060/ACSS/TW	I-58
500Q	E-71	5600-1032D	I-47	5600-2082	I-49	9061/ACSS	I-57
50CHENBOX	D-3	5600-1040	I-47	62CHENBOX	D-3	9061/ACSS/TW	I-58

ALPHA-NUMERIC INDEX BY CATALOG NUMBER (Continued)

Catalog Number	Page #	Catalog Number	Page #	Catalog Number	Page #	Catalog Number	Page #
9062/ACSS	I-57	B-1208	E-80	B-1321	E-80	B-1646	E-91
9062/ACSS/TW	I-58	B-1212	E-85	B-1322	E-80	B-1648	E-91
9063/ACSS	I-57	B-1215	E-90	B-1323	E-80	B-1649	E-91
9063/ACSS/TW	I-58	B-1216	E-90	B-1324	E-80	B-1650	E-91
9065/ACSS	I-57	B-1218	E-90	B-1325	E-80	B1E34R	N-120
9065/ACSS/TW	I-58	B-1219	E-90	B-1326	E-80	B-205	E-75
9066/ACSS	I-57	B-1220	E-90	B-1327	E-80	B-206	E-75
9066/ACSS/TW	I-58	B-1221	E-90	B-1328	E-80	B-207	E-75
9067/ACSS	I-57	B-1222	E-90	B-1329	E-80	B-208	E-75
9067/ACSS/TW	I-58	B-1223	E-90	B-1330	E-80	B-2084	E-85
9070/ACSS	I-57	B-1224	E-90	B-1331	E-80	B-209	E-75
9070/ACSS/TW	I-58	B-1225-H	E-90	B-1332	E-80	B-210	E-75
9072/ACSS	I-57	B-1226-H	E-90	B-1333	E-80	B-211	E-75
9072/ACSS/TW	I-58	B-1228-H	E-90	B-1334	E-80	B-213	E-75
9073/ACSS	I-57	B-1270	E-79	B-1335	E-80	B-214	E-75
9073/ACSS/TW	I-58	B-1271	E-79	B-1336	E-80	B-215	E-75
9074/ACSS	I-57	B-1272	E-79	B-1581	E-83	B2154	E-83
9074/ACSS/TW	I-58	B-1273	E-79	B-1582	E-83	B-2155	E-83
9075/ACSS	I-57	B-1274	E-79	B-1583	E-83	B-2156	E-83
9075/ACSS/TW	I-58	B-1275	E-79	B-1584	E-83	B-2157	E-83
9076/ACSS	I-57	B-1276	E-79	B-1586	E-83	B-2158	E-83
9076/ACSS/TW	I-58	B-1277	E-79	B-1587	E-83	B-2159	E-83
90CI	E-74	B-1278	E-79	B-1588	E-83	B-2160	E-83
90Q	E-71	B-1279	E-79	B-1589	E-83	B-2161	E-83
9165-NZ	I-59	B-1280	E-79	B-1593	E-83	B-2162	E-83
AGSKIT2	A-33	B-1281	E-79	B-1594	E-83	B-2163	E-83
AGSKIT250	A-33	B-1282	E-79	B-1595	E-83	B-2164	E-83
ALFLUIDGAL	N-97	B-1283	E-79	B-1596	E-83	B-2165	E-83
ALFLUIDQT	N-97	B-1284	E-79	B-1597	E-83	B-2189	E-90
AMS-0	A-32	B-1285	E-79	B-1601	E-83	B-2199	E-87
AMS-1000	A-32	B-1286	E-79	B-1602	E-83	B-2200	E-87
AMS-2	A-32	B-1287	E-79	B-1603	E-83	B-221	E-76
AMS-250	A-32	B-1288	E-79	B-1604	E-83	B-223	E-76
AMS-350	A-32	B-1289	E-79	B-1605	E-83	B-2235	E-85
AMS-4/0	A-32	B-1290	E-79	B-1606	E-83	B-224	E-76
AMS-500	A-32	B-1291	E-79	B-1610	E-83	B-225	E-76
AMS-750	A-32	B-1292	E-79	B-1611	E-83	B-226	E-76
ASA1000U	C-142	B-1293	E-79	B-1613	E-92	B-227	E-76
ASA250U	C-142	B-1294	E-79	B-1614	E-92	B-228	E-76
ASA800U	C-142	B-1295	E-79	B-1615	E-92	B-229	E-76
AYP1	C-149	B-1296	E-79	B-1616	E-92	B-230	E-76
AYP1/0	C-149	B-1297	E-79	B-1617	E-92	B-231	E-76
AYP2	C-149	B-1298	E-79	B-1618	E-92	B-232	E-76
AYP250	C-149	B-1299	E-79	B-1619	E-92	B-2320	E-85
AYP350	C-149	B12E	N-120	B-1620	E-92	B-234	E-76
AYP4	C-149	B-1300	E-79	B-1626	E-91	B-235	E-76
AYP500	C-149	B-1301	E-79	B-1627	E-91	B-236	E-76
AYP6	C-149	B-1302	E-79	B-1628	E-91	B-237	E-76
AYP750	C-149	B-1303	E-79	B-1629	E-91	B-238	E-76
AYPO2/0	C-149	B-1304	E-79	B-1630	E-91	B-239	E-76
AYPO250	C-149	B-1305	E-79	B-1631	E-91	B-240	E-76
AYPO3/0	C-149	B-1306	E-79	B-1632	E-91	B-241	E-76
AYPO300	C-149	B-1307	E-79	B-1633	E-91	B-242	E-76
AYPO350	C-149	B-1308	E-79	B-1634	E-91	B-243	E-76
AYPO4/0	C-149	B-1309	E-79	B-1635	E-91	B-244	E-76
AYPO400	C-149	B-1310	E-79	B-1636	E-91	B-245	E-76
AYPO500	C-149	B-1311	E-80	B-1637	E-91	B-2450	E-85
AYPO600	C-149	B-1313	E-80	B-1638	E-91	B-246	E-76
AYPO750	C-149	B-1314	E-80	B-1639	E-91	B-247	E-76
B-106	E-101	B-1315	E-80	B-1640	E-91	B-2476	E-89
B106-32	E-102	B-1316	E-80	B-1641	E-91	B-2477	E-89
B106-37	E-102	B-1317	E-80	B-1642	E-91	B-2478	E-89
B106-41	E-102	B-1318	E-80	B1643	E-91	B-248	E-76
B-107	E-101	B-1319	E-80	B-1644	E-91	B-2480	E-89
B107-32	E-102	B-1320	E-80	B-1645	E-91	B-2480-S	E-89

ALPHA-NUMERIC INDEX BY CATALOG NUMBER (Continued)

Catalog Number	Page #	Catalog Number	Page #	Catalog Number	Page #	Catalog Number	Page #
B-2482	E-89	B-2705	E-78	B38-0315-00	E-103	B-461	E-77
B-2483	E-89	B-2706	E-78	B38-0330-00	E-103	B-462	E-77
B-2484	E-89	B-2707	E-78	B38-3662-01	E-105	B-463	E-77
B-2486	E-89	B-2708	E-78	B38-3662-02	E-105	B-464	E-77
B-2487	E-89	B-2709	E-78	B38-3662-03	E-105	B-465	E-77
B-2488	E-89	B-2710	E-78	B38-3662-04	E-105	B-466	E-77
B-249	E-76	B-2711	E-78	B38-3662-05	E-105	B-467	E-77
B-2490	E-89	B-2712	E-78	B38-3662-06	E-105	B-468	E-77
B-2491	E-89	B-2713	E-78	B38-3922-00	E-103, E-104	B-469	E-77
B-2493	E-89	B-2714	E-78	B38412900	E-103	B-470	E-77
B-2494	E-89	B-2715	E-78	B38412905	E-103	B-471	E-77
B-2495	E-89	B-2716	E-78	B3D12	E-56	B-472	E-77
B-2497	E-89	B-2717	E-78	B3D12N	E-56	B-483	E-77
B-2498	E-89	B-2718	E-78	B3E12	E-56	B-485	E-77
B-250	E-76	B-2719	E-78	B3E12N	E-56	B-486	E-77
B-2506	E-87	B-2747	E-78	B3F12	E-56	B-487	E-77
B-2507	E-87	B-2751	E-78	B3F12N	E-56	B-488	E-77
B-2509	E-87	B-2752	E-78	B3G12	E-56	B-489	E-77
B-251	E-76	B-2753	E-78	B3G12N	E-56	B-490	E-77
B-2510	E-85	B-2754	E-78	B40-0106-75	E-101	B-491	E-77
B-2511	E-87	B-2755	E-78	B40-0106-76	E-102	B-492	E-77
B-252	E-76	B-2756	E-78	B40-0106-77	E-102	B-493	E-77
B-253	E-76	B-2757	E-78	B40-0106-78	E-102	B-495	E-81
B-254	E-76	B-2761	E-92	B40-0319-01	E-103	B-496	E-81
B-2540	E-90	B-2781	E-90	B40-0319-03	E-103	B-497	E-81
B-2542	E-87	B-280	E-76	B40-3657-00	E-101	B-498	E-81
B-255	E-76	B-282	E-76	B40-4431-00	E-102	B-499	E-81
B-2558	E-85	B-283	E-76	B-423	E-77	B4D12	E-56
B-256	E-76	B-284	E-76	B-424	E-77	B4D12N	E-56
B-2566	E-84	B-285	E-76	B-425	E-77	B4E12	E-56
B-2567	E-92	B-286	E-76	B-426	E-77	B4E12N	E-56
B-2568	E-92	B-287	E-76	B-427	E-77	B4F12	E-56
B-257	E-76	B-288	E-76	B-428	E-77	B4F12N	E-56
B-258	E-76	B-289	E-76	B-429	E-77	B4G12N	E-56
B-2583	E-89	B-290	E-76	B-430	E-77	B-500	E-81
B-2583-S	E-89	B-291	E-76	B-431	E-77	B-501	E-81
B-259	E-76	B-293	E-76	B-432	E-77	B-502	E-81
B-260	E-76	B-294	E-76	B-433	E-77	B-5021	E-76
B-261	E-76	B-295	E-76	B-434	E-77	B-503	E-81
B-262	E-76	B-296	E-76	B-435	E-77	B-504	E-81
B-263	E-76	B-297	E-76	B-436	E-77	B-505	E-81
B-264	E-76	B-298	E-76	B-437	E-77	B-506	E-81
B-265	E-76	B2D12	E-56	B-438	E-77	B-5065	E-88
B-266	E-76	B2D12N	E-56	B-439	E-77	B-507	E-81
B-267	E-76	B2E12	E-56	B-440	E-77	B-508	E-81
B-268	E-76	B2E12N	E-56	B-441	E-77	B-509	E-81
B-2687	E-78	B2F12	E-56	B-442	E-77	B-510	E-81
B-2689	E-78	B2F12N	E-56	B-443	E-77	B-511	E-81
B-269	E-76	B2G12N	E-56	B-444	E-77	B-513	E-81
B-2690	E-78	B-333	E-76	B-445	E-77	B-5294	E-84
B-2691	E-78	B34E12R	N-120	B-446	E-77	B-5321	E-83
B-2692	E-78	B370320-01	E-74	B-447	E-77	B-5330	E-85
B-2693	E-78	B370320-02	E-74	B-448	E-77	B-5331	E-88
B-2694	E-78	B370320-03	E-74	B-449	E-77	B-5332	E-85
B-2695	E-78	B38-0101-00	E-104	B-450	E-77	B-5333	E-85
B-2696	E-78	B38-0135-01	E-103	B-451	E-77	B-5334	E-85
B-2697	E-78	B38-0302-00	E-104	B-452	E-77	B-5335	E-85
B-2698	E-78	B38-0302-02	E-104	B-453	E-77	B-5336	E-85
B-2699	E-78	B38-0303-00	E-104	B-454	E-77	B-5337	E-85
B-270	E-76	B38-0304-00	E-104	B-455	E-77	B-5338	E-85
B-2700	E-78	B38-0305-00	E-104	B-456	E-77	B-5340	E-80
B-2701	E-78	B38-0306-00	E-103, E-104	B-457	E-77	B-5341	E-85
B-2702	E-78	B38-0307-00	E-104	B-458	E-77	B-5342	E-80
B-2703	E-78	B38-0308-00	E-104	B-459	E-77	B-5351	E-85
B-2704	E-78	B38-0309-00	E-104	B-460	E-77	B-5352	E-85

ALPHA-NUMERIC INDEX BY CATALOG NUMBER (Continued)

Catalog Number	Page #	Catalog Number	Page #	Catalog Number	Page #	Catalog Number	Page #
B-5353	E-85	B-564	E-82	B-5943	E-80	B-7507	E-93
B-5359	E-90	B-5640	E-85	B-595	E-89	B-7508	E-93
B-5361	E-90	B-5642	E-80	B-596	E-89	B-7509	E-93
B-5362	E-90	B-5644	E-80	B-5961	E-84	B-7510	E-93
B-5363	E-90	B-5645	E-80	B-5963	E-84	B-7511	E-93
B-537	E-82	B-5652	E-80	B-5972	E-84	B-7512	E-93
B-538	E-82	B-5659	E-80	B-598	E-89	B-7513	E-93
B-5380	E-84	B-566	E-82	B-599	E-89	B-7514	E-93
B-5389	E-90	B-5660	E-83	B-5992	E-84	B-7515	E-93
B-539	E-82	B-5667	E-85	B-600	E-89	B-7520	E-93
B-5390	E-84	B-5668	E-80	B-6002	E-85	B-7521	E-93
B-540	E-82	B-567	E-82	B-6003	E-84	B-7522	E-93
B-541	E-82	B-5676	E-80	B-602	E-88	B-7523	E-93
B-5416	E-84	B-5677	E-85	B-6025	E-84	B-7528	E-93
B-5419	E-92	B-5679	E-80	B-603	E-88	B-7529	E-93
B-542	E-82	B-5680	E-80	B-604	E-88	B-7530	E-93
B-5428	E-85	B-5682	E-80	B-6046	E-80	B-7531	E-93
B-543	E-82	B-5684	E-80	B-6048	E-84	B-7588	E-94
B-5432	E-78	B-5686	E-80	B-605	E-88	B-7589	E-94
B-544	E-82	B-5688	E-80	B-6051	E-85	B-7590	E-94
B-545	E-82	B-569	E-82	B-6060	E-92	B-7591	E-94
B-546	E-82	B-5698	E-84	B-6061	E-92	B-7592	E-94
B-547	E-82	B-5699	E-84	B-6067	E-92	B-7593	E-94
B-5475	E-76	B-570	E-82	B-6072	E-92	B-7594	E-94
B-548	E-82	B-5702	E-85	B-6114	E-87	B-7595	E-94
B-549	E-82	B-5709	E-79	B-616	E-88	B-7596	E-94
B-550	E-82	B-571	E-82	B-6165	E-84	B-7597	E-94
B-551	E-82	B-572	E-82	B-617	E-88	B-7598	E-94
B-5513	E-84	B-5722	E-84	B-618	E-88	B-7599	E-94
B-5515	E-84	B-573	E-82	B-619	E-88	B-7600	E-94
B-5517	E-85	B-5732	E-84	B-620	E-88	B-7601	E-94
B-552	E-82	B-5734	E-84	B-6208	E-85	B-7602	E-94
B-553	E-82	B-5738	E-84	B-621	E-88	B-7603	E-94
B-555	E-82	B-574	E-82	B-622	E-88	B-7604	E-94
B-5555	E-84	B-5746	E-84	B-624	E-88	B-7605	E-94
B-5556	E-84	B-575	E-82	B-625-H	E-88	B-7606	E-94
B-556	E-82	B-5767	E-85	B-626-H	E-88	B-7607	E-94
B-5560	E-85	B-577	E-82	B-628	E-87	B-7608	E-94
B-5561	E-84	B-5777	E-84	B-629	E-87	B-7609	E-94
B-557	E-82	B-578	E-82	B-630	E-87	B-7610	E-94
B-5573	E-85	B-579	E-82	B-631	E-87	B-7611	E-94
B-5574	E-76	B-5803	E-84	B-644	E-87	B-7612	E-94
B-558	E-82	B-5807	E-84	B-645	E-87	B-7613	E-94
B-559	E-82	B-5820	E-84	B-646	E-87	B-7614	E-94
B-560	E-82	B-5821	E-84	B-647	E-87	B-7615	E-94
B-5604	E-85	B-5830	E-84	B-648	E-87	B-7616	E-94
B-561	E-82	B-5833	E-84	B-649	E-87	B-7617	E-94
B-5618	E-79	B-585	E-89	B-650	E-87	B-7618	E-94
B-562	E-82	B-5850	E-84	B-652	E-87	B-7619	E-94
B-5623	E-75	B-5857	E-84	B-653	E-87	B-7620	E-95
B-5624	E-75	B-586	E-89	B-654	E-87	B-7621	E-95
B-5625	E-75	B-587	E-89	B-6552	E-80	B-7622	E-95
B-5626	E-75	B-5877	E-84	B-6630	E-83	B-7623	E-95
B-5627	E-80	B-588	E-89	B-6766	E-85	B-7624	E-95
B-5629	E-80	B-588-S	E-89	B-6906	E-83	B-7625	E-95
B-563	E-82	B-589	E-89	B-7075	E-87	B-7626	E-95
B-5630	E-80	B-590	E-89	B-7146	E-87	B-7627	E-95
B-5631	E-80	B-5904	E-84	B-7192	E-88	B-7628	E-95
B-5632	E-80	B-591	E-89	B-7500	E-93	B-7629	E-95
B-5634	E-80	B-5910	E-92	B-7501	E-93	B-7630	E-95
B-5635	E-80	B-592	E-89	B-7502	E-93	B-7631	E-95
B-5636	E-80	B-593	E-89	B-7503	E-93	B-7632	E-95
B-5637	E-80	B-5935	E-84	B-7504	E-93	B-7633	E-95
B-5638	E-80	B-594	E-89	B-7505	E-93	B-7634	E-95
B-5639	E-80	B-5940	E-84	B-7506	E-93	B-7635	E-95

ALPHA-NUMERIC INDEX BY CATALOG NUMBER (Continued)

Catalog Number	Page #	Catalog Number	Page #	Catalog Number	Page #	Catalog Number	Page #
B-7636	E-95	B-7893	E-97	B-9253	E-92	BA16EZ10	B-42
B-7637	E-95	B-7894	E-97	BA10E10M	B-8	BA16EZ2	B-42
B-7638	E-95	B-7895	E-97	BA10E14M	B-8	BA16EZ6	B-42
B-7639	E-95	B-7896	E-97	BA10E38M	B-8	BA16EZ8	B-42
B-7640	E-95	B-7897	E-97	BA10E516	B-8	BA-200	E-105
B-7641	E-95	B-7898	E-97	BA10E6M	B-8	BA-201	E-105
B-7642	E-95	B-7899	E-97	BA10E8M	B-8	BA-202	E-105
B-7643	E-95	B-7900	E-97	BA10EF10	B-28	BA-203	E-105
B-7644	E-95	B-7901	E-97	BA10EF10M	B-28	BA-204	E-105
B-7645	E-95	B-7902	E-97	BA10EF6	B-28	BA-205	E-105
B-7646	E-95	B-7903	E-97	BA10EF6M	B-28	BA-207	E-105
B-7647	E-95	B-7904	E-97	BA10EF8	B-28	BA-208	E-105
B-7648	E-95	B-7905	E-97	BA10EF8M	B-28	BA-209	E-105
B-7649	E-95	B-7906	E-97	BA10EL10	B-33	BA-211	E-105
B-7650	E-95	B-7907	E-97	BA10EL10M	B-33	BA-212	E-105
B-7651	E-95	B-7908	E-97	BA10EL6	B-33	BA-213	E-105
B-7652	E-95	B-7909	E-97	BA10EL6M	B-33	BA-214	E-105
B-7653	E-95	B-7910	E-97	BA10EL8	B-33	BA-215	E-105
B-7654	E-95	B-7911	E-97	BA10EL8M	B-33	BA-240	E-105
B-7655	E-95	B-7912	E-97	BA10EZ10	B-42	BAT14V	N-24, N-79
B-7656	E-95	B-7913	E-97	BA10EZ6	B-42	BAT18V	N-10, N-20, N-73
B-7657	E-95	B-7914	E-97	BA10EZ8	B-42	BAT18VLI	N-9, N-21, N-72
B-7658	E-95	B-7915	E-97	BA14E10M	B-8	BB024L	E-52
B-7659	E-95	B-7916	E-97	BA14E14M	B-8	BB024L6T14	E-54
B-7708	E-96	B-7917	E-97	BA14E38	B-8	BB024L9T14	E-54
B-7709	E-96	B-7918	E-97	BA14E4M	B-8	BB048L	E-52
B-7710	E-96	B-7919	E-97	BA14E516M	B-8	BB048L6T14	E-54
B-7711	E-96	B-7920	E-97	BA14E6L	B-33	BB048L9T14	E-54
B-7712	E-96	B-7921	E-97	BA14E6LM	B-33	BB067L	E-52
B-7713	E-96	B-7922	E-97	BA14E6M	B-8	BB067L6T14	E-54
B-7714	E-96	B-7923	E-97	BA14E8M	B-8	BB067L9T14	E-54
B-7715	E-96	B-8011	E-85	BA14EF10	B-28	BB077L	E-52
B-7716	E-96	B-8027	E-85	BA14EF10M	B-28	BB154L	E-52
B-7717	E-96	B-8165	E-90	BA14EF2	B-28	BB226L	E-52
B-7718	E-96	B-8214	E-85	BA14EF6	B-28	BB300L	E-52
B-7719	E-96	B-8294	E-85	BA14EF8	B-28	BBB-14210A	E-68
B-7720	E-96	B-8359	E-92	BA14EF8M	B-28	BBB-14224B	E-68
B-7721	E-96	B-8379	E-88	BA14EL10	B-33	BBB-14410C	E-68
B-7722	E-96	B-8381	E-88	BA14EL10M	B-33	BBB-14410D	E-68
B-7723	E-96	B-8402	E-81	BA14EL8	B-33	BBB-14412E	E-68
B-7724	E-96	B-8403	E-81	BA14EL8M	B-33	BBB-14412F	E-68
B-7725	E-96	B-8410	E-88	BA14EZ10	B-42	BBB-14416G	E-68
B-7726	E-96	B-8413	E-88	BA14EZ2	B-42	BBB-14416H	E-68
B-7727	E-96	B-8414	E-81	BA14EZ6	B-42	BBB-14420J	E-68
B-7728	E-96	B-8415	E-81	BA14EZ8	B-42	BBB412UD	E-68
B-7729	E-96	B-8423	E-88	BA16E10M	B-8	BBB-424-UD	E-68
B-7730	E-96	B-8428	E-85	BA16E14M	B-8	BBB-HR19	E-68
B-7731	E-96	B-8434	E-82	BA16E38M	B-8	BBB-VR36	E-68
B-7732	E-96	B-8435	E-82	BA16E4M	B-8	BC25	H-69
B-7733	E-96	B-8441	E-82	BA16E6M	B-8	BC28	H-69
B-7734	E-96	B-8442	E-82	BA16E8M	B-8	BC2C	H-69
B-7735	E-96	B-8451	E-85	BA16EF10	B-28	BCC1000CUAL	N-80
B-7736	E-96	B-8452	E-82	BA16EF10M	B-28	BCCBAT12V	N-80
B-7737	E-96	B-8454	E-82	BA16EF2	B-28	BCCCASE	N-80
B-7738	E-96	B-8461	E-85	BA16EF2M	B-28	BCCCHGR	N-80
B-7739	E-96	B-8512	E-90	BA16EF6	B-28	BCH1211	N-117, N-119
B-7884	E-97	B-8718	E-90	BA16EF6M	B-28	BCM5	N-117, N-119
B-7885	E-97	B-8726	E-85	BA16EF8	B-28	BCT/PATCHGR-LIDC	N-76
B-7886	E-97	B-8802	E-85	BA16EF8M	B-28	BCT/PATDCCCHGR	N-10, N-20, N-71
B-7887	E-97	B-8833	E-89	BA16EL10	B-33	BD12	E-55
B-7888	E-97	B-8882	E-80	BA16EL10M	B-33	BD12N	E-55
B-7889	E-97	B-9021	E-89	BA16EL6	B-33	BD18	E-55
B-7890	E-97	B-9029	E-90	BA16EL6M	B-33	BD18N	E-55
B-7891	E-97	B-9233	E-89	BA16EL8	B-33	BD24	E-55
B-7892	E-97	B-9233-S	E-89	BA16EL8M	B-33	BD24N	E-55

ALPHA-NUMERIC INDEX BY CATALOG NUMBER (Continued)

Catalog Number	Page #	Catalog Number	Page #	Catalog Number	Page #	Catalog Number	Page #
BD6T14	E-54	BDB-212-500-2	A-52	BDBMHC145003	A-48	BHA12E	N-120
BD9T14	E-54	BDB-212-500-3	A-52	BDBMHC162/01	A-48	BHA1E34R	N-120
BDA-11-2/0-1	A-53	BDB-22-2/0-1	A-53	BDBMHC162/02	A-48	BHA34E12R	N-120
BDA-112-350	A-51	BDB-22-2/0-2	A-53	BDBMHC162/03	A-48	BHSG1100	F-15
BDA-11-500	A-51	BDB-22-2/0-3	A-53	BDBMHC1625001	A-48	BIBD2/0-10	A-58
BDA-14-2/0-1	A-53	BDB-22-350-1	A-53	BDBMHC1625002	A-48	BIBD2/010MT	A-59
BDA-16-350	A-51	BDB-22-350-2	A-53	BDBMHC1625003	A-48	BIBD2/0-12	A-58
BDA-16-500	A-51	BDB-22-350-3	A-53	BDBMHC222/01	A-48	BIBD2/012MT	A-59
BDA-212-500	A-51	BDB-22-500-1	A-53	BDBMHC222/02	A-48	BIBD2/0-14	A-58
BDA-22-350	A-51	BDB-22-500-2	A-53	BDBMHC222/03	A-48	BIBD2/0-2	A-58
BDA-22-500	A-51	BDB-22-500-3	A-53	BDBMHC262/01	A-48	BIBD2/0-3	A-58
BDA-24-500	A-51	BDB-24-500-1	A-52	BDBMHC262/02	A-48	BIBD2/0-4	A-58
BDA-26-350	A-51	BDB-24-500-2	A-52	BDBMHC262/03	A-48	BIBD2/04MT	A-59
BDA-26-500	A-51	BDB-24-500-3	A-52	BDBMHCCOVER	A-48	BIBD2/0-5	A-58
BDALHC112350	A-49	BDB-26-2/0-1	A-52	BDBSHCCOVER	A-47	BIBD2/0-6	A-58
BDALHC11500	A-49	BDB-26-2/0-2	A-52	BDC-11-2/0-1	A-53	BIBD2/06MT	A-59
BDALHC16350	A-49	BDB-26-2/0-3	A-52	BDC-14-2/0-1	A-53	BIBD2/0-8	A-58
BDALHC16500	A-49	BDB-26-350-1	A-52	BDCSHC112/01	A-47	BIBD2/08MT	A-59
BDALHC1212500	A-49	BDB-26-350-2	A-52	BDCSHC142/01	A-47	BIBD250-10	A-58
BDALHC22350	A-49	BDB-26-350-3	A-52	BDESS750-3	K-65	BIBD25010MT	A-59
BDALHC22500	A-49	BDB-26-500-1	A-52	BDESS750-4	K-65	BIBD250-12	A-58
BDALHC22600	A-50	BDB-26-500-2	A-52	BDESS750-5	K-65	BIBD25012MT	A-59
BDALHC24500	A-50	BDB-26-500-3	A-52	BDESS750-6	K-65	BIBD250-14	A-58
BDALHC26350	A-49	BDBLHC1123501	A-49	BDESS750-7	K-65	BIBD250-2	A-58
BDALHC26500	A-50	BDBLHC1123502	A-49	BDESS750-8	K-65	BIBD250-3	A-58
BDALHCEB	A-50	BDBLHC1123503	A-49	BDSC1	F-5	BIBD250-4	A-58
BDAMHC112/0	A-48	BDBLHC115001	A-49	BDSC5	F-5	BIBD2504MT	A-59
BDAMHC11350	A-48	BDBLHC115002	A-49	BDT1	E-41	BIBD250-5	A-58
BDAMHC14500	A-48	BDBLHC115003	A-49	BDTIBB	E-42	BIBD250-6	A-58
BDAMHC162/0	A-48	BDBLHC163501	A-49	BE12	E-55	BIBD2506MT	A-59
BDAMHC162500	A-48	BDBLHC163502	A-49	BE12N	E-55	BIBD250-8	A-58
BDAMHC222/0	A-48	BDBLHC163503	A-49	BE18	E-55	BIBD2508MT	A-59
BDAMHC262/0	A-48	BDBLHC165001	A-49	BE18N	E-55	BIBD350-10	A-58
BDAMHCEB	A-48	BDBLHC165002	A-49	BE24	E-55	BIBD35010MT	A-59
BDASHC112/01	A-47	BDBLHC165003	A-49	BE24N	E-55	BIBD350-12	A-58
BDASHC142/01	A-47	BDBLHC2125001	A-49	BEB122	N-121	BIBD35012MT	A-59
BDASHCEB	A-47	BDBLHC2125002	A-49	BEB122EMT	N-121	BIBD350-14	A-58
BDB-11-2/0-1	A-53	BDBLHC2125003	A-49	BEB122PVC	N-121	BIBD350-2	A-58
BDB-11-2/0-2	A-53	BDBLHC223501	A-49	BEB122RIG	N-121	BIBD350-3	A-58
BDB-11-2/0-3	A-53	BDBLHC223502	A-49	BEBSHOECASE	N-121	BIBD350-4	A-58
BDB-112-350-1	A-52	BDBLHC223503	A-49	BECBSD	N-68	BIBD3504MT	A-59
BDB-112-350-2	A-52	BDBLHC225001	A-49	BECNVSD	N-68	BIBD350-5	A-58
BDB-112-350-3	A-52	BDBLHC225002	A-49	BF12	E-55	BIBD350-6	A-58
BDB-11-350-1	A-53	BDBLHC225003	A-49	BF12N	E-55	BIBD3506MT	A-59
BDB-11-350-2	A-53	BDBLHC226001	A-50	BF18	E-55	BIBD350-8	A-58
BDB-11-350-3	A-53	BDBLHC226002	A-50	BF18N	E-55	BIBD3508MT	A-59
BDB-11-500-1	A-53	BDBLHC226003	A-50	BF24	E-55	BIBD4-2	A-58
BDB-11-500-2	A-53	BDBLHC245001	A-50	BF24N	E-55	BIBD4-3	A-58
BDB-11-500-3	A-53	BDBLHC245002	A-50	BG12	E-55	BIBD4-4	A-58
BDB-14-500-1	A-52	BDBLHC245003	A-50	BG12N	E-55	BIBD4-5	A-58
BDB-14-500-2	A-52	BDBLHC263501	A-49	BG18	E-55	BIBD4-6	A-58
BDB-14-500-3	A-52	BDBLHC263502	A-49	BG18N	E-55	BIBD4-8	A-58
BDB-16-2/0-1	A-52	BDBLHC263503	A-49	BG24	E-55	BIBD600-10	A-58
BDB-16-2/0-2	A-52	BDBLHC265001	A-50	BG24N	E-55	BIBD60010MT	A-59
BDB-16-2/0-3	A-52	BDBLHC265002	A-50	BGBL-1/0	A-13	BIBD600-12	A-58
BDB-162-500-1	A-52	BDBLHC265003	A-50	BGBL-250	A-13	BIBD60012MT	A-59
BDB-162-500-2	A-52	BDBLHCCOVER	A-50	BGBL-4	A-13	BIBD600-14	A-58
BDB-162-500-3	A-52	BDBMHC112/01	A-48	BGBL4SS	A-13	BIBD600-2	A-58
BDB-16-350-1	A-52	BDBMHC112/02	A-48	BGM3050	E-100	BIBD600-3	A-58
BDB-16-350-2	A-52	BDBMHC112/03	A-48	BGM3100	E-100	BIBD600-4	A-58
BDB-16-350-3	A-52	BDBMHC113501	A-48	BGM640044	E-100	BIBD6004MT	A-59
BDB-16-500-1	A-52	BDBMHC113502	A-48	BGM64006	E-100	BIBD600-5	A-58
BDB-16-500-2	A-52	BDBMHC113503	A-48	BGM640066	E-100	BIBD600-6	A-58
BDB-16-500-3	A-52	BDBMHC145001	A-48	BGM640068	E-100	BIBD6006MT	A-59
BDB-212-500-1	A-52	BDBMHC145002	A-48	BH864	N-117, N-119	BIBD600-8	A-58

ALPHA-NUMERIC INDEX BY CATALOG NUMBER (Continued)

Catalog Number	Page #	Catalog Number	Page #	Catalog Number	Page #	Catalog Number	Page #
BIBD6008MT	A-59	BIBS60012MT	A-59	BKD3500	N-112	BPD-4-350	K-75
BIBD750-10	A-58	BIBS600-14	A-57	BKD4000	N-112	BPD-4-500	K-75
BIBD750-12	A-58	BIBS600-3	A-57	BKD500B	N-110	BPD-6-350	K-75
BIBD750-14	A-58	BIBS600-4	A-57	BKD750B	N-110	BPD-6-500	K-75
BIBD750-2	A-58	BIBS6004MT	A-59	BKLP2	N-116	BPD-8-350	K-75
BIBD750-3	A-58	BIBS600-5	A-57	BKLP2K1	N-116	BPD-8-500	K-75
BIBD750-4	A-58	BIBS600-6	A-57	BKLP6	N-115	BPF65	N-119
BIBD750-6	A-58	BIBS6006MT	A-59	BKOF540	N-119	BPH20	N-117, N-118
BIBD750-8	A-58	BIBS600-8	A-57	BKOH2540	N-112	BPTE14-750	A-62
BIBS2/0-10	A-57	BIBS6008MT	A-59	BKOH520A	N-117	BPTE20-1000	A-62
BIBS2/010MT	A-59	BIBS750-10	A-57	BKOH540A	N-118	BPTE22-750	A-62
BIBS2/0-12	A-57	BIBS750-12	A-57	BKOM152	N-111	BPTE26-500	A-62
BIBS2/012MT	A-59	BIBS750-14	A-57	BKOM50125	N-110	BS10	B-47
BIBS2/0-14	A-57	BIBS750-3	A-57	BKOR14	N-114	BS14	B-47
BIBS2/0-3	A-57	BIBS750-4	A-57	BKOR152	N-114	BS16	B-47
BIBS2/0-4	A-57	BIBS750-6	A-57	BKOR50	N-114	BS-2006	E-86
BIBS2/04MT	A-59	BIBS750-8	A-57	BKOR520	N-114	BS-2007	E-86
BIBS2/0-5	A-57	BIC2-4-750	K-75	BKOR75125	N-114	BS-2008	E-86
BIBS2/0-6	A-57	BIC2-6-750	K-75	BKOS520	N-116	BS-2009	E-86
BIBS2/06MT	A-59	BIC2-8-750	K-75	BKOS5290	N-115	BS-2010	E-86
BIBS2/0-8	A-57	BIC-4-350	K-75	BKOW520	N-113	BS-2011	E-86
BIBS2/08MT	A-59	BIC-4-500	K-75	BKP1000B	N-110	BS-2012	E-86
BIBS250-10	A-57	BIC-6-350	K-75	BKP1250B	N-110	BS-2013	E-86
BIBS25010MT	A-59	BIC-6-500	K-75	BKP1500B	N-111	BS-2014	E-86
BIBS250-12	A-57	BIC-8-350	K-75	BKP2000B	N-111	BS-2015	E-86
BIBS25012MT	A-59	BIC-8-500	K-75	BKP2500	N-112	BS-2016	E-86
BIBS250-14	A-57	BIPC1/0-2	A-39	BKP3000	N-112	BS-2017	E-86
BIBS250-3	A-57	BIPC350-350	A-39	BKP3500	N-112	BS-2018	E-86
BIBS250-4	A-57	BIPC350-4/0	A-39	BKP4000	N-112	BS-2019	E-86
BIBS2504MT	A-59	BIPC4/0-1/0	A-39	BKP500B	N-110	BS-2020	E-86
BIBS250-5	A-57	BIPC4/0-6	A-39	BKP750B	N-110	BS-2021	E-86
BIBS250-6	A-57	BIPC500-4/0	A-39	BKPR7520	N-115	BS-2024	E-86
BIBS2506MT	A-59	BISR1/0	A-56	BKPR7540	N-117	BS-2025	E-86
BIBS250-8	A-57	BISR1-DB	A-36	BKPS50	N-115	BS-2026	E-86
BIBS2508MT	A-59	BISR2	A-56	BKS752B	N-110	BS-2027	E-86
BIBS350-10	A-57	BISR250	A-56	BKSA50	N-115	BS-2028	E-86
BIBS35010MT	A-59	BISR250-DB	A-36	BKSB50B	N-110	BS-2029	E-86
BIBS350-12	A-57	BISR3/0-DB	A-36	BKW52	N-113	BS-2030	E-86
BIBS35012MT	A-59	BISR350	A-56	BMV-BCH-MT	N-59	BS-2031	E-86
BIBS350-14	A-57	BISR4-DB	A-36	BP10PADKIT	N-88, N-89	BS-2032	E-86
BIBS3502DB	A-34	BISR500	A-56	BPC1000	F-12	BS-2033	E-86
BIBS350-3	A-57	BIT2/0	A-56	BPC1125	F-12	BS-2034	E-86
BIBS3503DB	A-34	BIT250	A-56	BPC1187	F-12	BS-2068	E-86
BIBS350-4	A-57	BIT350	A-56	BPC1250	F-12	BS-2069	E-86
BIBS3504DB	A-34	BIT4	A-56	BPC1375	F-12	BS-2070	E-86
BIBS3504MT	A-59	BIT600	A-56	BPC1500	F-12	BS-2105	E-86
BIBS350-5	A-57	BIT750	A-56	BPC1687	F-12	BS-2106	E-86
BIBS3505DB	A-34	BITO2/0	A-56	BPC1875	F-12	BS-2107	E-86
BIBS350-6	A-57	BITO250	A-56	BPC2000	F-12	BS-2108	E-86
BIBS3506DB	A-34	BITO350	A-56	BPC2375	F-12	BS-2109	E-86
BIBS3506MT	A-59	BITO4	A-56	BPC2500	F-12	BS-2110	E-86
BIBS350-8	A-57	BITO600	A-56	BPC312	F-12	BSC1000	F-11
BIBS3508MT	A-59	BITO750	A-56	BPC3500	F-12	BSC1125	F-11
BIBS4-3	A-57	BK88001	N-111	BPC375	F-12	BSC1375	F-11
BIBS4-4	A-57	BK88004	N-110	BPC437	F-12	BSC1500	F-11
BIBS4-5	A-57	BK88007	N-113	BPC500	F-12	BSC1875	F-11
BIBS4-6	A-57	BK88008	N-112	BPC562	F-12	BSC2000	F-11
BIBS4-8	A-57	BK88020	N-114, N-116	BPC625	F-12	BSC2375	F-11
BIBS5003DB	A-34	BKC3540	N-117, N-119	BPC687	F-12	BSC2500	F-11
BIBS5004DB	A-34	BKD1000B	N-110	BPC750	F-12	BSC25002.5	F-11
BIBS5005DB	A-34	BKD1250B	N-110	BPC843	F-12	BSC2H	N-122
BIBS5006DB	A-34	BKD1500B	N-111	BPC875	F-12	BSC2H1C2DEBP	N-122
BIBS600-10	A-57	BKD2000B	N-111	BPD2-4-750	K-75	BSC2H2A1B1FEBP	N-122
BIBS60010MT	A-59	BKD2500	N-112	BPD2-6-750	K-75	BSC2H2C1DEBP	N-122
BIBS600-12	A-57	BKD3000	N-112	BPD2-8-750	K-75	BSC2H3A2B	N-122

ALPHA-NUMERIC INDEX BY CATALOG NUMBER (Continued)

Catalog Number	Page #	Catalog Number	Page #	Catalog Number	Page #	Catalog Number	Page #
BSC2H5A	N-122	BYNA32RT15HT	I-23	BYNA56RHT	I-22	C-22LH-2	E-47
BSC2H5B	N-122	BYNA32RTACCC	I-50	BYNA56RT15HHT	I-18, I-19	C-22LH-3	E-47
BSC2L	N-123	BYNA32RTHT	I-23	BYNA56RT15HT	I-23	C-4	E-43
BSC2L1C2DEBP	N-123	BYNA34R15HHT	I-16, I-17	BYNA56RTHT	I-23	C-4JA	E-45
BSC2L2C1DEBP	N-123	BYNA34R15HT	I-22	BYNA56R15HHT	I-16, I-17	C-4JPT	E-43
BSC2L3A2B	N-123	BYNA34RHT	I-22	BYNA58R15HT	I-22	C-4LH-1	E-47
BSC2L5A	N-123	BYNA34RT15HHT	I-18, I-19	BYNA58RHT	I-22	C-4LH-2	E-47
BSC2L5B	N-123	BYNA34RT15HT	I-23	BYNA58RT15HHT	I-18, I-19	C-4LH-3	E-47
BSC687	F-11	BYNA34RTHT	I-23	BYNA58RT15HT	I-23	C-5	E-43
BSCWS40	N-122	BYNA36R15HHT	I-16, I-17	BYNA58RTHT	I-23	C-6	E-46
BSCWS80	N-122	BYNA36R15HT	I-22	BYNA590MRT15ACCC	I-50	C-61	E-46
BSD2050	E-62	BYNA36RHT	I-22	BYNA590MRT15HACCC	I-48	C-66	E-46
BSD2050N	E-62	BYNA36RT15ACCC	I-50	BYNA590MRTACCC	I-50	C-6D	E-46
BSD2050Y	E-62	BYNA36RT15HACCC	I-47	BYNA59R15HHT	I-16, I-17	C-7	E-46
BSSBC750-2-1	K-64	BYNA36RT15HHT	I-18, I-19	BYNA59R15HT	I-22	C-8	E-43
BSSBC750-3	K-65	BYNA36RT15HT	I-23	BYNA59RHT	I-22	CASEWDIES	N-66
BSSBC750-3-1	K-64	BYNA36RTACCC	I-50	BYNA59RT15HHT	I-18, I-19	CCD	H-26
BSSBC750-4	K-65	BYNA36RTHT	I-23	BYNA59RT15HT	I-23	CCFBG-FR	C-135
BSSBC750-4-1	K-64	BYNA39R15HHT	I-16, I-17	BYNA59RTHT	I-23	CCFD-FR	C-131, C-135
BSSBC750-4-2	K-64	BYNA39R15HT	I-22	BYNA760MRT15ACCC	I-50	CCFDXFR	C-131
BSSBC750-5	K-65	BYNA39RHT	I-22	BYNA760MRT15HACCC	I-48	CCFDX-FR	C-135
BSSBC750-6	K-65	BYNA39RT15ACCC	I-50	BYNA760MRTACCC	I-50	CCFN-FR	C-131, C-135
BSSBC750-6-2	K-64	BYNA39RT15HACCC	I-47	BYNS32RHT	I-24	CCFO-FR	C-131, C-135
BSSBC750-7	K-65	BYNA39RT15HHT	I-18, I-19	BYNS32RTHT	I-25	CCFR-FR	C-131, C-135
BSSBC750-8	K-65	BYNA39RT15HT	I-23	BYNS34RHT	I-24	CCN	H-26
BSSI-20	K-71	BYNA39RTACCC	I-50	BYNS34RTHT	I-25	CCNL	H-26
BSSI-500	K-71	BYNA39RTHT	I-23	BYNS36RHT	I-24	CCO	H-26
BSSI-500L	K-71	BYNA43R15HHT	I-16, I-17	BYNS36RTHT	I-25	CFAD	C-155
BTW150750	N-70	BYNA43R15HT	I-22	BYNS39RHT	I-24	CFAD-FR	C-155
BTW1575F12	N-70	BYNA43RHT	I-22	BYNS39RTHT	I-25	CFAN	C-155
BTW30150	N-70	BYNA43RT15ACCC	I-50	BYNS43RHT	I-24	CFAN-FR	C-155
BTWTC500	K-71	BYNA43RT15HACCC	I-47	BYNS43RTHT	I-25	CFANL	C-155
BULF10HS	B-83	BYNA43RT15HHT	I-18, I-19	BYNS451RHT	I-24	CFANL-FR	C-155
BULF10P	B-82	BYNA43RT15HT	I-23	BYNS451RTHT	I-25	CFAO-FR	C-155
BULF14HS	B-83	BYNA43RTACCC	I-50	BYNS49RHT	I-24	CFAR	C-155
BULF14N	B-82	BYNA43RTHT	I-23	BYNS49RTHT	I-25	CFAR-FR	C-155
BULF14NG	B-83	BYNA451R15HHT	I-16, I-17	BYNS52RHT	I-24	CFBG-FR	C-135
BULF14P	B-82	BYNA451R15HT	I-22	BYNS52RTHT	I-25	CFD-FR	C-131, C-135
BULF18HS	B-83	BYNA451RHT	I-22	BYNS56RHT	I-24	CFN-FR	C-131, C-135
BULF18N	B-82	BYNA451RT15ACCC	I-50	BYNS56RTHT	I-25	CFO-FR	C-131, C-135
BULF18NG	B-83	BYNA451RT15HACCC	I-47	BYNS58RHT	I-24	CFR-FR	C-131, C-135
BULF18P	B-82	BYNA451RT15HHT	I-18, I-19	BYNS58RTHT	I-25	CH10C	G-19
BULM10P	B-80	BYNA451RT15HT	I-23	BYNS59RHT	I-24	CH10M	G-19
BULM14HS	B-81	BYNA451RTACCC	I-50	BYNS59RTHT	I-25	CH11C	G-19
BULM14N	B-80	BYNA451RTHT	I-23	C-11B	E-43	CH11M	G-19
BULM14NG	B-81	BYNA49R15HHT	I-16, I-17	C-11CSH-1	E-47	CH12C	G-19
BULM14P	B-80	BYNA49R15HT	I-22	C-11CSH-2	E-47	CH12M	G-19
BULM18HS	B-81	BYNA49RHT	I-22	C-11CSH-3	E-47	CH14C	G-19
BULM18N	B-80	BYNA49RT15ACCC	I-50	C11CSLH12	E-47	CH14M	G-19
BULM18NG	B-81	BYNA49RT15HACCC	I-48	C-11D	E-43	CH16C	G-19
BULM18P	B-80	BYNA49RT15HHT	I-18, I-19	C11HD4/0DB	E-45	CH16M	G-19
BWB680AG	E-70	BYNA49RT15HT	I-23	C-11JA	E-45	CH18C	G-19
BWB680IG	E-70	BYNA49RTACCC	I-50	C-11JPT	E-43	CH18M	G-19
BWTE21-1000	A-61	BYNA49RTHT	I-23	C11K16D	E-44	CH24C	G-19
BWTE21-500	A-61	BYNA52R15HHT	I-16, I-17	C11K17D	E-44	CH24L	G-19
BWTE21-750	A-61	BYNA52R15HT	I-22	C-11LH-1	E-47	CH2C	G-19
BYNA245MRT15ACCC	I-50	BYNA52RHT	I-22	C-11LH-2	E-47	CH2M	G-19
BYNA245MRT15HACCC	I-47	BYNA52RT15ACCC	I-50	C-11LH-3	E-47	CH3C	G-19
BYNA245MRTACCC	I-50	BYNA52RT15HACCC	I-48	C-11N	E-43	CH3M	G-19
BYNA32R15HHT	I-16, I-17	BYNA52RT15HHT	I-18, I-19	C-22	E-43	CH4C	G-19
BYNA32R15HT	I-22	BYNA52RT15HT	I-23	C-22D	E-43	CH4M	G-19
BYNA32RHT	I-22	BYNA52RTACCC	I-50	C22HD4/0DB	E-45	CH5C	G-19
BYNA32RT15ACCC	I-50	BYNA52RTHT	I-23	C-22JA	E-45	CH5M	G-19
BYNA32RT15HACCC	I-47	BYNA56R15HHT	I-16, I-17	C-22JPT	E-43	CH6C	G-19
BYNA32RT15HHT	I-18, I-19	BYNA56R15HT	I-22	C-22LH-1	E-47	CH6M	G-19

ALPHA-NUMERIC INDEX BY CATALOG NUMBER (Continued)

Catalog Number	Page #	Catalog Number	Page #	Catalog Number	Page #	Catalog Number	Page #
CH7C	G-19	CT110400SSBL0	G-14	CT175400Q	G-5	CT250800RQ0	G-10
CH7M	G-19	CT110500SSBC	G-14	CT175400Q0UG	G-8	CT30125C	G-5, G-6
CH8C	G-19	CT110500SSBC0	G-14	CT175500Q	G-7	CT30125C0	G-6
CH8M	G-19	CT110500SSBL	G-14	CT175500Q0	G-7	CT30125C00	G-5
CH9C	G-19	CT110500SSBL0	G-14	CT175600Q	G-5, G-7	CT30125C0UG	G-8
CH9M	G-19	CT110600SSBC	G-14	CT175600Q0	G-7	CT30125CUG	G-8
CL1/0-14TN	A-14, E-31	CT110600SSBC0	G-14	CT175600Q00	G-5	CT30125M	G-5, G-6
CL250-516TN	A-14, E-31	CT110600SSBL	G-14	CT175600Q0UG	G-8	CT30125M0	G-6
CL3/0-516TN	A-14, E-31	CT110600SSBL0	G-14	CT175600QUG	G-8	CT30125M00	G-5
CL50-1	A-14, E-31	CT110800SSBC	G-14	CT175900Q	G-5, G-7	CT30125MH8C	G-12
CL50-1TN	A-14, E-31	CT110800SSBC0	G-14	CT175900Q0	G-7	CT30125MH8C0	G-12
CL50-1TNBULK	E-31	CT110800SSBL	G-14	CT175900Q00	G-5	CT30125MH8M	G-12
CM2829P	K-35	CT110800SSBL0	G-14	CT175900Q0UG	G-8	CT30125MUG	G-8
CM2929P	K-35	CT120200D	G-7	CT18075C	G-5, G-6	CT40137SSBC	G-13
CM29L	K-35	CT120200D0	G-7	CT18075C0	G-6	CT40137SSBC0	G-13
CM3029P	K-35	CT120200L	G-7	CT18075C00	G-5	CT40137SSBM	G-13
CM3229P	K-35	CT120200L0	G-7	CT18075C0UG	G-8	CT40137SSBM0	G-13
CM3429P	K-35	CT120200L0UG	G-8	CT18075CUG	G-8	CT40200C	G-6
CM3629P	K-35	CT120300D	G-7	CT18075FLC	G-11	CT40200C0	G-6
CP2525	H-13	CT120300D0	G-7	CT18075IDC	G-5, G-11	CT40200CUG	G-8
CP2626	H-13	CT120300L	G-7	CT18075M	G-5, G-6	CT40200M	G-6
CP26A26A	H-11	CT120300L0	G-7	CT18075M0	G-6	CT40200M0	G-6
CP27A27A	H-11	CT120300SSBC	G-14	CT18075M00	G-5	CT40200MUG	G-8
CP2828	H-13	CT120300SSBC0	G-14	CT18075M0UG	G-8	CT40200SSBC	G-13
CP28A28A	H-11	CT120300SSBL	G-14	CT18075MH4C	G-12	CT40200SSBC0	G-13
CP2929	H-13	CT120300SSBL0	G-14	CT18075MH4C0	G-12	CT40200SSBD	G-13
CP29A29A	H-11	CT120350SSBC	G-14	CT18075MH4M	G-12	CT40200SSBD0	G-13
CP2C2C	H-13	CT120350SSBC0	G-14	CT18075MUG	G-8	CT40300C	G-6
CP30A30A	H-11	CT120350SSBL	G-14	CT18100SSBC	G-13	CT40300C0	G-6
CP31A31A	H-11	CT120350SSBL0	G-14	CT18100SSBC0	G-13	CT40300M	G-6
CP32A32A	H-11	CT120400C0UG	G-8	CT18100SSBM	G-13	CT40300M0	G-6
CP3434	H-13	CT120400D	G-5, G-7	CT18100SSBM0	G-13	CT40300SSBC	G-13
CP34A34A	H-11	CT120400D0	G-7	CT18125C	G-6	CT40300SSBC0	G-13
CP37A37A	H-11	CT120400D00	G-5	CT18125C0	G-6	CT40300SSBD	G-13
CPB10	A-45	CT120400L	G-5, G-7	CT18125M	G-6	CT40300SSBD0	G-13
CPB12	A-45	CT120400L0	G-7	CT18125M0	G-6	CT40400C	G-6
CPB14	A-45	CT120400L00	G-5	CT18200C	G-6	CT40400C0	G-6
CPB16-5/8	A-45	CT120400L0UG	G-8	CT18200C0	G-6	CT40400C0UG	G-8
CPB21-1/4	A-45	CT120400LUG	G-8	CT18200C0UG	G-8	CT40400M	G-6
CPB6	A-45	CT120400MH14D	G-12	CT18200M	G-6	CT40400M0	G-6
CPB8	A-45	CT120400MH14D0	G-12	CT18200M0	G-6	CT40400SSBC	G-13
CPT10	A-45	CT120400MH14L	G-12	CT18200MUG	G-8	CT40400SSBC0	G-13
CPT12	A-45	CT120400MH14L0	G-12	CT18200SSBC	G-13	CT40400SSBD	G-13
CPT16	A-45	CT120400SSBC	G-14	CT18200SSBC0	G-13	CT40400SSBD0	G-13
CPT6	A-45	CT120400SSBC0	G-14	CT18200SSBM	G-13	CT50137EPRC	G-10
CPT8	A-45	CT120400SSBL	G-14	CT18200SSBM0	G-13	CT50137EPRC0	G-10
CT110200SSBB	G-14	CT120400SSBL0	G-14	CT2501000Q	G-7	CT50137RC	G-10
CT110200SSBB0	G-14	CT120500CUG	G-8	CT2501000Q0	G-7	CT50137RC0	G-10
CT110200SSBC	G-14	CT120500D0UG	G-8	CT2501000RQ	G-10	CT50175C	G-5, G-6
CT110200SSBC0	G-14	CT120500SSBC	G-14	CT2501000RQ0	G-10	CT50175C0	G-6
CT110300SSBC	G-14	CT120500SSBC0	G-14	CT2501200Q	G-7	CT50175C00	G-5
CT110300SSBC0	G-14	CT120500SSBL	G-14	CT2501200Q0	G-7	CT50175C0UG	G-8
CT110300SSBL	G-14	CT120500SSBL0	G-14	CT2501200RQ0	G-10	CT50175CUG	G-8
CT110300SSBL0	G-14	CT120800L	G-7	CT250200RQ	G-10	CT50175ID2L	G-5, G-11
CT110325SSBB	G-14	CT120800L0	G-7	CT250200RQ0	G-10	CT50175ID3L	G-5, G-11
CT110325SSBB0	G-14	CT120900D	G-5	CT250500RQ	G-10	CT50175IDC	G-5, G-11
CT110325SSBC	G-14	CT120900D00	G-5	CT250500RQ0	G-10	CT50175M	G-5, G-6
CT110325SSBC0	G-14	CT120900L	G-5	CT250600Q	G-7	CT50175M0	G-6
CT110350SSBC	G-14	CT120900L00	G-5	CT250600Q0	G-7	CT50175M00	G-5
CT110350SSBC0	G-14	CT120900LUG	G-8	CT250600RQ	G-10	CT50175M0UG	G-8
CT110350SSBL	G-14	CT1751100Q	G-7	CT250600RQ0	G-10	CT50175MH10C	G-12
CT110350SSBL0	G-14	CT1751100Q0	G-7	CT250800Q	G-7	CT50175MH10C0	G-12
CT110400SSBC	G-14	CT1751100Q0UG	G-8	CT250800Q0	G-7	CT50175MH10C0UG	G-9
CT110400SSBC0	G-14	CT1751100QUG	G-8	CT250800Q00UG	G-8	CT50175MH10CUG	G-9
CT110400SSBL	G-14	CT1751400QUG	G-8	CT250800RQ	G-10	CT50175MH10M	G-12

ALPHA-NUMERIC INDEX BY CATALOG NUMBER (Continued)

Catalog Number	Page #	Catalog Number	Page #	Catalog Number	Page #	Catalog Number	Page #
CT50175MH10M0	G-12	CTB125S2C	G-18	CTSS250800FC304L	G-22	CTSS675600FC316Q	G-23
CT50175MUG	G-8	CTB125S4C	G-18	CTSS250800FC316L	G-23	CTSS675600PC304Q	G-24
CT50175RC	G-10	CTB150AA4C	G-18	CTSS250800PC304L	G-24	CTSS675600PC316Q	G-25
CT50175RC0	G-10	CTB150RA4B	G-18	CTSS250800PC316L	G-25	CTSS675700FC304Q	G-22
CT50175SSBC	G-13	CTB150RA4C	G-18	CTSS450200FC304L	G-22	CTSS675700FC316Q	G-23
CT50175SSBC0	G-13	CTB150S4B	G-18	CTSS450200FC316L	G-23	CTSS675700PC304Q	G-24
CT50175SSBD	G-13	CTH30200C	G-15	CTSS450200PC304L	G-24	CTSS675700PC316Q	G-25
CT50175SSBD0	G-13	CTH50175C	G-15	CTSS450200PC316L	G-25	CTSS675800FC304Q	G-22
CT50200SSBB	G-13	CTH50175M	G-15	CTSS450300FC304L	G-22	CTSS675800FC316Q	G-23
CT50200SSBB0	G-13	CTHS120400M	G-16	CTSS450300FC316L	G-23	CTSS675800PC304Q	G-24
CT50200SSBC	G-13	CTHS140125M	G-16	CTSS450300PC304L	G-24	CTSS675800PC316Q	G-25
CT50200SSBC0	G-13	CTHS18075M	G-16	CTSS450300PC316L	G-25	CTSS700200304L	G-20
CT50250EPRC	G-10	CTHS50300M	G-16	CTSS450400FC304L	G-22	CTSS700200316L	G-21
CT50250EPRC0	G-10	CTHS50400M	G-16	CTSS450400FC316L	G-23	CTSS700300304L	G-20
CT50250SSBB	G-13	CTHS50700M	G-16	CTSS450400PC304L	G-24	CTSS700300316L	G-21
CT50250SSBB0	G-13	CTSS100100FC304C	G-22	CTSS450400PC316L	G-25	CTSS700400304L	G-20
CT50250SSBC	G-13	CTSS100100FC316C	G-23	CTSS450500FC304L	G-22	CTSS700400316L	G-21
CT50250SSBC0	G-13	CTSS100200FC304C	G-22	CTSS450500FC316L	G-23	CTSS700500304L	G-20
CT50300C	G-5, G-6	CTSS100200FC316C	G-23	CTSS450500PC304L	G-24	CTSS700500316L	G-21
CT50300C0	G-6	CTSS100300FC304C	G-22	CTSS450500PC316L	G-25	CTSS700600304L	G-20
CT50300C00	G-5	CTSS100300FC316C	G-23	CTSS450600FC304L	G-22	CTSS700600316L	G-21
CT50300C0UG	G-8	CTSS100400FC304C	G-22	CTSS450600FC316L	G-23	CTSS700700304L	G-20
CT50300CUG	G-8	CTSS100400FC316C	G-23	CTSS450600PC304L	G-24	CTSS700700316L	G-21
CT50300M	G-5, G-6	CTSS100500FC304C	G-22	CTSS450600PC316L	G-25	CTSS700800304L	G-20
CT50300M0	G-6	CTSS100500FC316C	G-23	CTSS450700FC304L	G-22	CTSS700800316L	G-21
CT50300M00	G-5	CTSS100600FC304C	G-22	CTSS450700FC316L	G-23	CTSS900	G-26
CT50300M0UG	G-8	CTSS100600FC316C	G-23	CTSS450700PC304L	G-24	CTSS900200304L	G-20
CT50300MH10C0UG	G-9	CTSS100800FC304C	G-22	CTSS450700PC316L	G-25	CTSS900200316L	G-21
CT50300MH10GUG	G-9	CTSS100800FC316C	G-23	CTSS450800FC304L	G-22	CTSS900300304L	G-20
CT50300MUG	G-8	CTSS225100304C	G-20	CTSS450800FC316L	G-23	CTSS900300316L	G-21
CT50300SSBB	G-13	CTSS225100316C	G-21	CTSS450800PC304L	G-24	CTSS900400304L	G-20
CT50300SSBB0	G-13	CTSS225200304C	G-20	CTSS450800PC316L	G-25	CTSS900400316L	G-21
CT50300SSBC	G-13	CTSS225200316C	G-21	CTSS500200304L	G-20	CTSS900500304L	G-20
CT50300SSBC0	G-13	CTSS225300304C	G-20	CTSS500200316C	G-21	CTSS900500316L	G-21
CT50400C	G-5, G-6	CTSS225300316C	G-21	CTSS500300304L	G-20	CTSS900600304L	G-20
CT50400C0	G-6	CTSS225400304C	G-20	CTSS500300316C	G-21	CTSS900600316L	G-21
CT50400C00	G-5	CTSS225400316C	G-21	CTSS500400304L	G-20	CTSS900700304L	G-20
CT50400C0UG	G-8	CTSS225500304C	G-20	CTSS500400316L	G-21	CTSS900700316L	G-21
CT50400CUG	G-8	CTSS225500316C	G-21	CTSS500500304L	G-20	CTSS900800304L	G-20
CT50400IDC	G-5	CTSS225600304C	G-20	CTSS500500316L	G-21	CTSS900800316L	G-21
CT50400M	G-5, G-6	CTSS225600316C	G-21	CTSS500600304L	G-20	CTT50	G-26
CT50400M0	G-6	CTSS250200FC304L	G-22	CTSS500600316L	G-21	CTZ120400D	G-15
CT50400M00	G-5	CTSS250200FC316L	G-23	CTSS500700304L	G-20	CTZ120400L	G-15
CT50400MH10C	G-12	CTSS250200PC304L	G-24	CTSS500700316L	G-21	CTZ18075C	G-15
CT50400MH10C0	G-12	CTSS250200PC316L	G-25	CTSS500750304L	G-20	CTZ30200C	G-15
CT50400MH10M0	G-12	CTSS250300FC304L	G-22	CTSS500750316L	G-21	CTZ50175C	G-15
CT50400RC	G-10	CTSS250300FC316L	G-23	CTSS500800304L	G-20	CUSA442NTC	C-142
CT50400RC0	G-10	CTSS250300PC304L	G-24	CTSS500800316L	G-21	CUSA442TC38	C-142
CT50425SSBB	G-14	CTSS250300PC316L	G-25	CTSS675200FC304Q	G-22	CUT200BLMVBL	N-76, N-77
CT50425SSBB0	G-14	CTSS250400FC304L	G-22	CTSS675200FC316Q	G-23	CUT200BLSTA	N-76, N-77
CT50425SSBC	G-14	CTSS250400FC316L	G-23	CTSS675200PC304Q	G-24	CUW26RE-1	H-71
CT50425SSBC0	G-14	CTSS250400PC304L	G-24	CTSS675200PC316Q	G-25	CUW30A-E	H-71
CTASST	G-26	CTSS250400PC316L	G-25	CTSS675300FC304Q	G-22	CUW32R-E	H-71
CTB075AA4C	G-18	CTSS250500FC304L	G-22	CTSS675300FC316Q	G-23	CUW34-E	H-70
CTB075RA4C	G-18	CTSS250500FC316L	G-23	CTSS675300PC304Q	G-24	CUW361R-E	H-71
CTB075RA4CUG	G-9	CTSS250500PC304L	G-24	CTSS675300PC316Q	G-25	CUW391A-E	H-71
CTB075RA4M	G-18	CTSS250500PC316L	G-25	CTSS675400FC304Q	G-22	CUW44-E	H-70
CTB075S4C	G-18	CTSS250600FC304L	G-22	CTSS675400FC316Q	G-23	CZ-11	E-44
CTB125AA4C	G-18	CTSS250600FC316L	G-23	CTSS675400PC304Q	G-24	D26L/Y29PR	N-69
CTB125RA2C	G-18	CTSS250600PC304L	G-24	CTSS675400PC316Q	G-25	D3CL/Y29PR	N-69
CTB125RA4C	G-18	CTSS250600PC316L	G-25	CTSS675500FC304Q	G-22	D6CL/Y29PL	N-69
CTB125RA4CUG	G-9	CTSS250700FC304L	G-22	CTSS675500FC316Q	G-23	DUW28	H-70
CTB125RA4D	G-18	CTSS250700FC316L	G-23	CTSS675500PC304Q	G-24	DUW28A	H-71
CTB125RA4DUG	G-9	CTSS250700PC304L	G-24	CTSS675500PC316Q	G-25	DUW31	H-70
CTB125RA4L	G-18	CTSS250700PC316L	G-25	CTSS675600FC304Q	G-22	DUW34	H-70

ALPHA-NUMERIC INDEX BY CATALOG NUMBER (Continued)

Catalog Number	Page #	Catalog Number	Page #	Catalog Number	Page #	Catalog Number	Page #
DUW44	H-70	FD64C5T16	L-20	GAR1634	E-34	GBL30N	E-57
DUW44A	H-71	FD655C6	L-20	GAR164C	E-34	GBM26	E-57
DUW44A-E	H-71	FD655D6	L-20	GAR1726	E-35	GBM29	E-57
DV1L/Y29PR	N-69	FD65C6T14	L-20	GAR1729	E-35	GBM34	E-57
DV25L/Y29PR	N-69	FD66C6	L-20	GAR1734	E-35	GBM4C	E-57
DV26L/Y29PR	N-69	FD66D6	L-20	GAR174C	E-35	GC15A	E-48
DV2CL/Y29PL	N-69	FD675C8	L-20	GAR1826	E-35	GC18A	E-48
DV4L/Y29PL	N-69	FD675D8	L-20	GAR1829	E-35	GC22A	E-48
DV6LY29PL	N-69	FD685C8	L-20	GAR1834	E-35	GC2525CT	E-59
DV8L/Y29PL	N-69	FD685D12	L-20	GAR184C	E-35	GC2626	E-57
E2C34G1	A-19, H-40, L-22	FD685D8	L-20	GAR1926	E-35	GC2626CT	E-59
E3C34G1	A-19, H-40, L-22	FD68C8	L-20	GAR1929	E-35	GC2929	E-57
E4C34G1	A-19, H-40, L-22	FD68D12	L-20	GAR1934	E-35	GC2929CT	E-59
EA25	A-12	FD68D8	L-20	GAR194C	E-35	GC3434	E-57
EA28	A-12	FD69C8	L-20	GAR2026	E-35	GC4C4C	E-57
EA28-2N	A-12	FD69D12	L-20	GAR2029	E-35	GCB63T13G1	E-61
EA2C	A-12	FD69D8	L-20	GAR2034	E-35	GCL30	E-57
EA34	A-12	FD70D12	L-20	GAR204C	E-35	GCM26	E-57
EA34-2N	A-12	FD70D16	L-20	GAR2126	E-35	GCM29	E-57
EBP	N-122, N-123	FL1025X03B	B-74	GAR2129	E-35	GCM30	E-57
EP10	N-93	FL1025X03D	B-74	GAR2134	E-35	GCM34	E-57
EP10-1HP	N-94	FL1425X03B	B-74	GAR214C	E-35	GCM4C	E-57
EP10-1HP-2	N-94	FL1425X03D	B-74	GAR2226	E-35	GCRT1/0	E-51
EP10-2	N-93	FL1825X03B	B-74	GAR2229	E-35	GD1526	E-38
EP6	N-93	FL1825X03D	B-74	GAR2234	E-35	GD1529	E-38
EP8	N-93	FLN1025X03D	B-74	GAR224C	E-35	GD1626	E-38
EPAC10	N-92	FLN1425X03D	B-74	GAR2426	E-35	GD1629	E-38
EPAC-6	N-92	FLN1825X03D	B-74	GAR2429	E-35	GD1726	E-38
EPAC-8	N-92	FORCEGAUGE12-15	N-8, N-25	GAR2434	E-35	GD1729	E-38
EPP10	N-91	FP10	N-89	GAR244C	E-35	GD1734	E-38
EPP6	N-91	FP6	N-89	GAR3902	E-36	GD174C	E-38
EPPCASE-1	N-91	FP8	N-89	GAR3902-BU	E-36	GD1826	E-38
ES25A25A	H-45	FQN10M25X03B	B-67	GAR3902TC	E-37	GD1829	E-38
ES25A2W	H-45	FQN10M25X03D	B-67	GAR3903	E-36	GD1834	E-38
ES25A4W	H-45	FQN14M18X02D	B-67	GAR3903-BU	E-36	GD184C	E-38
ES25R25R	H-45	FQN14M25X03B	B-67	GAR3903TC	E-37	GD1926	E-38
ES25R2R	H-45	FQN14M25X03D	B-67	GAR3904	E-36	GD1929	E-38
ES25R2W	H-45	FQN18M18X02D	B-67	GAR3904-BU	E-36	GD1934	E-38
ES25R4W	H-45	FQN18M25X03B	B-67	GAR3904TC	E-37	GD194C	E-38
ES25R6W	H-45	FQN18M25X03D	B-67	GAR3905	E-36	GD2026	E-38
ES2R2R	H-45	FQP10F25X03D	B-64	GAR3905-BU	E-36	GD2029	E-38
ES2R2W	H-45	FQP14F11X03D	B-64	GAR3905TC	E-37	GD2034	E-38
ES2R4W	H-45	FQP14F18X02D	B-64	GAR3906	E-36	GD204C	E-38
ES2R6W	H-45	FQP14F25X03D	B-64	GAR3906-BU	E-36	GD2126	E-38
ES2R8W	H-45	FQP18F11X03D	B-64	GAR3906TC	E-37	GD2129	E-38
ES2W2W	H-45	FQP18F18X02D	B-64	GAR3907	E-36	GD2134	E-38
ES2W4W	H-45	FQP18F25X03D	B-64	GAR3907-BU	E-36	GD214C	E-38
ES2W6W	H-45	FT3B4/0	A-41	GAR3907TC	E-37	GD2226	E-38
ES2W8W	H-45	FT3B500	A-41	GAR3908	E-36	GD2229	E-38
ES4W4W	H-45	FT4B4/0	A-41	GAR3908-BU	E-36	GD2234	E-38
ES4W6W	H-45	FT4B500	A-41	GAR3908TC	E-37	GD224C	E-38
ES4W8W	H-45	GA25H26	E-64	GAR3909	E-36	GG15-1	E-49
ES6W6W	H-45	GAR1126	E-34	GAR3909-BU	E-36	GG16-1	E-49
ES6W8W	H-45	GAR1129	E-34	GAR3909TC	E-37	GG17-1	E-49
ES8W8W	H-45	GAR114C	E-34	GAR6426	E-34	GG17-15	E-49
F22A28	K-74	GAR1426	E-34	GAR6429	E-34	GG18-1	E-49
FCB63-2NP300	A-37, L-22	GAR1429	E-34	GAR6434	E-34	GG18-15	E-49
FCB63-4N	A-37, L-22	GAR1434	E-34	GAR644C	E-34	GG18-2	E-49
FCB63-6N	A-37, L-22	GAR144C	E-34	GAR644C-RB	E-36	GG19-2	E-49
FCB64-2NP300	L-22	GAR1526	E-34	GAR8629	E-35	GG19-25	E-49
FCB64-44NP50	A-37, L-22	GAR1529	E-34	GAR8634	E-35	GG20-2	E-49
FCB644G4	L-22	GAR1534	E-34	GB26	E-57	GG20-25	E-49
FCB64-4N	A-37, L-22	GAR154C	E-34	GB29	E-57	GG20-3	E-49
FCB64-6N	A-37, L-22	GAR1626	E-34	GB34	E-57	GG21-2	E-49
FCB65-4N	A-37, L-22	GAR1629	E-34	GB4C	E-57	GG21-25	E-49

ALPHA-NUMERIC INDEX BY CATALOG NUMBER (Continued)

Catalog Number	Page #	Catalog Number	Page #	Catalog Number	Page #	Catalog Number	Page #
GG21-3	E-49	GP644C	E-39	HFB62P1	L-24	HS_332T300PF	F-8
GG21-35	E-49	GP64526G1	E-67	HFB63P1	A-21, L-24	HS_332T48PF	F-7
GG22-2	E-49	GP654CG1	E-67	HFB64P1	L-24	HS_34FR	F-14
GG22-25	E-49	GQ26-1	E-50	HFB66-6N	A-22, L-24	HS_34FR250	F-14
GG22-3	E-49	GQ2626	E-50	HFB66P1	A-21	HS_34T300PF	F-8
GG22-4	E-49	GQ29-1	E-50	HFB88P1	A-21	HS_34T48PF	F-7
GG24-2	E-49	GQ2929	E-50	HH5-RL48	N-27	HS_38FR	F-14
GIE2CCG3	E-60	GRC12	E-51	HHS-O/C-4-B13	N-106	HS_38FR250	F-14
GIE4CG3	E-60	GRC34	E-51	HHS-O/C-5-B13	N-106	HS_38T300PF	F-8
GIE4CG3P5	E-60	GRC58	E-51	HHS-O/C-B13	N-106	HS_38T48PF	F-7
GIE4CG3P7	E-60	GRF4C-3	E-66	HHS-O/C-B16	N-106	HSB100T6PF7	F-6
GIE4CG4	E-60	GRF4C-4	E-66	HHS-O/C-B20	N-106	HSB110H48PF5	F-9
GIE4CG4P5	E-60	GRL3	E-51	HIW12SOCSET	N-109	HSB110H6PF5	F-9
GIE4CG4P7	E-60	GRL4	E-51	HIW71612TGKIT	N-109	HSB110H9PF5	F-9
GK1126	E-40	GRL5	E-51	HIW716ENF	N-98	HSB11612T6PF14	F-6
GK1129	E-40	GRL6	E-51	HIW716ENFTG	N-98	HSB116T6PF26	F-6
GK114C	E-40	GROUNDMAX	E-98	HIW716ENFTGKIT	N-98	HSB12T6PF10	F-6
GK1426	E-40	GROUNDTAB1/2	E-18	HIW716MAG	N-99	HSB14T6PF14	F-6
GK1429	E-40	GROUNDTAB3/8	E-18	HOSE2	N-104	HSB150H12PF3	F-9
GK1434	E-40	GSTUD14HY	E-24	HOSE325	N-104	HSB150H48PF5	F-9
GK1526	E-40	GSTUD34HY	E-24	HOSE350	N-104	HSB150H9PF3	F-9
GK1529	E-40	GSTUD38HY	E-24	HP10	N-88	HSB18T6PF20	F-6
GK1626	E-40	GSTUD916HY	E-24	HP2CAMLOCKHOSESET	N-104	HSB200H12PF2	F-9
GK1629	E-40	GX2626	E-50	HP2HV	N-104	HSB200H48PF2	F-9
GK1726	E-40	GX264C	E-50	HP3	N-104	HSB200H9PF2	F-9
GK1729	E-40	GX2926	E-50	HP6	N-88	HSB316T6PF18	F-6
GK1826	E-40	GX2929	E-50	HP8	N-88	HSB332T6PF24	F-6
GK1829	E-40	GX294C	E-50	HPP18	N-108	HSB34H48PF5	F-9
GK1926	E-40	GX3426	E-50	HPP18-2	N-108	HSB34H6PF10	F-9
GK1929	E-40	GX3429	E-50	HPP5	N-108	HSB34H9PF10	F-9
GK6426	E-40	GX3434	E-50	HPS1371LW	N-107	HSB34T6PF8	F-6
GK6429	E-40	GX344C	E-50	HPS1383LW	N-107	HSB35H3PF25	F-9
GK6434	E-40	GX4C4C	E-50	HPT-59-R1	N-105	HSB35H48PF5	F-9
GK644C	E-40	GXP1828RF	E-65	HPT-60-R1	N-105	HSB35H6PF25	F-9
GKA25	E-30	GZ26-12	E-58	HPT-71-R1	N-105	HSB38100T6PF8	F-6
GKA25SB	E-30	GZ26-38	E-58	HPT-72-R1	N-105	HSB38T6PF12	F-6
GKA28	E-30	GZ26-58	E-58	HPT-83-R1	N-105	HSC100FR	F-13
GKA28SB	E-30	GZ29-12	E-58	HPT-84-R1	N-105	HSC100FR100	F-13
GKA4C	E-30	GZ29-38	E-58	HPT-96-R1	N-105	HSC112FR	F-13
GKA8C	E-30	GZ29-58	E-58	HS_100FR	F-14	HSC112FR100	F-13
GL2626	E-58	GZ4C-12	E-58	HS_100FR100	F-14	HSC12FR	F-13
GL2929	E-58	GZ4C-38	E-58	HS_100T300PF	F-8	HSC12FR250	F-13
GL3434	E-58	GZ4C-58	E-58	HS_100T48PF	F-7	HSC14FR	F-13
GL4C4C	E-58	H12E	N-120	HS_112FR	F-14	HSC14FR250	F-13
GP10	N-95	H1E34R	N-120	HS_112FR100	F-14	HSC18FR	F-13
GP1126	E-39	H34E12R	N-120	HS_116T300PF	F-8	HSC18FR250	F-13
GP1129	E-39	HBR40	N-103	HS_116T48PF	F-7	HSC200FR	F-13
GP114C	E-39	HBR66	N-103	HS_12FR	F-14	HSC200FR100	F-13
GP1426	E-39	HCCACSR	N-71, N-82	HS_12FR250	F-14	HSC34FR	F-13
GP1429	E-39	HCCUAL	N-71, N-82	HS_12T300PF	F-8	HSC34FR250	F-13
GP1434	E-39	HCCGUY	N-71, N-82	HS_12T48PF	F-7	HSC38FR	F-13
GP144C	E-39	HCCSOL	N-71, N-82	HS_14FR	F-14	HSC38FR250	F-13
GP1526G1	E-67	HFB22P1	A-21, L-24	HS_14FR250	F-14	HSIC10-500FR	F-10
GP1629	E-39	HFB33-4N	A-22, L-24	HS_14T300PF	F-8	HSIC200FR	F-10
GP164C	E-39	HFB33P1	A-21, L-24	HS_14T48PF	F-7	HSIC30-1000FR	F-10
GP1726	E-39	HFB42P1	A-21, L-24	HS_150T48PF	F-7	HSIC350FR	F-10
GP1726G1	E-67	HFB44-4N	A-22, L-24	HS_18FR	F-14	HSIC4-40FR	F-10
GP1726RT	E-67	HFB44G30W	L-23	HS_18FR250	F-14	HSIC8-1FR	F-10
GP1826	E-39	HFB44G31W	L-23	HS_18T300PF	F-8	HSKIT	B-91
GP184C	E-39	HFB44G32W	L-23	HS_18T48PF	F-7	HSM100T6PF7	F-6
GP2026	E-39	HFB44P1	A-21, L-24	HS_200FR	F-14	HSM116T6PF26	F-6
GP2226	E-39	HFB52P1	L-24	HS_200FR100	F-14	HSM12T6PF10	F-6
GP6426	E-39	HFB53P1	L-24	HS_200T48PF	F-7	HSM14T6PF14	F-6
GP6429	E-39	HFB54P1	L-24	HS_316T300PF	F-8	HSM18T6PF20	F-6
GP6434	E-39	HFB55P1	L-24	HS_316T48PF	F-7	HSM316T6PF18	F-6

ALPHA-NUMERIC INDEX BY CATALOG NUMBER (Continued)

Catalog Number	Page #	Catalog Number	Page #	Catalog Number	Page #	Catalog Number	Page #
HSM332T6PF24	F-6	K2A40U-2N	A-25	KA2U	A-23	KK8A44U-14	A-28
HSM34T6PF8	F-6	K2A44U	A-25	KA30226U	A-23	KK431U-2N	A-23
HSM38T6PF12	F-6	K2A44U-2N	A-25	KA30U	A-23	KLU125	A-11
HTP3	N-104	K2C15	E-27	KA30UAR	A-24	KLU125TP	A-11
HYA_28	K-60	K2C15B1	E-27	KA31U	A-23	KLU175	A-11
HYA_29	K-60	K2C17	E-27	KA31UAR	A-24	KLU175TP	A-11
HYA_31	K-60	K2C17B1	E-27	KA34	A-12	KLU225	A-11
HYA_34	K-60	K2C20	E-27	KA34U	A-23	KLU225TP	A-11
HYA_39	K-60	K2C20B1	E-27	KA36229U	A-23	KLU25	A-11
HYAO_28	K-60	K2C22	E-27	KA36U	A-23	KLU25TP	A-11
HYAO_29	K-60	K2C22B1	E-27	KA36U-2N	A-23	KLU300	A-11
HYAO_31	K-60	K2C23	E-27	KA36UAR	A-24	KLU300TP	A-11
HYAO_34	K-60	K2C23B1	E-27	KA39229U	A-23	KLU35	A-11
HYAO_39	K-60	K2C25	E-27	KA40U	A-23	KLU35TP	A-11
HYFLUIDGAL	N-97	K2C25B1	E-27	KA40U-2N	A-23	KLU400	A-11
HYFLUIDQT	N-97	K2C26	E-27	KA44U	A-23	KLU400TP	A-11
HYM_28	K-60	K2C26B1	E-27	KA44U-2N	A-23	KLU70	A-11
HYM_29	K-60	K2C28	E-27	KA4C	A-12	KLU70TP	A-11
HYM_31	K-60	K2C28B1	E-27	KA4UAR	A-24	KPA25	A-10
HYM_34	K-60	K2C28G3	E-27	KA6U	A-23	KPA28	A-10
HYM_39	K-60	K2C31	E-27	KA8C	A-12	KPA34	A-10
HYS_28	K-60	K2C31B1	E-27	KAG1MTGBRKT	A-30	KPA4C	A-10
HYS_29	K-60	K2C34	E-27	KAU-KIT1	A-29	KPA4CUP	A-10
HYS_31	K-60	K2C34B1	E-27	KAU-KIT2	A-29	KPA8C	A-10
HYS_34	K-60	K2P4CAG1	A-30	KAU-KIT3	A-29	KPA8CUP	A-10
HYS_39	K-60	K33B34-4N	K-73	KAU-KIT4	A-29	KPB4CG1	E-30
J1022NC1	N-54, N-68	K3A25U-2	A-26	KC15	E-27	K-PC28	K-72
J1022NC2	N-54, N-68	K3A25U-4	A-26	KC15B1	E-27	KPU29A26AC	A-38
J1022NC3	N-54, N-68	K3A26U-2N	A-26	KC17	E-27	KPU29A29AC	A-38
J1022NC4	N-54, N-68	K3A27U-2N	A-26	KC17B1	E-27	KPU34A26AC	A-38
J1022NC5	N-54, N-68	K3A27U-4N	A-26	KC20	E-27	KPU34A34AC	A-38
J1207	K-66	K3A29U-2N	A-26	KC20B1	E-27	KPU39A26AC	A-38
J1592	K-66	K3A29U-4N	A-26	KC22	E-27	KPU39A39AC	A-38
J278	E-63	K3A2U-2	A-26	KC22B1	E-27	KS15	A-3, E-29, H-4
J279	E-63	K3A2U-4	A-26	KC23	E-27	KS17	A-3, E-29, H-4
J280	E-63	K3A31U-2N	A-26	KC23B1	E-27	KS17-3	A-3, H-4
J295	E-63	K3A31U-4N	A-26	KC25	E-27	KS20	A-3, E-29, H-4
J4CNC	N-68	K3A36U-2N	A-26	KC25B1	E-27	KS20-3	A-3, H-4
J6CNC	N-68	K3A36U-4N	A-26	KC26	E-27	KS22	A-3, E-29, H-4
J6NCP1CH	N-68	K3A40U-4N	A-26	KC26B1	E-27	KS22-3	A-3, H-4
J8CNC	N-68	K3P4CAG1	A-30	KC28	E-27	KS23	A-3, E-29, H-4
K10P4CG1	A-31	K4A29U-4N	A-27	KC28B1	E-27	KS25	A-3, E-29, H-4
K11A30U	A-27	K4A31U-4N	A-27	KC28G3	E-27	KS26	A-3, E-29, H-4
K11A34U-2	A-27	K5P6C2P1/0CAG1	A-30	KC31	E-27	KS27	A-3, E-29, H-4
K11A36U-2	A-27	K6A34U-6N	K-74	KC31B1	E-27	KS29	A-3, E-29, H-4
K11A39U-2	A-27	K6A34U-8	A-28	KC34	E-27	KS31	A-3, E-29, H-4
K12P4CG1	A-31	K6B2826-2N	K-73	KC34B1	E-27	KS34	A-3, E-29, H-4
K12P6C3P1/0CAG1	A-30	K6B28-4N	K-73	KCKF23	E-28	KS39	A-3, H-4
K13P4CAG1	A-30	K6P28	K-72	KCKF25	E-28	KS44	A-3, H-4
K14P4CG1	A-31	K6P28C	K-72	KCKF28	E-28	KS90	A-3, H-4
K14P6C5P1/0CAG1	A-30	K6P34U	K-74	KK3A36U-2N	A-26	KSA1/0	A-5
K15P4CAG1	A-30	K6P34UC	K-74	KK3A36U-4N	A-26	KSA2	A-5
K16P6C5P1/0CAG1	A-30	K6P4CG1	A-31	KK3A40U-2N	A-26	KSA2/0	A-5
K174P4CG1	A-31	K6PC34U	K-74	KK3A40U-4N	A-26	KSA350	A-5
K21A36U-2	A-27	K8A34U-10	A-28	KK3A44U-2N	A-26	KSA4	A-5
K22A36U-2	A-27	K8P4CG1	A-31	KK3A44U-4N	A-26	KSA4/0	A-5
K22A39U-2	A-27	K9P4CAG1	A-30	KK4A36U-4N	A-27	KSA500	A-5
K2A25U	A-25	KA25	A-12	KK4A40U-4N	A-27	KSA6	A-5
K2A26U	A-25	KA25-2TC38	A-12	KK6A31U-8	A-28	KSU17	A-4, H-5
K2A29U	A-25	KA25U	A-23	KK6A34U-8	A-28	KSU20	A-4, H-5
K2A31U	A-25	KA25UAR	A-24	KK6A44U-12	A-28	KSU22	A-4, H-5
K2A31U-2N	A-25	KA26U	A-23	KK8A31U-10	A-28	KSU23	A-4, H-5
K2A36U	A-25	KA26UAR	A-24	KK8A34U-10	A-28	KSU25	A-4, H-5
K2A36U-2N	A-25	KA28	A-12	KK8A39U-10	A-28	KSU26	A-4, H-5
K2A40U	A-25	KA29U	A-23	KK8A39U-12	A-28	KSU27	A-4, H-5

ALPHA-NUMERIC INDEX BY CATALOG NUMBER (Continued)

Catalog Number	Page #	Catalog Number	Page #	Catalog Number	Page #	Catalog Number	Page #
KSU29	A-4, H-5	LF1006	K-53	LPHTGRDVR11458	N-109	LYS28C	K-51
KSU31	A-4, H-5	LF1010	K-51, K-53	LPHTGRDVR11858	N-109	LYS28P5	K-55
KSU34	A-4, H-5	LF1014	K-51, K-52, K-53	LPHTHOSNCR666610	N-102, N-109	LYS29C	K-51
KUADP	N-15	LF1025	K-51, K-52, K-53	LPHTHOSNCR666610OP	N-102, N-109	LYS29P5	K-55
KVS26	A-6, H-6	LF2019	K-51, K-52, K-53	LPHTHOSNCR66668	N-98, N-109	LYS2CC	K-51
KVS26A	A-7, H-8	LF2027	K-51, K-52, K-53	LPHTHOSNCR66668OP	N-102, N-109	LYS2CP5	K-55
KVS28	A-6, H-6	LF2038	K-51, K-52, K-53	LPHTHTMABODY66	N-98, N-102	LYS30C	K-51
KVS28A	A-7, H-8	LF2065	K-51, K-52, K-53	LPHTHTMADUSTCAPF	N-109	LYS30P5	K-55
KVS31	A-6, H-6	LF2108	K-53	LPHTHTMADUSTCAPM	N-109	LYS31C	K-51
KVS31A	A-7, H-8	LH283	L-18	LPHTHTMANOSE66	N-98, N-102	LYS31P5	K-55
KVS34	A-6, H-6	LH343	L-18	LPHTMOILPT118	N-109	LYS32C	K-51
KVS34A	A-7, H-8	LH453	L-18	LPHTMOILPT11814	N-109	LYS32P5	K-55
KVS40	A-6, H-6	LHR293	L-18	LPHTNARCHISEL11814	N-109	LYS32P6	K-56
KVS40A	A-7, H-8	LHR443	L-18	LPHTSOC121	N-109	LYS34C	K-51
KVS44	A-6, H-6	LHR445	L-18	LPHTSOC121/118	N-109	LYS34P2	K-54
KVS44A	A-7, H-8	LPC12S	N-109	LPHTSOC121116	N-109	LYS34P5	K-55
KVSU26	A-6, H-7	LPC38S	N-109	LPHTSOC12112	N-109	LYS48P6	K-56
KVSU28	A-6, H-7	LPHT3CHISEL11418	N-109	LPHTSOC12114	N-109	LYS4CC	K-51
KVSU31	A-6, H-7	LPHTADPMM71612	N-99, N-109	LPHTSOC12118	N-109	LYS4CP5	K-55
KVSU34	A-6, H-7	LPHTADPMMOP66	N-98, N-109	LPHTSOC121188PT	N-109	LYS64P6	K-56
KVSU40	A-6, H-7	LPHTADPSMFOP66	N-102	LPHTSOC1212	N-109	LYS6CP5	K-55
KVSU44	A-6, H-7	LPHTADPSMOP66	N-99	LPHTSOC12128PT	N-109	LYS80P6	K-56
KVSW26	A-7, H-6	LPHTASPHALTCUT118	N-109	LPHTSOC121316	N-109	M20	H-69
KVSW28	A-7, H-6	LPHTBIT111612HC	N-101	LPHTSOC121316/1516	N-109	M30	H-69
KVSW31	A-7, H-6	LPHTBIT111612SC	N-101	LPHTSOC1213168PT	N-109	M40	H-69
KVSW34	A-7, H-6	LPHTBIT111618	N-101	LPHTSOC12138	N-109	M50	H-69
KVSW40	A-7, H-6	LPHTBIT111618D	N-101, N-109	LPHTSOC1215168PT	N-109	M60	H-69
KVSW44	A-7, H-6	LPHTBIT111618HC	N-101	LPHTSOC121716	N-109	M70	H-69
L717W	N-33	LPHTBIT111618R	N-101	LPHTSOC1217168PT	N-109	M80	H-69
L719W	N-33	LPHTBIT111624D	N-101, N-109	LPHTSOC1218PT	N-109	M8ND	N-57
L720W	N-33	LPHTBIT111624R	N-101	LPHTSOC1234	N-109	M90	H-69
L722W	N-33	LPHTBIT11812HC	N-101	LPHTSOC12348PT	N-109	MCC1000	N-85
L724W	N-33	LPHTBIT11824D	N-101	LPHTSOC1258	N-109	MCC1000BLADESET	N-85
L725W	N-33	LPHTBIT11824R	N-101	LPHTSOC12588PT	N-109	MCC600	N-85
L727W	N-33	LPHTBIT1218	N-101	LPHTSOC1278	N-109	MCC600BLADESET	N-85
L728W	N-33	LPHTBIT131612HC	N-101	LPHTSOC12788PT	N-109	MD6	N-62
L729W	N-33	LPHTBIT131612SC	N-101	LPHTSOC12916	N-109	MD6-12	N-62
L735W	N-33	LPHTBIT131618	N-101	LPHY750CXT	N-102	MD6-14	N-62
LB13A	L-34	LPHTBIT131618D	N-101, N-109	LPHY750XT	N-102	MD6-37	N-62
LB14A	L-34	LPHTBIT131618HC	N-101	LPWHPKITD	N-105	MD6-38	N-62
LB15A	L-34	LPHTBIT131618R	N-101	LSC1/0	H-19	MD6-4	N-62
LB16A	L-34	LPHTBIT131618SC	N-101	LSC1/0-1	H-19	MD6-6	N-62
LB17A	L-34	LPHTBIT131624	N-101	LSC556	H-19	MD6-6HS60	N-65
LB18A	L-34	LPHTBIT131624D	N-101, N-109	LSC556-1	H-19	MD6-6HS72	N-65
LB19A	L-34	LPHTBIT131624R	N-101	LYBASE	K-54	MD6-8	N-62
LB20A	L-34	LPHTBIT151618	N-101	LYM1CC	K-52	MD6-8AH48	N-65
LB21A	L-34	LPHTBIT151618D	N-101, N-109	LYM25C	K-52	MD6-8HS60	N-65
LB22A	L-34	LPHTBIT151618R	N-101	LYM26C	K-52	MD6-8HS72	N-65
LB23A	L-34	LPHTBIT151624D	N-101, N-109	LYM27C	K-52	MD6-AH48	N-65
LB24A	L-34	LPHTBIT151624R	N-101	LYM28C	K-52	MD6-CP1	N-66
LB53A	L-34	LPHTBIT3418D	N-101	LYM29C	K-52	MD6HS60	N-65
LB54A	L-34	LPHTBIT3418R	N-101	LYM2CC	K-52	MD6HS72	N-65
LB55A	L-34	LPHTBIT3424D	N-101	LYM30C	K-52	MD6-K	N-62
LB56A	L-34	LPHTBIT5818D	N-101	LYM31C	K-52	MD7	N-63
LB57A	L-34	LPHTBIT5818R	N-101	LYM32C	K-52	MD7-34	N-64
LB58A	L-34	LPHTBIT5824D	N-101	LYM34C	K-52	MD7-34-KIT1	N-64
LB59A	L-34	LPHTBIT7818D	N-101	LYM34P3	K-56	MD7-34R	N-64
LB83A	L-34	LPHTBIT91612HC	N-101	LYS1CC	K-51	MD7-34R-C	N-64
LB86A	L-34	LPHTBIT91618R	N-101	LYS1CP5	K-55	MD7-34R-KIT1	N-64
LB88A	L-34	LPHTBIT9168R	N-101	LYS25C	K-51	MD7-6	N-63
LB90A	L-34	LPHTCLAYSPADE118	N-109	LYS25P5	K-55	MD7-8	N-63
LB91A	L-34	LPHTDRIPBODY66	N-109	LYS26C	K-51	MINBAG	N-82
LB92A	L-34	LPHTDRIPBODY88	N-109	LYS26P5	K-55	MK7	G-26
LB94A	L-34	LPHTDRIPNOSE66	N-109	LYS27C	K-51	MK9	G-26
LB96A	L-34	LPHTDRIPNOSE88	N-109	LYS27P5	K-55	MK9SST	G-26

ALPHA-NUMERIC INDEX BY CATALOG NUMBER (Continued)

Catalog Number	Page #	Catalog Number	Page #	Catalog Number	Page #	Catalog Number	Page #
MR15	N-52	NA22A-4N	L-28	NBC24A34N	L-31	NNTR19A42A	L-27
MR18	N-52	NAH29-2N	L-6	NBC24A44N	L-31	NNTR20A32A	L-27
MR20	N-52	NAH29-34N	L-6	NBC86A44N	L-31	NNTR22A46A	L-27
MR4C	N-53	NAH34-2N	L-6	NDR6328T13	L-19	NNTR29A29A	L-26
MR8-1A	N-50	NAH34-34N	L-6	NDR6334T13	L-19	NNTR32A25A	L-26
MR8-33S-1	N-50	NAH40-2N	L-6	NDR6428T16	L-19	NNTR32A32A	L-26
MR8-33T-1	N-50	NAH40-34N	L-6	NDR6434T12	L-19	NNTR36A29A	L-26
MR8-9Q	N-50	NAH404-4N	L-6	NDR6434T16	L-19	NNTR36A36A	L-26
MR8-G96	N-50	NAH44-2N	L-6	NDR6444T16	L-19	NNTR42A32A	L-26
MR8-G98	N-50	NAH44-34N	L-6	NDR64534T14	L-19	NNTR42A36A	L-26
MRC840	N-58	NAH44-44N	L-6	NDR6528T14	L-19	NNTR42A42A	L-26
MRC840AL	N-58	NAH46-2N	L-6	NDR6534T12	L-19	NNTR45A45A	L-26
MRE10-22B	N-51	NAH46-34N	L-6	NDR6534T14	L-19	NNTR46A42A	L-26
MRE10-22NV	N-51	NAH46-44N	L-6	NDR6544T14	L-19	NNTR46A46A	L-26
MTB	N-122, N-123	NAH48-2N	L-6	NDR65528T12	L-19	NNTR48A48A	L-26
MTX	N-122, N-123	NAH48-34N	L-6	NDR65534T12	L-19	NS1212	L-15
MY28	N-59	NAH48-44N	L-6	NDR65544T12	L-19	NS1313	L-15
MY28-4	N-59	NAH48-62N	L-6	NDR6748T12	L-19	NS14148HC	L-15
MY28-6	N-59	NAH486-34N	L-6	NDR67544T12	L-19	NS1414HC	L-15
MY29-11	N-59	NAR25A2N	L-30	NDR67548T12	L-19	NS14A14A	L-28
MY29-11C	N-59	NAR29A2N	L-30	NDR6844T12	L-19	NS1515	L-15
MY29-3	N-59	NAR29A4N	L-30	NDR6848T12	L-19	NS1515HC	L-15
MY29-3C	N-59	NAR32A2N	L-30	NDR68544T12	L-19	NS1515CHQ	L-15
MY29-3CF	N-59	NAR32A4N	L-30	NHNT1429	L-13	NS15A15A	L-28
MY29UNIVERSALKIT	N-59	NAR36A2N	L-30	NHNT1434	L-13	NS1616HC	L-15
N2AH29-2N	L-7	NAR36A4N	L-30	NHNT1529	L-13	NS16A16A	L-28
N2AH29-34N	L-7	NAR42A2N	L-30	NHNT1534	L-13	NS1717	L-15
N2AH34-2N	L-7	NAR42A4N	L-30	NHNT1540	L-13	NS1717HC	L-15
N2AH34-34N	L-7	NAR45A2N	L-30	NHNT1629	L-13	NS1717HCHQ	L-15
N2AH34-44N	L-7	NAR45A4N	L-30	NHNT1634	L-13	NS17A17A	L-28
N2AH40-34N	L-7	NAR46A2N	L-30	NHNT1640	L-13	NS1818	L-15
N2AH44-34N	L-7	NAR46A4N	L-30	NHNT1644	L-13	NS1818CG2	L-15
N2AH44-44N	L-7	NAR48A2N	L-30	NHNT1729	L-13	NS1818HC	L-15
N2AH44-44NHQ	L-7	NAR48A4N	L-30	NHNT1734	L-13	NS18A18A	L-28
N2AH46-44N	L-7	NAS29-2N	L-4	NHNT1740	L-13	NS1919	L-15
N2AH48-44N	L-7	NAS29-34N	L-4	NHNT1744	L-13	NS1919HC	L-15
NA122N	L-5	NAS29-N	L-4	NHNT1829	L-13	NS1919HCHQ	L-15
NA132N	L-5	NAS34-2N	L-4	NHNT1834	L-13	NS19A19A	L-28
NA142N	L-5	NAS34-34N	L-4	NHNT1840	L-13	NS2020	L-15
NA144N	L-5	NAS34-N	L-4	NHNT1844	L-13	NS2020HC	L-15
NA152N	L-5	NAS40-2N	L-4	NHNT1846	L-13	NS20A20A	L-28
NA154N	L-5	NAS40-34N	L-4	NHNT1929	L-13	NS2121	L-15
NA15A-2N	L-28	NAS40-44N	L-4	NHNT1934	L-13	NS2121HC	L-15
NA15A-4N	L-28	NBC14A2N	L-31	NHNT1940	L-13	NS21A21A	L-28
NA162N	L-5	NBC15A-2N	L-31	NHNT1944	L-13	NS2222	L-15
NA164N	L-5	NBC15A34N	L-31	NHNT1946	L-13	NS2222HC	L-15
NA16A-2N	L-28	NBC16A2N	L-31	NHNT2040	L-13	NS22A22A	L-28
NA172N	L-5	NBC16A34N	L-31	NHNT2044	L-13	NS23A23A	L-28
NA1744NHQ	L-5	NBC16A44N	L-31	NHNT2229	L-13	NS24A24A	L-28
NA174N	L-5	NBC17A2N	L-31	NNT15A15A	L-25	NS86A86A	L-28
NA17A-2N	L-28	NBC17A34N	L-31	NNT16A16A	L-25	NSNT1329	L-12
NA17A-4N	L-28	NBC17A44N	L-31	NNT17A17A	L-25	NSNT1429	L-12
NA182N	L-5	NBC18A2N	L-31	NNT18A18A	L-25	NSNT1434	L-12
NA184N	L-5	NBC18A34N	L-31	NNT19A19A	L-25	NSNT1529	L-12
NA18A-2N	L-28	NBC18A-44N	L-31	NNT20A20A	L-25	NSNT1629	L-12
NA18A-4N	L-28	NBC19A34N	L-31	NNT21A20A	L-25	NSNT2929	L-12
NA1944N	L-5	NBC19A44N	L-31	NNT22A22A	L-25	NSNT3429	L-12
NA1944NHQ	L-5	NBC20A2N	L-31	NNTR14A29A	L-27	NSNT3434	L-12
NA194N	L-5	NBC20A34N	L-31	NNTR15A36A	L-27	NT1313	L-11
NA194N90CG2	L-5	NBC20A-44N	L-31	NNTR15A42A	L-27	NT1413	L-11
NA19A-4N	L-28	NBC21A44N	L-31	NNTR16A29A	L-27	NT1414	L-11
NA204N	L-5	NBC22A2N	L-31	NNTR16A32A	L-27	NT1514	L-11
NA20A-4N	L-28	NBC22A34N	L-31	NNTR16A42A	L-27	NT1515	L-11
NA214N	L-5	NBC22A44N	L-31	NNTR17A29A	L-27	NT1614	L-11
NA224N	L-5	NBC24A2N	L-31	NNTR18A29A	L-27	NT1615	L-11

ALPHA-NUMERIC INDEX BY CATALOG NUMBER (Continued)

Catalog Number	Page #	Catalog Number	Page #	Catalog Number	Page #	Catalog Number	Page #
NT1616	L-11	PAT600-18V	N-22	PATMDCUT48LLI	N-79	PT10074020	N-78, N-79
NT1714	L-11	PAT600C-18V	N-22	PATMDCUT48LNMH	N-79	PT101128	N-35, N-82, N-97
NT1715	L-11	PAT600C-LI	N-21	PATMDCUT60LLI	N-79	PT11018	N-97
NT1717	L-11	PAT600-LI	N-21	PATMDCUT60LNMH	N-79	PT208620	N-13, N-20, N-76
NT1816	L-11	PAT644-LI	N-16	PATMDCUT72LLI	N-79	PT29074-1	N-96, N-97
NT1817	L-11	PAT750CK-18V	N-15	PATMDCUT72LNMH	N-79	PT29091	N-97
NT1818	L-11	PAT750C-LI	N-13	PATMDCUTACSRKIT	N-78, N-79	PT29214-1	N-97
NT1919	L-11	PAT750CXT-18V	N-14	PATMDCUTLI	N-78	PT29279-2	N-27, N-37
NT2020	L-11	PAT750K-18V	N-15	PATMDCUTLIDC	N-78	PT29291	N-7, N-25, N-97
NT2121	L-11	PAT750K-LI	N-15	PATMDCUTSOMI	N-78, N-79	PT29360	N-27, N-37, N-97
NT2222	L-11	PAT750-LI	N-13	PENA1/2	F-4	PT2972	N-27
NYFT3434CCP	K-50	PAT750XT-18V	N-14	PENA13-4	F-4	PT29900-10	N-96
NYFT3434CCR	K-50	PAT81KFT-18V	N-18	PENA13-55GAL	F-4	PT29900-15	N-96
NYT2825	K-58	PAT81KFT-LI	N-17	PENA13-5GAL	F-4	PT29900-25	N-96
NYT2826	K-58	PATCHGLIDC	N-78, N-79	PENA13-8	F-4	PT29901-10	N-96
NYT2828	C-138, K-58	PATCHGR18V	N-10, N-20, N-79	PENA13CARTRIDGE	F-4	PT29901-15	N-96
NYT282C	K-58	PATCHGR250V	N-10, N-22, N-75	PENA13-GAL	F-4	PT29901-25	N-96
NYT2925	C-138, K-58	PATCHGRLI	N-11, N-78, N-79	PENA13-QT	F-4	PT29902-10	N-96
NYT2926	K-58	PATCHGR-LI	N-9, N-17, N-74	PENA-4	F-4	PT29902-15	N-96
NYT2928	K-58	PATCHGR-LIDC	N-15, N-21, N-74	PENA-55GAL	F-4	PT29902-25	N-96
NYT2929	C-138, K-58	PATCUT129ACSR-18V	N-73	PENA-5GAL	F-4	PT4583	N-60, N-61
NYT292C	K-58	PATCUT129-LI	N-72	PENACARTRIDGE	F-4	PT4925	N-66
NYT3125	K-58	PATCUT2156-18V	N-77	PENA-GAL	F-4	PT4931-1	N-66
NYT3126	K-58	PATCUT2156-18V250V	N-77	PENA-QT	F-4	PT4952-1	N-66
NYT3128	K-58	PATCUT2156-18VDC	N-77	PENE-4	F-4	PT6515	N-36
NYT3129	K-58	PATCUT2156-LI	N-76	PENE-55GAL	F-4	PT6545	N-36, N-97
NYT3131	K-58	PATCUT2156-LIDC	N-76	PENE-5GAL	F-4	PT6733	N-27, N-66
NYT3426	C-138, K-58	PATCUT2156-LILCB	N-76	PENE-8	F-4	PT6744	N-66
NYT3428	C-138, K-58	PATCUT245CUAL-18V	N-75	PENE-GAL	F-4	PT76	N-96
NYT3429	C-138, K-58	PATCUT245-LI	N-74	PENE-QT	F-4	PT8504	N-66
NYT3431	K-58	PATHCC1018V	N-71	PENHT1LB	F-4	PT91	N-96
NYT3434	C-138, K-58	PATHCC10ACSR18V	N-71	PENHT-4	F-4	PT93	N-97
NYT3926	K-58	PATHCC10C18V	N-71	PENHT-8	F-4	PT94	N-97
NYT3928	K-58	PATHCC10CACSR18V	N-71	PENHTGAL	F-4	PTV10	B-84
NYT3929	C-138, K-58	PATHCC10CCUAL18V	N-71	PG1025X03D	B-71	PTV14	B-84
NYT3931	K-58	PATHCC10CGUY18V	N-71	PG121-1	N-53	PTV18	B-84
NYT3934	C-138, K-58	PATHCC10CSOL18V	N-71	PG125-1	N-53	PU998	N-7
NYT3939	K-58	PATHCC10CUAL18V	N-71	PG133-1	N-53	PUADP-1	N-9, N-11, N-35
NYT4426	K-58	PATHCC10GUY18V	N-71	PG1425X03D	B-71	Q10F11X02D	B-61
NYT4428	K-58	PATHCC10SOL18V	N-71	PG1825X03D	B-71	Q10F18X02D	B-61
NYT4429	C-138, K-58	PATJAWSCUT	N-23, N-78, N-79	PG-406-1	N-51	Q10F25X03B	B-61
NYT4431	C-138, K-58	PATJAWSMD6	N-23, N-78, N-79	PG-407-1	N-51	Q10F25X03D	B-61
NYT4434	C-138, K-58	PATJAWSMD6-6	N-23, N-78, N-79	PG-408-1	N-51	Q10M25X03D	B-60
NYT4439	K-58	PATJAWSMD6-8	N-24, N-78, N-79	PGHS1425X03D	B-71	Q14F11X02B	B-61
NYT4444	C-138, K-58	PATJAWSMD6K	N-23, N-78, N-79	PGHS1825X03D	B-71	Q14F11X02D	B-61
NYT4628	K-58	PATJMD6-K-14V	N-24	PGN1025X03B	B-73	Q14F18X02B	B-61
NYT4629	K-58	PATJMD6-K-LI	N-23	PGN1025X03D	B-73	Q14F18X02D	B-61
NYT4631	K-58	PATMD6-14V	N-24	PGN1425X03B	B-73	Q14F25X03B	B-61
NYT4634	K-58	PATMD6-6-14V	N-24	PGN1425X03D	B-73	Q14F25X03D	B-61
NYT4639	K-58	PATMD66JC	N-23, N-78, N-79	PGN1825X03B	B-73	Q14M18X02B	B-60
NYT4644	K-58	PATMD6-6-LI	N-23	PGN1825X03D	B-73	Q14M18X02D	B-60
NYT4646	C-138, K-58	PATMD66LICUTKIT1	N-23, N-78	PGP1025X03B	B-72	Q14M25X03B	B-60
OH25	N-60	PATMD66LIWCJ	N-23, N-78	PGP1025X03D	B-72	Q14M25X03D	B-60
OUR840	N-61	PATMD6-8-14V	N-24	PGP1425X03B	B-72	Q18F11X02D	B-61
OUR840-WC	N-61	PATMD6-8-LI	N-23	PGP1425X03D	B-72	Q18F18X02B	B-61
P15K	N-9, N-12, N-35	PATMD68LICUTKIT1	N-23, N-78	PGP1825X03B	B-72	Q18F18X02D	B-61
P8A	F-4	PATMD68LIWCJ	N-23, N-78	PGP1825X03D	B-72	Q18F25X03B	B-61
PAT46-18V	N-10	PATMD6JC	N-23, N-24, N-79	PT10024162	N-81	Q18F25X03D	B-61
PAT46C-18V	N-10	PATMD6KJC	N-23, N-78, N-79	PT10037384	N-72, N-74, N-83	Q18M11X02D	B-60
PAT46C-LI	N-9	PATMD6-LI	N-23	PT10037388	N-72, N-73, N-83	Q18M18X02B	B-60
PAT46-LI	N-9	PATMD6LICUTKIT1	N-23, N-78	PT10038657	N-75, N-84	Q18M18X02D	B-60
PAT46LW-18V	N-11, N-12	PATMD6LIWCJ	N-23, N-78	PT10040663	N-75, N-84	Q18M25X03B	B-60
PAT46LW-LI	N-11, N-12	PATMDCUT14V	N-78	PT10043890	N-83	Q18M25X03D	B-60
PAT4PC834-18V	N-20	PATMDCUT14V250V	N-78	PT10044980	N-75	Q2A1C-2	A-16
PAT4PC834-LI	N-19	PATMDCUT14VDC	N-78	PT10054094	N-84	Q2A26-2N	A-16

ALPHA-NUMERIC INDEX BY CATALOG NUMBER (Continued)

Catalog Number	Page #	Catalog Number	Page #	Catalog Number	Page #	Catalog Number	Page #
Q2A28-2N	A-16	QGFL26B2	A-37, E-64, L-21	QP18M18X02B	B-62	RDMD4-2858D	K-61
Q2A28-4N	A-16	QGFL26B2T6	A-37, E-64, L-21	QP18M18X02D	B-62	RDMD4-28G3	K-61
Q2A31-2N	A-16	QGFL29B1	A-37, E-64, L-21	QP18M25X03B	B-62	RGC39G1	E-63
Q2A31-4N	A-16	QGFL29B1T6	A-37, E-64, L-21	QP18M25X03D	B-62	RGC44G1	E-63
Q2A34-2N	A-16	QGFL31B1	A-37, E-64, L-21	QPX2828	A-8, H-14	RHCC10	N-82
Q2A34-4N	A-16	QGFL31B1T6	A-37, E-64, L-21	QPX2828-Y	A-9	RHCC10ACSR	N-82
Q2A40-2N	A-16	QGFL34B1	A-37, E-64, L-21	QPX282C	A-8, H-14	RHCC10C	N-82
Q2A40-4N	A-16	QGFL34B1T6	A-37, E-64, L-21	QPX282C-Y	A-9	RHCC10CACSR	N-82
Q2A44-4N	A-16	QGFL39B1	A-37, E-64, L-21	QPX2C2C	A-8, H-14	RHCC10CCUAL	N-82
Q2A46-4N	A-16	QGFL39B1T6	A-37, E-64, L-21	QPX2C2C-Y	A-9	RHCC10CGUY	N-82
Q2B28-2N	A-17	QGFL44B1	A-37, E-64, L-21	QPX3428	A-8, H-14	RHCC10CSOL	N-82
Q2B31-2N	A-17	QGFL44B1T6	A-37, E-64, L-21	QPX3428-Y	A-9	RHCC10CUAL	N-82
Q2B40-4N	A-17	QGFL46B1	A-37, E-64, L-21	QPX342C	A-8, H-14	RHCC10GUY	N-82
Q3A28-2N	A-16	QGFL46B1T6	A-37, E-64, L-21	QPX342C-Y	A-9	RHCC10SOL	N-82
Q3A28-4N	A-16	QGFL48B1	A-37, E-64, L-21	QPX3434	A-8, H-14	RHCC129ACSR	N-83
Q3A31-2N	A-16	QIKLITE	E-71	QPX3434-Y	A-9	RHCC245CUAL	N-84
Q3A31-4N	A-16	QIKLITEKIT	E-71	QPX4428	A-8, H-14	RHCCHSA	N-83
Q3A34-2N	A-16	QIKSTIK	E-71	QPX442C	A-8, H-14	RK141-2	B-92
Q3A34-4N	A-16	QN10F18X02B	B-66	QPX4434	A-8, H-14	RK141ABOX100	B-92
Q3A40-4N	A-16	QN10F18X02D	B-66	QPX4444	A-8, H-14	RK142-2	B-92
Q3A44-4N	A-16	QN10F25X03B	B-66	QPX4444-Y	A-9	RK142ABOX100	B-92
Q3A46-4N	A-16	QN10F25X03D	B-66	QQA1C	A-15	RK149-2	A-40
QA1C-2B	A-15	QN10M25X03D	B-65	QQA1C-2	A-15	RK150-2	A-40
QA1C-B	A-15	QN14F11X02B	B-66	QQA26	A-15	RK151-2	A-40
QA26-2B	A-15	QN14F11X02D	B-66	QQA26-2	A-15	RK152-2	A-40
QA26-B	A-15	QN14F18X02B	B-66	QQA28	A-15	RK153-2	A-40
QA28-2B	A-15	QN14F18X02D	B-66	QQA28-2N	A-15	RK194-2	N-67
QA28-2N	A-15	QN14F25X03B	B-66	QQA31	A-15	RK225-2	A-40
QA28-B	A-15	QN14F25X03D	B-66	QQA31-2N	A-15	RK226-2	A-40
QA31-2B	A-15	QN14M18X02B	B-65	QQA34	A-15	RK227-2	A-40
QA31-2N	A-15	QN14M18X02D	B-65	QQA34-2N	A-15	RP50RP02	N-80
QA31-B	A-15	QN14M25X03B	B-65	QQA40-2N	A-15	RP50RP03	N-80
QA34-2B	A-15	QN14M25X03D	B-65	QQA40-4N	A-15	RWRC516	N-87
QA34-2N	A-15	QN18F11X02B	B-66	QQA44-2N	A-15	RWRC916	N-87
QA34-4B	A-15	QN18F11X02D	B-66	QQA44-4N	A-15	RYA25UC	K-63
QA34-B	A-15	QN18F18X02B	B-66	QQA4C	A-15	RYA25UCR	K-63
QA40-2N	A-15	QN18F18X02D	B-66	QQA4C-2	A-15	RYA26UC	K-63
QA40-B	A-15	QN18F25X03B	B-66	QQA8C	A-15	RYA26UCR	K-63
QA44-2N	A-15	QN18F25X03D	B-66	QQA8C-2	A-15	RYA27UC	K-63
QA44-4N	A-15	QN18M18X02B	B-65	QR1C	A-18	RYA27UCR	K-63
QA44-B	A-15	QN18M18X02D	B-65	QR26	A-18	RYA28UC	K-63
QA46-2N	A-15	QN18M25X03B	B-65	QR28	A-18	RYA28UCR	K-63
QA46-B	A-15	QN18M25X03D	B-65	QR31	A-18	RYA29UC	K-63
QA4C-2B	A-15	QP10F18X02B	B-63	QR34	A-18	RYA29UCR	K-63
QA4C-B	A-15	QP10F18X02D	B-63	QR40	A-18	RYA2UC	K-63
QA8C-2B	A-15	QP10F25X03B	B-63	QR4C	A-18	RYA2UCR	K-63
QA8C-B	A-15	QP10F25X03D	B-63	R17A	N-122, N-124	RYA2WAC	K-63
QB1C	A-17	QP10F38X05D	B-63	R17C	N-122, N-124	RYA2WACR	K-63
QB26	A-17	QP10M25X03D	B-62	R22B	N-122, N-124	RYA31	K-63
QB28	A-17	QP14F11X02D	B-63	R24F	N-122, N-124	RYA31AC	K-63
QB31-2N	A-17	QP14F18X02B	B-63	R25D	N-122, N-124	RYA31ACR	K-63
QB4C	A-17	QP14F18X02D	B-63	RA6UCR-SL	K-62	RYA31C-2	K-62
QB8C	A-17	QP14F25X03B	B-63	RA6UC-SL	K-62	RYA31CR-2	K-62
QDA1C	A-18	QP14F25X03D	B-63	RCC1000	N-86	RYA34C-2	K-62
QDA26	A-18	QP14M11X02D	B-62	RCC336	N-86	RYA34CR-2	K-62
QDA28	A-18	QP14M18X02B	B-62	RCC556	N-86	RYA4UC	K-63
QDA31	A-18	QP14M18X02D	B-62	RCC600E	N-86	RYA4UCR	K-63
QDA34	A-18	QP14M25X03B	B-62	RCC750HD	N-86	RYA75AC	K-63
QDA40	A-18	QP14M25X03D	B-62	RCC954ACSR1K	N-86	RYA75ACR	K-63
QDA4C	A-18	QP18F11X02D	B-63	RDM4-28	K-62	RYAC25	K-63
QDA8C	A-18	QP18F18X02B	B-63	RDM5-28T	K-62	RYAC31	K-66
QGFL1CB1	A-37, E-64, L-21	QP18F18X02D	B-63	RDM6-28	K-62	RYAC31-1	K-66
QGFL1CB1T6	A-37, E-64, L-21	QP18F25X03B	B-63	RDM7-28T	K-62	S2D451R-SG1	I-62
QGFL26B1	A-37, E-64, L-21	QP18F25X03D	B-63	RDM8-28	K-62	S2GBP41A	M-33
QGFL26B1T6	A-37, E-64, L-21	QP18M11X02D	B-62	RDMD-28CR	K-61	S2GBP41A12	M-33

ALPHA-NUMERIC INDEX BY CATALOG NUMBER (Continued)

Catalog Number	Page #	Catalog Number	Page #	Catalog Number	Page #	Catalog Number	Page #
S2GBP41A12B2	M-35	S2GBPA483AB2	M-36	SN10	B-48	SWAB19A2N	M-19
S2GBP41AB2	M-35	S2GBPA486A	M-34	SN10B	B-49	SWAB19A-34N	M-19
S2GBP445A	M-33	S2GBPA486A12	M-34	SN14	B-48	SWAB22A2N	M-19
S2GBP445A12	M-33	S2GBPA486A12B2	M-36	SN14B	B-49	SWAB22A-34N	M-19
S2GBP445A12B2	M-35	S2GBPA486AB2	M-36	SN18	B-48	SWAB22A-44N	M-19
S2GBP445AB2	M-35	S2GBPA48A	M-34	SN18B	B-49	SWAB86A2N	M-19
S2GBP44A	M-33	S2GBPA48A12	M-34	SP10	B-47	SWAB86A34N	M-19
S2GBP44A12	M-33	S2GBPA48A12B2	M-36	SP14	B-47	SWAB86A-44N	M-19
S2GBP44A12B2	M-35	S2GBPA48AB2	M-36	SP16	B-47	SWAC18A-2N	M-13
S2GBP44AB2	M-35	S3D451R-SG1	I-62	STKIT08	B-90	SWAC18A-34N	M-13
S2GBP451ASG1HT	I-63	S3D55R-SG1	I-62	STKIT15	B-90	SWAC18A-44N	M-13
S2GBP451ASG4	I-63	S3GBP41A	M-37	STS33A-4N	M-32	SWAC19A-2N	M-13
S2GBP45A	M-33	S3GBP445A	M-37	STS43A-4N	M-32	SWAC19A-34N	M-13
S2GBP45A12	M-33	S3GBP44A	M-37	STS44A-4N	M-32	SWAC19A-44N	M-13
S2GBP45A12B2	M-35	S3GBP45A	M-37	STS44A-4NCG2	M-32	SWAC20A-2N	M-13
S2GBP45AB2	M-35	S3GBP46A	M-37	STS46A6NCG1	M-32	SWAC20A-34N	M-13
S2GBP463ASG1HT	I-63	S3GBP483A	M-37	SW3A20A44N8	M-39	SWAC20A-44N	M-13
S2GBP463ASG6	I-63	S3GBP486A	M-37	SW3A22A44N8	M-39	SWAC21A-34N	M-13
S2GBP46A	M-34	S3GBP48A	M-37	SW3A24A44N8	M-39	SWAC21A-44N	M-13
S2GBP46A12	M-34	S4D48R-SG1	I-62	SW3A86A44N8	M-39	SWAC22A-34N	M-13
S2GBP46A12B2	M-36	S6D441R-SG1	I-62	SW3AB20A44N8	M-40	SWAC22A-44N	M-13
S2GBP46AB2	M-36	SC2	A-3, H-5	SW3AB22A44N8	M-40	SWAC23A-34N	M-13
S2GBP47ASG1	I-63	SC2/0	A-3, H-5	SW3AB24A44N8	M-40	SWAC24A-34N	M-13
S2GBP47ASG2HT	I-63	SC4	A-3, H-5	SW3AB86A44N8	M-40	SWAC24A-44N	M-13
S2GBP483A	M-34	SCB19A	M-29	SWA18A-2N	M-12	SWAC58A-2N	M-13
S2GBP483A12	M-34	SCB20A	M-29	SWA18A-34N	M-12	SWAC58A-34N	M-13
S2GBP483A12B2	M-36	SCB21A	M-29	SWA18A-44N	M-12	SWAC58A-44N	M-13
S2GBP483AB2	M-36	SCB22A	M-29	SWA19A-2N	M-12	SWAC59A-2N	M-13
S2GBP486A	M-34	SCB24A	M-29	SWA19A-34N	M-12	SWAC59A-34N	M-13
S2GBP486A12	M-34	SCB86A	M-29	SWA19A-44N	M-12	SWAC59A-44N	M-13
S2GBP486A12B2	M-36	SD10NCP1CH	N-68	SWA20A-2N	M-12	SWAC86A-44N	M-13
S2GBP486AB2	M-36	SF2A44NL12EX	M-38	SWA20A-34N	M-12	SWAC90A-2N	M-13
S2GBP48A	M-34	SF2A44NL18EX	M-38	SWA20A-44N	M-12	SWAC90A-34N	M-13
S2GBP48A12	M-34	SH2GBP41A5	M-33	SWA21A-34N	M-12	SWAC90A-44N	M-13
S2GBP48A12B2	M-36	SH2GBP41A512	M-33	SWA21A-44N	M-12	SWAC91A-34N	M-13
S2GBP48AB2	M-36	SH2GBP41A512B2	M-35	SWA22A-44N	M-12	SWAC91A-44N	M-13
S2GBP48ASG1HT	I-63	SH2GBP41A5B2	M-35	SWA23A-44N	M-12	SWAC92A-34N	M-13
S2GBP48ASG2	I-63	SH2GBP445A5	M-33	SWA24A-34N	M-12	SWAC92A-44N	M-13
S2GBP51ASG1	I-63	SH2GBP445A512	M-33	SWA24A-44N	M-12	SWAC93A-34N	M-13
S2GBP51ASG2HT	I-63	SH2GBP445A512B2	M-35	SWA444A-44N	M-11	SWAC94A-34N	M-13
S2GBP52ASG1	I-63	SH2GBP445A5B2	M-35	SWA44R-44N	M-11	SWAC94A-44N	M-13
S2GBP52ASG2HT	I-63	SH2GBP44A5	M-33	SWA486A-44N	M-11	SWAC96A-44N	M-13
S2GBPA41A	M-33	SH2GBP44A512	M-33	SWA486A-4N	M-11	SWAT18A16A-30	M-23
S2GBPA41A12	M-33	SH2GBP44A512B2	M-35	SWA486A-66N	M-11	SWAT18A17A-30	M-23
S2GBPA41A12B2	M-35	SH2GBP44A5B2	M-35	SWA48A-44N	M-11	SWAT18A18A-30	M-23
S2GBPA41AB2	M-35	SH2GBP45A5	M-33	SWA493R-4N	M-11	SWAT19A16A-30	M-23
S2GBPA445A	M-33	SH2GBP45A512	M-33	SWA54R-44N	M-11	SWAT19A17A-30	M-23
S2GBPA445A12	M-33	SH2GBP45A512B2	M-35	SWA58A-2N	M-12	SWAT19A18A-30	M-23
S2GBPA445A12B2	M-35	SH2GBP45A5B2	M-35	SWA58A-34N	M-12	SWAT20A17A-30	M-23
S2GBPA445AB2	M-35	SH2GBP46A5	M-34	SWA58A-44N	M-12	SWAT20A18A-30	M-23
S2GBPA44A	M-33	SH2GBP46A512	M-34	SWA58R-44N	M-11	SWAT20A19A-30	M-23
S2GBPA44A12	M-33	SH2GBP46A512B2	M-36	SWA59A-2N	M-12	SWAT21A16A-30	M-23
S2GBPA44A12B2	M-35	SH2GBP46A5B2	M-36	SWA59A-34N	M-12	SWAT21A17A-30	M-23
S2GBPA44AB2	M-35	SH2GBP483A5	M-34	SWA59A-44N	M-12	SWAT21A18A-30	M-23
S2GBPA45A	M-33	SH2GBP483A512	M-34	SWA86A-44N	M-12	SWAT21A19A-30	M-23
S2GBPA45A12	M-33	SH2GBP483A512B2	M-36	SWA90A-2N	M-12	SWAT21A20A-30	M-23
S2GBPA45A12B2	M-35	SH2GBP483A5B2	M-36	SWA90A-34N	M-12	SWAT22A18A-30	M-23
S2GBPA45AB2	M-35	SH2GBP486A5	M-34	SWA90A-44N	M-12	SWAT22A19A-30	M-23
S2GBPA46A	M-34	SH2GBP486A512	M-34	SWA91A-34N	M-12	SWAT22A20A-30	M-23
S2GBPA46A12	M-34	SH2GBP486A512B2	M-36	SWA91A-44N	M-12	SWAT24A18A-30	M-23
S2GBPA46A12B2	M-36	SH2GBP486A5B2	M-36	SWA92A-44N	M-12	SWAT24A19A-30	M-23
S2GBPA46AB2	M-36	SH2GBP48A5	M-34	SWA93A-44N	M-12	SWAT24A20A-30	M-23
S2GBPA483A	M-34	SH2GBP48A512	M-34	SWA94A-34N	M-12	SWAT86A20A-30	M-23
S2GBPA483A12	M-34	SH2GBP48A512B2	M-36	SWA94A-44N	M-12	SWAT86A21A-30	M-23
S2GBPA483A12B2	M-36	SH2GBP48A5B2	M-36	SWA96A-44N	M-12	SWAT86A22A-30	M-23

ALPHA-NUMERIC INDEX BY CATALOG NUMBER (Continued)

Catalog Number	Page #	Catalog Number	Page #	Catalog Number	Page #	Catalog Number	Page #
SWCB19A	M-30	SWT22A18A	M-21	T10-10	B-5	TFV3B18V2	G-17
SWCB20A	M-30	SWT22A18A75	M-22	T1010BF	B-37	TFV3B6V2	G-17
SWCB22A	M-30	SWT22A19A	M-21	T10-10F	B-27	TFV3BLU12	G-17
SWCB24A	M-30	SWT22A19A75	M-22	T1010LF	B-32	TFV3BLU18	G-17
SWCB86A	M-30	SWT22A20A	M-21	T10-12	B-5	TMH261	D-8
SWHRH18A-3CH	M-25	SWT22A20A75	M-22	T10-14	B-5	TMH261SS	D-8
SWHRH18A-5CH	M-25	SWT22A21A	M-21	T10-14F	B-27	TMH262	D-8
SWHRH19A-3CH	M-25	SWT22A22A	M-21	T10-38	B-5	TMH262SS	D-8
SWHRH19A-5CH	M-25	SWT24A18A75	M-22	T10-516	B-5	TMH263	D-8
SWHRH20A-3CH	M-25	SWT24A19A75	M-22	T10-6	B-5	TMH263SS	D-8
SWHRH20A-5CH	M-25	SWT24A20A	M-21	T106BF	B-37	TMH264	D-8
SWHRH21A-3CH	M-25	SWT24A20A75	M-22	T10-6F	B-27	TMH264SS	D-8
SWHRH21A-5CH	M-25	SWT24A21A	M-21	T106LF	B-32	TMH265	D-8
SWHRH22A-3CH	M-25	SWT24A22A	M-21	T10-8	B-5	TMH265SS	D-8
SWHRH22A-5CH	M-25	SWT24A24A	M-21	T108BF	B-37	TMH266	D-8
SWHRH24A-3CH	M-25	SWT86A20A	M-21	T10-8F	B-27	TMH267	D-8
SWHRH24A-5CH	M-25	SWT86A20A75	M-22	T108LF	B-32	TMH267SS	D-8
SWHRH86A-3CH	M-25	SWT86A21A	M-21	T14-10	B-5	TMH268	D-8
SWHRH86A-5CH	M-25	SWT86A21A75	M-22	T1410BF	B-37	TMH268SS	D-8
SWL18A	M-28	SWT86A22A	M-21	T14-10F	B-27	TMH269	D-8
SWL19A	M-28	SWT86A22A75	M-22	T1410LF	B-32	TMH269SS	D-8
SWL20A	M-28	SWT86A24A	M-21	T14-14	B-5	TMH270	D-8
SWL21A	M-28	SWT86A86A	M-21	T14-14F	B-27	TMH270SS	D-8
SWL22A	M-28	SWVH19A-5	M-26	T14-38	B-5	TMH271	D-8
SWL24A	M-28	SWVH19A-7	M-26	T14-4	B-5	TMH271SS	D-8
SWL58A	M-28	SWVH20A-5	M-26	T14-516	B-5	TMH272	D-8
SWL59A	M-28	SWVH20A-7	M-26	T14-6	B-5	TMH272SS	D-8
SWL86A	M-28	SWVH22A-5	M-26	T146BF	B-37	TMH289	D-8
SWL90A	M-28	SWVH22A-7	M-26	T14-6F	B-27	TMH294	D-8
SWL91A	M-28	SWVH24A-5	M-26	T146LF	B-32	TMH294SS	D-8
SWL92A	M-28	SWVH86A-5	M-26	T14-8	B-5	TMH295	D-8
SWL93A	M-28	SWVH86A-7	M-26	T148BF	B-37	TMH295SS	D-8
SWL96A	M-28	SWXA20A-44N	M-15	T14-8F	B-27	TMH322SS	D-8
SWOH18A-3	M-24	SWXA20A-4NK8	M-14	T148LF	B-32	TMH332	D-8
SWOH18A-5	M-24	SWXA22A-44N	M-15	T1610BF	B-37	TMH69	D-8
SWOH19A-3	M-24	SWXA22A-4NK8	M-14	T1610LF	B-32	TMH69SS	D-8
SWOH19A-5	M-24	SWXA24A-44N	M-15	T166BF	B-37	TN10-10	B-9
SWOH20A-3	M-24	SWXA24A-4NK8	M-14	T166LF	B-32	TN1010BF	B-39
SWOH20A-5	M-24	SWXA86A-44N	M-15	T168BF	B-37	TN10-10F	B-29
SWOH21A-5	M-24	SWXA86A-4NK8	M-14	T168LF	B-32	TN10-10LF	B-34
SWOH22A-3	M-24	SWXA92A-44N	M-15	T18-10	B-5	TN10-12	B-9
SWOH22A-5	M-24	SWXA92A-4NK8	M-14	T18-10F	B-27	TN10-14	B-9
SWOH24A-5	M-24	SWXA94A-44N	M-15	T18-14	B-5	TN10-14F	B-29
SWOH86A-5	M-24	SWXA94A-4NK8	M-14	T18-14F	B-27	TN10-38	B-9
SWT17A17A	M-20	SWXA96A-4NK8	M-14	T18-38	B-5	TN10-516	B-9
SWT18A16A75	M-22	SWXHP19A-5	M-27	T18-4	B-5	TN10-6	B-9
SWT18A17A75	M-22	SWXHP20A-5	M-27	T18-516	B-5	TN106BF	B-39
SWT19A16A75	M-22	SWXHP21A-5	M-27	T18-6	B-5	TN10-6F	B-29
SWT19A17A75	M-22	SWXHP22A-5	M-27	T18-6F	B-27	TN10-6LF	B-34
SWT19A18A75	M-22	SWXHP24A-5	M-27	T18-8	B-5	TN10-8	B-9
SWT19A19A	M-20	SWXHP59A-5	M-27	T18-8F	B-27	TN108BF	B-39
SWT20A17A75	M-22	SWXHP86A-5	M-27	TBPT10	A-42	TN10-8F	B-29
SWT20A18A75	M-22	SWXHP90A-5	M-27	TBPT12	A-42	TN10-8LF	B-34
SWT20A19A75	M-22	SWXHP91A-5	M-27	TBPT6	A-42	TN14-10	B-9
SWT21A14A	M-20	SWXHP92A-5	M-27	TBPT8	A-42	TN1410BF	B-39
SWT21A15A	M-20	SWXHP94A-5	M-27	TDM177RG1	I-61	TN14-10F	B-29
SWT21A16A	M-20	SWXHP96A-5	M-27	TDM177RG2	I-61	TN14-10LF	B-34
SWT21A16A75	M-22	SWXP20A20A	M-18	TDM210RG1	I-61	TN14-14	B-9
SWT21A17A	M-21	SWXP22A22A	M-18	TDM210RG2	I-61	TN14-14F	B-29
SWT21A17A75	M-22	SWXP24A24A	M-18	TDM246RG1	I-61	TN14-38	B-9
SWT21A18A	M-21	SWXP86A86A	M-18	TDM330RG1	I-61	TN14-4	B-9
SWT21A18A75	M-22	SWXP90A90A	M-18	TDM393RG1	I-61	TN14-516	B-9
SWT21A19A	M-21	SWXP92A92A	M-18	TDM430RG1	I-61	TN14-6	B-9
SWT21A19A75	M-22	SWXP94A94A	M-18	TDM99RG1	I-61	TN146BF	B-39
SWT21A20A	M-21	SWXP96A96A	M-18	TFV3B12V2	G-17	TN14-6F	B-29

ALPHA-NUMERIC INDEX BY CATALOG NUMBER (Continued)

Catalog Number	Page #	Catalog Number	Page #	Catalog Number	Page #	Catalog Number	Page #
TN14-6G1	B-9	TP14-8LF	B-33	U39ART-2	N-5, N-7	UB317	D-9
TN14-6LF	B-34	TP14-8Z	B-42	U39RT	N-5, N-7	UB318	D-9
TN14-8	B-9	TP16-10	B-8	U3CRT	N-5	UB319	D-9
TN148BF	B-39	TP1610BF	B-38	U3CRTW	N-5	UB328	D-9
TN14-8F	B-29	TP16-10F	B-28	U44XRT	N-5	UB336	D-9
TN14-8LF	B-34	TP16-10LF	B-33	U4CABT	N-5, N-7	UB344	D-9
TN18-10	B-9	TP16-10Z	B-42	U4CRT	N-5, N-7	UB354	D-9
TN1810BF	B-39	TP16-14	B-8	U4CRTW	N-5, N-7	UB357	D-9
TN18-10F	B-29	TP16-2F	B-28	U5CRT	N-5, N-7	UB358	D-9
TN18-10LF	B-34	TP16-2Z	B-42	U5CRTW	N-5, N-7	UB383	D-9
TN18-14	B-9	TP16-38	B-8	U6CABT	N-5, N-7	UB384	D-9
TN18-14F	B-29	TP16-4	B-8	U8CABT	N-5	UB390	D-9
TN18-38	B-9	TP16-516	B-8	U8CRT	N-5	UB392	D-9
TN18-4	B-9	TP16-6	B-8	U8CRTW	N-5, N-7	UB399	D-9
TN184F	B-29	TP166BF	B-38	U997	N-7	UB400	D-9
TN18-516	B-9	TP16-6F	B-28	UB101	D-9	UB416	D-9
TN18-6	B-9	TP16-6LF	B-33	UB1027	D-9	UB422	D-9
TN186BF	B-39	TP16-6Z	B-42	UB1028	D-9	UB425	D-9
TN18-6F	B-29	TP16-8	B-8	UB1029	D-9	UB436	D-9
TN18-6G1	B-9	TP168BF	B-38	UB1030	D-9	UB437	D-9
TN18-6LF	B-34	TP16-8F	B-28	UB1031	D-9	UB464	D-9
TN18-8	B-9	TP16-8LF	B-33	UB1032	D-9	UB540	D-9
TN188BF	B-39	TP16-8Z	B-42	UB1033	D-9	UC	N-7
TN18-8F	B-29	TS-KD	N-105	UB104	D-9	UC25R2R	H-16
TN18-8LF	B-34	TS-RD	N-105	UB105	D-9	UC25R2RS	H-16
TN20-2F	B-29	TS-SQ	N-105	UB106	D-9	UC2834	H-13
TN20-6F	B-29	TTV10	B-75	UB107	D-9	UC28R	H-16
TP10-10	B-8	TTV14	B-75	UB124	D-9	UC28RS	H-16
TP1010BF	B-38	TTV18	B-75	UB178	D-9	UC2W28-L	H-10
TP10-10F	B-28	TWT1	G-26	UB187	D-9	UC2W30	H-13
TP10-10LF	B-33	TWT2	G-26	UB199	D-9	UC3040	H-13
TP10-10Z	B-42	U1011	N-7	UB204	D-9	UC32R	H-16
TP10-12	B-8	U1104	N-7	UB222	D-9	UC32RS	H-16
TP10-14	B-8	U1105	N-7	UB224	D-9	UC33R	H-16
TP10-38	B-8	U1CART	N-5, N-7	UB230	D-9	UC3444	H-13
TP10-516	B-8	U1CRT-1	N-5, N-7	UB232	D-9	UC4W28	H-13
TP10-6	B-8	U1CRT-1W	N-5, N-7	UB236	D-9	UC4W28CONKIT	H-18
TP106BF	B-38	U25ART	N-5, N-7	UB242	D-9	UC6W25	H-13
TP10-6F	B-28	U25RT	N-5, N-7	UB244	D-9	UC6W25CONKIT	H-18
TP10-6LF	B-33	U25RTW	N-5, N-7	UB249	D-9	UC8W26-L	H-10
TP10-6Z	B-42	U26ART	N-5, N-7	UB254	D-9	UCCOVER1BOX25	H-18
TP10-8	B-8	U26RT	N-5, N-7	UB257	D-9	UCG25R	H-16
TP108BF	B-38	U26RTW	N-5, N-7	UB258	D-9	UCG25R2R	H-16
TP10-8F	B-28	U27ART	N-5, N-7	UB260	D-9	UCG25R2RS	H-16
TP10-8LF	B-33	U27RT	N-5, N-7	UB261	D-9	UCG25RS	H-16
TP10-8Z	B-42	U27RTW	N-5, N-7	UB262	D-9	UCG28R	H-16
TP14-10	B-8	U28ART	N-5, N-7	UB263	D-9	UCG28RS	H-16
TP1410BF	B-38	U28RT	N-5, N-7	UB264	D-9	UCG32R	H-16
TP14-10F	B-28	U28RTW	N-5, N-7	UB266	D-9	UCG32RS	H-16
TP14-10LF	B-33	U29ART	N-5, N-7	UB267	D-9	UCK-1UL	H-10
TP14-10Z	B-42	U29RT	N-5, N-7	UB268	D-9	UCK-2UL	H-10
TP14-14	B-8	U2CABT	N-5, N-7	UB269	D-9	UCK-3UL	H-10
TP14-2F	B-28	U2CRT	N-5, N-7	UB271	D-9	UCT26RS	H-17
TP14-2Z	B-42	U2CRTW	N-5, N-7	UB275	D-9	UCT32RS	H-17
TP14-38	B-8	U30ART	N-5, N-7	UB282	D-9	UCTCOVER	H-18
TP14-4	B-8	U30RT	N-5, N-7	UB291	D-9	UCU28AC	A-38
TP14-516	B-8	U31ART	N-5, N-7	UB293	D-9	UDIEKITAL	N-7
TP14-6	B-8	U31RT	N-5, N-7	UB294	D-9	UDIEKITCU	N-7
TP146BF	B-38	U32ART	N-5, N-7	UB300	D-9	UDIEKITCUW	N-7
TP14-6F	B-28	U32RT	N-5, N-7	UB302	D-9	UDIEKITHYGRD	N-7
TP14-6LF	B-33	U34ART	N-5, N-7	UB306	D-9	UGS350ULDB	A-35
TP14-6Z	B-42	U34RT	N-5, N-7	UB310	D-9	UGSKIT2	A-33
TP14-8	B-8	U36ART	N-5, N-7	UB311	D-9	UGSKIT250	A-33
TP148BF	B-38	U36RT	N-5, N-7	UB314	D-9	UGSKIT8	A-35
TP14-8F	B-28	U38XRT	N-5	UB315	D-9	UH143	L-17

ALPHA-NUMERIC INDEX BY CATALOG NUMBER (Continued)

Catalog Number	Page #	Catalog Number	Page #	Catalog Number	Page #	Catalog Number	Page #
UH153	L-17	UHR175	L-17	VT4840	L-14	W34RT	N-6
UH155	L-17	UHR183	L-17	VT4844	L-14	W34VT	N-6
UH163	L-17	UHR185	L-17	VT4848	L-14	W36RT	N-6
UH165	L-17	UO	N-7	VVA25	A-20, L-9	W3CRT	N-6
UH173	L-17	UP34R	H-68	VVA25-2	L-9	W3CVT	N-6
UH175	L-17	UP45R	H-68	VVA28	A-20, L-9	W4CRT	N-6
UH183	L-17	UP45R36R	H-68	VVA28-2N	A-20, L-9	W4CVT	N-6
UH185	L-17	UW25R	H-12	VVA2C	A-20, L-9	W5CRT	N-6
UH193	L-17	UW2R	H-12	VVA30	A-20, L-9	W5CVT	N-6
UH195	L-17	VA25	A-20, L-8	VVA30-2N	A-20, L-9	W660	N-6
UH203	L-17	VA252	L-8	VVA30-4N	L-9	W-687	N-66
UH205	L-17	VA28	A-20, L-8	VVA34	A-20, L-9	W-702	N-66
UH225	L-17	VA28-2N	A-20, L-8	VVA34-2N	A-20, L-9	W8CRT	N-6
UHG13A3CH	L-32	VA2C	A-20, L-8	VVA34-4	L-9	W8CVT	N-6
UHG14A-3	L-32	VA30	A-20, L-8	VVA34-4N	A-20, L-9	WAD1015	J-16
UHG14A3CH	L-32	VA30-2N	A-20, L-8	VVA40	A-20, L-9	WAD1029	J-16
UHG15A-3	L-32	VA34	A-20, L-8	VVA40-2N	A-20, L-9	WAD1035	J-16
UHG15A3CH	L-32	VA34-2N	A-20, L-8	VVA40-4N	A-20, L-9	WAD336-15	J-16
UHG15A-5	L-32	VA344	L-8	VVA40-4NCG1	L-9	WAD336-29	J-16
UHG15A5CH	L-32	VA34-4N	A-20	VVA44-2N	L-9	WAD336-35	J-16
UHG16A3CH	L-32	VA40	A-20, L-8	VVA44-4N	L-9	WAD4015	J-16
UHG16A5CH	L-32	VA40-2N	A-20, L-8	VVA46-2N	L-9	WAD4029	J-16
UHG17A-3	L-32	VA404	L-8	VVA46-4NCG2	L-9	WAD4035	J-16
UHG17A3CH	L-32	VA40-4N	A-20, L-8	VVA46-4NCG4	L-9	WAD477-15	J-16
UHG17A-5	L-32	VA44	L-8	VVA48-2N	L-9	WAD477-29	J-16
UHG17A5CH	L-32	VA444	L-8	VYFT3428CCP	K-50	WAD477-35	J-16
UHG18A-3	L-32	VA462N	L-8	VYFT3428CCR	K-50	WAD556-15	J-16
UHG18A3CH	L-32	VA4C	L-8	VYFT3434CCP	K-50	WAD556-29	J-16
UHG18A-5	L-32	VG1	H-9	VYFT3434CCR	K-50	WAD556-35	J-16
UHG18A5CH	L-32	VG2	H-9	VYFT3934CCP	K-50	WAD795-15	J-16
UHG19A-3	L-32	VG3	H-9	VYFT3934CCR	K-50	WAD795-29	J-16
UHG19A3CH	L-32	VG4	H-9	VYFT4434CCP	K-50	WAD795-35	J-16
UHG19A5CH	L-32	VG5	H-9	VYFT4434CCR	K-50	WAS14A-2N	L-35
UHG20A3CH	L-32	VP2828	H-12	W161	N-6	WAS15A-2N	L-35
UHG20A-5	L-32	VP3030	H-12	W162	N-6	WAS15A-34N	L-35
UHG20A5CH	L-32	VP3430	H-12	W163	N-6	WAS16A-2N	L-35
UHG20A7CH	L-32	VP3434	H-12	W166	N-6	WAS16A34N	L-35
UHG21A-3	L-32	VP4030	H-12	W1CRT-1	N-6	WAS17A-2N	L-35
UHG21A3CH	L-32	VP4040	H-12	W1CVT	N-6	WAS17A-34N	L-35
UHG21A5CH	L-32	VP4440	H-12	W239	N-6	WAS18A-2N	L-35
UHG22A3CH	L-32	VP4646	H-12	W241	N-6	WAS18A-34N	L-35
UHG22A-5	L-32	VT2525	A-19, H-15, L-14	W245	N-6	WAS18A44N	L-35
UHG22A5CH	L-32	VT2825	A-19, H-15, L-14	W249	N-6	WAS19A-2N	L-35
UHG24A-3	L-32	VT2828	A-19, H-15, L-14	W25RT	N-6	WAS19A-34N	L-35
UHG24A3CH	L-32	VT2C2C	A-19, H-15, L-14	W25VT	N-6	WAS19A-44N	L-35
UHG24A-5	L-32	VT3025	A-19, H-15, L-14	W26RT	N-6	WAS20A-2N	L-35
UHG24A5CH	L-32	VT3028	L-14	W26VT	N-6	WAS20A-34N	L-35
UHG83A5	L-32	VT3030	A-19, H-15	W27RT	N-6	WAS20A-44N	L-35
UHG86A5CH	L-32	VT3425	A-19, H-15	W27VT	N-6	WAS21A34N	L-35
UHKR11A3	L-33	VT3428	A-19, H-15	W28K	N-23, N-24, N-66	WAS22A34N	L-35
UHKR11A5	L-33	VT3430	A-19, H-15	W28RT	N-6	WAS22A-44N	L-35
UHKR13A3	L-33	VT3434	A-19, H-15	W28VT	N-6	WASC15A2N	L-36
UHKR13A5	L-33	VT4034	L-14	W29RT	N-6	WASC16A34N	L-36
UHKR14A3	L-33	VT4040	A-19, H-15	W29VT	N-6	WASC17A2N	L-36
UHKR14A5	L-33	VT4425	A-19, H-15	W2CRT	N-6	WASC17A34N	L-36
UHKR16A3	L-33	VT4428	A-19, H-15	W2CVT	N-6	WASC18A2N	L-36
UHKR16A5	L-33	VT4430	L-14	W30RT	N-6	WASC18A34N	L-36
UHKR17A3	L-33	VT4434	L-14	W30VT	N-6	WASC19A34N	L-36
UHKR17A5	L-33	VT4440	L-14	W31ART	N-6	WASC19A44N	L-36
UHR133	L-17	VT4444	L-14	W31RT	N-6	WASC20A2N	L-36
UHR135	L-17	VT4628	L-14	W31VT	N-6	WASC20A34N	L-36
UHR153	L-17	VT4630	L-14	W32RT	N-6	WASC20A44N	L-36
UHR153SS	L-17	VT4640	L-14	W32VT	N-6	WASC21A34N	L-36
UHR155	L-17	VT4830	L-14	W33RT	N-6	WASC21A44N	L-36
UHR173	L-17	VT4834	A-19, H-15	W33VT	N-6	WASC22A34N	L-36

ALPHA-NUMERIC INDEX BY CATALOG NUMBER (Continued)

Catalog Number	Page #	Catalog Number	Page #	Catalog Number	Page #	Catalog Number	Page #
WASC22A44N	L-36	WCR36	J-6	WCY65	J-7	WLB86A	M-29
WASC24A44N	L-36	WCR37	J-6	WCY65PB	J-13	WLB90A	M-29
WASC24A66N	L-36	WCY100	J-8	WCY66	J-7	WLB91A	M-29
W-BG	N-66	WCY101	J-8	WCY67	J-7	WLB92A	M-29
WCAB30R-2N	J-13	WCY102	J-8	WCY68	J-7	WLB94A	M-29
WCAB30R-4N	J-13	WCY103	J-8	WCY69	J-7	WLB96A	M-29
WCAY39R-2N	J-13	WCY104	J-8	WCY70	J-7	WS14A	M-17
WCAY39R-4N	J-13	WCY105	J-8	WCY71	J-7	WS15A	M-17
WCAY49R-2N	J-13	WCY106	J-8	WCY72	J-7	WS16A	M-17
WCAY49R-4N	J-13	WCY107	J-8	WCY73	J-7	WS17A	M-17
WCB10	J-6	WCY108	J-8	WCY74	J-7	WS18A	M-17
WCB10C2	J-9	WCY109	J-8	WCY75	J-7	WS19A	M-17
WCB11	J-6	WCY110	J-8	WCY76	J-7	WS20A	M-17
WCB11PB	J-13	WCY111	J-8	WCY77	J-7	WS21A	M-17
WCB12	J-6	WCY112	J-8	WCY78	J-7	WS22A	M-17
WCB13	J-6	WCY113	J-8	WCY79	J-7	WS24A	M-17
WCB14	J-6	WCY114	J-8	WCY80	J-7	WS58A	M-17
WCB15	J-6	WCY115	J-8	WCY81	J-7	WS59A	M-17
WCB16	J-6	WCY116	J-8	WCY82	J-7	WS86A	M-17
WCB17	J-6	WCY117	J-8	WCY83	J-7	WS90A	M-17
WCB18	J-6	WCY118	J-8	WCY84	J-7	WS91A	M-17
WCB19	J-6	WCY119	J-8	WCY85	J-7	WS92A	M-17
WCB20	J-6	WCY120	J-8	WCY86	J-7	WS94A	M-17
WCB20C2	J-9	WCY121	J-8	WCY87	J-7	WS96A	M-17
WCB20C20	J-9	WCY122	J-8	WCY88	J-7	WSBC128A	M-31
WCB21	J-6	WCY123	J-8	WCY89	J-7	WSBC74A	M-31
WCB22	J-6	WCY124	J-8	WCY90	J-7	WSBC83A	M-31
WCB23	J-6	WCY125	J-8	WCY91	J-7	WSL1	J-11
WCB24	J-6	WCY126	J-8	WCY92	J-7	WSL10	J-11
WCB25	J-6	WCY127	J-8	WCY93	J-7	WSL11	J-11
WCB250C2	J-9	WCY128	J-8	WCY94	J-7	WSL12	J-11
WCB250C20	J-9	WCY129	J-8	WCY95	J-7	WSL13	J-11
WCB250C250	J-9	WCY130	J-8	WCY96	J-7	WSL14	J-11
WCB26	J-6	WCY131	J-8	WCY97	J-7	WSL2	J-11
WCB27	J-6	WCY132	J-8	WCY98	J-7	WSL3	J-11
WCB28	J-6	WCY133	J-8	WCY99	J-7	WSL4	J-11
WCB2C2	J-9	WCY134	J-8	WDA8300	N-32	WSL5	J-11
WCB30C2	J-9	WCY135	J-8	WDC4500	N-32	WSL6	J-11
WCB40	J-6	WCY136	J-8	WDIETREE	N-21, N-22, N-66	WSL7	J-11
WCB40C2	J-9	WCY137	J-8	WG19A	L-37	WSL8	J-11
WCB40C20	J-9	WCY138	J-8	WG86A	L-37	WSL9	J-11
WCB40C40	J-9	WCY139	J-8	WHHWB	J-14	WSLB15A	M-16
WCB41	J-6	WCY140	J-8	WHSCWH	J-14	WSLB16A	M-16
WCB42	J-6	WCY145	J-8	WHSGB	J-14	WSLB17A	M-16
WCB43	J-6	WCY48	J-6	WHSPBC	J-14	WSLB18A	M-16
WCB44	J-6	WCY49	J-6	WHSSADP	J-14	WSLB19A	M-16
WCB45	J-6	WCY50	J-6	WHSTA	J-14	WSLB20A	M-16
WCB46	J-6	WCY51	J-6	WHSWB	J-14	WSLB21A	M-16
WCB47	J-6	WCY52	J-7	WHSWHADP	J-14	WSLB22A	M-16
WCB4C4	J-9	WCY53	J-7	Wiley PV Solutions	E-32, E-33	WSLB24A	M-16
WCB30R-4N	J-13	WCY53PB	J-13	WIREMIKE	N-25, N-37, N-67	WSLB55A	M-16
WCBY39R-4N	J-13	WCY54	J-7	WLB15A	M-29	WSLB56A	M-16
WCBY49R-4N	J-13	WCY54PB	J-13	WLB16A	M-29	WSLB57A	M-16
WCCB	J-5	WCY55	J-7	WLB17A	M-29	WSLB58A	M-16
WCCLY	J-5	WCY56	J-7	WLB18A	M-29	WSLB59A	M-16
WCCR	J-5	WCY57	J-7	WLB19A	M-29	WSLB86A	M-16
WCCSY	J-5	WCY58	J-7	WLB20A	M-29	WSLB90A	M-16
WCHAWAS	J-14	WCY59	J-7	WLB21A	M-29	WSLB91A	M-16
WCR29	J-6	WCY60	J-7	WLB22A	M-29	WSLB92A	M-16
WCR30	J-6	WCY61	J-7	WLB24A	M-29	WSLB94A	M-16
WCR31	J-6	WCY62	J-7	WLB55A	M-29	WSLB96A	M-16
WCR32	J-6	WCY63	J-7	WLB56A	M-29	WSM1	J-11
WCR33	J-6	WCY63PB	J-13	WLB57A	M-29	WSM10	J-11
WCR34	J-6	WCY64	J-7	WLB58A	M-29	WSM11	J-11
WCR35	J-6	WCY64PB	J-13	WLB59A	M-29	WSM2	J-11

ALPHA-NUMERIC INDEX BY CATALOG NUMBER (Continued)

Catalog Number	Page #	Catalog Number	Page #	Catalog Number	Page #	Catalog Number	Page #
WSM3	J-11	XA574N	L-10	Y35BH	N-38	YA25-2L	C-35
WSM4	J-11	XA594N	L-10	Y35BH-4	N-38	YA25-2LN	C-35
WSM5	J-11	XBG	N-61	Y35H	N-38	YA252N	C-41
WSM6	J-11	XNBG	N-61	Y35P3	N-27	YA252NTC38	C-41
WSM7	J-11	XOH25	N-61	Y-37.5	K-57	YA252NU	C-19
WSM8	J-11	XP1313	L-16	Y39	N-28	YA252TC14	C-41
WSM9	J-11	XP1414	L-16	Y3934R	C-112	YA252TC14E2	C-41
WSS1	J-11	XP1515	L-16	Y3936R	C-112	YA252TC38	C-41
WSS2	J-11	XP1616	L-16	Y39BH	N-39	YA252TC516	C-41
WT2B2RBYK	J-15	XP1717	L-16	Y4439R	C-112	YA25A1	C-144
WT2B2RBYWABAG	J-15	XP1818	L-16	Y45	N-36	YA25A1S60T516E	C-107
WT2BRBYK	J-15	XP1919	L-16	Y46	N-35	YA25A3	C-144
WT2BRBYWABAG	J-15	XP1919HC	L-16	Y46-2	N-35	YA25A3N69T38E	C-107
WTB	J-12	XP2020	L-16	Y46C	N-35	YA25A5	C-146
WTBASY1	J-12	XP2121	L-16	Y4PC834	N-31	YA25A7	C-146
WTBGBWRBYK	J-15	XP2222	L-16	Y4PC834MBH	N-42	YA25A9	C-144
WTCK	J-12	XP5656	L-16	Y-50	K-57	YA25L2-BOX	C-22
WTHR1S	J-12	Y10-22	N-46	Y500CT-HS	N-32	YA25L2NT14	C-38
WTHY1S	J-12	Y10AC9	N-90	Y60BHU	N-33	YA25L2NT14E1	C-38
WTOCBR	J-12	Y10D	N-45	Y60LW	N-34	YA25L-2TC14	C-35
WTOCY	J-12	Y10MRS1	N-54	Y644HSCASE	N-29	YA25L-2TC14E1	C-35
WTRB	J-15	Y-11	K-57	Y644HSXT	N-29	YA25L-2TC14E2	C-35
WTRBK	J-15	Y122CMR	N-55	Y644MBH	N-40	YA25L-2TC38	C-35
WTRBKNHS	J-15	Y-15	K-57	Y6NCP1	N-68	YA25L4-BOX	C-22
WTRBKNHSBAG	J-15	Y1MRKIT	N-56	Y6NCP1BMNT	N-68	YA25L4TCG1	C-85
WTRBWABAG	J-15	Y1MRTC	N-56	Y6NCP1FTSW	N-68	YA25L6-BOX	C-22
WTRBYK	J-15	Y1MRTCKIT	N-56	Y6NCP1SD	N-68	YA25-LB	C-55
WTRBYKNHS	J-15	Y-22.5	K-57	Y-7.5	K-57	YA25L-BOX	C-22
WTRBYKNHSGAB	J-15	Y-25	K-57	Y750BHXT	N-37	YA25LN50T14E	C-107
WTRBYWABAG	J-15	Y281CR	C-112	Y750CBHXT	N-37	YA25LN64T516E	C-107
WTY	J-15	Y2825R	C-112	Y750CHSXT	N-25	YA25LNT10	C-25
WTYK	J-15	Y2826R	C-112	Y750HSCASE	N-25	YA25LNT14	C-25
WTYKNHS	J-15	Y2827R	C-112	Y750HSXT	N-25	YA25LNT38	C-25
WTYKNHSBAG	J-15	Y282CR	C-112	Y81KFT	N-30	YA25LNT516	C-25
WTYWABAG	J-15	Y284CR	C-112	Y81KFTMBH	N-41	YA25N	C-28
X161	N-61	Y284WR	C-112	Y8MRB-1	N-49	YA25TC10	C-28
X241	N-61	Y286CR	C-112	YA10A-TN	C-143	YA25TC38	C-28
X245	N-61	Y2928R	C-112	YA12A-TN	C-143	YA26	C-29
X247	N-61	Y29BH	N-44	YA15ALKIT	C-17	YA26-2L	C-36
X249	N-61	Y29NC	N-69	YA1C	C-28	YA26-2LH89	H-41
X660	N-61	Y2CNC	N-68	YA1C-2L	C-35	YA26-2LN	C-36
X840	N-61	Y3025R	C-112	YA1C-2LN	C-35	YA262N	C-41
X8CART	N-6	Y3026R	C-112	YA1C2N	C-41	YA262NU	C-19
XA132N	L-10	Y3027R	C-112	YA1C2NU	C-19	YA262TC14	C-41
XA142N	L-10	Y3028R	C-112	YA1C2TC14	C-41	YA262TC14E2	C-41
XA144N	L-10	Y302CR	C-112	YA1C2TC14E2	C-41	YA262TC38	C-41
XA152N	L-10	Y304CR	C-112	YA1C2TC38	C-41	YA26A1	C-144
XA154N	L-10	Y3126R	C-112	YA1CA1	C-144	YA26A13N100T516E	C-107
XA15A-4N	L-29	Y3128R	C-112	YA1CL2	C-22	YA26A3	C-146
XA162N	L-10	Y3129R	C-112	YA1CL2NT14	C-38	YA26A5	C-146
XA164N	L-10	Y3425R	C-112	YA1CL2NT14E2	C-38	YA26A6	C-144
XA16A-4N	L-29	Y3426R	C-112	YA1CL-2TC14	C-35	YA26A6N100T38E	C-107
XA172N	L-10	Y3427R	C-112	YA1CL-2TC14E2	C-35	YA26L2-BOX	C-22
XA174N	L-10	Y3428R	C-112	YA1CL-2TC38	C-35	YA26L2NT14	C-38
XA184N	L-10	Y3429R	C-112	YA1CL4-BOX	C-22	YA26L2NT14E1	C-38
XA18A-4N	L-29	Y342CR	C-112	YA1CL6-BOX	C-22	YA26L-2TC14	C-36
XA194N	L-10	Y3430R	C-112	YA1C-LB	C-55	YA26L-2TC14E1	C-36
XA19A-4N	L-29	Y3431R	C-112	YA1CL-BOX	C-22	YA26L-2TC14E2	C-36
XA204N	L-10	Y3432R	C-112	YA1CLNT10	C-25	YA26L-2TC38	C-36
XA20A-4N	L-29	Y34A	N-27	YA1CLNT14	C-25	YA26L4TCG1	C-85
XA214N	L-10	Y34BH	N-43	YA1CN	C-28	YA26L60	C-22
XA21A-4N	L-29	Y35	N-26	YA1CTC10	C-28	YA26L6-BOX	C-22
XA224N	L-10	Y35/Y39REPKITA	N-27	YA1CTC14	C-28	YA26-LB	C-55
XA22A-4N	L-29	Y35-2	N-26	YA1CTC38	C-28	YA26L-BOX	C-22
XA24A-4N	L-29	Y35B	N-38	YA25	C-28	YA26LN50T14E	C-107

ALPHA-NUMERIC INDEX BY CATALOG NUMBER (Continued)

Catalog Number	Page #	Catalog Number	Page #	Catalog Number	Page #	Catalog Number	Page #
YA26LNT10	C-25	YA29-2LN	C-36	YA302N	C-42	YA31L-NT12-FX	C-50, C-52
YA26LNT14	C-25	YA292N	C-41	YA302N-FXB	C-69	YA31LNT38	C-26
YA26LNT38	C-25	YA292NU	C-19	YA302NU	C-19	YA31L-TC12-FX	C-50
YA26LNT516	C-25	YA292TC38	C-41	YA302TC38	C-42	YA31L-TC14-FX	C-50
YA26N	C-29	YA292TC58E16	C-41	YA30A1	C-144	YA31L-TC34-FX	C-50
YA26TC14	C-29	YA29A1	C-144	YA30A1N131T12E	C-108	YA31L-TC38-FX	C-50
YA26TC516	C-29	YA29A3	C-146	YA30A3	C-146	YA31L-TC516-FX	C-50
YA27	C-29	YA29A5	C-146	YA30A5	C-146	YA31L-TC58-FX	C-50
YA27-2LN	C-36	YA29A9	C-144	YA30A6	C-144	YA31-TC12-FXB	C-59
YA272N	C-41	YA29L2	C-23	YA30A6N100T38E	C-108	YA32	C-29
YA272NU	C-19	YA29L2NT38	C-38	YA30A9N100T516E	C-107	YA32-2L	C-36
YA272TC14E2	C-41	YA29L2NT38E16	C-38	YA30L	C-23	YA32-2LN	C-36
YA272TC38	C-41	YA29L-2TC38	C-36	YA30L1	C-23	YA322N	C-42
YA27A1	C-144	YA29L4	C-23	YA30L24	C-23	YA322N-FXB	C-70
YA27A10S76T516E	C-107	YA29L4TCG1	C-85	YA30L24N100T38E	C-107	YA322NU	C-19
YA27A3	C-144	YA29L7	C-23	YA30L27	C-23	YA322TC38	C-42
YA27A5	C-146	YA29-LB	C-55	YA30L28	C-23	YA322TC38-FXB	C-70
YA27A7	C-146	YA29L-BOX	C-23	YA30-L2NTC-FX	C-62	YA32A1	C-144
YA27L2NT14	C-38	YA29LENT38	C-26	YA30L-2TC-38	C-36	YA32A3	C-146
YA27L2NT38	C-38	YA29LENT516	C-26	YA30-L2TC38-FX	C-62	YA32A5	C-146
YA27L2NT516	C-38	YA29LNT38	C-26	YA30-L2TC516-FX	C-62	YA32A8N106T516E	C-108
YA27L-2TC14E2	C-36	YA29LTC78	C-23	YA30L7	C-23	YA32A9	C-144
YA27L-2TC38	C-36	YA2C	C-28	YA30-LB	C-55	YA32L	C-23
YA27L3	C-22	YA2C-2L	C-35	YA30LN	C-23	YA32L1	C-23
YA27L4-BOX	C-22	YA2C-2LN	C-35	YA30LNT14	C-26	YA32L14	C-23
YA27L4TCG1	C-85	YA2C2N	C-41	YA30LNT38	C-26	YA32L2NT38FX	C-64
YA27-LB	C-55	YA2C2NTC38	C-41	YA30LNT516FX	C-52	YA32-L2NTC-FX	C-62
YA27L-BOX	C-22	YA2C2NU	C-19	YA30L-TC12-FX	C-50	YA32L-2TC38	C-36
YA27LNT14	C-26	YA2C2TC14	C-41	YA30L-TC34-FX	C-50	YA32L-2TC38E5	C-36
YA27LNT38	C-26	YA2C2TC14E2	C-41	YA30L-TC38-FX	C-50	YA32-L2TC38-FX	C-62
YA27LNT516	C-26	YA2C2TC38	C-41	YA30L-TC516-FX	C-50	YA32-LB	C-55
YA28	C-29	YA2C2TC38E2	C-41	YA30L-TC58-FX	C-50	YA32LN	C-23
YA28-2LH114	H-41	YA2C2TC38E6	C-41	YA30N	C-29	YA32LNT12	C-26
YA28-2LH115	H-41	YA2C2TC38SL	C-81	YA30-TC12-FXB	C-59	YA32LNT38	C-26
YA28-2LN	C-36	YA2C2TC38SLBOX500	C-81	YA31	C-29	YA32LNT38FX	C-52
YA282N	C-41	YA2C2TC516E2	C-41	YA31-2LH90	H-41	YA32LNT516FX	C-52
YA282NTC38	C-41	YA2CA1	C-144	YA31-2LN	C-36	YA32L-TC100-FX	C-50
YA282NU	C-19	YA2CA1S91T516E	C-107	YA312N	C-42	YA32L-TC12-FX	C-50
YA282TC14E2	C-41	YA2CA3	C-144	YA312N-FXB	C-69	YA32L-TC38-FX	C-50
YA282TC38	C-41	YA2CA5	C-144	YA312NU	C-19	YA32L-TC58-FX	C-50
YA28A1	C-144	YA2CA5S53T14E	C-107	YA312TC14E2	C-42	YA32LTC78	C-23
YA28A14N100T516E	C-107	YA2CA9	C-146	YA312TC38	C-42	YA32N	C-29
YA28A1N100T38E	C-107	YA2CL2-BOX	C-22	YA312TC38-FXB	C-69	YA32-TC12-FXB	C-59
YA28A3	C-144	YA2CL2NT14	C-38	YA31A1	C-144	YA33	C-29
YA28A5	C-146	YA2CL2NT14E1	C-38	YA31A11N100T516E	C-108	YA33-2LN	C-37
YA28A7	C-146	YA2CL2NT14E2	C-38	YA31A3	C-146	YA332N	C-42
YA28L2	C-23	YA2CL-2TC14	C-35	YA31A5	C-146	YA33L	C-23
YA28L2NT14	C-38	YA2CL-2TC14E1	C-35	YA31A9N100T38E	C-108	YA33N	C-29
YA28L2NTC516	C-36	YA2CL-2TC14E2	C-35	YA31L	C-23	YA34	C-29
YA28L-2TC14E1	C-36	YA2CL-2TC38	C-35	YA31L11	C-23	YA34-2L	C-37
YA28L-2TC14E2	C-36	YA2CL-2TC516	C-35	YA31L2NT38	C-39	YA34-2LH110	H-41
YA28L-2TC38	C-36	YA2CL4-BOX	C-22	YA31L2NT38E16	C-39	YA34-2LH111	H-41
YA28L-2TC38E2	C-36	YA2CL6-BOX	C-22	YA31L2NT38FX	C-64	YA34-2LN	C-37
YA28L3	C-23	YA2C-LB	C-55	YA31L-2NTC516	C-36	YA342LNN119T12E	C-107
YA28L4-BOX	C-23	YA2CL-BOX	C-22	YA31-L2NTC-FX	C-62	YA342LNN131T12E	C-107
YA28L4TCG1	C-85	YA2CLNT10	C-25	YA31L-2TC12	C-36	YA342N	C-42
YA28L56	C-23	YA2CLNT14	C-25	YA31-L2TC12-FX	C-62	YA342N-FXB	C-70
YA28-LB	C-55	YA2CLNT516	C-25	YA31L-2TC14E2	C-36	YA342NU	C-19
YA28L-BOX	C-23	YA2CN	C-28	YA31L-2TC38	C-36	YA342TC14E2	C-42
YA28LNT14	C-26	YA2CTC10	C-28	YA31-L2TC38-FX	C-62	YA342TC38	C-42
YA28LNT38	C-26	YA2CTC14	C-28	YA31L36	C-23	YA342TC38-FXB	C-70
YA28LNT516	C-26	YA2CTC38	C-28	YA31L4TCG1	C-85	YA34A1	C-144
YA28TC38	C-29	YA30	C-29	YA31L7	C-23	YA34A3	C-146
YA29	C-29	YA30-2LH85	H-41	YA31-LB	C-55	YA34A3N131T12E	C-108
YA29-2LH91	H-41	YA30-2LN	C-36	YA31LNT12	C-26	YA34A5	C-146

ALPHA-NUMERIC INDEX BY CATALOG NUMBER (Continued)

Catalog Number	Page #	Catalog Number	Page #	Catalog Number	Page #	Catalog Number	Page #
YA34A7N131T12E	C-108	YA37	C-30	YA39L9	C-24	YA444NU	C-20
YA34A8N131T38E	C-108	YA37-2L	C-37	YA39-LB	C-55	YA444A1	C-144
YA34L	C-23	YA37-2LN	C-37	YA39LNT12	C-26	YA444A3	C-146
YA34L20	C-23	YA372N	C-42	YA39LNT38	C-26	YA44L	C-24
YA34L2NT12E1	C-39	YA37L	C-24	YA39LNT58	C-26	YA44L2	C-24
YA34L2NT38	C-39	YA37L1	C-24	YA39N	C-30	YA44L23	C-24
YA34L2NT38E16	C-39	YA37N	C-30	YA3C	C-28	YA44L2NNTFX	C-64
YA34L2NT38FX	C-64	YA38	C-30	YA3C-2L	C-35	YA44L2NNTFXSL	C-80
YA34-L2NTC38-FX	C-62	YA382-FXBG2	C-70	YA3C2N	C-40	YA44L2NT38FX	C-64
YA34-L2NTC-FX	C-62	YA382-FXBG3	C-70	YA3C2NU	C-18	YA44L-2NTC12E24	C-39
YA34L-2TC12	C-37	YA38-2L	C-37	YA3C2TC14	C-40	YA44-L2NTC-FX	C-62
YA34-L2TC12-FX	C-62	YA38-2LN	C-37	YA3C2TC14E2	C-40	YA44L-2TC12	C-37
YA34L-2TC14E2	C-37	YA382N	C-42	YA3C2TC38	C-40	YA44-L2TC12E3-FX	C-62
YA34L-2TC38	C-37	YA382N-FXB	C-70	YA3C2TC38E2	C-40	YA44-L2TC12-FX	C-62
YA34-L2TC38-FX	C-62	YA382TC38	C-42	YA3C2TC38-FXB	C-68	YA44-L2TC38-FX	C-62
YA34-L2TC516-FX	C-62	YA382TC38-FXB	C-70	YA3C2TC38SL	C-81	YA44-L2TC58-FX	C-62
YA34L37	C-23	YA38L	C-24	YA3C2TC38SLBOX500	C-81	YA44-LB	C-55
YA34L6	C-23	YA38L2ENT38FX	C-64	YA3C2TC516-FXB	C-68	YA44LNT12FX	C-52
YA34L6N131T12E	C-107	YA38L2NNTFX	C-64	YA3CL	C-22	YA44LNT38FX	C-52
YA34L8	C-23	YA38L2NT38FX	C-64	YA3CL-2TC14	C-35	YA44L-TC12-FX	C-50
YA34L9	C-23	YA38-L2NTC-FX	C-62	YA3CL-2TC38	C-35	YA44L-TC58-FX	C-50
YA34-LB	C-55	YA38L-2TC12	C-37	YA3C-LB	C-55	YA44N	C-30
YA34LNT12	C-26	YA38-L2TC12-FX	C-62	YA3CLNT14	C-25	YA44-TC58-FXB	C-59
YA34LNT38	C-26	YA38L-2TC38	C-37	YA3CLNT516	C-25	YA45	C-30
YA34L-TC12-FX	C-50	YA38-L2TC38-FX	C-62	YA3CN	C-28	YA452N	C-42
YA34L-TC38-FX	C-50	YA38-L2TC516-FX	C-62	YA3CTC14	C-28	YA452NU	C-20
YA34L-TC516-FX	C-50	YA38-LB	C-55	YA3CTC38	C-28	YA4532N	C-42
YA34L-TC58-FX	C-50	YA38LNT12FX	C-52	YA40	C-30	YA453L	C-24
YA34N	C-29	YA38LNTM20FX	C-52	YA40-2L	C-37	YA454N	C-47
YA34-TC12-FXB	C-59	YA38L-TC12-FX	C-50	YA40-2LN	C-37	YA454NU	C-20
YA35	C-29	YA38L-TC38-FX	C-50	YA402N	C-42	YA45A5^A	C-146
YA35-2L	C-37	YA38L-TC516-FX	C-50	YA402N-FXB	C-70	YA45L	C-24
YA35-2LN	C-37	YA38L-TC58-FX	C-50	YA402NU	C-20	YA45L2NT38FX	C-64
YA352N	C-42	YA38N	C-30	YA40A1	C-144	YA46	C-30
YA35L	C-23	YA38-TC12-FXB	C-59	YA40A3	C-146	YA462N	C-42
YA35N	C-29	YA38-TC58-FXB	C-59	YA40L	C-24	YA462N-FXB	C-70
YA36	C-29	YA39	C-30	YA40L2NNTFX	C-64	YA462NU	C-20
YA36-2LN	C-37	YA392ENNT	C-42	YA40-L2NTC-FX	C-62	YA464N	C-47
YA362N	C-42	YA39-2L	C-37	YA40L-2TC38	C-37	YA464NU	C-20
YA362NFXB	C-70	YA39-2LN	C-37	YA40-L2TC38-FX	C-62	YA46A3	C-146
YA362NU	C-19	YA392LNN131T12E	C-107	YA40-LB	C-55	YA46A5	C-146
YA362TC38	C-42	YA392N	C-42	YA40LENT12FX	C-52	YA46L	C-24
YA36A1	C-144	YA392NT38	C-42	YA40L-TC12-FX	C-50	YA46N	C-30
YA36A3	C-146	YA392NU	C-20	YA40L-TC38-FX	C-50	YA46-TC58-FXB	C-59
YA36A3N131TD12E	C-108	YA392TC38	C-42	YA40L-TC516-FX	C-50	YA47	C-30
YA36A3N131TD38E	C-108	YA39A1	C-144	YA40L-TC58-FX	C-50	YA472N	C-42
YA36A5	C-146	YA39A1N131TD12E	C-108	YA40-TC58-FXB	C-59	YA472NU	C-20
YA36A9N131TD12E	C-108	YA39A3	C-144	YA41	C-30	YA474N	C-47
YA36L	C-23	YA39A34	C-144	YA41-2L	C-37	YA47N	C-30
YA36L11	C-23	YA39A5	C-146	YA412N	C-42	YA48	C-30
YA36L2ENT38E10FX	C-64	YA39A5N131TD12E	C-108	YA41L	C-24	YA482N	C-42
YA36L2NNT	C-39	YA39A7	C-146	YA41N	C-30	YA482NU	C-20
YA36L2NT38FX	C-64	YA39AM2	C-146	YA42A1	C-144	YA484N	C-47
YA36-L2NTC-FX	C-62	YA39L	C-24	YA42A3	C-144	YA4864N	C-47
YA36L-2TC38	C-37	YA39L2	C-24	YA42A5	C-146	YA48A3	C-146
YA36-L2TC38-FX	C-62	YA39L2NT12E1	C-39	YA42A7	C-146	YA48L	C-24
YA36-LB	C-55	YA39L2NT38	C-39	YA44	C-30	YA48N	C-30
YA36LNT12	C-26	YA39L2NT38E16	C-39	YA44-2L	C-37	YA4C	C-27
YA36LNT38	C-26	YA39-L2NTC-FX	C-62	YA44-2LN	C-37	YA4C-2L	C-35
YA36L-TC12-FX	C-50	YA39L-2TC12E3	C-37	YA442N	C-42	YA4C-2LN	C-35
YA36L-TC58-FX	C-50	YA39L-2TC38	C-37	YA442N-FXB	C-70	YA4C2N	C-40
YA36LTC78	C-23	YA39-L2TC38E10-FX	C-62	YA442NU	C-20	YA4C2NU	C-18
YA36N	C-29	YA39L-2TC58	C-37	YA442TC38	C-42	YA4C2TC14	C-40
YA36-TC12-FXB	C-59	YA39L6	C-24	YA442TC38-FXB	C-70	YA4C2TC14E2	C-40
YA36-TC58-FXB	C-59	YA39L6N131T12E	C-107	YA444N	C-47	YA4C2TC38	C-40

ALPHA-NUMERIC INDEX BY CATALOG NUMBER (Continued)

Catalog Number	Page #	Catalog Number	Page #	Catalog Number	Page #	Catalog Number	Page #
YA4CA1	C-143	YA8C2TC14	C-40	YAD14-4	B-5	YAD31M16E58	B-7
YA4CA3	C-143	YA8C2TC14E2	C-40	YAD14-516	B-5	YAD31M20E34	B-7
YA4CA6	C-143	YA8C2TC14E2-FXB	C-68	YAD14-6	B-5	YAD33M10E38	B-7
YA4CL1-BOX	C-22	YA8C2TC38	C-40	YAD146F	B-27	YAD33M12E12	B-7
YA4CL-2TC14	C-35	YA8C2TC38-FXB	C-68	YAD14-6M	B-5	YAD33M16E58	B-7
YA4CL-2TC14E1	C-35	YA8CA1	C-143	YAD14-8	B-5	YAD33M20E34	B-7
YA4CL-2TC14E2	C-35	YA8CA3	C-143	YAD148F	B-27	YAD36M10E38	B-7
YA4CL-2TC38	C-35	YA8CA3S56T14E	C-107	YAD14-8M	B-5	YAD36M12E12	B-7
YA4CL-2TC516	C-35	YA8CL1-BOX	C-21	YAD18-10	B-5	YAD36M16E58	B-7
YA4CL3-BOX	C-22	YA8C-L1-BOX	C-48	YAD1810F	B-27	YAD36M20E34	B-7
YA4CL4-BOX	C-22	YA8CL2-BOX	C-21	YAD18-10M	B-5	YAD4CM10E38	B-6
YA4CL6-BOX	C-22	YA8C-L2-BOX	C-48	YAD18-14	B-5	YAD4CM12E12	B-6
YA4C-LB	C-55	YA8C-L2TC10	C-34, C-60	YAD1814F	B-27	YAD4CM16E58	B-6
YA4CL-BOX	C-22	YA8CL-2TC10E2	C-34	YAD18-14M	B-5	YAD4CM20E34	B-6
YA4CLNT10	C-25	YA8C-L2TC14	C-34, C-60	YAD18-38	B-5	YAD4CM5E10	B-6
YA4CN	C-28	YA8C-L2TC14E1	C-34, C-60	YAD18-4	B-5	YAD4CM6E14	B-6
YA4CTC10	C-27	YA8C-L2TC14E2	C-34, C-60	YAD18-4M	B-5	YAD4CM8E516	B-6
YA4CTC38	C-28	YA8C-L2TC38	C-34, C-60	YAD18-516	B-5	YAD6CM10E38	B-6
YA5C	C-27	YA8CL3-BOX	C-21	YAD18-6	B-5	YAD6CM12E12	B-6
YA5C-2L	C-35	YA8C-L3-BOX	C-48	YAD186F	B-27	YAD6CM5E10	B-6
YA5C2N	C-40	YA8CL4-BOX	C-21	YAD18-6M	B-5	YAD6CM6E14	B-6
YA5C2NU	C-18	YA8C-L4-BOX	C-48	YAD18-8	B-5	YAD6CM8E516	B-6
YA5CL	C-21	YA8C-LB	C-55	YAD188F	B-27	YAD8CM10E38	B-6
YA5C-LB	C-55	YA8CL-BOX	C-21, C-48	YAD18-8M	B-5	YAD8CM12E12	B-6
YA5CN	C-27	YA8CLNT6	C-25	YAD1CM10E38	B-6	YAD8CM16E58	B-6
YA5CTC14FXB	C-58	YA8CLNT8	C-25	YAD1CM12E12	B-6	YAD8CM4E8	B-6
YA6C	C-27	YA8CTC10	C-27	YAD1CM16E58	B-6	YAD8CM5E10	B-6
YA6C-2L	C-34	YA8CTC14	C-27	YAD1CM20E34	B-6	YAD8CM6E14	B-6
YA6C-2L51	C-34	YA8C-TC14-FXB	C-58	YAD1CM6E14	B-6	YAD8CM8E516	B-6
YA6C-2L52	C-34	YA8CTC38	C-27	YAD1CM8E516	B-6	YAE10N	B-11
YA6C-2LN	C-35	YA-A-KIT1	C-147	YAD25M10E38	B-6	YAE10N11	B-11
YA6C2N	C-40	YA-AKIT2	C-147	YAD25M12E12	B-6	YAE10N110BFBOX	B-40
YA6C2NU	C-18	YA-AKIT3	C-147	YAD25M16E58	B-6	YAE10N110LFBOX	B-35
YA6C2TC14	C-40	YAB25-2LH70	H-41	YAD25M20E34	B-6	YAE10N111BFBOX	B-40
YA6C2TC14E1	C-40	YAB25-2LH71	H-41	YAD25M6E14	B-6	YAE10N111LFBOX	B-35
YA6C2TC14E2	C-40	YAB2C-2LH74	H-41	YAD25M8E516	B-6	YAE10N112BFBOX	B-40
YA6C2TC38	C-40	YAB2C2LH75	H-41	YAD26M10E38	B-7	YAE10N112LFBOX	B-35
YA6C2TC38E2	C-40	YAB344N	C-47	YAD26M12E12	B-7	YAE10N11BOX	B-11
YA6C2TC38E6	C-40	YAB364N	C-47	YAD26M16E58	B-7	YAE10N11M	B-11
YA6C2TC38SL	C-81	YAB394N	C-47	YAD26M20E34	B-7	YAE10N2	B-11
YA6C2TC38SLBOX500	C-81	YAB4C-2LH72	H-41	YAD26M6E14	B-7	YAE10N2BOX	B-11
YA6CA1	C-143	YAC-CASE	N-90	YAD26M8E516	B-7	YAE10N2M	B-11
YA6CA3	C-143	YAC-FC	N-90	YAD27M10E38	B-7	YAE10N3	B-11
YA6CL1-BOX	C-21	YAD10-10	B-5	YAD27M12E12	B-7	YAE10N3BOX	B-11
YA6CL-2TC10	C-34	YAD1010F	B-27	YAD27M16E58	B-7	YAE10N3M	B-11
YA6CL-2TC14	C-34	YAD10-14	B-5	YAD27M20E34	B-7	YAE10N4	B-11
YA6CL-2TC14E	C-34	YAD1014F	B-27	YAD27M8E516	B-7	YAE10N4BOX	B-11
YA6CL-2TC14E1	C-34	YAD10-14M	B-5	YAD28M10E38	B-7	YAE10N4M	B-11
YA6CL-2TC14E2	C-34	YAD10-38	B-5	YAD28M12E12	B-7	YAE10N5	B-11
YA6CL2TC14E2SL	C-80	YAD10-38M	B-5	YAD28M16E58	B-7	YAE10N5BOX	B-11
YA6CL-2TC38	C-35	YAD10-516	B-5	YAD28M20E34	B-7	YAE10N5M	B-11
YA6CL-2TC516	C-35	YAD10-516M	B-5	YAD28M6E14	B-7	YAE10N79	B-11
YA6CL-2TC516E2	C-35	YAD10-6	B-5	YAD28M8E516	B-7	YAE10N79BOX	B-11
YA6CL3-BOX	C-21	YAD106F	B-27	YAD2CM10E38	B-6	YAE10N80FBOX	B-30
YA6CL4-BOX	C-21	YAD10-8	B-5	YAD2CM12E12	B-6	YAE10N81FBOX	B-30
YA6CL-6	C-21	YAD108F	B-27	YAD2CM16E58	B-6	YAE10N82FBOX	B-30
YA6CL-BOX	C-21	YAD10-8M	B-5	YAD2CM20E34	B-6	YAE10N83FBOX	B-30
YA6CLNT6	C-25	YAD14-10	B-5	YAD2CM6E14	B-6	YAE10NBOX	B-11
YA6CN	C-27	YAD1410F	B-27	YAD2CM8E516	B-6	YAE10NM	B-11
YA6CTC10	C-27	YAD14-10M	B-5	YAD30M10E38	B-7	YAE12N	B-11
YA6CTC38	C-27	YAD14-14	B-5	YAD30M12E12	B-7	YAE12N1	B-11
YA6CTC516	C-27	YAD1414F	B-27	YAD30M16E58	B-7	YAE12N1BOX	B-11
YA6CTC8	C-27	YAD14-14M	B-5	YAD30M20E34	B-7	YAE12N1M	B-11
YA8C-2LN	C-34	YAD14-38	B-5	YAD31M10E38	B-7	YAE12N2	B-11
YA8C2NU	C-18	YAD14-38M	B-5	YAD31M12E12	B-7	YAE12N2BOX	B-11

ALPHA-NUMERIC INDEX BY CATALOG NUMBER (Continued)

Catalog Number	Page #	Catalog Number	Page #	Catalog Number	Page #	Catalog Number	Page #
YAE12N2M	B-11	YAE18N15M	B-11	YAEBAF1CPTNOEM	C-12	YAES10N13	B-9
YAE12N7	B-11	YAE18N2	B-11	YAEBAF25NTN	C-12	YAES10N14	B-9
YAE12N7BOX	B-11	YAE18N21	B-11	YAEBAF25NTNOEM	C-12	YAES10N56	B-9
YAE12N7M	B-11	YAE18N21BOX	B-11	YAEBAF25PTN	C-12	YAES10N56F	B-29
YAE12N9	B-11	YAE18N21M	B-11	YAEBAF25PTNOEM	C-12	YAES10N57	B-9
YAE12N9BOX	B-11	YAE18N24	B-11	YAEBAF26NTN	C-12	YAES10N57F	B-29
YAE12N9M	B-11	YAE18N24BOX	B-11	YAEBAF26NTNOEM	C-12	YAES10N58	B-9
YAE12NBOX	B-11	YAE18N24M	B-11	YAEBAF26PTN	C-12	YAES14K10	B-14
YAE12NM	B-11	YAE18N26	B-11	YAEBAF26PTNOEM	C-12	YAES14K53	B-14
YAE12Z2	B-43	YAE18N26BOX	B-11	YAEBAF27NTN	C-12	YAES14K54	B-14
YAE12Z2BOX	B-43	YAE18N26M	B-11	YAEBAF27NTNOEM	C-12	YAES14K6	B-14
YAE12Z3	B-43	YAE18N2BOX	B-11	YAEBAF27PTN	C-12	YAES14K7	B-14
YAE12Z3BOX	B-43	YAE18N2M	B-11	YAEBAF27PTNOEM	C-12	YAES14K8	B-14
YAE12Z4	B-43	YAE18N3	B-11	YAEBAF28NTN	C-12	YAES14K9	B-14
YAE12Z4BOX	B-43	YAE18N3BOX	B-11	YAEBAF28NTNOEM	C-12	YAES14N10	B-9
YAE14N	B-11	YAE18N3M	B-11	YAEBAF28PTN	C-12	YAES14N52	B-9
YAE14N1	B-11	YAE18N56F	B-30	YAEBAF28PTNOEM	C-12	YAES14N53	B-9
YAE14N107BFBOX	B-40	YAE18N56FBOX	B-30	YAEBAF2CNTN	C-12	YAES14N53F	B-29
YAE14N107LFBOX	B-35	YAE18N57F	B-30	YAEBAF2CNTNOEM	C-12	YAES14N54	B-9
YAE14N108BFBOX	B-40	YAE18N57FBOX	B-30	YAEBAF2CPTN	C-12	YAES14N54F	B-29
YAE14N108LFBOX	B-35	YAE18N57FM	B-30	YAEBAF2CPTNOEM	C-12	YAES14N6	B-9
YAE14N109BFBOX	B-40	YAE18N58FBOX	B-30	YAEBAS1CNTN	C-11	YAES14N6F	B-29
YAE14N109LFBOX	B-35	YAE18N60F	B-30	YAEBAS1CNTNOEM	C-11	YAES14N7	B-9
YAE14N1BOX	B-11	YAE18N60FBOX	B-30	YAEBAS1CPTN	C-11	YAES14N8	B-9
YAE14N1M	B-11	YAE18N60FM	B-30	YAEBAS1CPTNOEM	C-11	YAES14N8F	B-29
YAE14N2	B-11	YAE18NBOX	B-11	YAEBAS25NTN	C-11	YAES14N9	B-9
YAE14N2BOX	B-11	YAE18NM	B-11	YAEBAS25NTNOEM	C-11	YAES18K1	B-14
YAE14N2M	B-11	YAE18Z1	B-43	YAEBAS25PTN	C-11	YAES18K2	B-14
YAE14N3	B-11	YAE18Z1BOX	B-43	YAEBAS25PTNOEM	C-11	YAES18K3	B-14
YAE14N3BOX	B-11	YAE18Z2	B-43	YAEBAS26NTN	C-11	YAES18K4	B-14
YAE14N3M	B-11	YAE18Z2BOX	B-43	YAEBAS26NTNOEM	C-11	YAES18K49	B-14
YAE14N4	B-11	YAE18Z3	B-43	YAEBAS26PTN	C-11	YAES18K5	B-14
YAE14N43	B-11	YAE18Z3BOX	B-43	YAEBAS26PTNOEM	C-11	YAES18K50	B-14
YAE14N43BOX	B-11	YAE18Z4	B-43	YAEBAS27NTN	C-11	YAES18N1	B-9
YAE14N43M	B-11	YAE18Z4BOX	B-43	YAEBAS27NTNOEM	C-11	YAES18N1F	B-29
YAE14N4BOX	B-11	YAE22G12	B-10	YAEBAS27PTN	C-11	YAES18N2	B-9
YAE14N4M	B-11	YAE22G12BOX	B-10	YAEBAS27PTNOEM	C-11	YAES18N3	B-9
YAE14N76F	B-30	YAE22G13	B-10	YAEBAS28NTN	C-11	YAES18N3F	B-29
YAE14N76FBOX	B-30	YAE22G13BOX	B-10	YAEBAS28NTNOEM	C-11	YAES18N4	B-9
YAE14N77F	B-30	YAE22G13M	B-10	YAEBAS28PTN	C-11	YAES18N48	B-9
YAE14N77FBOX	B-30	YAE22G14	B-10	YAEBAS28PTNOEM	C-11	YAES18N49	B-9
YAE14N77FM	B-30	YAE22G14BOX	B-10	YAEBAS2CNTN	C-11	YAES18N49F	B-29
YAE14N78F	B-30	YAE22G15	B-10	YAEBAS2CNTNOEM	C-11	YAES18N5	B-9
YAE14N78FBOX	B-30	YAE22G15BOX	B-10	YAEBAS2CPTN	C-11	YAES18N50	B-9
YAE14N78FM	B-30	YAE22G16	B-10	YAEBAS2CPTNOEM	C-11	YAES18N50F	B-29
YAE14NBOX	B-11	YAE22G16BOX	B-10	YAEBAS4CNTN	C-11	YAEV10	B-19
YAE14NM	B-11	YAE22G16M	B-10	YAEBAS4CNTNOEM	C-11	YAEV10BOX	B-19
YAE14Z2	B-43	YAE22G18	B-10	YAEBAS4CPTN	C-11	YAEV10-L36	B-19
YAE14Z2BOX	B-43	YAE22G18BOX	B-10	YAEBAS4CPTNOEM	C-11	YAEV10-L36BOX	B-19
YAE14Z3	B-43	YAE22G18M	B-10	YAEBAS6CNTN	C-11	YAEV10-T11	B-19
YAE14Z3BOX	B-43	YAE22N65F	B-30	YAEBAS6CNTNOEM	C-11	YAEV10-T11BOX	B-19
YAE14Z4	B-43	YAE22N65FBOX	B-30	YAEBAS6CPTN	C-11	YAEV10-T2	B-19
YAE14Z4BOX	B-43	YAE22N65FM	B-30	YAEBAS6CPTNOEM	C-11	YAEV10-T2BOX	B-19
YAE18G43F	B-30	YAE22N66F	B-30	YAES10K11	B-14	YAEV10-T3	B-19
YAE18G43FBOX	B-30	YAE22N66FBOX	B-30	YAES10K11T1	B-14	YAEV10-T3BOX	B-19
YAE18G43FM	B-30	YAE22N66FM	B-30	YAES10K12	B-14	YAEV10-T4	B-19
YAE18N	B-11	YAE22Z1	B-43	YAES10K13	B-14	YAEV10-T4BOX	B-19
YAE18N104BFBOX	B-40	YAE22Z1BOX	B-43	YAES10K14	B-14	YAEV10-T7	B-19
YAE18N104LFBOX	B-35	YAE22Z2	B-43	YAES10K56	B-14	YAEV10-T7BOX	B-19
YAE18N105BFBOX	B-40	YAE22Z2BOX	B-43	YAES10K57	B-14	YAEV14	B-19
YAE18N105LFBOX	B-35	YAE22Z3	B-43	YAES10K58	B-14	YAEV14BOX	B-19
YAE18N106BFBOX	B-40	YAE22Z3BOX	B-43	YAES10N11	B-9	YAEV18	B-19
YAE18N106LFBOX	B-35	YAEBAF1CNTN	C-12	YAES10N11F	B-29	YAEV18BOX	B-19
YAE18N15	B-11	YAEBAF1CNTNOEM	C-12	YAES10N12	B-9	YAEV1C-H	B-21
YAE18N15BOX	B-11	YAEBAF1CPTN	C-12	YAES10N12F	B-29	YAEV1C-H1	B-21

ALPHA-NUMERIC INDEX BY CATALOG NUMBER (Continued)

Catalog Number	Page #	Catalog Number	Page #	Catalog Number	Page #	Catalog Number	Page #
YAEV1C-H2	B-21	YAEV6C-H4	B-21	YAG25L-2TC38-LD	C-77	YAG29L-2TC38-LD	C-77
YAEV1C-H3	B-21	YAEV6C-L	B-20	YAG25L-2TC516E2-LD	C-77	YAG29L-2TC516-LD	C-77
YAEV1C-L	B-20	YAEV6C-L1	B-20	YAG25L-2TC516-LD	C-77	YAG29LTC12FX	C-54
YAEV1C-L1	B-20	YAEV6C-L10	B-20	YAG25LTC12FX	C-53	YAG29LTC12LD	C-74
YAEV1C-L2	B-20	YAEV6C-L2	B-20	YAG25LTC12LD	C-74	YAG29LTC34LD	C-74
YAEV1C-L3	B-20	YAEV6C-L4	B-20	YAG25LTC14FX	C-53	YAG29LTC38FX	C-54
YAEV1C-RH	B-25	YAEV6C-RH	B-25	YAG25LTC14LD	C-74	YAG29LTC38LD	C-74
YAEV1C-RH2	B-25	YAEV6C-RH1	B-25	YAG25LTC38FX	C-53	YAG29LTC516LD	C-74
YAEV1C-RS	B-24	YAEV6C-RS	B-24	YAG25LTC38LD	C-74	YAG29LTC58FX	C-54
YAEV1C-RS2	B-24	YAEV6C-RS1	B-24	YAG25LTC516FX	C-53	YAG2CL-2NTC-LD	C-76
YAEV25-H	B-22	YAEV8C-H	B-21	YAG25LTC516LD	C-74	YAG2CL-2TC14E1-LD	C-76
YAEV25-H1	B-22	YAEV8C-H1	B-21	YAG26L-2NTC-LD	C-77	YAG2CL-2TC14E2-LD	C-76
YAEV25-H2	B-22	YAEV8C-H14	B-21	YAG26L-2TC14E2-LD	C-77	YAG2CL-2TC14-LD	C-76
YAEV25-H3	B-22	YAEV8C-H2	B-21	YAG26L-2TC14-LD	C-77	YAG2CL-2TC38-LD	C-76
YAEV25-H4	B-22	YAEV8C-H3	B-21	YAG26L-2TC38-LD	C-77	YAG2CL-2TC516-LD	C-76
YAEV25-L	B-20	YAEV8C-H4	B-21	YAG26L-2TC516-LD	C-77	YAG2CLTC10LD	C-73
YAEV25-L1	B-20	YAEV8C-L	B-20	YAG26LTC10LD	C-74	YAG2CLTC12FX	C-53
YAEV25-L2	B-20	YAEV8C-L1	B-20	YAG26LTC12FX	C-53	YAG2CLTC12LD	C-73
YAEV25-L3	B-20	YAEV8C-L14	B-20	YAG26LTC12LD	C-74	YAG2CLTC14FX	C-53
YAEV25-L4	B-20	YAEV8C-L14BOX	B-20	YAG26LTC14FX	C-53	YAG2CLTC14LD	C-73
YAEV25-RH	B-25	YAEV8C-L1BOX	B-20	YAG26LTC14LD	C-74	YAG2CLTC38FX	C-53
YAEV25-RS	B-24	YAEV8C-L2	B-20	YAG26LTC34LD	C-74	YAG2CLTC38LD	C-73
YAEV26-H	B-22	YAEV8C-L2BOX	B-20	YAG26LTC38FX	C-53	YAG2CLTC516FX	C-53
YAEV26-H1	B-22	YAEV8C-L3	B-20	YAG26LTC38LD	C-74	YAG2CLTC516LD	C-73
YAEV26-H12	B-22	YAEV8C-L3BOX	B-20	YAG26LTC516FX	C-53	YAG30L-2NTC-LD	C-78
YAEV26-H2	B-22	YAEV8C-L4	B-20	YAG26LTC516LD	C-74	YAG30L-2TC12-LD	C-78
YAEV26-H3	B-22	YAEV8C-L4BOX	B-20	YAG26LTC58LD	C-74	YAG30L-2TC38-LD	C-78
YAEV26-L	B-20	YAEV8C-LBOX	B-20	YAG27L-2NTC-LD	C-77	YAG30LTC12FX	C-54
YAEV26-L1	B-20	YAEV8C-RH	B-25	YAG27L-2TC14E2-LD	C-77	YAG30LTC34LD	C-74
YAEV26-L2	B-20	YAEV8C-RH1	B-25	YAG27L-2TC14-LD	C-77	YAG30LTC38FX	C-54
YAEV26-L3	B-20	YAEV8C-RS	B-24	YAG27L-2TC38-LD	C-77	YAG30LTC58FX	C-54
YAEV26-RH	B-25	YAEV8C-RS1	B-24	YAG27L-2TC516-LD	C-77	YAG30LTC58LD	C-74
YAEV26-RS	B-24	YAFW10HS	B-79	YAG27LTC10LD	C-74	YAG31L-2NTC38-LD	C-78
YAEV2C-H	B-21	YAFW10N	B-78	YAG27LTC12FX	C-53	YAG31L-2NTC-LD	C-78
YAEV2C-H1	B-21	YAFW10NG	B-79	YAG27LTC12LD	C-74	YAG31L-2TC12-LD	C-78
YAEV2C-H2	B-21	YAFW10P	B-78	YAG27LTC14FX	C-53	YAG31L-2TC38-LD	C-78
YAEV2C-H3	B-21	YAFW14HS	B-79	YAG27LTC14LD	C-74	YAG31LNT12LD	C-74
YAEV2C-H4	B-21	YAFW14N	B-78	YAG27LTC38FX	C-53	YAG31LTC12FX	C-54
YAEV2C-L	B-20	YAFW14NG	B-79	YAG27LTC38LD	C-74	YAG31LTC12LD	C-74
YAEV2C-L1	B-20	YAFW14P	B-78	YAG27LTC516FX	C-53	YAG31LTC14FX	C-54
YAEV2C-L2	B-20	YAFW18HS	B-79	YAG27LTC516LD	C-74	YAG31LTC14LD	C-74
YAEV2C-L3	B-20	YAFW18N	B-78	YAG28L-2NT38-LD	C-77	YAG31LTC34LD	C-74
YAEV2C-L4	B-20	YAFW18NG	B-79	YAG28L-2NTC-LD	C-77	YAG31LTC38FX	C-54
YAEV2C-RH	B-25	YAFW18P	B-78	YAG28L-2TC12E1-LD	C-77	YAG31LTC58LD	C-74
YAEV2C-RH1	B-25	YAFX15CLKIT	C-17	YAG28L-2TC12-LD	C-77	YAG31LTC516FX	C-54
YAEV2C-RS	B-24	YAG18TC516LD	C-73	YAG28L-2TC14E2-LD	C-77	YAG31LTC516LD	C-74
YAEV2C-RS1	B-24	YAG1CL-2NTC-LD	C-77	YAG28L-2TC14-LD	C-77	YAG31LTC58FX	C-54
YAEV4C-H	B-21	YAG1CL-2TC14E1-LD	C-77	YAG28L-2TC38-LD	C-77	YAG31LTC58LD	C-74
YAEV4C-H2	B-21	YAG1CL-2TC14E2-LD	C-77	YAG28L-2TC516-LD	C-77	YAG32L-2NTC-LD	C-78
YAEV4C-H3	B-21	YAG1CL-2TC14-LD	C-77	YAG28LTC12LD	C-54	YAG32L-2TC38-LD	C-78
YAEV4C-H4	B-21	YAG1CL-2TC38-LD	C-77	YAG28LTC12LD	C-74	YAG32LTC12FX	C-54
YAEV4C-H5	B-21	YAG1CL-2TC516-LD	C-77	YAG28LTC14FX	C-54	YAG32LTC12LD	C-74
YAEV4C-L	B-20	YAG1CLTC10LD	C-73	YAG28LTC14LD	C-74	YAG32LTC38LD	C-74
YAEV4C-L2	B-20	YAG1CLTC12FX	C-53	YAG28LTC38FX	C-54	YAG32LTC58FX	C-54
YAEV4C-L3	B-20	YAG1CLTC12LD	C-73	YAG28LTC38LD	C-74	YAG32LTC58LD	C-74
YAEV4C-L4	B-20	YAG1CLTC14FX	C-53	YAG28LTC516FX	C-54	YAG34L-2NT38-LD	C-78
YAEV4C-L5	B-20	YAG1CLTC14LD	C-73	YAG28LTC516LD	C-74	YAG34L-2NTC-LD	C-78
YAEV4C-RH	B-25	YAG1CLTC38FX	C-53	YAG28LTC516N66LD	C-74	YAG34L-2TC12-LD	C-78
YAEV4C-RH2	B-25	YAG1CLTC38LD	C-73	YAG28LTC58LD	C-74	YAG34L-2TC38-LD	C-78
YAEV4C-RS	B-24	YAG1CLTC516FX	C-53	YAG29L-2NT38-LD	C-77	YAG34L-2TC516-LD	C-78
YAEV4C-RS2	B-24	YAG1CLTC516LD	C-73	YAG29L-2NTC-LD	C-77	YAG34LNT516N66LD	C-75
YAEV6C-H	B-21	YAG25L-2NTC-LD	C-77	YAG29L-2TC12E1-LD	C-77	YAG34LTC12FX	C-54
YAEV6C-H1	B-21	YAG25L-2TC12E1-LD	C-77	YAG29L-2TC12-LD	C-77	YAG34LTC12LD	C-75
YAEV6C-H10	B-21	YAG25L-2TC14E2-LD	C-77	YAG29L-2TC14E2-LD	C-77	YAG34LTC38FX	C-54
YAEV6C-H2	B-21	YAG25L-2TC14-LD	C-77	YAG29L-2TC14-LD	C-77	YAG34LTC38LD	C-75

ALPHA-NUMERIC INDEX BY CATALOG NUMBER (Continued)

Catalog Number	Page #	Catalog Number	Page #	Catalog Number	Page #	Catalog Number	Page #
YAG34LTC516FX	C-54	YAG6CL-2TC10E-LD	C-76	YAGB4CLTC12FX	C-13	YALB120FM12	C-101
YAG34LTC516LD	C-75	YAG6CL-2TC10-LD	C-76	YAGB4CLTC12FXOEM	C-13	YALB120FM14	C-101
YAG34LTC516N66LD	C-75	YAG6CL-2TC14E1-LD	C-76	YAGB4CLTC14FX	C-13	YALB120FM16	C-101
YAG34LTC58FX	C-54	YAG6CL-2TC14E2-LD	C-76	YAGB4CLTC14FXOEM	C-13	YALB120FM20	C-101
YAG34LTC58LD	C-75	YAG6CL-2TC14-LD	C-76	YAGB4CLTC38FX	C-13	YALB120FM8	C-101
YAG36L-2NTC-LD	C-78	YAG6CL-2TC38-LD	C-76	YAGB4CLTC38FXOEM	C-13	YALB120M10	C-91
YAG36L-2TC38-LD	C-78	YAG6CL-2TC516-LD	C-76	YAGB4CLTC516FX	C-13	YALB120M12	C-91
YAG36LTC12LD	C-75	YAG6CLTC10LD	C-73	YAGB4CLTC516FXOEM	C-13	YALB120M14	C-91
YAG36LTC38FX	C-54	YAG6CLTC12FX	C-53	YAGB6CLTC10FX	C-13	YALB120M16	C-91
YAG36LTC58LD	C-75	YAG6CLTC12LD	C-73	YAGB6CLTC10FXOEM	C-13	YALB120M20	C-91
YAG38L-2NT38-LD	C-78	YAG6CLTC14FX	C-53	YAGB6CLTC12FX	C-13	YALB120M8	C-91
YAG38L-2NTC-LD	C-78	YAG6CLTC14LD	C-73	YAGB6CLTC12FXOEM	C-13	YALB1502M10	C-97
YAG38L-2TC12-LD	C-78	YAG6CLTC38FX	C-53	YAGB6CLTC14FX	C-13	YALB1502M12	C-97
YAG38L-2TC38-LD	C-78	YAG6CLTC38LD	C-73	YAGB6CLTC14FXOEM	C-13	YALB1502M14	C-97
YAG38L-2TC516-LD	C-78	YAG6CLTC516FX	C-53	YAGB6CLTC38FX	C-13	YALB1502M16	C-97
YAG38LTC12FX	C-54	YAG6CLTC516LD	C-73	YAGB6CLTC38FXOEM	C-13	YALB1502M20	C-97
YAG38LTC12LD	C-75	YAG8CL-2TC10-LD	C-76	YAGB6CLTC516FX	C-13	YALB1502M8	C-97
YAG38LTC38FX	C-54	YAG8CL-2TC14E1-LD	C-76	YAGB6CLTC516FXOEM	C-13	YALB150F2M10	C-105
YAG38LTC38LD	C-75	YAG8CL-2TC14E2-LD	C-76	YAIT1210Y	B-75	YALB150F2M12	C-105
YAG38LTC516FX	C-54	YAG8CL-2TC14-LD	C-76	YAIT1814B	B-75	YALB150F2M14	C-105
YAG38LTC516LD	C-75	YAG8CL-2TC38-LD	C-76	YAIT2218R	B-75	YALB150F2M16	C-105
YAG38LTC58LD	C-75	YAG8CLTC10LD	C-73	YAK25A-2G1	H-77	YALB150F2M20	C-105
YAG39L-2NTC-LD	C-78	YAG8CLTC12FX	C-53	YAK25A-2G2	H-77	YALB150F2M8	C-105
YAG40L-2NNT-LD	C-78	YAG8CLTC12LD	C-73	YAK28A-2G1	H-77	YALB150FM10	C-101
YAG40L-2NTC-LD	C-78	YAG8CLTC14FX	C-53	YAK28A-2G2	H-77	YALB150FM12	C-101
YAG40L-2TC38-LD	C-78	YAG8CLTC14LD	C-73	YAK29A-2G1	H-77	YALB150FM14	C-101
YAG40LTC12FX	C-54	YAG8CLTC38LD	C-73	YAK2CA2G1	H-77	YALB150FM16	C-101
YAG40LTC12LD	C-75	YAG8CLTC516FX	C-53	YAK2CA2G2	H-77	YALB150FM20	C-101
YAG40LTC14FX	C-54	YAG8CLTC516LD	C-73	YAK311A-2G1	H-77	YALB150FM8	C-101
YAG40LTC38FX	C-54	YAGB25LTC12FX	C-13	YAK311A-2G2	H-77	YALB150M10	C-91
YAG40LTC38LD	C-75	YAGB25LTC12FXOEM	C-13	YAK31A-2G1	H-77	YALB150M12	C-91
YAG40LTC516FX	C-54	YAGB25LTC14FX	C-13	YAK31A-2G2	H-77	YALB150M14	C-91
YAG40LTC516LD	C-75	YAGB25LTC14FXOEM	C-13	YAK34A-2G1	H-77	YALB150M16	C-91
YAG40LTC58LD	C-75	YAGB25LTC38FX	C-13	YAK34A-2G2	H-77	YALB150M20	C-91
YAG44L-2NTC-LD	C-78	YAGB25LTC38FXOEM	C-13	YAK-361A-2G1	H-77	YALB150M8	C-91
YAG44L-2TC12E3-LD	C-78	YAGB25LTC516FX	C-13	YAK-361A-2G2	H-77	YALB162M10	C-96
YAG44L-2TC12-LD	C-78	YAGB25LTC516FXOEM	C-13	YAK39A-2G1	H-77	YALB162M12	C-96
YAG44L-2TC38-LD	C-78	YAGB26LTC12FX	C-13	YAK39A-2G2	H-77	YALB162M4	C-96
YAG44L-2TC58-LD	C-78	YAGB26LTC12FXOEM	C-13	YAK44A-2NG7	H-77	YALB162M5	C-96
YAG44LTC12FX	C-54	YAGB26LTC14FX	C-13	YAK44A-2NG8	H-77	YALB162M6	C-96
YAG44LTC12LD	C-75	YAGB26LTC14FXOEM	C-13	YALB102M10	C-96	YALB162M8	C-96
YAG44LTC38FX	C-54	YAGB26LTC38FX	C-13	YALB102M12	C-96	YALB16M10	C-90
YAG44LTC516FX	C-54	YAGB26LTC38FXOEM	C-13	YALB102M4	C-96	YALB16M12	C-90
YAG44LTC58LD	C-75	YAGB26LTC516FX	C-13	YALB102M5	C-96	YALB16M4	C-90
YAG4CL-2NT10E1-LD	C-76	YAGB26LTC516FXOEM	C-13	YALB102M6	C-96	YALB16M5	C-90
YAG4CL-2NT10-LD	C-76	YAGB28LTC12FX	C-13	YALB102M8	C-96	YALB16M6	C-90
YAG4CL-2NTC-LD	C-76	YAGB28LTC12FXOEM	C-13	YALB10M10	C-90	YALB16M8	C-90
YAG4CL-2TC14E1-LD	C-76	YAGB28LTC14FX	C-13	YALB10M12	C-90	YALB1852M10	C-97
YAG4CL-2TC14E2-LD	C-76	YAGB28LTC14FXOEM	C-13	YALB10M4	C-90	YALB1852M12	C-97
YAG4CL-2TC14-LD	C-76	YAGB28LTC38FX	C-13	YALB10M5	C-90	YALB1852M14	C-97
YAG4CL-2TC38-LD	C-76	YAGB28LTC38FXOEM	C-13	YALB10M6	C-90	YALB1852M16	C-97
YAG4CL-2TC516-LD	C-76	YAGB28LTC516FX	C-13	YALB10M8	C-90	YALB1852M20	C-97
YAG4CLNT10LD	C-73	YAGB28LTC516FXOEM	C-13	YALB1202M10	C-97	YALB1852M8	C-97
YAG4CLTC10LD	C-73	YAGB2CLTC10FX	C-13	YALB1202M12	C-97	YALB185F2M10	C-106
YAG4CLTC12FX	C-53	YAGB2CLTC10FXOEM	C-13	YALB1202M14	C-97	YALB185F2M12	C-106
YAG4CLTC12LD	C-73	YAGB2CLTC12FX	C-13	YALB1202M16	C-97	YALB185F2M14	C-106
YAG4CLTC14FX	C-53	YAGB2CLTC12FXOEM	C-13	YALB1202M20	C-97	YALB185F2M16	C-106
YAG4CLTC14LD	C-73	YAGB2CLTC14FX	C-13	YALB1202M8	C-97	YALB185F2M20	C-106
YAG4CLTC38FX	C-53	YAGB2CLTC14FXOEM	C-13	YALB120F2M10	C-105	YALB185F2M8	C-106
YAG4CLTC38LD	C-73	YAGB2CLTC38FX	C-13	YALB120F2M12	C-105	YALB185FM10	C-102
YAG4CLTC516FX	C-53	YAGB2CLTC38FXOEM	C-13	YALB120F2M14	C-105	YALB185FM12	C-102
YAG4CLTC516LD	C-73	YAGB2CLTC516FX	C-13	YALB120F2M16	C-105	YALB185FM14	C-102
YAG6CL-2NTC-LD	C-76	YAGB2CLTC516FXOEM	C-13	YALB120F2M20	C-105	YALB185FM16	C-102
YAG6CL-2TC10E2-LD	C-76	YAGB4CLTC10FX	C-13	YALB120F2M8	C-105	YALB185FM20	C-102
YAG6CL-2TC10E4-LD	C-76	YAGB4CLTC10FXOEM	C-13	YALB120FM10	C-101	YALB185FM8	C-102

ALPHA-NUMERIC INDEX BY CATALOG NUMBER (Continued)

Catalog Number	Page #	Catalog Number	Page #	Catalog Number	Page #	Catalog Number	Page #
YALB185M10	C-91	YALB35M8	C-90	YALB702M10	C-97	YAV0252M5	C-93
YALB185M12	C-91	YALB4002M12	C-98	YALB702M12	C-97	YAV0252M6	C-93
YALB185M14	C-91	YALB4002M14	C-98	YALB702M14	C-97	YAV0252M8	C-93
YALB185M16	C-91	YALB4002M16	C-98	YALB702M16	C-97	YAV025M3	C-87
YALB185M20	C-91	YALB4002M20	C-98	YALB702M6	C-97	YAV025M4	C-87
YALB185M8	C-91	YALB400F2M12	C-106	YALB702M8	C-97	YAV025M5	C-87
YALB2402M10	C-98	YALB400F2M14	C-106	YALB70F2M10	C-105	YAV025M6	C-87
YALB2402M12	C-98	YALB400F2M16	C-106	YALB70F2M12	C-105	YAV025M8	C-87
YALB2402M14	C-98	YALB400F2M20	C-106	YALB70F2M14	C-105	YAV062M10	C-93
YALB2402M16	C-98	YALB400FM12	C-102	YALB70F2M16	C-105	YAV062M4	C-93
YALB2402M20	C-98	YALB400FM14	C-102	YALB70F2M6	C-105	YAV062M5	C-93
YALB240F2M10	C-106	YALB400FM16	C-102	YALB70F2M8	C-105	YAV062M6	C-93
YALB240F2M12	C-106	YALB400FM20	C-102	YALB70FM10	C-101	YAV062M8	C-93
YALB240F2M14	C-106	YALB400M12	C-92	YALB70FM12	C-101	YAV06M10	C-87
YALB240F2M16	C-106	YALB400M14	C-92	YALB70FM14	C-101	YAV06M4	C-87
YALB240F2M20	C-106	YALB400M16	C-92	YALB70FM16	C-101	YAV06M5	C-87
YALB240FM10	C-102	YALB400M20	C-92	YALB70FM6	C-101	YAV06M6	C-87
YALB240FM12	C-102	YALB5002M12	C-98	YALB70FM8	C-101	YAV06M8	C-87
YALB240FM14	C-102	YALB5002M16	C-98	YALB70M10	C-91	YAV10	B-15
YALB240FM16	C-102	YALB5002M20	C-98	YALB70M12	C-91	YAV102M10	C-93
YALB240FM20	C-102	YALB500F2M12	C-106	YALB70M14	C-91	YAV102M12	C-93
YALB240M10	C-92	YALB500F2M16	C-106	YALB70M16	C-91	YAV102M4	C-93
YALB240M12	C-92	YALB500F2M20	C-106	YALB70M6	C-91	YAV102M5	C-93
YALB240M14	C-92	YALB500FM12	C-102	YALB70M8	C-91	YAV102M6	C-93
YALB240M16	C-92	YALB500FM16	C-102	YALB952M10	C-97	YAV102M8	C-93
YALB240M20	C-92	YALB500FM20	C-102	YALB952M12	C-97	YAV10-2TC10	C-34
YALB252M10	C-96	YALB500M12	C-92	YALB952M14	C-97	YAV102TC1090SL	C-83
YALB252M12	C-96	YALB500M16	C-92	YALB952M16	C-97	YAV10-2TC14	C-34
YALB252M5	C-96	YALB500M20	C-92	YALB952M20	C-97	YAV10-2TC14E1	C-34
YALB252M6	C-96	YALB502M10	C-96	YALB952M8	C-97	YAV10-2TC14E2	C-34
YALB252M8	C-96	YALB502M12	C-96	YALB95F2M10	C-105	YAV10-2TC38	C-34
YALB25M10	C-90	YALB502M14	C-96	YALB95F2M12	C-105	YAV10BOX	B-15, C-21
YALB25M12	C-90	YALB502M16	C-96	YALB95F2M14	C-105	YAV10-H25BOX	B-18
YALB25M5	C-90	YALB502M6	C-96	YALB95F2M16	C-105	YAV10-H3BOX	B-18
YALB25M6	C-90	YALB502M8	C-96	YALB95F2M20	C-105	YAV10-HBOX	B-18
YALB25M8	C-90	YALB50F2M10	C-105	YALB95F2M8	C-105	YAV10-HF	B-45
YALB3002M10	C-98	YALB50F2M12	C-105	YALB95FM10	C-101	YAV10-HFBOX	B-45
YALB3002M12	C-98	YALB50F2M14	C-105	YALB95FM12	C-101	YAV10L36	B-15
YALB3002M14	C-98	YALB50F2M16	C-105	YALB95FM14	C-101	YAV10-L36BOX	B-15
YALB3002M16	C-98	YALB50F2M6	C-105	YALB95FM16	C-101	YAV10M10	C-87
YALB3002M20	C-98	YALB50F2M8	C-105	YALB95FM20	C-101	YAV10M12	C-87
YALB300F2M10	C-106	YALB50FM10	C-101	YALB95FM8	C-101	YAV10M4	C-87
YALB300F2M12	C-106	YALB50FM12	C-101	YALB95M10	C-91	YAV10M5	C-87
YALB300F2M14	C-106	YALB50FM14	C-101	YALB95M12	C-91	YAV10M6	C-87
YALB300F2M16	C-106	YALB50FM16	C-101	YALB95M14	C-91	YAV10M8	C-87
YALB300F2M20	C-106	YALB50FM6	C-101	YALB95M16	C-91	YAV10-R	B-23
YALB300FM10	C-102	YALB50FM8	C-101	YALB95M20	C-91	YAV10-R3BOX	B-23, C-21
YALB300FM12	C-102	YALB50M10	C-90	YALB95M8	C-91	YAV10R-BOX	C-21
YALB300FM14	C-102	YALB50M12	C-90	YASG6CL-2TC14E2-FX	C-79	YAV10T11	B-15
YALB300FM16	C-102	YALB50M14	C-90	YASV6CL-2TC14E2-FX	C-79	YAV10-T11BOX	B-15
YALB300FM20	C-102	YALB50M16	C-90	YASV6CL-2TC14E2-FX-60	C-79	YAV10T2	B-15
YALB300M10	C-92	YALB50M6	C-90	YATW10HS	B-77	YAV10T21F	B-44
YALB300M12	C-92	YALB50M8	C-90	YATW10N	B-76	YAV10-T21FBOX	B-44
YALB300M14	C-92	YALB6302M12	C-98	YATW10NG	B-77	YAV10T23F	B-44
YALB300M16	C-92	YALB6302M16	C-98	YATW10P	B-76	YAV10-T23FBOX	B-44
YALB300M20	C-92	YALB6302M20	C-98	YATW14HS	B-77	YAV10-T2BOX	B-15, C-21
YALB352M10	C-96	YALB630F2M12	C-106	YATW14N	B-76	YAV10T3	B-15
YALB352M12	C-96	YALB630F2M16	C-106	YATW14NG	B-77	YAV10-T3BOX	B-15, C-21
YALB352M5	C-96	YALB630F2M20	C-106	YATW14P	B-76	YAV10T4	B-15
YALB352M6	C-96	YALB630FM12	C-102	YATW18HS	B-77	YAV10-T4BOX	B-15, C-21
YALB352M8	C-96	YALB630FM16	C-102	YATW18N	B-76	YAV10T7	B-15
YALB35M10	C-90	YALB630FM20	C-102	YATW18NG	B-77	YAV10-T7BOX	B-15
YALB35M12	C-90	YALB630M12	C-92	YATW18P	B-76	YAV1202M10	C-94
YALB35M5	C-90	YALB630M16	C-92	YAV0252M3	C-93	YAV1202M12	C-94
YALB35M6	C-90	YALB630M20	C-92	YAV0252M4	C-93	YAV1202M14	C-94

ALPHA-NUMERIC INDEX BY CATALOG NUMBER (Continued)

Catalog Number	Page #	Catalog Number	Page #	Catalog Number	Page #	Catalog Number	Page #
YAV1202M16	C-94	YAV1502M8	C-94	YAV18-L33BOX	B-15	YAV252TC14-FXB	C-69
YAV1202M20	C-94	YAV150F2M10	C-103	YAV18-R	B-23	YAV252TC38-FXB	C-69
YAV1202M8	C-94	YAV150F2M12	C-103	YAV18T1	B-15	YAV25-L	B-17
YAV120F2M10	C-103	YAV150F2M14	C-103	YAV18T19F	B-44	YAV25-L1	B-17
YAV120F2M12	C-103	YAV150F2M16	C-103	YAV18-T19FBOX	B-44	YAV25-L1BOX	B-17
YAV120F2M14	C-103	YAV150F2M20	C-103	YAV18-T1BOX	B-15	YAV25-L2	B-17
YAV120F2M16	C-103	YAV150F2M8	C-103	YAV18T21F	B-44	YAV25-L2BOX	B-17
YAV120F2M20	C-103	YAV150FM10	C-99	YAV18-T21FBOX	B-44	YAV25L2NT14E1FX	C-63
YAV120F2M8	C-103	YAV150FM12	C-99	YAV18T4	B-15	YAV25L2NT14FX	C-63
YAV120FM10	C-99	YAV150FM14	C-99	YAV18-T4BOX	B-15	YAV25L2NT516FX	C-63
YAV120FM12	C-99	YAV150FM16	C-99	YAV18T5	B-15	YAV25-L2NTC-FX	C-61
YAV120FM14	C-99	YAV150FM20	C-99	YAV18-T5BOX	B-15	YAV25-L2TC12E1-FX	C-61
YAV120FM16	C-99	YAV150FM8	C-99	YAV1C2N-FXB	C-69	YAV25-L2TC14E2-FX	C-61
YAV120FM20	C-99	YAV150M10	C-88	YAV1C2TC38-FXB	C-69	YAV25-L2TC14-FX	C-61
YAV120FM8	C-99	YAV150M12	C-88	YAV1C-L	B-17	YAV25-L2TC38-FX	C-61
YAV120M10	C-88	YAV150M14	C-88	YAV1C-L1	B-17	YAV25-L2TC516E2-FX	C-61
YAV120M12	C-88	YAV150M16	C-88	YAV1C-L1BOX	B-17	YAV25-L2TC516-FX	C-61
YAV120M14	C-88	YAV150M20	C-88	YAV1C-L2	B-17	YAV25-L3	B-17
YAV120M16	C-88	YAV150M8	C-88	YAV1C-L2BOX	B-17	YAV25-L3BOX	B-17
YAV120M20	C-88	YAV162M10	C-93	YAV1CL2NT14FX	C-63	YAV25-L4	B-17
YAV120M8	C-88	YAV162M12	C-93	YAV1CL2NT516FX	C-63	YAV25-L4BOX	B-17
YAV12G2	B-15	YAV162M4	C-93	YAV1C-L2NTC-FX	C-61	YAV25L4TC14FXG1	C-85
YAV12-G2BOX	B-15	YAV162M5	C-93	YAV1C-L2TC14E1-FX	C-61	YAV25-LBOX	B-17
YAV12G3	B-15	YAV162M6	C-93	YAV1C-L2TC14E2-FX	C-61	YAV25LNT14FX	C-51
YAV12-G3BOX	B-15	YAV162M8	C-93	YAV1C-L2TC14-FX	C-61	YAV25LNT38FX	C-51
YAV14	B-15	YAV16M10	C-87	YAV1C-L2TC38-FX	C-61	YAV25LNT516FX	C-51
YAV14BOX	B-15	YAV16M12	C-87	YAV1C-L2TC516-FX	C-61	YAV25L-TC12-FX	C-49
YAV14-H1BOX	B-18	YAV16M4	C-87	YAV1C-L3	B-17	YAV25L-TC14-FX	C-49
YAV14-H2BOX	B-18	YAV16M5	C-87	YAV1C-L3BOX	B-17	YAV25L-TC38-FX	C-49
YAV14-H32F	B-45	YAV16M6	C-87	YAV1C-LBOX	B-17	YAV25L-TC516-FX	C-49
YAV14-H32FBOX	B-45	YAV16M8	C-87	YAV1CL-TC10-FX	C-49	YAV25M10	C-87
YAV14-H34F	B-45	YAV18	B-15	YAV1CL-TC12-FX	C-49	YAV25M12	C-87
YAV14-H34FBOX	B-45	YAV1852M10	C-94	YAV1CL-TC14-FX	C-49	YAV25M5	C-87
YAV14-H56F	B-45	YAV1852M12	C-94	YAV1CL-TC38-FX	C-49	YAV25M6	C-87
YAV14-H56FBOX	B-45	YAV1852M14	C-94	YAV1CL-TC516-FX	C-49	YAV25M8	C-87
YAV14-HBOX	B-18	YAV1852M16	C-94	YAV1C-RS1	B-23	YAV25-RS	B-23
YAV14-HF	B-45	YAV1852M20	C-94	YAV1C-RS2	B-23	YAV25-RS3	B-23
YAV14-HFBOX	B-45	YAV1852M8	C-94	YAV1C-TC10-FXB	C-58	YAV25-TC10-FXB	C-59
YAV14L33	B-15	YAV185F2M10	C-103	YAV1C-TC516-FXB	C-58	YAV25-TC12-FXB	C-59
YAV14-L33BOX	B-15	YAV185F2M12	C-103	YAV2402M10	C-94	YAV25-TC38-FXB	C-59
YAV14L36	B-15	YAV185F2M14	C-103	YAV2402M12	C-94	YAV25-TC516-FXB	C-59
YAV14-L36BOX	B-15	YAV185F2M16	C-103	YAV2402M14	C-94	YAV262N-FXB	C-69
YAV14-R	B-23	YAV185F2M20	C-103	YAV2402M16	C-94	YAV262NTC38-FXB	C-69
YAV14-RL33	B-23	YAV185F2M8	C-103	YAV2402M20	C-94	YAV262TC14E2-FXB	C-69
YAV14T1	B-15	YAV185FM10	C-100	YAV240F2M10	C-104	YAV262TC14-FXB	C-69
YAV14-T1BOX	B-15	YAV185FM12	C-100	YAV240F2M12	C-104	YAV262TC38-FXB	C-69
YAV14T2	B-15	YAV185FM14	C-100	YAV240F2M14	C-104	YAV26-L	B-17
YAV14-T2BOX	B-15	YAV185FM16	C-100	YAV240F2M16	C-104	YAV26-L1	B-17
YAV14T3	B-15	YAV185FM20	C-100	YAV240F2M20	C-104	YAV26-L12	B-17
YAV14T32F	B-44	YAV185FM8	C-100	YAV240FM10	C-100	YAV26-L12BOX	B-17
YAV14-T32FBOX	B-44	YAV185M10	C-89	YAV240FM12	C-100	YAV26-L1BOX	B-17
YAV14T34F	B-44	YAV185M12	C-89	YAV240FM14	C-100	YAV26-L2	B-17
YAV14-T34FBOX	B-44	YAV185M14	C-89	YAV240FM16	C-100	YAV26-L2BOX	B-17
YAV14-T3BOX	B-15	YAV185M16	C-89	YAV240FM20	C-100	YAV26L2NT14FX	C-63
YAV14T5	B-15	YAV185M20	C-89	YAV240M10	C-89	YAV26L2NT38FX	C-63
YAV14-T5BOX	B-15	YAV185M8	C-89	YAV240M12	C-89	YAV26L2NT516FX	C-63
YAV14-Z5	B-45	YAV18BOX	B-15	YAV240M14	C-89	YAV26-L2NTC-FX	C-61
YAV14-Z5BOX	B-45	YAV18-H19F	B-45	YAV240M16	C-89	YAV26-L2TC12E1-FX	C-61
YAV14-Z6	B-45	YAV18-H19FBOX	B-45	YAV240M20	C-89	YAV26-L2TC14E2-FX	C-61
YAV14-Z6BOX	B-45	YAV18-H21F	B-45	YAV252M10	C-93	YAV26-L2TC14-FX	C-61
YAV1502M10	C-94	YAV18-H21FBOX	B-45	YAV252M12	C-93	YAV26-L2TC38E10-FX	C-61
YAV1502M12	C-94	YAV18-H6F	B-45	YAV252M5	C-93	YAV26-L2TC38-FX	C-61
YAV1502M14	C-94	YAV18-H6FBOX	B-45	YAV252M6	C-93	YAV26-L2TC516-FX	C-61
YAV1502M16	C-94	YAV18-HBOX	B-18	YAV252M8	C-93	YAV26-L3	B-17
YAV1502M20	C-94	YAV18L33	B-15	YAV252TC14E2-FXB	C-69	YAV26-L3BOX	B-17

ALPHA-NUMERIC INDEX BY CATALOG NUMBER (Continued)

Catalog Number	Page #	Catalog Number	Page #	Catalog Number	Page #	Catalog Number	Page #
YAV26L4TC14FXG1	C-85	YAV28L-TC34-FX	C-49	YAV3002M12	C-95	YAV4C-L3	B-16
YAV26-LBOX	B-17	YAV28L-TC38-FX	C-49	YAV3002M14	C-95	YAV4C-L3BOX	B-16
YAV26LNT12FX	C-51	YAV28L-TC516-FX	C-49	YAV3002M16	C-95	YAV4C-L4	B-16
YAV26LNT38FX	C-51	YAV28L-TC58-FX	C-49	YAV3002M20	C-95	YAV4C-L4BOX	B-16
YAV26LNT516FX	C-51	YAV28-RS	B-23	YAV300F2M10	C-104	YAV4C-L5	B-16
YAV26L-TC10-FX	C-49	YAV28-TC12-FXB	C-59	YAV300F2M12	C-104	YAV4C-L5BOX	B-16
YAV26L-TC12-FX	C-49	YAV28-TC38-FXB	C-59	YAV300F2M14	C-104	YAV4C-LBOX	B-16
YAV26L-TC14-FX	C-49	YAV292N-FXB	C-69	YAV300F2M16	C-104	YAV4CLNT10FX	C-51
YAV26L-TC34-FX	C-49	YAV292NT38-FXB	C-69	YAV300F2M20	C-104	YAV4CL-TC10-FX	C-48
YAV26L-TC38-FX	C-49	YAV292NTC38-FXB	C-69	YAV300FM10	C-100	YAV4CL-TC12-FX	C-48
YAV26L-TC516-FX	C-49	YAV292TC14E2-FXB	C-69	YAV300FM12	C-100	YAV4CL-TC14-FX	C-48
YAV26L-TC58-FX	C-49	YAV292TC38-FXB	C-69	YAV300FM14	C-100	YAV4CL-TC38-FX	C-48
YAV26-RS	B-23	YAV29L2NT38FX	C-64	YAV300FM16	C-100	YAV4CL-TC516-FXB	C-48
YAV26-RS3	B-23	YAV29-L2NTC-FX	C-61	YAV300FM20	C-100	YAV4C-RS	B-23
YAV26-TC12-FXB	C-59	YAV29-L2TC12E1-FX	C-61	YAV300M10	C-89	YAV4C-RS2	B-23
YAV26-TC38-FXB	C-59	YAV29-L2TC12-FX	C-61	YAV300M12	C-89	YAV4C-RS3	B-23
YAV272N-FXB	C-69	YAV29-L2TC14E2-FX	C-61	YAV300M14	C-89	YAV4C-RS4	B-23
YAV272TC14E2-FXB	C-69	YAV29-L2TC14-FX	C-61	YAV300M16	C-89	YAV4C-TC10-FXB	C-58
YAV272TC38-FXB	C-69	YAV29-L2TC38-FX	C-61	YAV300M20	C-89	YAV4C-TC14-FXB	C-58
YAV27-L	B-17	YAV29-L2TC516-FX	C-61	YAV352M10	C-93	YAV4C-TC516-FXB	C-58
YAV27-L1	B-17	YAV29L-TC12-FX	C-49	YAV352M12	C-93	YAV5002M12	C-95
YAV27-L15	B-17	YAV29L-TC14-FX	C-49	YAV352M5	C-93	YAV5002M16	C-95
YAV27-L15BOX	B-17	YAV29L-TC34-FX	C-49	YAV352M6	C-93	YAV5002M20	C-95
YAV27-L1BOX	B-17	YAV29L-TC38-FX	C-49	YAV352M8	C-93	YAV500F2M12	C-104
YAV27-L2NTC-FX	C-61	YAV29L-TC516-FX	C-49	YAV35M10	C-87	YAV500F2M16	C-104
YAV27-L2TC14-FX	C-61	YAV29L-TC58-FX	C-49	YAV35M12	C-87	YAV500F2M20	C-104
YAV27-L2TC38-FX	C-61	YAV2C2N-FXB	C-68	YAV35M5	C-87	YAV500FM12	C-100
YAV27L4TC14FXG1	C-85	YAV2C2TC14E1-FXB	C-68	YAV35M6	C-87	YAV500FM16	C-100
YAV27-LBOX	B-17	YAV2C2TC14E2-FXB	C-68	YAV35M8	C-87	YAV500FM20	C-100
YAV27LNT12FX	C-51	YAV2C2TC14-FXB	C-68	YAV3C2NFXB	C-68	YAV500M12	C-89
YAV27L-TC10-FX	C-49	YAV2C2TC38-FXB	C-68	YAV4002M12	C-95	YAV500M16	C-89
YAV27L-TC12-FX	C-49	YAV2C2TC516-FXB	C-68	YAV4002M14	C-95	YAV500M20	C-89
YAV27L-TC14-FX	C-49	YAV2C-L	B-16	YAV4002M16	C-95	YAV502M10	C-93
YAV27L-TC38-FX	C-49	YAV2C-L1	B-16	YAV4002M20	C-95	YAV502M12	C-93
YAV27L-TC516-FX	C-49	YAV2C-L1BOX	B-16	YAV400F2M12	C-104	YAV502M14	C-93
YAV27-RS	B-23	YAV2C-L2	B-16	YAV400F2M14	C-104	YAV502M16	C-93
YAV27-TC12-FXB	C-59	YAV2C-L2BOX	B-16	YAV400F2M16	C-104	YAV502M6	C-93
YAV282N-FXB	C-69	YAV2CL2NT10FX	C-63	YAV400F2M20	C-104	YAV502M8	C-93
YAV282NT38-FXB	C-69	YAV2CL2NT14E1FX	C-63	YAV400FM12	C-100	YAV50F2M10	C-103
YAV282NTC38-FXB	C-69	YAV2CL2NT14FX	C-63	YAV400FM14	C-100	YAV50F2M12	C-103
YAV282TC14E2-FXB	C-69	YAV2C-L2NTC-FX	C-60	YAV400FM16	C-100	YAV50F2M14	C-103
YAV282TC38-FXB	C-69	YAV2C-L2TC14E1-FX	C-60	YAV400FM20	C-100	YAV50F2M16	C-103
YAV28-L	B-17	YAV2C-L2TC14E2-FX	C-60	YAV400M12	C-89	YAV50F2M6	C-103
YAV28-L12	B-17	YAV2C-L2TC14-FX	C-60	YAV400M14	C-89	YAV50F2M8	C-103
YAV28-L12BOX	B-17	YAV2CL2TC14FXSL	C-80	YAV400M16	C-89	YAV50FM10	C-99
YAV28-L13	B-17	YAV2C-L2TC38-FX	C-60	YAV400M20	C-89	YAV50FM12	C-99
YAV28-L13BOX	B-17	YAV2CL2TC38FXSL	C-80	YAV4C2N-FXB	C-68	YAV50FM14	C-99
YAV28-L14	B-17	YAV2C-L2TC516-FX	C-60	YAV4C2TC14E2-FXB	C-68	YAV50FM16	C-99
YAV28-L14BOX	B-17	YAV2C-L4	B-16	YAV4C2TC14-FXB	C-68	YAV50FM6	C-99
YAV28L2ENT14FX	C-63	YAV2C-L4BOX	B-16	YAV4C2TC38-FXB	C-68	YAV50FM8	C-99
YAV28L2NT38FX	C-63	YAV2CL4TC14FXG1	C-85	YAV4C2TC516-FXB	C-68	YAV50M10	C-88
YAV28-L2NTC-FX	C-61	YAV2C-LBOX	B-16	YAV4C-L	B-16	YAV50M12	C-88
YAV28-L2TC12E1-FX	C-61	YAV2CLNT14FX	C-51	YAV4C-L2	B-16	YAV50M14	C-88
YAV28-L2TC12-FX	C-61	YAV2CLNT516FX	C-51	YAV4C-L2BOX	B-16	YAV50M16	C-88
YAV28-L2TC14E2-FX	C-61	YAV2CL-TC10-FX	C-48	YAV4CL2NT10E1FX	C-63	YAV50M6	C-88
YAV28-L2TC14-FX	C-61	YAV2CL-TC12-FX	C-48	YAV4CL2NT10FX	C-63	YAV50M8	C-88
YAV28-L2TC38-FX	C-61	YAV2CL-TC14-FX	C-48	YAV4CL2NT14FX	C-63	YAV6302M12	C-95
YAV28-L2TC516-FX	C-61	YAV2CL-TC38-FX	C-48	YAV4C-L2NTC-FX	C-60	YAV6302M16	C-95
YAV28L4TC14FXG1	C-85	YAV2CL-TC516-FX	C-48	YAV4C-L2TC14E1-FX	C-60	YAV6302M20	C-95
YAV28-LBOX	B-17	YAV2C-RS	B-23	YAV4C-L2TC14E2-FX	C-60	YAV630F2M12	C-104
YAV28LNT12FX	C-51	YAV2C-RS1	B-23	YAV4C-L2TC14-FX	C-60	YAV630F2M16	C-104
YAV28LNT38FX	C-51	YAV2C-RS2	B-23	YAV4CL2TC14FXSL	C-80	YAV630F2M20	C-104
YAV28LNT516FX	C-51	YAV2C-TC10-FXB	C-58	YAV4C-L2TC38-FX	C-60	YAV630FM12	C-100
YAV28L-TC12-FX	C-49	YAV2C-TC516-FXB	C-58	YAV4CL2TC38FXSL	C-80	YAV630FM16	C-100
YAV28L-TC14-FX	C-49	YAV3002M10	C-95	YAV4C-L2TC516-FX	C-60	YAV630FM20	C-100

ALPHA-NUMERIC INDEX BY CATALOG NUMBER (Continued)

Catalog Number	Page #	Catalog Number	Page #	Catalog Number	Page #	Catalog Number	Page #
YAV630M12	C-89	YAV8C-L	B-16	YAZ26-2N	C-45	YAZ32TC38FX	C-57
YAV630M16	C-89	YAV8C-L1	B-16	YAZ26-2TC14	C-45	YAZ33-2N	C-46
YAV630M20	C-89	YAV8C-L1BOX	B-16	YAZ262TC14E1	C-45	YAZ33TC12	C-33
YAV6C2N-FXB	C-68	YAV8C-L2	B-16	YAZ26-2TC14E2	C-45	YAZ34-2N	C-46
YAV6C2TC14E2-FXB	C-68	YAV8C-L2BOX	B-16	YAZ26-2TC38	C-45	YAZ342NT38FX	C-67, C-71
YAV6C2TC14-FXB	C-68	YAV8C-L3	B-16	YAZ262TC38E16	C-45	YAZ342NTCFX	C-67
YAV6C2TC38-FXB	C-68	YAV8C-L3BOX	B-16	YAZ264TC38E1G1	C-86	YAZ34-2TC14E2	C-46
YAV6C-L	B-16	YAV8C-L4	B-16	YAZ264TCG1	C-86	YAZ342TC14E2FX	C-67
YAV6C-L1	B-16	YAV8C-L4BOX	B-16	YAZ26TC12	C-32	YAZ34-2TC38	C-46
YAV6C-L10	B-16	YAV8C-LBOX	B-16	YAZ26TC14	C-32	YAZ342TC38FX	C-67
YAV6C-L10BOX	B-16	YAV8C-RS	B-23	YAZ26TC38	C-32	YAZ34NT38FX	C-57
YAV6C-L1BOX	B-16	YAV8C-RS1	B-23	YAZ27-2N	C-45	YAZ34TC12	C-33
YAV6C-L2	B-16	YAV8C-RS3	B-23	YAZ27-2TC14E2	C-45	YAZ34TC12FX	C-57
YAV6C-L2BOX	B-16	YAV952M10	C-94	YAZ27-2TC38	C-45	YAZ34TC38	C-33
YAV6C-L2NTC-FX	C-60	YAV952M12	C-94	YAZ27TC12	C-32	YAZ34TC38FX	C-57
YAV6C-L2TC10E2-FX	C-60	YAV952M14	C-94	YAZ27TC38	C-32	YAZ35-2N	C-46
YAV6C-L2TC10E4-FX	C-60	YAV952M16	C-94	YAZ28-2N	C-45	YAZ35TC12	C-33
YAV6C-L2TC10E9-FX	C-60	YAV952M20	C-94	YAZ28-2NTC38	C-45	YAZ36-2N	C-46
YAV6C-L2TC10-FX	C-60	YAV952M8	C-94	YAZ28-2TC14E2	C-45	YAZ36-2TC38	C-46
YAV6CL2TC10FX90SL	C-80	YAV95F2M10	C-103	YAZ28-2TC38	C-45	YAZ362TC38FX	C-67
YAV6C-L2TC14E1-FX	C-60	YAV95F2M12	C-103	YAZ284TCG1	C-86	YAZ36TC12	C-33
YAV6C-L2TC14E2-FX	C-60	YAV95F2M14	C-103	YAZ28TC12	C-32	YAZ36TC38	C-33
YAV6C-L2TC14-FX	C-60	YAV95F2M16	C-103	YAZ28TC38	C-32	YAZ36TC38FX	C-57
YAV6C-L2TC38-FX	C-60	YAV95F2M20	C-103	YAZ29-2N	C-45	YAZ37-2N	C-46
YAV6C-L2TC516-FX	C-60	YAV95F2M8	C-103	YAZ29-2TC38	C-45	YAZ37TC12	C-33
YAV6C-L4	B-16	YAV95FM10	C-99	YAZ294TCG1	C-86	YAZ382ENT38FX	C-72
YAV6C-L4BOX	B-16	YAV95FM12	C-99	YAZ29TC12	C-32	YAZ38-2N	C-46
YAV6C-LBOX	B-16	YAV95FM14	C-99	YAZ29TC38	C-32	YAZ382NNTFX	C-67, C-72
YAV6CL-TC10-FX	C-48	YAV95FM16	C-99	YAZ2C-2N	C-44	YAZ382NT38FX	C-67, C-72
YAV6CL-TC12-FX	C-48	YAV95FM20	C-99	YAZ2C-2NTC38	C-44	YAZ382NTCFX	C-67
YAV6CL-TC14-FX	C-48	YAV95FM8	C-99	YAZ2C-2TC10E2	C-44	YAZ382TC38FX	C-67
YAV6CL-TC34-FX	C-48	YAV95M10	C-88	YAZ2C-2TC14	C-44	YAZ38NT12FX	C-57
YAV6CL-TC38-FX	C-48	YAV95M12	C-88	YAZ2C-2TC14E1	C-44	YAZ38NT38FX	C-57
YAV6CL-TC516-FX	C-48	YAV95M14	C-88	YAZ2C-2TC14E2	C-44	YAZ38TC12	C-33
YAV6C-RS	B-23	YAV95M16	C-88	YAZ2C-2TC38	C-44	YAZ38TC12FX	C-57
YAV6C-RS1	B-23	YAV95M20	C-88	YAZ2C-2TC38E2	C-44	YAZ38TC38FX	C-57
YAV6C-RS2	B-23	YAV95M8	C-88	YAZ2C-2TC38E6	C-44	YAZ39-2N	C-46
YAV6C-RS4	B-23	YAV9CL36	B-15	YAZ2C2TC38SL	C-82	YAZ39-2NNT	C-46
YAV6C-TC10-FXB	C-58	YAV9C-L36BOX	B-15	YAZ2C2TC38SLBOX500	C-82	YAZ39-2NT38	C-46
YAV6C-TC14-FXB	C-58	YAV9CT4	B-15	YAZ2C-2TC516E2	C-44	YAZ39-2TC38	C-46
YAV702M10	C-94	YAV9C-T4BOX	B-15	YAZ2C2TC516E7	C-44	YAZ39NT12	C-33
YAV702M12	C-94	YAV9CT9	B-15	YAZ2CTC12	C-32	YAZ39TC12	C-33
YAV702M14	C-94	YAV9C-T9BOX	B-15	YAZ2CTC14	C-32	YAZ39TC38	C-33
YAV702M16	C-94	YAZ1C-2N	C-44	YAZ2CTC38	C-32	YAZ3C-2N	C-44
YAV702M6	C-94	YAZ1C-2TC14	C-44	YAZ30-2N	C-45	YAZ3C-2TC14	C-44
YAV702M8	C-94	YAZ1C-2TC14E2	C-44	YAZ30-2TC38	C-45	YAZ3C-2TC14E2	C-44
YAV70F2M10	C-103	YAZ1C-2TC38	C-44	YAZ302TC38FX	C-66	YAZ3C-2TC38	C-44
YAV70F2M12	C-103	YAZ1CTC12	C-32	YAZ30TC12	C-32	YAZ3C-2TC38E2	C-44
YAV70F2M14	C-103	YAZ1CTC14	C-32	YAZ30TC38	C-32	YAZ3C2TC38SL	C-82
YAV70F2M16	C-103	YAZ1CTC38	C-32	YAZ30TC38FX	C-57	YAZ3C2TC38SLBOX500	C-82
YAV70F2M6	C-103	YAZ25-2N	C-45	YAZ31-2N	C-45	YAZ3CTC12	C-32
YAV70F2M8	C-103	YAZ25-2NTC38	C-45	YAZ312NTCFX	C-67	YAZ3CTC14	C-32
YAV70FM10	C-99	YAZ25-2TC14	C-45	YAZ31-2TC14E2	C-45	YAZ3CTC38	C-32
YAV70FM12	C-99	YAZ25-2TC14E1	C-45	YAZ312TC14E2FX	C-67	YAZ40-2N	C-46
YAV70FM14	C-99	YAZ25-2TC14E2	C-45	YAZ31-2TC38	C-45	YAZ402NTCFX	C-67
YAV70FM16	C-99	YAZ252TC14E3	C-45	YAZ312TC38FX	C-67	YAZ40TC12	C-33
YAV70FM6	C-99	YAZ25-2TC38	C-45	YAZ314TCG1	C-86	YAZ41-2N	C-46
YAV70FM8	C-99	YAZ25-2TC516	C-45	YAZ31TC12	C-32	YAZ41TC12	C-33
YAV70M10	C-88	YAZ25-2TC516E6	C-45	YAZ31TC38	C-32	YAZ44-2N	C-46
YAV70M12	C-88	YAZ254TC38E1G1	C-86	YAZ31TC38FX	C-57	YAZ442NT38FX	C-67, C-72
YAV70M14	C-88	YAZ254TCG1	C-86	YAZ32-2N	C-45	YAZ44-2TC38	C-46
YAV70M16	C-88	YAZ25TC12	C-32	YAZ32-2TC38	C-45	YAZ44TC12	C-33
YAV70M5	C-88	YAZ25TC14	C-32	YAZ322TC38FX	C-67	YAZ44TC38	C-33
YAV70M6	C-88	YAZ25TC38	C-32	YAZ32TC12	C-32	YAZ45-2N	C-46
YAV70M8	C-88	YAZ25TC516	C-32	YAZ32TC38	C-32	YAZ453-2N	C-46

ALPHA-NUMERIC INDEX BY CATALOG NUMBER (Continued)

Catalog Number	Page #	Catalog Number	Page #	Catalog Number	Page #	Catalog Number	Page #
YAZ453TC12	C-33	YAZV252TC14E2FX	C-66	YAZV6C2TC14FX	C-65	YC25A4	H-22
YAZ45TC12	C-33	YAZV252TC14FX	C-66	YAZV6C2TC14FXSL	C-83	YC25L12	C-129
YAZ46-2N	C-46	YAZV252TC14FXSL	C-84	YAZV6C2TC14FXSLBOX500	C-83	YC26A25	H-22
YAZ46TC12	C-33	YAZV252TC14FXSLBOX500	C-84	YAZV6C2TC38E2FX	C-65	YC26A26	H-22
YAZ47-2N	C-46	YAZV252TC38FX	C-66	YAZV6C2TC38E6FX	C-65	YC26C2	C-130, H-21
YAZ47TC12	C-33	YAZV252TC38FXSL	C-84	YAZV6C2TC38FX	C-65	YC26C26	C-130, H-21
YAZ48-2N	C-46	YAZV252TC38FXSLBOX500	C-84	YAZV6C2TC38FXSL	C-83	YC26L12	C-129
YAZ48TC12	C-33	YAZV25TC12FX	C-57	YAZV6C2TC38FXSLBOX500	C-83	YC27L12	C-129
YAZ4C-2N	C-44	YAZV25TC14FX	C-57	YAZV6CTC14FX	C-56	YC28A2	H-22
YAZ4C-2TC10-E2	C-44	YAZV25TC38FX	C-57	YAZV6CTC38FX	C-56	YC28A25	H-22
YAZ4C-2TC14	C-44	YAZV262NTCFX	C-66	YBA15ALKIT	C-17	YC28A26	H-22
YAZ4C-2TC14E2	C-44	YAZV262TC14E2FX	C-66	YBA25A	C-16	YC28A28	H-22
YAZ4C-2TC38	C-44	YAZV262TC14FX	C-66	YBA26A	C-16	YC28C2	C-130, H-21
YAZ4CTC12	C-31	YAZV262TC14FXSL	C-84	YBA27A	C-16	YC28C26	C-130, H-21
YAZ4CTC14	C-31	YAZV262TC14FXSLBOX500	C-84	YBA28A	C-16	YC28C28	C-130, H-21
YAZ4CTC38	C-31	YAZV262TC38E6FX	C-66	YBA29	C-14	YC28U26	H-25
YAZ5C-2N	C-43	YAZV262TC38FX	C-66	YBA29A	C-16	YC2A2	H-22
YAZ5CTC12	C-31	YAZV262TC38FXSL	C-84	YBA30A	C-16	YC2A4	H-22
YAZ6C-2N	C-43	YAZV262TC38FXSLBOX500	C-84	YBA31A	C-16	YC2C2	C-130, H-21
YAZ6C-2TC10E2	C-43	YAZV26TC12FX	C-57	YBA31FX	C-14	YC2C4	C-130, H-21
YAZ6C-2TC14	C-43	YAZV26TC14FX	C-57	YBA32A	C-16	YC2L12	C-129
YAZ6C-2TC14E1	C-43	YAZV26TC38FX	C-57	YBA32FX	C-14	YC33R26	H-22
YAZ6C-2TC14E2	C-43	YAZV272TC14E2FX	C-66	YBA34A	C-16	YC33R26U	H-25
YAZ6C-2TC38	C-43	YAZV272TC38FX	C-66	YBA34FX	C-14	YC3L12	C-129
YAZ6C2TC38E16	C-43	YAZV27TC38FX	C-57	YBA36A	C-16	YC4A4	H-22
YAZ6C-2TC38E2	C-43	YAZV282NT38FX	C-71	YBA36FX	C-15	YC4A6	H-22
YAZ6C-2TC38E6	C-43	YAZV282NTCFX	C-66	YBA36FX58	C-15	YC4C4	C-130, H-21
YAZ6C2TC38SL	C-82	YAZV282TC14E2FX	C-66	YBA38FX	C-15	YC4C6	C-130, H-21
YAZ6C2TC38SLBOX500	C-82	YAZV282TC14FXSL	C-84	YBA39	C-15	YC4C8	C-130, H-21
YAZ6CTC12	C-31	YAZV282TC14FXSLBOX500	C-84	YBA39A	C-16	YC4L12	C-129
YAZ6CTC14	C-31	YAZV282TC38FX	C-66	YBA42A	C-16	YC4U1	H-25
YAZ6CTC38	C-31	YAZV282TC38FXSL	C-84	YBA44A	C-16	YC6L12	C-129
YAZ8C-2TC10	C-43	YAZV282TC38FXSLBOX500	C-84	YBA44FX	C-15	YC8C8	C-130, H-21
YAZ8C2TC1090SL	C-82	YAZV28NT38FX	C-57	YBA44FX58	C-15	YC8L12	C-129
YAZ8C-2TC10E2	C-43	YAZV28TC12FX	C-57	YBAF15CLKIT	C-17	YCA25-2N	H-73
YAZ8C2TC10E2FX	C-65	YAZV28TC38FX	C-57	YBAV25FX14	C-14	YCA25R-2N	H-75
YAZ8C2TC10FX	C-65	YAZV292NT516FX	C-66, C-71	YBAV26FX14	C-14	YCA25RL-2N	H-74
YAZ8C2TC10SL	C-82	YAZV29NT516FX	C-57	YBAV27FX14	C-14	YCA26-2N	H-73
YAZ8C-2TC14	C-43	YAZV2C2NT14E2FX	C-71	YBAV28FX	C-14	YCA26R-2N	H-75
YAZ8C-2TC14E1	C-43	YAZV2C2NTCFX	C-65	YBM1C-L	B-26	YCA26RL-2N	H-74
YAZ8C2TC14E1FX	C-65	YAZV2C2TC14E2FX	C-65	YBM1C-L3	B-26	YCA27-2N	H-73
YAZ8C-2TC14E2	C-43	YAZV2C2TC14FX	C-65	YBM25-L	B-26	YCA27R-2N	H-75
YAZ8C2TC14E2FX	C-65	YAZV2C2TC14FXSL	C-84	YBM25-L1	B-26	YCA27RL-2N	H-74
YAZ8C2TC14FX	C-65	YAZV2C2TC14FXSLBOX500	C-84	YBM25-L2	B-26	YCA28-2N	H-73
YAZ8C-2TC38	C-43	YAZV2C2TC38FX	C-65	YBM26-L	B-26	YCA28R-2N	H-75
YAZ8C2TC38FX	C-65	YAZV2C2TC38FXSL	C-84	YBM28-1/4	B-26	YCA28RL-2N	H-74
YAZ8CTC10	C-31, C-56	YAZV2C2TC38FXSLBOX500	C-84	YBM2C-L	B-26	YCA29-2N	H-73
YAZ8CTC14	C-31, C-56	YAZV2CTC12FX	C-56	YBM2C-L1	B-26	YCA2R-2N	H-75
YAZ8CTC38	C-31, C-56	YAZV2CTC14FX	C-56	YBM2C-L2	B-26	YCA2RL-2N	H-74
YAZV10-2TC14	C-43	YAZV2CTC38FX	C-56	YBM4C-L	B-26	YCA30-2N	H-73
YAZV102TC14E1	C-65	YAZV4C2NT14E2FX	C-71	YBM4C-L1	B-26	YCA30R-2N	H-75
YAZV10-2TC14E2	C-43	YAZV4C2TC14E2FX	C-65	YBM4C-L2	B-26	YCA31-2N	H-73
YAZV102TC14SL	C-83	YAZV4C2TC14FX	C-65	YBM4C-L4	B-26	YCA321R-2N	H-75
YAZV10TC14	C-31	YAZV4C2TC14FXSL	C-83	YBM6C-L	B-26	YCA321RL-2N	H-74
YAZV1C2TC14E1FX	C-66	YAZV4C2TC14FXSLBOX500	C-83	YBM6C-L2	B-26	YCA32-2N	H-73
YAZV1C2TC14E2FX	C-66	YAZV4C2TC38E2-FX	C-65	YBM6C-L3	B-26	YCA33R-2N	H-75
YAZV1C2TC14FX	C-66	YAZV4C2TC38FX	C-65	YBM6C-L9	B-26	YCA34-2N	H-73
YAZV1C2TC38FX	C-66	YAZV4C2TC38FXSL	C-83	YBM8C	B-26	YCA35R-2N	H-75
YAZV1C2TC516E6FX	C-66	YAZV4C2TC38FXSLBOX500	C-83	YBM8C-T2	B-26	YCA361R-2N	H-75
YAZV1C2TC516FX	C-66	YAZV4CTC14FX	C-56	YBM8CT4	B-26	YCA37R-2N	H-75
YAZV1CTC14FX	C-56	YAZV4CTC38FX	C-56	YC10C10	C-130, H-21	YCA391A-2N	H-76
YAZV1CTC38FX	C-56	YAZV6C2TC10E2FX	C-65	YC1L12	C-129	YCA39-2N	H-73
YAZV1CTC516FX	C-56	YAZV6C2TC10FX90SL	C-83	YC1U1	H-25	YCA39R-2N	H-75
YAZV252NT14FX	C-71	YAZV6C2TC14E1FX	C-65	YC25A2	H-22	YCA43R-2N	H-76
YAZV252NTCFX	C-66	YAZV6C2TC14E2FX	C-65	YC25A25	H-22	YCA441A-4N	H-76

ALPHA-NUMERIC INDEX BY CATALOG NUMBER (Continued)

Catalog Number	Page #	Catalog Number	Page #	Catalog Number	Page #	Catalog Number	Page #
YCA44A2NG2	H-76	YCR2825	H-51	YCU28A	H-53	YDS28RP1	H-59, H-64
YCA451A-4N	H-76	YCR28RG5	H-52	YCU28R	H-54	YDS28RP2	H-59
YCA45R-2N	H-76	YCR28RG6	H-52	YCU291A	H-53	YDS29	H-57
YCA48R-4N	H-76	YCR28RG7	H-52	YCU2CA	H-53	YDS291AT	H-56
YCA4R-2N	H-75	YCR28RG8	H-52	YCU2R	H-54	YDS291R	H-59
YCA4RL-2N	H-74	YCR291RG2	H-52	YCU301A	H-53	YDS291RP1	H-59
YCACB28-4N	H-73	YCR291RG3	H-52	YCU30R	H-54	YDS29AT	H-56
YCACB32-4N	H-73	YCR291RG4	H-52	YCU321R	H-54	YDS2C	H-53, H-57
YCACB34-4N	H-73	YCR291RG5	H-52	YCU4R	H-54	YDS2C-3	H-57
YCACB39-4N	H-73	YCR30RG4	H-52	YCU4RG1	H-54	YDS2CA	H-56, H-63
YCACB44-4N	H-73	YCR30RG6	H-52	YCU4RG1	N-81	YDS2F	H-66
YCAK25R-4N	H-75	YCR30RG7	H-52	YD28REP2	H-64	YDS2KT	H-66
YCAK28A-2G1	H-78	YCR32RG1	H-52	YDS011R	H-60	YDS2RE	H-64
YCAK28R-4N	H-75	YCR32RG2	H-52	YDS011RP1	H-60	YDS2REP2	H-64
YCAK29A-2G1	H-78	YCR32RG3	H-52	YDS021R	H-59	YDS2RL	H-62
YCAK30R-4N	H-75	YCR32RG4	H-52	YDS021RE	H-64	YDS2RLY	H-61
YCAK31A-2G1	H-78	YCR32RG5	H-52	YDS021REP1	H-64	YDS2W	H-53, H-58
YCAK31AG1	H-78	YCR32RG6	H-52	YDS021RL	H-62	YDS2WA	H-56
YCAK321R-4N	H-75	YCR32RG7	H-52	YDS021RLY	H-61	YDS30	H-57
YCAK33R-4N	H-75	YCS25	H-53	YDS021RP1	H-59	YDS301AT	H-56
YCAK34A-2G3	H-78	YCS25R	H-48, H-49	YDS1C	H-53, H-57	YDS30LT	H-63
YCAK35R-4N	H-75	YCS25RL	H-50	YDS1C-3	H-57	YDS30R	H-59
YCAK361A-4N	H-75	YCS26	H-53	YDS1R	H-59	YDS30RP1	H-59
YCAK361R-4N	H-75	YCS26A	H-51	YDS1RP1	H-59	YDS30RP2	H-59
YCAK36A-2G1	H-78	YCS26R	H-49	YDS1RP2	H-59	YDS31	H-57
YCAK37R-4N	H-75	YCS26RL	H-50	YDS1W	H-58	YDS311AT	H-56, H-63
YCAK391A-4N	H-76	YCS27	H-53	YDS25	H-57	YDS312E	H-64
YCAK39A-2G2	H-78	YCS27R	H-49	YDS250E	H-64	YDS312H	H-64
YCAK39R-4N	H-75	YCS28	H-53	YDS251R	H-60	YDS31AT	H-56
YCAK43R-4N	H-76	YCS28A	H-51	YDS251RP1	H-60	YDS32	H-57
YCAK44A-2G2	H-78	YCS28R	H-49	YDS25AT	H-48, H-56, H-63	YDS321R	H-59
YCAK453R-4N	H-76	YCS28RL	H-50	YDS25F	H-66	YDS321RL	H-62
YCAK45R-4N	H-76	YCS29	H-53	YDS25R	H-59	YDS321RLY	H-61
YCB1U1	H-38	YCS2R	H-49	YDS25REP2	H-64	YDS321RP1	H-59
YCB25R	H-37	YCS30	H-53	YDS25RL	H-62	YDS326R	H-59
YCB26R	H-37	YCS301A	H-51	YDS25RLY	H-61	YDS32LT	H-63
YCB27R	H-37	YCS30R	H-49	YDS25RP1	H-59, H-64	YDS32R	H-59
YCB28R	H-37	YCS31	H-53	YDS25RP2	H-59	YDS32RP2	H-59
YCB28U26	H-38	YCS311A	H-51	YDS26	H-57	YDS331AT	H-56, H-63
YCB2R	H-37	YCS32	H-53	YDS261R	H-60	YDS33R	H-59
YCB321R	H-37	YCS321R	H-49	YDS261RP1	H-60	YDS33RP1	H-59
YCB33R	H-37	YCS321RL	H-50	YDS26AT	H-56	YDS34	H-57
YCB33R26U	H-38	YCS331A	H-51	YDS26F	H-66	YDS341RL	H-63
YCB35R	H-37	YCS33R	H-49	YDS26R	H-59	YDS34R	H-59
YCB361R	H-37	YCS34	H-53	YDS26RL	H-62	YDS34RP2	H-59, H-60
YCB38R26U	H-38	YCS341RL	H-50	YDS26RLY	H-61	YDS351AT	H-56
YCB4U1	H-38	YCS351A	H-51	YDS26RP1	H-59, H-64	YDS35R	H-59
YCHC29TC2	C-131	YCS35R	H-49	YDS26RP2	H-59	YDS35RP1	H-59
YCHC29TC29	C-131	YCS361A	H-51	YDS27	H-57	YDS361AT	H-56
YCHC2TC2	C-131	YCS361R	H-49	YDS271R	H-60	YDS361R	H-59, H-64
YCHC34TC2	C-131	YCS37R	H-49	YDS271RP1	H-60	YDS361RL	H-55, H-63
YCHC34TC29	C-131	YCS39	H-53	YDS27AT	H-56, H-63	YDS361RP1	H-59, H-64
YCHC34TC34	C-131	YCS391A	H-51	YDS27R	H-59	YDS36LT	H-63
YCHC39TC2	C-131	YCS39R	H-49	YDS27RE	H-64	YDS36R	H-59
YCHC39TC31	C-131	YCS43R	H-49	YDS27RL	H-62	YDS36RP2	H-59, H-60
YCHC39TC39	C-131	YCS44	H-53	YDS27RLY	H-61	YDS375H	H-64
YCHC44TC44	C-131	YCS453R	H-49	YDS27RP1	H-59, H-64	YDS37RP1	H-59
YCHC8TC8	C-131	YCS45R	H-49	YDS27RP2	H-59, H-60, H-64	YDS39	H-57
YCR25RG6	H-52	YCS4R	H-49	YDS28	H-57	YDS391AT	H-56
YCR2625	H-51	YCT2626	H-31	YDS28AT	H-56, H-63	YDS392R	H-60
YCR26RG2	H-52	YCT2828	H-31	YDS28F	H-66	YDS39RP1	H-60
YCR26RG3	H-52	YCU25A	H-53	YDS28R	H-59	YDS3C-3	H-57
YCR2725	H-51	YCU25R	H-54	YDS28RE	H-64	YDS3K10	H-65
YCR27RG5	H-52	YCU26R	H-54	YDS28RL	H-62	YDS3K5	H-65
YCR27RG6	H-52	YCU27R	H-54	YDS28RLY	H-61	YDS3K6	H-65, H-66

ALPHA-NUMERIC INDEX BY CATALOG NUMBER (Continued)

Catalog Number	Page #	Catalog Number	Page #	Catalog Number	Page #	Catalog Number	Page #
YDS3K7	H-65	YE26R-60	H-42	YEV26P33X75FX	C-140	YF0418UI	B-86
YDS3K8	H-65	YE27R-60	H-42	YEV26P37X75FX	C-139	YF0420UI	B-86
YDS3W	H-58	YE28-LH128	H-42	YEV27P33X75FX	C-141	YF0422ID	B-88
YDS40R	H-60	YE28R-60	H-42	YEV27P37X75FX	C-140	YF0422IT	B-88
YDS41RP2	H-59, H-60	YE29P31X109	C-141	YEV27P41X82FX	C-139	YF0422IW	B-88
YDS42R	H-60	YE29P41X82	C-141	YEV28P37X75FX	C-141	YF0425ID	B-88
YDS431AT	H-56	YE29P46X92	C-140	YEV28P41X75FX	C-140	YF0425IT	B-88
YDS43R43RS	H-60	YE29P50X100	C-139	YEV28P46X92FX	C-139	YF0425IW	B-88
YDS43R45RS	H-60	YE2C-LH128	H-42	YEV2CP20X75FX	C-141	YF0425UI	B-86
YDS43RP1	H-60	YE2C-LH129	H-42	YEV2CP23X75FX	C-140	YF0432UI	B-86
YDS43RP2	H-60	YE2R-25	H-42	YEV2CP26X75FX	C-139	YF0612ID	B-88
YDS44	H-57	YE2WAG5	H-42	YEV4CP16X75FX	C-141	YF0612IT	B-88
YDS44RP2	H-59, H-60	YE30P46X92	C-141	YEV4CP20X75FX	C-139	YF0612IW	B-88
YDS451R34RS	H-60	YE30P46X92FX	C-140	YF0112ID	B-88	YF0612UI	B-86
YDS451R49RS	H-60	YE30P50X100	C-140	YF0112IT	B-88	YF0615UI	B-86
YDS451RP1	H-60	YE30P50X100FX	C-139	YF0112IW	B-88	YF0618ID	B-88
YDS45R45RS	H-60	YE30P55X110	C-139	YF0116ID	B-88	YF0618IT	B-88
YDS45RP1	H-60	YE30R-60	H-42	YF0116IT	B-88	YF0618IW	B-88
YDS45RP2	H-60	YE31-LH96	H-42	YF0116IW	B-88	YF0618UI	B-86
YDS49R	H-60	YE31P41X82FX	C-141	YF0120ID	B-88	YF0625UI	B-86
YDS49RP1	H-60	YE31P50X100	C-141	YF0120IT	B-88	YF0801TOOL	N-48
YDS49RP2	H-60	YE31P51X102FX	C-139	YF0120IW	B-88	YF0812ID	B-88
YDS4C	H-53, H-57	YE31P55X110	C-140	YF0122ID	B-88	YF0812IT	B-88
YDS4CA	H-48, H-56	YE31P59X118	C-139	YF0122IT	B-88	YF0812IW	B-88
YDS4KT	H-66	YE32P51X102FX	C-140	YF0122IW	B-88	YF0812UI	B-86
YDS4RL	H-62	YE32P55X110	C-141	YF0122UI	B-86	YF0815ID	B-88
YDS4RLY	H-61	YE32P55X110FX	C-139	YF0125ID	B-88	YF0815IT	B-88
YDS4W	H-53, H-58	YE32P59X118	C-140	YF0125IT	B-88	YF0815IW	B-88
YDS4WA	H-48, H-56	YE32P63X126	C-139	YF0125IW	B-88	YF0815UI	B-86
YDS500H	H-64	YE32R-60	H-42	YF0125UI	B-86	YF0818ID	B-88
YDS50R	H-60	YE34-LH119	H-42	YF0130ID	B-88	YF0818IT	B-88
YDS6C	H-53, H-57	YE34-LH120	H-42	YF0130IT	B-88	YF0818IW	B-88
YDS6CA	H-56	YE34P51X102FX	C-141	YF0130IW	B-88	YF0818UI	B-86
YDS6KT	H-66	YE34P55X110FX	C-140	YF0132UI	B-86	YF1/03/OTOOL	N-48
YDS6W	H-53, H-58	YE34P59X118	C-141	YF0215UI	B-86	YF1006TOOL	N-48
YDS6WA	H-56	YE34P59X118FX	C-139	YF0216ID	B-88	YF1010ID	B-88
YDS6WK	H-65	YE34P63X126	C-140	YF0216IT	B-88	YF1010IT	B-88
YDS75	H-58	YE34P71X142	C-139	YF0216IW	B-88	YF1010IW	B-88
YDS76	H-58	YE361R-60	H-42	YF0218ID	B-88	YF1010UI	B-85
YDS78	H-58	YE36P59X118FX	C-140	YF0218IT	B-88	YF1012ID	B-88
YDS7K5	H-65	YE36P63X126	C-141	YF0218IW	B-88	YF1012IT	B-88
YDS7K6	H-65	YE36P67X134FX	C-139	YF0220UI	B-86	YF1012IW	B-88
YDS7K7	H-65	YE36P71X142	C-140	YF0222ID	B-88	YF1012UI	B-85
YDS7M10T	H-66, I-45	YE36P78X156	C-139	YF0222IT	B-88	YF1015UI	B-85
YDS7M6T	H-66, I-45	YE38P59X118FX	C-141	YF0222IW	B-88	YF1018ID	B-88
YDS7M7T	H-66, I-45	YE38P67X134FX	C-140	YF0225ID	B-88	YF1018IT	B-88
YDS7M8T	H-66, I-45	YE38P71X142FX	C-139	YF0225IT	B-88	YF1018IW	B-88
YDS7M9T	H-66, I-45	YE39P71X142	C-141	YF0225IW	B-88	YF1018UI	B-85
YDS8KT	H-66	YE39P78X156	C-140	YF0225UI	B-86	YF1209ID	B-88
YDS8W	H-53, H-58	YE39P87X174	C-139	YF0232UI	B-86	YF1209IT	B-88
YDS8WG1	H-58	YE39R-60	H-42	YF0401TOOL	N-48	YF1209IW	B-88
YDS8WK	H-65	YE40P67X134FX	C-141	YF0412ID	B-88	YF1209UI	B-85
YDSR25RL	H-55	YE40P71X142FX	C-140	YF0412IT	B-88	YF1210ID	B-88
YDSR26RL	H-55	YE40P78X156FX	C-139	YF0412IW	B-88	YF1210IT	B-88
YDSR27RL	H-55	YE44P78X156FX	C-140	YF0412UI	B-86	YF1210IW	B-88
YDSR28RL	H-55	YE44P87X174FX	C-139	YF0415ID	B-88	YF1212ID	B-88
YDSR2RL	H-55	YE4R-25	H-42	YF0415IT	B-88	YF1212IT	B-88
YDSR321RL	H-55	YE6R-25	H-42	YF0415IW	B-88	YF1212IW	B-88
YDSR341RL	H-55	YEV1CP23X75FX	C-141	YF0415UI	B-86	YF1212UI	B-85
YDSR4RL	H-55	YEV1CP26X75FX	C-140	YF0416ID	B-88	YF1215UI	B-85
YE1WAG1	H-42	YEV1CP29X75FX	C-139	YF0416IT	B-88	YF1218ID	B-88
YE25-LH97	H-42	YEV25P26X75FX	C-141	YF0416IW	B-88	YF1218IT	B-88
YE25R-25	H-42	YEV25P29X75FX	C-140	YF0418ID	B-88	YF1218IW	B-88
YE26-LH88	H-42	YEV25P33X75FX	C-139	YF0418IT	B-88	YF1218UI	B-85
YE26-LH89	H-42	YEV26P29X75FX	C-141	YF0418IW	B-88	YF1407UI	B-85

ALPHA-NUMERIC INDEX BY CATALOG NUMBER (Continued)

Catalog Number	Page #	Catalog Number	Page #	Catalog Number	Page #	Catalog Number	Page #
YF1408ID	B-87	YF2006IW	B-87	YF3/025UI	B-86	YFM30CR	K-48
YF1408IT	B-87	YF2006UI	B-85	YF3/030ID	B-88	YFM31CP	K-48
YF1408IW	B-87	YF2008ID	B-87	YF3/030UI	B-86	YFM31CPL	K-48
YF1408UI	B-85	YF2008IT	B-87	YF3/032UI	B-86	YFM31CR	K-48
YF1410ID	B-87	YF2008IW	B-87	YF3206TOOL	N-48	YFM32CP	K-48
YF1410IT	B-87	YF2010ID	B-87	YF35032UI	B-86	YFM32CPL	K-48
YF1410IW	B-87	YF2010IT	B-87	YF35040UI	B-86	YFM32CR	K-48
YF1410UI	B-85	YF2010IW	B-87	YF4/0250TOOL	N-48	YFM34CP	K-48
YF1412ID	B-87	YF2010UI	B-85	YF4/027ID	B-88	YFM34CPL	K-48
YF1412IT	B-87	YF2012ID	B-87	YF4/030ID	B-88	YFM34CR	K-48
YF1412IW	B-87	YF2012IT	B-87	YF4/032ID	B-88	YFM39CP	K-48
YF1412UI	B-85	YF2012IW	B-87	YF4/032UI	B-86	YFM39CPL	K-48
YF1418ID	B-87	YF2012UI	B-85	YF4/034ID	B-88	YFM39CR	K-48
YF1418IT	B-87	YF2018ID	B-87	YF4/034UI	B-86	YFMP28	K-49
YF1418IW	B-87	YF2018IT	B-87	YF4/040UI	B-86	YFMP28L	K-49
YF1418UI	B-85	YF2018IW	B-87	YFA28CP-2	K-44	YFMP29	K-49
YF1606ID	B-87	YF2205ID	B-87	YFA28CPL2	K-45	YFMP29L	K-49
YF1606IT	B-87	YF2205IT	B-87	YFA28CR2	K-44	YFMP30	K-49
YF1606IW	B-87	YF2205IW	B-87	YFA29CP-2	K-44	YFMP30L	K-49
YF1607UI	B-85	YF2206ID	B-87	YFA29CPL2	K-45	YFMP31	K-49
YF1608ID	B-87	YF2206IT	B-87	YFA29CR2	K-44	YFMP31L	K-49
YF1608IT	B-87	YF2206IW	B-87	YFA30CP-2	K-44	YFMP32	K-49
YF1608IW	B-87	YF2206UI	B-85	YFA30CPL2	K-45	YFMP32L	K-49
YF1608UI	B-85	YF2208ID	B-87	YFA30CR2	K-44	YFMP34	K-49
YF1610ID	B-87	YF2208IT	B-87	YFA31CP-2	K-44	YFMP34PL	K-49
YF1610IT	B-87	YF2208IW	B-87	YFA31CPL2	K-45	YFMP39	K-49
YF1610IW	B-87	YF2208UI	B-85	YFA31CR2	K-44	YFMP39PL	K-49
YF1610UI	B-85	YF22-10FL	N-47	YFA32CPL2	K-45	YFMR28	K-49
YF1612ID	B-87	YF2210ID	B-87	YFA32CR2	K-44	YFMR29	K-49
YF1612IT	B-87	YF2210IT	B-87	YFA34CP-2	K-44	YFMR30	K-49
YF1612IW	B-87	YF2210IW	B-87	YFA34CPL2	K-45	YFMR31	K-49
YF1612UI	B-85	YF2210TOOL	N-48	YFA34CR2	K-44	YFMR32	K-49
YF1615ID	B-87	YF2210UI	B-85	YFA39CP-2	K-44	YFMR34	K-49
YF1615IT	B-87	YF2212ID	B-87	YFA39CPL2	K-45	YFMR39	K-49
YF1615IW	B-87	YF2212IT	B-87	YFA39CR2	K-44	YFN-540	C-154
YF1618ID	B-87	YF2212IW	B-87	YFAP282	K-46	YFO-140	C-154
YF1618IT	B-87	YF2212UI	B-85	YFAP28L2	K-47	YFR-865	C-154
YF1618IW	B-87	YF2214TOOL	N-48	YFAP292	K-46	YFS28CPL	K-42
YF1618UI	B-85	YF2405UI	B-85	YFAP29L2	K-47	YFS28CR	K-41
YF1806ID	B-87	YF2406IT	B-87	YFAP302	K-46	YFS29CP	K-41
YF1806IT	B-87	YF2406IW	B-87	YFAP30L2	K-47	YFS29CPL	K-42
YF1806IW	B-87	YF2407UI	B-85	YFAP312	K-46	YFS29CR	K-41
YF1806UI	B-85	YF2408IT	B-87	YFAP31L2	K-47	YFS30CP	K-41
YF1808ID	B-87	YF2408IW	B-87	YFAP322	K-46	YFS30CPL	K-42
YF1808IT	B-87	YF25025ID	B-88	YFAP32L2	K-47	YFS30CR	K-41
YF1808IW	B-87	YF25027ID	B-88	YFAP342	K-46	YFS31CP	K-41
YF1808UI	B-85	YF25032ID	B-88	YFAP34L2	K-47	YFS31CPL	K-42
YF1810ID	B-87	YF25032UI	B-86	YFAP392	K-46	YFS31CR	K-41
YF1810IT	B-87	YF25038ID	B-88	YFAP39L2	K-47	YFS32CP	K-41
YF1810IW	B-87	YF25040UI	B-86	YFAR282	K-46	YFS32CPL	K-42
YF1810UI	B-85	YF2605UI	B-85	YFAR292	K-46	YFS32CR	K-41
YF1812ID	B-87	YF2606ID	B-87	YFAR302	K-46	YFS34CP	K-41
YF1812IT	B-87	YF2606IT	B-87	YFAR312	K-46	YFS34CPL	K-42
YF1812IW	B-87	YF2606IW	B-87	YFAR322	K-46	YFS34CR	K-41
YF1812UI	B-85	YF2607UI	B-85	YFAR342	K-46	YFS39CP	K-41
YF1818ID	B-87	YF2608ID	B-87	YFAR392	K-46	YFS39CPL	K-42
YF1818IT	B-87	YF2608IT	B-87	YFD-365	C-154	YFS39CR	K-41
YF1818IW	B-87	YF2608IW	B-87	YFM28CP	K-48	YFSP28	K-43
YF2/020ID	B-88	YF2610TOOL	N-48	YFM28CPL	K-48	YFSP28L	K-43
YF2/022UI	B-86	YF2806IT	B-87	YFM28CR	K-48	YFSP29	K-43
YF2/025ID	B-88	YF2806IW	B-87	YFM29CP	K-48	YFSP29L	K-43
YF2/025UI	B-86	YF2807UI	B-85	YFM29CPL	K-48	YFSP30	K-43
YF2/027ID	B-88	YF2808IT	B-87	YFM29CR	K-48	YFSP30L	K-43
YF2/032UI	B-86	YF2808IW	B-87	YFM30CP	K-48	YFSP31	K-43
YF2006IT	B-87	YF3/025ID	B-88	YFM30CPL	K-48	YFSP31L	K-43

ALPHA-NUMERIC INDEX BY CATALOG NUMBER (Continued)

Catalog Number	Page #	Catalog Number	Page #	Catalog Number	Page #	Catalog Number	Page #
YFSP32	K-43	YGA6C-TC14	E-17	YGIBS28-613-2N	E-23	YH3939	C-132, C-134
YFSP32L	K-43	YGA6C-TC516	E-17	YGIBS28-675-2N	E-23	YH3939WC	C-132, C-134
YFSP34	K-43	YGA8C-2N	E-17	YGIBS34-338-2N	E-23	YH3939WCC	C-132, C-134
YFSP34L	K-43	YGA8C-TC10	E-17	YGIBS34-400-2N	E-23	YH4429	C-132, C-134
YFSP39	K-43	YGA8C-TC14	E-17	YGIBS34-462-2N	E-23	YH4429WC	C-132, C-134
YFSP39L	K-43	YGA8C-TC516	E-17	YGIBS34-550-2N	E-23	YH4429WCC	C-132, C-134
YFSR28	K-43	YGC6C6	E-12	YGIBS34-675-2N	E-23	YH4434	C-132, C-134
YFSR29	K-43	YGC6C8	E-12	YGBW28-1000-2N	E-23	YH4434WC	C-132, C-134
YFSR30	K-43	YGC8C8	E-12	YGBW28-338-2N	E-23	YH4434WCC	C-132, C-134
YFSR31	K-43	YGF29-2N	E-21	YGBW28-400-2N	E-23	YH4444	C-132, C-134
YFSR32	K-43	YGF29-4N	E-21	YGBW28-462-2N	E-23	YH4444WC	C-132, C-134
YFSR34	K-43	YGF34-2N	E-21	YGBW28-550-2N	E-23	YH4444WCC	C-132, C-134
YFSR39	K-43	YGF34-4N	E-21	YGBW28-613-2N	E-23	YH6C6C	C-132, C-134
YFTW0614D	B-89	YGHA25-2N	E-16	YGBW28-675-2N	E-23	YH6C6CWC	C-132, C-134
YFTW0614T	B-89	YGHA26-2N	E-16	YGBW28-750-2N	E-23	YH6C6CWCC	C-132, C-134
YFTW0614W	B-89	YGHA27-2N	E-16	YGBW34-338-2N	E-23	YH8C8C	C-132, C-134
YFTW0814D	B-89	YGHA28-2N	E-16	YGBW34-400-2N	E-23	YH8C8CWC	C-132, C-134
YFTW0814T	B-89	YGHA29-2N	E-16	YGBW34-462-2N	E-23	YH8C8CWCC	C-132, C-134
YFTW0814W	B-89	YGHA2C-2N	E-16	YGBW34-550-2N	E-23	YHD200	H-38
YFTW1014D	B-89	YGHA31-2N	E-16	YGBW34-613-2N	E-23	YHD-200	H-28
YFTW1014T	B-89	YGHA34-2N	E-16	YGBW34-675-2N	E-23	YHD200J1444	H-39
YFTW1014W	B-89	YGHC26C2	E-11	YGL29C2	E-7	YHD250	H-38
YFTW1212D	B-89	YGHC26C26	E-11	YGL29C29	E-7	YHD-250	H-28
YFTW1212T	B-89	YGHC29C26	E-11	YGL2C2	E-7	YHD250J1444	H-39
YFTW1212W	B-89	YGHC29C29	E-11	YGL34C2	E-7	YHD-3	H-30
YFTW1410D	B-89	YGHC2C2	E-11	YGL34C29	E-7	YHD300	H-38
YFTW1410T	B-89	YGHC34C26	E-11	YGL34C34	E-7	YHD-300	H-28
YFTW1410W	B-89	YGHC34C29	E-11	YGLR29C100	E-8	YHD300J1496	H-39
YFTW1413D	B-89	YGHC34C34	E-11	YGLR29C12	E-8	YHD350	H-38
YFTW1413T	B-89	YGHP29C2	E-9	YGLR29C34	E-8	YHD-350	H-28
YFTW1413W	B-89	YGHP29C26	E-9	YGLR29C58	E-8	YHD350J1496	H-39
YFTW1608D	B-89	YGHP29C29	E-9	YGLR34C100	E-8	YHD-4	H-30
YFTW1608T	B-89	YGHP29C6W6W	E-9	YGLR34C12	E-8	YHD-400	H-28
YFTW1608W	B-89	YGHP2C2	E-9	YGLR34C34	E-8	YHD-5	H-30
YFTW1612D	B-89	YGHP2C6W6W	E-9	YGLR34C58	E-8	YHD-6	H-30
YFTW1612T	B-89	YGHP34C2	E-9	YGS25	E-20	YHD-7	H-30
YFTW1612W	B-89	YGHP34C26	E-9	YGS26	E-20	YHN-450	H-29
YFTW1808D	B-89	YGHP34C29	E-9	YGS28	E-20	YHN500	H-38
YFTW1808T	B-89	YGHP34C34	E-9	YGS29	E-20	YHN-500	H-29
YFTW1808W	B-89	YGHP58C2W-2	E-10	YGS2C	E-20	YHN500J1496	H-39
YFTW1810D	B-89	YGHP58C2W-2TN	E-10	YGS34	E-20	YHN-525	H-29
YFTW1810T	B-89	YGHR26C100	E-14	YGS6C	E-20	YHN-550	H-29
YFTW1810W	B-89	YGHR26C12	E-14	YGS8C	E-20	YHN-600	H-29
YFTW2008D	B-89	YGHR26C34	E-14	YGT275	E-25	YHO-1	H-30
YFTW2008T	B-89	YGHR26C58	E-14	YH2929	C-132, C-134	YHO-10	H-30
YFTW2008W	B-89	YGHR29C100	E-14	YH2929WC	C-132, C-134	YHO100	H-38
YFTW2010D	B-89	YGHR29C12	E-14	YH2929WCC	C-132, C-134	YHO-100	H-28
YFTW2010T	B-89	YGHR29C34	E-14	YH292C	C-132, C-134	YHO100J1444	H-39
YFTW2010W	B-89	YGHR29C58	E-14	YH292CWCC	C-132, C-134	YHO125	H-30
YFTW2208D	B-89	YGHR34C100	E-14	YH292CWCC	C-132, C-134	YHO-125	H-28
YFTW2208T	B-89	YGHR34C34	E-14	YH298C	C-132, C-134	YHO150	H-38
YFTW2208W	B-89	YGHR34C58	E-14	YH298CWC	C-132, C-134	YHO-150	H-28
YG14B2TC2C2C	E-26	YGHR58C2W-3	E-15	YH298CWCC	C-132, C-134	YHO150J1444	H-39
YG14B2TC2C6C	E-26	YGHS25	E-19	YH2C2C	C-132, C-134	YHO-2	H-30
YG14BTC28	E-26	YGHS26	E-19	YH2C2CWC	C-132, C-134	YHR-700	H-29
YGA25-2N	E-17	YGHS27	E-19	YH2C2CWCC	C-132, C-134	YHR-750	H-29
YGA26-2N	E-17	YGHS28	E-19	YH3429	C-132, C-134	YHR-800	H-29
YGA28-2N	E-17	YGHS29	E-19	YH3429WC	C-132, C-134	YHR-850	H-29
YGA29-2N	E-17	YGHS2C	E-19	YH3429WCC	C-132, C-134	YHR-900	H-29
YGA2C-2N	E-17	YGHS31	E-19	YH3434	C-132, C-134	YHR-950	H-29
YGA2C-2TC38	E-17	YGHS34	E-19	YH3434WC	C-132, C-134	YHSA10K10	B-12
YGA34-2N	E-17	YGIBS28-338-2N	E-23	YH3434WCC	C-132, C-134	YHSA10K10BF	B-41
YGA6C-2N	E-17	YGIBS28-400-2N	E-23	YH3931	C-132, C-134	YHSA10K10F	B-31
YGA6C-2TC38E2G1	E-17	YGIBS28-462-2N	E-23	YH3931WC	C-132, C-134	YHSA10K10FRK	B-31
YGA6C-TC10	E-17	YGIBS28-550-2N	E-23	YH3931WCC	C-132, C-134	YHSA10K10LF	B-36

ALPHA-NUMERIC INDEX BY CATALOG NUMBER (Continued)

Catalog Number	Page #	Catalog Number	Page #	Catalog Number	Page #	Catalog Number	Page #
YHSA10K10RK	B-12	YHSFQ10F25X03	B-70	YNA34R15H	I-3	YNA59R15	I-9, I-37
YHSA10K12	B-12	YHSFQ10F25X03RK	B-70	YNA34RT	I-10	YNA59R15H	I-4, I-29, I-31
YHSA10K12RK	B-12	YHSFQ14F25X03	B-70	YNA34RT15	I-10	YNA59RT	I-10, I-38
YHSA10K14	B-12	YHSFQ14F25X03RK	B-70	YNA34RT15H	I-5	YNA59RT15	I-10, I-38
YHSA10K14FRK	B-31	YHSFQ18F25X03	B-70	YNA36R	I-9	YNA59RT15H	I-5, I-6, I-30
YHSA10K14RK	B-12	YHSFQ18F25X03RK	B-70	YNA36R15	I-9	YNA7M10T	I-44
YHSA10K38	B-12	YHSQ10F25X03	B-69	YNA36R15H	I-3, I-31, I-32	YNA7M6T	I-44
YHSA10K38RK	B-12	YHSQ10F25X03RK	B-69	YNA36RT	I-10, I-38	YNA7M7T	I-44
YHSA10K516	B-12	YHSQ10M25X03	B-68	YNA36RT15	I-10, I-38	YNA7M8T	I-44
YHSA10K6	B-12	YHSQ10M25X03RK	B-68	YNA36RT15H	I-5, I-6, I-30	YNM428	K-38
YHSA10K6BF	B-41	YHSQ14F11X02D	B-69	YNA39R	I-9, I-37	YNM434	K-38
YHSA10K6F	B-31	YHSQ14F18X02D	B-69	YNA39R15	I-9, I-37	YNM628	K-38
YHSA10K6LF	B-36	YHSQ14F25X03	B-69	YNA39R15H	I-3, I-29, I-32	YNM634	K-38
YHSA10K8	B-12	YHSQ14F25X03RK	B-69	YNA39RT	I-10, I-38	YNM828	K-38
YHSA10K8BF	B-41	YHSQ14M25X03	B-68	YNA39RT15	I-10, I-38	YNM834	K-38
YHSA10K8F	B-31	YHSQ14M25X03RK	B-68	YNA39RT15H	I-5, I-6, I-30	YNS32R	I-11, I-39
YHSA10K8FRK	B-31	YHSQ18F11X02D	B-69	YNA43R	I-9, I-37	YNS32RT	I-12, I-40
YHSA10K8LF	B-36	YHSQ18F18X02D	B-69	YNA43R15	I-9, I-37	YNS34R	I-11, I-39
YHSA14K10	B-12	YHSQ18F25X03	B-69	YNA43R15H	I-3, I-29, I-32	YNS34RT	I-12, I-40
YHSA14K10BF	B-41	YHSQ18F25X03RK	B-69	YNA43RT	I-10, I-38	YNS36R	I-11, I-39
YHSA14K10F	B-31	YHSQ18M250X03RK	B-68	YNA43RT15	I-10, I-38	YNS36RT	I-12, I-40
YHSA14K10FRK	B-31	YHSQ18M25X03	B-68	YNA43RT15H	I-5, I-6, I-30	YNS39R	I-11, I-39
YHSA14K10LF	B-36	YHSS10	B-59	YNA451R	I-9, I-37	YNS39RT	I-12, I-40
YHSA14K10RK	B-12	YHSS10RK	B-59	YNA451R15	I-9, I-37	YNS43R	I-11, I-39
YHSA14K14	B-12	YHSS14	B-59	YNA451R15H	I-3, I-31, I-32	YNS43RT	I-12, I-40
YHSA14K14FRK	B-31	YHSS14RK	B-59	YNA451RT	I-10, I-38	YNS451R	I-11, I-39
YHSA14K14RK	B-12	YHSS18	B-59	YNA451RT15	I-10, I-38	YNS451RT	I-12, I-40
YHSA14K38	B-12	YHSS18RK	B-59	YNA451RT15H	I-5, I-6, I-30	YNS49R	I-11, I-39
YHSA14K38RK	B-12	YKA25R-2N	H-34	YNA49R	I-9	YNS49RT	I-12, I-40
YHSA14K516	B-12	YKA26-2N	H-36	YNA49R15	I-9	YNS52R	I-11, I-39
YHSA14K6	B-12	YKA26R-2N	H-34	YNA49R15H	I-3	YNS52RT	I-12, I-40
YHSA14K6BF	B-41	YKA27R-2N	H-34	YNA49RT	I-10, I-38	YNS54R	I-39
YHSA14K6F	B-31	YKA28-2N	H-36	YNA49RT15	I-10, I-38	YNS54RT	I-40
YHSA14K6FRK	B-31	YKA28R-2N	H-34	YNA49RT15H	I-5, I-6, I-30	YNS56R	I-11, I-39
YHSA14K6LF	B-36	YKA2C-2N	H-36	YNA52R	I-9, I-37	YNS56RT	I-12, I-40
YHSA14K8	B-12	YKA2R-2N	H-34	YNA52R15	I-9, I-37	YNS58R	I-11, I-39
YHSA14K8BF	B-41	YKA30-2N	H-36	YNA52R15H	I-3, I-29, I-32	YNS58RT	I-12, I-40
YHSA14K8F	B-31	YKA30R-2N	H-34	YNA52RT	I-10, I-38	YNS594R	I-39
YHSA14K8FRK	B-31	YKA321R-2N	H-34	YNA52RT15	I-10, I-38	YNS594RT	I-40
YHSA14K8LF	B-36	YKA33R-2N	H-34	YNA52RT15H	I-5, I-6, I-30	YNS59R	I-11, I-39
YHSA14K8RK	B-12	YKA34-2N	H-36	YNA54R	I-37	YNS59RT	I-12, I-40
YHSA18K10	B-12	YKA34CA-2N	H-34	YNA54R15	I-37	YNT32R32R	I-13, I-42
YHSA18K10BF	B-41	YKA361R-2N	H-34	YNA54R15H	I-29, I-31, I-32	YNT32R32RHT	I-26
YHSA18K10F	B-31	YKA37R-2N	H-34	YNA54RT	I-38	YNT34R34R	I-13, I-42
YHSA18K10FRK	B-31	YKA391A-2N	H-34	YNA54RT15	I-38	YNT34R34RHT	I-26
YHSA18K10LF	B-36	YKA44-2N	H-36	YNA54RT15H	I-30	YNT36R36R	I-13, I-42
YHSA18K10RK	B-12	YKA6C-2N	H-36	YNA56R	I-9, I-37	YNT36R36RHT	I-26
YHSA18K14	B-12	YM10-28	K-37	YNA56R15	I-9, I-37	YNT39R39R	I-13, I-42
YHSA18K14RK	B-12	YM10-34	K-37	YNA56R15H	I-3, I-4, I-31	YNT39R39RHT	I-26
YHSA18K38	B-12	YM12-28	K-37	YNA56RT	I-10, I-38	YNT43R43R	I-13, I-42
YHSA18K38RK	B-12	YM12-34	K-37	YNA56RT15	I-10, I-38	YNT43R43RHT	I-26
YHSA18K516	B-12	YM4-28	K-37	YNA56RT15H	I-5, I-6, I-30	YNT451R451R	I-13, I-42
YHSA18K516RK	B-12	YM4-34	K-37	YNA58R	I-9, I-37	YNT451R451RHT	I-26
YHSA18K6	B-12	YM6-28	K-37	YNA58R15	I-9, I-37	YNT49R49R	I-13, I-42
YHSA18K6BF	B-41	YM6-34	K-37	YNA58R15H	I-3, I-4, I-32	YNT49R49RHT	I-26
YHSA18K6F	B-31	YM8-28	K-37	YNA58RT	I-10, I-38	YNT52R52R	I-13, I-42
YHSA18K6FRK	B-31	YM8-34	K-37	YNA58RT15	I-10, I-38	YNT52R52RHT	I-26
YHSA18K6LF	B-36	YNA32R	I-9, I-37	YNA58RT15H	I-5, I-6, I-30	YNT54R54R	I-42
YHSA18K6RK	B-12	YNA32R15	I-9, I-37	YNA594R	I-37	YNT56R56R	I-13, I-42
YHSA18K8	B-12	YNA32R15H	I-3, I-31, I-32	YNA594R15	I-37	YNT56R56RHT	I-26
YHSA18K8BF	B-41	YNA32RT	I-10, I-38	YNA594R15H	I-29, I-31, I-32	YNT58R58R	I-13, I-42
YHSA18K8F	B-31	YNA32RT15	I-10, I-38	YNA594RT	I-38	YNT58R58RHT	I-26
YHSA18K8FRK	B-31	YNA32RT15H	I-5	YNA594RT15	I-38	YNT594R594R	I-42
YHSA18K8LF	B-36	YNA34R	I-9	YNA594RT15H	I-30	YNT59R59R	I-13, I-42
YHSA18K8RK	B-12	YNA34R15	I-9	YNA59R	I-9, I-37	YNT59R59RHT	I-26

ALPHA-NUMERIC INDEX BY CATALOG NUMBER (Continued)

Catalog Number	Page #	Catalog Number	Page #	Catalog Number	Page #	Catalog Number	Page #
YNTA245MRTACCC	I-51	YOU33R	H-54	YRB28U25TW	K-67	YS27AT	C-152
YNTA32R	I-14, I-41	YOU35R	H-54	YRB28U26	C-153	YS27-LB	C-113, C-114
YNTA32RHT	I-27	YOU361R	H-54	YRB28U26TW	K-67	YS27-LBOX	C-110
YNTA32RTACCC	I-51	YOU37R	H-54	YRB28U28TW	K-67	YS27UCG1	K-66
YNTA34R	I-14, I-41	YOU39R	H-54	YRB28U31TW	K-67	YS28	C-111
YNTA34RHT	I-27	YOU41R	H-54	YRB29U28	C-153	YS28A1	C-151
YNTA36R	I-14, I-41	YOU421R	H-54	YRB2U3TTN	K-67	YS28AT	C-152
YNTA36RHT	I-27	YOU43R	H-54	YRB2U4	C-153	YS28-LB	C-113, C-115
YNTA36RTACCC	I-51	YOU44R	H-54	YRB31U25TW	K-67	YS28-LBOX	C-110
YNTA39R	I-14, I-41	YOU453R	H-54	YRB31U28	C-153	YS28LTCKITC	C-118
YNTA39RHT	I-27	YOU45R	H-54	YRB31U28TW	K-67	YS28-T	C-116
YNTA39RTACCC	I-51	YOU48R	H-54	YRB31U29	C-153	YS28UCG1	K-66
YNTA43R	I-14, I-41	YOU49R	H-54	YRB31U31TW	K-67	YS29	C-111
YNTA43RHT	I-27	YP25U25	H-23	YRB3428T	K-70	YS29A1	C-151
YNTA43RTACCC	I-51	YP26AU2	H-23, H-38	YRB34U25TW	K-68	YS29AT	C-152
YNTA451R	I-14, I-41	YP27AU2	H-23	YRB34U28TW	K-68	YS29FXLTKITC	C-118
YNTA451RHT	I-27	YP27AU26	H-23, H-38	YRB34U29TW	K-68	YS29-LB	C-113, C-115
YNTA451RTACCC	I-51	YP27AU4	H-23, H-38	YRB34U30TW	K-68	YS29-LBOX	C-110
YNTA49R	I-14, I-41	YP28C28	H-21	YRB34U31	C-153	YS29-T	C-116
YNTA49RHT	I-27	YP28U2	H-23	YRB34U31TW	K-68	YS2C	C-111
YNTA49RTACCC	I-51	YP28U26	H-23, H-38	YRB34U34TW	K-68	YS2CA1	C-150
YNTA52RTACCC	I-51	YP28U28	H-23	YRB36U31	C-153	YS2CAT	C-152
YNTA54R	I-14, I-41	YP29C26	H-21	YRB36U34	C-153	YS2CFXLTKITC	C-118
YNTA54RHT	I-27	YP2C2	H-21	YRB39U31TW	K-68	YS2C-LB	C-113, C-114
YNTA56R	I-14, I-41	YP2U3	H-23, H-38	YRB39U34	C-153	YS2C-LBOX	C-110
YNTA56RHT	I-27	YPC26R8U	H-25	YRB39U34TW	K-68	YS2CLTKITC	C-118
YNTA58R	I-14, I-41	YPC28R28A	H-24	YRB39U36	C-153	YS2C-T	C-116
YNTA58RHT	I-27	YPC28U26	H-24, H-38	YRB39U39TW	K-68	YS2UCG1	K-66
YNTA594R	I-41	YPC28U28	H-24	YRB44U31TW	K-68	YS30	C-111
YNTA59R	I-14, I-41	YPC28U4	H-24, H-38	YRB44U34TW	K-68	YS30A1	C-151
YNTA59RHT	I-27	YPC29C26	K-72	YRB44U39TW	K-68	YS30AT	C-152
YNU245MRACCC	I-52	YPC2A8U	H-25	YRB44U44TW	K-68	YS30-FXB	C-117
YNU32R	I-15, I-43	YPC33R26U	H-24, H-38	YRV2CV6C-L	B-58	YS30-L	C-110
YNU32RACCC	I-52	YPC33R28R	H-24	YRV4CV6C-L	B-58	YS30-LB	C-113, C-115
YNU32RHT	I-28	YPC33R33R	H-24	YRV6CV10-L	B-58	YS30-T	C-116
YNU34R	I-15, I-43	YPC36A32	H-24	YRV6CV8C-L	B-58	YS31	C-111
YNU34RHT	I-28	YPC36A36	H-24	YRV8CV10-L	B-58	YS31A1	C-151
YNU36R	I-15, I-43	YPC38R26U	H-24	YRV8CV14-L	B-58	YS31ACG1	K-66
YNU36RACCC	I-52	YPC40A32	H-24	YS10WAG1	C-150	YS31AT	C-152
YNU36RHT	I-28	YPC40A36	H-24	YS12AG1	C-150	YS31-FXB	C-117
YNU39R	I-15, I-43	YPC40A40	H-24	YS1C	C-111	YS31-L	C-110
YNU39RACCC	I-52	YQE-91	B-92	YS1CA1	C-150	YS31LTCKITC	C-118
YNU39RHT	I-28	YR2C2WT	C-111	YS1C-LB	C-113, C-114	YS31-T	C-116
YNU43R	I-15, I-43	YRA1CU-1	H-78	YS1C-LBOX	C-110	YS32	C-111
YNU43RACCC	I-52	YRA25A-1	H-78	YS1C-T	C-116	YS32A1	C-151
YNU43RHT	I-28	YRA25U	H-78	YS25	C-111	YS32-FXB	C-117
YNU451R	I-15, I-43	YRA26U	H-78	YS25A1	C-150	YS32-L	C-110
YNU451RACCC	I-52	YRA27U	H-78	YS25AT	C-152	YS32-LB	C-113, C-115
YNU451RHT	I-28	YRA28U	H-78	YS25FXLTKITC	C-118	YS34	C-111
YNU49R	I-15, I-43	YRA4CU-1	H-78	YS25-LB	C-113, C-114	YS34A1	C-151
YNU49RACCC	I-52	YRA6CU-1	H-78	YS25-LBOX	C-110	YS34AT	C-152
YNU49RHT	I-28	YRA8CU-1	H-78	YS25LTCKITC	C-118	YS34-FXB	C-117
YNU52RACCC	I-52	YRAL1CU	H-78	YS25-T	C-116	YS34FXLTKITC	C-118
YNU54R	I-15, I-43	YRAL4CU	H-78	YS25UCG1	K-66	YS34-L	C-110
YNU54RHT	I-28	YRB1CU1TTN	K-67	YS26	C-111	YS34-LB	C-113, C-115
YNU56R	I-15, I-43	YRB1CU2TTN	K-67	YS26A1	C-151	YS34LTCKITC	C-118
YNU56RHT	I-28	YRB25U2	C-153	YS26AT	C-152	YS34-T	C-116
YNU58R	I-15	YRB25U25TTN	K-67	YS26FXLTKITC	C-118	YS36	C-111
YNU58RHT	I-28	YRB25U2TTN	K-67	YS26-LB	C-113, C-114	YS36A1	C-151
YNU594R	I-43	YRB25U3TTN	K-67	YS26-LBOX	C-110	YS36-FXB	C-117
YNU595R	I-43	YRB27U25	C-153	YS26LTCKITC	C-118	YS36-L	C-110
YNU59R	I-15, I-43	YRB27U25TW	K-67	YS26-T	C-116	YS38-FXB	C-117
YNU59RHT	I-28	YRB27U26	C-153	YS26UCG1	K-66	YS38FXLTKITC	C-118
YOT3434	H-31	YRB2825T	K-70	YS27	C-111	YS38-L	C-110
YOU32R	H-54	YRB28U1TW	K-67	YS27A1	C-151	YS38-LB	C-113, C-115

ALPHA-NUMERIC INDEX BY CATALOG NUMBER (Continued)

Catalog Number	Page #	Catalog Number	Page #	Catalog Number	Page #	Catalog Number	Page #
YS39	C-111	YSD26R2W	H-47	YSR25FX8CFXLTKITC	C-122, C-127	YSR44FX28FXLTCKITC	C-119, C-123
YS39A1	C-151	YSD27R25R	H-47	YSR26FX25FXLTCKITC	C-121, C-127	YSR44FX28LTCKITC	C-119, C-123
YS39AM1	C-151	YSD27R26R	H-47	YSR26FX2CFXLTKITC	C-121, C-127	YSR44FX29FXLTCKITC	C-119, C-123
YS39AT	C-152	YSD27R27R	H-47	YSR26FX4CFXLTKITC	C-121, C-127	YSR44FX29LTCKITC	C-119, C-123
YS39-L	C-110	YSD27R2R	H-47	YSR26FX6CFXLTKITC	C-121, C-127	YSR44FX30LTCKITC	C-119, C-123
YS39LTCKITC	C-118	YSD27R2W	H-47	YSR2825FXLTCKITC	C-121, C-127	YSR44FX31LTCKITC	C-119, C-123
YS39-T	C-116	YSD28R25R	H-47	YSR282CFXLTKITC	C-121, C-127	YSR44FX34FXLTCKITC	C-119, C-123
YS3C	C-111	YSD28R26R	H-47	YSR284CFXLTKITC	C-121, C-127	YSR44FX34LTCKITC	C-119, C-123
YS3C-L	C-110	YSD28R27R	H-47	YSR286CFXLTKITC	C-121, C-127	YSR44FX38FXLTCKITC	C-119, C-123
YS3C-LB	C-113, C-114	YSD28R28R	H-47	YSR28FX25FXLTCKITC	C-121, C-126	YSR44FX39LTCKITC	C-119, C-123
YS40-FXB	C-117	YSD28R2R	H-47	YSR28FX26FXLTCKITC	C-121, C-126	YSR4CFX10LTCKITC	C-122, C-128
YS42A1	C-151	YSD28R2W	H-47	YSR28FX28LTCKITC	C-121, C-126	YSR4CFX6CFXLTKITC	C-122, C-128
YS44	C-111	YSE10	B-50	YSR28FX2CFXLTKITC	C-121, C-126	YSR4CFX8CFXLTKITC	C-122, C-128
YS44A1	C-151	YSE10-BOX	B-50	YSR28FX4CFXLTKITC	C-121, C-127	YSR6CFX10LTCKITC	C-122, C-128
YS44AT	C-152	YSE10HHS	B-51	YSR29FX25FXLTCKITC	C-121, C-126	YSR6CFX14CLTKITC	C-122, C-128
YS44-FXB	C-117	YSE10HN	B-48	YSR29FX28LTCKITC	C-121, C-126	YSR6CFX8CFXLTKITC	C-122, C-128
YS44FXLTCKITC	C-118	YSE14H	B-50	YSR29FX2CFXLTKITC	C-121, C-126	YSR8CFX10LTCKITC	C-122, C-128
YS44-L	C-110	YSE14H-BOX	B-50	YSR2CFX4CFXLTKITC	C-122, C-128	YSR8CFX14CLTKITC	C-122, C-128
YS45A1	C-151	YSE14HHS	B-51	YSR2CFX6CFXLTKITC	C-122, C-128	YSS2R	H-48
YS46	C-111	YSE14HN	B-48	YSR2CFX8CFXLTKITC	C-122, C-128	YSS4R	H-48
YS46A1	C-151	YSE18H	B-50	YSR3125FXLTCKITC	C-121, C-126	YSS6R	H-48
YS47A1	C-151	YSE18H-BOX	B-50	YSR3126FXLTCKITC	C-121, C-126	YSS6RG2	H-48
YS48	C-111	YSE18HHS	B-51	YSR3128FXLTCKITC	C-120, C-125	YST2525	C-137
YS483A1	C-151	YSE18HN	B-48	YSR3128LTCKITC	C-121, C-125	YST2626	C-137
YS48A1	C-151	YSES10K	B-52	YSR3129FXLTCKITC	C-120, C-125	YST2825	C-137
YS4C	C-111	YSES14K	B-52	YSR312CFXLTKITC	C-121, C-126	YST2828	C-137
YS4CA1	C-150	YSES18K	B-52	YSR314CFXLTKITC	C-121, C-126	YST282C	C-137
YS4CFXLTKITC	C-118	YSF28CP	K-41	YSR316CFXLTKITC	C-121, C-126	YST2929	C-137
YS4C-LB	C-113, C-114	YSH2929	C-136	YSR32FX28FXLTCKITC	C-120, C-125	YST2C2C	C-137
YS4C-LBOX	C-110	YSH3429	C-136	YSR32FX29FXLTCKITC	C-120, C-125	YST3131	C-137
YS4C-T	C-116	YSH3434	C-136	YSR3425FXLTCKITC	C-120, C-124	YST3428	C-137
YS5C	C-111	YSH3931	C-136	YSR3426FXLTCKITC	C-120, C-124	YST3434	C-137
YS5C-LB	C-113, C-114	YSH3939	C-136	YSR3428FXLTCKITC	C-120, C-124	YST3939	C-137
YS5C-LBOX	C-110	YSHG3429	E-13	YSR3428LTCKITC	C-120, C-124	YST4C4C	C-137
YS6C	C-111	YSHG3434	E-13	YSR3429FXLTCKITC	C-120, C-124	YSU25A25A	H-46
YS6CA1	C-150	YSHG3931	E-13	YSR3431LTCKITC	C-120, C-124	YSU25R25R	H-46
YS6CFXLTKITC	C-118	YSHG4429	E-13	YSR3434FXLTCKITC	C-120, C-124	YSU25R2R	H-46
YS6C-LBOX	C-110	YSM10	B-56	YSR34FX25FXLTCKITC	C-120, C-125	YSU25R2W	H-46
YS6C-T	C-116	YSM14	B-56	YSR34FX26FXLTCKITC	C-120, C-125	YSU25R4W	H-46
YS8C	C-111	YSM18	B-56	YSR34FX28FXLTCKITC	C-120, C-125	YSU25R6W	H-46
YS8CA1	C-150	YSM1C	B-56	YSR34FX28LTCKITC	C-120, C-125	YSU2R2R	H-46
YS8C-FXB	C-117	YSM25	B-56	YSR34FX29FXLTCKITC	C-120, C-124	YSU2R2W	H-46
YS8CFXLTKITC	C-118	YSM26	B-56	YSR34FX2CFXLTKITC	C-120, C-125	YSU2R4W	H-46
YS8C-L-BOX	C-110	YSM27	B-56	YSR34FX31LTCKITC	C-120, C-124	YSU2R6W	H-46
YSA25R-2N	H-35	YSM28	B-56	YSR34FX4CFXLTKITC	C-120, C-125	YSU2R8W	H-46
YSA26R-2N	H-35	YSM2C	B-56	YSR34FX6CFXLTKITC	C-120, C-125	YSU2W2W	H-46
YSA28R-2N	H-35	YSM4C	B-56	YSR38FX26FXLTCKITC	C-120, C-124	YSU2W4W	H-46
YSA2R-2N	H-35	YSM6C	B-56	YSR38FX28FXLTCKITC	C-120, C-124	YSU2W6W	H-46
YSA30R-2N	H-35	YSM8C	B-56	YSR38FX28LTCKITC	C-120, C-124	YSU2W8W	H-46
YSA321R-2N	H-35	YSP1C-T	C-116	YSR38FX29FXLTCKITC	C-120, C-124	YSU4W4W	H-46
YSA37R-2N	H-35	YSP25-T	C-116	YSR38FX29LTCKITC	C-120, C-124	YSU4W6W	H-46
YSCM104	B-57, C-109	YSP26-T	C-116	YSR38FX30LTCKITC	C-120, C-124	YSU4W8W	H-46
YSCM133	B-57, C-109	YSP28-T	C-116	YSR38FX31LTCKITC	C-120, C-124	YSU6W6W	H-46
YSCM167	B-57, C-109	YSP29-T	C-116	YSR38FX34FXLTCKITC	C-119, C-124	YSV10	B-53
YSCM17	B-57, C-109	YSP2C-T	C-116	YSR38FX34LTCKITC	C-119, C-124	YSV1014-G2	B-58
YSCM212	B-57, C-109	YSP30-T	C-116	YSR3928FXLTCKITC	C-119, C-123	YSV10BBOX	B-46
YSCM231	B-57, C-109	YSP31-T	C-116	YSR3928LTCKITC	C-119, C-123	YSV10BOX	B-53
YSCM27	B-57, C-109	YSP34-T	C-116	YSR3929FXLTCKITC	C-119, C-123	YSV10H	B-55
YSCM42	B-57, C-109	YSP39-T	C-116	YSR3929LTCKITC	C-119, C-123	YSV10-HBOX	B-55
YSCM66	B-57, C-109	YSP4C-T	C-116	YSR3930LTCKITC	C-119, C-123	YSV1214-G1	B-58
YSCM80	B-57, C-109	YSR10CFX12CLTKITC	C-122, C-128	YSR3931LTCKITC	C-119, C-123	YSV14	B-53
YSD25R25R	H-47	YSR10CFX14CLTKITC	C-122, C-128	YSR3934FXLTCKITC	C-119, C-123	YSV1418	B-58
YSD26R25R	H-47	YSR25FX2CFXLTKITC	C-122, C-127	YSR3934LTCKITC	C-119, C-123	YSV14BBOX	B-46
YSD26R26R	H-47	YSR25FX4CFXLTKITC	C-122, C-127	YSR3938FXLTCKITC	C-119, C-123	YSV14BOX	B-53
YSD26R2R	H-47	YSR25FX6CFXLTKITC	C-122, C-127	YSR3939LTCKITC	C-119, C-123	YSV14H	B-55

ALPHA-NUMERIC INDEX BY CATALOG NUMBER (Continued)

Catalog Number	Page #	Catalog Number	Page #	Catalog Number	Page #	Catalog Number	Page #
YSV14-HBOX	B-55	YTS34R34RSHT	I-20	YTS48RT481RS	I-8	YTU25R4W	H-32
YSV18	B-53	YTS34RT34RS	I-8	YTS48RT481RSHT	I-21	YTU26R26R	H-32
YSV18BBOX	B-46	YTS34RT34RSHT	I-21	YTS48RT48RS	I-8	YTU27R27R	H-32
YSV18BOX	B-53	YTS351A	I-33	YTS48RT48RSHT	I-21	YTU28R28R	H-32
YSV18H	B-55	YTS351AT	I-35	YTS49AR	I-34	YTU30R30R	H-32
YSV18-HBOX	B-55	YTS361A	I-33	YTS49ART	I-36	YTU321R26R	H-32
YSV1C-FXB	C-117	YTS361AT	I-35	YTS49R483RS	I-7	YTU321R27R	H-32
YSV1CL	B-54	YTS36R362RS	I-7	YTS49R483RSHT	I-20	YTU321R28R	H-32
YSV1C-LBOX	B-54	YTS36R362RSHT	I-20	YTS49R48RS	I-7	YTU321R2R	H-32
YSV25-FXB	C-117	YTS36R36RS	I-7	YTS49R48RSHT	I-20	YTU321R321R	H-32
YSV25L	B-54	YTS36R36RSHT	I-20	YTS49RT483RS	I-8	YTU33R26R	H-32
YSV25-LBOX	B-54	YTS36RT362RS	I-8	YTS49RT483RSHT	I-21	YTU33R28R	H-32
YSV26-FXB	C-117	YTS36RT362RSHT	I-21	YTS49RT48RS	I-8	YTU33R33R	H-32
YSV26L	B-54	YTS36RT36RS	I-8	YTS49RT48RSHT	I-21	YTW301A	I-29
YSV26-LBOX	B-54	YTS36RT36RSHT	I-21	YTS500E	I-46	YTW301A331AEK	I-29
YSV27-FXB	C-117	YTS375E	H-65, I-46	YTS51AR	I-34	YTW301AD	I-31
YSV27L	B-54	YTS391A	I-33	YTS51ART	I-36	YTW301AD331AEK	I-31
YSV27-LBOX	B-54	YTS391AT	I-35	YTS52R48RS	I-7	YTW301ADT	I-32
YSV28-FXB	C-117	YTS39A	I-33	YTS52R48RSHT	I-20	YTW301ADT331AEK	I-32
YSV28L	B-54	YTS39AR	I-34	YTS52R521RS	I-7	YTW301AT	I-30
YSV28-LBOX	B-54	YTS39ART	I-36	YTS52R521RSHT	I-20	YTW301AT331AEK	I-30
YSV2C-FXB	C-117	YTS39AT	I-35	YTS52R59RS	I-7	YTW311A	I-29
YSV2CL	B-54	YTS39R43RS	I-7	YTS52R59RSHT	I-20	YTW311A331AEK	I-29
YSV2C-LBOX	B-54	YTS39R43RSHT	I-20	YTS52RT48RS	I-8	YTW311AD	I-31
YSV4C-FXB	C-117	YTS39RT43RS	I-8	YTS52RT48RSHT	I-21	YTW311AD331AEK	I-31
YSV4CL	B-54	YTS39RT43RSHT	I-21	YTS52RT521RS	I-8	YTW311ADT	I-32
YSV4C-LBOX	B-54	YTS431A	I-33	YTS52RT521RSHT	I-21	YTW311ADT331AEK	I-32
YSV6C-FXB	C-117	YTS431AT	I-35	YTS52RT59RS	I-8	YTW311AT	I-30
YSV6CL	B-54	YTS438E	H-65, I-46	YTS52RT59RSHT	I-21	YTW311AT331AEK	I-30
YSV6C-LBOX	B-54	YTS43R43RS	I-7	YTS54959RSHT	I-20	YTW32R	I-3
YSV8CL	B-54	YTS43R43RSHT	I-20	YTS549R521RS	I-7	YTW32R33REK	I-3
YSV8C-LBOX	B-54	YTS43RT43RS	I-8	YTS549R521RSHT	I-20	YTW32R33REKHT	I-16
YTA25R-2N	H-33	YTS43RT43RSHT	I-21	YTS549R549RS	I-7	YTW32R34REK	I-3
YTA26-2N	H-35	YTS445A	I-33	YTS549R549RSHT	I-20	YTW32R34REKHT	I-16
YTA26R-2N	H-33	YTS445AT	I-35	YTS549R59RS	I-7	YTW32RD	I-4
YTA27R-2N	H-33	YTS451A	I-33	YTS549RT521RS	I-8	YTW32RD33REK	I-4
YTA28-2N	H-35	YTS451AR	I-34	YTS549RT521RSHT	I-21	YTW32RD33REKHT	I-17
YTA28R-2N	H-33	YTS451ART	I-36	YTS549RT549RS	I-8	YTW32RD34REK	I-4
YTA2C-2N	H-35	YTS451AT	I-35	YTS549RT549RSHT	I-21	YTW32RD34REKHT	I-17
YTA2R-2N	H-33	YTS451R449RS	I-7	YTS549RT59RS	I-8	YTW32RDHT	I-17
YTA321R-2N	H-33	YTS451R449RSHT	I-20	YTS549RT59RSHT	I-21	YTW32RDT	I-6
YTA33R-2N	H-33	YTS451R48RS	I-7	YTS55AR	I-34	YTW32RDT33REK	I-6
YTA34-2N	H-35	YTS451R48RSHT	I-20	YTS55ART	I-36	YTW32RDT33REKHT	I-19
YTA361R-2N	H-33	YTS451RT449RS	I-8	YTS56R59RS	I-7	YTW32RDT34REK	I-6
YTA37R-2N	H-33	YTS451RT449RSHT	I-21	YTS56R59RSHT	I-20	YTW32RDT34REKHT	I-19
YTA391A-2N	H-33	YTS451RT48RS	I-8	YTS56RT59RS	I-8	YTW32RDHT	I-19
YTA39R-2N	H-33	YTS451RT48RSHT	I-21	YTS56RT59RSHT	I-21	YTW32RHT	I-16
YTA43R-2N	H-33	YTS457A	I-33	YTS58R48RS	I-7	YTW32RT	I-5
YTS301A	I-33	YTS457AT	I-35	YTS58R48RSHT	I-20	YTW32RT33REK	I-5
YTS301AT	I-35	YTS463A	I-33	YTS58RT48RS	I-8	YTW32RT33REKHT	I-18
YTS311A	I-33	YTS463AT	I-35	YTS58RT48RSHT	I-21	YTW32RT34REK	I-5
YTS311AT	I-35	YTS47A	I-33	YTS592AR	I-34	YTW32RT34REKHT	I-18
YTS312E	I-46	YTS47AT	I-35	YTS592ART	I-36	YTW32RTHT	I-18
YTS32AR	I-34	YTS484A	I-33	YTS59AR	I-34	YTW331A	I-29
YTS32ART	I-36	YTS484AT	I-35	YTS59ART	I-36	YTW331A331AEK	I-29
YTS32R33RS	I-7	YTS486A	I-33	YTS59R521RS	I-7	YTW331AD	I-31
YTS32R34RS	I-7	YTS486AT	I-35	YTS59R521RSHT	I-20	YTW331AD331AEK	I-31
YTS32R34RSHT	I-20	YTS48A	I-33	YTS59R59RS	I-7	YTW331ADT	I-32
YTS32RT33RS	I-8	YTS48AR	I-34	YTS59R59RSHT	I-20	YTW331ADT331AEK	I-32
YTS32RT33RSHT	I-21	YTS48ART	I-36	YTS59RT521RS	I-8	YTW331AE	I-29, I-30, I-32
YTS32RT34RS	I-8	YTS48AT	I-35	YTS59RT521RSHT	I-21	YTW331AT	I-30
YTS32RT34RSHT	I-21	YTS48R481RS	I-7	YTS59RT59RS	I-8	YTW331AT331AEK	I-30
YTS331A	I-33	YTS48R481RSHT	I-20	YTS59RT59RSHT	I-21	YTW33RE	I-3, I-5, I-6
YTS331AT	I-35	YTS48R48RS	I-7	YTTAG388	E-25	YTW33REHT	I-16, I-17, I-19
YTS34R34RS	I-7	YTS48R48RSHT	I-20	YTU25R25R	H-32	YTW34R	I-3

ALPHA-NUMERIC INDEX BY CATALOG NUMBER (Continued)

Catalog Number	Page #	Catalog Number	Page #	Catalog Number	Page #	Catalog Number	Page #
YTW34R34REK	I-3	YTW391AD431AEK	I-31	YTW451A	I-29	YTW47AE	I-29, I-30, I-32
YTW34R34REKHT	I-16	YTW391ADT	I-32	YTW451A463AEK	I-29	YTW47AT	I-30
YTW34RD	I-4	YTW391ADT431AEK	I-32	YTW451AD	I-31	YTW47AT47AEK	I-30
YTW34RD34REK	I-4	YTW391AT	I-30	YTW451AD463AEK	I-31	YTW481RE	I-3, I-5, I-6
YTW34RD34REKHT	I-17	YTW391AT431AEK	I-30	YTW451ADT	I-32	YTW481REHT	I-16, I-17, I-19
YTW34RDHT	I-17	YTW39A	I-29	YTW451ADT463AEK	I-32	YTW483RE	I-3, I-4, I-5
YTW34RDT	I-6	YTW39A39AEK	I-29	YTW451AT	I-30	YTW483REHT	I-16, I-17, I-19
YTW34RDT34REK	I-6	YTW39AD	I-31	YTW451AT463AEK	I-30	YTW484A	I-29
YTW34RDT34REKHT	I-19	YTW39AD39AEK	I-31	YTW451R	I-3	YTW484A484AEK	I-29
YTW34RDTHHT	I-19	YTW39ADT	I-32	YTW451R45REK	I-3	YTW484AD	I-31
YTW34RE	I-4, I-5, I-6	YTW39ADT39AEK	I-32	YTW451R45REKHT	I-16	YTW484AD484AEK	I-31
YTW34REHT	I-16, I-17, I-19	YTW39AE	I-29, I-30, I-32	YTW451R481REK	I-3	YTW484ADT	I-32
YTW34RHHT	I-16	YTW39AT	I-30	YTW451R481REKHT	I-16	YTW484ADT484AEK	I-32
YTW34RT	I-5	YTW39AT39AEK	I-30	YTW451R48REK	I-3	YTW484AE	I-30, I-31, I-32
YTW34RT34REK	I-5	YTW39R	I-3	YTW451R48REKHT	I-16	YTW484AT	I-30
YTW34RT34REKHT	I-18	YTW39R43REK	I-3	YTW451RD	I-4	YTW484AT484AEK	I-30
YTW34RTHT	I-18	YTW39R43REKHT	I-16	YTW451RD45REK	I-4	YTW486A	I-29
YTW351A	I-29	YTW39RD	I-4	YTW451RD45REKHT	I-17	YTW486A486AEK	I-29
YTW351A351AEK	I-29	YTW39RD43REK	I-4	YTW451RD481REK	I-4	YTW486AD	I-31
YTW351AD	I-31	YTW39RD43REKHT	I-17	YTW451RD481REKHT	I-17	YTW486AD486AEK	I-31
YTW351AD351AEK	I-31	YTW39RDHT	I-17	YTW451RD48REK	I-4	YTW486ADT	I-32
YTW351ADT	I-32	YTW39RDT	I-6	YTW451RD48REKHT	I-17	YTW486ADT486AEK	I-32
YTW351ADT351AEK	I-32	YTW39RDT43REK	I-6	YTW451RDHT	I-17	YTW486AE	I-29, I-30, I-32
YTW351AE	I-29, I-30, I-32	YTW39RDT43REKHT	I-19	YTW451RDT	I-6	YTW486AT	I-30
YTW351AT	I-30	YTW39RDTHHT	I-19	YTW451RDT45REK	I-6	YTW486AT486AEK	I-30
YTW351T351AEK	I-30	YTW39RHHT	I-16	YTW451RDT45REKHT	I-19	YTW48A	I-29
YTW361A	I-29	YTW39RT	I-5	YTW451RDT481REK	I-6	YTW48A484AEK	I-29
YTW361A39AEK	I-29	YTW39RT43REK	I-5	YTW451RDT481REKHT	I-19	YTW48AD	I-31
YTW361AD	I-31	YTW39RT43REKHT	I-18	YTW451RDT48REK	I-6	YTW48AD484AEK	I-31
YTW361AD39AEK	I-31	YTW39RTHT	I-18	YTW451RDT48REKHT	I-19	YTW48ADT	I-32
YTW361ADT	I-32	YTW431A	I-29	YTW451RDTHHT	I-19	YTW48ADT484AEK	I-32
YTW361ADT39AEK	I-32	YTW431A431AEK	I-29	YTW451RHHT	I-16	YTW48AT	I-30
YTW361AT	I-30	YTW431AD	I-31	YTW451RT	I-5	YTW48AT484AEK	I-30
YTW361AT39AEK	I-30	YTW431AD431AEK	I-31	YTW451RT45REK	I-5	YTW48R	I-3
YTW362RE	I-3, I-4, I-6	YTW431ADT	I-32	YTW451RT45REKHT	I-18	YTW48R481REK	I-3
YTW362REHT	I-16, I-18, I-19	YTW431ADT431AEK	I-32	YTW451RT481REK	I-5	YTW48R481REKHT	I-16
YTW36R	I-3	YTW431AE	I-29, I-31, I-32	YTW451RT481REKHT	I-18	YTW48R48REK	I-3
YTW36R362REK	I-3	YTW431AT	I-30	YTW451RT48REK	I-5	YTW48R48REKHT	I-16
YTW36R362REKHT	I-16	YTW431AT431AEK	I-30	YTW451RT48REKHT	I-18	YTW48RD	I-4
YTW36R36REK	I-3	YTW43R	I-3	YTW451RTHT	I-18	YTW48RD481REK	I-4
YTW36R36REKHT	I-16	YTW43R43REK	I-3	YTW457A	I-29	YTW48RD481REKHT	I-17
YTW36RD	I-4	YTW43R43REKHT	I-16	YTW457A463AEK	I-29	YTW48RD48REK	I-4
YTW36RD362REK	I-4	YTW43RD	I-4	YTW457AD	I-31	YTW48RD48REKHT	I-17
YTW36RD362REKHT	I-17	YTW43RD43REK	I-4	YTW457AD463AEK	I-31	YTW48RDHT	I-17
YTW36RD36REK	I-4	YTW43RD43REKHT	I-17	YTW457ADT	I-32	YTW48RDT	I-6
YTW36RD36REKHT	I-17	YTW43RDHT	I-17	YTW457ADT463AEK	I-32	YTW48RDT481REK	I-6
YTW36RDHT	I-17	YTW43RDT	I-6	YTW457AT	I-30	YTW48RDT481REKHT	I-19
YTW36RDT	I-6	YTW43RDT43REK	I-6	YTW457AT463AEK	I-30	YTW48RDT48REK	I-6
YTW36RDT362REK	I-6	YTW43RDT43REKHT	I-19	YTW45RE	I-3, I-5, I-6	YTW48RDT48REKHT	I-19
YTW36RDT362REKHT	I-19	YTW43RDTHHT	I-19	YTW45REHT	I-16, I-17, I-18	YTW48RDTHHT	I-19
YTW36RDT36REK	I-6	YTW43RE	I-3, I-4, I-5	YTW463A	I-29	YTW48RE	I-3, I-4, I-6
YTW36RDT36REKHT	I-19	YTW43REHT	I-16, I-18, I-19	YTW463A463AEK	I-29	YTW48REHT	I-16, I-17, I-19
YTW36RDTHHT	I-19	YTW43RHHT	I-16	YTW463AD	I-31	YTW48RHHT	I-16
YTW36RE	I-3, I-4, I-6	YTW43RT	I-5	YTW463AD463AEK	I-31	YTW48RT	I-5
YTW36REHT	I-16, I-17, I-19	YTW43RT43REK	I-5	YTW463ADT	I-32	YTW48RT481REK	I-5
YTW36RHHT	I-16	YTW43RT43REKHT	I-18	YTW463ADT463AEK	I-32	YTW48RT481REKHT	I-18
YTW36RT	I-5	YTW43RTHT	I-18	YTW463AE	I-29, I-31, I-32	YTW48RT48REK	I-5
YTW36RT362REK	I-5	YTW445A	I-29	YTW463AT	I-30	YTW48RT48REKHT	I-18
YTW36RT362REKHT	I-18	YTW445A463AEK	I-29	YTW463AT463AEK	I-30	YTW48RTHT	I-18
YTW36RT36REK	I-5	YTW445AD	I-31	YTW47A	I-29	YTW49R	I-3
YTW36RT36REKHT	I-18	YTW445AD463AEK	I-31	YTW47A47AEK	I-29	YTW49R483REK	I-3
YTW36RTHT	I-18	YTW445ADT	I-32	YTW47AD	I-31	YTW49R483REKHT	I-16
YTW391A	I-29	YTW445ADT463AEK	I-32	YTW47AD47AEK	I-31	YTW49R50REK	I-3
YTW391A431AEK	I-29	YTW445AT	I-30	YTW47ADT	I-32	YTW49R50REKHT	I-16
YTW391AD	I-31	YTW445AT463AEK	I-30	YTW47ADT47AEK	I-32	YTW49RD	I-4

ALPHA-NUMERIC INDEX BY CATALOG NUMBER (Continued)

Catalog Number	Page #	Catalog Number	Page #	Catalog Number	Page #	Catalog Number	Page #
YTW49RD483REK	I-4	YTW549RD549REKHT	I-17	YTW59R591REKHT	I-16	Z2929	K-33, K-34
YTW49RD483REKHT	I-17	YTW549RD56REK	I-4	YTW59R59REK	I-3	Z2930	K-33, K-34
YTW49RD50REK	I-4	YTW549RD56REKHT	I-17	YTW59R59REKHT	I-16	Z2932	K-33, K-34
YTW49RD50REKHT	I-17	YTW549RDHT	I-17	YTW59RD	I-4	Z2934	K-33, K-34
YTW49RDHT	I-17	YTW549RDT	I-6	YTW59RD591REK	I-4	Z2936	K-33, K-34
YTW49RDT	I-6	YTW549RDT521REK	I-6	YTW59RD591REKHT	I-17	Z2940	K-33, K-34
YTW49RDT483REK	I-6	YTW549RDT521REKHT	I-19	YTW59RD59REK	I-4	Z2944	K-34
YTW49RDT483REKHT	I-19	YTW549RDT549REK	I-6	YTW59RD59REKHT	I-17	Z29NR	K-32, K-35
YTW49RDT50REK	I-6	YTW549RDT549REKHT	I-19	YTW59RDHT	I-17	Z29P	K-31
YTW49RDT50REKHT	I-19	YTW549RDT56REK	I-6	YTW59RDT	I-6	Z2C28	K-33, K-34
YTW49RDHT	I-19	YTW549RDT56REKHT	I-19	YTW59RDT591REK	I-6	Z2C29	K-33, K-34
YTW49RHT	I-16	YTW549RDHT	I-19	YTW59RDT591REKHT	I-19	Z2C30	K-33
YTW49RT	I-5	YTW549RE	I-3, I-5, I-6	YTW59RDT59REK	I-6	Z2C32	K-33
YTW49RT483REK	I-5	YTW549REHT	I-16, I-17, I-19	YTW59RDT59REKHT	I-19	Z2C34	K-33
YTW49RT483REKHT	I-18	YTW549RHT	I-16	YTW59RDHT	I-19	Z2MLDN2-20	K-29
YTW49RT50REK	I-5	YTW549RT	I-5	YTW59RE	I-3, I-4, I-5	Z2MLDN2-30	K-29
YTW49RT50REKHT	I-18	YTW549RT521REK	I-5	YTW59REHT	I-16, I-17, I-19	Z2MLDN2-30B	K-29
YTW49RTHT	I-18	YTW549RT521REKHT	I-18	YTW59RHT	I-16	Z2MLDN4-20	K-29
YTW50RE	I-3, I-5, I-6	YTW549RT549REK	I-5	YTW59RT	I-5	Z2MLDN4-30	K-29
YTW50REHT	I-16, I-17, I-19	YTW549RT549REKHT	I-18	YTW59RT591REK	I-5	Z2MLDN4-30B	K-29
YTW521RE	I-3, I-5, I-6	YTW549RT56REK	I-5	YTW59RT591REKHT	I-18	Z2MLDN6-20	K-29
YTW521REHT	I-16, I-17, I-18	YTW549RT56REKHT	I-18	YTW59RT59REK	I-5	Z2MLDN6-30	K-29
YTW52R	I-3	YTW549RTHT	I-18	YTW59RT59REKHT	I-18	Z2MLDN6-30B	K-29
YTW52R50REK	I-3	YTW56R	I-3	YTW59RTHT	I-18	Z-30	K-57
YTW52R50REKHT	I-16	YTW56R590REK	I-3	Z104C4034	K-36	Z3030	K-33
YTW52R521REK	I-3	YTW56R590REKHT	I-16	Z104C4434	K-36	Z3032	K-33
YTW52R521REKHT	I-16	YTW56RD	I-4	Z-11	K-57	Z3034	K-33
YTW52R56REK	I-3	YTW56RD590REK	I-4	Z144C4840	K-36	Z3036	K-33
YTW52R56REKHT	I-16	YTW56RD590REKHT	I-17	Z-15	K-57	Z3040	K-33
YTW52RD	I-4	YTW56RDHT	I-17	Z1C28	K-34	Z30NR	K-32
YTW52RD50REK	I-4	YTW56RDT	I-6	Z1C29	K-33, K-34	Z3132	K-33
YTW52RD50REKHT	I-17	YTW56RDT590REK	I-6	Z1C30	K-33, K-34	Z3134	K-33
YTW52RD521REK	I-4	YTW56RDT590REKHT	I-19	Z1C32	K-33, K-34	Z3136	K-33
YTW52RD521REKHT	I-17	YTW56RDHT	I-19	Z1C34	K-33	Z3140	K-33
YTW52RD56REK	I-4	YTW56RE	I-3, I-4, I-5, I-6	Z-22.5	K-57	Z3232	K-33, K-34
YTW52RD56REKHT	I-17	YTW56REHT	I-16, I-18, I-19	Z-25	K-57	Z3234	K-33, K-34
YTW52RDHT	I-17	YTW56RHT	I-16	Z2528	K-33, K-34	Z3236	K-33, K-34
YTW52RDT	I-6	YTW56RT	I-5	Z2529	K-33, K-34	Z3240	K-33, K-34
YTW52RDT50REK	I-6	YTW56RT590REK	I-5	Z2530	K-33, K-34	Z3244	K-34
YTW52RDT50REKHT	I-19	YTW56RT590REKHT	I-18	Z2532	K-33, K-34	Z32NR	K-32, K-35
YTW52RDT521REK	I-6	YTW56RTHT	I-18	Z2534	K-33, K-34	Z3334	K-33, K-34
YTW52RDT521REKHT	I-19	YTW58R	I-3	Z2536	K-34	Z3336	K-33, K-34
YTW52RDT56REK	I-6	YTW58R58REK	I-3	Z2628	K-34	Z3340	K-33, K-34
YTW52RDT56REKHT	I-19	YTW58R58REKHT	I-16	Z2629	K-33, K-34	Z3344	K-34
YTW52RDHT	I-19	YTW58RD	I-4	Z2630	K-33, K-34	Z3434	K-33, K-34
YTW52RHT	I-16, I-18	YTW58RD58REK	I-4	Z2632	K-33, K-34	Z3436	K-33, K-34
YTW52RT	I-5	YTW58RD58REKHT	I-17	Z2634	K-33, K-34	Z3440	K-33, K-34
YTW52RT50REK	I-5	YTW58RDHT	I-17	Z2636	K-34	Z3444	K-33, K-34
YTW52RT50REKHT	I-18	YTW58RDT	I-6	Z2640	K-34	Z34NR	K-32, K-35
YTW52RT521REK	I-5	YTW58RDT58REK	I-6	Z2728	K-33, K-34	Z34NRB	K-32
YTW52RT521REKHT	I-18	YTW58RDT58REKHT	I-19	Z2729	K-34	Z34P	K-31
YTW52RT56REK	I-5	YTW58RDHT	I-19	Z2730	K-33, K-34	Z3536	K-33
YTW52RT56REKHT	I-18	YTW58RE	I-3, I-4, I-6	Z2732	K-33, K-34	Z3540	K-33
YTW52RTHT	I-18	YTW58REHT	I-16, I-17, I-19	Z2734	K-33, K-34	Z3544	K-33
YTW549R	I-3	YTW58RHT	I-16	Z2736	K-34	Z3636	K-33, K-34
YTW549R521REK	I-3	YTW58RT	I-5	Z2740	K-34	Z3640	K-33, K-34
YTW549R521REKHT	I-16	YTW58RT58REK	I-5	Z2828	K-33	Z3644	K-33, K-34
YTW549R549REK	I-3	YTW58RT58REKHT	I-18	Z2829	K-33, K-34	Z36NR	K-32, K-35
YTW549R549REKHT	I-16	YTW58RTHT	I-18	Z2830	K-33, K-34	Z-37.5	K-57
YTW549R56REK	I-3	YTW590RE	I-3, I-5, I-6	Z2832	K-33, K-34	Z3740	K-33
YTW549R56REKHT	I-16	YTW590REHT	I-16, I-17, I-18	Z2834	K-33, K-34	Z3744	K-33
YTW549RD	I-4	YTW591RE	I-3, I-4, I-5	Z2836	K-34	Z3840	K-33
YTW549RD521REK	I-4	YTW591REHT	I-16, I-17, I-19	Z2840	K-34	Z3844	K-33
YTW549RD521REKHT	I-17	YTW59R	I-3	Z2844	K-34	Z3940	K-33
YTW549RD549REK	I-4	YTW59R591REK	I-3	Z28NR	K-32, K-35	Z3944	K-33

ALPHA-NUMERIC INDEX BY CATALOG NUMBER (Continued)

Catalog Number	Page #	Catalog Number	Page #	Catalog Number	Page #	Catalog Number	Page #
Z3C28	K-34	ZMDN5-20	K-30	ZMK5-25B12	K-20	ZML5-25	K-18
Z3ONR	K-35	ZMDN5-20B	K-30	ZMK530	K-26	ZML5-25A3	K-18
Z4040	K-33	ZMDN5-25	K-30	ZMK530B	K-26	ZML5-25B	K-18
Z4044	K-33	ZMDN6-20	K-30	ZMK6-15	K-14	ZML5-25B12	K-18
Z40NR	K-32	ZMDN6-20B	K-30	ZMK6-15A3	K-14	ZML5-30	K-24
Z40NRA	K-32	ZMDN6-25	K-30	ZMK6-15A4	K-14	ZML5-30B	K-24
Z40P	K-31	ZME2-15	K-11	ZMK6-25	K-20	ZML6-15	K-12
Z4144	K-33	ZME2-25	K-17	ZMK6-25A4	K-20	ZML6-15A3	K-12
Z4244	K-33	ZME2-25B	K-17	ZMK6-25B	K-20	ZML6-25	K-18
Z4344	K-33	ZME230	K-23	ZMK6-25B12	K-20	ZML6-25A3	K-18
Z-44	K-57	ZME230B	K-23	ZMK630	K-26	ZML6-25B	K-18
Z4444	K-33	ZME3-15	K-11	ZMK630B	K-26	ZML6-25B12	K-18
Z44NR	K-32	ZME3-25	K-17	ZMK7-15	K-14	ZML6-30	K-24
Z4C28	K-33	ZME3-25B	K-17	ZMK7-15A3	K-14	ZML6-30B	K-24
Z4C29	K-33	ZME330	K-23	ZMK7-15A4	K-14	ZML7-15	K-12
Z4C30	K-33	ZME330B	K-23	ZMK7-25	K-20	ZML7-15A3	K-12
Z-50	K-57	ZME4-15	K-11	ZMK7-25A4	K-20	ZML7-25	K-18
Z6C28	K-33	ZME4-25	K-17	ZMK7-25B	K-20	ZML7-25A3	K-18
Z6C29	K-33	ZME4-25B	K-17	ZMK7-25B12	K-20	ZML7-25B	K-18
Z6C30	K-33	ZME430	K-23	ZMK730	K-26	ZML7-25B12	K-18
Z-7.5	K-57	ZME430B	K-23	ZMK730B	K-26	ZML7-30	K-24
Z72C3029	K-36	ZME5-15	K-11	ZMK8-15	K-14	ZML7-30B	K-24
Z88C3429	K-36	ZME5-25	K-17	ZMK8-15A3	K-14	ZML8-15	K-12
ZH50	K-57	ZME5-25B	K-17	ZMK8-15A4	K-14	ZML8-25	K-18
ZM10-15	K-9	ZME530	K-23	ZMK8-25	K-20	ZML8-25A3	K-18
ZM10-25	K-15	ZME530B	K-23	ZMK8-25A4	K-20	ZML8-25B	K-18
ZM10-25B	K-15	ZME6-15	K-11	ZMK8-25B	K-20	ZML8-25B12	K-18
ZM10-30	K-21	ZME6-25	K-17	ZMK8-25B12	K-20	ZML8-30	K-24
ZM10-30B	K-21	ZME6-25B	K-17	ZMK830	K-26	ZML8-30B	K-24
ZM12-15	K-9	ZME630	K-23	ZMK830B	K-26	ZML9-15	K-12
ZM12-25	K-15	ZME630B	K-23	ZMK9-15	K-14	ZML9-15A3	K-12
ZM12-25B	K-15	ZME7-15	K-11	ZMK9-15A3	K-14	ZML9-25	K-18
ZM12-30	K-21	ZME7-25	K-17	ZMK9-15A4	K-14	ZML9-25A3	K-18
ZM12-30B	K-21	ZME7-25B	K-17	ZMK9-25	K-20	ZML9-25B	K-18
ZM14-15	K-9	ZME730	K-23	ZMK9-25A4	K-20	ZML9-25B12	K-18
ZM14-25	K-15	ZME730B	K-23	ZMK9-25B	K-20	ZML9-30	K-24
ZM14-25B	K-15	ZME8-15	K-11	ZMK9-25B12	K-20	ZML9-30B	K-24
ZM14-30	K-21	ZME8-25	K-17	ZMK930	K-26	ZMLDN1-15	K-27
ZM14-30B	K-21	ZME8-25B	K-17	ZML0-15A3	K-12	ZMLDN1-20	K-27
ZM16-15	K-9	ZME830	K-23	ZML2-15	K-12	ZMLDN1-20B	K-27
ZM16-25	K-15	ZME830B	K-23	ZML2-15A3	K-12	ZMLDN1-25	K-28
ZM16-25B	K-15	ZMK10-15	K-14	ZML2-25	K-18	ZMLDN1-25B	K-28
ZM16-30	K-21	ZMK10-15A3	K-14	ZML2-25A3	K-18	ZMLDN1-30	K-28
ZM16-30B	K-21	ZMK10-15A4	K-14	ZML2-25B	K-18	ZMLDN1-30B	K-28
ZM4-15	K-9	ZMK10-25	K-20	ZML2-25B12	K-18	ZMLDN2-15	K-27
ZM4-25	K-15	ZMK10-25A4	K-20	ZML2-30	K-24	ZMLDN2-20	K-27
ZM4-25B	K-15	ZMK10-25B	K-20	ZML2-30B	K-24	ZMLDN2-20B	K-27
ZM4-30	K-21	ZMK10-25B12	K-20	ZML3-15	K-12	ZMLDN2-25	K-28
ZM4-30B	K-21	ZMK1030	K-26	ZML3-15A3	K-12	ZMLDN2-25B	K-28
ZM6-15	K-9	ZMK1030B	K-26	ZML3-25	K-18	ZMLDN2-30	K-28
ZM6-25	K-15	ZMK4-15	K-14	ZML3-25A3	K-18	ZMLDN2-30B	K-28
ZM6-25B	K-15	ZMK4-15A3	K-14	ZML3-25B	K-18	ZMLDN3-15	K-27
ZM6-30	K-21	ZMK4-15A4	K-14	ZML3-25B12	K-18	ZMLDN3-20	K-27
ZM6-30B	K-21	ZMK4-25	K-20	ZML3-30	K-24	ZMLDN3-20B	K-27
ZM8-15	K-9	ZMK4-25A4	K-20	ZML3-30B	K-24	ZMLDN3-25	K-28
ZM8-25	K-15	ZMK4-25B	K-20	ZML4-15	K-12	ZMLDN3-25B	K-28
ZM8-25B	K-15	ZMK4-25B12	K-20	ZML4-15A3	K-12	ZMLDN3-30	K-28
ZM8-30	K-21	ZMK430	K-26	ZML4-25	K-18	ZMLDN3-30B	K-28
ZM8-30B	K-21	ZMK430B	K-26	ZML4-25A3	K-18	ZMLDN4-15	K-27
ZMDN3-20	K-30	ZMK5-15	K-14	ZML4-25B	K-18	ZMLDN4-20	K-27
ZMDN3-20B	K-30	ZMK5-15A3	K-14	ZML4-25B12	K-18	ZMLDN4-20B	K-27
ZMDN3-25	K-30	ZMK5-15A4	K-14	ZML4-30	K-24	ZMLDN4-25	K-28
ZMDN4-20	K-30	ZMK5-25	K-20	ZML4-30B	K-24	ZMLDN4-25B	K-28
ZMDN4-20B	K-30	ZMK5-25A4	K-20	ZML5-15	K-12	ZMLDN4-30	K-28
ZMDN4-25	K-30	ZMK5-25B	K-20	ZML5-15A3	K-12	ZMLDN4-30B	K-28

ALPHA-NUMERIC INDEX BY CATALOG NUMBER (Continued)

Catalog Number	Page #	Catalog Number	Page #	Catalog Number	Page #
ZMLDN5-15	K-27	ZMT7-15	K-10	ZMX4-25	K-19
ZMLDN5-20	K-27	ZMT7-15A3	K-10	ZMX4-25A4	K-19
ZMLDN5-20B	K-27	ZMT7-25	K-16	ZMX4-25B	K-19
ZMLDN5-25	K-28	ZMT7-25A3	K-16	ZMX4-25B12	K-19
ZMLDN5-25B	K-28	ZMT7-25B	K-16	ZMX4-30	K-25
ZMLDN5-30	K-28	ZMT7-25B12	K-16	ZMX4-30B	K-25
ZMLDN5-30B	K-28	ZMT7-30	K-22	ZMX6-15	K-13
ZMLDN6-15	K-27	ZMT7-30B	K-22	ZMX6-15A3	K-13
ZMLDN6-20	K-27	ZMT9-15	K-10	ZMX6-15A4	K-13
ZMLDN6-20B	K-27	ZMT9-15A3	K-10	ZMX6-25	K-19
ZMLDN6-25	K-28	ZMT9-25	K-16	ZMX6-25A4	K-19
ZMLDN6-25B	K-28	ZMT9-25A3	K-16	ZMX6-25B	K-19
ZMLDN6-30	K-28	ZMT9-25B	K-16	ZMX6-25B12	K-19
ZMLDN6-30B	K-28	ZMT9-25B12	K-16	ZMX6-30	K-25
ZMS29	K-35	ZMT9-30B	K-22	ZMX6-30B	K-25
ZMS34	K-35	ZMTDN1015	K-31	ZMX8-15	K-13
ZMS40	K-35	ZMTDN81025	K-31	ZMX8-15A3	K-13
ZMT11-15	K-10	ZMTDN815	K-31	ZMX8-15A4	K-13
ZMT11-15A3	K-10	ZMTDN820	K-31	ZMX8-25	K-19
ZMT11-25	K-16	ZMX10-15	K-13	ZMX8-25A4	K-19
ZMT11-25A3	K-16	ZMX10-15A3	K-13	ZMX8-25B	K-19
ZMT11-25B	K-16	ZMX10-15A4	K-13	ZMX8-25B12	K-19
ZMT11-25B12	K-16	ZMX10-25	K-19	ZMX8-30	K-25
ZMT11-30	K-22	ZMX10-25A4	K-19	ZMX8-30B	K-25
ZMT11-30B	K-22	ZMX10-25B	K-19		
ZMT13-15	K-10	ZMX10-25B12	K-19		
ZMT13-15A3	K-10	ZMX10-30	K-25		
ZMT13-25	K-16	ZMX10-30B	K-25		
ZMT13-25A3	K-16	ZMX12-15	K-13		
ZMT13-25B	K-16	ZMX12-15A3	K-13		
ZMT13-25B12	K-16	ZMX12-15A4	K-13		
ZMT13-30	K-22	ZMX12-25	K-19		
ZMT13-30B	K-22	ZMX12-25A4	K-19		
ZMT15-15	K-10	ZMX12-25B	K-19		
ZMT15-15A3	K-10	ZMX12-25B12	K-19		
ZMT15-25	K-16	ZMX12-30	K-25		
ZMT15-25A3	K-16	ZMX14-15	K-13		
ZMT15-25B	K-16	ZMX14-15A3	K-13		
ZMT15-25B12	K-16	ZMX14-15A4	K-13		
ZMT15-30	K-22	ZMX14-25	K-19		
ZMT15-30B	K-22	ZMX14-25A4	K-19		
ZMT17-15	K-10	ZMX14-25B	K-19		
ZMT17-15A3	K-10	ZMX14-25B12	K-19		
ZMT17-25	K-16	ZMX14-30	K-25		
ZMT17-25A3	K-16	ZMX14-30B	K-25		
ZMT17-25B	K-16	ZMX16-15	K-13		
ZMT17-25B12	K-16	ZMX16-15A3	K-13		
ZMT17-30	K-22	ZMX16-15A4	K-13		
ZMT17-30B	K-22	ZMX16-25	K-19		
ZMT3-15	K-10	ZMX16-25A4	K-19		
ZMT3-15A3	K-10	ZMX16-25B	K-19		
ZMT3-25	K-16	ZMX16-25B12	K-19		
ZMT3-25B	K-16	ZMX16-30	K-25		
ZMT3-25A3	K-16	ZMX18-15	K-13		
ZMT3-25B12	K-16	ZMX18-15A3	K-13		
ZMT3-30	K-22	ZMX18-15A4	K-13		
ZMT3-30B	K-22	ZMX18-25	K-19		
ZMT5-15	K-10	ZMX18-25A4	K-19		
ZMT5-15A3	K-10	ZMX18-25B	K-19		
ZMT5-25	K-16	ZMX18-25B12	K-19		
ZMT5-25A3	K-16	ZMX18-30	K-25		
ZMT5-25B	K-16	ZMX18-30B	K-25		
ZMT5-25B12	K-16	ZMX4-15	K-13		
ZMT5-30	K-22	ZMX4-15A3	K-13		
ZMT5-30B	K-22	ZMX4-15A4	K-13		