

Conduit Outlet Boxes and Bodies: Malleable Iron or Aluminum; Explosionproof, Dust-Ignitionproof

UNILETS® for use with Threaded Metal Conduit.

Applications

- Meet a wide range of classified area requirements.
- Corrosion-resistant—ideal indoors or out.
- For pulling of wires.
- Connect conduit lengths and change direction of conduit.
- Provide access for maintenance.

Features: All Bodies and Boxes

- Malleable iron bodies have high tensile strength and ductility. Provides great resistance to corrosion, impact, and shock.
- Accurately tapped, tapered hub threads for tight, rigid joints and ground continuity.
- Furnish with covers.
- General purpose wiring.

Features: GR and GRF

- ①GR offers ten hub arrangements.
- ②GRF has integral mounting flange.
- Function as sealing fittings when used with sealing covers (see NEC for restrictions).
- Internally threaded body with externally threaded cover.
- Covers have pry notches for bar or wrench.
- Accommodate sealing, dome, hub and union hub covers, and canopies.
- Standard O-rings provide raintight fit. NEMA 3,4.
- Internal ground screw standard.
- Smooth, rounded integral bushing in each hub type box protects conductor insulation.

Features: GRH

- ③Designed for use in Class I, Groups A, B, C, and D; Class II, Groups E, F, and G; and Class III.
- Internally threaded body with externally threaded covers.
- Standard O-rings provide raintight fit. NEMA 3,4.
- Internal ground screw standard.
- Smooth, rounded integral bushing in each hub type box protects conductor insulation.

Features: ELBD

- ④Exclusive built-in pulling rollers in each end (2-1/2 thru 4" sizes) protect cable from damage and make cable pulling easier.

Effective September, 2005
Copyright 2005

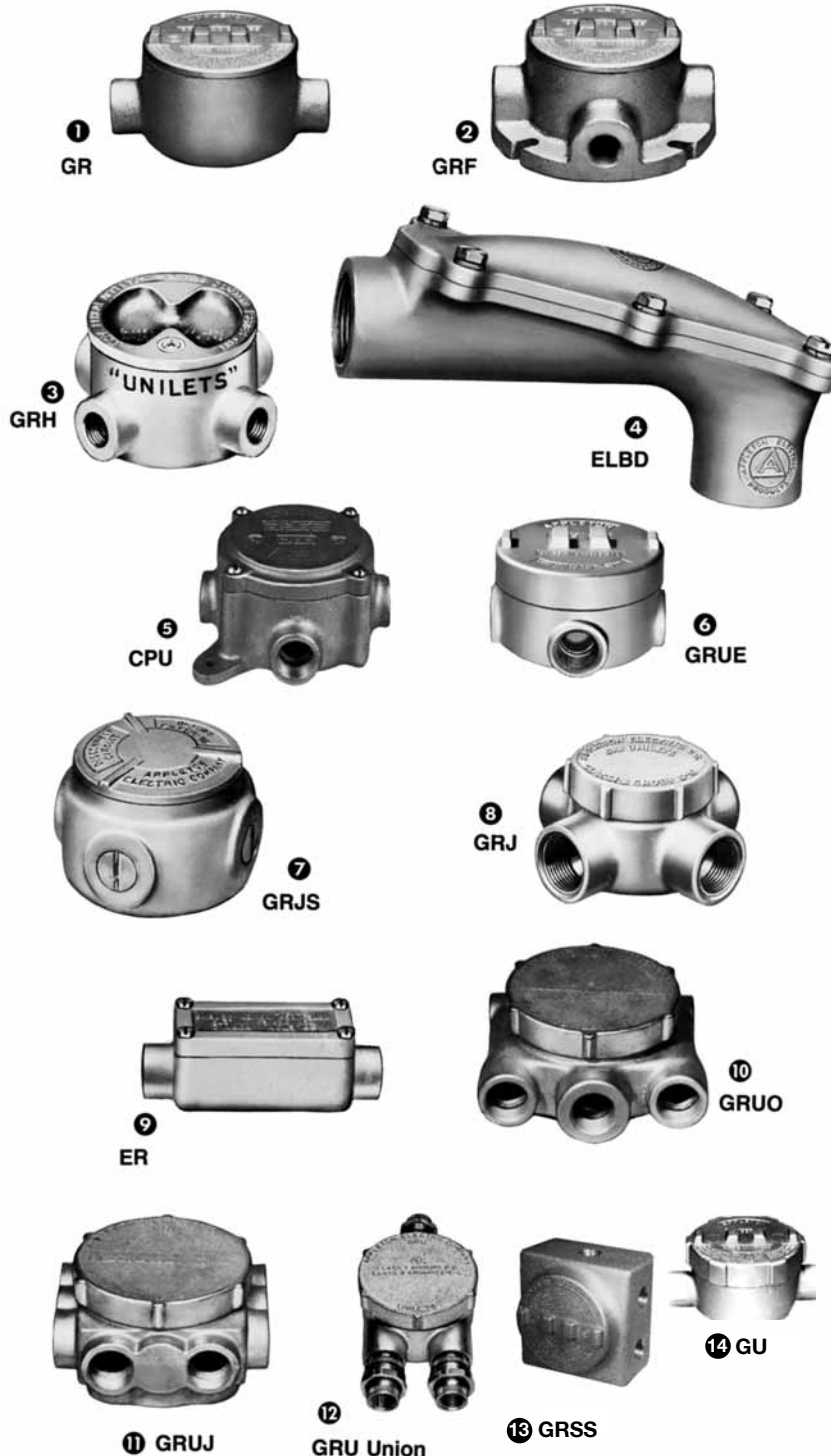

Conduit Outlet Boxes and Bodies: Malleable Iron or Aluminum; Explosionproof, Dust-Ignitionproof

UNILETS® for use with Threaded Metal Conduit.

- Excellent for use in wiring of motors, panelboards, circuit breakers, entrances to buildings, etc.

- Body and cover have ground mating surfaces to meet classified-location requirements.

- Smooth, rounded integral bushing in each hub type box protects conductor insulation.

Features: ELBY

- Serve as pulling fittings.
- Make 90° bends in conduit.
- Threaded cover opening permits easy access for pulling conductors thru hubs.
- Easily removable threaded cover.

Features: CPU

- ⑤ Universal design with four threaded universal hubs and three close-up plugs.
- Serve as mounting outlets for lighting fixtures when used with hub cover.
- Wide, accurately ground explosion-proof mating surfaces.
- Smooth, rounded integral bushing in each hub type box protects conductor insulation.

Features: GRU and GRUE

- ⑥ Universal design with five threaded universal hubs and three close-up plugs.
- Copper-free aluminum body and cover provide resistance to corrosive atmospheres.
- Function as sealing fittings when used with sealing covers (see NEC for restrictions).
- GRU has internally threaded body and externally threaded cover with O-ring for raintight fit, NEMA 3,4. GRUE has externally threaded body and internally threaded overlapping cover.
- Covers have pry notches for bar or wrench.
- Smooth, rounded integral bushing in each hub type box protects conductor insulation.

Features: GRJS

- ⑦ Universal design with five threaded openings and three close-up plugs.
- Compact round box for use where space is limited.
- Serve as mounting means for lighting fixtures when used with hub cover.
- Function as sealing fittings when

used with sealing covers (see NEC for restrictions).

- Internally threaded body with externally threaded cover.

- Smooth, rounded integral bushing in each hub type box protects conductor insulation.

Features: GRJ

- ⑧ Small, round conduit outlet boxes.
- Function as sealing fittings when used with sealing covers (see NEC for restrictions).
- Externally threaded body with internally threaded cover.
- Smooth, rounded integral bushing in each hub type box protects conductor insulation.

Features: ER

- ⑨ Compact, rectangular conduit outlet boxes are ideal in classified locations where space is limited.
- Six different hub arrangements.
- Ground surface contact between body and cover assures a flame-tight joint.
- Smooth, rounded integral bushing in each hub type box protects conductor insulation.

Features: GRUO and GRUJ

- Threaded universal hubs for wiring flexibility.
- ⑩ GRUO has eight hubs.
- ⑪ GRUJ offers up to eleven hubs.
- Ideally suited for use where space is limited, such as for gasoline pumps.
- Function as sealing fittings when used with sealing cover (see NEC for restrictions).
- Externally threaded body with internally threaded covers.
- Smooth, rounded integral bushing in each hub type box protects conductor insulation.

Features: GRU (Union Hubs)

- ⑫ Union hubs permit easy wiring.
- Function as sealing fittings when used with sealing covers (see NEC for restrictions).
- Externally threaded body with internally threaded cover.
- Smooth, rounded integral bushing in each hub type box protects conductor insulation.

Features: GRSS and GRSSA

- ⑬ Multiple hubs permit flexibility.
- Copper-free aluminum body and cover provide superior corrosion resistance.
- Internal ground screw standard.

Features: GU

- ⑭ Designed for Class I, Groups B,C,D; Class II, Groups E,F,G; and Class III.
- Externally threaded body with internally threaded cover.
- Smooth, rounded integral bushing in each hub type box protects conductor insulation.
- Internal ground screw standard.

Standard Materials

- *GR, GRF, GRH, and GRJS:* Malleable iron bodies with aluminum covers.
- *Aluminum GR Series:* Copper-free body and cover.
- *GU, GRUO, GRUJ, GRU (Union), GRJ, CPU, ER, ELBD and ELBY:* Malleable iron bodies and covers.
- *GRU, GRUE, and GRSS:* Aluminum copper-free bodies and covers.
- *GRG O-Rings:* Neoprene.

Standard Finishes

- *Malleable iron bodies and covers (except ELBY)* triple-coat—(1) zinc electroplate, (2) dichromate, and (3) epoxy powder coat.
- *Aluminum bodies and covers:* epoxy powder coat.
- *ELBY malleable iron body and cover:* zinc electroplate and clear chromate.

Compliances







- UL Standard 886.
- Federal Spec. W-C-586B.
- Appleton malleable iron products conform to ASTM A47-77, Grade 32510, which has the following properties: tensile strength, 50,000 psi; yield, 32,000 psi; and elongation, 10%.
- Appleton aluminum products are produced from a high strength copper-free (4/10 of 1% max.) alloy.
- Suitable for Class I, Div. 1 & 2, if installed in compliance with NEC 501-4(a)(b) and for Class II, Div. 1 & 2, if in compliance with NEC 502-4(a)(b).
- *GR Series:* CSA -LR25875-30.

J-4

Class I, Div. 1 and 2
Groups B*,C,D
Class II, Div. 1 and 2
Groups E,F,G
Class III
NEMA 3,4

GR Conduit Outlet Boxes: Explosionproof, Dust-Ignitionproof

UNILETS® for use with Threaded Metal Conduit.
Furnished with Internal Ground Screw and O-Ring.

	Hub Type	Conduit Size (Inches)	Cover Opening (Inches)	Cubic Inches	Form No.†	Catalog Number* Malleable Iron*	Aluminum*
	GRE	1/2	3.38	18	1	GRE50	GRE50-A
		3/4	3.38	18	1	GRE75	GRE75-A
		1	3.38	18	1	GRE100	GRE100-A
		1-1/4	3.94	31	2	GRE125	GRE125-A
		1-1/2	4.88	72	3	GRE150	GRE150-A
	GRC	1/2	3.38	18	1	GRC50	GRC50-A
		3/4	3.38	18	1	GRC75	GRC75-A
		1	3.38	18	1	GRC100	GRC100-A
		1-1/4	3.94	31	2	GRC125	GRC125-A
		1-1/2	4.88	72	3	GRC150	GRC150-A
2	4.88	76	3	GRC200	GRC200-A		
	GRL	1/2	3.38	18	1	GRL50	GRL50-A
		3/4	3.38	18	1	GRL75	GRL75-A
		1	3.38	18	1	GRL100	GRL100-A
		1-1/4	3.94	31	2	GRL125	GRL125-A
		1-1/2	4.88	72	3	GRL150	GRL150-A
2	4.88	76	3	GRL200	GRL200-A		
	GRLB	1/2	3.38	18	1	GRLB50	GRLB50-A
		3/4	3.38	18	1	GRLB75	GRLB75-A
		1	3.38	18	1	GRLB100	GRLB100-A
		1-1/4	3.94	31	2	GRLB125	GRLB125-A
		1-1/2	4.88	72	3	GRLB150	GRLB150-A
2	4.88	76	3	GRLB200	GRLB200-A		
	GRN	1/2	3.38	18	1	GRN50	GRN50-A
		3/4	3.38	18	1	GRN75	GRN75-A
		1	3.38	18	1	GRN100	GRN100-A
		1-1/4	3.94	31	2	GRN125	GRN125-A
		1-1/2	4.88	72	3	GRN150	GRN150-A
	GRT	1/2	3.38	18	1	GRT50	GRT50-A
		3/4	3.38	18	1	GRT75	GRT75-A
		1	3.38	18	1	GRT100	GRT100-A
		1-1/4	3.94	31	2	GRT125	GRT125-A
		1-1/2	4.88	72	3	GRT150	GRT150-A
2	4.88	76	3	GRT200	GRT200-A		
	GRX	1/2	3.38	18	1	GRX50	GRX50-A
		3/4	3.38	18	1	GRX75	GRX75-A
		1	3.38	18	1	GRX100	GRX100-A
		1-1/4	3.94	31	2	GRX125	GRX125-A
		1-1/2	4.88	72	3	GRX150	GRX150-A
2	4.88	76	3	GRX200	GRX200-A		

* In Class I, Div. 1, Group B atmospheres, all conduit runs must have a sealing fitting (not supplied) field installed adjacent to the enclosure.
• Supplied with Aluminum covers.

† Form number designates body and matching cover sizes. To order body without cover, add suffix **-LC** to catalog number.
Other covers available—see GR Cover listing page and order separately.

See J-8 for optional Terminal Blocks.

**Class I, Div. 1 and 2
Groups B*,C,D
Class II, Div. 1 and 2
Groups E,F,G
Class III
NEMA 3,4**

GR Conduit Outlet Boxes: Explosionproof, Dust-Ignitionproof

UNILETS® for use with Threaded Metal Conduit.
Furnished with Internal Ground Screw and O-Ring.



Hub Type	Conduit Size (Inches)	Cover Opening (Inches)	Form No.†	Catalog Number*	
				Malleable Iron	Aluminum
GRCA	1/2	3.38	1	GRCA50	GRCA50-A
	3/4	3.38	1	GRCA75	GRCA75-A
GRLA	1/2	3.38	1	GRLA50	GRLA50-A
	3/4	3.38	1	GRLA75	GRLA75-A
GRTA	1/2	3.38	1	GRTA50	GRTA50-A
	3/4	3.38	1	GRTA75	GRTA75-A

* In Class I, Div. 1, Group B atmospheres, all conduit runs must have a sealing fitting (not supplied) field installed adjacent to the enclosure.
• Supplied with Aluminum covers.

† Form number designates body and matching cover sizes. To order body without cover, add suffix **-LC** to catalog number.
Other covers available—see GR Cover listing page and order separately.

See J-8 for optional Terminal Blocks.

GR Form 1

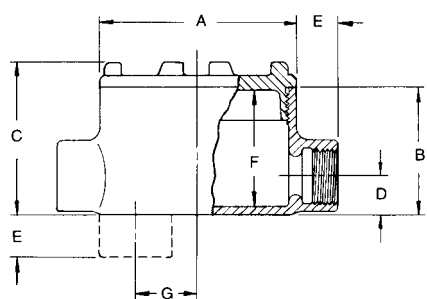

GR Series, Form 1

Dimensions in Inches

Hub Size (In.)	A	B	C	D	E	F	G
1/2	3.75	2.44	2.88	.75	.81	2.25	1.25
3/4	3.75	2.44	2.88	.75	.81	2.25	1.25
1	3.75	2.44	2.88	.94	.94	2.25	1.06

Dimensions in Centimeters

1/2	9.5	6.2	7.3	1.9	2.1	5.7	3.2
3/4	9.5	6.2	7.3	1.9	2.1	5.7	3.2
1	9.5	6.2	7.3	2.4	2.4	5.7	2.7

GR Forms 2 and 3

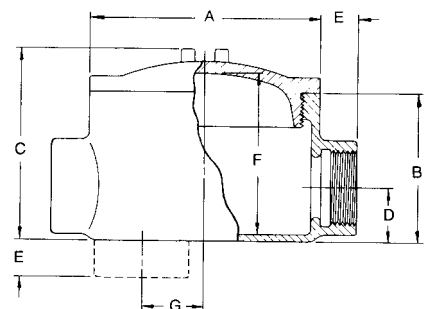

GR Series, Forms 2 and 3

Dimensions in Inches

Hub Size (In.)	A	B	C	D	E	F	G
1-1/4	4.50	2.69	3.56	1.19	.88	2.75	1.13
1-1/2	5.75	3.75	4.81	1.38	.94	4.06	1.50
2	5.75	4.00	5.06	1.63	1.00	4.25	1.25

Dimensions in Centimeters

1-1/4	11.4	6.8	9.1	3.0	2.2	7.0	2.9
1-1/2	14.6	9.5	12.2	3.5	2.4	10.3	3.8
2	14.6	10.2	12.9	4.1	2.5	10.8	3.2





For cubic inches information, see page J-19

J-6

Class I, Div. 1 and 2
Groups B*, C, D
Class II, Div. 1 and 2
Groups E, F, G
Class III
NEMA 3, 4

GRF Flanged Conduit Outlet Boxes: Explosionproof, Dust-Ignitionproof

UNILETS® for use with Threaded Metal Conduit.
Furnished with Internal Ground Screw and O-Ring.

	Hub Type	Conduit Size (Inches)	Cover Opening (Inches)	Form No.†	Catalog Number*	
					Malleable Iron	Aluminum
	GRFC	1/2	3.38	1	GRFC50	GRFC50-A
		3/4	3.38	1	GRFC75	GRFC75-A
		1	3.38	1	GRFC100	GRFC100-A
	GRFL	1/2	3.38	1	GRFL50	GRFL50-A
		3/4	3.38	1	GRFL75	GRFL75-A
		1	3.38	1	GRFL100	GRFL100-A
	GRFT	1/2	3.38	1	GRFT50	GRFT50-A
		3/4	3.38	1	GRFT75	GRFT75-A
		1	3.38	1	GRFT100	GRFT100-A
	GRFX	1/2	3.38	1	GRFX50	GRFX50-A
		3/4	3.38	1	GRFX75	GRFX75-A
		1	3.38	1	GRFX100	GRFX100-A

* In Class I, Div. 1, Group B atmospheres, all conduit runs must have a sealing fitting (not supplied) field installed adjacent to the enclosure.

† Form number designates body and matching cover sizes. To order body without cover, add suffix -LC to catalog number.
Other covers available—see GR Cover listing page and order separately.

For cubic inches information, see page J-19



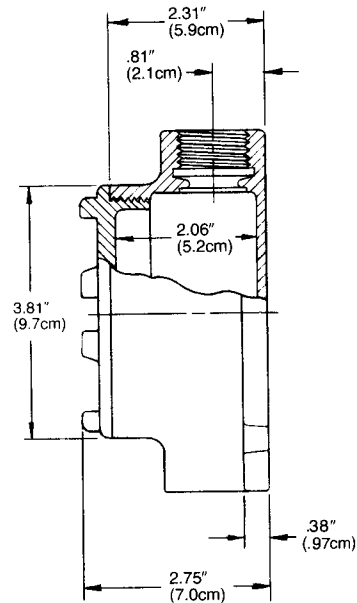
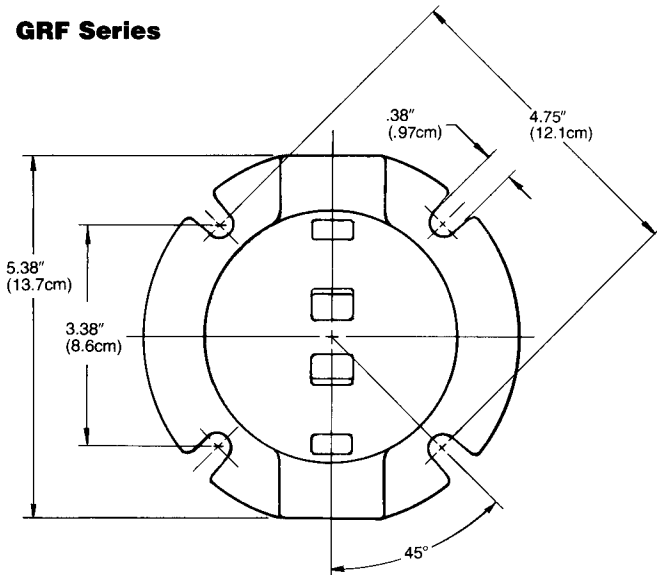

GRF Series



Class I, Div. 1 and 2
Groups A,B,C,D
Class II, Div. 1 and 2
Groups E,F,G
Class III
NEMA 3,4

GRH Conduit Outlet Boxes: Explosionproof, Dust-Ignitionproof

UNILETS® for use with Threaded Metal Conduit.
Furnished with Internal Ground Screw and O-Ring.

	Hub Type	Conduit Size (Inches)	Cover Opening (Inches)	Catalog Number Malleable Iron
	GRHC	1/2	3.38	GRHC50
		3/4	3.38	GRHC75
		1	3.38	GRHC100
	GRHL	1/2	3.38	GRHL50
		3/4	3.38	GRHL75
		1	3.38	GRHL100
	GRHLB	1/2	3.38	GRHLB50
		3/4	3.38	GRHLB75
		1	3.38	GRHLB100
	GRHT	1/2	3.38	GRHT50
		3/4	3.38	GRHT75
		1	3.38	GRHT100
	GRHX	1/2	3.38	GRHX50
		3/4	3.38	GRHX75
		1	3.38	GRHX100

GRH Series

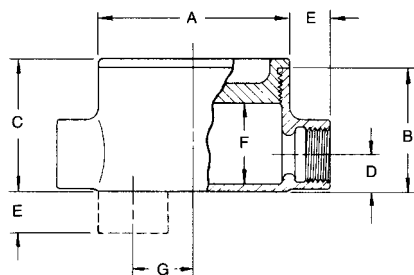

GRH Series

Dimensions in Inches

Hub Size (In.)	A	B	C	D	E	F	G
1/2	3.75	2.44	2.63	.75	.81	1.63	1.25
3/4	3.75	2.44	2.63	.75	.81	1.63	1.25
1	3.75	2.44	2.63	.94	.94	1.63	1.06









Dimensions in Centimeters

1/2	9.5	6.2	6.7	1.9	2.1	4.1	3.2
3/4	9.5	6.2	6.7	1.9	2.1	4.1	3.2
1	9.5	6.2	6.7	2.4	2.4	4.1	2.7

For cubic inches information, see page J-19

Covers for GR and GRF Conduit Outlet Boxes

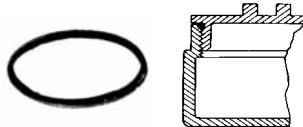
Covers and O-rings Fit Bodies with Corresponding Form Numbers.

			Hub Type	Cover Opening (Inches)	Fixture Stem Size (Inches)	Form No.†	Catalog Number	
							Malleable Iron	Aluminum
	Form 1 Malleable	Form 1 Aluminum	Surface	3.38		1	GRK-1M	GRK-1
				3.94		2	GRK-2M	GRK-2
				4.88		3	GRK-3M	GRK-3
			Sealing	3.38		1	GRK-1SC	GRK-1SC-A
				3.94		2	GRK-2SC	GRK-2SC-A
				4.88		3	GRK-3SC	GRK-3SC-A
			Dome 2" deep	3.38		1		GRK-1DC
			Union Hub	3.38	3/4	1	GRK-75U	GRK-75UA
			Hub	3.38	1/2	1	GRK-50	GRK50-A
				3.38	3/4	1	GRK-75	GRK75-A
			Canopy	3.38	1/2	1	GRK-50C	
	Length			3.38	3/4	1	GRK-75C	
	4-1/2"			3.38	1	1	GRK-100C	
			O-Rings—Buna-N				Catalog Number	
			Provide Raintight fit when used on following series: GR (Forms 1, 2 and 3), GRF (Form 1), GRH, and GRU (Form 1).			1	GRG-1	
						2	GRG-2	
						3	GRG-3	
			GRTB Terminal Strip					
			For use in standard GR series boxes Weidmuller type MK terminal Block* with wire range of #22-#12 AWG. Mounts on 2 predrilled and tapped standard holes (furnished in internal GR boxes).					
			6 position terminal block kit			1+2	GRTB6-12	
			6 position terminal block kit			3	GRTB6-3	
		12 position terminal block kit			3	GRTB12-3		

*Terminal block is UL listed for 300 volts, 25 ampere. CSA certified for 300 volts, 13 ampere.

†Form numbers designate cover and matching body sizes.

Wiring Capacity: Explosionproof Conduit Outlet Boxes



Volume in Cubic Inches and Cubic Centimeters

Wiring Capacity

Type	Size	Vol./cu. in.	Vol./cu. cm
CPU	Form 20	21.0	344.1
ER	1/2"	4.8	78.7
ER	3/4"	7.3	119.3
GR	Form 1	18.0	295.0
GR	Form 2	31.0	508.0
GR	Form 3 (1-1/2")	72.0	1179.9
	Form 3 (2")	76.0	1245.4
GRF	All	18.0	295.0
GRH	All	13.8	226.2
GRJ	All	7.3	119.3
GRJS	All	12.5	204.8
GRK (Canopy)-	-50C, -75C, -100C	16.0	262.2
GRK (Dome)	1DC	6.0	98.3
GRU (Union Hubs)	1/2", 3/4"	19.0	311.4
GRU (Universal)	1/2", 3/4"	13.5	221.2
	1"	17.5	286.8
GRUE	1/2", 3/4"	15.3	250.7
	1"	18.5	303.2
GRUJ	All	25.0	409.7
GRUO	All	25.0	409.7
GRSS	All	29.0	475.2
GRSSA	All	29.0	475.2
GU	All	19.0	311.4

ELBD 90° Pulling Unilets

Size	1/2	3/4	1	1-1/4	1-1/2	2	2-1/2	3	3-1/2	4
Capacity in Cubic Inches										
ELBD	7.0	7.0	25.0	25.0	69.0	69.0	240.0	240.0	540.0	540.0
Capacity in Cubic Centimeters										
ELBD	114.7	114.7	409.7	409.7	1130.7	1130.7	3932.9	3932.9	8849.0	8849.0

